



Authorized Pasternack Distributor:



**EQUIPEMENTS SCIENTIFIQUES S.A.**

TEL: +33 1 47 95 99 60

FAX: +33 1 47 01 16 22

EMAIL: [hyper@es-france.com](mailto:hyper@es-france.com)

WEB: [www.es-france.com](http://www.es-france.com)

# 2022 RF Product Guide





## With Over 45 Years of RF Expertise, It's More Than Parts That Sets Us Apart

Since 1972, Pasternack has been satisfying the urgent requirements of engineers around the world by offering the largest in-stock, ready-to-ship selection of RF, microwave, and mmWave components, assemblies and devices, including over 40,000 popular and hard-to-find items across 107 categories of interconnect, passives, actives, antennas, and test and measurement. Ranging from DC to 220 GHz maximum frequency levels, Pasternack components are used in a wide range of test, development and deployment environments for military/aerospace, telecom, commercial, and industrial applications.

- 99.4% in-stock availability
- Same-day shipping
- No minimum order quantity
- 24/7 assistance by phone, email or chat
- Engineers on-hand to answer questions
- International distribution partner network





## Largest RF Selection Available for Same-Day Shipping

- Adapters
- Amplifiers
- Antennas
- Attenuators/Equalizers
- Baluns
- Bias Tees/DC Blocks
- Cable Assemblies
- Cables
- Connectors
- Connector Accessories
- Couplers
- Educational Products
- Filters
- Frequency Multipliers/Dividers
- Impedance Matching
- Isolators/Circulators
- Limiters/Detectors
- Mixers/Modulators
- Noise Sources
- Oscillators/Synthesizers
- Phase Shifters/Trimmers
- Power Dividers/Combiners
- Rotary Joints
- Surge Protectors
- Switches
- Terminations
- Test and Measurement
- Tools
- Waveguides
- 60 GHz Systems & Modules



# Expanded Portfolio of High Frequency Components

**In Stock and Available for Same-Day Shipping!**

Pasternack's RF Engineering team has curated a broad portfolio of microwave and millimeter wave components to address the needs of 5G innovation and testing, along with other applications requiring higher frequencies and greater bandwidth. Whether your high frequency requirements are for active, passive, or interconnect products, Pasternack has you covered with the industry's largest in-stock selection available for same-day shipping.

## Waveguide Components to 220 GHz



## Electromechanical Switches to 50 GHz Waveguide Electromechanical Switches to 40 GHz



## Test Cables and Adapters 2.92mm/40 GHz, 2.4mm/50 GHz 1.85mm/70 GHz, 1.0mm/110 GHz



## Broadband Amplifiers to 86.5 GHz



## Mixers and Detectors to 110 GHz



## PIN Diode Switches to 67 GHz



## High Frequency Power Dividers/ Couplers to 67 GHz

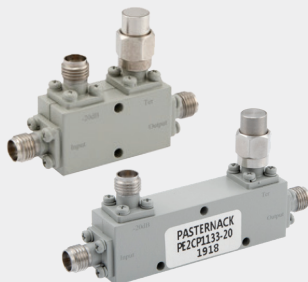

## Calibrated Noise Sources to 60 GHz



## High Band 5G 28 GHz and 39 GHz





# RF PRODUCT GUIDE INDEX

RF Loads with Frequencies up to 67 GHz; ProLine Series Standard Gain Waveguide Horn Antennas; High-Power RF and Microwave PIN Diode Coaxial Packaged Switches; Input Protected Low Noise Amplifiers; Coaxial Packaged Voltage Controlled Oscillators (VCO) Cover Broad Frequency Bands; Sub-6 GHz RF Antennas for 5G; etc.	<a href="#">3</a>	<b>NEW PRODUCT ADDITIONS</b>
5G Solution from Pasternack	<a href="#">5</a>	<b>5G SOLUTIONS</b>
Adapter Selection Guide; Adapter Locator (Part Number Identifier); Low PIM Adapters, Adapters to all Connectors	<a href="#">9</a>	<b>ADAPTERS</b>
Amplifiers Selection Guide; Bi-Directional Amplifiers; Broadband Amplifiers; DC Coupled Amplifiers; Gain Block Amplifiers; Limiting Amplifiers; Linear Amplifiers; Log Amplifiers; Low Noise Amplifiers; Power-GaN Amplifiers; Rackmount Variable Gain Amplifiers; Amplifiers Accessories	<a href="#">49</a>	<b>AMPLIFIERS</b>
Directional Antennas; Omni Directional Antennas; Antenna Mounts	<a href="#">60</a>	<b>ANTENNAS</b>
Attenuators Selection Guide; Continuously Variable Attenuators; DC Bias Attenuators; Fixed Attenuators; Step Attenuators; TTL, CMOS, Relay and USB Attenuators; Voltage Variable Attenuators; Positive Slope Equalizers	<a href="#">68</a>	<b>ATTENUATORS &amp; EQUALIZERS</b>
Baluns	<a href="#">86</a>	<b>BALUNS</b>
Bias Tees; DC Blocks	<a href="#">87</a>	<b>BIAS TEES &amp; DC BLOCKS</b>
Cable Assemblies Selection Guide; Cable Assemblies Locator (By Connector Type); High Reliability and Low PIM Cable Assemblies, Precision and Standard Cable Assemblies	<a href="#">88</a>	<b>CABLE ASSEMBLIES</b>
Circulators; Isolators	<a href="#">222</a>	<b>CIRCULATORS &amp; ISOLATORS</b>
75 Ohm Broadcast; Communications; High Performance; RG MIL-C-17 Type Cables; Semi-Rigid & Formable; Twinax	<a href="#">225</a>	<b>COAX CABLES</b>
Connector Selection Guide; Connector Locator (By Connector Type); All Connectors; Non-Shorting Caps; Shorting Caps	<a href="#">231</a>	<b>CONNECTORS</b>
Dual Directional Couplers; Single Directional Couplers; 90 Degree and 180 Degrees Hybrids	<a href="#">302</a>	<b>COUPLERS &amp; HYBRIDS</b>
RF Diplexers	<a href="#">307</a>	<b>RF DIPLEXERS</b>
Bandpass Filters; Highpass Filters; Lowpass Filters; Band Pass Filters; Band Reject Filters; Harmonic Filters	<a href="#">308</a>	<b>FILTERS</b>
Mixers and Bi-Phase Modulators; Frequency Dividers; Frequency Multipliers	<a href="#">310</a>	<b>FREQ. CONVERSION COMPONENTS</b>
Hi-REL Limiters; PIN-PIN Limiters; PIN-Schottky Limiters; Biased Detectors, Finline Detectors, Log Detectors; Phase Detectors, Power Detectors; Schottky Zero Bias Detectors; Threshold Detectors; Tunnel Diode Zero Bias Detectors	<a href="#">314</a>	<b>LIMITERS &amp; DETECTORS</b>
Precision and Standard Noise Sources	<a href="#">317</a>	<b>NOISE SOURCES</b>
Adjustable Phase Shifters and Trimmers; 8 Bit Programmable Phase Shifters; Analog Phase Shifters	<a href="#">318</a>	<b>PHASE SHIFTERS/ TRIMMERS</b>
Resistive and Reactive Power Dividers; Wilkinson Power Dividers; Broadband	<a href="#">319</a>	<b>POWER DIVIDERS &amp; RF COMBINERS</b>
Rotary Joints	<a href="#">322</a>	<b>ROTARY JOINTS</b>
In-Line Surge Protectors; Replacement Cartridges	<a href="#">322</a>	<b>SURGE PROTECTORS</b>
Electromechanical Relay Switches; SMT Packaged Electromechanical Relay Switches; Manual Switches; High Isolation USB Switches; High Isolation Switches; PIN Diode Switches GaN High Power Switches	<a href="#">324</a>	<b>SWITCHES</b>
Synthesizers; Commercial Surface Mount Packaged VCO; Hermetically Sealed MIL Grade Surface Mount Packaged VCO; Connectorized Packaged VCO, Reference Oscillators, TCXO Oscillators, Phase Locked Oscillators and Phase Locked Crystal Oscillators	<a href="#">336</a>	<b>SYNTHESIZERS &amp; OSCILLATORS</b>
Equal Split; Unequal Split	<a href="#">341</a>	<b>TAPPERS</b>
RF Load Terminations; Feed-Thru Load Terminations; Resistive Impedance Transformers	<a href="#">342</a>	<b>TERMINATIONS &amp; MATCHING PADS</b>
1.0mm Flexible VNA Test Cables; 26.5, 40, 50, 67 GHz and 75 Ohm Test Cables; Calibration Kits; Handheld RF Analyzer Rugged Stable Cable Assemblies; PE-TC151 and PE-TC195 Series Phase Stable Test Cable Assemblies; Semi-Rigid Pigtail Test Probes; VNA Test Cable Assemblies, etc.	<a href="#">348</a>	<b>TEST &amp; MEASUREMENT PRODUCTS</b>
Cable Cutters; Crimp Tools; Crimp Tool Dies ; Insertion/Extraction Tools; Torque Wrenches	<a href="#">355</a>	<b>TOOLS</b>
WG Antennas; WG Bandpass Filters; WG Bends; WG Bulkhead Adapters; WG Converters; WG Couplers; WG Detectors; WG Direct Read Atten.; WG EMS; Flexible WG; WG Gunn Oscillators; WG Magic Tees; WG Phase Shifters; WG PIN Diode Switches; WG Power Amps., etc.	<a href="#">358</a>	<b>WAVEGUIDES</b>
Pasternack REACH and RoHS Compliance Programs; Mailing List Changes; Binding Terms/Warranty; Part Number Index; Mounting Holes; Connector Identifiers; Connector Frequency Range Chart; Conversion Tables	<a href="#">390</a>	<b>APPENDIX</b>

The information contained in this catalog and on pasternack.com is accurate to the best of our knowledge at the time of publication. It may be necessary to make modifications to the parts and/or the documentation of the parts, in order to implement improvements. Pasternack reserves



**Technical Support**  
+1 (949) 261-1920



**Same-Day Shipping,  
Even Custom  
Cable Assemblies**

# TABLE OF CONTENTS

<b>5G Solutions</b>			
The 5G Outlook	5		
RF Interconnects	6		
RF Actives	6		
RF Passives	7		
Antennas	8		
<b>Adapters</b>			
Adapters to All Connectors	18		
Locator (Part Number Identifier)	10		
Low PIM Adapters	16		
Quick Reference Guide	9		
Selection Guide	9		
<b>Amplifiers</b>			
Locator	49		
Quick Reference Guide	49		
Selection Guide	49		
Bi Directional Amplifiers	51		
Broadband Amplifiers	51		
DC Coupled Amplifiers	53		
Gain Block Amplifiers	53		
GaN High Power Amplifiers	58		
Input Protected Low Noise Amplifiers	55		
Limiting Amplifiers	53		
Log Amplifiers	54		
Low Noise Amplifiers	54		
Power Amplifiers	55		
Variable Gain Amplifiers	59		
<b>Antennas</b>			
Antenna Mounts	67		
Directional Antennas	60		
Omni Directional Antennas	62		
<b>Attenuators, Active</b>			
Locator	68		
Quick Reference Guide	68		
Selection Guide	68		
Programmable Attenuators	85		
Voltage Variable Attenuators	85		
<b>Attenuators, Passive</b>			
Locator	68		
Quick Reference Guide	68		
Selection Guide	68		
Continuously Variable Attenuators	85		
DC Bias Attenuators	84		
Fixed Attenuators	70		
Step Attenuators, Push Button	83		
Step Attenuators, Rotary	84		
Step Attenuators, Toggle	83		
<b>Baluns</b>			
Surface Mount	86		
<b>Bias Tee</b>			
Bias Tee	87		
<b>Cable Assemblies</b>			
Locator (By connector Type)	89		
Low PIM and High-Reliability Cable Assemblies	93		
Precision and Standard Cable Assemblies	96		
Quick Reference Guide	88		
Selection Guide	88		
<b>Circulators</b>			
2.92mm Connectors	222		
N Connectors	222		
SMA Connectors	222		
<b>Coaxial Cables</b>			
75 Ohm Broadcast	226		
Communications	226		
High Performance	227		
RG Mil-C-17 Type Cable	227		
Semirigid and Formable	228		
Twinax Cable	230		
<b>Connectors</b>			
Locator (Part Number Identifier)	231		
Quick Reference Guide	231		
Selection Guide	231		
<b>Connector Caps</b>			
Non-Shorting Caps	300		
Shorting Caps	301		
<b>Couplers</b>			
90 degree Hybrid	306		
180 degree Hybrid	307		
Directional	302		
Dual Directional	305		
<b>DC Blocks</b>			
1.85mm	87		
2.4mm	87		
2.92mm	87		
BNC	87		
N	87		
SMA	87		
TNC	87		
BNC	87		
F	87		
N	87		
<b>Detectors</b>			
Biased Detectors	315		
Finline Detectors	315		
Log Detectors	315		
Phase Detectors	315		
Power Detectors	316		
Schottky Zero Bias Detectors	316		
Threshold Detectors	316		
Tunnel Diode Zero Bias Detectors	316		
<b>RF Diplexers</b>			
Low Pass and High Pass	307		
<b>Equalizers</b>			
Positive Slope Equalizers	86		
<b>Filters</b>			
Band Pass	310		
Band Reject	310		
Chebyshev Filters	309		
Combine Filters	308		
High Pass Filters	309		
Low Pass Filters	309		
<b>Frequency Dividers</b>			
SMA Connectors	310		
<b>Frequency Multipliers</b>			
Active	313		
Passive Doublers	313		
<b>Isolators</b>			
2.4mm Connectors	223		
2.92mm Connectors	223		
N Connectors	223		
SMA Connectors	223		
<b>Limiters</b>			
HIGH REL	314		
PIN-PIN	314		
PIN-Schottky	314		
<b>Manual Switches</b>			
Manual Switches	331		
<b>Matching Pads</b>			
Resistive Impedance Transformers	347		
<b>Mixers</b>			
Double Balanced	311		
IQ	311		
Triple Balanced	312		
<b>Modulators</b>			
BiPhase	312		
<b>Noise Sources</b>			
Precision	317		
SMT Pin Packaged	317		
Standard	317		
<b>Oscillators</b>			
0.175" Ultra Small Commercial Surface Mount Packaged VCO	337		
0.5" Commercial Surface Mount Packaged VCO	337		
0.5" Commercial Surface Mount Packaged VCO w/ Integrated Buffer Amps	338		
0.5" Commercial Surface Mount Packaged VCO w/ Low Noise	338		
0.5" Commercial Surface Mount Packaged VCO w/ Modulation Input Port	339		
0.5" Hermetically Sealed MIL Grade Surface Mount Packaged VCO	339		
Connectorized Packaged VCO w/ Field Replaceable Connectors	339		
Phase Locked Crystal Oscillators	341		
Phase Locked Oscillators	341		
Reference Oscillators	340		
TCXO Reference Oscillators	340		
<b>Phase Shifters</b>			
8 Bit Programmable Phase Shifter	318		
Adjustable Phase Shifter	318		
Analog Phase Shifter	319		
<b>Phase Trimmers</b>			
Adjustable Phase Trimmer	318		
<b>Power Dividers</b>			
	319		
Reactive	319		
Resistive	320		
Wilkinson	320		
<b>RF Combiners</b>			
Broadband	322		
<b>Rotary Joints</b>			
SMA	322		
2.92mm	322		
SMA	322		
<b>Surge Protectors</b>			
In-Line Surge Protectors	322		
Surge Protector Replacement Cartridges	323		
<b>Switches</b>			
Electromechanical Relay Switches	324		
Electromechanical Relay Switches, SMT Packaged	330		
GaN High Power Switches	335		
High Isolation PIN Diode Switches	335		
High Isolation USB PIN Diode Switches	335		
PIN Diode Switches	331		
<b>Synthesizers</b>			
Integer/Fractional	336		
<b>Tappers</b>			
Equal Split	341		
Unequal Split	342		
<b>Terminations</b>			
Feed-Thru Load	347		
RF Load	343		
<b>Test And Measurement</b>			
1.0mm Flexible VNA 110 GHz Precision Cables	352		
26.5 GHz and 40 GHz Test Cables	354		
40 GHz Skew Matched Cable Pairs	350		
4-in-1 Calibration Kits	349		
50 GHz and 67 GHz Test Cable Assemblies	351		
75 Ohm Test Cable Assemblies	354		
Bench Type Calibration Kits	348		
Handheld RF Analyzer Rugged Phase Stable Cable Assemblies	350		
Interchangeable Connectors	349		
PE-TC151 Series Phase Stable Test Cable	353		
PE-TC195 Series Phase Stable Test Cable	353		
RF Microwave Probes	349		
Semi-Rigid Pigtail Test Probes	354		
VNA Ruggedized Test Cable	351		
<b>Tools</b>			
Cable Cutter	355		
Crimp Tool Dies	357		
Crimp Tools	357		
Insertion/Extraction Tool	355		
Torque Wrenches	356		
<b>Waveguides</b>			
Flexible Waveguides	380		
Waveguide Accessories	388		
Waveguide Antennas	360		
Waveguide Antennas Accessories	365		
Waveguide BandPass Filters	369		
Waveguide Bends	369		
Waveguide Bulkhead Adapters	370		
Waveguide Converter Mixers	371		
Waveguide Couplers	371		
Waveguide Detectors	377		
Waveguide Direct Read Attenuators	377		
Waveguide Double Ridge Bends	370		
Waveguide Double Ridge Sections	385		
Waveguide Electromechanical Relay Switches	377		
Waveguide Fixed Attenuators	379		
Waveguide Gunn Oscillators	381		
Waveguide Isolators	381		
Waveguide Low Noise Amplifiers	382		
Waveguide Magic Tees	382		
Waveguide Orthomode Transducers	382		
Waveguide Phase Shifters	382		
Waveguide PIN Diode Switches	383		
Waveguide Polarizers	383		
Waveguide Power Amplifiers	383		
Waveguide Sections	383		
Waveguide Terminations	385		
Waveguide Transitions	386		
Waveguide Twists	387		
Waveguide Variable Attenuators	388		

## HELPFUL RESOURCES

Connector Freq. Range Chart	414	Mounting Hole Layout	409
Connector Identifier	410	Part Number Index	395
Conversion Tables	407	REACH-RoHS Compliance Program	391
How to Place your Order	392	Terms & Conditions	392



# NEW PRODUCT ADDITIONS

## RF Loads with Frequencies up to 67 GHz (See pages [343](#))



- Operating frequency range up to 67GHz
- Coaxial designs with 1.85mm, 2.4mm, 3.5mm, SMP and Mini-SMP connectors
- Available in both male/female connectorized configurations
- Flat RF response and performance

- Excellent VSWR performance as low as 1.15:1

## ProLine Series Standard Gain Waveguide Horn Antennas (See pages [360-368](#))

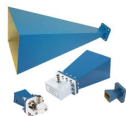

- Complete line of high-performance waveguide antennas
- US made and TAA compliant
- Operating from 1.7 GHz to 40 GHz
- L, S, C, X, Ku, K, and Ka Band Operation
- Gain options of 10, 15 and 20 dBi

- WR-28 to WR-430 sizes available
- Type N, SMA, and 2.92mm (Type K) connectors available
- Ideal for applications such as: Antenna Measurements, Laboratory Use, Wireless Communications, Microwave Radio Systems

## High-Power RF and Microwave PIN Diode Coaxial Packaged Switches (See pages [332, 335](#))

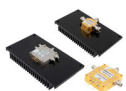

- GaN Semiconductor PIN Diode Switch Technology
- 50 Ohm Reflective Designs Cover Broadband Frequencies ranging from DC to 18 GHz
- High RF input power handling up to 100 watts CW
- Switching Speed 50 to 100 nsec typical

- Insertion Loss: 0.9 to 1.5 dB typical
- Compact and Rugged Mil Grade Coaxial Packaged Designs with Integrated TTL Compatible Drivers
- Models available with and without heatsinks

## Input Protected Low Noise Amplifiers (See pages [55](#))



- GaN Semiconductor Technology
- Broadband Frequencies ranging from 1 - 23 GHz
- High RF input power handling up to 10 watts CW
- High gain up to 44 dB typ
- Low Noise Figure as low as 1.5 dB typ

- Rugged Mil-Grade SMA Connectorized Packaging

## Coaxial Packaged Voltage Controlled Oscillators (VCO) Cover Broad Frequency Bands (See pages [340](#))



- Frequency bands ranging from 230 MHz to 5420 MHz
- Output power ranging from 0 dBm to +9 dBm
- Exceptional phase noise performance as low as -110 dBc/Hz at 10 KHz offset
- Internal voltage regulation and reverse DC protection.

## Sub-6 GHz RF Antennas for 5G (See pages [62, 65, 66](#))



- Antennas designed for operation in sub-6 GHz 5G frequency bands
- Great for public or private 5G networks
- Options are available to cover from 600 MHz up to 7.2 GHz
- Connectors available in Type N or SMA

- In stock and ready to ship same day

## Waveguide Components Include WRD-180, WRD-650 and WRD-750 Sizes (See pages [368, 370, 385-387](#))



- Wider operating frequency ranges than regular waveguide components (from 6.5GHz to 40GHz)
- Waveguide sizes: WRD-180, WRD-650 and WRD-750
- UG-style square cover flanges

- Manufactured with precision machining to ensure excellent RF performances

## Micro-Sized EM Switches offer DC to 26 GHz Performance (See pages [330](#))



- 6 models cover broadband frequencies ranging from DC to 26 GHz
- SPDT Designs feature Latching Actuators with long and reliable lifespans up to 5M lifecycles typical
- Impressive Performance with very low insertion loss, high isolation, and excellent repeatability

- True SMT Package concept has high thermal resistance and can use a variety of solder mounting processes
- Hot Switching capability up to 40W Average Power
- Models are RoHS and REACH Compliant

## Rubber Duck Antennas offer Gain of 2 to 7 dBi and Frequencies of 900 MHz and 2.4 GHz (See pages [66](#))



- Antennas suitable for multiple applications in the 900 MHz and 2.4 GHz ISM space
- Functional in US, EU and Global RFID needs
- RIGID connections and Tilt and Swivel knuckle options available
- Gain from 2 dBi up to 7 dBi

- N Type, SMA, Reverse Polarity SMA and Reverse Polarity TNC connector options
- Economically priced for the entry level designer and upgrade opportunities
- Functional for IoT and automation applications
- In-stock and ready to ship same-day



Technical Support  
+1 (949) 261-1920



Same-Day Shipping,  
Even Custom  
Cable Assemblies

# NEW PRODUCT ADDITIONS

## Yagi Antennas Operate at 400 / 900 MHz and Can Withstand Sustained Winds up to 200 mph (See pages [61](#))



- Yagi antennas offering 400 to 470 MHz (400 MHz band) and 880 to 960 MHz (900 MHz band) configurations
- Aircraft-quality aluminum with 1" boom and 5/16" elements
- Black powder-coated for corrosion, fade, and ice build-up resistance
- 200 mph wind survivability
- Gain options of 7 dBi to 13 dBi
- Antennas come fully welded for maximum durability
- In-stock and available for same-day shipping

## Amplifier Models Cover Popular VHF/UHF, L, S and C Frequency Bands (See pages [51](#))



- 6 bi-directional amplifier models cover popular VHF/UHF, L, S, and C frequency bands
- Several designs incorporate highly efficient GaN semiconductor technology
- Transmit (Tx) output Psat levels range from 8 to 20 watts that boost performance of data links and transmitters
- Designs offer sensitive receiver performance with 2.5 dB noise figure
- Models feature manual or auto-sensing transmit/receive (T/R) control with fast switching times of 1-2  $\mu$ sec
- Rugged mil-grade designs are in compact, environmentally-sealed SMA connectorized packages

## PCB Antennas Support Frequencies Ranging from 700 MHz to 5 GHz (See pages [65](#), [63](#))



- Variety of low profile/compact shapes and sizes to meet your design requirements
- Support for multiband cellular, NB-IoT, LTE-M, WiFi, WLAN and GPS
- Miniaturized connectors compatible with UMCX, IPEX and U.FL
- Highly efficient PCB designs for maximum embedded performance

## Antennas Address ISM, RFID, SCADA, IoT and Utility Network Applications (See pages [60-67](#))



- Antennas suitable for multiple applications in the 900 MHz ISM space
- Functional in US, EU and global RFID needs
- Variety of polarization options to best fit the environment
- Point to multipoint & Non Line of Sight (NLOS) applications
- RFID & SCADA
- LPWAN, LoRA, IoT, M2M
- In stock and ready to ship same day

## Waveguide-to-Coax Adapters with European IEC Standard Flanges (See pages [365-368](#))



- Frequency ranges from 1.72GHz to 40 GHz in 15 waveguide bands
- Waveguide sizes from WR-28 to WR-430
- European IEC standard flanges: UDR, PDR and UBR
- Coaxial designs: SMA, 2.92mm, N-Type and 2.4mm connectors
- Constructed with precision machining in brass or aluminum
- Available in right-angle and end-launch configurations

## VNA Test Cables Boast Flex Life Exceeding 100,000 Cycles (See pages [100](#), [214](#), [351-352](#))



- Max phase variation +/- 6° to 50 GHz and +/- 8° to 70 GHz with flexure
- VSWR of 1.3:1 to 50 GHz and 1.4:1 to 70 GHz
- Standard and NMD 1.85mm and 2.4mm connector options
- Flexible VNA cable series rated up to 5,000 mating cycles
- Up to 100,000 flex cycles
- Swept right angle connector options available
- Highly flexible stainless steel braided armoring
- Designed for accurate and repeatable measurements

## Field Replaceable Connectors Include SMA, 3.5mm, 2.92mm, 2.4mm, and 1.85mm Options (See pages [238](#), [240-241](#), [273-274](#))



- 4 Connector series SMA, 2.92mm, 2.4mm, and 1.85mm
- 2-Hole and 4-hole flange types
- Contacts mate with 5 pin diameters ranging from 0.009" to 0.036"
- Metal ground contact rings
- Allows for replacement of damaged connectors without accessing sealed components
- Multiple connector series can be used with a single mating pin diameter

## Circulators/Isolators Cover Operating Frequency Ranges up to 42.5 GHz (See pages [222-224](#))



- Operating frequency ranges up to 42.5GHz
- Max. power rating up to 100W
- Available in SMA, N-type, 2.4mm and 2.92mm connectorized designs
- Broad spectrum of product selection available

## SMT Noise Sources Cover Freq. from 0.2 MHz-3 GHz and are Ideal for PWB Applications (See pages [317](#))



- SMT gullwing pin and dual inline pin (DIP) surface mount packaging options with Frequency Bands range from 0.2-3 GHz
- Models generate additive white Gaussian noise (AWGN) output
- SMT gullwing pin models have high output ENR levels up to 51 dB
- Dual inline pin (DIP) models generate a noise output power level of -5 dBm
- Rugged 50 Ohm designs have operating temperature ranges up to -55°C to +125°C





## The 5G Outlook

5G promises to deliver lightning-speed data rates, increased user capacity, reduced latency, and overall improved network efficiencies through new delivery technologies and distribution techniques like network splicing. Although many factors affect network speed, 5G will be at least 10 times faster than 4G networks, which often average less than 10 Mbps. The global 5G infrastructure being built today will be the backbone of RF wireless innovation for years to come and also enable a new era for big data, where near-real-time processing and intelligence shared to and from a plethora of connected devices will provide enhanced user experiences, safety, and responsiveness.

New 5G devices and applications are in various stages of development, testing and deployment. Three major use cases for 5G have been defined:

### Mission Critical Applications

Including autonomous vehicles, remote health care, intelligent grids, industrial automation, and more – where low latency, ultra-high reliability connectivity is essential.

### Enhanced Mobile Broadband

Offering increased speed and capacity through further rollout of MIMO, small cell, DAS, and fixed wireless technologies.

### The Internet of Things (IoT)

Comprised of billions of connected devices, communicating without human intervention, creating new opportunities for big data exchange and analysis, and set to revolutionize manufacturing, business communications, agriculture, and more.

## 5G Solutions from Pasternack

RF Components for the Next Generation.....[see web](#)

Pasternack meets the urgent needs of engineers and technicians around the world for high-grade RF components and cable assemblies to support 5G innovation development, testing and deployments in the global sub-6 GHz (e.g. the 3.5 GHz mid-band) and mmWave bands (e.g. 26 GHz, 28 GHz and 39 GHz).

All Pasternack 5G solutions components are in-stock and shipped same day, and they are backed by first-class technical and engineering support. Our applications engineers are standing by ready to assist with answering your questions and selecting the right product for your specific application. Visit us online at [Pasternack.com](http://Pasternack.com) to view detailed datasheets, CAD drawings, real-time pricing and inventory, or to place your order and have it shipped today!



Technical  
Support  
+1 (949) 261-1920



Same-Day Shipping,  
Even Custom  
Cable Assemblies





## Programmable Attenuators.....[see web](#)

Ensure reliable attenuation levels with Pasternack's ready-to-ship RF programmable attenuators for 5G applications.

- Covering sub-6 GHz and mmWave frequency bands
- Maximum attenuation levels up to 127 dB
- Designs optimized for low insertion loss and excellent VSWR as low as 1.25:1

## Limiters and Detectors.....[see web](#)

Keep control of I/O power levels with Pasternack's ready-to-ship, broadband coaxial packaged RF limiters and detectors for 5G applications.

- Over 15 limiters and 20 detectors available for sub-6 GHz or mmWave frequency bands
- Available in compact cylindrical or drop-mountable package outlines with SMA or 2.92 mm RF connectors
- Ideal for proof-of-concept and prototyping in precision test and measurement, instrumentation, and subsystem assemblies

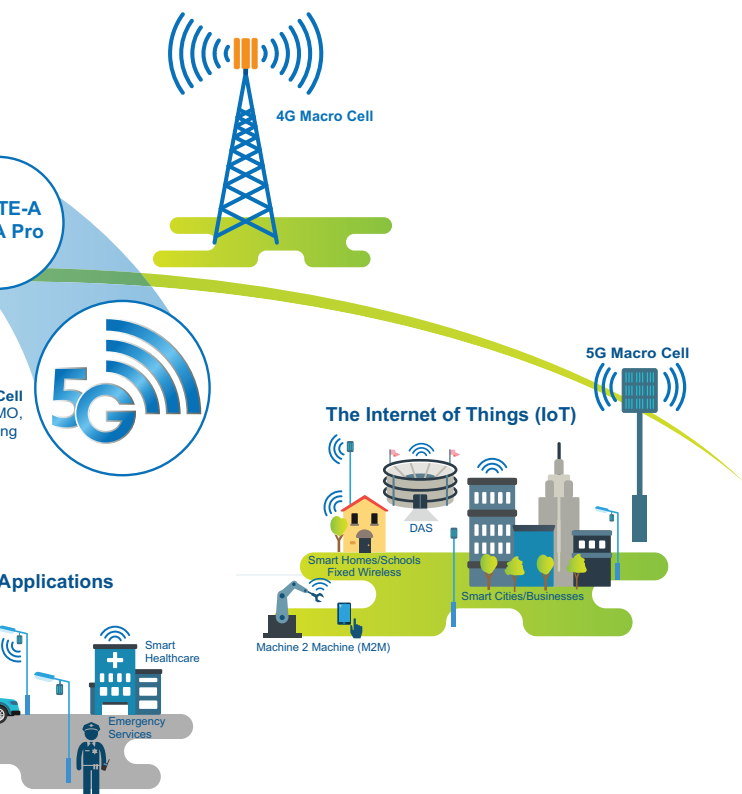

## Noise Sources.....[see web](#)

Meet your immediate requirements for signal performance testing with Pasternack's ready-to-ship RF coaxial packaged noise sources for 5G applications.

- Over 25 models covering sub-6 GHz and mmWave frequency bands
- Noise source design configurations include: octave band and broadband, amplified, precision-calibrated instrumentation-grade, noise sources with integral isolators
- Most models designed to meet MIL-STD-202F environmental test conditions

## Oscillators.....[see web](#)

Count on high-performance signal generation with Pasternack's ready-to-ship RF oscillators for 5G applications.

- Covering select bands from 10 MHz to 43 GHz
- Oscillator types include: voltage controlled (VCO), reference, phase locked, phase locked crystal, temperature compensated crystal
- Surface mount and coaxial packaged versions available

## RF Passives

### Power Dividers.....[see web](#)

Meet your immediate needs for 2-way and 4-way input power division with Pasternack's ready-to-ship RF power dividers for 5G applications.

- Maximum input power of 30 W for wideband operating frequency ranges up to 6 GHz
- Maximum input power of 20 W for operating frequency ranges in the mmWave bands

## Fixed Attenuators.....[see web](#)

Provide reliable signal attenuation with Pasternack's line of ready-to-ship RF fixed attenuators for 5G applications.

- Wide range of attenuation levels and rated up to 2 W
- Maximum operating frequencies up to 6 GHz and mmWave bands
- Durable stainless steel construction
- Available in SMA and 2.92 mm connector designs

## Network Infrastructure



Technical Support  
+1 (949) 261-1920



Same-Day Shipping,  
Even Custom  
Cable Assemblies

## Terminations.....[see web](#)

Expect durable, high-performance with Pasternack's ready-to-ship RF terminations for 5G applications.

- Rated up to 2 W with maximum operating frequencies up to 6 GHz, 18 GHz, or 40 GHz
- Reliable stainless steel construction
- Available in SMA, Mini SMP, Type-N, 4.3-10, and 2.92 mm connector series

## Filters.....[see web](#)

Turn to Pasternack for your RF bandpass filter needs for 5G applications.

- Covering mid-band and mmWave band frequencies
- 4, 9, and 11 section options
- SMA connector package design
- Low insertion loss and excellent VSWR

## Directional Couplers.....[see web](#)

Expect high-quality signal coupling performance with Pasternack's ready-to-ship RF directional couplers for 5G applications.

- Wide range of coupling levels available and maximum input power levels as high as 30 W
- Operating frequency ranges up to the mmWave bands and operating temperature range from -45 to 85 degree C
- SMA and 2.92 connector designs available

## Waveguides.....[see web](#)

Enable low loss transmission with Pasternack's ready-to-ship, precision waveguide components for 5G applications.

- mmWave operating frequency bands and Wide range of waveguide sizes
- Waveguide components include: couplers, waveguide-to-coax adapters, straights, bends, twists, and more

## DC Blocks.....[see web](#)

Protect your bias-sensitive RF components with Pasternack's ready-to-ship, high-grade RF DC blocks for 5G applications.

- Maximum operating frequency ranges up to the mmWave band
- Inner or outer conductor configuration options available
- 2.92 mm, SMA, Type-N, and TNC connector designs available

## Bias Tees.....[see web](#)

Ensure dependable signal processing with Pasternack's ready-to-ship RF bias tees for 5G applications.

- Maximum operating frequencies in the sub-6 GHz or mmWave frequency bands
- Maximum DC voltage rating of 100 V and current rating of 2.5 A
- SMA, Type-N, 3.5 mm, and 2.92 mm connector options available

## Antennas

### RF and Waveguide Antennas.....[see web](#)

Explore Pasternack's wide selection of ready-to-ship RF and waveguide antennas for 5G applications.

- Operating in the sub-6 GHz and mmWave frequency bands
- Including coax fed antennas operating at sub-6 GHz
- Comprehensive offering of waveguide antennas including: standard gain horns, conical horns, scalar feed horns, lens horns, omni-directional with waveguide flanges
- Waveguide antennas mount directly to waveguides or can be combined with waveguide-to-coax adapters for coaxial connections

## 5G Efficiencies



# 10x

**Decrease in Latency**  
Delivering latency as low as 1 ms



# 3x

**Spectrum Efficiency**  
Achieving even more bits per Hz with advanced antenna techniques



# 10x

**Experience Throughput**  
Bringing more uniform, multi-Gbps peak rates



# 10x

**Connection Density**  
Enabling more efficient signaling for IoT connectivity



# 100x

**Traffic Capacity**  
Driving network hyper-densification with more small cells everywhere



# 100x

**Network Efficiency**  
Optimizing network energy consumption with more efficient processing

# Adapter Selection Guide

## 3 Easy Ways to Find your Product.....

### 1. Search by PE Part Number

If you know the PE part number you are searching for, please reference our Part Number Index on Page [395](#)

### 2. Quick Reference Guide

(Page number refers to first appearance of product in the Adapter Section)

Connector Series	Page	Connector Series	Page	Connector Series	Page	Connector Series	Page	Connector Series	Page
1.0/2.3	<a href="#">36</a>	7/16 DIN	<a href="#">23</a>	95Ω 3/4"-20 Twinax	<a href="#">48</a>	MCX	<a href="#">28</a>	SC	<a href="#">24</a>
1.0mm	<a href="#">18</a>	75Ω BNC	<a href="#">45</a>	Banana	<a href="#">48</a>	MHV	<a href="#">26</a>	SHV	<a href="#">28</a>
1.85mm	<a href="#">18</a>	75Ω F	<a href="#">26</a>	BMA	<a href="#">25</a>	Mini SMP	<a href="#">19</a>	SMA	<a href="#">19</a>
10-32	<a href="#">25</a>	75Ω Mini SMB	<a href="#">46</a>	BNC	<a href="#">22</a>	Mini UHF	<a href="#">28</a>	SMB	<a href="#">31</a>
2.4mm	<a href="#">18</a>	75Ω N	<a href="#">46</a>	BNC Triax	<a href="#">26</a>	MMBX	<a href="#">29</a>	SMC	<a href="#">31</a>
2.4mm NMD	<a href="#">19</a>	75Ω PAL	<a href="#">45</a>	C	<a href="#">26</a>	MMCX	<a href="#">29</a>	SMP	<a href="#">19</a>
2.92mm	<a href="#">18</a>	75Ω RCA	<a href="#">26</a>	Double Banana	<a href="#">26</a>	N	<a href="#">18</a>	SSMA	<a href="#">21</a>
2.92mm NMD	<a href="#">21</a>	75Ω SMB	<a href="#">26</a>	D-Sub	<a href="#">26</a>	QMA	<a href="#">31</a>	SSMB	<a href="#">37</a>
3.5mm	<a href="#">18</a>	75Ω SMC	<a href="#">26</a>	FME	<a href="#">26</a>	Rev Pol MCX	<a href="#">40</a>	SSMC	<a href="#">40</a>
3.5mm NMD	<a href="#">22</a>	75Ω TNC	<a href="#">46</a>	GR874	<a href="#">27</a>	Rev Pol N	<a href="#">30</a>	TNC	<a href="#">31</a>
4.1/9.5 Mini DIN	<a href="#">22</a>	78Ω BNC Twinax	<a href="#">48</a>	HN	<a href="#">24</a>	Rev Pol SMA	<a href="#">35</a>	UHF	<a href="#">32</a>
4.3-10	<a href="#">22</a>	7mm	<a href="#">19</a>	LC	<a href="#">27</a>	Rev Pol TNC	<a href="#">33</a>	UMCX	<a href="#">38</a>

### Adapter Locator Layout

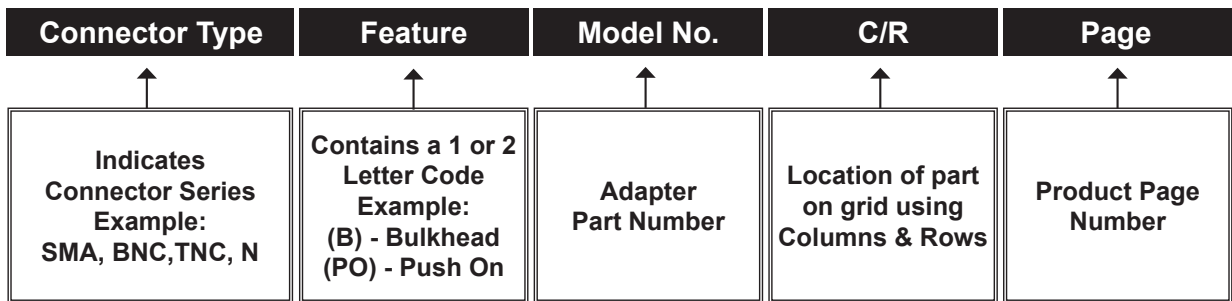

### 3. Between-Series Adapter Locator

(Adapter Locator starts on Page [10](#))

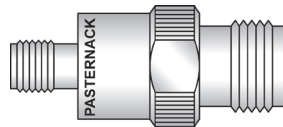

SMA FEMALE TO TNC FEMALE  
PE9079

SMA Female To:		EXAMPLE		
Connector Type	Feature	Model No.	C/R	Page
SSMA Male		PE9188	A4	163
SSMB Plug		PE0402	A3	167
TNC Female		<b>PE9079</b>	D6	164
TNC Female	(B)	PE9251	A1	165

TNC Female To:		EXAMPLE		
Connector Type	Feature	Model No.	C/R	Page
SMA Female	(P)	PE0442	C6	164
SMA Female		<b>PE9079</b>	D6	164
SMA Female	(B)	PE9251	A1	165
SMA Female	(PM)	PE9276	B1	165

The Adapter Locator example above includes Between-Series part numbers in two configurations:

**Connector 1 to Connector 2 as well as Connector 2 to Connector 1 can be found in the same location.**

Products can only be found under the first instance of the series combination. As an example, PE9079 above will be found in only one location in the Adapter Section.



# Adapter Locator

Connector Type	Feature	Model No.	C/R	Page
<b>1.0/2.3 Jack To:</b>				
SMA Female		PE9693	C1	38
SMA Male		PE9690	D2	36
<b>1.0/2.3 Plug To:</b>				
SMA Female		PE9691	B1	38
SMA Male		PE9692	C2	36
<b>1.0mm Female To:</b>				
1.85mm Female		PE91109	D2	18
1.85mm Male		PE91119	C2	18
<b>1.0mm In-Series:</b>				
Female to Female		PE91463	D1	18
Female to Male		PE91461	C1	18
Male to Male		PE91462	B1	18
<b>1.0mm Male To:</b>				
1.85mm Female		PE91108	B2	18
1.85mm Male		PE91118	A2	18
<b>1.85mm Female To:</b>				
1.0mm Female		PE91109	D2	18
1.0mm Male		PE91108	B2	18
2.4mm Female	90°	PE91534	A6	18
2.4mm Female		PE9675	D4	19
2.4mm Male		PE9674	E2	19
2.92mm Female	90°	PE91163	D6	18
2.92mm Female	90°	PE91513	E6	18
2.92mm Male	90°	PE91162	B6	18
2.92mm Male	90°	PE91512	C6	18
2.92mm Male		PE9666	A3	20
3.5mm Female		PE9748	A7	21
3.5mm Male		PE9745	B5	21
N Female		PE9721	B7	18
N Male		PE9720	A7	18
SMA Female		PE9729	E1	38
SMA Male		PE9728	A3	36
<b>1.85mm In-Series:</b>				
Female to Female		PE91084	E3	18
Female to Male		PE91115	A4	18
Male to Female		PE91086	C3	18
Male to Female		PE9715	D3	18
Male to Male		PE91085	A3	18
Male to Male		PE9716	B3	18
<b>1.85mm Male To:</b>				
1.0mm Female		PE91119	C2	18
1.0mm Male		PE91118	A2	18
2.4mm Female	90°	PE91511	E4	18
2.4mm Female		PE9673	B4	19
2.4mm Female	(P)	PE91542	C4	19
2.4mm Male	90°	PE91157	C4	18
2.4mm Male	90°	PE91518	D4	18
2.4mm Male		PE9672	C2	19
2.4mm Male		PE91540	D2	19
2.92mm Female		PE9665	B6	20
2.92mm Male	90°	PE91161	A5	18
2.92mm Male	90°	PE91519	B5	18
2.92mm Male		PE9667	E2	20
3.5mm Female		PE9747	C5	18
3.5mm Male		PE9746	A5	21
N Female		PE9719	E5	18
N Male		PE9718	D5	18
SMA Female		PE9726	D1	38
SMA Male		PE9727	E2	36
<b>10-32 Female To:</b>				
BNC Female		PE9752	C2	25
BNC Female	(B)	PE9754	D2	25
BNC Male		PE9750	B2	25
<b>10-32 In-Series:</b>				
Female to Female		PE9756	A1	25
Female to Female	(B)	PE9757	B1	25
<b>10-32 Male To:</b>				
BNC Female		PE9753	E1	25
BNC Female	(B)	PE9755	A2	25
BNC Male		PE9751	D1	25
<b>2.4mm Female To:</b>				
1.85mm Female		PE9675	D4	19
1.85mm Female	90°	PE91534	A6	18
1.85mm Male		PE9673	B4	19
1.85mm Male	(P)	PE91542	C4	19
1.85mm Male	90°	PE91511	E4	18
2.4mm NMD Female		PE91145	E6	19
2.92mm Female	90°	PE91111	A5	19
2.92mm Female	90°	PE91525	B5	19
2.92mm Female		PE91499	E6	20
2.92mm Female		PE9456	A7	20
2.92mm Male	90°	PE91526	E4	19
2.92mm Male		PE91450	D3	20
2.92mm Male		PE9455	E3	20
2.92mm NMD Female		PE91144	E2	21
3.5mm Female		PE91291	C7	21
3.5mm Female		PE9652	D7	21
3.5mm Female		PE91547	E7	21
3.5mm Male		PE91452	E5	21
3.5mm Male		PE9651	A6	21
3.5mm NMD Female		PE91148	B2	22
Full Detent Mini SMP Male		PE91122	C5	19
Mini SMP Female		PE91123	D5	19
N Female	(P)	PE9502	A6	19
N Male	(P)	PE9503	E5	19
SMA Female	(P)	PE9656	B2	38
SMA Male	(P)	PE9654	C3	36

Connector Type	Feature	Model No.	C/R	Page
SMP Female		PE91055	C6	19
SMP Male		PE91048	B6	19
<b>2.4mm In-Series:</b>				
Female to Female		PE9453	C1	19
Female to Female	(B)	PE91459	D1	19
Female to Female	(B)	PE9640	E1	19
Female to Female	90°	PE91529	A2	19
Male to Female		PE9452	E7	18
Male to Female	90°	PE91138	A1	19
Male to Female	90°	PE91498	B1	19
Male to Male		PE9451	D7	18
<b>2.4mm Male To:</b>				
1.85mm Female		PE9674	E2	19
1.85mm Male		PE9672	C2	19
1.85mm Male		PE91540	D2	19
1.85mm Male	90°	PE91157	C4	18
1.85mm Male	90°	PE91518	D4	18
2.92mm Female	90°	PE91502	B3	19
2.92mm Female		PE91451	C6	20
2.92mm Female		PE9454	D6	20
2.92mm Male	90°	PE91508	A3	19
2.92mm Male		PE91298	B3	20
2.92mm Male		PE9457	C3	20
3.5mm Female		PE9650	B7	21
3.5mm Male		PE91294	C5	21
3.5mm Male		PE9649	D5	21
7mm Sexless		PE9458	C3	19
Full Detent Mini SMP Male		PE91121	D3	19
N Female	(P)	PE9501	A4	19
N Male	(P)	PE9504	E3	19
SMA Female		PE9655	A2	38
SMA Male	(P)	PE9653	B3	36
<b>2.4mm NMD Female To:</b>				
2.4mm Female		PE91145	E6	19
SMA Female	(RU)	PE91146	A7	19
<b>2.92mm Female To:</b>				
1.85mm Female	90°	PE91163	D6	18
1.85mm Female	90°	PE91513	E6	18
1.85mm Male		PE9665	B6	20
2.4mm Female		PE91499	E6	20
2.4mm Female		PE9456	A7	20
2.4mm Female	90°	PE91111	A5	19
2.4mm Female	90°	PE91525	B5	19
2.4mm Male		PE91451	C6	20
2.4mm Male	90°	PE9454	D6	20
2.4mm Male	90°	PE91502	B3	19
2.92mm Male	(R)	PE91070	A4	20
3.5mm Female		PE9660	C7	20
3.5mm Female	90°	PE91167	D7	20
3.5mm Female	90°	PE91521	E7	20
3.5mm Male	90°	PE91520	B7	20
3.5mm Male		PE9658	B6	21
7mm Sexless	(P)	PE9461	A1	21
Full Detent Mini SMP Male		PE91127	B1	21
Mini SMP Female		PE9782	D1	21
N Female	(P)	PE9664	A2	21
N Male	(P)	PE9663	E1	21
SMA Female	(P)	PE91011	D2	38
SMA Male	(P)	PE91008	E3	36
Smooth Bore Mini SMP Male		PE91128	C1	21
SMP Female		PE91060	B2	21
SSMA Male		PE9768	C2	21
<b>2.92mm In-Series:</b>				
Female to Female		PE91510	B1	20
Female to Female		PE9438	C1	20
Female to Female	90°	PE91517	D1	20
Female to Female	(B) (PM)	PE9647	E1	20
Female to Female	(PM)	PE91113	A2	20
Female to Female	(PM)	PE9648	B2	20
Female to Female	(PM)	PE91538	C2	20
Female to Female	(PM)	PE9437	E7	19
Male to Female		PE91503	A1	20
Male to Male		PE9436	C7	19
Male to Male	90°	PE91516	D7	19
<b>2.92mm Male To:</b>				
1.85mm Female		PE9666	A3	20
1.85mm Female	90°	PE91162	B6	18
1.85mm Female	90°	PE91512	C6	18
1.85mm Male		PE9667	E2	20
1.85mm Male	90°	PE91161	A5	18
1.85mm Male	90°	PE91519	B5	18
2.4mm Female		PE91450	D3	20
2.4mm Female	90°	PE9455	E3	20
2.4mm Female		PE91526	E4	19
2.4mm Male		PE91298	B3	20
2.4mm Male		PE9457	C3	20
2.4mm Male	(R)	PE91508	A3	19
2.92mm Female	90°	PE91070	A4	20
3.5mm Female	90°	PE91168	D4	20
3.5mm Female	90°	PE91514	E4	20
3.5mm Female		PE9659	A1	22
3.5mm Male	90°	PE91165	B4	20
3.5mm Male	90°	PE91522	C4	20
7mm Sexless		PE9460	A5	20
Mini SMP Female		PE91126	D5	20
Mini SMP Male		PE91124	B5	20
N Female	(P)	PE9662	A6	20

Connector Type	Feature	Model No.	C/R	Page
N Male	(P)	PE9661	E5	20
SMA Female	(P)	PE91009	C2	38
SMA Male	(P)	PE91010	D3	36
Smooth Bore Mini SMP Male		PE91125	C5	20
<b>2.92mm NMD Female To:</b>				
2.4mm Female		PE91144	E2	21
<b>3.5mm Female To:</b>				
1.85mm Female		PE9748	A7	21
1.85mm Male		PE9747	C5	18
2.4mm Female		PE91291	C7	21
2.4mm Female		PE9652	D7	21
2.4mm Female		PE91547	E7	21
2.4mm Male		PE9650	B7	21
2.92mm Female		PE9660	C7	20
2.92mm Female	90°	PE91167	D7	20
2.92mm Female	90°	PE91521	E7	20
2.92mm Male		PE9659	A1	22
2.92mm Male	90°	PE91168	D4	20
2.92mm Male	90°	PE91514	E4	20
7mm Sexless	(P)	PE9325	B1	22
7mm Sexless	(P)	PE91546	C1	22
N Female	(P)	PE9323	E1	22
N Male	(P)	PE9321	D1	22
SMA Female		PE9725	A3	38
SMA Male		PE91536	B4	36
<b>3.5mm In-Series:</b>				
Female to Female	(B) (PM)	PE9678	B4	21
Female to Female	(PM)	PE9676	C4	21
Female to Female	90°	PE91528	D4	21
Male to Female		PE9332	E3	21
Male to Female	90°	PE91523	A4	21
Male to Male		PE9330	B3	21
Male to Male	90°	PE91169	C3	21
Male to Male	90°	PE91515	D3	21
<b>3.5mm Male To:</b>				
1.85mm Female		PE9745	B5	21
1.85mm Male		PE9746	A5	21
2.4mm Female		PE91452	E5	21
2.4mm Female		PE9651	A6	21
2.4mm Male		PE91294	C5	21
2.4mm Male		PE9649	D5	21
2.4mm Male		PE9658	B6	21
2.92mm Female		PE91520	B7	20
2.92mm Female	90°	PE91165	B4	20
2.92mm Male	90°	PE91522	C4	20
7mm Sexless	(P)	PE9326	C6	21
N Female	(P)	PE9324	E6	21
N Male	(P)	PE9322	D6	21
SMA Female		PE9724	E2	38
SMA Male		PE9722	A4	36
<b>3.5mm NMD Female To:</b>				
2.4mm Female		PE91148	B2	22
SMA Female	(RU)	PE91147	C2	22
<b>4.1/9.5 Mini DIN Female To:</b>				
7/16 DIN Female		PE91208	D4	24
7/16 DIN Female		PE91245		

# Adapter Locator

Adapters

Connector Type	Feature	Model No.	C/R	Page
Male to Female	(LP)	PE91387	A1	23
Male to Male	(LP)	PE91466	B7	22
Male to Male	(LP)	PE91385	C7	22
<b>4.3-10 Male To:</b>				
7/16 DIN Female	(LP)	PE91470	C5	24
7/16 DIN Female	(LP)	PE91391	E5	24
7/16 DIN Male	(LP)	PE91468	B2	24
N Female	(LP)	PE91474	B2	23
N Female	(LP)	PE91477	C2	23
N Female	(LP) 90°	PE91483	E2	23
N Female	(LP)	PE91389	A3	23
N Male	(LP)	PE91476	E1	23
SMA Female	(LP)	PE91484	B3	23
<b>7/16 DIN Female To:</b>				
4.1/9.5 Mini DIN Female		PE91208	D4	24
4.1/9.5 Mini DIN Female		PE91245	E4	24
4.1/9.5 Mini DIN Female	(LP)	PE91091	A5	24
4.1/9.5 Mini DIN Female	(B)	PE91247	B5	24
4.1/9.5 Mini DIN Male		PE91209	A4	24
4.1/9.5 Mini DIN Male		PE91246	B4	24
4.1/9.5 Mini DIN Male	(LP)	PE91090	C4	24
4.3-10 Female	(LP)	PE91471	A6	24
4.3-10 Male	(LP)	PE91470	C5	24
4.3-10 Male	(LP)	PE91391	E5	24
HN Male		PE9559	C6	24
N Female		PE91213	A7	24
N Female		PE91250	B7	24
N Female	(B)	PE91215	C7	24
N Female	(B)	PE91252	D7	24
N Female	(LP)	PE91033	A2	32
N Female	(LP)	PE9180	B2	32
N Male		PE91214	D6	24
N Male		PE91251	E6	24
N Male	(LP)	PE91032	B1	31
N Male		PE91134	C1	31
QD 4.3-10 Female	(LP) (QD)	PE91473	B6	24
QD 4.3-10 Male	(LP) (QD)	PE91472	D5	24
SMA Female	(LP)	PE91042	A4	38
SMA Male		PE9411	D4	36
TNC Female		PE91392	D3	44
TNC Male		PE9638	D7	43
<b>7/16 DIN In-Series:</b>				
Female to Female		PE91192	B6	23
Female to Female		PE91229	C6	23
Female to Female	(LP)	PE91029	D6	23
Female to Female		PE9409	E6	23
Female to Female		PE9556	A7	23
Female to Female	(B) (LP)	PE91038	B7	23
Female to Female	(B)	PE9414	C7	23
Female to Female	(B)	PE91193	D7	23
Female to Female	(B)	PE91230	E7	23
Female to Male		PE9557	A6	23
Male to Female		PE91191	A5	23
Male to Female		PE91228	B5	23
Male to Female		PE91027	C5	23
Male to Female	(LP)	PE91028	D5	23
Male to Female	90°	PE91117	E5	23
Male to Male		PE91190	C4	23
Male to Male		PE91227	D4	23
Male to Male	(LP)	PE91039	E4	23
<b>7/16 DIN Male To:</b>				
4.1/9.5 Mini DIN Female		PE91207	E1	24
4.1/9.5 Mini DIN Female		PE91244	A2	24
4.1/9.5 Mini DIN Male		PE91206	B1	24
4.1/9.5 Mini DIN Male		PE91243	C1	24
4.1/9.5 Mini DIN Male	(LP)	PE91088	D1	24
4.3-10 Female	(LP)	PE91469	C2	24
4.3-10 Female	(LP)	PE91390	D2	24
4.3-10 Male	(LP)	PE91468	B2	24
HN Female		PE9558	E2	24
N Female		PE91212	C3	24
N Female		PE91249	D3	24
N Female	(LP)	PE91031	E1	32
N Male		PE91211	A3	24
N Male		PE91248	B3	24
N Male	(LP)	PE91030	E7	30
N Male		PE9535	A1	31
SC Female		PE91444	E3	24
SMA Female	(LP)	PE91036	D3	38
SMA Female		PE91175	E3	38
<b>75 Ohm BNC Female To:</b>				
75 Ohm F Female	(B)	PE91324	B4	45
75 Ohm F Female		PE9744	C7	45
75 Ohm F Male		PE9743	D6	45
75 Ohm Mini SMB Jack		PE9619	E2	46
75 Ohm Mini SMB Plug		PE9617	C2	46
75 Ohm N Female		PE9371	A7	46
75 Ohm N Male		PE9369	E4	46
75 Ohm TNC Male		PE9631	A7	47
<b>75 Ohm BNC In-Series:</b>				
Female to Female		PE9362	B3	45
Female to Female	(B)	PE9363	C3	45
Female to Female	(PM)	PE9367	D3	45
Female to Female	(B)	PE9791	E3	45
Female to Male		PE9365	A3	45
Male to Female	90°	PE9361	E2	45
Male to Male		PE9364	D2	45
<b>75 Ohm BNC Male To:</b>				
75 Ohm F Female		PE9741	B7	45

Connector Type	Feature	Model No.	C/R	Page
75 Ohm F Male		PE9742	D6	45
75 Ohm Mini SMB Jack		PE9618	D2	46
75 Ohm Mini SMB Plug		PE9616	B2	46
75 Ohm N Female		PE9368	E6	46
75 Ohm N Male		PE9370	D4	46
75 Ohm TNC Female		PE9630	D7	47
<b>75 Ohm F Female To:</b>				
75 Ohm BNC Female		PE9744	C7	45
75 Ohm BNC Female	(B)	PE91324	B4	45
75 Ohm BNC Male		PE9741	B7	45
75 Ohm N Female		PE9740	D7	46
75 Ohm N Male		PE9396	B5	46
75 Ohm PAL Jack		PE9634	D7	45
75 Ohm RCA Plug		PE9163	E7	45
75 Ohm TNC Female		PE91082	A1	48
75 Ohm TNC Male		PE91080	C7	47
BNC Female		PE9153	C4	26
BNC Male		PE9150	C2	26
N Male		PE9155	D3	31
SMA Female		PE91002	D5	38
SMA Male		PE91003	D5	36
UHF Female		PE9167	A2	45
UHF Male		PE9165	A1	45
<b>75 Ohm F In-Series:</b>				
Female to Female	(P)	PE91349	D5	45
Female to Female		PE9164	E5	45
Female to Female	(B) (PM)	PE9734	A6	45
Male to Female	(PO)	PE9180	A5	45
Male to Female		PE9759	B5	45
Male to Female	90°	PE9166	C5	45
Male to Male	(P)	PE91348	D4	45
Male to Male		PE9760	E4	45
<b>75 Ohm F Male To:</b>				
75 Ohm BNC Female		PE9743	D6	45
75 Ohm BNC Male		PE9742	C6	45
75 Ohm N Female		PE9397	B7	46
75 Ohm N Female		PE9739	C7	46
75 Ohm N Male		PE9738	A5	46
75 Ohm PAL Jack		PE9632	A7	45
75 Ohm PAL Plug		PE9633	E6	45
75 Ohm TNC Female		PE91083	E7	47
75 Ohm TNC Male		PE91081	B7	47
BNC Female		PE9151	B4	26
BNC Male		PE9152	B2	26
N Female		PE9389	D4	32
SMA Female		PE91045	C5	38
<b>75 Ohm Mini SMB In-Series:</b>				
Jack to Jack		PE9608	D1	46
Jack to Jack	(B)	PE9611	E1	46
Plug to Jack		PE9610	C1	46
Plug to Plug		PE9609	B1	46
<b>75 Ohm Mini SMB Jack To:</b>				
75 Ohm BNC Female		PE9619	E2	46
75 Ohm BNC Male		PE9618	D2	46
75 Ohm N Female		PE9615	A1	47
75 Ohm N Male		PE9614	D5	46
75 Ohm SMB Plug		PE9736	A4	47
<b>75 Ohm Mini SMB Plug To:</b>				
75 Ohm BNC Female		PE9617	C2	46
75 Ohm BNC Male		PE9616	B2	46
75 Ohm N Female		PE9613	E7	46
75 Ohm N Male		PE9612	C5	46
75 Ohm SMB Jack		PE9735	C4	47
<b>75 Ohm N Female To:</b>				
75 Ohm BNC Female		PE9371	A7	46
75 Ohm BNC Male		PE9368	E6	46
75 Ohm F Female		PE9740	D7	46
75 Ohm F Male		PE9397	B7	46
75 Ohm Mini SMB Jack		PE9615	A1	47
75 Ohm Mini SMB Plug		PE9613	E7	46
75 Ohm SMB Jack		PE9583	C1	47
75 Ohm SMB Plug		PE9585	B1	47
75 Ohm SMC Jack		PE9587	E1	47
75 Ohm SMC Plug		PE9589	D1	47
75 Ohm TNC Female		PE9629	B2	47
75 Ohm TNC Male		PE9628	A2	47
<b>75 Ohm N In-Series:</b>				
Female to Female		PE9306	E3	46
Female to Female	(B) (PM)	PE9417	A4	46
Female to Female	(B)	PE9416	B4	46
Male to Female		PE9391	C3	46
Male to Female	90°	PE9307	D3	46
Male to Male		PE9308	B3	46
<b>75 Ohm N Male To:</b>				
75 Ohm BNC Female		PE9369	E4	46
75 Ohm BNC Male		PE9370	D4	46
75 Ohm F Female		PE9396	B5	46
75 Ohm F Male		PE9738	A5	46
75 Ohm Mini SMB Jack		PE9614	D5	46
75 Ohm Mini SMB Plug		PE9612	C5	46
75 Ohm SMB Jack		PE9582	A6	46
75 Ohm SMB Plug		PE9584	E5	46
75 Ohm SMC Jack		PE9586	B6	46
75 Ohm TNC Female		PE9627	D6	46
75 Ohm TNC Male		PE9626	C6	46
<b>75 Ohm PAL In-Series:</b>				
Plug to Plug		PE9680	D2	47

Connector Type	Feature	Model No.	C/R	Page
<b>75 Ohm PAL Jack To:</b>				
75 Ohm F Female		PE9634	D7	45
75 Ohm F Male		PE9632	A7	45
<b>75 Ohm PAL Plug To:</b>				
75 Ohm F Plug		PE9633	E6	45
<b>75 Ohm Push-On RCA Jack To:</b>				
BNC Male	(PO)	PE9171	E2	26
<b>75 Ohm RCA Jack To:</b>				
BNC Female		PE9015	E4	26
<b>75 Ohm RCA Plug To:</b>				
75 Ohm F Female		PE9163	E7	45
BNC Female		PE9158	D4	26
<b>75 Ohm SMB In-Series:</b>				
Jack to Jack		PE9248	C3	47
Jack to Plug		PE9245	B3	47
Plug to Plug		PE9271	A3	47
<b>75 Ohm SMB Jack To:</b>				
75 Ohm Mini SMB Plug		PE9735	C4	47
75 Ohm N Female		PE9583	C1	47
75 Ohm N Male		PE9582	A6	46
BNC Female		PE9231	A5	26
BNC Male		PE9229	B4	47
<b>75 Ohm SMB Plug To:</b>				
75 Ohm Mini SMB Jack		PE9736	A4	47
75 Ohm N Female		PE9585	B1	47
75 Ohm N Male		PE9584	E5	46
BNC Female		PE9232	E3	47
BNC Male		PE9230	A3	26
<b>75 Ohm SMC In-Series:</b>				
Jack to Jack		PE9227	A5	47
Jack to Jack	(B) (PM)	PE9228	B5	47
Jack to Plug		PE9244	E4	47
<b>75 Ohm SMC Jack To:</b>				
75 Ohm N Female		PE9587	E1	47
75 Ohm N Male		PE9586	B6	46
BNC Female		PE9235	D5	47
BNC Male		PE91044	C3	26
<b>75 Ohm SMC Plug To:</b>				
75 Ohm N Female		PE9589	D1	47
BNC Female		PE9236	B5	26
BNC Male		PE9234	B3	26
<b>75 Ohm TNC Female To:</b>				
75 Ohm BNC Male		PE9630	D7	47
75 Ohm F Female		PE91082	A1	48
75 Ohm F Male		PE91083	E7	47
75 Ohm N Female		PE9629	B2	47
75 Ohm N Male		PE9627	D6	46
<b>75 Ohm TNC In-Series:</b>				
Female to Female		PE9622	B6	47
Female to Female	(B) (PM)	PE9625	C6	47
Female to Female	(B)	PE9624	D6	47
Male to Female	90°	PE9623	A6	47
<b>75 Ohm TNC Male To:</b>				
75 Ohm BNC Female		PE9631	A7	47
75 Ohm F Female		PE91080	C7	47
75 Ohm F Male		PE91081	B7	47
75 Ohm N Female		PE9628	A2	47
75 Ohm N Male		PE9626	C6	46
<b>78 Ohm BNC Twinax In-Series:</b>				
Jack to Jack		PE9378	A2	48
Jack to Jack	(B)	PE9280	B2	48
Jack to Plug		PE9375	E1	48
Plug to Jack	90°	PE9377	D1	48
Plug to Plug		PE9376	C1	48
<b>7mm Sexless To:</b>				
2.4mm Male		PE9458	C3	19
2.92mm Female	(P)	PE9461	A1	21
2.92mm Male		PE9460	A5	20
3.5mm Female	(P)	PE9325	B1	22
3.5mm Female	(P)	PE91546	C1	22
3.5mm Male	(P)	PE9326	C6	21
BNC Female	(P)	PE9220	A3	22
BNC Male	(P)	PE9221	E2	22
N Female	(P)	PE9216	D1	32
N Male	(P)	PE9217	C7	30
SMA Female	(P)	PE9214	B3	38
SMA Female	(P) (PM)	PE9327	C3	38
SMA Male	(P)	PE9215	C4	36
TNC Female	(P)	PE9218	C3	44
TNC Male	(P)	PE9219	C7	43
<b>95 Ohm 3/4"-20 Twinax In-Series:</b>				
Female to Female		PE9199	E2	48
Female to Female	(B)	PE9373	A3	48
Female to Male		PE9374	D2	48
<b>Banana Binding Post Jack To:</b>				
BNC Male		PE9169	C4	48
<b>Banana Plug To:</b>				
BNC Female		PE9175	C3	48
<b>BMA In-Series:</b>				
Jack to Jack		PE91395	A3	25
<b>BNC Female To:</b>				
10-32 Female		PE9752	C2	25
10-32 Female	(B)	PE9754	D2	25
10-32 Male		PE9753	E1	25
10-32 Male	(B)	PE9755	A2	25
75 Ohm F Female		PE9153	C4	26

Feature: (B) Bulkhead Mount / (H) Hermetically Sealed / (I) Isolated Sealed / (LP) Low PIM / (P) Precision / (PM) Panel Mount / (PO) Push On / (QD) Quick Disconnect / (R) Radius Right Angle / (RU) Ruggedized / (SO) Snap-On



Technical Support  
+1 (949) 261-1920



# Adapter Locator

Connector Type	Feature	Model No.	C/R	Page
75 Ohm F Male		PE9151	B4	26
75 Ohm RCA Jack		PE9015	E4	26
75 Ohm RCA Plug		PE9158	D4	26
75 Ohm SMB Jack		PE9231	A5	26
75 Ohm SMB Plug		PE9232	E3	47
75 Ohm SMC Jack		PE9235	D5	47
75 Ohm SMC Plug		PE9236	B5	26
7mm Sexless	(P)	PE9220	A3	22
Banana Plug		PE9175	C3	48
C Female		PE9537	A3	26
C Female	(B) (PM)	PE9204	E4	26
C Male		PE9087	D3	26
Double Banana Binding		PE9013	E4	48
Post Jack		PE9008	A4	48
Double Banana Plug		PE9712	E1	27
FME Jack		PE9126	D5	27
HN Male		PE9466	B3	28
MCX Jack		PE9520	C3	28
MCX Jack	(B) (PM)	PE9467	E2	28
MCX Plug		PE9342	D7	28
Mini UHF Male		PE9516	D3	29
MMCX Jack		PE9206	B3	32
N Female	(P)	PE9492	C3	32
N Female	(B) (PM)	PE9261	D3	32
N Female	(PM)	PE9238	E3	32
N Female	(B) (PM)	PE9540	A4	32
N Male		PE9002	B2	31
N Male	(P)	PE9491	C2	31
N Male	90°	PE9278	D2	31
N Male	(PM)	PE9388	E2	31
SC Female		PE9571	B7	33
SMA Female		PE9075	D4	38
SMA Female		PE9496	E4	38
SMA Female	(B)	PE9185	A5	38
SMA Female	(B)	PE9407	B5	38
SMA Male		PE9074	B5	36
SMA Male		PE9495	C5	36
SMB Jack		PE9136	D3	41
SMB Jack	(B)	PE9240	E3	41
SMB Plug		PE9137	A3	41
SMB Plug	(B) (PM)	PE9241	B3	41
SMC Jack		PE9140	E6	41
SMC Jack	(B)	PE9108	A7	41
SMC Plug		PE9141	A6	41
SSMA Male		PE91046	E4	42
SSMB Jack		PE9394	D6	42
SSMB Plug		PE9395	B6	42
TNC Female		PE9097	A4	44
TNC Male		PE9088	A1	44
TNC Male	90°	PE9783	B1	44
UHF Female		PE9421	E1	45
UHF Male		PE91328	E7	44
<b>BNC In-Series:</b>				
Female to Female		PE9084	C6	25
Female to Female		PE9003	D6	25
Female to Female	(B) (PM)	PE9420	E6	25
Female to Female	(B)	PE9093	A7	25
Female to Female	(B)	PE9172	B7	25
Female to Female	(PM)	PE9106	C7	25
Female to Male		PE9001	B6	25
Female to Male		PE9529	A1	26
Male to Female		PE9269	C5	25
Male to Female	90°	PE9085	D5	25
Male to Female		PE9174	E5	25
Male to Female		PE9484	A6	25
Male to Female		PE9530	E7	25
Male to Male		PE9000	A5	25
Male to Male	90°	PE9758	B5	25
<b>BNC Male To:</b>				
10-32 Female		PE9750	B2	25
10-32 Male		PE9751	D1	25
75 Ohm F Female		PE9150	C2	26
75 Ohm F Male		PE9152	B2	26
75 Ohm Push-On RCA Jack	(PO)	PE9171	E2	26
75 Ohm SMB Jack		PE9229	B4	47
75 Ohm SMB Plug		PE9230	A3	26
75 Ohm SMC Jack		PE91044	C3	26
75 Ohm SMC Plug		PE9234	B3	26
7mm Sexless	(P)	PE9221	E2	22
Banana Binding Post Jack		PE9169	C4	48
BNC Triax Female		PE91104	D1	26
C Female		PE9109	A2	26
C Male		PE9536	E1	26
Double Banana Binding		PE9011	C1	26
Post Jack		PE9009	E3	48
Double Banana Plug		PE9711	D1	27
FME Jack		PE9697	B1	27
FME Plug		PE9698	C1	27
FME Plug	90°	PE9698	C1	27
GR874 Sexless		PE9223	E2	27
HN Female		PE9129	D6	27
HN Male		PE9567	C5	27
MCX Jack		PE9468	A3	28
MCX Plug		PE9469	D2	28
MHV Female		PE9406	D2	26
Mini UHF Female		PE9341	C1	29
MMCX Jack		PE9518	C3	29

Connector Type	Feature	Model No.	C/R	Page
MMCX Plug		PE9517	E2	29
N Female		PE9005	C2	32
N Female	(P)	PE9490	D2	32
N Female	90°	PE9566	E2	32
N Female	(PM)	PE9123	A3	32
N Male		PE9127	D1	31
N Male	(P)	PE9489	E1	31
N Male	90°	PE9565	A2	31
<b>Reverse Polarity TNC</b>				
Female		PE91087	A6	44
SC Male		PE9568	A7	33
SMA Female		PE9073	B4	38
SMA Female		PE9494	C4	38
SMA Male		PE9072	E4	36
SMA Male		PE9493	A5	36
SMB Jack		PE9132	C3	41
SMB Plug		PE9135	E2	41
SMC Jack		PE9138	D6	41
SMC Plug		PE9139	E5	41
SSMA Female		PE9191	B5	42
SSMA Male		PE9213	D4	42
SSMB Jack		PE9392	C6	42
SSMB Plug		PE9393	A6	42
TNC Female		PE9098	E3	44
TNC Male		PE91449	E7	43
UHF Female		PE91329	D1	45
UHF Male		PE9201	D7	44
<b>BNC Triax Female To:</b>				
BNC Male		PE91104	D1	26
<b>BNC Triax In-Series:</b>				
Female to Female		PE91107	C5	48
Female to Female	(B) (PM)	PE91105	D5	48
Male to Female		PE91106	B5	48
<b>C Female To:</b>				
BNC Female		PE9537	E3	26
BNC Female	(B) (PM)	PE9204	A4	26
BNC Male		PE9109	A2	26
GR874 Sexless		PE9301	A3	27
HN Male		PE9296	A6	27
N Female		PE9539	C4	32
N Male		PE91446	B3	31
N Male	90°	PE9239	C3	31
TNC Male		PE9562	C1	44
<b>C In-Series:</b>				
Female to Female		PE9208	B6	26
Female to Female		PE9294	C6	26
Female to Female	(B) (PM)	PE9186	D6	26
Female to Male		PE9207	A6	26
Male to Female	90°	PE9293	E5	26
Male to Male		PE9300	D5	26
<b>C Male To:</b>				
BNC Female		PE9087	D3	26
BNC Male		PE9536	E1	26
HN Female		PE9212	E6	27
HN Male		PE9579	E5	27
N Female		PE9295	B4	32
N Male		PE9538	A3	31
TNC Female		PE9564	B4	44
<b>Double Banana Binding Post Jack To:</b>				
BNC Female		PE9013	E4	48
BNC Male		PE9011	C1	26
<b>Double Banana Plug To:</b>				
BNC Female		PE9008	A4	48
BNC Male		PE9009	E3	48
<b>D-Sub In-Series:</b>				
Plug to Plug		PE9688	A7	26
Plug to Receptacle		PE9687	B7	26
Receptacle to Receptacle		PE9689	C7	26
<b>FME In-Series:</b>				
Plug to Plug		PE9696	E7	26
<b>FME Jack To:</b>				
BNC Female		PE9712	E1	27
BNC Male		PE9711	D1	27
Mini UHF Female		PE9710	D1	29
Mini UHF Male		PE9709	B1	29
SMA Female		PE9708	A6	38
SMA Male		PE9707	E5	36
TNC Female		PE9714	C4	44
TNC Male		PE9713	A2	44
<b>FME Plug To:</b>				
BNC Male		PE9697	B1	27
BNC Male	90°	PE9698	C1	27
Mini UHF Male		PE9705	E7	28
Mini UHF Male	90°	PE9706	A1	29
N Female		PE9704	E3	31
N Female		PE9703	E5	38
SMA Female		PE9699	D1	44
TNC Male	90°	PE9700	E1	44
UHF Male		PE9701	B1	45
<b>Full Detent Mini SMP Male To:</b>				
2.4mm Female		PE91122	C5	19
2.4mm Male		PE91121	D3	19
2.92mm Female		PE91127	B1	21
SMA Female		PE91299	B7	38
SMA Female		PE91129	D7	38
SMA Male		PE91302	A7	38
SMA Male	(P)	PE91052	C7	36

Connector Type	Feature	Model No.	C/R	Page
<b>Full Detent SMP Male To:</b>				
SMA Female		PE91305	D5	39
SMA Female	(P)	PE91056	D6	39
SMA Female	(B) (PM)	PE91054	B7	39
SMA Female	(P) (PM)	PE91058	D7	39
SMA Male		PE91309	D4	37
SMA Male	(P)	PE91063	B5	37
<b>GR874 In-Series:</b>				
Sexless to Sexless	90°	PE9286	B2	27
Sexless to Sexless		PE9285	C2	27
<b>GR874 Sexless To:</b>				
BNC Male		PE9223	E2	27
C Female		PE9301	A3	27
HN Female		PE9387	A7	27
HN Male		PE9386	B6	27
N Female		PE9258	E4	32
N Male		PE9257	A4	31
SMA Female		PE9260	B6	38
SMA Male		PE9259	A6	36
<b>HN Female To:</b>				
7/16 DIN Male		PE9558	E2	24
BNC Male		PE9129	D6	27
C Male		PE9212	E6	27
GR874 Sexless		PE9387	A7	27
LC Male		PE9181	B1	28
N Female		PE9360	B5	32
N Female	(PM)	PE9553	C5	32
N Male		PE9125	C4	31
SMA Female		PE9255	D6	38
SMA Male		PE9256	C6	36
<b>HN In-Series:</b>				
Female to Female		PE9580	D4	27
Female to Female		PE9574	E4	27
Female to Female	(B) (PM)	PE9193	A5	27
Female to Male		PE9575	C4	27
Male to Female		PE9576	E3	27
Male to Female	90°	PE9205	A4	27
Male to Female		PE9578	B4	27
Male to Male		PE9210	C3	27
Male to Male	90°	PE9577	D3	27
<b>HN Male To:</b>				
7/16 DIN Female		PE9559	C6	24
BNC Female		PE9126	D5	27
BNC Male		PE9567	C5	27
C Female		PE9296	A6	27
C Male		PE9579	E5	27
GR874 Sexless		PE9386	B6	27
LC Female		PE9413	C1	28
MHV Female		PE9264	C6	27
N Female		PE9194	A5	32
N Male		PE9554	B4	31
SMA Female		PE9253	C6	38
SMA Male		PE91448	B6	36
TNC Male		PE9563	B2	44
<b>LC Female To:</b>				
HN Male		PE9413	C1	28
N Female		PE9298	E5	32
N Male		PE9299	D4	31
<b>LC In-Series:</b>				
Female to Female		PE9419	E7	27
Male to Female	90°	PE9398	D7	27
Male to Male		PE9569	C7	27
<b>LC Male To:</b>				
HN Female		PE9181	B1	28
N Female		PE9237	D5	32
<b>Limited Detent SMP Male To:</b>				
SMA Female		PE91306	E5	39
SMA Female	(P)	PE91050	C6	39
SMA Female	(P)	PE9512	E6	39
SMA Female		PE9778	A7	39
SMA Female	(P) (PM)	PE91066	A1	40
SMA Male		PE91310	E4	37
SMA Male	(P)	PE9511	C5	37
TNC Female	(B)	PE91073	C5	44
<b>MCX In-Series:</b>				
Jack to Jack		PE9524	A2	28
Jack to Jack	(B)	PE9474	B2	28
Plug to Jack		PE9479	E1	28
<b>MCX Jack To:</b>				
BNC Female		PE9466	B3	28
BNC Female	(B) (PM)	PE9520	C3	28
BNC Male		PE9468	A3	28
MMCX Jack		PE9526	A4	29
MMCX Plug		PE9525	B3	29
N Female		PE9462	B6	32
N Male		PE9464	A5	31
SMA Female		PE9470	A7	38
SMA Male		PE9472	E6	36
TNC Female		PE9544	E4	44
TNC Female	(B) (PM)	PE9521	A5	44
TNC Male		PE9542	D2	44
<b>MCX Plug To:</b>				
BNC Female		PE9467	E2	28
BNC Male		PE9469	D2	28
MMCX Jack		PE9528	E3	29
MMCX Plug		PE9527	A3	29
N Female		PE9463	A6	32
N Male		PE9465	E4	31

Feature: (B) Bulkhead Mount / (H) Hermetically Sealed / (I) Isolated Sealed / (LP) Low PIM / (P) Precision / (PM) Panel Mount / (PO) Push On / (QD) Quick Disconnect / (R) Radius Right Angle / (RU) Ruggedized / (SO) Snap-On



# Adapter Locator

Adapters

Connector Type	Feature	Model No.	C/R	Page
SMA Female		PE9471	E6	38
SMA Male		PE9473	D6	36
TNC Female		PE9545	D4	44
TNC Male		PE9543	C2	44
<b>MHV Female To:</b>				
BNC Male		PE9406	D2	26
HN Male		PE9264	C6	27
SHV Jack		PE9339	D5	28
SHV Plug		PE9265	C5	28
<b>MHV In-Series:</b>				
Female to Female		PE9267	C4	28
Female to Female	(B)	PE9268	D4	28
Female to Male		PE9211	B4	28
Male to Female		PE9297	E3	28
Male to Female	90°	PE9266	A4	28
<b>MHV Male To:</b>				
SHV Jack		PE9335	B5	28
SHV Plug		PE9340	A5	28
<b>Mini SMP Female To:</b>				
2.4mm Female		PE91123	D5	19
2.92mm Female		PE9782	D1	21
2.92mm Male		PE91126	D5	20
SMA Female		PE91301	E7	38
SMA Female	(P)	PE91051	A1	39
SMA Male		PE91304	D7	36
SMA Male	(P)	PE91103	E7	36
<b>Mini SMP In-Series:</b>				
Female to Female		PE9780	A6	28
Female to Female		PE91069	B6	28
<b>Mini SMP Male To:</b>				
2.92mm Male		PE91124	B5	20
<b>Mini UHF Female To:</b>				
BNC Male		PE9341	C1	29
FME Jack		PE9710	D1	29
N Male		PE9064	B5	31
TNC Male		PE9345	E2	44
UHF Male		PE9348	C1	45
<b>Mini UHF In-Series:</b>				
Female to Female		PE9343	A7	28
Female to Female		PE9066	B7	28
Female to Male		PE9065	E6	28
Male to Female	90°	PE9347	D6	28
<b>Mini UHF Male To:</b>				
BNC Female		PE9342	D7	28
FME Jack		PE9709	B1	29
FME Plug		PE9705	E7	28
FME Plug	90°	PE9706	A1	29
N Female		PE9183	C6	32
TNC Female		PE9346	B5	44
UHF Female		PE91447	B2	45
<b>MMBX In-Series:</b>				
Plug to Plug	(SO)	PE91370	C4	29
Plug to Plug		PE91371	D4	29
Plug to Plug	(SO)	PE91372	E4	29
Plug to Plug	(SO)	PE91373	A5	29
<b>MMCX In-Series:</b>				
Jack to Jack		PE9523	B2	29
Jack to Jack	(B) (PM)	PE9522	C2	29
Plug to Jack		PE9480	A2	29
<b>MMCX Jack To:</b>				
BNC Female		PE9516	D3	29
BNC Male		PE9518	C3	29
MCX Jack		PE9526	A4	29
MCX Plug		PE9528	E3	29
SMA Female		PE9477	C1	39
SMA Male		PE9478	B1	37
<b>MMCX Plug To:</b>				
BNC Male		PE9517	E2	29
MCX Jack		PE9525	B3	29
MCX Plug		PE9527	A3	29
SMA Female		PE9475	B1	39
SMA Male		PE9476	A1	37
<b>N Female To:</b>				
1.85mm Female		PE9721	B7	18
1.85mm Male		PE9719	E5	18
2.4mm Female	(P)	PE9502	A6	19
2.4mm Male	(P)	PE9501	A4	19
2.92mm Female	(P)	PE9684	A2	21
2.92mm Male	(P)	PE9682	A6	20
3.5mm Female	(P)	PE9323	E1	22
3.5mm Male	(P)	PE9324	E6	21
4.1/9.5 Mini DIN Female		PE91218	C6	22
4.1/9.5 Mini DIN Female		PE91255	D6	22
4.1/9.5 Mini DIN Female	(LP)	PE91095	E6	22
4.1/9.5 Mini DIN Male		PE91217	B5	22
4.1/9.5 Mini DIN Male		PE91254	C5	22
4.1/9.5 Mini DIN Male	(LP)	PE91093	D5	22
4.3-10 Female	(LP)	PE91475	E3	23
4.3-10 Male	(LP)	PE91474	B2	23
4.3-10 Male	(LP)	PE91477	C2	23
4.3-10 Male	(LP) 90°	PE91483	E2	23
4.3-10 Male	(LP)	PE91389	A3	23
7/16 DIN Female	(LP)	PE91033	A2	32
7/16 DIN Female	(LP)	PE9180	B2	32
7/16 DIN Female		PE91213	A7	24
7/16 DIN Female		PE91250	B7	24
7/16 DIN Female	(B)	PE91215	C7	24

Connector Type	Feature	Model No.	C/R	Page
7/16 DIN Female	(B)	PE91252	D7	24
7/16 DIN Male	(LP)	PE91031	E1	32
7/16 DIN Male		PE91212	C3	24
7/16 DIN Male		PE91249	D3	24
75 Ohm F Male		PE9389	D4	32
7mm Sexless		PE9216	D1	32
BNC Female	(P)	PE9206	B3	32
BNC Female	(P)	PE9492	C3	32
BNC Female	(B) (PM)	PE9261	D3	32
BNC Female	(PM)	PE9238	E3	32
BNC Female	(B) (PM)	PE9540	A4	32
BNC Male		PE9005	C2	32
BNC Male	(P)	PE9490	D2	32
BNC Male	90°	PE9566	E2	32
BNC Male	(PM)	PE9123	A3	32
C Female		PE9539	C4	32
C Male		PE9295	B4	32
GR874 Sexless		PE9258	E4	32
HN Female		PE9360	B5	32
HN Female	(PM)	PE9553	C5	32
HN Male		PE9194	A5	32
LC Female		PE9298	E5	32
LC Male		PE9237	D5	32
MCX Jack		PE9462	B6	32
MCX Plug		PE9463	A6	32
Mini UHF Male		PE9183	C6	32
QD 4.3-10 Female	(LP) (QD)	PE91482	A4	23
QD 4.3-10 Male	(LP) (QD)	PE91478	D2	23
Reverse Polarity SMA Male		PE9732	E5	40
Reverse Polarity TNC Male		PE9731	C3	33
SC Female		PE9292	E6	32
SC Male		PE9277	D6	32
SMA Female		PE9083	A3	39
SMA Female	(P)	PE9432	B3	39
SMA Female	(B)	PE9252	C3	39
SMA Female	(B) (P)	PE9486	D3	39
SMA Female	(PM)	PE9104	E3	39
SMA Female	(P) (PM)	PE9434	A4	39
SMA Female	(B)	PE9408	B4	39
SMA Female	(B) (P)	PE9435	C4	39
SMA Male	(PM)	PE91178	A7	32
SMA Male	(LP)	PE9082	C2	37
SMA Male	(P)	PE9433	D2	37
SMA Male	(B) (P)	PE9487	E2	37
SMA Male	(PM)	PE9105	A3	37
SMA Male	(P) (PM)	PE9497	B3	37
SMA Male	(B) (P)	PE9488	C3	37
SMB Jack		PE9315	C7	32
SMB Plug		PE9316	B7	32
SMC Jack		PE9319	E7	32
SMC Plug		PE9320	D7	32
SSMA Female		PE9354	D5	42
TNC Female		PE9131	D1	33
TNC Female	(P)	PE9449	E1	33
TNC Female	(PM)	PE9552	A2	33
TNC Female	(B)	PE9482	B2	33
TNC Female	(P) (PM)	PE9450	C2	33
TNC Male		PE9089	A1	33
TNC Male	(P)	PE91506	B1	33
TNC Male	90°	PE9263	C1	33
UHF Female		PE9385	E2	33
UHF Male		PE9112	D2	33
<b>N In-Series:</b>				
Female to Female		PE91200	D2	30
Female to Female		PE91237	E2	30
Female to Female		PE9006	A3	30
Female to Female	(LP)	PE91140	B3	30
Female to Female		PE91141	C3	30
Female to Female	(P)	PE91530	D3	30
Female to Female	90°	PE9359	E3	30
Female to Female		PE9101	A4	30
Female to Female	(B)	PE9548	B4	30
Female to Female	(B)	PE9128	C4	30
Female to Female	(B)	PE9383	D4	30
Female to Female	(B) 90°	PE9541	E4	30
Female to Female	(PM)	PE9173	A5	30
Female to Female	(P) (PM)	PE9429	B5	30
Female to Female	(B)	PE91201	C5	30
Female to Female	(B)	PE91238	D5	30
Female to Female	(B) (LP)	PE91179	E5	30
Female to Female	(B) (P)	PE9500	A6	30
Female to Female	(B)	PE9382	B6	30
Female to Male		PE9350	B2	30
Female to Male		PE9102	C2	30
Female to Male		PE9770	E6	30
Male to Female		PE91199	E6	29
Male to Female		PE91236	A7	29
Male to Female	(LP)	PE91040	B7	29
Male to Female	(PO)	PE91114	C7	29
Male to Female	(P)	PE91531	D7	29
Male to Female		PE9311	E7	29
Male to Female		PE9349	A1	30
Male to Female	(QD)	PE9547	B1	30
Male to Female	(P) (R)	PE91350	C1	30
Male to Female	90°	PE9086	D1	30
Male to Female		PE9481	E1	30
Male to Female	(B)	PE9595	A2	30
Male to Female		PE9771	D6	30
Male to Female		PE91198	C5	29

Connector Type	Feature	Model No.	C/R	Page
Male to Male		PE91235	D5	29
Male to Male		PE9007	E5	29
Male to Male	(LP)	PE91034	A6	29
Male to Male	(P)	PE91532	B6	29
Male to Male	90°	PE9198	C6	29
Male to Male		PE9390	D6	29
<b>N Male To:</b>				
1.85mm Female		PE9720	A7	18
1.85mm Male		PE9718	D5	18
2.4mm Female	(P)	PE9503	E5	19
2.4mm Male	(P)	PE9504	E3	19
2.92mm Female	(P)	PE9663	E1	21
2.92mm Male	(P)	PE9661	E5	20
3.5mm Female	(P)	PE9321	D1	22
3.5mm Male	(P)	PE9322	D6	21
4.1/9.5 Mini DIN Female		PE91219	E5	22
4.1/9.5 Mini DIN Female		PE91256	A6	22
4.1/9.5 Mini DIN Female	(LP)	PE91094	B6	22
4.1/9.5 Mini DIN Male		PE91216	E4	22
4.1/9.5 Mini DIN Male	(LP)	PE91092	A5	22
4.3-10 Female	(LP)	PE91388	D7	30
4.3-10 Female	(LP)	PE91479	C3	23
4.3-10 Male	(LP)	PE91476	E1	23
7/16 DIN Female	(LP)	PE91032	B1	31
7/16 DIN Female		PE91134	C1	31
7/16 DIN Female		PE91214	D6	24
7/16 DIN Female		PE91251	E6	24
7/16 DIN Male	(LP)	PE91030	E7	30
7/16 DIN Male		PE9535	A1	31
7/16 DIN Male		PE91211	A3	24
7/16 DIN Male		PE91248	B3	24
75 Ohm F Female		PE9155	D3	31
7mm Sexless	(P)	PE9217	C7	30
BNC Female		PE9002	B2	31
BNC Female	(P)	PE9491	C2	31
BNC Female	90°	PE9278	D2	31
BNC Female	(PM)	PE9388	E2	31
BNC Male		PE9127	D1	31
BNC Male	(P)	PE9489	E1	31
BNC Male	90°	PE9565	A2	31
C Female		PE91446	B3	31
C Female	90°	PE9239	C3	31
C Male		PE9538	A3	31
FME Plug		PE9704	E3	31
GR874 Sexless		PE9257	A4	31
HN Female		PE9125	C4	31
HN Male		PE9554	B4	31
LC Female		PE9299	D4	31
MCX Jack		PE9464	A5	31
MCX Plug		PE9465	E4	31
Mini UHF Female		PE9064	B5	31
QD 4.3-10 Female	(LP) (QD)	PE91481	D3	23
QD 4.3-10 Male	(LP) (QD)	PE91480	A2	23
QMA Female		PE9787	C5	31
Reverse Polarity SMA Female		PE9733	C6	40
Reverse Polarity TNC Female		PE9730	B3	33
SC Female		PE9196	E5	31
SC Male		PE9570	D5	31
SMA Female	(LP)	PE91177	A6	31
SMA Female	(P)	PE91339	B6	31
SMA Female		PE9081	A2	39
SMA Female	(B)	PE9551	C2	39
SMA Female	(PM)	PE9275	D2	39
SMA Female	(P) (PM)	PE9498	E2	39
SMA Male		PE9080	E1	37
SMA Male	(P)	PE9431	A2	37
SMA Male	(P) (PM)	PE9499	B2	37
SMB Jack		PE9313	D6	31
SMB Plug		PE9314	C6	31
SMC Jack		PE9317	A7	31
SMC Plug		PE9318	E6	31
SSMA Female		PE9352	C5	42
SSMA Male		PE9351	A5	42
TNC Female		PE9090	D7	31
TNC Female	90°	PE9550	E7	31
TNC Female		PE91537	A1	32
TNC Male		PE9130	B7	31
TNC Male	(P)	PE9446	C7	31
UHF Female		PE9111	C1	32
UHF Male		PE9113	B1	32
<b>Push-On SMA Male To:</b>				
SMA Female	(PO)	PE91336	D3	37
<b>Push-On SMP Female To:</b>				
Snap-On MMBX Plug	(PO) (SO)	PE91364	D2	42
<b>QD 4.3-10 Female To:</b>				
7/16 DIN Female	(LP) (QD)	PE91473	B6	24
N Female	(LP) (QD)	PE91482	A4	23
N Male	(LP) (QD)	PE91481	D3	23
<b>QD 4.3-10 Male To:</b>				
7/16 DIN Female	(LP) (QD)	PE91472	D5	24
N Female	(LP) (QD)	PE91478	D2	23
N Male	(LP) (QD)	PE91480	A2	23
<b>QD N Male To:</b>				
SMA Female	(QD)	PE9684	B2	39
<b>QMA Female To:</b>				
N Male		PE9787	C5	31
<b>QMA In-Series:</b>				
Female to Female	(SO)	PE91343	B4	33

Feature: (B) Bulkhead Mount / (H) Hermetically

# Adapter Locator

Connector Type	Feature	Model No.	C/R	Page
Male to Female	(SO)	PE91342	A4	33
Male to Male	(SO)	PE91341	E3	33
<b>QMA Male To:</b>				
SMA Female		PE9786	D4	39
<b>Reverse Polarity MCX Plug To:</b>				
SMA Male		PE9581	A5	40
<b>Reverse Polarity N In-Series:</b>				
Female to Female		PE9773	A7	30
<b>Reverse Polarity SMA Female To:</b>				
N Male		PE9733	C6	40
Reverse Polarity TNC Female		PE9606	D7	40
Reverse Polarity TNC Male		PE9607	C7	40
TNC Female		PE9599	E6	40
TNC Male		PE9598	D6	40
<b>Reverse Polarity SMA In-Series:</b>				
Female to Female		PE91262	D7	35
Female to Female		PE91334	E7	35
Female to Female	(B) (PM)	PE9593	A1	36
Female to Female	(PM)	PE91270	B1	36
Female to Female	(PM)	PE91269	C1	36
Male to Female	(QD)	PE91267	B6	35
Male to Female	90°	PE91263	C6	35
Male to Female	(QD)	PE91268	A7	35
Male to Female		PE91331	B7	35
Male to Female	90°	PE9594	C7	35
Male to Male	(QD)	PE91266	A6	35
Male to Male		PE91261	D6	35
Male to Male		PE91330	E6	35
<b>Reverse Polarity SMA Male To:</b>				
N Female		PE9732	E5	40
Reverse Polarity TNC Female		PE9604	B7	40
Reverse Polarity TNC Male		PE9605	A7	40
TNC Female		PE9596	B6	40
TNC Male		PE9597	A6	40
<b>Reverse Polarity TNC Female To:</b>				
BNC Male		PE91087	A6	44
N Male		PE9730	B3	33
Reverse Polarity SMA Female		PE9606	D7	40
Reverse Polarity SMA Male		PE9604	B7	40
SMA Female		PE9603	D5	40
SMA Male		PE9600	B5	40
<b>Reverse Polarity TNC In-Series:</b>				
Male to Female	90°	PE9918	A7	43
<b>Reverse Polarity TNC Male To:</b>				
N Female		PE9731	C3	33
Reverse Polarity SMA Female		PE9607	C7	40
Reverse Polarity SMA Male		PE9605	A7	40
SMA Female		PE9602	C5	40
<b>SC Female To:</b>				
7/16 DIN Male		PE91444	E3	24
BNC Female		PE9571	B7	33
N Female		PE9292	E6	32
N Male		PE9196	E5	31
<b>SC In-Series:</b>				
Female to Female		PE9404	C6	33
Female to Female	(B)	PE9573	D6	33
Female to Male		PE9225	B6	33
Male to Female		PE9572	E5	33
Male to Female	90°	PE9405	A6	33
Male to Male		PE9403	D5	33
<b>SC Male To:</b>				
BNC Male		PE9568	A7	33
N Female		PE9277	D6	32
N Male		PE9570	D5	31
<b>SHV In-Series:</b>				
Jack to Jack		PE9337	B1	34
Jack to Jack	(B)	PE9336	C1	34
Jack to Plug		PE9249	A1	34
Plug to Jack		PE9749	D7	33
Plug to Jack	90°	PE9338	E7	33
<b>SHV Jack To:</b>				
MHV Female		PE9339	D5	28
MHV Male		PE9335	B5	28
<b>SHV Plug To:</b>				
MHV Female		PE9265	C5	28
MHV Male		PE9340	A5	28
<b>Slide-On BMA Jack To:</b>				
SMA Female		PE91400	C4	25
SMA Female	(PM)	PE91399	D4	25
SMA Male		PE91397	B4	25
<b>Slide-On BMA Plug To:</b>				
SMA Female		PE91398	E3	25
SMA Female	(B)	PE91402	A4	25
SMA Male		PE91396	C3	25
SMA Male	(B)	PE91401	D3	25
<b>SMA Female To:</b>				
1.0/2.3 Jack		PE9693	C1	38
1.0/2.3 Plug		PE9691	B1	38
1.85mm Female		PE9729	E1	38
1.85mm Male		PE9726	D1	38
2.4mm Female	(P)	PE9656	B2	38
2.4mm Male		PE9655	A2	38
2.4mm NMD Female	(RU)	PE91146	A7	19
2.92mm Female	(P)	PE91011	D2	38
2.92mm Male	(P)	PE91009	C2	38
3.5mm Female		PE9725	A3	38
3.5mm Male		PE9724	E2	38

Connector Type	Feature	Model No.	C/R	Page
3.5mm NMD Female	(RU)	PE91147	C2	22
4.3-10 Male	(LP)	PE91484	B3	23
7/16 DIN Female	(LP)	PE91042	A4	38
7/16 DIN Male	(LP)	PE91036	D3	38
7/16 DIN Male		PE91175	E3	38
75 Ohm F Female		PE91002	D5	38
75 Ohm F Male		PE91045	C5	38
7mm Sexless	(P)	PE9214	B3	38
7mm Sexless	(P) (PM)	PE9327	C3	38
BNC Female		PE9075	D4	38
BNC Female		PE9496	E4	38
BNC Female	(B)	PE9185	A5	38
BNC Female	(B)	PE9407	B5	38
BNC Male		PE9073	B4	38
BNC Male		PE9494	C4	38
FME Jack		PE9708	A6	38
FME Plug		PE9703	E5	38
Full Detent Mini SMP Male		PE91299	B7	38
Full Detent Mini SMP Male		PE91129	D7	38
Full Detent SMP Male		PE91305	D5	39
Full Detent SMP Male	(P)	PE91056	D6	39
Full Detent SMP Male	(B) (PM)	PE91054	B7	39
Full Detent SMP Male	(P) (PM)	PE91058	D7	39
GR874 Sexless		PE9260	B6	38
HN Female		PE9255	D6	38
HN Male		PE9253	C6	38
Limited Detent SMP Male		PE91306	E5	39
Limited Detent SMP Male	(P)	PE91050	C6	39
Limited Detent SMP Male	(P)	PE9512	E6	39
Limited Detent SMP Male		PE9778	A7	39
Limited Detent SMP Male	(P) (PM)	PE91066	A1	40
MCX Jack		PE9470	A7	38
MCX Plug		PE9471	E6	38
Mini SMP Female		PE91301	E7	38
Mini SMP Female	(P)	PE91051	A1	39
MMCX Jack		PE9477	C1	39
MMCX Plug		PE9475	B1	39
N Female		PE9083	A3	39
N Female	(P)	PE9432	B3	39
N Female	(B)	PE9252	C3	39
N Female	(B) (P)	PE9486	D3	39
N Female	(PM)	PE9104	E3	39
N Female	(P) (PM)	PE9434	A4	39
N Female	(B)	PE9408	B4	39
N Female	(B) (P)	PE9435	C4	39
N Male		PE9081	A2	39
N Male	(B)	PE9551	C2	39
N Male	(PM)	PE9275	D2	39
N Male	(P) (PM)	PE9498	E2	39
N Male	(LP)	PE91177	A6	31
N Male	(P)	PE91339	B6	31
Push-On SMA Male	(PO)	PE91336	D3	37
QD N Male	(QD)	PE9684	B2	39
QMA Male		PE9786	D4	39
Reverse Polarity TNC Female		PE9603	D5	40
Reverse Polarity TNC Male		PE9602	C5	40
Slide-On BMA Jack		PE91400	C4	25
Slide-On BMA Jack	(PM)	PE91399	D4	25
Slide-On BMA Plug		PE91398	E3	25
Slide-On BMA Plug	(B)	PE91402	A4	25
SMB Jack		PE9143	A5	39
SMB Plug		PE9142	E4	39
SMC Jack		PE9147	C5	39
SMC Plug		PE9146	B5	39
Smooth Bore Mini SMP Male		PE91300	C7	38
Smooth Bore SMP Male		PE91307	A6	39
Smooth Bore SMP Male	(P)	PE91049	B6	39
Smooth Bore SMP Male	(P) (PM)	PE91061	E7	39
SMP Female		PE91308	C1	40
SMP Female	(P)	PE91064	D1	40
SMP Female	(P)	PE9779	E1	40
SMP Male	(P) (PM)	PE91057	C7	39
SMP Male	(P) (PM)	PE91059	B1	40
Snap-On MMBX Jack	(SO)	PE91363	E1	39
Snap-On MMBX Plug	(SO)	PE91361	D1	39
Snap-On QMA Male	(SO)	PE91345	E4	33
SSMA Female		PE9399	B2	40
SSMA Male		PE9188	A2	40
SSMB Plug		PE9402	C2	40
SSMC Jack		PE91433	E2	40
SSMC Plug		PE91380	D2	40
TNC Female		PE9079	C3	40
TNC Female		PE9442	D3	40
TNC Female	(B) (PM)	PE9251	E3	40
TNC Female	(PM)	PE9276	A4	40
TNC Male		PE9077	A3	40
TNC Male		PE9440	B3	40
UHF Male		PE9415	B4	40
UMCX Jack		PE91006	D4	40
UMCX Plug		PE91005	C4	40
<b>SMA In-Series:</b>				
Female to Female		PE9070	B7	34
Female to Female		PE9380	C7	34
Female to Female	(P)	PE9507	D7	34
Female to Female	(P)	PE9695	E7	34

Connector Type	Feature	Model No.	C/R	Page
Female to Female	(R)	PE91494	A1	35
Female to Female	(R)	PE91495	B1	35
Female to Female	90° (P)	PE91153	C1	35
Female to Female	90°	PE9485	D1	35
Female to Female		PE9246	E1	35
Female to Female	(B) (PM)	PE9014	A2	35
Female to Female	(B)	PE91258	B2	35
Female to Female	(B) (PM)	PE9508	C2	35
Female to Female	(B) (P)	PE9620	D2	35
Female to Female	(PM)	PE91393	E2	35
Female to Female	(H) (B)	PE9184	A3	35
Female to Female	(B)	PE9067	B3	35
Female to Female	(B)	PE9312	C3	35
Female to Female	(PM)	PE9670	D3	35
Female to Female	(B)	PE9184NH	E3	35
Female to Female	(PM)	PE91290	A4	35
Female to Female	(P)	PE91549	B4	35
Female to Female	90°	PE91176	C4	35
Female to Female		PE91260	E5	35
Female to Male		PE9182	A7	34
Female to Male		PE9533	D5	35
Female to Male		PE9683	A2	36
Female to Male		PE9103	E3	34
Female to Male	(P)	PE9506	A4	34
Female to Male	(QD)	PE9546	B4	34
Female to Male	(P)	PE9694	C4	34
Female to Male	(P) (QD)	PE9774	D4	34
Female to Male	(R)	PE91492	E4	34
Female to Male	(R)	PE91493	A5	34
Female to Male	(R)	PE91155	B5	34
Female to Male	(R)	PE91222	C5	34
Female to Male	90°	PE9068	D5	34
Female to Male	(P) 45°	PE91332	E5	34
Female to Male		PE9247	A6	34
Female to Male	(B)	PE9621	B6	34
Female to Male	(PM)	PE91453	C6	34
Female to Male	(B) (PO)	PE91321	D6	34
Female to Male	(P) 90°	PE91504	E6	34
Female to Male	(QD)	PE91265	A5	35
Female to Male		PE9534	B5	35
Female to Male	90°	PE91264	C5	35
Female to Male		PE9682	E1	36
Female to Male		PE91135	E1	34
Female to Male	(P)	PE9505	A2	34
Female to Male	(R)	PE91496	B2	34
Female to Male	(R)	PE91497	C2	34
Female to Male	90°	PE9418	D2	34
Female to Male		PE9379	E2	34
Female to Male	(P) 90°	PE91151	A3	34
Female to Male	(R) 90°	PE9642	B3	34
Female to Male	(PM)	PE9669	C3	34
Female to Male		PE91535	D3	34
Female to Male		PE91259	E3	35
<b>SMA Male To:</b>				
1.0/2.3 Jack		PE9690	D2	36
1.0/2.3 Plug		PE9692	C2	36
1.85mm Female		PE9728	A3	36
1.85mm Male		PE9727	E2	36
2.4mm Female	(P)	PE9654	C3	36
2.4mm Male	(P)	PE9653	B3	36
2.92mm Female	(P)	PE91008	E3	36
2.92mm Male	(P)	PE91010	D3	36
3.5mm Female		PE91536	B4	36
3.5mm Male		PE9722	A4	36
7/16 DIN Female		PE9411	D4	36
75 Ohm F Female	(P)	PE91003	D5	36
7mm Sexless		PE9215	C4	36
BNC Female		PE9074	B5	36
BNC Female		PE9495	C5	36
BNC Male		PE9072	E4	36
BNC Male		PE9493	A5	36
FME Jack		PE9707	E5	36
Full Detent Mini SMP Male		PE91302	A7	36
Full Detent Mini SMP Male	(P)	PE91052	C7	36
Full Detent SMP Male		PE91309	D4	37
Full Detent SMP Male	(P)	PE91063	B5	37
GR874 Sexless		PE9299	A6	36
HN Female		PE9256	C6	36
HN Male		PE91448	B6	36
Limited Detent SMP Male		PE91310	E4	37
Limited Detent SMP Male	(P)	PE9511	C5	37
MCX Jack		PE9472	E6	36
MCX Plug		PE9473	D6	36
Mini SMP Female		PE91304	D7	36
Mini SMP Female	(P)	PE91103	E7	36
MMCX Jack		PE9478	B1	37
MMCX Plug		PE9476	A1	37
N Female		PE9082	C2	37
N Female	(P)	PE9433	D2	37
N Female	(B) (P)	PE9487	E2	37
N Female	(PM)	PE9105	A3	37
N Female	(P) (PM)	PE9497	B3	37
N Female	(B) (P)	PE9488	C3	37
N Female	(LP)	PE91178	A7	32
N Male		PE9080	E1	37
N Male	(P)	PE9431	A2	37

Feature: (B) Bulkhead Mount / (H) Hermetically Sealed / (I) Isolated Sealed / (LP) Low PIM / (P) Precision / (PM) Panel Mount / (PO) Push On / (QD) Quick Disconnect / (R) Radius Right Angle / (RU) Ruggedized / (SO) Snap-On

# Adapter Locator

Adapters

Connector Type	Feature	Model No.	C/R	Page
N Male	(P) (PM)	PE9499	B2	37
Reverse Polarity MCX Plug		PE9581	A5	40
Reverse Polarity TNC Female		PE9600	B5	40
Slide-On BMA Jack		PE91397	B4	25
Slide-On BMA Plug		PE91396	C3	25
Slide-On BMA Plug	(B)	PE91401	D3	25
SMB Jack		PE9145	A4	37
SMB Plug		PE9144	E3	37
SMC Jack		PE9149	C4	37
SMC Plug		PE9148	B4	37
Smooth Bore Mini SMP Male		PE91303	B7	36
Smooth Bore SMP Male		PE91311	A5	37
SMP Female		PE91312	D5	37
SMP Female	(P)	PE91062	E5	37
SMP Female	(P)	PE9513	A6	37
Snap-On MMBX Jack	(SO)	PE91362	D1	37
Snap-On MMBX Plug	(SO)	PE91360	C1	37
Snap-On QMA Female	(SO)	PE91346	A5	33
SSMA Female		PE9063	C6	37
SSMA Male		PE9187	B6	37
SSMB Jack		PE9401	D6	37
TNC Female		PE9078	B7	37
TNC Female		PE91507	C7	37
TNC Female	(PM)	PE9384	D7	37
TNC Male		PE9076	E6	37
TNC Male		PE9439	A7	37
UHF Female		PE9400	E7	37
UMCX Jack		PE91007	A1	38
<b>SMB In-Series:</b>				
Jack to Jack		PE9116	A2	41
Jack to Jack	(B) (PM)	PE9302	B2	41
Jack to Jack		PE9122	C2	41
Jack to Plug		PE9243	E1	41
Plug to Jack		PE9120	C1	41
Plug to Jack		PE9309	D1	41
Plug to Plug		PE9118	A1	41
Plug to Plug		PE9310	B1	41
<b>SMB Jack To:</b>				
BNC Female	(B)	PE9136	D3	41
BNC Female		PE9240	E3	41
BNC Male		PE9132	C3	41
N Female		PE9315	C7	32
N Male		PE9313	D6	31
SMA Female		PE9143	A5	39
SMA Male		PE9145	A4	37
SMC Jack		PE9283	C7	41
SMC Plug		PE9284	C6	41
<b>SMB Plug To:</b>				
BNC Female	(B) (PM)	PE9137	A3	41
BNC Female		PE9241	B3	41
BNC Male		PE9135	E2	41
N Female		PE9316	B7	32
N Male		PE9314	C6	31
SMA Female		PE9142	E4	39
SMA Male		PE9144	E3	37
SMC Jack		PE9282	B7	41
SMC Plug		PE9281	B6	41
<b>SMC In-Series:</b>				
Jack to Jack	(B) (PM)	PE9304	B5	41
Jack to Jack		PE91403	C5	41
Jack to Plug		PE9242	A5	41
Plug to Jack		PE9119	D4	41
Plug to Jack	90°	PE9303	E4	41
Plug to Plug		PE9117	B4	41
Plug to Plug		PE9305	C4	41
<b>SMC Jack To:</b>				
BNC Female	(B)	PE9140	E6	41
BNC Female		PE9108	A7	41
BNC Male		PE9138	D6	41
N Female		PE9319	E7	32
N Male		PE9317	A7	31
SMA Female		PE9147	C5	39
SMA Male		PE9149	C4	37
SMB Jack		PE9283	C7	41
SMB Plug		PE9282	B7	41
TNC Male		PE9226	A3	44
<b>SMC Plug To:</b>				
BNC Female		PE9141	A6	41
BNC Male		PE9139	E5	41
N Female		PE9320	D7	32
N Male		PE9318	E6	31
SMA Female		PE9146	B5	39
SMA Male		PE9148	B4	37
SMB Jack		PE9284	C6	41
SMB Plug		PE9281	B6	41
<b>Smooth Bore Mini SMP Male To:</b>				
2.92mm Female		PE91128	C1	21
2.92mm Male		PE91125	C5	20
SMA Female		PE91300	C7	38
SMA Male		PE91303	B7	36
<b>Smooth Bore SMP Male To:</b>				
SMA Female	(P)	PE91307	A6	39
SMA Female	(P)	PE91049	B6	39
SMA Female	(P) (PM)	PE91061	E7	39
SMA Male		PE91311	A5	37
<b>SMP Female To:</b>				
2.4mm Female		PE91055	C6	19

Connector Type	Feature	Model No.	C/R	Page
2.92mm Female		PE91060	B2	21
SMA Female		PE91308	C1	40
SMA Female	(P)	PE91064	D1	40
SMA Female	(P)	PE9779	E1	40
SMA Male		PE91312	D5	37
SMA Male	(P)	PE91062	E5	37
SMA Male	(P)	PE9513	A6	37
SMP Female		PE91065	E2	42
SMP Female		PE91065	E2	42
<b>SMP In-Series:</b>				
Female to Female		PE91102	E7	41
Female to Female		PE9776	A1	42
Female to Female		PE91068	B1	42
Female to Female		PE91072	C1	42
Female to Female		PE91099	D1	42
Female to Female		PE91101	E1	42
Female to Female		PE9775	A2	42
Female to Female		PE9777	B2	42
<b>SMP Male To:</b>				
2.4mm Female		PE91048	B6	19
SMA Female	(P) (PM)	PE91057	C7	39
SMA Female	(P) (PM)	PE91059	B1	40
<b>Snap-On MMBX Jack To:</b>				
SMA Female	(SO)	PE91363	E1	39
SMA Male	(SO)	PE91362	D1	37
<b>Snap-On MMBX Plug To:</b>				
Push-On SMP Female	(PO) (SO)	PE91364	D2	42
SMA Female	(SO)	PE91361	D1	39
SMA Male	(SO)	PE91360	C1	37
<b>Snap-On QMA Female To:</b>				
SMA Male	(SO)	PE91346	A5	33
Snap-On SMA Female	(SO)	PE91347	B5	33
<b>Snap-On QMA Male To:</b>				
SMA Female	(SO)	PE91345	E4	33
Snap-On SMA Male	(SO)	PE91344	D4	33
<b>Snap-On SMA Female To:</b>				
Snap-On QMA Female	(SO)	PE91347	B5	33
Snap-On SMA Male	(SO)	PE91344	D4	33
<b>SSMA Female To:</b>				
BNC Male		PE9191	B5	42
N Female		PE9354	D5	42
N Male		PE9352	C5	42
SMA Female		PE9399	B2	40
SMA Male		PE9063	C6	37
<b>SSMA In-Series:</b>				
Female to Female		PE9192	A4	42
Female to Female	(B) (PM)	PE9189	B4	42
Male to Female		PE9358	C3	42
Male to Female	(QD)	PE9685	D3	42
Male to Female	90°	PE9334	E3	42
Male to Male		PE9357	B3	42
<b>SSMA Male To:</b>				
2.92mm Female		PE9768	C2	21
BNC Female		PE91046	E4	42
BNC Male		PE9213	D4	42
N Male		PE9351	A5	42
SMA Female		PE9188	A2	40
SMA Male		PE9187	B6	37
<b>SSMB Jack To:</b>				
BNC Female		PE9394	D6	42
BNC Male		PE9392	C6	42
SMA Male		PE9401	D6	37
<b>SSMB Plug To:</b>				
BNC Female		PE9395	B6	42
BNC Male		PE9393	A6	42
SMA Female		PE9402	C2	40
<b>SSMC In-Series:</b>				
Jack to Jack	(B)	PE91432	C7	42
Plug to Jack		PE91434	B7	42
Plug to Plug		PE91436	A7	42
<b>SSMC Jack To:</b>				
SMA Female		PE91433	E2	40
<b>SSMC Plug To:</b>				
SMA Female		PE91380	D2	40
<b>TNC Female To:</b>				
7/16 DIN Female		PE91392	D3	44
7mm Sexless	(P)	PE9218	C3	44
BNC Female		PE9097	A4	44
BNC Male		PE9098	E3	44
C Male		PE9564	B4	44
FME Jack		PE9714	C4	44
Limited Detent SMP Male	(B)	PE91073	C5	44
MCX Jack		PE9544	E4	44
MCX Jack	(B) (PM)	PE9521	A5	44
MCX Plug		PE9545	D4	44
Mini UHF Male		PE9346	B5	44
N Female		PE9131	D1	33
N Female	(P)	PE9449	E1	33
N Female	(PM)	PE9552	A2	33
N Female	(B)	PE9482	B2	33
N Female	(P) (PM)	PE9450	C2	33
N Male		PE9090	D7	31
N Male	90°	PE9550	E7	31
N Male		PE91537	A1	32
Reverse Polarity SMA Female		PE9599	E6	40
Reverse Polarity SMA Male		PE9596	B6	40

Connector Type	Feature	Model No.	C/R	Page
SMA Female		PE9079	C3	40
SMA Female		PE9442	D3	40
SMA Female	(B) (PM)	PE9251	E3	40
SMA Female	(PM)	PE9276	A4	40
SMA Male		PE9078	B7	37
SMA Male		PE91507	C7	37
SMA Male	(PM)	PE9384	D7	37
UHF Male		PE9372	D5	44
<b>TNC In-Series:</b>				
Female to Female		PE91204	A4	43
Female to Female		PE91241	B4	43
Female to Female		PE9099	C4	43
Female to Female	(LP)	PE91174	D4	43
Female to Female	(P)	PE9444	E4	43
Female to Female		PE91381	A5	43
Female to Female	(B)	PE91430	B5	43
Female to Female	(B)	PE9154	C5	43
Female to Female	(B)	PE91205	D5	43
Female to Female	(B)	PE91242	E5	43
Female to Female	(B)	PE9287	A6	43
Female to Female	(PM)	PE9288	B6	43
Female to Male		PE9195	E3	43
Female to Male		PE9531	E6	43
Male to Female		PE91203	A2	43
Male to Female		PE91240	B2	43
Male to Female	(P)	PE91505	C2	43
Male to Female	(LP)	PE91173	D2	43
Male to Female		PE9270	E2	43
Male to Female	(P)	PE9443	A3	43
Male to Female	(QD)	PE9561	B3	43
Male to Female	90°	PE9100	C3	43
Male to Female		PE9290	D3	43
Male to Female		PE9532	D6	43
Male to Male	(LP)	PE91172	E7	42
Male to Male		PE91202	A1	43
Male to Male		PE91239	B1	43
Male to Male		PE9091	C1	43
Male to Male		PE9445	D1	43
Male to Male	90°	PE9560	E1	43
<b>TNC Male To:</b>				
7/16 DIN Female		PE9638	D7	43
7mm Sexless	(P)	PE9219	C7	43
BNC Female		PE9088	A1	44
BNC Female	90°	PE9783	B1	44
BNC Male		PE91449	E7	43
C Female		PE9562	C1	44
FME Jack		PE9713	A2	44
FME Plug		PE9699	D1	44
FME Plug	90°	PE9700	E1	44
HN Male		PE9563	B2	44
MCX Jack		PE9542	D2	44
MCX Plug		PE9543	C2	44
Mini UHF Female		PE9345	E2	44
N Female		PE9089	A1	33
N Female	(P)	PE91506	B1	33
N Female	90°	PE9263	C1	33
N Male		PE9130	B7	31
N Male	(P)	PE9446	C7	31
Reverse Polarity SMA Female		PE9598	D6	40
Reverse Polarity SMA Male		PE9597	A6	40
SMA Female		PE9077	A3	40
SMA Female		PE9440	B3	40
SMA Male		PE9076	E6	37
SMA Male		PE9439	A7	37
SMC Jack		PE9226	A3	44
UHF Female		PE9291	B3	44
<b>UHF Female To:</b>				
75 Ohm F Female		PE9167	A2	45
BNC Female		PE9421	E1	45
BNC Male		PE91329	D1	45
Mini UHF Male		PE91447	B2	45
N Female		PE9385	E2	33
N Male		PE9111	C1	32
SMA Male		PE9400	E7	37
TNC Male		PE9291	B3	44
<b>UHF In-Series:</b>				
Female to Female		PE9094	A7	44
Female to Female	(B) (PM)	PE9114	B7	44
Female to Male		PE9095	E6	44
Male to Female	90°	PE9209	D6	44
Male to Male		PE91487	C6	44
<b>UHF Male To:</b>				
75 Ohm F Female		PE9165	A1	45
BNC Female		PE91328	E7	44
BNC Male		PE9201	D7	44
FME Plug		PE9701	B1	45
Mini UHF Female		PE9348	C1	45
N Female		PE9112	D2	33
N Male		PE9113	B1	32
SMA Female		PE9415	B4	40
TNC Female		PE9372	D5	44
<b>UMCX Jack To:</b>				
SMA Female		PE91006	D4	40
SMA Male		PE91007	A1	38
<b>UMCX Plug To:</b>				
SMA Female		PE91005	C4	40

Feature: (B) Bulkhead Mount / (H) Hermetically Sealed / (I) Isolated Sealed / (LP) Low PIM / (P) Precision / (PM) Panel Mount / (PO) Push On / (QD) Quick Disconnect / (R) Radius Right Angle / (RU) Ruggedized / (SO) Snap-On



Technical Support  
+1 (949) 261-1920



Same-Day Shipping,  
Even Custom  
Cable Assemblies

































# LOW PIM ADAPTERS

See Adapter Locator on Pages 10-15

See Page 409 for Mounting Holes

Adapters

























See Our Website For Current Pricing & Real-Time Stock Availability!

	A	B	C	D	E																																																																											
1	<p><b>4.1/9.5 Mini DIN Between Series</b></p>  <table border="1"> <thead> <tr> <th colspan="3">PRICE</th> </tr> </thead> <tbody> <tr> <td>1-24</td> <td></td> <td>\$65.02</td> </tr> <tr> <td>25-49</td> <td></td> <td>\$61.77</td> </tr> <tr> <td>50-99</td> <td></td> <td>\$58.52</td> </tr> <tr> <td>100+</td> <td></td> <td>\$55.92</td> </tr> </tbody> </table> <p>Low PIM</p> <p>4.1/9.5 Mini DIN Male to N Male</p> <p>VSWR 1.25:1 to 6 GHz</p> <p>Model No: <a href="#">PE91092</a></p>	PRICE			1-24		\$65.02	25-49		\$61.77	50-99		\$58.52	100+		\$55.92	 <table border="1"> <thead> <tr> <th colspan="3">PRICE</th> </tr> </thead> <tbody> <tr> <td>1-24</td> <td></td> <td>\$63.25</td> </tr> <tr> <td>25-49</td> <td></td> <td>\$60.09</td> </tr> <tr> <td>50-99</td> <td></td> <td>\$56.93</td> </tr> <tr> <td>100+</td> <td></td> <td>\$54.40</td> </tr> </tbody> </table> <p>Low PIM</p> <p>4.1/9.5 Mini DIN Male to N Female</p> <p>VSWR 1.25:1 to 6 GHz</p> <p>Model No: <a href="#">PE91093</a></p>	PRICE			1-24		\$63.25	25-49		\$60.09	50-99		\$56.93	100+		\$54.40	 <table border="1"> <thead> <tr> <th colspan="3">PRICE</th> </tr> </thead> <tbody> <tr> <td>1-24</td> <td></td> <td>\$65.02</td> </tr> <tr> <td>25-49</td> <td></td> <td>\$61.77</td> </tr> <tr> <td>50-99</td> <td></td> <td>\$58.52</td> </tr> <tr> <td>100+</td> <td></td> <td>\$55.92</td> </tr> </tbody> </table> <p>Low PIM</p> <p>4.1/9.5 Mini DIN Female to N Male</p> <p>VSWR 1.25:1 to 6 GHz</p> <p>Model No: <a href="#">PE91094</a></p>	PRICE			1-24		\$65.02	25-49		\$61.77	50-99		\$58.52	100+		\$55.92	 <table border="1"> <thead> <tr> <th colspan="3">PRICE</th> </tr> </thead> <tbody> <tr> <td>1-24</td> <td></td> <td>\$65.02</td> </tr> <tr> <td>25-49</td> <td></td> <td>\$61.77</td> </tr> <tr> <td>50-99</td> <td></td> <td>\$58.52</td> </tr> <tr> <td>100+</td> <td></td> <td>\$55.92</td> </tr> </tbody> </table> <p>Low PIM</p> <p>4.1/9.5 Mini DIN Female to N Female</p> <p>VSWR 1.25:1 to 6 GHz</p> <p>Model No: <a href="#">PE91095</a></p>	PRICE			1-24		\$65.02	25-49		\$61.77	50-99		\$58.52	100+		\$55.92																
PRICE																																																																																
1-24		\$65.02																																																																														
25-49		\$61.77																																																																														
50-99		\$58.52																																																																														
100+		\$55.92																																																																														
PRICE																																																																																
1-24		\$63.25																																																																														
25-49		\$60.09																																																																														
50-99		\$56.93																																																																														
100+		\$54.40																																																																														
PRICE																																																																																
1-24		\$65.02																																																																														
25-49		\$61.77																																																																														
50-99		\$58.52																																																																														
100+		\$55.92																																																																														
PRICE																																																																																
1-24		\$65.02																																																																														
25-49		\$61.77																																																																														
50-99		\$58.52																																																																														
100+		\$55.92																																																																														
2	<p><b>4.3 Non Constant In-Series</b></p>  <table border="1"> <thead> <tr> <th colspan="3">PRICE</th> </tr> </thead> <tbody> <tr> <td>1-24</td> <td></td> <td>\$39.02</td> </tr> <tr> <td>25-49</td> <td></td> <td>\$37.07</td> </tr> <tr> <td>50-99</td> <td></td> <td>\$35.12</td> </tr> <tr> <td>100+</td> <td></td> <td>\$33.56</td> </tr> </tbody> </table> <p>Low PIM</p> <p>4.3-10 Male to 4.3-10 Male</p> <p>VSWR 1.25:1 to 6 GHz</p> <p>Model No: <a href="#">PE91466</a></p>	PRICE			1-24		\$39.02	25-49		\$37.07	50-99		\$35.12	100+		\$33.56	 <table border="1"> <thead> <tr> <th colspan="3">PRICE</th> </tr> </thead> <tbody> <tr> <td>1-24</td> <td></td> <td>\$88.05</td> </tr> <tr> <td>25-49</td> <td></td> <td>\$83.65</td> </tr> <tr> <td>50-99</td> <td></td> <td>\$79.25</td> </tr> <tr> <td>100+</td> <td></td> <td>\$75.72</td> </tr> </tbody> </table> <p>Low PIM</p> <p>4.3-10 Male to 4.3-10 Male</p> <p>VSWR 1.08:1 to 6 GHz</p> <p>Model No: <a href="#">PE91385</a></p>	PRICE			1-24		\$88.05	25-49		\$83.65	50-99		\$79.25	100+		\$75.72	 <table border="1"> <thead> <tr> <th colspan="3">PRICE</th> </tr> </thead> <tbody> <tr> <td>1-24</td> <td></td> <td>\$44.10</td> </tr> <tr> <td>25-49</td> <td></td> <td>\$41.90</td> </tr> <tr> <td>50-99</td> <td></td> <td>\$39.69</td> </tr> <tr> <td>100+</td> <td></td> <td>\$37.93</td> </tr> </tbody> </table> <p>Low PIM</p> <p>4.3-10 Male to 4.3-10 Female</p> <p>VSWR 1.25:1 to 6 GHz</p> <p>Model No: <a href="#">PE91465</a></p>	PRICE			1-24		\$44.10	25-49		\$41.90	50-99		\$39.69	100+		\$37.93	 <table border="1"> <thead> <tr> <th colspan="3">PRICE</th> </tr> </thead> <tbody> <tr> <td>1-24</td> <td></td> <td>\$88.05</td> </tr> <tr> <td>25-49</td> <td></td> <td>\$83.65</td> </tr> <tr> <td>50-99</td> <td></td> <td>\$79.25</td> </tr> <tr> <td>100+</td> <td></td> <td>\$75.72</td> </tr> </tbody> </table> <p>Low PIM</p> <p>4.3-10 Male to 4.3-10 Female Right Angle</p> <p>VSWR 1.2:1 to 3 GHz</p> <p>Model No: <a href="#">PE91467</a></p>	PRICE			1-24		\$88.05	25-49		\$83.65	50-99		\$79.25	100+		\$75.72																
PRICE																																																																																
1-24		\$39.02																																																																														
25-49		\$37.07																																																																														
50-99		\$35.12																																																																														
100+		\$33.56																																																																														
PRICE																																																																																
1-24		\$88.05																																																																														
25-49		\$83.65																																																																														
50-99		\$79.25																																																																														
100+		\$75.72																																																																														
PRICE																																																																																
1-24		\$44.10																																																																														
25-49		\$41.90																																																																														
50-99		\$39.69																																																																														
100+		\$37.93																																																																														
PRICE																																																																																
1-24		\$88.05																																																																														
25-49		\$83.65																																																																														
50-99		\$79.25																																																																														
100+		\$75.72																																																																														
3	 <table border="1"> <thead> <tr> <th colspan="3">PRICE</th> </tr> </thead> <tbody> <tr> <td>1-24</td> <td></td> <td>\$89.17</td> </tr> <tr> <td>25-49</td> <td></td> <td>\$85.60</td> </tr> <tr> <td>50-99</td> <td></td> <td>\$82.93</td> </tr> <tr> <td>100+</td> <td></td> <td>\$81.14</td> </tr> </tbody> </table> <p>Low PIM</p> <p>4.3-10 Male to 4.3-10 Female</p> <p>VSWR 1.08:1 to 6 GHz</p> <p>Model No: <a href="#">PE91387</a></p>	PRICE			1-24		\$89.17	25-49		\$85.60	50-99		\$82.93	100+		\$81.14	 <table border="1"> <thead> <tr> <th colspan="3">PRICE</th> </tr> </thead> <tbody> <tr> <td>1-24</td> <td></td> <td>\$44.10</td> </tr> <tr> <td>25-49</td> <td></td> <td>\$41.90</td> </tr> <tr> <td>50-99</td> <td></td> <td>\$39.69</td> </tr> <tr> <td>100+</td> <td></td> <td>\$37.93</td> </tr> </tbody> </table> <p>Low PIM</p> <p>4.3-10 Female to 4.3-10 Female</p> <p>VSWR 1.25:1 to 6 GHz</p> <p>Model No: <a href="#">PE91464</a></p>	PRICE			1-24		\$44.10	25-49		\$41.90	50-99		\$39.69	100+		\$37.93	 <table border="1"> <thead> <tr> <th colspan="3">PRICE</th> </tr> </thead> <tbody> <tr> <td>1-24</td> <td></td> <td>\$90.97</td> </tr> <tr> <td>25-49</td> <td></td> <td>\$86.42</td> </tr> <tr> <td>50-99</td> <td></td> <td>\$81.87</td> </tr> <tr> <td>100+</td> <td></td> <td>\$78.23</td> </tr> </tbody> </table> <p>Low PIM</p> <p>4.3-10 Female to 4.3-10 Female</p> <p>VSWR 1.08:1 to 6 GHz</p> <p>Model No: <a href="#">PE91386</a></p>	PRICE			1-24		\$90.97	25-49		\$86.42	50-99		\$81.87	100+		\$78.23	<p><b>4.3 Non Constant Between Series</b></p>  <table border="1"> <thead> <tr> <th colspan="3">PRICE</th> </tr> </thead> <tbody> <tr> <td>1-24</td> <td></td> <td>\$39.02</td> </tr> <tr> <td>25-49</td> <td></td> <td>\$37.07</td> </tr> <tr> <td>50-99</td> <td></td> <td>\$35.12</td> </tr> <tr> <td>100+</td> <td></td> <td>\$33.56</td> </tr> </tbody> </table> <p>Low PIM</p> <p>4.3-10 Male to N Male</p> <p>VSWR 1.25:1 to 6 GHz</p> <p>Model No: <a href="#">PE91476</a></p>	PRICE			1-24		\$39.02	25-49		\$37.07	50-99		\$35.12	100+		\$33.56																
PRICE																																																																																
1-24		\$89.17																																																																														
25-49		\$85.60																																																																														
50-99		\$82.93																																																																														
100+		\$81.14																																																																														
PRICE																																																																																
1-24		\$44.10																																																																														
25-49		\$41.90																																																																														
50-99		\$39.69																																																																														
100+		\$37.93																																																																														
PRICE																																																																																
1-24		\$90.97																																																																														
25-49		\$86.42																																																																														
50-99		\$81.87																																																																														
100+		\$78.23																																																																														
PRICE																																																																																
1-24		\$39.02																																																																														
25-49		\$37.07																																																																														
50-99		\$35.12																																																																														
100+		\$33.56																																																																														
4	 <table border="1"> <thead> <tr> <th colspan="3">PRICE</th> </tr> </thead> <tbody> <tr> <td>1-24</td> <td></td> <td>\$53.33</td> </tr> <tr> <td>25-49</td> <td></td> <td>\$50.66</td> </tr> <tr> <td>50-99</td> <td></td> <td>\$48.00</td> </tr> <tr> <td>100+</td> <td></td> <td>\$45.86</td> </tr> </tbody> </table> <p>Low PIM</p> <p>QD 4.3-10 Male to N Male</p> <p>VSWR 1.25:1 to 6 GHz</p> <p>Model No: <a href="#">PE91480</a></p>	PRICE			1-24		\$53.33	25-49		\$50.66	50-99		\$48.00	100+		\$45.86	 <table border="1"> <thead> <tr> <th colspan="3">PRICE</th> </tr> </thead> <tbody> <tr> <td>1-24</td> <td></td> <td>\$39.02</td> </tr> <tr> <td>25-49</td> <td></td> <td>\$37.07</td> </tr> <tr> <td>50-99</td> <td></td> <td>\$35.12</td> </tr> <tr> <td>100+</td> <td></td> <td>\$33.56</td> </tr> </tbody> </table> <p>Low PIM</p> <p>4.3-10 Male to N Female</p> <p>VSWR 1.25:1 to 6 GHz</p> <p>Model No: <a href="#">PE91474</a></p>	PRICE			1-24		\$39.02	25-49		\$37.07	50-99		\$35.12	100+		\$33.56	 <table border="1"> <thead> <tr> <th colspan="3">PRICE</th> </tr> </thead> <tbody> <tr> <td>1-24</td> <td></td> <td>\$39.02</td> </tr> <tr> <td>25-49</td> <td></td> <td>\$37.07</td> </tr> <tr> <td>50-99</td> <td></td> <td>\$35.12</td> </tr> <tr> <td>100+</td> <td></td> <td>\$33.56</td> </tr> </tbody> </table> <p>Low PIM</p> <p>4.3-10 Male to N Female</p> <p>VSWR 1.25:1 to 6 GHz</p> <p>Model No: <a href="#">PE91477</a></p>	PRICE			1-24		\$39.02	25-49		\$37.07	50-99		\$35.12	100+		\$33.56	 <table border="1"> <thead> <tr> <th colspan="3">PRICE</th> </tr> </thead> <tbody> <tr> <td>1-24</td> <td></td> <td>\$51.32</td> </tr> <tr> <td>25-49</td> <td></td> <td>\$48.75</td> </tr> <tr> <td>50-99</td> <td></td> <td>\$46.19</td> </tr> <tr> <td>100+</td> <td></td> <td>\$44.14</td> </tr> </tbody> </table> <p>Low PIM</p> <p>QD 4.3-10 Male to N Female</p> <p>VSWR 1.25:1 to 6 GHz</p> <p>Model No: <a href="#">PE91478</a></p>	PRICE			1-24		\$51.32	25-49		\$48.75	50-99		\$46.19	100+		\$44.14	 <table border="1"> <thead> <tr> <th colspan="3">PRICE</th> </tr> </thead> <tbody> <tr> <td>1-24</td> <td></td> <td>\$62.14</td> </tr> <tr> <td>25-49</td> <td></td> <td>\$59.03</td> </tr> <tr> <td>50-99</td> <td></td> <td>\$55.93</td> </tr> <tr> <td>100+</td> <td></td> <td>\$53.44</td> </tr> </tbody> </table> <p>Low PIM</p> <p>4.3-10 Male to N Female Right Angle</p> <p>VSWR 1.25:1 to 6 GHz</p> <p>Model No: <a href="#">PE91483</a></p>	PRICE			1-24		\$62.14	25-49		\$59.03	50-99		\$55.93	100+		\$53.44
PRICE																																																																																
1-24		\$53.33																																																																														
25-49		\$50.66																																																																														
50-99		\$48.00																																																																														
100+		\$45.86																																																																														
PRICE																																																																																
1-24		\$39.02																																																																														
25-49		\$37.07																																																																														
50-99		\$35.12																																																																														
100+		\$33.56																																																																														
PRICE																																																																																
1-24		\$39.02																																																																														
25-49		\$37.07																																																																														
50-99		\$35.12																																																																														
100+		\$33.56																																																																														
PRICE																																																																																
1-24		\$51.32																																																																														
25-49		\$48.75																																																																														
50-99		\$46.19																																																																														
100+		\$44.14																																																																														
PRICE																																																																																
1-24		\$62.14																																																																														
25-49		\$59.03																																																																														
50-99		\$55.93																																																																														
100+		\$53.44																																																																														
5	 <table border="1"> <thead> <tr> <th colspan="3">PRICE</th> </tr> </thead> <tbody> <tr> <td>1-24</td> <td></td> <td>\$92.71</td> </tr> <tr> <td>25-49</td> <td></td> <td>\$88.07</td> </tr> <tr> <td>50-99</td> <td></td> <td>\$83.44</td> </tr> <tr> <td>100+</td> <td></td> <td>\$79.73</td> </tr> </tbody> </table> <p>Low PIM</p> <p>4.3-10 Male to N Female</p> <p>VSWR 1.08:1 to 6 GHz</p> <p>Model No: <a href="#">PE91389</a></p>	PRICE			1-24		\$92.71	25-49		\$88.07	50-99		\$83.44	100+		\$79.73	 <table border="1"> <thead> <tr> <th colspan="3">PRICE</th> </tr> </thead> <tbody> <tr> <td>1-24</td> <td></td> <td>\$35.29</td> </tr> <tr> <td>25-49</td> <td></td> <td>\$33.53</td> </tr> <tr> <td>50-99</td> <td></td> <td>\$31.76</td> </tr> <tr> <td>100+</td> <td></td> <td>\$30.35</td> </tr> </tbody> </table> <p>Low PIM</p> <p>4.3-10 Male to SMA Female</p> <p>VSWR 1.15:1 to 6 GHz</p> <p>Model No: <a href="#">PE91484</a></p>	PRICE			1-24		\$35.29	25-49		\$33.53	50-99		\$31.76	100+		\$30.35	 <table border="1"> <thead> <tr> <th colspan="3">PRICE</th> </tr> </thead> <tbody> <tr> <td>1-24</td> <td></td> <td>\$45.86</td> </tr> <tr> <td>25-49</td> <td></td> <td>\$43.57</td> </tr> <tr> <td>50-99</td> <td></td> <td>\$41.27</td> </tr> <tr> <td>100+</td> <td></td> <td>\$39.44</td> </tr> </tbody> </table> <p>Low PIM</p> <p>4.3-10 Female to N Male</p> <p>VSWR 1.25:1 to 6 GHz</p> <p>Model No: <a href="#">PE91479</a></p>	PRICE			1-24		\$45.86	25-49		\$43.57	50-99		\$41.27	100+		\$39.44	 <table border="1"> <thead> <tr> <th colspan="3">PRICE</th> </tr> </thead> <tbody> <tr> <td>1-24</td> <td></td> <td>\$43.25</td> </tr> <tr> <td>25-49</td> <td></td> <td>\$41.09</td> </tr> <tr> <td>50-99</td> <td></td> <td>\$38.93</td> </tr> <tr> <td>100+</td> <td></td> <td>\$37.20</td> </tr> </tbody> </table> <p>Low PIM</p> <p>QD 4.3-10 Female to N Male</p> <p>VSWR 1.25:1 to 6 GHz</p> <p>Model No: <a href="#">PE91481</a></p>	PRICE			1-24		\$43.25	25-49		\$41.09	50-99		\$38.93	100+		\$37.20	 <table border="1"> <thead> <tr> <th colspan="3">PRICE</th> </tr> </thead> <tbody> <tr> <td>1-24</td> <td></td> <td>\$39.87</td> </tr> <tr> <td>25-49</td> <td></td> <td>\$37.88</td> </tr> <tr> <td>50-99</td> <td></td> <td>\$35.88</td> </tr> <tr> <td>100+</td> <td></td> <td>\$34.29</td> </tr> </tbody> </table> <p>Low PIM</p> <p>4.3-10 Female to N Female</p> <p>VSWR 1.25:1 to 6 GHz</p> <p>Model No: <a href="#">PE91475</a></p>	PRICE			1-24		\$39.87	25-49		\$37.88	50-99		\$35.88	100+		\$34.29
PRICE																																																																																
1-24		\$92.71																																																																														
25-49		\$88.07																																																																														
50-99		\$83.44																																																																														
100+		\$79.73																																																																														
PRICE																																																																																
1-24		\$35.29																																																																														
25-49		\$33.53																																																																														
50-99		\$31.76																																																																														
100+		\$30.35																																																																														
PRICE																																																																																
1-24		\$45.86																																																																														
25-49		\$43.57																																																																														
50-99		\$41.27																																																																														
100+		\$39.44																																																																														
PRICE																																																																																
1-24		\$43.25																																																																														
25-49		\$41.09																																																																														
50-99		\$38.93																																																																														
100+		\$37.20																																																																														
PRICE																																																																																
1-24		\$39.87																																																																														
25-49		\$37.88																																																																														
50-99		\$35.88																																																																														
100+		\$34.29																																																																														
6	 <table border="1"> <thead> <tr> <th colspan="3">PRICE</th> </tr> </thead> <tbody> <tr> <td>1-24</td> <td></td> <td>\$43.02</td> </tr> <tr> <td>25-49</td> <td></td> <td>\$40.87</td> </tr> <tr> <td>50-99</td> <td></td> <td>\$38.72</td> </tr> <tr> <td>100+</td> <td></td> <td>\$37.00</td> </tr> </tbody> </table> <p>Low PIM</p> <p>QD 4.3-10 Female to N Female</p> <p>VSWR 1.25:1 to 6 GHz</p> <p>Model No: <a href="#">PE91482</a></p>	PRICE			1-24		\$43.02	25-49		\$40.87	50-99		\$38.72	100+		\$37.00	<p><b>7/16 DIN In-Series</b></p>  <table border="1"> <thead> <tr> <th colspan="3">PRICE</th> </tr> </thead> <tbody> <tr> <td>1-9</td> <td></td> <td>\$123.52</td> </tr> <tr> <td>10-24</td> <td></td> <td>\$117.34</td> </tr> <tr> <td>25-49</td> <td></td> <td>\$111.17</td> </tr> <tr> <td>50+</td> <td></td> <td>\$106.23</td> </tr> </tbody> </table> <p>Low PIM</p> <p>7/16 DIN Male to 7/16 DIN Male</p> <p>Max. Freq. 8 GHz</p> <p>Model No: <a href="#">PE91039</a></p>	PRICE			1-9		\$123.52	10-24		\$117.34	25-49		\$111.17	50+		\$106.23	 <table border="1"> <thead> <tr> <th colspan="3">PRICE</th> </tr> </thead> <tbody> <tr> <td>1-9</td> <td></td> <td>\$117.66</td> </tr> <tr> <td>10-24</td> <td></td> <td>\$111.78</td> </tr> <tr> <td>25-49</td> <td></td> <td>\$105.89</td> </tr> <tr> <td>50+</td> <td></td> <td>\$101.19</td> </tr> </tbody> </table> <p>Low PIM</p> <p>7/16 DIN Male to 7/16 DIN Female</p> <p>Max. Freq. 8 GHz</p> <p>Model No: <a href="#">PE91028</a></p>	PRICE			1-9		\$117.66	10-24		\$111.78	25-49		\$105.89	50+		\$101.19	 <table border="1"> <thead> <tr> <th colspan="3">PRICE</th> </tr> </thead> <tbody> <tr> <td>1-9</td> <td></td> <td>\$117.66</td> </tr> <tr> <td>10-24</td> <td></td> <td>\$111.78</td> </tr> <tr> <td>25-49</td> <td></td> <td>\$105.89</td> </tr> <tr> <td>50+</td> <td></td> <td>\$101.19</td> </tr> </tbody> </table> <p>Low PIM</p> <p>7/16 DIN Female to 7/16 DIN Female</p> <p>Max. Freq. 8 GHz</p> <p>Model No: <a href="#">PE91029</a></p>	PRICE			1-9		\$117.66	10-24		\$111.78	25-49		\$105.89	50+		\$101.19																
PRICE																																																																																
1-24		\$43.02																																																																														
25-49		\$40.87																																																																														
50-99		\$38.72																																																																														
100+		\$37.00																																																																														
PRICE																																																																																
1-9		\$123.52																																																																														
10-24		\$117.34																																																																														
25-49		\$111.17																																																																														
50+		\$106.23																																																																														
PRICE																																																																																
1-9		\$117.66																																																																														
10-24		\$111.78																																																																														
25-49		\$105.89																																																																														
50+		\$101.19																																																																														
PRICE																																																																																
1-9		\$117.66																																																																														
10-24		\$111.78																																																																														
25-49		\$105.89																																																																														
50+		\$101.19																																																																														
7	 <table border="1"> <thead> <tr> <th colspan="3">PRICE</th> </tr> </thead> <tbody> <tr> <td>1-9</td> <td></td> <td>\$154.56</td> </tr> <tr> <td>10-24</td> <td></td> <td>\$146.83</td> </tr> <tr> <td>25-49</td> <td></td> <td>\$139.10</td> </tr> <tr> <td>50+</td> <td></td> <td>\$132.92</td> </tr> </tbody> </table> <p>Low PIM</p> <p>7/16 DIN Female to 7/16 DIN Female Bulkhead</p> <p>Max. Freq. 8 GHz</p> <p>Model No: <a href="#">PE91038</a></p>	PRICE			1-9		\$154.56	10-24		\$146.83	25-49		\$139.10	50+		\$132.92	<p><b>7/16 DIN Between Series</b></p>  <table border="1"> <thead> <tr> <th colspan="3">PRICE</th> </tr> </thead> <tbody> <tr> <td>1-24</td> <td></td> <td>\$85.09</td> </tr> <tr> <td>25-49</td> <td></td> <td>\$80.84</td> </tr> <tr> <td>50-99</td> <td></td> <td>\$76.58</td> </tr> <tr> <td>100+</td> <td></td> <td>\$73.18</td> </tr> </tbody> </table> <p>Low PIM</p> <p>7/16 DIN Male to 4.1/9.5 Mini DIN Male</p> <p>VSWR 1.25:1 to 6 GHz</p> <p>Model No: <a href="#">PE91088</a></p>	PRICE			1-24		\$85.09	25-49		\$80.84	50-99		\$76.58	100+		\$73.18	 <table border="1"> <thead> <tr> <th colspan="3">PRICE</th> </tr> </thead> <tbody> <tr> <td>1-24</td> <td></td> <td>\$40.72</td> </tr> <tr> <td>25-49</td> <td></td> <td>\$38.68</td> </tr> <tr> <td>50-99</td> <td></td> <td>\$36.65</td> </tr> <tr> <td>100+</td> <td></td> <td>\$35.02</td> </tr> </tbody> </table> <p>Low PIM</p> <p>7/16 DIN Male to 4.3-10 Male</p> <p>VSWR 1.25:1 to 6 GHz</p> <p>Model No: <a href="#">PE91468</a></p>	PRICE			1-24		\$40.72	25-49		\$38.68	50-99		\$36.65	100+		\$35.02	 <table border="1"> <thead> <tr> <th colspan="3">PRICE</th> </tr> </thead> <tbody> <tr> <td>1-24</td> <td></td> <td>\$44.10</td> </tr> <tr> <td>25-49</td> <td></td> <td>\$41.90</td> </tr> <tr> <td>50-99</td> <td></td> <td>\$39.69</td> </tr> <tr> <td>100+</td> <td></td> <td>\$37.93</td> </tr> </tbody> </table> <p>Low PIM</p> <p>7/16 DIN Male to 4.3-10 Female</p> <p>VSWR 1.25:1 to 6 GHz</p> <p>Model No: <a href="#">PE91469</a></p>	PRICE			1-24		\$44.10	25-49		\$41.90	50-99		\$39.69	100+		\$37.93																
PRICE																																																																																
1-9		\$154.56																																																																														
10-24		\$146.83																																																																														
25-49		\$139.10																																																																														
50+		\$132.92																																																																														
PRICE																																																																																
1-24		\$85.09																																																																														
25-49		\$80.84																																																																														
50-99		\$76.58																																																																														
100+		\$73.18																																																																														
PRICE																																																																																
1-24		\$40.72																																																																														
25-49		\$38.68																																																																														
50-99		\$36.65																																																																														
100+		\$35.02																																																																														
PRICE																																																																																
1-24		\$44.10																																																																														
25-49		\$41.90																																																																														
50-99		\$39.69																																																																														
100+		\$37.93																																																																														

# LOW PIM ADAPTERS

See Adapter Locator on Pages 10-15

See Page 409 for Mounting Holes

	A	B	C	D	E																																													
1	 <table border="1"> <thead> <tr><th>PRICE</th></tr> </thead> <tbody> <tr><td>1-24</td><td>\$76.11</td></tr> <tr><td>25-49</td><td>\$72.30</td></tr> <tr><td>50-99</td><td>\$68.50</td></tr> <tr><td>100+</td><td>\$65.45</td></tr> </tbody> </table> <p>Low PIM</p> <p>7/16 DIN Male to 4.3-10 Female</p> <p>VSWR 1.08:1 to 6 GHz</p> <p>Model No: <a href="#">PE91390</a></p>	PRICE	1-24	\$76.11	25-49	\$72.30	50-99	\$68.50	100+	\$65.45	 <table border="1"> <thead> <tr><th>PRICE</th></tr> </thead> <tbody> <tr><td>1-24</td><td>\$85.09</td></tr> <tr><td>25-49</td><td>\$80.84</td></tr> <tr><td>50-99</td><td>\$76.58</td></tr> <tr><td>100+</td><td>\$73.18</td></tr> </tbody> </table> <p>Low PIM</p> <p>7/16 DIN Female to 4.1/9.5 Mini DIN Male</p> <p>VSWR 1.25:1 to 6 GHz</p> <p>Model No: <a href="#">PE91090</a></p>	PRICE	1-24	\$85.09	25-49	\$80.84	50-99	\$76.58	100+	\$73.18	 <table border="1"> <thead> <tr><th>PRICE</th></tr> </thead> <tbody> <tr><td>1-24</td><td>\$85.09</td></tr> <tr><td>25-49</td><td>\$80.84</td></tr> <tr><td>50-99</td><td>\$76.58</td></tr> <tr><td>100+</td><td>\$73.18</td></tr> </tbody> </table> <p>Low PIM</p> <p>7/16 DIN Female to 4.1/9.5 Mini DIN Female</p> <p>VSWR 1.25:1 to 6 GHz</p> <p>Model No: <a href="#">PE91091</a></p>	PRICE	1-24	\$85.09	25-49	\$80.84	50-99	\$76.58	100+	\$73.18	 <table border="1"> <thead> <tr><th>PRICE</th></tr> </thead> <tbody> <tr><td>1-24</td><td>\$43.25</td></tr> <tr><td>25-49</td><td>\$41.09</td></tr> <tr><td>50-99</td><td>\$38.93</td></tr> <tr><td>100+</td><td>\$37.20</td></tr> </tbody> </table> <p>Low PIM</p> <p>7/16 DIN Female to 4.3-10 Male</p> <p>VSWR 1.2:1 to 6 GHz</p> <p>Model No: <a href="#">PE91470</a></p>	PRICE	1-24	\$43.25	25-49	\$41.09	50-99	\$38.93	100+	\$37.20	 <table border="1"> <thead> <tr><th>PRICE</th></tr> </thead> <tbody> <tr><td>1-24</td><td>\$59.55</td></tr> <tr><td>25-49</td><td>\$56.57</td></tr> <tr><td>50-99</td><td>\$53.60</td></tr> <tr><td>100+</td><td>\$51.21</td></tr> </tbody> </table> <p>Low PIM</p> <p>7/16 DIN Female to QD 4.3-10 Male</p> <p>VSWR 1.2:1 to 6 GHz</p> <p>Model No: <a href="#">PE91472</a></p>	PRICE	1-24	\$59.55	25-49	\$56.57	50-99	\$53.60	100+	\$51.21
	PRICE																																																	
1-24	\$76.11																																																	
25-49	\$72.30																																																	
50-99	\$68.50																																																	
100+	\$65.45																																																	
PRICE																																																		
1-24	\$85.09																																																	
25-49	\$80.84																																																	
50-99	\$76.58																																																	
100+	\$73.18																																																	
PRICE																																																		
1-24	\$85.09																																																	
25-49	\$80.84																																																	
50-99	\$76.58																																																	
100+	\$73.18																																																	
PRICE																																																		
1-24	\$43.25																																																	
25-49	\$41.09																																																	
50-99	\$38.93																																																	
100+	\$37.20																																																	
PRICE																																																		
1-24	\$59.55																																																	
25-49	\$56.57																																																	
50-99	\$53.60																																																	
100+	\$51.21																																																	
2	 <table border="1"> <thead> <tr><th>PRICE</th></tr> </thead> <tbody> <tr><td>1-9</td><td>\$121.83</td></tr> <tr><td>10-24</td><td>\$115.74</td></tr> <tr><td>25-49</td><td>\$109.65</td></tr> <tr><td>50+</td><td>\$104.77</td></tr> </tbody> </table> <p>Low PIM</p> <p>7/16 DIN Female to 4.3-10 Male</p> <p>VSWR 1.08:1 to 6 GHz</p> <p>Model No: <a href="#">PE91391</a></p>	PRICE	1-9	\$121.83	10-24	\$115.74	25-49	\$109.65	50+	\$104.77	 <table border="1"> <thead> <tr><th>PRICE</th></tr> </thead> <tbody> <tr><td>1-24</td><td>\$44.10</td></tr> <tr><td>25-49</td><td>\$41.90</td></tr> <tr><td>50-99</td><td>\$39.69</td></tr> <tr><td>100+</td><td>\$37.93</td></tr> </tbody> </table> <p>Low PIM</p> <p>7/16 DIN Female to 4.3-10 Female</p> <p>VSWR 1.25:1 to 6 GHz</p> <p>Model No: <a href="#">PE91471</a></p>	PRICE	1-24	\$44.10	25-49	\$41.90	50-99	\$39.69	100+	\$37.93	 <table border="1"> <thead> <tr><th>PRICE</th></tr> </thead> <tbody> <tr><td>1-24</td><td>\$44.18</td></tr> <tr><td>25-49</td><td>\$41.97</td></tr> <tr><td>50-99</td><td>\$39.76</td></tr> <tr><td>100+</td><td>\$37.99</td></tr> </tbody> </table> <p>Low PIM</p> <p>7/16 DIN Female to QD 4.3-10 Female</p> <p>VSWR 1.2:1 to 6 GHz</p> <p>Model No: <a href="#">PE91473</a></p>	PRICE	1-24	\$44.18	25-49	\$41.97	50-99	\$39.76	100+	\$37.99	<p><b>N</b></p> <p><i>In-Series</i></p> <p>→</p>		 <table border="1"> <thead> <tr><th>PRICE</th></tr> </thead> <tbody> <tr><td>1-24</td><td>\$103.84</td></tr> <tr><td>25-49</td><td>\$98.65</td></tr> <tr><td>50-99</td><td>\$93.46</td></tr> <tr><td>100+</td><td>\$89.30</td></tr> </tbody> </table> <p>Low PIM</p> <p>N Male to N Male</p> <p>Max. Freq. 12.4 GHz</p> <p>Model No: <a href="#">PE91034</a></p>	PRICE	1-24	\$103.84	25-49	\$98.65	50-99	\$93.46	100+	\$89.30								
	PRICE																																																	
1-9	\$121.83																																																	
10-24	\$115.74																																																	
25-49	\$109.65																																																	
50+	\$104.77																																																	
PRICE																																																		
1-24	\$44.10																																																	
25-49	\$41.90																																																	
50-99	\$39.69																																																	
100+	\$37.93																																																	
PRICE																																																		
1-24	\$44.18																																																	
25-49	\$41.97																																																	
50-99	\$39.76																																																	
100+	\$37.99																																																	
PRICE																																																		
1-24	\$103.84																																																	
25-49	\$98.65																																																	
50-99	\$93.46																																																	
100+	\$89.30																																																	
3	 <table border="1"> <thead> <tr><th>PRICE</th></tr> </thead> <tbody> <tr><td>1-24</td><td>\$106.63</td></tr> <tr><td>25-49</td><td>\$101.30</td></tr> <tr><td>50-99</td><td>\$95.97</td></tr> <tr><td>100+</td><td>\$91.70</td></tr> </tbody> </table> <p>Low PIM</p> <p>N Male to N Female</p> <p>Max. Freq. 12.4 GHz</p> <p>Model No: <a href="#">PE91040</a></p>	PRICE	1-24	\$106.63	25-49	\$101.30	50-99	\$95.97	100+	\$91.70	 <table border="1"> <thead> <tr><th>PRICE</th></tr> </thead> <tbody> <tr><td>1-24</td><td>\$78.39</td></tr> <tr><td>25-49</td><td>\$74.47</td></tr> <tr><td>50-99</td><td>\$70.55</td></tr> <tr><td>100+</td><td>\$67.42</td></tr> </tbody> </table> <p>Low PIM</p> <p>N Female to N Female</p> <p>VSWR 1.2:1 to 6 GHz</p> <p>Model No: <a href="#">PE91140</a></p>	PRICE	1-24	\$78.39	25-49	\$74.47	50-99	\$70.55	100+	\$67.42	 <table border="1"> <thead> <tr><th>PRICE</th></tr> </thead> <tbody> <tr><td>1-24</td><td>\$70.22</td></tr> <tr><td>25-49</td><td>\$66.71</td></tr> <tr><td>50-99</td><td>\$63.20</td></tr> <tr><td>100+</td><td>\$60.39</td></tr> </tbody> </table> <p>Low PIM</p> <p>N Female to N Female Bulkhead</p> <p>VSWR 1.2:1 to 6 GHz</p> <p>Model No: <a href="#">PE91179</a></p>	PRICE	1-24	\$70.22	25-49	\$66.71	50-99	\$63.20	100+	\$60.39	<p><b>N</b></p> <p><i>Between Series</i></p> <p>→</p>		 <table border="1"> <thead> <tr><th>PRICE</th></tr> </thead> <tbody> <tr><td>1-24</td><td>\$81.38</td></tr> <tr><td>25-49</td><td>\$77.31</td></tr> <tr><td>50-99</td><td>\$73.24</td></tr> <tr><td>100+</td><td>\$69.99</td></tr> </tbody> </table> <p>Low PIM</p> <p>N Male to 4.3-10 Female</p> <p>VSWR 1.08:1 to 6 GHz</p> <p>Model No: <a href="#">PE91388</a></p>	PRICE	1-24	\$81.38	25-49	\$77.31	50-99	\$73.24	100+	\$69.99								
	PRICE																																																	
1-24	\$106.63																																																	
25-49	\$101.30																																																	
50-99	\$95.97																																																	
100+	\$91.70																																																	
PRICE																																																		
1-24	\$78.39																																																	
25-49	\$74.47																																																	
50-99	\$70.55																																																	
100+	\$67.42																																																	
PRICE																																																		
1-24	\$70.22																																																	
25-49	\$66.71																																																	
50-99	\$63.20																																																	
100+	\$60.39																																																	
PRICE																																																		
1-24	\$81.38																																																	
25-49	\$77.31																																																	
50-99	\$73.24																																																	
100+	\$69.99																																																	
4	 <table border="1"> <thead> <tr><th>PRICE</th></tr> </thead> <tbody> <tr><td>1-24</td><td>\$93.44</td></tr> <tr><td>25-49</td><td>\$88.77</td></tr> <tr><td>50-99</td><td>\$84.10</td></tr> <tr><td>100+</td><td>\$80.36</td></tr> </tbody> </table> <p>Low PIM</p> <p>N Male to 7/16 DIN Male</p> <p>Max. Freq. 8 GHz</p> <p>Model No: <a href="#">PE91030</a></p>	PRICE	1-24	\$93.44	25-49	\$88.77	50-99	\$84.10	100+	\$80.36	 <table border="1"> <thead> <tr><th>PRICE</th></tr> </thead> <tbody> <tr><td>1-24</td><td>\$115.11</td></tr> <tr><td>25-49</td><td>\$109.35</td></tr> <tr><td>50-99</td><td>\$103.60</td></tr> <tr><td>100+</td><td>\$98.99</td></tr> </tbody> </table> <p>Low PIM</p> <p>N Male to 7/16 DIN Female</p> <p>Max. Freq. 8 GHz</p> <p>Model No: <a href="#">PE91032</a></p>	PRICE	1-24	\$115.11	25-49	\$109.35	50-99	\$103.60	100+	\$98.99	 <table border="1"> <thead> <tr><th>PRICE</th></tr> </thead> <tbody> <tr><td>1-24</td><td>\$52.34</td></tr> <tr><td>25-49</td><td>\$49.72</td></tr> <tr><td>50-99</td><td>\$47.11</td></tr> <tr><td>100+</td><td>\$45.01</td></tr> </tbody> </table> <p>Low PIM</p> <p>N Male to SMA Female</p> <p>VSWR 1.2:1 to 6 GHz</p> <p>Model No: <a href="#">PE91177</a></p>	PRICE	1-24	\$52.34	25-49	\$49.72	50-99	\$47.11	100+	\$45.01	 <table border="1"> <thead> <tr><th>PRICE</th></tr> </thead> <tbody> <tr><td>1-24</td><td>\$107.77</td></tr> <tr><td>25-49</td><td>\$102.38</td></tr> <tr><td>50-99</td><td>\$96.99</td></tr> <tr><td>100+</td><td>\$92.68</td></tr> </tbody> </table> <p>Low PIM</p> <p>N Female to 7/16 DIN Male</p> <p>Max. Freq. 8 GHz</p> <p>Model No: <a href="#">PE91031</a></p>	PRICE	1-24	\$107.77	25-49	\$102.38	50-99	\$96.99	100+	\$92.68	 <table border="1"> <thead> <tr><th>PRICE</th></tr> </thead> <tbody> <tr><td>1-24</td><td>\$100.12</td></tr> <tr><td>25-49</td><td>\$95.11</td></tr> <tr><td>50-99</td><td>\$90.11</td></tr> <tr><td>100+</td><td>\$86.10</td></tr> </tbody> </table> <p>Low PIM</p> <p>N Female to 7/16 DIN Female</p> <p>Max. Freq. 8 GHz</p> <p>Model No: <a href="#">PE91033</a></p>	PRICE	1-24	\$100.12	25-49	\$95.11	50-99	\$90.11	100+	\$86.10
	PRICE																																																	
1-24	\$93.44																																																	
25-49	\$88.77																																																	
50-99	\$84.10																																																	
100+	\$80.36																																																	
PRICE																																																		
1-24	\$115.11																																																	
25-49	\$109.35																																																	
50-99	\$103.60																																																	
100+	\$98.99																																																	
PRICE																																																		
1-24	\$52.34																																																	
25-49	\$49.72																																																	
50-99	\$47.11																																																	
100+	\$45.01																																																	
PRICE																																																		
1-24	\$107.77																																																	
25-49	\$102.38																																																	
50-99	\$96.99																																																	
100+	\$92.68																																																	
PRICE																																																		
1-24	\$100.12																																																	
25-49	\$95.11																																																	
50-99	\$90.11																																																	
100+	\$86.10																																																	
5	 <table border="1"> <thead> <tr><th>PRICE</th></tr> </thead> <tbody> <tr><td>1-9</td><td>\$153.30</td></tr> <tr><td>10-24</td><td>\$145.64</td></tr> <tr><td>25-49</td><td>\$137.97</td></tr> <tr><td>50+</td><td>\$131.84</td></tr> </tbody> </table> <p>Low PIM</p> <p>N Female to 7/16 DIN Female</p> <p>Max. Freq. 8 GHz</p> <p>Model No: <a href="#">PE9180</a></p>	PRICE	1-9	\$153.30	10-24	\$145.64	25-49	\$137.97	50+	\$131.84	 <table border="1"> <thead> <tr><th>PRICE</th></tr> </thead> <tbody> <tr><td>1-24</td><td>\$53.30</td></tr> <tr><td>25-49</td><td>\$50.64</td></tr> <tr><td>50-99</td><td>\$47.97</td></tr> <tr><td>100+</td><td>\$45.84</td></tr> </tbody> </table> <p>Low PIM</p> <p>N Female to SMA Male</p> <p>VSWR 1.2:1 to 6 GHz</p> <p>Model No: <a href="#">PE91178</a></p>	PRICE	1-24	\$53.30	25-49	\$50.64	50-99	\$47.97	100+	\$45.84	<p><b>SMA</b></p> <p><i>Between Series</i></p> <p>→</p>		 <table border="1"> <thead> <tr><th>PRICE</th></tr> </thead> <tbody> <tr><td>1-24</td><td>\$92.67</td></tr> <tr><td>25-49</td><td>\$88.04</td></tr> <tr><td>50-99</td><td>\$83.40</td></tr> <tr><td>100+</td><td>\$79.70</td></tr> </tbody> </table> <p>Low PIM</p> <p>SMA Female to 7/16 DIN Male</p> <p>VSWR 1.09:1 to 7.5 GHz</p> <p>Model No: <a href="#">PE91036</a></p>	PRICE	1-24	\$92.67	25-49	\$88.04	50-99	\$83.40	100+	\$79.70	 <table border="1"> <thead> <tr><th>PRICE</th></tr> </thead> <tbody> <tr><td>1-24</td><td>\$93.44</td></tr> <tr><td>25-49</td><td>\$88.77</td></tr> <tr><td>50-99</td><td>\$84.10</td></tr> <tr><td>100+</td><td>\$80.36</td></tr> </tbody> </table> <p>Low PIM</p> <p>SMA Female to 7/16 DIN Female</p> <p>Max. Freq. 8 GHz</p> <p>Model No: <a href="#">PE91042</a></p>	PRICE	1-24	\$93.44	25-49	\$88.77	50-99	\$84.10	100+	\$80.36								
	PRICE																																																	
1-9	\$153.30																																																	
10-24	\$145.64																																																	
25-49	\$137.97																																																	
50+	\$131.84																																																	
PRICE																																																		
1-24	\$53.30																																																	
25-49	\$50.64																																																	
50-99	\$47.97																																																	
100+	\$45.84																																																	
PRICE																																																		
1-24	\$92.67																																																	
25-49	\$88.04																																																	
50-99	\$83.40																																																	
100+	\$79.70																																																	
PRICE																																																		
1-24	\$93.44																																																	
25-49	\$88.77																																																	
50-99	\$84.10																																																	
100+	\$80.36																																																	
6	<p><b>TNC</b></p> <p><i>In-Series</i></p> <p>→</p>		 <table border="1"> <thead> <tr><th>PRICE</th></tr> </thead> <tbody> <tr><td>1-24</td><td>\$67.62</td></tr> <tr><td>25-49</td><td>\$64.24</td></tr> <tr><td>50-99</td><td>\$60.86</td></tr> <tr><td>100+</td><td>\$58.15</td></tr> </tbody> </table> <p>Low PIM</p> <p>TNC Male to TNC Male</p> <p>VSWR 1.25:1 to 6 GHz</p> <p>Model No: <a href="#">PE91172</a></p>	PRICE	1-24	\$67.62	25-49	\$64.24	50-99	\$60.86	100+	\$58.15	 <table border="1"> <thead> <tr><th>PRICE</th></tr> </thead> <tbody> <tr><td>1-24</td><td>\$64.44</td></tr> <tr><td>25-49</td><td>\$61.22</td></tr> <tr><td>50-99</td><td>\$58.00</td></tr> <tr><td>100+</td><td>\$55.42</td></tr> </tbody> </table> <p>Low PIM</p> <p>TNC Male to TNC Female</p> <p>VSWR 1.25:1 to 6 GHz</p> <p>Model No: <a href="#">PE91173</a></p>	PRICE	1-24	\$64.44	25-49	\$61.22	50-99	\$58.00	100+	\$55.42	 <table border="1"> <thead> <tr><th>PRICE</th></tr> </thead> <tbody> <tr><td>1-24</td><td>\$59.06</td></tr> <tr><td>25-49</td><td>\$56.11</td></tr> <tr><td>50-99</td><td>\$53.15</td></tr> <tr><td>100+</td><td>\$50.79</td></tr> </tbody> </table> <p>Low PIM</p> <p>TNC Female to TNC Female</p> <p>VSWR 1.25:1 to 6 GHz</p> <p>Model No: <a href="#">PE91174</a></p>	PRICE	1-24	\$59.06	25-49	\$56.11	50-99	\$53.15	100+	\$50.79	<p>Visit <a href="http://pasternack.com">pasternack.com</a> for our complete offering of adapters</p>																	
	PRICE																																																	
1-24	\$67.62																																																	
25-49	\$64.24																																																	
50-99	\$60.86																																																	
100+	\$58.15																																																	
PRICE																																																		
1-24	\$64.44																																																	
25-49	\$61.22																																																	
50-99	\$58.00																																																	
100+	\$55.42																																																	
PRICE																																																		
1-24	\$59.06																																																	
25-49	\$56.11																																																	
50-99	\$53.15																																																	
100+	\$50.79																																																	

See Our Website For Current Pricing & Real-Time Stock Availability!



Technical Support  
+1 (949) 261-1920



Same-Day Shipping,  
Even Custom Cable Assemblies































# ADAPTERS

See Adapter Locator on Pages 10-15

See Page 409 for Mounting Holes

Adapters

See Our Website For Current Pricing & Real-Time Stock Availability!

	A	B	C	D	E																																																		
1	<p><b>1.0mm In-Series</b></p>  <p>→</p>	 <table border="1"> <thead> <tr> <th colspan="2">PRICE</th> </tr> </thead> <tbody> <tr><td>1-24</td><td>\$1,722.55</td></tr> <tr><td>25-49</td><td>\$1,601.97</td></tr> <tr><td>50-99</td><td>\$1,481.39</td></tr> <tr><td>100+</td><td>\$1,378.04</td></tr> </tbody> </table> <p>1.0mm Male to 1.0mm Male VSWR 1.28:1 to 110 GHz</p> <p>Model No: <a href="#">PE91462</a></p>	PRICE		1-24	\$1,722.55	25-49	\$1,601.97	50-99	\$1,481.39	100+	\$1,378.04	 <table border="1"> <thead> <tr> <th colspan="2">PRICE</th> </tr> </thead> <tbody> <tr><td>1-1</td><td>\$1,789.73</td></tr> <tr><td>2-4</td><td>\$1,718.14</td></tr> <tr><td>5-9</td><td>\$1,646.55</td></tr> <tr><td>10+</td><td>\$1,574.96</td></tr> </tbody> </table> <p>1.0mm Female to 1.0mm Male VSWR 1.28:1 to 110 GHz</p> <p>Model No: <a href="#">PE91461</a></p>	PRICE		1-1	\$1,789.73	2-4	\$1,718.14	5-9	\$1,646.55	10+	\$1,574.96	 <table border="1"> <thead> <tr> <th colspan="2">PRICE</th> </tr> </thead> <tbody> <tr><td>1-1</td><td>\$1,471.71</td></tr> <tr><td>2-4</td><td>\$1,412.84</td></tr> <tr><td>5-9</td><td>\$1,353.97</td></tr> <tr><td>10+</td><td>\$1,295.10</td></tr> </tbody> </table> <p>1.0mm Female to 1.0mm Female VSWR 1.28:1 to 110 GHz</p> <p>Model No: <a href="#">PE91463</a></p>	PRICE		1-1	\$1,471.71	2-4	\$1,412.84	5-9	\$1,353.97	10+	\$1,295.10	<p><b>1.0mm Between Series</b></p> <p>→</p>																				
PRICE																																																							
1-24	\$1,722.55																																																						
25-49	\$1,601.97																																																						
50-99	\$1,481.39																																																						
100+	\$1,378.04																																																						
PRICE																																																							
1-1	\$1,789.73																																																						
2-4	\$1,718.14																																																						
5-9	\$1,646.55																																																						
10+	\$1,574.96																																																						
PRICE																																																							
1-1	\$1,471.71																																																						
2-4	\$1,412.84																																																						
5-9	\$1,353.97																																																						
10+	\$1,295.10																																																						
2	 <table border="1"> <thead> <tr> <th colspan="2">PRICE</th> </tr> </thead> <tbody> <tr><td>1-4</td><td>\$738.81</td></tr> <tr><td>5-9</td><td>\$701.87</td></tr> <tr><td>10-24</td><td>\$664.93</td></tr> <tr><td>25+</td><td>\$635.38</td></tr> </tbody> </table> <p>1.0mm Male to 1.85mm Male VSWR 1.25:1 to 65 GHz</p> <p>Model No: <a href="#">PE91118</a></p>	PRICE		1-4	\$738.81	5-9	\$701.87	10-24	\$664.93	25+	\$635.38	 <table border="1"> <thead> <tr> <th colspan="2">PRICE</th> </tr> </thead> <tbody> <tr><td>1-4</td><td>\$493.83</td></tr> <tr><td>5-9</td><td>\$469.14</td></tr> <tr><td>10-24</td><td>\$444.45</td></tr> <tr><td>25+</td><td>\$424.69</td></tr> </tbody> </table> <p>1.0mm Male to 1.85mm Female VSWR 1.35:1 to 65 GHz</p> <p>Model No: <a href="#">PE91108</a></p>	PRICE		1-4	\$493.83	5-9	\$469.14	10-24	\$444.45	25+	\$424.69	 <table border="1"> <thead> <tr> <th colspan="2">PRICE</th> </tr> </thead> <tbody> <tr><td>1-4</td><td>\$597.78</td></tr> <tr><td>5-9</td><td>\$567.89</td></tr> <tr><td>10-24</td><td>\$538.00</td></tr> <tr><td>25+</td><td>\$514.09</td></tr> </tbody> </table> <p>1.0mm Female to 1.85mm Male VSWR 1.25:1 to 65 GHz</p> <p>Model No: <a href="#">PE91119</a></p>	PRICE		1-4	\$597.78	5-9	\$567.89	10-24	\$538.00	25+	\$514.09	 <table border="1"> <thead> <tr> <th colspan="2">PRICE</th> </tr> </thead> <tbody> <tr><td>1-4</td><td>\$493.83</td></tr> <tr><td>5-9</td><td>\$469.14</td></tr> <tr><td>10-24</td><td>\$444.45</td></tr> <tr><td>25+</td><td>\$424.69</td></tr> </tbody> </table> <p>1.0mm Female to 1.85mm Female VSWR 1.35:1 to 65 GHz</p> <p>Model No: <a href="#">PE91109</a></p>	PRICE		1-4	\$493.83	5-9	\$469.14	10-24	\$444.45	25+	\$424.69	<p><b>1.85mm In-Series</b></p> <p>→</p>										
PRICE																																																							
1-4	\$738.81																																																						
5-9	\$701.87																																																						
10-24	\$664.93																																																						
25+	\$635.38																																																						
PRICE																																																							
1-4	\$493.83																																																						
5-9	\$469.14																																																						
10-24	\$444.45																																																						
25+	\$424.69																																																						
PRICE																																																							
1-4	\$597.78																																																						
5-9	\$567.89																																																						
10-24	\$538.00																																																						
25+	\$514.09																																																						
PRICE																																																							
1-4	\$493.83																																																						
5-9	\$469.14																																																						
10-24	\$444.45																																																						
25+	\$424.69																																																						
3	 <table border="1"> <thead> <tr> <th colspan="2">PRICE</th> </tr> </thead> <tbody> <tr><td>1-4</td><td>\$784.38</td></tr> <tr><td>5-9</td><td>\$745.16</td></tr> <tr><td>10-24</td><td>\$705.94</td></tr> <tr><td>25+</td><td>\$674.57</td></tr> </tbody> </table> <p>1.85mm Male to 1.85mm Male VSWR 1.35:1 to 67 GHz</p> <p>Model No: <a href="#">PE91085</a></p>	PRICE		1-4	\$784.38	5-9	\$745.16	10-24	\$705.94	25+	\$674.57	 <table border="1"> <thead> <tr> <th colspan="2">PRICE</th> </tr> </thead> <tbody> <tr><td>1-4</td><td>\$716.36</td></tr> <tr><td>5-9</td><td>\$680.54</td></tr> <tr><td>10-24</td><td>\$644.72</td></tr> <tr><td>25+</td><td>\$616.07</td></tr> </tbody> </table> <p>1.85mm Male to 1.85mm Male VSWR 1.5:1 to 65 GHz</p> <p>Model No: <a href="#">PE9716</a></p>	PRICE		1-4	\$716.36	5-9	\$680.54	10-24	\$644.72	25+	\$616.07	 <table border="1"> <thead> <tr> <th colspan="2">PRICE</th> </tr> </thead> <tbody> <tr><td>1-4</td><td>\$719.61</td></tr> <tr><td>5-9</td><td>\$683.63</td></tr> <tr><td>10-24</td><td>\$647.65</td></tr> <tr><td>25+</td><td>\$618.86</td></tr> </tbody> </table> <p>1.85mm Male to 1.85mm Female VSWR 1.35:1 to 67 GHz</p> <p>Model No: <a href="#">PE91086</a></p>	PRICE		1-4	\$719.61	5-9	\$683.63	10-24	\$647.65	25+	\$618.86	 <table border="1"> <thead> <tr> <th colspan="2">PRICE</th> </tr> </thead> <tbody> <tr><td>1-4</td><td>\$716.36</td></tr> <tr><td>5-9</td><td>\$680.54</td></tr> <tr><td>10-24</td><td>\$644.72</td></tr> <tr><td>25+</td><td>\$616.07</td></tr> </tbody> </table> <p>1.85mm Male to 1.85mm Female VSWR 1.5:1 to 65 GHz</p> <p>Model No: <a href="#">PE9715</a></p>	PRICE		1-4	\$716.36	5-9	\$680.54	10-24	\$644.72	25+	\$616.07	 <table border="1"> <thead> <tr> <th colspan="2">PRICE</th> </tr> </thead> <tbody> <tr><td>1-4</td><td>\$730.39</td></tr> <tr><td>5-9</td><td>\$693.87</td></tr> <tr><td>10-24</td><td>\$657.35</td></tr> <tr><td>25+</td><td>\$628.14</td></tr> </tbody> </table> <p>1.85mm Female to 1.85mm Female Max. Freq. 67 GHz</p> <p>Model No: <a href="#">PE91084</a></p>	PRICE		1-4	\$730.39	5-9	\$693.87	10-24	\$657.35	25+	\$628.14
PRICE																																																							
1-4	\$784.38																																																						
5-9	\$745.16																																																						
10-24	\$705.94																																																						
25+	\$674.57																																																						
PRICE																																																							
1-4	\$716.36																																																						
5-9	\$680.54																																																						
10-24	\$644.72																																																						
25+	\$616.07																																																						
PRICE																																																							
1-4	\$719.61																																																						
5-9	\$683.63																																																						
10-24	\$647.65																																																						
25+	\$618.86																																																						
PRICE																																																							
1-4	\$716.36																																																						
5-9	\$680.54																																																						
10-24	\$644.72																																																						
25+	\$616.07																																																						
PRICE																																																							
1-4	\$730.39																																																						
5-9	\$693.87																																																						
10-24	\$657.35																																																						
25+	\$628.14																																																						
4	 <table border="1"> <thead> <tr> <th colspan="2">PRICE</th> </tr> </thead> <tbody> <tr><td>1-4</td><td>\$604.10</td></tr> <tr><td>5-9</td><td>\$573.90</td></tr> <tr><td>10-24</td><td>\$543.69</td></tr> <tr><td>25+</td><td>\$519.53</td></tr> </tbody> </table> <p>1.85mm Female to 1.85mm Female VSWR 1.25:1 to 67 GHz</p> <p>Model No: <a href="#">PE91115</a></p>	PRICE		1-4	\$604.10	5-9	\$573.90	10-24	\$543.69	25+	\$519.53	<p><b>1.85mm Between Series</b></p> <p>→</p>	 <table border="1"> <thead> <tr> <th colspan="2">PRICE</th> </tr> </thead> <tbody> <tr><td>1-9</td><td>\$423.77</td></tr> <tr><td>10-24</td><td>\$402.58</td></tr> <tr><td>25-49</td><td>\$381.39</td></tr> <tr><td>NEW 50+</td><td>\$364.44</td></tr> </tbody> </table> <p>1.85mm Male to 2.4mm Male Right Angle VSWR 1.4:1 to 50 GHz</p> <p>Model No: <a href="#">PE91157</a></p>	PRICE		1-9	\$423.77	10-24	\$402.58	25-49	\$381.39	NEW 50+	\$364.44	 <table border="1"> <thead> <tr> <th colspan="2">PRICE</th> </tr> </thead> <tbody> <tr><td>1-9</td><td>\$386.58</td></tr> <tr><td>10-24</td><td>\$367.25</td></tr> <tr><td>25-49</td><td>\$347.92</td></tr> <tr><td>NEW 50+</td><td>\$332.46</td></tr> </tbody> </table> <p>1.85mm Male to 2.4mm Male Miter Right Angle VSWR 1.35:1 to 50 GHz</p> <p>Model No: <a href="#">PE91518</a></p>	PRICE		1-9	\$386.58	10-24	\$367.25	25-49	\$347.92	NEW 50+	\$332.46	 <table border="1"> <thead> <tr> <th colspan="2">PRICE</th> </tr> </thead> <tbody> <tr><td>1-9</td><td>\$432.34</td></tr> <tr><td>10-24</td><td>\$410.72</td></tr> <tr><td>25-49</td><td>\$389.11</td></tr> <tr><td>NEW 50+</td><td>\$371.81</td></tr> </tbody> </table> <p>1.85mm Male to 2.4mm Female Miter Right Angle VSWR 1.35:1 to 50 GHz</p> <p>Model No: <a href="#">PE91511</a></p>	PRICE		1-9	\$432.34	10-24	\$410.72	25-49	\$389.11	NEW 50+	\$371.81										
PRICE																																																							
1-4	\$604.10																																																						
5-9	\$573.90																																																						
10-24	\$543.69																																																						
25+	\$519.53																																																						
PRICE																																																							
1-9	\$423.77																																																						
10-24	\$402.58																																																						
25-49	\$381.39																																																						
NEW 50+	\$364.44																																																						
PRICE																																																							
1-9	\$386.58																																																						
10-24	\$367.25																																																						
25-49	\$347.92																																																						
NEW 50+	\$332.46																																																						
PRICE																																																							
1-9	\$432.34																																																						
10-24	\$410.72																																																						
25-49	\$389.11																																																						
NEW 50+	\$371.81																																																						
5	 <table border="1"> <thead> <tr> <th colspan="2">PRICE</th> </tr> </thead> <tbody> <tr><td>1-24</td><td>\$401.15</td></tr> <tr><td>25-49</td><td>\$373.07</td></tr> <tr><td>50-99</td><td>\$344.99</td></tr> <tr><td>100+</td><td>\$320.92</td></tr> </tbody> </table> <p>1.85mm Male to 2.92mm Male Right Angle VSWR 1.3:1 to 40 GHz</p> <p>Model No: <a href="#">PE91161</a></p>	PRICE		1-24	\$401.15	25-49	\$373.07	50-99	\$344.99	100+	\$320.92	 <table border="1"> <thead> <tr> <th colspan="2">PRICE</th> </tr> </thead> <tbody> <tr><td>1-9</td><td>\$355.54</td></tr> <tr><td>10-24</td><td>\$337.76</td></tr> <tr><td>25-49</td><td>\$319.99</td></tr> <tr><td>NEW 50+</td><td>\$305.76</td></tr> </tbody> </table> <p>1.85mm Male to 2.92mm Male Miter Right Angle VSWR 1.25:1 to 40 GHz</p> <p>Model No: <a href="#">PE91519</a></p>	PRICE		1-9	\$355.54	10-24	\$337.76	25-49	\$319.99	NEW 50+	\$305.76	 <table border="1"> <thead> <tr> <th colspan="2">PRICE</th> </tr> </thead> <tbody> <tr><td>1-9</td><td>\$234.76</td></tr> <tr><td>10-24</td><td>\$223.02</td></tr> <tr><td>25-49</td><td>\$211.28</td></tr> <tr><td>50+</td><td>\$201.89</td></tr> </tbody> </table> <p>1.85mm Male to 3.5mm Female VSWR 1.3:1 to 34 GHz</p> <p>Model No: <a href="#">PE9747</a></p>	PRICE		1-9	\$234.76	10-24	\$223.02	25-49	\$211.28	50+	\$201.89	 <table border="1"> <thead> <tr> <th colspan="2">PRICE</th> </tr> </thead> <tbody> <tr><td>1-9</td><td>\$233.30</td></tr> <tr><td>10-24</td><td>\$221.64</td></tr> <tr><td>25-49</td><td>\$209.97</td></tr> <tr><td>50+</td><td>\$200.64</td></tr> </tbody> </table> <p>1.85mm Male to N Male VSWR 1.25:1 to 18 GHz</p> <p>Model No: <a href="#">PE9718</a></p>	PRICE		1-9	\$233.30	10-24	\$221.64	25-49	\$209.97	50+	\$200.64	 <table border="1"> <thead> <tr> <th colspan="2">PRICE</th> </tr> </thead> <tbody> <tr><td>1-9</td><td>\$237.54</td></tr> <tr><td>10-24</td><td>\$225.66</td></tr> <tr><td>25-49</td><td>\$213.79</td></tr> <tr><td>50+</td><td>\$204.28</td></tr> </tbody> </table> <p>1.85mm Male to N Female VSWR 1.25:1 to 18 GHz</p> <p>Model No: <a href="#">PE9719</a></p>	PRICE		1-9	\$237.54	10-24	\$225.66	25-49	\$213.79	50+	\$204.28
PRICE																																																							
1-24	\$401.15																																																						
25-49	\$373.07																																																						
50-99	\$344.99																																																						
100+	\$320.92																																																						
PRICE																																																							
1-9	\$355.54																																																						
10-24	\$337.76																																																						
25-49	\$319.99																																																						
NEW 50+	\$305.76																																																						
PRICE																																																							
1-9	\$234.76																																																						
10-24	\$223.02																																																						
25-49	\$211.28																																																						
50+	\$201.89																																																						
PRICE																																																							
1-9	\$233.30																																																						
10-24	\$221.64																																																						
25-49	\$209.97																																																						
50+	\$200.64																																																						
PRICE																																																							
1-9	\$237.54																																																						
10-24	\$225.66																																																						
25-49	\$213.79																																																						
50+	\$204.28																																																						
6	 <table border="1"> <thead> <tr> <th colspan="2">PRICE</th> </tr> </thead> <tbody> <tr><td>1-24</td><td>\$423.77</td></tr> <tr><td>25-49</td><td>\$402.58</td></tr> <tr><td>50-99</td><td>\$381.39</td></tr> <tr><td>NEW 100+</td><td>\$364.44</td></tr> </tbody> </table> <p>1.85mm Female to 2.4mm Female Miter Right Angle VSWR 1.35:1 to 50 GHz</p> <p>Model No: <a href="#">PE91534</a></p>	PRICE		1-24	\$423.77	25-49	\$402.58	50-99	\$381.39	NEW 100+	\$364.44	 <table border="1"> <thead> <tr> <th colspan="2">PRICE</th> </tr> </thead> <tbody> <tr><td>1-24</td><td>\$401.14</td></tr> <tr><td>25-49</td><td>\$373.06</td></tr> <tr><td>50-99</td><td>\$344.98</td></tr> <tr><td>100+</td><td>\$320.91</td></tr> </tbody> </table> <p>1.85mm Female to 2.92mm Male Right Angle VSWR 1.3:1 to 40 GHz</p> <p>Model No: <a href="#">PE91162</a></p>	PRICE		1-24	\$401.14	25-49	\$373.06	50-99	\$344.98	100+	\$320.91	 <table border="1"> <thead> <tr> <th colspan="2">PRICE</th> </tr> </thead> <tbody> <tr><td>1-24</td><td>\$360.23</td></tr> <tr><td>25-49</td><td>\$335.01</td></tr> <tr><td>50-99</td><td>\$309.80</td></tr> <tr><td>NEW 100+</td><td>\$288.18</td></tr> </tbody> </table> <p>1.85mm Female to 2.92mm Male Miter Right Angle VSWR 1.25:1 to 40 GHz</p> <p>Model No: <a href="#">PE91512</a></p>	PRICE		1-24	\$360.23	25-49	\$335.01	50-99	\$309.80	NEW 100+	\$288.18	 <table border="1"> <thead> <tr> <th colspan="2">PRICE</th> </tr> </thead> <tbody> <tr><td>1-24</td><td>\$289.82</td></tr> <tr><td>25-49</td><td>\$269.53</td></tr> <tr><td>50-99</td><td>\$249.25</td></tr> <tr><td>NEW 100+</td><td>\$231.86</td></tr> </tbody> </table> <p>1.85mm Female to 2.92mm Female Miter Right Angle VSWR 1.3:1 to 40 GHz</p> <p>Model No: <a href="#">PE91163</a></p>	PRICE		1-24	\$289.82	25-49	\$269.53	50-99	\$249.25	NEW 100+	\$231.86	 <table border="1"> <thead> <tr> <th colspan="2">PRICE</th> </tr> </thead> <tbody> <tr><td>1-24</td><td>\$342.66</td></tr> <tr><td>25-49</td><td>\$318.67</td></tr> <tr><td>50-99</td><td>\$294.69</td></tr> <tr><td>NEW 100+</td><td>\$274.13</td></tr> </tbody> </table> <p>1.85mm Female to 2.92mm Female Miter Right Angle VSWR 1.25:1 to 40 GHz</p> <p>Model No: <a href="#">PE91513</a></p>	PRICE		1-24	\$342.66	25-49	\$318.67	50-99	\$294.69	NEW 100+	\$274.13
PRICE																																																							
1-24	\$423.77																																																						
25-49	\$402.58																																																						
50-99	\$381.39																																																						
NEW 100+	\$364.44																																																						
PRICE																																																							
1-24	\$401.14																																																						
25-49	\$373.06																																																						
50-99	\$344.98																																																						
100+	\$320.91																																																						
PRICE																																																							
1-24	\$360.23																																																						
25-49	\$335.01																																																						
50-99	\$309.80																																																						
NEW 100+	\$288.18																																																						
PRICE																																																							
1-24	\$289.82																																																						
25-49	\$269.53																																																						
50-99	\$249.25																																																						
NEW 100+	\$231.86																																																						
PRICE																																																							
1-24	\$342.66																																																						
25-49	\$318.67																																																						
50-99	\$294.69																																																						
NEW 100+	\$274.13																																																						
7	 <table border="1"> <thead> <tr> <th colspan="2">PRICE</th> </tr> </thead> <tbody> <tr><td>1-9</td><td>\$252.05</td></tr> <tr><td>10-24</td><td>\$239.45</td></tr> <tr><td>25-49</td><td>\$226.85</td></tr> <tr><td>50+</td><td>\$216.76</td></tr> </tbody> </table> <p>1.85mm Female to N Male VSWR 1.25:1 to 18 GHz</p> <p>Model No: <a href="#">PE9720</a></p>	PRICE		1-9	\$252.05	10-24	\$239.45	25-49	\$226.85	50+	\$216.76	 <table border="1"> <thead> <tr> <th colspan="2">PRICE</th> </tr> </thead> <tbody> <tr><td>1-9</td><td>\$237.54</td></tr> <tr><td>10-24</td><td>\$225.66</td></tr> <tr><td>25-49</td><td>\$213.79</td></tr> <tr><td>50+</td><td>\$204.28</td></tr> </tbody> </table> <p>1.85mm Female to N Female VSWR 1.25:1 to 18 GHz</p> <p>Model No: <a href="#">PE9721</a></p>	PRICE		1-9	\$237.54	10-24	\$225.66	25-49	\$213.79	50+	\$204.28	<p><b>2.4mm In-Series</b></p> <p>→</p>	 <table border="1"> <thead> <tr> <th colspan="2">PRICE</th> </tr> </thead> <tbody> <tr><td>1-9</td><td>\$228.28</td></tr> <tr><td>10-24</td><td>\$216.87</td></tr> <tr><td>25-49</td><td>\$205.45</td></tr> <tr><td>50+</td><td>\$196.32</td></tr> </tbody> </table> <p>2.4mm Male to 2.4mm Male VSWR 1.3:1 to 50 GHz</p> <p>Model No: <a href="#">PE9451</a></p>	PRICE		1-9	\$228.28	10-24	\$216.87	25-49	\$205.45	50+	\$196.32	 <table border="1"> <thead> <tr> <th colspan="2">PRICE</th> </tr> </thead> <tbody> <tr><td>1-9</td><td>\$218.51</td></tr> <tr><td>10-24</td><td>\$207.58</td></tr> <tr><td>25-49</td><td>\$196.66</td></tr> <tr><td>50+</td><td>\$187.92</td></tr> </tbody> </table> <p>2.4mm Male to 2.4mm Female VSWR 1.3:1 to 50 GHz</p> <p>Model No: <a href="#">PE9452</a></p>	PRICE		1-9	\$218.51	10-24	\$207.58	25-49	\$196.66	50+	\$187.92										
PRICE																																																							
1-9	\$252.05																																																						
10-24	\$239.45																																																						
25-49	\$226.85																																																						
50+	\$216.76																																																						
PRICE																																																							
1-9	\$237.54																																																						
10-24	\$225.66																																																						
25-49	\$213.79																																																						
50+	\$204.28																																																						
PRICE																																																							
1-9	\$228.28																																																						
10-24	\$216.87																																																						
25-49	\$205.45																																																						
50+	\$196.32																																																						
PRICE																																																							
1-9	\$218.51																																																						
10-24	\$207.58																																																						
25-49	\$196.66																																																						
50+	\$187.92																																																						



# ADAPTERS

See Adapter Locator on Pages 10-15  
See Page 409 for Mounting Holes

	A	B	C	D	E																																													
1	 <table border="1"> <thead> <tr><th>PRICE</th></tr> </thead> <tbody> <tr><td>1-24</td><td>\$395.98</td></tr> <tr><td>25-49</td><td>\$368.26</td></tr> <tr><td>50-99</td><td>\$340.54</td></tr> <tr><td>NEW 100+</td><td>\$316.78</td></tr> </tbody> </table> <p>2.4mm Male to 2.4mm Female Right Angle VSWR 1.4:1 to 50 GHz</p> <p>Model No: <a href="#">PE91138</a></p>	PRICE	1-24	\$395.98	25-49	\$368.26	50-99	\$340.54	NEW 100+	\$316.78	 <table border="1"> <thead> <tr><th>PRICE</th></tr> </thead> <tbody> <tr><td>1-24</td><td>\$371.81</td></tr> <tr><td>25-49</td><td>\$345.78</td></tr> <tr><td>50-99</td><td>\$319.76</td></tr> <tr><td>NEW 100+</td><td>\$297.45</td></tr> </tbody> </table> <p>2.4mm Male to 2.4mm Female Miter Right Angle VSWR 1.35:1 to 50 GHz</p> <p>Model No: <a href="#">PE91498</a></p>	PRICE	1-24	\$371.81	25-49	\$345.78	50-99	\$319.76	NEW 100+	\$297.45	 <table border="1"> <thead> <tr><th>PRICE</th></tr> </thead> <tbody> <tr><td>1-9</td><td>\$215.40</td></tr> <tr><td>10-24</td><td>\$204.63</td></tr> <tr><td>25-49</td><td>\$193.86</td></tr> <tr><td>50+</td><td>\$185.24</td></tr> </tbody> </table> <p>2.4mm Female to 2.4mm Female VSWR 1.3:1 to 50 GHz</p> <p>Model No: <a href="#">PE9453</a></p>	PRICE	1-9	\$215.40	10-24	\$204.63	25-49	\$193.86	50+	\$185.24	 <table border="1"> <thead> <tr><th>PRICE</th></tr> </thead> <tbody> <tr><td>1-24</td><td>\$212.57</td></tr> <tr><td>25-49</td><td>\$201.94</td></tr> <tr><td>50-99</td><td>\$191.31</td></tr> <tr><td>NEW 100+</td><td>\$182.81</td></tr> </tbody> </table> <p>2.4mm Female to 2.4mm Female Bulkhead VSWR 1.3:1 to 50 GHz</p> <p>Model No: <a href="#">PE91459</a></p>	PRICE	1-24	\$212.57	25-49	\$201.94	50-99	\$191.31	NEW 100+	\$182.81	 <table border="1"> <thead> <tr><th>PRICE</th></tr> </thead> <tbody> <tr><td>1-9</td><td>\$446.64</td></tr> <tr><td>10-24</td><td>\$424.31</td></tr> <tr><td>25-49</td><td>\$401.98</td></tr> <tr><td>50+</td><td>\$384.11</td></tr> </tbody> </table> <p>2.4mm Female to 2.4mm Female Bulkhead VSWR 1.35:1 to 50 GHz</p> <p>Model No: <a href="#">PE9640</a></p>	PRICE	1-9	\$446.64	10-24	\$424.31	25-49	\$401.98	50+	\$384.11
PRICE																																																		
1-24	\$395.98																																																	
25-49	\$368.26																																																	
50-99	\$340.54																																																	
NEW 100+	\$316.78																																																	
PRICE																																																		
1-24	\$371.81																																																	
25-49	\$345.78																																																	
50-99	\$319.76																																																	
NEW 100+	\$297.45																																																	
PRICE																																																		
1-9	\$215.40																																																	
10-24	\$204.63																																																	
25-49	\$193.86																																																	
50+	\$185.24																																																	
PRICE																																																		
1-24	\$212.57																																																	
25-49	\$201.94																																																	
50-99	\$191.31																																																	
NEW 100+	\$182.81																																																	
PRICE																																																		
1-9	\$446.64																																																	
10-24	\$424.31																																																	
25-49	\$401.98																																																	
50+	\$384.11																																																	
2	 <table border="1"> <thead> <tr><th>PRICE</th></tr> </thead> <tbody> <tr><td>1-24</td><td>\$352.63</td></tr> <tr><td>25-49</td><td>\$327.95</td></tr> <tr><td>50-99</td><td>\$303.26</td></tr> <tr><td>NEW 100+</td><td>\$282.10</td></tr> </tbody> </table> <p>2.4mm Female to 2.4mm Female Miter Right Angle VSWR 1.35:1 to 50 GHz</p> <p>Model No: <a href="#">PE91529</a></p>	PRICE	1-24	\$352.63	25-49	\$327.95	50-99	\$303.26	NEW 100+	\$282.10	<p><b>2.4mm Between Series</b></p> <p>→</p>		 <table border="1"> <thead> <tr><th>PRICE</th></tr> </thead> <tbody> <tr><td>1-4</td><td>\$651.58</td></tr> <tr><td>5-9</td><td>\$619.00</td></tr> <tr><td>10-24</td><td>\$586.42</td></tr> <tr><td>25+</td><td>\$560.36</td></tr> </tbody> </table> <p>2.4mm Male to 1.85mm Male VSWR 1.3:1 to 50 GHz</p> <p>Model No: <a href="#">PE9672</a></p>	PRICE	1-4	\$651.58	5-9	\$619.00	10-24	\$586.42	25+	\$560.36	 <table border="1"> <thead> <tr><th>PRICE</th></tr> </thead> <tbody> <tr><td>1-4</td><td>\$342.67</td></tr> <tr><td>5-9</td><td>\$325.54</td></tr> <tr><td>10-24</td><td>\$308.40</td></tr> <tr><td>NEW 25+</td><td>\$294.70</td></tr> </tbody> </table> <p>2.4mm Male to 1.85mm Male VSWR 1.3:1 to 50 GHz</p> <p>Model No: <a href="#">PE91540</a></p>	PRICE	1-4	\$342.67	5-9	\$325.54	10-24	\$308.40	NEW 25+	\$294.70	 <table border="1"> <thead> <tr><th>PRICE</th></tr> </thead> <tbody> <tr><td>1-9</td><td>\$389.03</td></tr> <tr><td>10-24</td><td>\$369.58</td></tr> <tr><td>25-49</td><td>\$350.13</td></tr> <tr><td>50+</td><td>\$334.57</td></tr> </tbody> </table> <p>2.4mm Male to 1.85mm Female VSWR 1.3:1 to 50 GHz</p> <p>Model No: <a href="#">PE9674</a></p>	PRICE	1-9	\$389.03	10-24	\$369.58	25-49	\$350.13	50+	\$334.57								
PRICE																																																		
1-24	\$352.63																																																	
25-49	\$327.95																																																	
50-99	\$303.26																																																	
NEW 100+	\$282.10																																																	
PRICE																																																		
1-4	\$651.58																																																	
5-9	\$619.00																																																	
10-24	\$586.42																																																	
25+	\$560.36																																																	
PRICE																																																		
1-4	\$342.67																																																	
5-9	\$325.54																																																	
10-24	\$308.40																																																	
NEW 25+	\$294.70																																																	
PRICE																																																		
1-9	\$389.03																																																	
10-24	\$369.58																																																	
25-49	\$350.13																																																	
50+	\$334.57																																																	
3	 <table border="1"> <thead> <tr><th>PRICE</th></tr> </thead> <tbody> <tr><td>1-24</td><td>\$425.47</td></tr> <tr><td>25-49</td><td>\$395.69</td></tr> <tr><td>50-99</td><td>\$365.90</td></tr> <tr><td>100+</td><td>\$340.38</td></tr> </tbody> </table> <p>2.4mm Male to 2.92mm Male Miter Right Angle VSWR 1.25:1 to 40 GHz</p> <p>Model No: <a href="#">PE91508</a></p>	PRICE	1-24	\$425.47	25-49	\$395.69	50-99	\$365.90	100+	\$340.38	 <table border="1"> <thead> <tr><th>PRICE</th></tr> </thead> <tbody> <tr><td>1-24</td><td>\$327.24</td></tr> <tr><td>25-49</td><td>\$304.33</td></tr> <tr><td>50-99</td><td>\$281.43</td></tr> <tr><td>100+</td><td>\$261.79</td></tr> </tbody> </table> <p>2.4mm Male to 2.92mm Female Miter Right Angle VSWR 1.25:1 to 40 GHz</p> <p>Model No: <a href="#">PE91502</a></p>	PRICE	1-24	\$327.24	25-49	\$304.33	50-99	\$281.43	100+	\$261.79	 <table border="1"> <thead> <tr><th>PRICE</th></tr> </thead> <tbody> <tr><td>1-4</td><td>\$760.36</td></tr> <tr><td>5-9</td><td>\$722.34</td></tr> <tr><td>10-24</td><td>\$684.32</td></tr> <tr><td>25+</td><td>\$653.91</td></tr> </tbody> </table> <p>2.4mm Male to 7mm Sexless VSWR 1.1:1 to 18 GHz</p> <p>Model No: <a href="#">PE9458</a></p>	PRICE	1-4	\$760.36	5-9	\$722.34	10-24	\$684.32	25+	\$653.91	 <table border="1"> <thead> <tr><th>PRICE</th></tr> </thead> <tbody> <tr><td>1-9</td><td>\$319.50</td></tr> <tr><td>10-24</td><td>\$303.53</td></tr> <tr><td>25-49</td><td>\$287.55</td></tr> <tr><td>50+</td><td>\$274.77</td></tr> </tbody> </table> <p>2.4mm Male to Full Detent Mini SMP Male VSWR 1.25:1 to 50 GHz</p> <p>Model No: <a href="#">PE91121</a></p>	PRICE	1-9	\$319.50	10-24	\$303.53	25-49	\$287.55	50+	\$274.77	 <table border="1"> <thead> <tr><th>PRICE</th></tr> </thead> <tbody> <tr><td>1-9</td><td>\$226.49</td></tr> <tr><td>10-24</td><td>\$215.17</td></tr> <tr><td>25-49</td><td>\$203.84</td></tr> <tr><td>PRECISION 50+</td><td>\$194.78</td></tr> </tbody> </table> <p>2.4mm Male to N Male VSWR 1.15:1 to 18 GHz</p> <p>Model No: <a href="#">PE9504</a></p>	PRICE	1-9	\$226.49	10-24	\$215.17	25-49	\$203.84	PRECISION 50+	\$194.78
PRICE																																																		
1-24	\$425.47																																																	
25-49	\$395.69																																																	
50-99	\$365.90																																																	
100+	\$340.38																																																	
PRICE																																																		
1-24	\$327.24																																																	
25-49	\$304.33																																																	
50-99	\$281.43																																																	
100+	\$261.79																																																	
PRICE																																																		
1-4	\$760.36																																																	
5-9	\$722.34																																																	
10-24	\$684.32																																																	
25+	\$653.91																																																	
PRICE																																																		
1-9	\$319.50																																																	
10-24	\$303.53																																																	
25-49	\$287.55																																																	
50+	\$274.77																																																	
PRICE																																																		
1-9	\$226.49																																																	
10-24	\$215.17																																																	
25-49	\$203.84																																																	
PRECISION 50+	\$194.78																																																	
4	 <table border="1"> <thead> <tr><th>PRICE</th></tr> </thead> <tbody> <tr><td>1-9</td><td>\$254.58</td></tr> <tr><td>10-24</td><td>\$241.85</td></tr> <tr><td>25-49</td><td>\$229.12</td></tr> <tr><td>PRECISION 50+</td><td>\$218.94</td></tr> </tbody> </table> <p>2.4mm Male to N Female VSWR 1.15:1 to 18 GHz</p> <p>Model No: <a href="#">PE9501</a></p>	PRICE	1-9	\$254.58	10-24	\$241.85	25-49	\$229.12	PRECISION 50+	\$218.94	 <table border="1"> <thead> <tr><th>PRICE</th></tr> </thead> <tbody> <tr><td>1-4</td><td>\$615.97</td></tr> <tr><td>5-9</td><td>\$585.17</td></tr> <tr><td>10-24</td><td>\$554.37</td></tr> <tr><td>25+</td><td>\$529.73</td></tr> </tbody> </table> <p>2.4mm Female to 1.85mm Male VSWR 1.3:1 to 50 GHz</p> <p>Model No: <a href="#">PE9673</a></p>	PRICE	1-4	\$615.97	5-9	\$585.17	10-24	\$554.37	25+	\$529.73	 <table border="1"> <thead> <tr><th>PRICE</th></tr> </thead> <tbody> <tr><td>1-4</td><td>\$342.67</td></tr> <tr><td>5-9</td><td>\$325.54</td></tr> <tr><td>10-24</td><td>\$308.40</td></tr> <tr><td>PRECISION NEW 25+</td><td>\$294.70</td></tr> </tbody> </table> <p>2.4mm Female to 1.85mm Male VSWR 1.3:1 to 50 GHz</p> <p>Model No: <a href="#">PE91542</a></p>	PRICE	1-4	\$342.67	5-9	\$325.54	10-24	\$308.40	PRECISION NEW 25+	\$294.70	 <table border="1"> <thead> <tr><th>PRICE</th></tr> </thead> <tbody> <tr><td>1-4</td><td>\$566.37</td></tr> <tr><td>5-9</td><td>\$538.05</td></tr> <tr><td>10-24</td><td>\$509.73</td></tr> <tr><td>25+</td><td>\$487.08</td></tr> </tbody> </table> <p>2.4mm Female to 1.85mm Female VSWR 1.3:1 to 50 GHz</p> <p>Model No: <a href="#">PE9675</a></p>	PRICE	1-4	\$566.37	5-9	\$538.05	10-24	\$509.73	25+	\$487.08	 <table border="1"> <thead> <tr><th>PRICE</th></tr> </thead> <tbody> <tr><td>1-24</td><td>\$332.91</td></tr> <tr><td>25-49</td><td>\$309.61</td></tr> <tr><td>50-99</td><td>\$286.30</td></tr> <tr><td>NEW 100+</td><td>\$266.33</td></tr> </tbody> </table> <p>2.4mm Female to 2.92mm Male Miter Right Angle VSWR 1.25:1 to 40 GHz</p> <p>Model No: <a href="#">PE91526</a></p>	PRICE	1-24	\$332.91	25-49	\$309.61	50-99	\$286.30	NEW 100+	\$266.33
PRICE																																																		
1-9	\$254.58																																																	
10-24	\$241.85																																																	
25-49	\$229.12																																																	
PRECISION 50+	\$218.94																																																	
PRICE																																																		
1-4	\$615.97																																																	
5-9	\$585.17																																																	
10-24	\$554.37																																																	
25+	\$529.73																																																	
PRICE																																																		
1-4	\$342.67																																																	
5-9	\$325.54																																																	
10-24	\$308.40																																																	
PRECISION NEW 25+	\$294.70																																																	
PRICE																																																		
1-4	\$566.37																																																	
5-9	\$538.05																																																	
10-24	\$509.73																																																	
25+	\$487.08																																																	
PRICE																																																		
1-24	\$332.91																																																	
25-49	\$309.61																																																	
50-99	\$286.30																																																	
NEW 100+	\$266.33																																																	
5	 <table border="1"> <thead> <tr><th>PRICE</th></tr> </thead> <tbody> <tr><td>1-24</td><td>\$415.05</td></tr> <tr><td>25-49</td><td>\$386.00</td></tr> <tr><td>50-99</td><td>\$356.94</td></tr> <tr><td>NEW 100+</td><td>\$332.04</td></tr> </tbody> </table> <p>2.4mm Female to 2.92mm Female Right Angle VSWR 1.3:1 to 40 GHz</p> <p>Model No: <a href="#">PE91111</a></p>	PRICE	1-24	\$415.05	25-49	\$386.00	50-99	\$356.94	NEW 100+	\$332.04	 <table border="1"> <thead> <tr><th>PRICE</th></tr> </thead> <tbody> <tr><td>1-24</td><td>\$366.09</td></tr> <tr><td>25-49</td><td>\$340.46</td></tr> <tr><td>50-99</td><td>\$314.84</td></tr> <tr><td>NEW 100+</td><td>\$292.87</td></tr> </tbody> </table> <p>2.4mm Female to 2.92mm Female Miter Right Angle VSWR 1.25:1 to 40 GHz</p> <p>Model No: <a href="#">PE91525</a></p>	PRICE	1-24	\$366.09	25-49	\$340.46	50-99	\$314.84	NEW 100+	\$292.87	 <table border="1"> <thead> <tr><th>PRICE</th></tr> </thead> <tbody> <tr><td>1-9</td><td>\$307.91</td></tr> <tr><td>10-24</td><td>\$292.51</td></tr> <tr><td>25-49</td><td>\$277.12</td></tr> <tr><td>50+</td><td>\$264.80</td></tr> </tbody> </table> <p>2.4mm Female to Full Detent Mini SMP Male VSWR 1.25:1 to 50 GHz</p> <p>Model No: <a href="#">PE91122</a></p>	PRICE	1-9	\$307.91	10-24	\$292.51	25-49	\$277.12	50+	\$264.80	 <table border="1"> <thead> <tr><th>PRICE</th></tr> </thead> <tbody> <tr><td>1-9</td><td>\$289.51</td></tr> <tr><td>10-24</td><td>\$275.03</td></tr> <tr><td>25-49</td><td>\$260.56</td></tr> <tr><td>50+</td><td>\$248.98</td></tr> </tbody> </table> <p>2.4mm Female to Mini SMP Female VSWR 1.25:1 to 50 GHz</p> <p>Model No: <a href="#">PE91123</a></p>	PRICE	1-9	\$289.51	10-24	\$275.03	25-49	\$260.56	50+	\$248.98	 <table border="1"> <thead> <tr><th>PRICE</th></tr> </thead> <tbody> <tr><td>1-9</td><td>\$239.96</td></tr> <tr><td>10-24</td><td>\$227.96</td></tr> <tr><td>25-49</td><td>\$215.96</td></tr> <tr><td>PRECISION 50+</td><td>\$206.37</td></tr> </tbody> </table> <p>2.4mm Female to N Male VSWR 1.15:1 to 18 GHz</p> <p>Model No: <a href="#">PE9503</a></p>	PRICE	1-9	\$239.96	10-24	\$227.96	25-49	\$215.96	PRECISION 50+	\$206.37
PRICE																																																		
1-24	\$415.05																																																	
25-49	\$386.00																																																	
50-99	\$356.94																																																	
NEW 100+	\$332.04																																																	
PRICE																																																		
1-24	\$366.09																																																	
25-49	\$340.46																																																	
50-99	\$314.84																																																	
NEW 100+	\$292.87																																																	
PRICE																																																		
1-9	\$307.91																																																	
10-24	\$292.51																																																	
25-49	\$277.12																																																	
50+	\$264.80																																																	
PRICE																																																		
1-9	\$289.51																																																	
10-24	\$275.03																																																	
25-49	\$260.56																																																	
50+	\$248.98																																																	
PRICE																																																		
1-9	\$239.96																																																	
10-24	\$227.96																																																	
25-49	\$215.96																																																	
PRECISION 50+	\$206.37																																																	
6	 <table border="1"> <thead> <tr><th>PRICE</th></tr> </thead> <tbody> <tr><td>1-9</td><td>\$231.78</td></tr> <tr><td>10-24</td><td>\$220.19</td></tr> <tr><td>25-49</td><td>\$208.60</td></tr> <tr><td>PRECISION 50+</td><td>\$199.33</td></tr> </tbody> </table> <p>2.4mm Female to N Female VSWR 1.15:1 to 18 GHz</p> <p>Model No: <a href="#">PE9502</a></p>	PRICE	1-9	\$231.78	10-24	\$220.19	25-49	\$208.60	PRECISION 50+	\$199.33	 <table border="1"> <thead> <tr><th>PRICE</th></tr> </thead> <tbody> <tr><td>1-9</td><td>\$291.84</td></tr> <tr><td>10-24</td><td>\$277.25</td></tr> <tr><td>25-49</td><td>\$262.66</td></tr> <tr><td>50+</td><td>\$250.98</td></tr> </tbody> </table> <p>2.4mm Female to SMP Male VSWR 1.25:1 to 40 GHz</p> <p>Model No: <a href="#">PE91048</a></p>	PRICE	1-9	\$291.84	10-24	\$277.25	25-49	\$262.66	50+	\$250.98	 <table border="1"> <thead> <tr><th>PRICE</th></tr> </thead> <tbody> <tr><td>1-9</td><td>\$338.79</td></tr> <tr><td>10-24</td><td>\$321.85</td></tr> <tr><td>25-49</td><td>\$304.91</td></tr> <tr><td>50+</td><td>\$291.36</td></tr> </tbody> </table> <p>2.4mm Female to SMP Female VSWR 1.25:1 to 40 GHz</p> <p>Model No: <a href="#">PE91055</a></p>	PRICE	1-9	\$338.79	10-24	\$321.85	25-49	\$304.91	50+	\$291.36	<p><b>2.4mm NMD Between Series</b></p> <p>→</p>		 <table border="1"> <thead> <tr><th>PRICE</th></tr> </thead> <tbody> <tr><td>1-9</td><td>\$361.09</td></tr> <tr><td>10-24</td><td>\$343.04</td></tr> <tr><td>25-49</td><td>\$324.98</td></tr> <tr><td>50+</td><td>\$310.54</td></tr> </tbody> </table> <p>2.4mm NMD Female to 2.4mm Female Max. Freq. 50 GHz</p> <p>Model No: <a href="#">PE91145</a></p>	PRICE	1-9	\$361.09	10-24	\$343.04	25-49	\$324.98	50+	\$310.54								
PRICE																																																		
1-9	\$231.78																																																	
10-24	\$220.19																																																	
25-49	\$208.60																																																	
PRECISION 50+	\$199.33																																																	
PRICE																																																		
1-9	\$291.84																																																	
10-24	\$277.25																																																	
25-49	\$262.66																																																	
50+	\$250.98																																																	
PRICE																																																		
1-9	\$338.79																																																	
10-24	\$321.85																																																	
25-49	\$304.91																																																	
50+	\$291.36																																																	
PRICE																																																		
1-9	\$361.09																																																	
10-24	\$343.04																																																	
25-49	\$324.98																																																	
50+	\$310.54																																																	
7	 <table border="1"> <thead> <tr><th>PRICE</th></tr> </thead> <tbody> <tr><td>1-9</td><td>\$320.89</td></tr> <tr><td>10-24</td><td>\$304.85</td></tr> <tr><td>25-49</td><td>\$288.80</td></tr> <tr><td>Ruggedized 50+</td><td>\$275.97</td></tr> </tbody> </table> <p>2.4mm NMD Female to SMA Female VSWR 1.2:1 to 27 GHz</p> <p>Model No: <a href="#">PE91146</a></p>	PRICE	1-9	\$320.89	10-24	\$304.85	25-49	\$288.80	Ruggedized 50+	\$275.97	<p><b>2.92mm In-Series</b></p> <p>→</p>		 <table border="1"> <thead> <tr><th>PRICE</th></tr> </thead> <tbody> <tr><td>1-9</td><td>\$196.26</td></tr> <tr><td>10-24</td><td>\$186.45</td></tr> <tr><td>25-49</td><td>\$176.63</td></tr> <tr><td>50+</td><td>\$168.78</td></tr> </tbody> </table> <p>2.92mm Male to 2.92mm Male VSWR 1.25:1 to 40 GHz</p> <p>Model No: <a href="#">PE9436</a></p>	PRICE	1-9	\$196.26	10-24	\$186.45	25-49	\$176.63	50+	\$168.78	 <table border="1"> <thead> <tr><th>PRICE</th></tr> </thead> <tbody> <tr><td>1-9</td><td>\$308.68</td></tr> <tr><td>10-24</td><td>\$293.25</td></tr> <tr><td>25-49</td><td>\$277.81</td></tr> <tr><td>NEW 50+</td><td>\$265.46</td></tr> </tbody> </table> <p>2.92mm Male to 2.92mm Male Miter Right Angle VSWR 1.25:1 to 40 GHz</p> <p>Model No: <a href="#">PE91516</a></p>	PRICE	1-9	\$308.68	10-24	\$293.25	25-49	\$277.81	NEW 50+	\$265.46	 <table border="1"> <thead> <tr><th>PRICE</th></tr> </thead> <tbody> <tr><td>1-9</td><td>\$202.89</td></tr> <tr><td>10-24</td><td>\$192.75</td></tr> <tr><td>25-49</td><td>\$182.60</td></tr> <tr><td>50+</td><td>\$174.49</td></tr> </tbody> </table> <p>2.92mm Male to 2.92mm Female VSWR 1.25:1 to 40 GHz</p> <p>Model No: <a href="#">PE9437</a></p>	PRICE	1-9	\$202.89	10-24	\$192.75	25-49	\$182.60	50+	\$174.49								
PRICE																																																		
1-9	\$320.89																																																	
10-24	\$304.85																																																	
25-49	\$288.80																																																	
Ruggedized 50+	\$275.97																																																	
PRICE																																																		
1-9	\$196.26																																																	
10-24	\$186.45																																																	
25-49	\$176.63																																																	
50+	\$168.78																																																	
PRICE																																																		
1-9	\$308.68																																																	
10-24	\$293.25																																																	
25-49	\$277.81																																																	
NEW 50+	\$265.46																																																	
PRICE																																																		
1-9	\$202.89																																																	
10-24	\$192.75																																																	
25-49	\$182.60																																																	
50+	\$174.49																																																	



Technical Support  
+1 (949) 261-1920



Same-Day Shipping,  
Even Custom Cable Assemblies

# ADAPTERS

See Adapter Locator on Pages 10-15

See Page 409 for Mounting Holes

Adapters

See Our Website For Current Pricing & Real-Time Stock Availability!

	A	B	C	D	E																																																		
1	 <table border="1"> <thead> <tr><th colspan="2">PRICE</th></tr> </thead> <tbody> <tr><td>1-9</td><td>\$230.76</td></tr> <tr><td>10-24</td><td>\$219.22</td></tr> <tr><td>25-49</td><td>\$207.68</td></tr> <tr><td>NEW 50+</td><td>\$198.45</td></tr> </tbody> </table> <p>2.92mm Male to 2.92mm Female Miter Right Angle VSWR 1.25:1 to 40 GHz</p> <p>Model No: <a href="#">PE91503</a></p>	PRICE		1-9	\$230.76	10-24	\$219.22	25-49	\$207.68	NEW 50+	\$198.45	 <table border="1"> <thead> <tr><th colspan="2">PRICE</th></tr> </thead> <tbody> <tr><td>1-24</td><td>\$76.40</td></tr> <tr><td>25-49</td><td>\$72.58</td></tr> <tr><td>50-99</td><td>\$68.76</td></tr> <tr><td>100+</td><td>\$65.70</td></tr> </tbody> </table> <p>2.92mm Female to 2.92mm Female VSWR 1.25:1 to 40 GHz</p> <p>Model No: <a href="#">PE91510</a></p>	PRICE		1-24	\$76.40	25-49	\$72.58	50-99	\$68.76	100+	\$65.70	 <table border="1"> <thead> <tr><th colspan="2">PRICE</th></tr> </thead> <tbody> <tr><td>1-9</td><td>\$210.58</td></tr> <tr><td>10-24</td><td>\$200.05</td></tr> <tr><td>25-49</td><td>\$189.52</td></tr> <tr><td>50+</td><td>\$181.10</td></tr> </tbody> </table> <p>2.92mm Female to 2.92mm Female VSWR 1.25:1 to 40 GHz</p> <p>Model No: <a href="#">PE9438</a></p>	PRICE		1-9	\$210.58	10-24	\$200.05	25-49	\$189.52	50+	\$181.10	 <table border="1"> <thead> <tr><th colspan="2">PRICE</th></tr> </thead> <tbody> <tr><td>1-9</td><td>\$315.69</td></tr> <tr><td>10-24</td><td>\$299.91</td></tr> <tr><td>25-49</td><td>\$284.12</td></tr> <tr><td>NEW 50+</td><td>\$271.49</td></tr> </tbody> </table> <p>2.92mm Female to 2.92mm Female Miter Right Angle VSWR 1.25:1 to 40 GHz</p> <p>Model No: <a href="#">PE91517</a></p>	PRICE		1-9	\$315.69	10-24	\$299.91	25-49	\$284.12	NEW 50+	\$271.49	 <table border="1"> <thead> <tr><th colspan="2">PRICE</th></tr> </thead> <tbody> <tr><td>1-9</td><td>\$134.89</td></tr> <tr><td>10-24</td><td>\$128.15</td></tr> <tr><td>25-49</td><td>\$121.40</td></tr> <tr><td>50+</td><td>\$116.01</td></tr> </tbody> </table> <p>2.92mm Female to 2.92mm Female Bulkhead-Mounting Hole B02 VSWR 1.25:1 to 40 GHz</p> <p>Model No: <a href="#">PE9647</a></p>	PRICE		1-9	\$134.89	10-24	\$128.15	25-49	\$121.40	50+	\$116.01
	PRICE																																																						
1-9	\$230.76																																																						
10-24	\$219.22																																																						
25-49	\$207.68																																																						
NEW 50+	\$198.45																																																						
PRICE																																																							
1-24	\$76.40																																																						
25-49	\$72.58																																																						
50-99	\$68.76																																																						
100+	\$65.70																																																						
PRICE																																																							
1-9	\$210.58																																																						
10-24	\$200.05																																																						
25-49	\$189.52																																																						
50+	\$181.10																																																						
PRICE																																																							
1-9	\$315.69																																																						
10-24	\$299.91																																																						
25-49	\$284.12																																																						
NEW 50+	\$271.49																																																						
PRICE																																																							
1-9	\$134.89																																																						
10-24	\$128.15																																																						
25-49	\$121.40																																																						
50+	\$116.01																																																						
2	 <table border="1"> <thead> <tr><th colspan="2">PRICE</th></tr> </thead> <tbody> <tr><td>1-24</td><td>\$101.61</td></tr> <tr><td>25-49</td><td>\$97.55</td></tr> <tr><td>50-99</td><td>\$94.50</td></tr> <tr><td>100+</td><td>\$92.47</td></tr> </tbody> </table> <p>2.92mm Female to 2.92mm Female 4 Hole Flange VSWR 1.25:1 to 40 GHz</p> <p>Model No: <a href="#">PE91113</a></p>	PRICE		1-24	\$101.61	25-49	\$97.55	50-99	\$94.50	100+	\$92.47	 <table border="1"> <thead> <tr><th colspan="2">PRICE</th></tr> </thead> <tbody> <tr><td>1-9</td><td>\$238.58</td></tr> <tr><td>10-24</td><td>\$226.65</td></tr> <tr><td>25-49</td><td>\$214.72</td></tr> <tr><td>50+</td><td>\$205.18</td></tr> </tbody> </table> <p>2.92mm Female to 2.92mm Female 4 Hole Flange VSWR 1.35:1 to 40 GHz</p> <p>Model No: <a href="#">PE9648</a></p>	PRICE		1-9	\$238.58	10-24	\$226.65	25-49	\$214.72	50+	\$205.18	 <table border="1"> <thead> <tr><th colspan="2">PRICE</th></tr> </thead> <tbody> <tr><td>1-24</td><td>\$103.35</td></tr> <tr><td>25-49</td><td>\$99.22</td></tr> <tr><td>50-99</td><td>\$96.12</td></tr> <tr><td>NEW 100+</td><td>\$94.05</td></tr> </tbody> </table> <p>2.92mm Female to 2.92mm Female 4 Hole Flange VSWR 1.25:1 to 40 GHz</p> <p>Model No: <a href="#">PE91538</a></p>	PRICE		1-24	\$103.35	25-49	\$99.22	50-99	\$96.12	NEW 100+	\$94.05	<p><b>2.92mm Between Series</b></p> <p>→</p>		 <table border="1"> <thead> <tr><th colspan="2">PRICE</th></tr> </thead> <tbody> <tr><td>1-4</td><td>\$542.25</td></tr> <tr><td>5-9</td><td>\$515.14</td></tr> <tr><td>10-24</td><td>\$488.03</td></tr> <tr><td>25+</td><td>\$466.34</td></tr> </tbody> </table> <p>2.92mm Male to 1.85mm Male VSWR 1.25:1 to 40 GHz</p> <p>Model No: <a href="#">PE9667</a></p>	PRICE		1-4	\$542.25	5-9	\$515.14	10-24	\$488.03	25+	\$466.34									
	PRICE																																																						
1-24	\$101.61																																																						
25-49	\$97.55																																																						
50-99	\$94.50																																																						
100+	\$92.47																																																						
PRICE																																																							
1-9	\$238.58																																																						
10-24	\$226.65																																																						
25-49	\$214.72																																																						
50+	\$205.18																																																						
PRICE																																																							
1-24	\$103.35																																																						
25-49	\$99.22																																																						
50-99	\$96.12																																																						
NEW 100+	\$94.05																																																						
PRICE																																																							
1-4	\$542.25																																																						
5-9	\$515.14																																																						
10-24	\$488.03																																																						
25+	\$466.34																																																						
3	 <table border="1"> <thead> <tr><th colspan="2">PRICE</th></tr> </thead> <tbody> <tr><td>1-4</td><td>\$577.50</td></tr> <tr><td>5-9</td><td>\$548.63</td></tr> <tr><td>10-24</td><td>\$519.75</td></tr> <tr><td>25+</td><td>\$496.65</td></tr> </tbody> </table> <p>2.92mm Male to 1.85mm Female VSWR 1.25:1 to 40 GHz</p> <p>Model No: <a href="#">PE9666</a></p>	PRICE		1-4	\$577.50	5-9	\$548.63	10-24	\$519.75	25+	\$496.65	 <table border="1"> <thead> <tr><th colspan="2">PRICE</th></tr> </thead> <tbody> <tr><td>1-9</td><td>\$242.99</td></tr> <tr><td>10-24</td><td>\$230.84</td></tr> <tr><td>25-49</td><td>\$218.69</td></tr> <tr><td>50+</td><td>\$208.97</td></tr> </tbody> </table> <p>2.92mm Male to 2.4mm Male VSWR 1.15:1 to 40 GHz</p> <p>Model No: <a href="#">PE91298</a></p>	PRICE		1-9	\$242.99	10-24	\$230.84	25-49	\$218.69	50+	\$208.97	 <table border="1"> <thead> <tr><th colspan="2">PRICE</th></tr> </thead> <tbody> <tr><td>1-9</td><td>\$180.43</td></tr> <tr><td>10-24</td><td>\$171.41</td></tr> <tr><td>25-49</td><td>\$162.39</td></tr> <tr><td>50+</td><td>\$155.17</td></tr> </tbody> </table> <p>2.92mm Male to 2.4mm Male VSWR 1.3:1 to 40 GHz</p> <p>Model No: <a href="#">PE9457</a></p>	PRICE		1-9	\$180.43	10-24	\$171.41	25-49	\$162.39	50+	\$155.17	 <table border="1"> <thead> <tr><th colspan="2">PRICE</th></tr> </thead> <tbody> <tr><td>1-9</td><td>\$237.13</td></tr> <tr><td>10-24</td><td>\$225.27</td></tr> <tr><td>25-49</td><td>\$213.42</td></tr> <tr><td>50+</td><td>\$203.93</td></tr> </tbody> </table> <p>2.92mm Male to 2.4mm Female VSWR 1.25:1 to 40 GHz</p> <p>Model No: <a href="#">PE91450</a></p>	PRICE		1-9	\$237.13	10-24	\$225.27	25-49	\$213.42	50+	\$203.93	 <table border="1"> <thead> <tr><th colspan="2">PRICE</th></tr> </thead> <tbody> <tr><td>1-9</td><td>\$149.76</td></tr> <tr><td>10-24</td><td>\$142.27</td></tr> <tr><td>25-49</td><td>\$134.78</td></tr> <tr><td>50+</td><td>\$128.79</td></tr> </tbody> </table> <p>2.92mm Male to 2.4mm Female VSWR 1.3:1 to 40 GHz</p> <p>Model No: <a href="#">PE9455</a></p>	PRICE		1-9	\$149.76	10-24	\$142.27	25-49	\$134.78	50+	\$128.79
	PRICE																																																						
1-4	\$577.50																																																						
5-9	\$548.63																																																						
10-24	\$519.75																																																						
25+	\$496.65																																																						
PRICE																																																							
1-9	\$242.99																																																						
10-24	\$230.84																																																						
25-49	\$218.69																																																						
50+	\$208.97																																																						
PRICE																																																							
1-9	\$180.43																																																						
10-24	\$171.41																																																						
25-49	\$162.39																																																						
50+	\$155.17																																																						
PRICE																																																							
1-9	\$237.13																																																						
10-24	\$225.27																																																						
25-49	\$213.42																																																						
50+	\$203.93																																																						
PRICE																																																							
1-9	\$149.76																																																						
10-24	\$142.27																																																						
25-49	\$134.78																																																						
50+	\$128.79																																																						
4	 <table border="1"> <thead> <tr><th colspan="2">PRICE</th></tr> </thead> <tbody> <tr><td>1-9</td><td>\$331.98</td></tr> <tr><td>10-24</td><td>\$318.70</td></tr> <tr><td>25-49</td><td>\$308.74</td></tr> <tr><td>50+</td><td>\$302.10</td></tr> </tbody> </table> <p>2.92mm Male to 2.92mm Female Radius Right Angle VSWR 1.5:1 to 40 GHz</p> <p>Model No: <a href="#">PE91070</a></p>	PRICE		1-9	\$331.98	10-24	\$318.70	25-49	\$308.74	50+	\$302.10	 <table border="1"> <thead> <tr><th colspan="2">PRICE</th></tr> </thead> <tbody> <tr><td>1-24</td><td>\$263.92</td></tr> <tr><td>25-49</td><td>\$245.45</td></tr> <tr><td>50-99</td><td>\$226.97</td></tr> <tr><td>100+</td><td>\$211.14</td></tr> </tbody> </table> <p>2.92mm Male to 3.5mm Male Right Angle VSWR 1.25:1 to 34.5 GHz</p> <p>Model No: <a href="#">PE91165</a></p>	PRICE		1-24	\$263.92	25-49	\$245.45	50-99	\$226.97	100+	\$211.14	 <table border="1"> <thead> <tr><th colspan="2">PRICE</th></tr> </thead> <tbody> <tr><td>1-9</td><td>\$234.28</td></tr> <tr><td>10-24</td><td>\$222.57</td></tr> <tr><td>25-49</td><td>\$210.85</td></tr> <tr><td>NEW 50+</td><td>\$201.48</td></tr> </tbody> </table> <p>2.92mm Male to 3.5mm Male Miter Right Angle VSWR 1.25:1 to 34.5 GHz</p> <p>Model No: <a href="#">PE91522</a></p>	PRICE		1-9	\$234.28	10-24	\$222.57	25-49	\$210.85	NEW 50+	\$201.48	 <table border="1"> <thead> <tr><th colspan="2">PRICE</th></tr> </thead> <tbody> <tr><td>1-24</td><td>\$263.92</td></tr> <tr><td>25-49</td><td>\$245.45</td></tr> <tr><td>50-99</td><td>\$226.97</td></tr> <tr><td>100+</td><td>\$211.14</td></tr> </tbody> </table> <p>2.92mm Male to 3.5mm Female Right Angle VSWR 1.25:1 to 34.5 GHz</p> <p>Model No: <a href="#">PE91168</a></p>	PRICE		1-24	\$263.92	25-49	\$245.45	50-99	\$226.97	100+	\$211.14	 <table border="1"> <thead> <tr><th colspan="2">PRICE</th></tr> </thead> <tbody> <tr><td>1-24</td><td>\$234.28</td></tr> <tr><td>25-49</td><td>\$217.88</td></tr> <tr><td>50-99</td><td>\$201.48</td></tr> <tr><td>NEW 100+</td><td>\$187.42</td></tr> </tbody> </table> <p>2.92mm Male to 3.5mm Female Miter Right Angle VSWR 1.25:1 to 34.5 GHz</p> <p>Model No: <a href="#">PE91514</a></p>	PRICE		1-24	\$234.28	25-49	\$217.88	50-99	\$201.48	NEW 100+	\$187.42
	PRICE																																																						
1-9	\$331.98																																																						
10-24	\$318.70																																																						
25-49	\$308.74																																																						
50+	\$302.10																																																						
PRICE																																																							
1-24	\$263.92																																																						
25-49	\$245.45																																																						
50-99	\$226.97																																																						
100+	\$211.14																																																						
PRICE																																																							
1-9	\$234.28																																																						
10-24	\$222.57																																																						
25-49	\$210.85																																																						
NEW 50+	\$201.48																																																						
PRICE																																																							
1-24	\$263.92																																																						
25-49	\$245.45																																																						
50-99	\$226.97																																																						
100+	\$211.14																																																						
PRICE																																																							
1-24	\$234.28																																																						
25-49	\$217.88																																																						
50-99	\$201.48																																																						
NEW 100+	\$187.42																																																						
5	 <table border="1"> <thead> <tr><th colspan="2">PRICE</th></tr> </thead> <tbody> <tr><td>1-9</td><td>\$480.81</td></tr> <tr><td>10-24</td><td>\$461.58</td></tr> <tr><td>25-49</td><td>\$447.15</td></tr> <tr><td>50+</td><td>\$437.54</td></tr> </tbody> </table> <p>2.92mm Male to 7mm Sexless VSWR 1.1:1 to 18 GHz</p> <p>Model No: <a href="#">PE9460</a></p>	PRICE		1-9	\$480.81	10-24	\$461.58	25-49	\$447.15	50+	\$437.54	 <table border="1"> <thead> <tr><th colspan="2">PRICE</th></tr> </thead> <tbody> <tr><td>1-9</td><td>\$244.56</td></tr> <tr><td>10-24</td><td>\$234.78</td></tr> <tr><td>25-49</td><td>\$227.44</td></tr> <tr><td>50+</td><td>\$222.55</td></tr> </tbody> </table> <p>2.92mm Male to Mini SMP Male VSWR 1.25:1 to 40 GHz</p> <p>Model No: <a href="#">PE91124</a></p>	PRICE		1-9	\$244.56	10-24	\$234.78	25-49	\$227.44	50+	\$222.55	 <table border="1"> <thead> <tr><th colspan="2">PRICE</th></tr> </thead> <tbody> <tr><td>1-9</td><td>\$245.77</td></tr> <tr><td>10-24</td><td>\$235.94</td></tr> <tr><td>25-49</td><td>\$228.57</td></tr> <tr><td>50+</td><td>\$223.65</td></tr> </tbody> </table> <p>2.92mm Male to Smooth Bore Mini SMP Male VSWR 1.4:1 to 40 GHz</p> <p>Model No: <a href="#">PE91125</a></p>	PRICE		1-9	\$245.77	10-24	\$235.94	25-49	\$228.57	50+	\$223.65	 <table border="1"> <thead> <tr><th colspan="2">PRICE</th></tr> </thead> <tbody> <tr><td>1-9</td><td>\$240.95</td></tr> <tr><td>10-24</td><td>\$231.31</td></tr> <tr><td>25-49</td><td>\$224.08</td></tr> <tr><td>50+</td><td>\$219.26</td></tr> </tbody> </table> <p>2.92mm Male to Mini SMP Female VSWR 1.4:1 to 40 GHz</p> <p>Model No: <a href="#">PE91126</a></p>	PRICE		1-9	\$240.95	10-24	\$231.31	25-49	\$224.08	50+	\$219.26	 <table border="1"> <thead> <tr><th colspan="2">PRICE</th></tr> </thead> <tbody> <tr><td>1-9</td><td>\$257.44</td></tr> <tr><td>10-24</td><td>\$244.57</td></tr> <tr><td>25-49</td><td>\$231.70</td></tr> <tr><td>PRECISION 50+</td><td>\$221.40</td></tr> </tbody> </table> <p>2.92mm Male to N Male VSWR 1.15:1 to 18 GHz</p> <p>Model No: <a href="#">PE9661</a></p>	PRICE		1-9	\$257.44	10-24	\$244.57	25-49	\$231.70	PRECISION 50+	\$221.40
	PRICE																																																						
1-9	\$480.81																																																						
10-24	\$461.58																																																						
25-49	\$447.15																																																						
50+	\$437.54																																																						
PRICE																																																							
1-9	\$244.56																																																						
10-24	\$234.78																																																						
25-49	\$227.44																																																						
50+	\$222.55																																																						
PRICE																																																							
1-9	\$245.77																																																						
10-24	\$235.94																																																						
25-49	\$228.57																																																						
50+	\$223.65																																																						
PRICE																																																							
1-9	\$240.95																																																						
10-24	\$231.31																																																						
25-49	\$224.08																																																						
50+	\$219.26																																																						
PRICE																																																							
1-9	\$257.44																																																						
10-24	\$244.57																																																						
25-49	\$231.70																																																						
PRECISION 50+	\$221.40																																																						
6	 <table border="1"> <thead> <tr><th colspan="2">PRICE</th></tr> </thead> <tbody> <tr><td>1-9</td><td>\$329.98</td></tr> <tr><td>10-24</td><td>\$313.48</td></tr> <tr><td>25-49</td><td>\$296.98</td></tr> <tr><td>PRECISION 50+</td><td>\$283.78</td></tr> </tbody> </table> <p>2.92mm Male to N Female VSWR 1.15:1 to 18 GHz</p> <p>Model No: <a href="#">PE9662</a></p>	PRICE		1-9	\$329.98	10-24	\$313.48	25-49	\$296.98	PRECISION 50+	\$283.78	 <table border="1"> <thead> <tr><th colspan="2">PRICE</th></tr> </thead> <tbody> <tr><td>1-4</td><td>\$651.39</td></tr> <tr><td>5-9</td><td>\$618.82</td></tr> <tr><td>10-24</td><td>\$586.25</td></tr> <tr><td>25+</td><td>\$560.20</td></tr> </tbody> </table> <p>2.92mm Female to 1.85mm Male VSWR 1.25:1 to 40 GHz</p> <p>Model No: <a href="#">PE9665</a></p>	PRICE		1-4	\$651.39	5-9	\$618.82	10-24	\$586.25	25+	\$560.20	 <table border="1"> <thead> <tr><th colspan="2">PRICE</th></tr> </thead> <tbody> <tr><td>1-9</td><td>\$269.57</td></tr> <tr><td>10-24</td><td>\$256.09</td></tr> <tr><td>25-49</td><td>\$242.61</td></tr> <tr><td>50+</td><td>\$231.83</td></tr> </tbody> </table> <p>2.92mm Female to 2.4mm Male VSWR 1.25:1 to 40 GHz</p> <p>Model No: <a href="#">PE91451</a></p>	PRICE		1-9	\$269.57	10-24	\$256.09	25-49	\$242.61	50+	\$231.83	 <table border="1"> <thead> <tr><th colspan="2">PRICE</th></tr> </thead> <tbody> <tr><td>1-9</td><td>\$140.61</td></tr> <tr><td>10-24</td><td>\$133.58</td></tr> <tr><td>25-49</td><td>\$126.55</td></tr> <tr><td>50+</td><td>\$120.92</td></tr> </tbody> </table> <p>2.92mm Female to 2.4mm Male VSWR 1.25:1 to 40 GHz</p> <p>Model No: <a href="#">PE9454</a></p>	PRICE		1-9	\$140.61	10-24	\$133.58	25-49	\$126.55	50+	\$120.92	 <table border="1"> <thead> <tr><th colspan="2">PRICE</th></tr> </thead> <tbody> <tr><td>1-24</td><td>\$252.55</td></tr> <tr><td>25-49</td><td>\$234.87</td></tr> <tr><td>50-99</td><td>\$217.19</td></tr> <tr><td>100+</td><td>\$202.04</td></tr> </tbody> </table> <p>2.92mm Female to 2.4mm Female VSWR 1.2:1 to 40 GHz</p> <p>Model No: <a href="#">PE91499</a></p>	PRICE		1-24	\$252.55	25-49	\$234.87	50-99	\$217.19	100+	\$202.04
	PRICE																																																						
1-9	\$329.98																																																						
10-24	\$313.48																																																						
25-49	\$296.98																																																						
PRECISION 50+	\$283.78																																																						
PRICE																																																							
1-4	\$651.39																																																						
5-9	\$618.82																																																						
10-24	\$586.25																																																						
25+	\$560.20																																																						
PRICE																																																							
1-9	\$269.57																																																						
10-24	\$256.09																																																						
25-49	\$242.61																																																						
50+	\$231.83																																																						
PRICE																																																							
1-9	\$140.61																																																						
10-24	\$133.58																																																						
25-49	\$126.55																																																						
50+	\$120.92																																																						
PRICE																																																							
1-24	\$252.55																																																						
25-49	\$234.87																																																						
50-99	\$217.19																																																						
100+	\$202.04																																																						
7	 <table border="1"> <thead> <tr><th colspan="2">PRICE</th></tr> </thead> <tbody> <tr><td>1-9</td><td>\$164.77</td></tr> <tr><td>10-24</td><td>\$156.53</td></tr> <tr><td>25-49</td><td>\$148.29</td></tr> <tr><td>50+</td><td>\$141.70</td></tr> </tbody> </table> <p>2.92mm Female to 2.4mm Female VSWR 1.3:1 to 40 GHz</p> <p>Model No: <a href="#">PE9456</a></p>	PRICE		1-9	\$164.77	10-24	\$156.53	25-49	\$148.29	50+	\$141.70	 <table border="1"> <thead> <tr><th colspan="2">PRICE</th></tr> </thead> <tbody> <tr><td>1-9</td><td>\$234.28</td></tr> <tr><td>10-24</td><td>\$222.57</td></tr> <tr><td>25-49</td><td>\$210.85</td></tr> <tr><td>NEW 50+</td><td>\$201.48</td></tr> </tbody> </table> <p>2.92mm Female to 3.5mm Male Miter Right Angle VSWR 1.25:1 to 34.5 GHz</p> <p>Model No: <a href="#">PE91520</a></p>	PRICE		1-9	\$234.28	10-24	\$222.57	25-49	\$210.85	NEW 50+	\$201.48	 <table border="1"> <thead> <tr><th colspan="2">PRICE</th></tr> </thead> <tbody> <tr><td>1-9</td><td>\$237.83</td></tr> <tr><td>10-24</td><td>\$225.94</td></tr> <tr><td>25-49</td><td>\$214.05</td></tr> <tr><td>50+</td><td>\$204.53</td></tr> </tbody> </table> <p>2.92mm Female to 3.5mm Female VSWR 1.25:1 to 34 GHz</p> <p>Model No: <a href="#">PE9660</a></p>	PRICE		1-9	\$237.83	10-24	\$225.94	25-49	\$214.05	50+	\$204.53	 <table border="1"> <thead> <tr><th colspan="2">PRICE</th></tr> </thead> <tbody> <tr><td>1-24</td><td>\$235.63</td></tr> <tr><td>25-49</td><td>\$219.14</td></tr> <tr><td>50-99</td><td>\$202.64</td></tr> <tr><td>100+</td><td>\$188.50</td></tr> </tbody> </table> <p>2.92mm Female to 3.5mm Female Right Angle VSWR 1.25:1 to 34.5 GHz</p> <p>Model No: <a href="#">PE91167</a></p>	PRICE		1-24	\$235.63	25-49	\$219.14	50-99	\$202.64	100+	\$188.50	 <table border="1"> <thead> <tr><th colspan="2">PRICE</th></tr> </thead> <tbody> <tr><td>1-9</td><td>\$216.71</td></tr> <tr><td>10-24</td><td>\$205.87</td></tr> <tr><td>25-49</td><td>\$195.04</td></tr> <tr><td>NEW 50+</td><td>\$186.37</td></tr> </tbody> </table> <p>2.92mm Female to 3.5mm Female Miter Right Angle VSWR 1.25:1 to 34.5 GHz</p> <p>Model No: <a href="#">PE91521</a></p>	PRICE		1-9	\$216.71	10-24	\$205.87	25-49	\$195.04	NEW 50+	\$186.37
	PRICE																																																						
1-9	\$164.77																																																						
10-24	\$156.53																																																						
25-49	\$148.29																																																						
50+	\$141.70																																																						
PRICE																																																							
1-9	\$234.28																																																						
10-24	\$222.57																																																						
25-49	\$210.85																																																						
NEW 50+	\$201.48																																																						
PRICE																																																							
1-9	\$237.83																																																						
10-24	\$225.94																																																						
25-49	\$214.05																																																						
50+	\$204.53																																																						
PRICE																																																							
1-24	\$235.63																																																						
25-49	\$219.14																																																						
50-99	\$202.64																																																						
100+	\$188.50																																																						
PRICE																																																							
1-9	\$216.71																																																						
10-24	\$205.87																																																						
25-49	\$195.04																																																						
NEW 50+	\$186.37																																																						

# ADAPTERS

See Adapter Locator on Pages 10-15  
See Page 409 for Mounting Holes

	A	B	C	D	E																									
1	 <table border="1"> <thead> <tr> <th>PRICE</th> </tr> </thead> <tbody> <tr> <td>1-9 \$538.51</td> </tr> <tr> <td>10-24 \$511.58</td> </tr> <tr> <td>25-49 \$484.66</td> </tr> <tr> <td>50+ \$463.12</td> </tr> </tbody> </table> <p>PRECISION 2.92mm Female to 7mm Sexless VSWR 1.1:1 to 18 GHz Model No: <a href="#">PE9461</a></p>	PRICE	1-9 \$538.51	10-24 \$511.58	25-49 \$484.66	50+ \$463.12	 <table border="1"> <thead> <tr> <th>PRICE</th> </tr> </thead> <tbody> <tr> <td>1-9 \$244.56</td> </tr> <tr> <td>10-24 \$234.78</td> </tr> <tr> <td>25-49 \$227.44</td> </tr> <tr> <td>50+ \$222.55</td> </tr> </tbody> </table> <p>2.92mm Female to Full Detent Mini SMP Male VSWR 1.35:1 to 40 GHz Model No: <a href="#">PE91127</a></p>	PRICE	1-9 \$244.56	10-24 \$234.78	25-49 \$227.44	50+ \$222.55	 <table border="1"> <thead> <tr> <th>PRICE</th> </tr> </thead> <tbody> <tr> <td>1-9 \$266.71</td> </tr> <tr> <td>10-24 \$256.04</td> </tr> <tr> <td>25-49 \$248.04</td> </tr> <tr> <td>50+ \$242.71</td> </tr> </tbody> </table> <p>2.92mm Female to Smooth Bore Mini SMP Male VSWR 1.35:1 to 40 GHz Model No: <a href="#">PE91128</a></p>	PRICE	1-9 \$266.71	10-24 \$256.04	25-49 \$248.04	50+ \$242.71	 <table border="1"> <thead> <tr> <th>PRICE</th> </tr> </thead> <tbody> <tr> <td>1-4 \$802.50</td> </tr> <tr> <td>5-9 \$762.38</td> </tr> <tr> <td>10-24 \$722.25</td> </tr> <tr> <td>25+ \$690.15</td> </tr> </tbody> </table> <p>2.92mm Female to Mini SMP Female VSWR 1.3:1 to 40 GHz Model No: <a href="#">PE9782</a></p>	PRICE	1-4 \$802.50	5-9 \$762.38	10-24 \$722.25	25+ \$690.15	 <table border="1"> <thead> <tr> <th>PRICE</th> </tr> </thead> <tbody> <tr> <td>1-9 \$236.33</td> </tr> <tr> <td>10-24 \$224.51</td> </tr> <tr> <td>25-49 \$212.70</td> </tr> <tr> <td>50+ \$203.24</td> </tr> </tbody> </table> <p>PRECISION 2.92mm Female to N Male VSWR 1.15:1 to 18 GHz Model No: <a href="#">PE9663</a></p>	PRICE	1-9 \$236.33	10-24 \$224.51	25-49 \$212.70	50+ \$203.24
PRICE																														
1-9 \$538.51																														
10-24 \$511.58																														
25-49 \$484.66																														
50+ \$463.12																														
PRICE																														
1-9 \$244.56																														
10-24 \$234.78																														
25-49 \$227.44																														
50+ \$222.55																														
PRICE																														
1-9 \$266.71																														
10-24 \$256.04																														
25-49 \$248.04																														
50+ \$242.71																														
PRICE																														
1-4 \$802.50																														
5-9 \$762.38																														
10-24 \$722.25																														
25+ \$690.15																														
PRICE																														
1-9 \$236.33																														
10-24 \$224.51																														
25-49 \$212.70																														
50+ \$203.24																														
2	 <table border="1"> <thead> <tr> <th>PRICE</th> </tr> </thead> <tbody> <tr> <td>1-9 \$222.42</td> </tr> <tr> <td>10-24 \$211.30</td> </tr> <tr> <td>25-49 \$200.18</td> </tr> <tr> <td>50+ \$191.28</td> </tr> </tbody> </table> <p>PRECISION 2.92mm Female to N Female VSWR 1.15:1 to 18 GHz Model No: <a href="#">PE9664</a></p>	PRICE	1-9 \$222.42	10-24 \$211.30	25-49 \$200.18	50+ \$191.28	 <table border="1"> <thead> <tr> <th>PRICE</th> </tr> </thead> <tbody> <tr> <td>1-9 \$216.77</td> </tr> <tr> <td>10-24 \$205.93</td> </tr> <tr> <td>25-49 \$195.09</td> </tr> <tr> <td>50+ \$186.42</td> </tr> </tbody> </table> <p>2.92mm Female to SMP Female VSWR 1.25:1 to 40 GHz Model No: <a href="#">PE91060</a></p>	PRICE	1-9 \$216.77	10-24 \$205.93	25-49 \$195.09	50+ \$186.42	 <table border="1"> <thead> <tr> <th>PRICE</th> </tr> </thead> <tbody> <tr> <td>1-9 \$220.84</td> </tr> <tr> <td>10-24 \$209.80</td> </tr> <tr> <td>25-49 \$198.76</td> </tr> <tr> <td>50+ \$189.92</td> </tr> </tbody> </table> <p>2.92mm Female to SSMA Male VSWR 1.25:1 to 40 GHz Model No: <a href="#">PE9768</a></p>	PRICE	1-9 \$220.84	10-24 \$209.80	25-49 \$198.76	50+ \$189.92	<p><b>2.92mm NMD Between Series</b></p> 		 <table border="1"> <thead> <tr> <th>PRICE</th> </tr> </thead> <tbody> <tr> <td>1-9 \$361.09</td> </tr> <tr> <td>10-24 \$343.04</td> </tr> <tr> <td>25-49 \$324.98</td> </tr> <tr> <td>50+ \$310.54</td> </tr> </tbody> </table> <p>2.92mm NMD Female to 2.4mm Female VSWR 1.35:1 to 40 GHz Model No: <a href="#">PE91144</a></p>	PRICE	1-9 \$361.09	10-24 \$343.04	25-49 \$324.98	50+ \$310.54				
PRICE																														
1-9 \$222.42																														
10-24 \$211.30																														
25-49 \$200.18																														
50+ \$191.28																														
PRICE																														
1-9 \$216.77																														
10-24 \$205.93																														
25-49 \$195.09																														
50+ \$186.42																														
PRICE																														
1-9 \$220.84																														
10-24 \$209.80																														
25-49 \$198.76																														
50+ \$189.92																														
PRICE																														
1-9 \$361.09																														
10-24 \$343.04																														
25-49 \$324.98																														
50+ \$310.54																														
3	<p><b>3.5mm In-Series</b></p> 		 <table border="1"> <thead> <tr> <th>PRICE</th> </tr> </thead> <tbody> <tr> <td>1-9 \$203.89</td> </tr> <tr> <td>10-24 \$193.70</td> </tr> <tr> <td>25-49 \$183.50</td> </tr> <tr> <td>50+ \$175.35</td> </tr> </tbody> </table> <p>3.5mm Male to 3.5mm Male VSWR 1.25:1 to 34.5 GHz Model No: <a href="#">PE9330</a></p>	PRICE	1-9 \$203.89	10-24 \$193.70	25-49 \$183.50	50+ \$175.35	 <table border="1"> <thead> <tr> <th>PRICE</th> </tr> </thead> <tbody> <tr> <td>1-24 \$281.08</td> </tr> <tr> <td>25-49 \$261.40</td> </tr> <tr> <td>50-99 \$241.73</td> </tr> <tr> <td>100+ \$224.86</td> </tr> </tbody> </table> <p>3.5mm Male to 3.5mm Male Right Angle VSWR 1.25:1 to 34.5 GHz Model No: <a href="#">PE91169</a></p>	PRICE	1-24 \$281.08	25-49 \$261.40	50-99 \$241.73	100+ \$224.86	 <table border="1"> <thead> <tr> <th>PRICE</th> </tr> </thead> <tbody> <tr> <td>1-9 \$231.37</td> </tr> <tr> <td>10-24 \$219.80</td> </tr> <tr> <td>25-49 \$208.23</td> </tr> <tr> <td>NEW 50+ \$198.98</td> </tr> </tbody> </table> <p>3.5mm Male to 3.5mm Male Miter Right Angle VSWR 1.35:1 to 34.5 GHz Model No: <a href="#">PE91515</a></p>	PRICE	1-9 \$231.37	10-24 \$219.80	25-49 \$208.23	NEW 50+ \$198.98	 <table border="1"> <thead> <tr> <th>PRICE</th> </tr> </thead> <tbody> <tr> <td>1-9 \$203.89</td> </tr> <tr> <td>10-24 \$193.70</td> </tr> <tr> <td>25-49 \$183.50</td> </tr> <tr> <td>50+ \$175.35</td> </tr> </tbody> </table> <p>3.5mm Male to 3.5mm Female VSWR 1.25:1 to 34.5 GHz Model No: <a href="#">PE9332</a></p>	PRICE	1-9 \$203.89	10-24 \$193.70	25-49 \$183.50	50+ \$175.35				
PRICE																														
1-9 \$203.89																														
10-24 \$193.70																														
25-49 \$183.50																														
50+ \$175.35																														
PRICE																														
1-24 \$281.08																														
25-49 \$261.40																														
50-99 \$241.73																														
100+ \$224.86																														
PRICE																														
1-9 \$231.37																														
10-24 \$219.80																														
25-49 \$208.23																														
NEW 50+ \$198.98																														
PRICE																														
1-9 \$203.89																														
10-24 \$193.70																														
25-49 \$183.50																														
50+ \$175.35																														
4	 <table border="1"> <thead> <tr> <th>PRICE</th> </tr> </thead> <tbody> <tr> <td>1-9 \$216.14</td> </tr> <tr> <td>10-24 \$205.33</td> </tr> <tr> <td>25-49 \$194.53</td> </tr> <tr> <td>NEW 50+ \$185.88</td> </tr> </tbody> </table> <p>3.5mm Male to 3.5mm Female Miter Right Angle VSWR 1.35:1 to 34.5 GHz Model No: <a href="#">PE91523</a></p>	PRICE	1-9 \$216.14	10-24 \$205.33	25-49 \$194.53	NEW 50+ \$185.88	 <table border="1"> <thead> <tr> <th>PRICE</th> </tr> </thead> <tbody> <tr> <td>1-9 \$185.98</td> </tr> <tr> <td>10-24 \$176.68</td> </tr> <tr> <td>25-49 \$167.38</td> </tr> <tr> <td>50+ \$159.94</td> </tr> </tbody> </table> <p>3.5mm Female to 3.5mm Female Bulkhead-Mounting Hole B06 VSWR 1.25:1 to 34.5 GHz Model No: <a href="#">PE9678</a></p>	PRICE	1-9 \$185.98	10-24 \$176.68	25-49 \$167.38	50+ \$159.94	 <table border="1"> <thead> <tr> <th>PRICE</th> </tr> </thead> <tbody> <tr> <td>1-9 \$248.65</td> </tr> <tr> <td>10-24 \$236.22</td> </tr> <tr> <td>25-49 \$223.79</td> </tr> <tr> <td>50+ \$213.84</td> </tr> </tbody> </table> <p>3.5mm Female to 3.5mm Female 4 Hole Flange-Mounting Hole A01 VSWR 1.25:1 to 34.5 GHz Model No: <a href="#">PE9676</a></p>	PRICE	1-9 \$248.65	10-24 \$236.22	25-49 \$223.79	50+ \$213.84	 <table border="1"> <thead> <tr> <th>PRICE</th> </tr> </thead> <tbody> <tr> <td>1 \$219.65</td> </tr> </tbody> </table> <p>3.5mm Female to 3.5mm Female Miter Right Angle VSWR 1.35:1 to 34.5 GHz Model No: <a href="#">PE91528</a></p>	PRICE	1 \$219.65	<p><b>3.5mm Between Series</b></p> 								
PRICE																														
1-9 \$216.14																														
10-24 \$205.33																														
25-49 \$194.53																														
NEW 50+ \$185.88																														
PRICE																														
1-9 \$185.98																														
10-24 \$176.68																														
25-49 \$167.38																														
50+ \$159.94																														
PRICE																														
1-9 \$248.65																														
10-24 \$236.22																														
25-49 \$223.79																														
50+ \$213.84																														
PRICE																														
1 \$219.65																														
5	 <table border="1"> <thead> <tr> <th>PRICE</th> </tr> </thead> <tbody> <tr> <td>1-9 \$241.22</td> </tr> <tr> <td>10-24 \$229.16</td> </tr> <tr> <td>25-49 \$217.10</td> </tr> <tr> <td>50+ \$207.45</td> </tr> </tbody> </table> <p>3.5mm Male to 1.85mm Male VSWR 1.3:1 to 34 GHz Model No: <a href="#">PE9746</a></p>	PRICE	1-9 \$241.22	10-24 \$229.16	25-49 \$217.10	50+ \$207.45	 <table border="1"> <thead> <tr> <th>PRICE</th> </tr> </thead> <tbody> <tr> <td>1-9 \$254.27</td> </tr> <tr> <td>10-24 \$241.56</td> </tr> <tr> <td>25-49 \$228.84</td> </tr> <tr> <td>50+ \$218.67</td> </tr> </tbody> </table> <p>3.5mm Male to 1.85mm Female VSWR 1.3:1 to 34 GHz Model No: <a href="#">PE9745</a></p>	PRICE	1-9 \$254.27	10-24 \$241.56	25-49 \$228.84	50+ \$218.67	 <table border="1"> <thead> <tr> <th>PRICE</th> </tr> </thead> <tbody> <tr> <td>1-9 \$293.38</td> </tr> <tr> <td>10-24 \$278.71</td> </tr> <tr> <td>25-49 \$264.04</td> </tr> <tr> <td>50+ \$252.31</td> </tr> </tbody> </table> <p>3.5mm Male to 2.4mm Male VSWR 1.15:1 to 34 GHz Model No: <a href="#">PE91294</a></p>	PRICE	1-9 \$293.38	10-24 \$278.71	25-49 \$264.04	50+ \$252.31	 <table border="1"> <thead> <tr> <th>PRICE</th> </tr> </thead> <tbody> <tr> <td>1-9 \$233.89</td> </tr> <tr> <td>10-24 \$222.20</td> </tr> <tr> <td>25-49 \$210.50</td> </tr> <tr> <td>50+ \$201.15</td> </tr> </tbody> </table> <p>3.5mm Male to 2.4mm Male VSWR 1.25:1 to 34 GHz Model No: <a href="#">PE9649</a></p>	PRICE	1-9 \$233.89	10-24 \$222.20	25-49 \$210.50	50+ \$201.15	 <table border="1"> <thead> <tr> <th>PRICE</th> </tr> </thead> <tbody> <tr> <td>1-24 \$265.13</td> </tr> <tr> <td>25-49 \$246.57</td> </tr> <tr> <td>50-99 \$228.01</td> </tr> <tr> <td>NEW 100+ \$212.10</td> </tr> </tbody> </table> <p>3.5mm Male to 2.4mm Female VSWR 1.3:1 to 34 GHz Model No: <a href="#">PE91452</a></p>	PRICE	1-24 \$265.13	25-49 \$246.57	50-99 \$228.01	NEW 100+ \$212.10
PRICE																														
1-9 \$241.22																														
10-24 \$229.16																														
25-49 \$217.10																														
50+ \$207.45																														
PRICE																														
1-9 \$254.27																														
10-24 \$241.56																														
25-49 \$228.84																														
50+ \$218.67																														
PRICE																														
1-9 \$293.38																														
10-24 \$278.71																														
25-49 \$264.04																														
50+ \$252.31																														
PRICE																														
1-9 \$233.89																														
10-24 \$222.20																														
25-49 \$210.50																														
50+ \$201.15																														
PRICE																														
1-24 \$265.13																														
25-49 \$246.57																														
50-99 \$228.01																														
NEW 100+ \$212.10																														
6	 <table border="1"> <thead> <tr> <th>PRICE</th> </tr> </thead> <tbody> <tr> <td>1-9 \$235.05</td> </tr> <tr> <td>10-24 \$223.30</td> </tr> <tr> <td>25-49 \$211.55</td> </tr> <tr> <td>50+ \$202.14</td> </tr> </tbody> </table> <p>3.5mm Male to 2.4mm Female VSWR 1.25:1 to 34 GHz Model No: <a href="#">PE9651</a></p>	PRICE	1-9 \$235.05	10-24 \$223.30	25-49 \$211.55	50+ \$202.14	 <table border="1"> <thead> <tr> <th>PRICE</th> </tr> </thead> <tbody> <tr> <td>1-9 \$237.83</td> </tr> <tr> <td>10-24 \$225.94</td> </tr> <tr> <td>25-49 \$214.05</td> </tr> <tr> <td>50+ \$204.53</td> </tr> </tbody> </table> <p>3.5mm Male to 2.92mm Female VSWR 1.25:1 to 34 GHz Model No: <a href="#">PE9658</a></p>	PRICE	1-9 \$237.83	10-24 \$225.94	25-49 \$214.05	50+ \$204.53	 <table border="1"> <thead> <tr> <th>PRICE</th> </tr> </thead> <tbody> <tr> <td>1-9 \$325.70</td> </tr> <tr> <td>10-24 \$309.42</td> </tr> <tr> <td>25-49 \$293.13</td> </tr> <tr> <td>PRECISION 50+ \$280.10</td> </tr> </tbody> </table> <p>3.5mm Male to 7mm Sexless VSWR 1.15:1 to 18 GHz Model No: <a href="#">PE9326</a></p>	PRICE	1-9 \$325.70	10-24 \$309.42	25-49 \$293.13	PRECISION 50+ \$280.10	 <table border="1"> <thead> <tr> <th>PRICE</th> </tr> </thead> <tbody> <tr> <td>1-9 \$200.82</td> </tr> <tr> <td>10-24 \$190.78</td> </tr> <tr> <td>25-49 \$180.74</td> </tr> <tr> <td>PRECISION 50+ \$172.71</td> </tr> </tbody> </table> <p>3.5mm Male to N Male VSWR 1.15:1 to 18 GHz Model No: <a href="#">PE9322</a></p>	PRICE	1-9 \$200.82	10-24 \$190.78	25-49 \$180.74	PRECISION 50+ \$172.71	 <table border="1"> <thead> <tr> <th>PRICE</th> </tr> </thead> <tbody> <tr> <td>1-9 \$190.79</td> </tr> <tr> <td>10-24 \$181.25</td> </tr> <tr> <td>25-49 \$171.71</td> </tr> <tr> <td>PRECISION 50+ \$164.08</td> </tr> </tbody> </table> <p>3.5mm Male to N Female VSWR 1.15:1 to 18 GHz Model No: <a href="#">PE9324</a></p>	PRICE	1-9 \$190.79	10-24 \$181.25	25-49 \$171.71	PRECISION 50+ \$164.08
PRICE																														
1-9 \$235.05																														
10-24 \$223.30																														
25-49 \$211.55																														
50+ \$202.14																														
PRICE																														
1-9 \$237.83																														
10-24 \$225.94																														
25-49 \$214.05																														
50+ \$204.53																														
PRICE																														
1-9 \$325.70																														
10-24 \$309.42																														
25-49 \$293.13																														
PRECISION 50+ \$280.10																														
PRICE																														
1-9 \$200.82																														
10-24 \$190.78																														
25-49 \$180.74																														
PRECISION 50+ \$172.71																														
PRICE																														
1-9 \$190.79																														
10-24 \$181.25																														
25-49 \$171.71																														
PRECISION 50+ \$164.08																														
7	 <table border="1"> <thead> <tr> <th>PRICE</th> </tr> </thead> <tbody> <tr> <td>1-9 \$231.29</td> </tr> <tr> <td>10-24 \$219.73</td> </tr> <tr> <td>25-49 \$208.16</td> </tr> <tr> <td>50+ \$198.91</td> </tr> </tbody> </table> <p>3.5mm Female to 1.85mm Female VSWR 1.3:1 to 34 GHz Model No: <a href="#">PE9748</a></p>	PRICE	1-9 \$231.29	10-24 \$219.73	25-49 \$208.16	50+ \$198.91	 <table border="1"> <thead> <tr> <th>PRICE</th> </tr> </thead> <tbody> <tr> <td>1-9 \$238.85</td> </tr> <tr> <td>10-24 \$226.91</td> </tr> <tr> <td>25-49 \$214.97</td> </tr> <tr> <td>50+ \$205.41</td> </tr> </tbody> </table> <p>3.5mm Female to 2.4mm Male VSWR 1.25:1 to 34 GHz Model No: <a href="#">PE9650</a></p>	PRICE	1-9 \$238.85	10-24 \$226.91	25-49 \$214.97	50+ \$205.41	 <table border="1"> <thead> <tr> <th>PRICE</th> </tr> </thead> <tbody> <tr> <td>1-9 \$289.05</td> </tr> <tr> <td>10-24 \$274.60</td> </tr> <tr> <td>25-49 \$260.15</td> </tr> <tr> <td>50+ \$248.58</td> </tr> </tbody> </table> <p>3.5mm Female to 2.4mm Female VSWR 1.15:1 to 34 GHz Model No: <a href="#">PE91291</a></p>	PRICE	1-9 \$289.05	10-24 \$274.60	25-49 \$260.15	50+ \$248.58	 <table border="1"> <thead> <tr> <th>PRICE</th> </tr> </thead> <tbody> <tr> <td>1-9 \$210.03</td> </tr> <tr> <td>10-24 \$199.53</td> </tr> <tr> <td>25-49 \$189.03</td> </tr> <tr> <td>50+ \$180.63</td> </tr> </tbody> </table> <p>3.5mm Female to 2.4mm Female VSWR 1.25:1 to 34 GHz Model No: <a href="#">PE9652</a></p>	PRICE	1-9 \$210.03	10-24 \$199.53	25-49 \$189.03	50+ \$180.63	 <table border="1"> <thead> <tr> <th>PRICE</th> </tr> </thead> <tbody> <tr> <td>1-9 \$194.46</td> </tr> <tr> <td>10-24 \$184.74</td> </tr> <tr> <td>25-49 \$175.01</td> </tr> <tr> <td>NEW 50+ \$167.24</td> </tr> </tbody> </table> <p>3.5mm Female to 2.4mm Female VSWR 1.15:1 to 34.5 GHz Model No: <a href="#">PE91547</a></p>	PRICE	1-9 \$194.46	10-24 \$184.74	25-49 \$175.01	NEW 50+ \$167.24
PRICE																														
1-9 \$231.29																														
10-24 \$219.73																														
25-49 \$208.16																														
50+ \$198.91																														
PRICE																														
1-9 \$238.85																														
10-24 \$226.91																														
25-49 \$214.97																														
50+ \$205.41																														
PRICE																														
1-9 \$289.05																														
10-24 \$274.60																														
25-49 \$260.15																														
50+ \$248.58																														
PRICE																														
1-9 \$210.03																														
10-24 \$199.53																														
25-49 \$189.03																														
50+ \$180.63																														
PRICE																														
1-9 \$194.46																														
10-24 \$184.74																														
25-49 \$175.01																														
NEW 50+ \$167.24																														



Technical Support  
+1 (949) 261-1920



Same-Day Shipping,  
Even Custom Cable Assemblies















# ADAPTERS

See Adapter Locator on Pages 10-15

See Page 409 for Mounting Holes

Adapters

See Our Website For Current Pricing & Real-Time Stock Availability!

	A	B	C	D	E																																																		
1	 <table border="1"> <thead> <tr> <th colspan="2">PRICE</th> </tr> </thead> <tbody> <tr><td>1-9</td><td>\$233.89</td></tr> <tr><td>10-24</td><td>\$222.20</td></tr> <tr><td>25-49</td><td>\$210.50</td></tr> <tr><td>50+</td><td>\$201.15</td></tr> </tbody> </table> <p>3.5mm Female to 2.92mm Male VSWR 1.25:1 to 34.5 GHz Model No: <a href="#">PE9659</a></p>	PRICE		1-9	\$233.89	10-24	\$222.20	25-49	\$210.50	50+	\$201.15	 <table border="1"> <thead> <tr> <th colspan="2">PRICE</th> </tr> </thead> <tbody> <tr><td>1-9</td><td>\$468.64</td></tr> <tr><td>10-24</td><td>\$445.21</td></tr> <tr><td>25-49</td><td>\$421.78</td></tr> <tr><td>50+</td><td>\$403.03</td></tr> </tbody> </table> <p>PRECISION 3.5mm Female to 7mm Sexless VSWR 1.15:1 to 18 GHz Model No: <a href="#">PE9325</a></p>	PRICE		1-9	\$468.64	10-24	\$445.21	25-49	\$421.78	50+	\$403.03	 <table border="1"> <thead> <tr> <th colspan="2">PRICE</th> </tr> </thead> <tbody> <tr><td>1-9</td><td>\$314.54</td></tr> <tr><td>10-24</td><td>\$298.81</td></tr> <tr><td>25-49</td><td>\$283.09</td></tr> <tr><td>50+</td><td>\$270.50</td></tr> </tbody> </table> <p>PRECISION NEW 3.5mm Female to 7mm Sexless VSWR 1.15:1 to 18 GHz Model No: <a href="#">PE91546</a></p>	PRICE		1-9	\$314.54	10-24	\$298.81	25-49	\$283.09	50+	\$270.50	 <table border="1"> <thead> <tr> <th colspan="2">PRICE</th> </tr> </thead> <tbody> <tr><td>1-9</td><td>\$188.68</td></tr> <tr><td>10-24</td><td>\$179.25</td></tr> <tr><td>25-49</td><td>\$169.81</td></tr> <tr><td>50+</td><td>\$162.26</td></tr> </tbody> </table> <p>PRECISION 3.5mm Female to N Male VSWR 1.15:1 to 18 GHz Model No: <a href="#">PE9321</a></p>	PRICE		1-9	\$188.68	10-24	\$179.25	25-49	\$169.81	50+	\$162.26	 <table border="1"> <thead> <tr> <th colspan="2">PRICE</th> </tr> </thead> <tbody> <tr><td>1-9</td><td>\$191.06</td></tr> <tr><td>10-24</td><td>\$181.51</td></tr> <tr><td>25-49</td><td>\$171.95</td></tr> <tr><td>50+</td><td>\$164.31</td></tr> </tbody> </table> <p>PRECISION 3.5mm Female to N Female VSWR 1.15:1 to 18 GHz Model No: <a href="#">PE9323</a></p>	PRICE		1-9	\$191.06	10-24	\$181.51	25-49	\$171.95	50+	\$164.31
PRICE																																																							
1-9	\$233.89																																																						
10-24	\$222.20																																																						
25-49	\$210.50																																																						
50+	\$201.15																																																						
PRICE																																																							
1-9	\$468.64																																																						
10-24	\$445.21																																																						
25-49	\$421.78																																																						
50+	\$403.03																																																						
PRICE																																																							
1-9	\$314.54																																																						
10-24	\$298.81																																																						
25-49	\$283.09																																																						
50+	\$270.50																																																						
PRICE																																																							
1-9	\$188.68																																																						
10-24	\$179.25																																																						
25-49	\$169.81																																																						
50+	\$162.26																																																						
PRICE																																																							
1-9	\$191.06																																																						
10-24	\$181.51																																																						
25-49	\$171.95																																																						
50+	\$164.31																																																						
2	<p><b>3.5mm NMD Between Series</b></p> <p>→</p>	 <table border="1"> <thead> <tr> <th colspan="2">PRICE</th> </tr> </thead> <tbody> <tr><td>1-9</td><td>\$361.09</td></tr> <tr><td>10-24</td><td>\$343.04</td></tr> <tr><td>25-49</td><td>\$324.98</td></tr> <tr><td>50+</td><td>\$310.54</td></tr> </tbody> </table> <p>3.5mm NMD Female to 2.4mm Female VSWR 1.25:1 to 33 GHz Model No: <a href="#">PE91148</a></p>	PRICE		1-9	\$361.09	10-24	\$343.04	25-49	\$324.98	50+	\$310.54	 <table border="1"> <thead> <tr> <th colspan="2">PRICE</th> </tr> </thead> <tbody> <tr><td>1-9</td><td>\$305.76</td></tr> <tr><td>10-24</td><td>\$290.47</td></tr> <tr><td>25-49</td><td>\$275.18</td></tr> <tr><td>50+</td><td>\$262.95</td></tr> </tbody> </table> <p>Ruggedized 3.5mm NMD Female to SMA Female Max. Freq. 27 GHz Model No: <a href="#">PE91147</a></p>	PRICE		1-9	\$305.76	10-24	\$290.47	25-49	\$275.18	50+	\$262.95	<p><b>7mm Between Series</b></p> <p>→</p>	 <table border="1"> <thead> <tr> <th colspan="2">PRICE</th> </tr> </thead> <tbody> <tr><td>1-9</td><td>\$524.30</td></tr> <tr><td>10-24</td><td>\$503.33</td></tr> <tr><td>25-49</td><td>\$487.60</td></tr> <tr><td>50+</td><td>\$477.11</td></tr> </tbody> </table> <p>PRECISION 7mm Sexless to BNC Male VSWR 1.15:1 to 8 GHz Model No: <a href="#">PE9221</a></p>	PRICE		1-9	\$524.30	10-24	\$503.33	25-49	\$487.60	50+	\$477.11																				
PRICE																																																							
1-9	\$361.09																																																						
10-24	\$343.04																																																						
25-49	\$324.98																																																						
50+	\$310.54																																																						
PRICE																																																							
1-9	\$305.76																																																						
10-24	\$290.47																																																						
25-49	\$275.18																																																						
50+	\$262.95																																																						
PRICE																																																							
1-9	\$524.30																																																						
10-24	\$503.33																																																						
25-49	\$487.60																																																						
50+	\$477.11																																																						
3	 <table border="1"> <thead> <tr> <th colspan="2">PRICE</th> </tr> </thead> <tbody> <tr><td>1-9</td><td>\$370.87</td></tr> <tr><td>10-24</td><td>\$352.33</td></tr> <tr><td>25-49</td><td>\$333.78</td></tr> <tr><td>50+</td><td>\$318.95</td></tr> </tbody> </table> <p>PRECISION 7mm Sexless to BNC Female VSWR 1.15:1 to 8 GHz Model No: <a href="#">PE9220</a></p>	PRICE		1-9	\$370.87	10-24	\$352.33	25-49	\$333.78	50+	\$318.95	<p><b>4.1/9.5 Mini DIN In-Series</b></p> <p>→</p>	 <table border="1"> <thead> <tr> <th colspan="2">PRICE</th> </tr> </thead> <tbody> <tr><td>1-24</td><td>\$71.77</td></tr> <tr><td>25-49</td><td>\$68.18</td></tr> <tr><td>50-99</td><td>\$64.59</td></tr> <tr><td>100+</td><td>\$61.72</td></tr> </tbody> </table> <p>4.1/9.5 Mini DIN Male to 4.1/9.5 Mini DIN Male VSWR 1.25:1 to 6 GHz Model No: <a href="#">PE91194</a></p>	PRICE		1-24	\$71.77	25-49	\$68.18	50-99	\$64.59	100+	\$61.72	 <table border="1"> <thead> <tr> <th colspan="2">PRICE</th> </tr> </thead> <tbody> <tr><td>1-24</td><td>\$52.43</td></tr> <tr><td>25-49</td><td>\$49.81</td></tr> <tr><td>50-99</td><td>\$47.19</td></tr> <tr><td>100+</td><td>\$45.09</td></tr> </tbody> </table> <p>4.1/9.5 Mini DIN Male to 4.1/9.5 Mini DIN Male VSWR 1.3:1 to 6 GHz Model No: <a href="#">PE91231</a></p>	PRICE		1-24	\$52.43	25-49	\$49.81	50-99	\$47.19	100+	\$45.09	 <table border="1"> <thead> <tr> <th colspan="2">PRICE</th> </tr> </thead> <tbody> <tr><td>1-24</td><td>\$71.77</td></tr> <tr><td>25-49</td><td>\$68.18</td></tr> <tr><td>50-99</td><td>\$64.59</td></tr> <tr><td>100+</td><td>\$61.72</td></tr> </tbody> </table> <p>4.1/9.5 Mini DIN Male to 4.1/9.5 Mini DIN Female VSWR 1.25:1 to 6 GHz Model No: <a href="#">PE91195</a></p>	PRICE		1-24	\$71.77	25-49	\$68.18	50-99	\$64.59	100+	\$61.72										
PRICE																																																							
1-9	\$370.87																																																						
10-24	\$352.33																																																						
25-49	\$333.78																																																						
50+	\$318.95																																																						
PRICE																																																							
1-24	\$71.77																																																						
25-49	\$68.18																																																						
50-99	\$64.59																																																						
100+	\$61.72																																																						
PRICE																																																							
1-24	\$52.43																																																						
25-49	\$49.81																																																						
50-99	\$47.19																																																						
100+	\$45.09																																																						
PRICE																																																							
1-24	\$71.77																																																						
25-49	\$68.18																																																						
50-99	\$64.59																																																						
100+	\$61.72																																																						
4	 <table border="1"> <thead> <tr> <th colspan="2">PRICE</th> </tr> </thead> <tbody> <tr><td>1-24</td><td>\$31.92</td></tr> <tr><td>25-49</td><td>\$30.32</td></tr> <tr><td>50-99</td><td>\$28.73</td></tr> <tr><td>100+</td><td>\$27.45</td></tr> </tbody> </table> <p>4.1/9.5 Mini DIN Female to 4.1/9.5 Mini DIN Female VSWR 1.3:1 to 6 GHz Model No: <a href="#">PE91233</a></p>	PRICE		1-24	\$31.92	25-49	\$30.32	50-99	\$28.73	100+	\$27.45	 <table border="1"> <thead> <tr> <th colspan="2">PRICE</th> </tr> </thead> <tbody> <tr><td>1-24</td><td>\$85.75</td></tr> <tr><td>25-49</td><td>\$81.46</td></tr> <tr><td>50-99</td><td>\$77.18</td></tr> <tr><td>100+</td><td>\$73.75</td></tr> </tbody> </table> <p>4.1/9.5 Mini DIN Female to 4.1/9.5 Mini DIN Female Bulkhead VSWR 1.25:1 to 6 GHz Model No: <a href="#">PE91197</a></p>	PRICE		1-24	\$85.75	25-49	\$81.46	50-99	\$77.18	100+	\$73.75	 <table border="1"> <thead> <tr> <th colspan="2">PRICE</th> </tr> </thead> <tbody> <tr><td>1-24</td><td>\$34.08</td></tr> <tr><td>25-49</td><td>\$32.38</td></tr> <tr><td>50-99</td><td>\$30.67</td></tr> <tr><td>100+</td><td>\$29.31</td></tr> </tbody> </table> <p>4.1/9.5 Mini DIN Female to 4.1/9.5 Mini DIN Female Bulkhead VSWR 1.3:1 to 6 GHz Model No: <a href="#">PE91234</a></p>	PRICE		1-24	\$34.08	25-49	\$32.38	50-99	\$30.67	100+	\$29.31	<p><b>4.1/9.5 Mini DIN Between Series</b></p> <p>→</p>	 <table border="1"> <thead> <tr> <th colspan="2">PRICE</th> </tr> </thead> <tbody> <tr><td>1-24</td><td>\$61.65</td></tr> <tr><td>25-49</td><td>\$58.57</td></tr> <tr><td>50-99</td><td>\$55.49</td></tr> <tr><td>100+</td><td>\$53.02</td></tr> </tbody> </table> <p>4.1/9.5 Mini DIN Male to N Male VSWR 1.25:1 to 6 GHz Model No: <a href="#">PE91216</a></p>	PRICE		1-24	\$61.65	25-49	\$58.57	50-99	\$55.49	100+	\$53.02										
PRICE																																																							
1-24	\$31.92																																																						
25-49	\$30.32																																																						
50-99	\$28.73																																																						
100+	\$27.45																																																						
PRICE																																																							
1-24	\$85.75																																																						
25-49	\$81.46																																																						
50-99	\$77.18																																																						
100+	\$73.75																																																						
PRICE																																																							
1-24	\$34.08																																																						
25-49	\$32.38																																																						
50-99	\$30.67																																																						
100+	\$29.31																																																						
PRICE																																																							
1-24	\$61.65																																																						
25-49	\$58.57																																																						
50-99	\$55.49																																																						
100+	\$53.02																																																						
5	 <table border="1"> <thead> <tr> <th colspan="2">PRICE</th> </tr> </thead> <tbody> <tr><td>1-24</td><td>\$65.02</td></tr> <tr><td>25-49</td><td>\$61.77</td></tr> <tr><td>50-99</td><td>\$58.52</td></tr> <tr><td>100+</td><td>\$55.92</td></tr> </tbody> </table> <p>Low PIM 4.1/9.5 Mini DIN Male to N Male VSWR 1.25:1 to 6 GHz Model No: <a href="#">PE91092</a></p>	PRICE		1-24	\$65.02	25-49	\$61.77	50-99	\$58.52	100+	\$55.92	 <table border="1"> <thead> <tr> <th colspan="2">PRICE</th> </tr> </thead> <tbody> <tr><td>1-24</td><td>\$67.83</td></tr> <tr><td>25-49</td><td>\$64.44</td></tr> <tr><td>50-99</td><td>\$61.05</td></tr> <tr><td>100+</td><td>\$58.33</td></tr> </tbody> </table> <p>4.1/9.5 Mini DIN Male to N Female VSWR 1.25:1 to 6 GHz Model No: <a href="#">PE91217</a></p>	PRICE		1-24	\$67.83	25-49	\$64.44	50-99	\$61.05	100+	\$58.33	 <table border="1"> <thead> <tr> <th colspan="2">PRICE</th> </tr> </thead> <tbody> <tr><td>1-24</td><td>\$70.45</td></tr> <tr><td>25-49</td><td>\$66.93</td></tr> <tr><td>50-99</td><td>\$63.41</td></tr> <tr><td>100+</td><td>\$60.59</td></tr> </tbody> </table> <p>4.1/9.5 Mini DIN Male to N Female VSWR 1.3:1 to 6 GHz Model No: <a href="#">PE91254</a></p>	PRICE		1-24	\$70.45	25-49	\$66.93	50-99	\$63.41	100+	\$60.59	 <table border="1"> <thead> <tr> <th colspan="2">PRICE</th> </tr> </thead> <tbody> <tr><td>1-24</td><td>\$63.25</td></tr> <tr><td>25-49</td><td>\$60.09</td></tr> <tr><td>50-99</td><td>\$56.93</td></tr> <tr><td>100+</td><td>\$54.40</td></tr> </tbody> </table> <p>Low PIM 4.1/9.5 Mini DIN Male to N Female VSWR 1.25:1 to 6 GHz Model No: <a href="#">PE91093</a></p>	PRICE		1-24	\$63.25	25-49	\$60.09	50-99	\$56.93	100+	\$54.40	 <table border="1"> <thead> <tr> <th colspan="2">PRICE</th> </tr> </thead> <tbody> <tr><td>1-24</td><td>\$61.65</td></tr> <tr><td>25-49</td><td>\$58.57</td></tr> <tr><td>50-99</td><td>\$55.49</td></tr> <tr><td>100+</td><td>\$53.02</td></tr> </tbody> </table> <p>4.1/9.5 Mini DIN Female to N Male VSWR 1.25:1 to 6 GHz Model No: <a href="#">PE91219</a></p>	PRICE		1-24	\$61.65	25-49	\$58.57	50-99	\$55.49	100+	\$53.02
PRICE																																																							
1-24	\$65.02																																																						
25-49	\$61.77																																																						
50-99	\$58.52																																																						
100+	\$55.92																																																						
PRICE																																																							
1-24	\$67.83																																																						
25-49	\$64.44																																																						
50-99	\$61.05																																																						
100+	\$58.33																																																						
PRICE																																																							
1-24	\$70.45																																																						
25-49	\$66.93																																																						
50-99	\$63.41																																																						
100+	\$60.59																																																						
PRICE																																																							
1-24	\$63.25																																																						
25-49	\$60.09																																																						
50-99	\$56.93																																																						
100+	\$54.40																																																						
PRICE																																																							
1-24	\$61.65																																																						
25-49	\$58.57																																																						
50-99	\$55.49																																																						
100+	\$53.02																																																						
6	 <table border="1"> <thead> <tr> <th colspan="2">PRICE</th> </tr> </thead> <tbody> <tr><td>1-24</td><td>\$76.06</td></tr> <tr><td>25-49</td><td>\$72.26</td></tr> <tr><td>50-99</td><td>\$68.45</td></tr> <tr><td>100+</td><td>\$65.41</td></tr> </tbody> </table> <p>4.1/9.5 Mini DIN Female to N Male VSWR 1.3:1 to 6 GHz Model No: <a href="#">PE91256</a></p>	PRICE		1-24	\$76.06	25-49	\$72.26	50-99	\$68.45	100+	\$65.41	 <table border="1"> <thead> <tr> <th colspan="2">PRICE</th> </tr> </thead> <tbody> <tr><td>1-24</td><td>\$65.02</td></tr> <tr><td>25-49</td><td>\$61.77</td></tr> <tr><td>50-99</td><td>\$58.52</td></tr> <tr><td>100+</td><td>\$55.92</td></tr> </tbody> </table> <p>Low PIM 4.1/9.5 Mini DIN Female to N Male VSWR 1.25:1 to 6 GHz Model No: <a href="#">PE91094</a></p>	PRICE		1-24	\$65.02	25-49	\$61.77	50-99	\$58.52	100+	\$55.92	 <table border="1"> <thead> <tr> <th colspan="2">PRICE</th> </tr> </thead> <tbody> <tr><td>1-24</td><td>\$60.50</td></tr> <tr><td>25-49</td><td>\$57.48</td></tr> <tr><td>50-99</td><td>\$54.45</td></tr> <tr><td>100+</td><td>\$52.03</td></tr> </tbody> </table> <p>4.1/9.5 Mini DIN Female to N Female VSWR 1.25:1 to 6 GHz Model No: <a href="#">PE91218</a></p>	PRICE		1-24	\$60.50	25-49	\$57.48	50-99	\$54.45	100+	\$52.03	 <table border="1"> <thead> <tr> <th colspan="2">PRICE</th> </tr> </thead> <tbody> <tr><td>1-24</td><td>\$66.54</td></tr> <tr><td>25-49</td><td>\$63.21</td></tr> <tr><td>50-99</td><td>\$59.89</td></tr> <tr><td>100+</td><td>\$57.22</td></tr> </tbody> </table> <p>4.1/9.5 Mini DIN Female to N Female VSWR 1.3:1 to 6 GHz Model No: <a href="#">PE91255</a></p>	PRICE		1-24	\$66.54	25-49	\$63.21	50-99	\$59.89	100+	\$57.22	 <table border="1"> <thead> <tr> <th colspan="2">PRICE</th> </tr> </thead> <tbody> <tr><td>1-24</td><td>\$65.02</td></tr> <tr><td>25-49</td><td>\$61.77</td></tr> <tr><td>50-99</td><td>\$58.52</td></tr> <tr><td>100+</td><td>\$55.92</td></tr> </tbody> </table> <p>Low PIM 4.1/9.5 Mini DIN Female to N Female VSWR 1.25:1 to 6 GHz Model No: <a href="#">PE91095</a></p>	PRICE		1-24	\$65.02	25-49	\$61.77	50-99	\$58.52	100+	\$55.92
PRICE																																																							
1-24	\$76.06																																																						
25-49	\$72.26																																																						
50-99	\$68.45																																																						
100+	\$65.41																																																						
PRICE																																																							
1-24	\$65.02																																																						
25-49	\$61.77																																																						
50-99	\$58.52																																																						
100+	\$55.92																																																						
PRICE																																																							
1-24	\$60.50																																																						
25-49	\$57.48																																																						
50-99	\$54.45																																																						
100+	\$52.03																																																						
PRICE																																																							
1-24	\$66.54																																																						
25-49	\$63.21																																																						
50-99	\$59.89																																																						
100+	\$57.22																																																						
PRICE																																																							
1-24	\$65.02																																																						
25-49	\$61.77																																																						
50-99	\$58.52																																																						
100+	\$55.92																																																						
7	<p><b>4.3 Non Constant In-Series</b></p> <p>→</p>	 <table border="1"> <thead> <tr> <th colspan="2">PRICE</th> </tr> </thead> <tbody> <tr><td>1-24</td><td>\$39.02</td></tr> <tr><td>25-49</td><td>\$37.07</td></tr> <tr><td>50-99</td><td>\$35.12</td></tr> <tr><td>100+</td><td>\$33.56</td></tr> </tbody> </table> <p>Low PIM 4.3-10 Male to 4.3-10 Male VSWR 1.25:1 to 6 GHz Model No: <a href="#">PE91466</a></p>	PRICE		1-24	\$39.02	25-49	\$37.07	50-99	\$35.12	100+	\$33.56	 <table border="1"> <thead> <tr> <th colspan="2">PRICE</th> </tr> </thead> <tbody> <tr><td>1-24</td><td>\$88.05</td></tr> <tr><td>25-49</td><td>\$83.65</td></tr> <tr><td>50-99</td><td>\$79.25</td></tr> <tr><td>100+</td><td>\$75.72</td></tr> </tbody> </table> <p>Low PIM 4.3-10 Male to 4.3-10 Male VSWR 1.08:1 to 6 GHz Model No: <a href="#">PE91385</a></p>	PRICE		1-24	\$88.05	25-49	\$83.65	50-99	\$79.25	100+	\$75.72	 <table border="1"> <thead> <tr> <th colspan="2">PRICE</th> </tr> </thead> <tbody> <tr><td>1-24</td><td>\$44.10</td></tr> <tr><td>25-49</td><td>\$41.90</td></tr> <tr><td>50-99</td><td>\$39.69</td></tr> <tr><td>100+</td><td>\$37.93</td></tr> </tbody> </table> <p>Low PIM 4.3-10 Male to 4.3-10 Female VSWR 1.25:1 to 6 GHz Model No: <a href="#">PE91465</a></p>	PRICE		1-24	\$44.10	25-49	\$41.90	50-99	\$39.69	100+	\$37.93	 <table border="1"> <thead> <tr> <th colspan="2">PRICE</th> </tr> </thead> <tbody> <tr><td>1-24</td><td>\$88.05</td></tr> <tr><td>25-49</td><td>\$83.65</td></tr> <tr><td>50-99</td><td>\$79.25</td></tr> <tr><td>100+</td><td>\$75.72</td></tr> </tbody> </table> <p>Low PIM 4.3-10 Male to 4.3-10 Female Right Angle VSWR 1.2:1 to 3 GHz Model No: <a href="#">PE91467</a></p>	PRICE		1-24	\$88.05	25-49	\$83.65	50-99	\$79.25	100+	\$75.72										
PRICE																																																							
1-24	\$39.02																																																						
25-49	\$37.07																																																						
50-99	\$35.12																																																						
100+	\$33.56																																																						
PRICE																																																							
1-24	\$88.05																																																						
25-49	\$83.65																																																						
50-99	\$79.25																																																						
100+	\$75.72																																																						
PRICE																																																							
1-24	\$44.10																																																						
25-49	\$41.90																																																						
50-99	\$39.69																																																						
100+	\$37.93																																																						
PRICE																																																							
1-24	\$88.05																																																						
25-49	\$83.65																																																						
50-99	\$79.25																																																						
100+	\$75.72																																																						



# ADAPTERS

See Adapter Locator on Pages 10-15  
See Page 409 for Mounting Holes

	A	B	C	D	E																																													
1	 <table border="1"> <thead> <tr><th>PRICE</th></tr> </thead> <tbody> <tr><td>1-24</td><td>\$89.17</td></tr> <tr><td>25-49</td><td>\$85.60</td></tr> <tr><td>50-99</td><td>\$82.93</td></tr> <tr><td>100+</td><td>\$81.14</td></tr> </tbody> </table> <p>Low PIM</p> <p>4.3-10 Male to 4.3-10 Female</p> <p>VSWR 1.08:1 to 6 GHz</p> <p>Model No: <a href="#">PE91387</a></p>	PRICE	1-24	\$89.17	25-49	\$85.60	50-99	\$82.93	100+	\$81.14	 <table border="1"> <thead> <tr><th>PRICE</th></tr> </thead> <tbody> <tr><td>1-24</td><td>\$44.10</td></tr> <tr><td>25-49</td><td>\$41.90</td></tr> <tr><td>50-99</td><td>\$39.69</td></tr> <tr><td>100+</td><td>\$37.93</td></tr> </tbody> </table> <p>Low PIM</p> <p>4.3-10 Female to 4.3-10 Female</p> <p>VSWR 1.25:1 to 6 GHz</p> <p>Model No: <a href="#">PE91464</a></p>	PRICE	1-24	\$44.10	25-49	\$41.90	50-99	\$39.69	100+	\$37.93	 <table border="1"> <thead> <tr><th>PRICE</th></tr> </thead> <tbody> <tr><td>1-24</td><td>\$90.97</td></tr> <tr><td>25-49</td><td>\$86.42</td></tr> <tr><td>50-99</td><td>\$81.87</td></tr> <tr><td>100+</td><td>\$78.23</td></tr> </tbody> </table> <p>Low PIM</p> <p>4.3-10 Female to 4.3-10 Female</p> <p>VSWR 1.08:1 to 6 GHz</p> <p>Model No: <a href="#">PE91386</a></p>	PRICE	1-24	\$90.97	25-49	\$86.42	50-99	\$81.87	100+	\$78.23	<div style="text-align: center;"> <h3>4.3</h3> <h2>Non Constant Between Series</h2>  </div>	 <table border="1"> <thead> <tr><th>PRICE</th></tr> </thead> <tbody> <tr><td>1-24</td><td>\$39.02</td></tr> <tr><td>25-49</td><td>\$37.07</td></tr> <tr><td>50-99</td><td>\$35.12</td></tr> <tr><td>100+</td><td>\$33.56</td></tr> </tbody> </table> <p>Low PIM</p> <p>4.3-10 Male to N Male</p> <p>VSWR 1.25:1 to 6 GHz</p> <p>Model No: <a href="#">PE91476</a></p>	PRICE	1-24	\$39.02	25-49	\$37.07	50-99	\$35.12	100+	\$33.56									
	PRICE																																																	
1-24	\$89.17																																																	
25-49	\$85.60																																																	
50-99	\$82.93																																																	
100+	\$81.14																																																	
PRICE																																																		
1-24	\$44.10																																																	
25-49	\$41.90																																																	
50-99	\$39.69																																																	
100+	\$37.93																																																	
PRICE																																																		
1-24	\$90.97																																																	
25-49	\$86.42																																																	
50-99	\$81.87																																																	
100+	\$78.23																																																	
PRICE																																																		
1-24	\$39.02																																																	
25-49	\$37.07																																																	
50-99	\$35.12																																																	
100+	\$33.56																																																	
2	 <table border="1"> <thead> <tr><th>PRICE</th></tr> </thead> <tbody> <tr><td>1-24</td><td>\$53.33</td></tr> <tr><td>25-49</td><td>\$50.66</td></tr> <tr><td>50-99</td><td>\$48.00</td></tr> <tr><td>100+</td><td>\$45.86</td></tr> </tbody> </table> <p>Low PIM</p> <p>QD 4.3-10 Male to N Male</p> <p>VSWR 1.25:1 to 6 GHz</p> <p>Model No: <a href="#">PE91480</a></p>	PRICE	1-24	\$53.33	25-49	\$50.66	50-99	\$48.00	100+	\$45.86	 <table border="1"> <thead> <tr><th>PRICE</th></tr> </thead> <tbody> <tr><td>1-24</td><td>\$39.02</td></tr> <tr><td>25-49</td><td>\$37.07</td></tr> <tr><td>50-99</td><td>\$35.12</td></tr> <tr><td>100+</td><td>\$33.56</td></tr> </tbody> </table> <p>Low PIM</p> <p>4.3-10 Male to N Female</p> <p>VSWR 1.25:1 to 6 GHz</p> <p>Model No: <a href="#">PE91474</a></p>	PRICE	1-24	\$39.02	25-49	\$37.07	50-99	\$35.12	100+	\$33.56	 <table border="1"> <thead> <tr><th>PRICE</th></tr> </thead> <tbody> <tr><td>1-24</td><td>\$39.02</td></tr> <tr><td>25-49</td><td>\$37.07</td></tr> <tr><td>50-99</td><td>\$35.12</td></tr> <tr><td>100+</td><td>\$33.56</td></tr> </tbody> </table> <p>Low PIM</p> <p>4.3-10 Male to N Female</p> <p>VSWR 1.25:1 to 6 GHz</p> <p>Model No: <a href="#">PE91477</a></p>	PRICE	1-24	\$39.02	25-49	\$37.07	50-99	\$35.12	100+	\$33.56	 <table border="1"> <thead> <tr><th>PRICE</th></tr> </thead> <tbody> <tr><td>1-24</td><td>\$51.32</td></tr> <tr><td>25-49</td><td>\$48.75</td></tr> <tr><td>50-99</td><td>\$46.19</td></tr> <tr><td>100+</td><td>\$44.14</td></tr> </tbody> </table> <p>Low PIM</p> <p>QD 4.3-10 Male to N Female</p> <p>VSWR 1.25:1 to 6 GHz</p> <p>Model No: <a href="#">PE91478</a></p>	PRICE	1-24	\$51.32	25-49	\$48.75	50-99	\$46.19	100+	\$44.14	 <table border="1"> <thead> <tr><th>PRICE</th></tr> </thead> <tbody> <tr><td>1-24</td><td>\$62.14</td></tr> <tr><td>25-49</td><td>\$59.03</td></tr> <tr><td>50-99</td><td>\$55.93</td></tr> <tr><td>100+</td><td>\$53.44</td></tr> </tbody> </table> <p>Low PIM</p> <p>4.3-10 Male to N Female Right Angle</p> <p>VSWR 1.25:1 to 6 GHz</p> <p>Model No: <a href="#">PE91483</a></p>	PRICE	1-24	\$62.14	25-49	\$59.03	50-99	\$55.93	100+	\$53.44
	PRICE																																																	
1-24	\$53.33																																																	
25-49	\$50.66																																																	
50-99	\$48.00																																																	
100+	\$45.86																																																	
PRICE																																																		
1-24	\$39.02																																																	
25-49	\$37.07																																																	
50-99	\$35.12																																																	
100+	\$33.56																																																	
PRICE																																																		
1-24	\$39.02																																																	
25-49	\$37.07																																																	
50-99	\$35.12																																																	
100+	\$33.56																																																	
PRICE																																																		
1-24	\$51.32																																																	
25-49	\$48.75																																																	
50-99	\$46.19																																																	
100+	\$44.14																																																	
PRICE																																																		
1-24	\$62.14																																																	
25-49	\$59.03																																																	
50-99	\$55.93																																																	
100+	\$53.44																																																	
3	 <table border="1"> <thead> <tr><th>PRICE</th></tr> </thead> <tbody> <tr><td>1-24</td><td>\$92.71</td></tr> <tr><td>25-49</td><td>\$88.07</td></tr> <tr><td>50-99</td><td>\$83.44</td></tr> <tr><td>100+</td><td>\$79.73</td></tr> </tbody> </table> <p>Low PIM</p> <p>4.3-10 Male to N Female</p> <p>VSWR 1.08:1 to 6 GHz</p> <p>Model No: <a href="#">PE91389</a></p>	PRICE	1-24	\$92.71	25-49	\$88.07	50-99	\$83.44	100+	\$79.73	 <table border="1"> <thead> <tr><th>PRICE</th></tr> </thead> <tbody> <tr><td>1-24</td><td>\$35.29</td></tr> <tr><td>25-49</td><td>\$33.53</td></tr> <tr><td>50-99</td><td>\$31.76</td></tr> <tr><td>100+</td><td>\$30.35</td></tr> </tbody> </table> <p>Low PIM</p> <p>4.3-10 Male to SMA Female</p> <p>VSWR 1.15:1 to 6 GHz</p> <p>Model No: <a href="#">PE91484</a></p>	PRICE	1-24	\$35.29	25-49	\$33.53	50-99	\$31.76	100+	\$30.35	 <table border="1"> <thead> <tr><th>PRICE</th></tr> </thead> <tbody> <tr><td>1-24</td><td>\$45.86</td></tr> <tr><td>25-49</td><td>\$43.57</td></tr> <tr><td>50-99</td><td>\$41.27</td></tr> <tr><td>100+</td><td>\$39.44</td></tr> </tbody> </table> <p>Low PIM</p> <p>4.3-10 Female to N Male</p> <p>VSWR 1.25:1 to 6 GHz</p> <p>Model No: <a href="#">PE91479</a></p>	PRICE	1-24	\$45.86	25-49	\$43.57	50-99	\$41.27	100+	\$39.44	 <table border="1"> <thead> <tr><th>PRICE</th></tr> </thead> <tbody> <tr><td>1-24</td><td>\$43.25</td></tr> <tr><td>25-49</td><td>\$41.09</td></tr> <tr><td>50-99</td><td>\$38.93</td></tr> <tr><td>100+</td><td>\$37.20</td></tr> </tbody> </table> <p>Low PIM</p> <p>QD 4.3-10 Female to N Male</p> <p>VSWR 1.25:1 to 6 GHz</p> <p>Model No: <a href="#">PE91481</a></p>	PRICE	1-24	\$43.25	25-49	\$41.09	50-99	\$38.93	100+	\$37.20	 <table border="1"> <thead> <tr><th>PRICE</th></tr> </thead> <tbody> <tr><td>1-24</td><td>\$39.87</td></tr> <tr><td>25-49</td><td>\$37.88</td></tr> <tr><td>50-99</td><td>\$35.88</td></tr> <tr><td>100+</td><td>\$34.29</td></tr> </tbody> </table> <p>Low PIM</p> <p>4.3-10 Female to N Female</p> <p>VSWR 1.25:1 to 6 GHz</p> <p>Model No: <a href="#">PE91475</a></p>	PRICE	1-24	\$39.87	25-49	\$37.88	50-99	\$35.88	100+	\$34.29
	PRICE																																																	
1-24	\$92.71																																																	
25-49	\$88.07																																																	
50-99	\$83.44																																																	
100+	\$79.73																																																	
PRICE																																																		
1-24	\$35.29																																																	
25-49	\$33.53																																																	
50-99	\$31.76																																																	
100+	\$30.35																																																	
PRICE																																																		
1-24	\$45.86																																																	
25-49	\$43.57																																																	
50-99	\$41.27																																																	
100+	\$39.44																																																	
PRICE																																																		
1-24	\$43.25																																																	
25-49	\$41.09																																																	
50-99	\$38.93																																																	
100+	\$37.20																																																	
PRICE																																																		
1-24	\$39.87																																																	
25-49	\$37.88																																																	
50-99	\$35.88																																																	
100+	\$34.29																																																	
4	 <table border="1"> <thead> <tr><th>PRICE</th></tr> </thead> <tbody> <tr><td>1-24</td><td>\$43.02</td></tr> <tr><td>25-49</td><td>\$40.87</td></tr> <tr><td>50-99</td><td>\$38.72</td></tr> <tr><td>100+</td><td>\$37.00</td></tr> </tbody> </table> <p>Low PIM</p> <p>QD 4.3-10 Female to N Female</p> <p>VSWR 1.25:1 to 6 GHz</p> <p>Model No: <a href="#">PE91482</a></p>	PRICE	1-24	\$43.02	25-49	\$40.87	50-99	\$38.72	100+	\$37.00	<div style="text-align: center;"> <h3>7/16 DIN In-Series</h3>  </div>	 <table border="1"> <thead> <tr><th>PRICE</th></tr> </thead> <tbody> <tr><td>1-24</td><td>\$93.75</td></tr> <tr><td>25-49</td><td>\$89.06</td></tr> <tr><td>50-99</td><td>\$84.38</td></tr> <tr><td>100+</td><td>\$80.63</td></tr> </tbody> </table> <p>7/16 DIN Male to 7/16 DIN Male</p> <p>VSWR 1.15:1 to 6 GHz</p> <p>Model No: <a href="#">PE91190</a></p>	PRICE	1-24	\$93.75	25-49	\$89.06	50-99	\$84.38	100+	\$80.63	 <table border="1"> <thead> <tr><th>PRICE</th></tr> </thead> <tbody> <tr><td>1-24</td><td>\$97.84</td></tr> <tr><td>25-49</td><td>\$92.95</td></tr> <tr><td>50-99</td><td>\$88.06</td></tr> <tr><td>100+</td><td>\$84.14</td></tr> </tbody> </table> <p>7/16 DIN Male to 7/16 DIN Male</p> <p>VSWR 1.25:1 to 6 GHz</p> <p>Model No: <a href="#">PE91227</a></p>	PRICE	1-24	\$97.84	25-49	\$92.95	50-99	\$88.06	100+	\$84.14	 <table border="1"> <thead> <tr><th>PRICE</th></tr> </thead> <tbody> <tr><td>1-9</td><td>\$123.52</td></tr> <tr><td>10-24</td><td>\$117.34</td></tr> <tr><td>25-49</td><td>\$111.17</td></tr> <tr><td>50+</td><td>\$106.23</td></tr> </tbody> </table> <p>Low PIM</p> <p>7/16 DIN Male to 7/16 DIN Male</p> <p>Max. Freq. 8 GHz</p> <p>Model No: <a href="#">PE91039</a></p>	PRICE	1-9	\$123.52	10-24	\$117.34	25-49	\$111.17	50+	\$106.23									
	PRICE																																																	
1-24	\$43.02																																																	
25-49	\$40.87																																																	
50-99	\$38.72																																																	
100+	\$37.00																																																	
PRICE																																																		
1-24	\$93.75																																																	
25-49	\$89.06																																																	
50-99	\$84.38																																																	
100+	\$80.63																																																	
PRICE																																																		
1-24	\$97.84																																																	
25-49	\$92.95																																																	
50-99	\$88.06																																																	
100+	\$84.14																																																	
PRICE																																																		
1-9	\$123.52																																																	
10-24	\$117.34																																																	
25-49	\$111.17																																																	
50+	\$106.23																																																	
5	 <table border="1"> <thead> <tr><th>PRICE</th></tr> </thead> <tbody> <tr><td>1-24</td><td>\$72.12</td></tr> <tr><td>25-49</td><td>\$68.51</td></tr> <tr><td>50-99</td><td>\$64.91</td></tr> <tr><td>100+</td><td>\$62.02</td></tr> </tbody> </table> <p>7/16 DIN Male to 7/16 DIN Female</p> <p>VSWR 1.15:1 to 6 GHz</p> <p>Model No: <a href="#">PE91191</a></p>	PRICE	1-24	\$72.12	25-49	\$68.51	50-99	\$64.91	100+	\$62.02	 <table border="1"> <thead> <tr><th>PRICE</th></tr> </thead> <tbody> <tr><td>1-24</td><td>\$74.37</td></tr> <tr><td>25-49</td><td>\$70.65</td></tr> <tr><td>50-99</td><td>\$66.93</td></tr> <tr><td>100+</td><td>\$63.96</td></tr> </tbody> </table> <p>7/16 DIN Male to 7/16 DIN Female</p> <p>VSWR 1.25:1 to 6 GHz</p> <p>Model No: <a href="#">PE91228</a></p>	PRICE	1-24	\$74.37	25-49	\$70.65	50-99	\$66.93	100+	\$63.96	 <table border="1"> <thead> <tr><th>PRICE</th></tr> </thead> <tbody> <tr><td>1-9</td><td>\$139.42</td></tr> <tr><td>10-24</td><td>\$132.45</td></tr> <tr><td>25-49</td><td>\$125.48</td></tr> <tr><td>50+</td><td>\$119.90</td></tr> </tbody> </table> <p>7/16 DIN Male to 7/16 DIN Female</p> <p>VSWR 1.35:1 to 7.5 GHz</p> <p>Model No: <a href="#">PE91027</a></p>	PRICE	1-9	\$139.42	10-24	\$132.45	25-49	\$125.48	50+	\$119.90	 <table border="1"> <thead> <tr><th>PRICE</th></tr> </thead> <tbody> <tr><td>1-9</td><td>\$117.66</td></tr> <tr><td>10-24</td><td>\$111.78</td></tr> <tr><td>25-49</td><td>\$105.89</td></tr> <tr><td>50+</td><td>\$101.19</td></tr> </tbody> </table> <p>Low PIM</p> <p>7/16 DIN Male to 7/16 DIN Female</p> <p>Max. Freq. 8 GHz</p> <p>Model No: <a href="#">PE91028</a></p>	PRICE	1-9	\$117.66	10-24	\$111.78	25-49	\$105.89	50+	\$101.19	 <table border="1"> <thead> <tr><th>PRICE</th></tr> </thead> <tbody> <tr><td>1-24</td><td>\$89.14</td></tr> <tr><td>25-49</td><td>\$84.68</td></tr> <tr><td>50-99</td><td>\$80.23</td></tr> <tr><td>100+</td><td>\$76.66</td></tr> </tbody> </table> <p>7/16 DIN Male to 7/16 DIN Female Right Angle</p> <p>VSWR 1.25:1 to 6 GHz</p> <p>Model No: <a href="#">PE91117</a></p>	PRICE	1-24	\$89.14	25-49	\$84.68	50-99	\$80.23	100+	\$76.66
	PRICE																																																	
1-24	\$72.12																																																	
25-49	\$68.51																																																	
50-99	\$64.91																																																	
100+	\$62.02																																																	
PRICE																																																		
1-24	\$74.37																																																	
25-49	\$70.65																																																	
50-99	\$66.93																																																	
100+	\$63.96																																																	
PRICE																																																		
1-9	\$139.42																																																	
10-24	\$132.45																																																	
25-49	\$125.48																																																	
50+	\$119.90																																																	
PRICE																																																		
1-9	\$117.66																																																	
10-24	\$111.78																																																	
25-49	\$105.89																																																	
50+	\$101.19																																																	
PRICE																																																		
1-24	\$89.14																																																	
25-49	\$84.68																																																	
50-99	\$80.23																																																	
100+	\$76.66																																																	
6	 <table border="1"> <thead> <tr><th>PRICE</th></tr> </thead> <tbody> <tr><td>1-9</td><td>\$281.43</td></tr> <tr><td>10-24</td><td>\$267.36</td></tr> <tr><td>25-49</td><td>\$253.29</td></tr> <tr><td>50+</td><td>\$242.03</td></tr> </tbody> </table> <p>7/16 DIN Female to 7/16 DIN Male Tee</p> <p>Model No: <a href="#">PE9557</a></p>	PRICE	1-9	\$281.43	10-24	\$267.36	25-49	\$253.29	50+	\$242.03	 <table border="1"> <thead> <tr><th>PRICE</th></tr> </thead> <tbody> <tr><td>1-24</td><td>\$80.12</td></tr> <tr><td>25-49</td><td>\$76.11</td></tr> <tr><td>50-99</td><td>\$72.11</td></tr> <tr><td>100+</td><td>\$68.90</td></tr> </tbody> </table> <p>7/16 DIN Female to 7/16 DIN Female</p> <p>VSWR 1.15:1 to 6 GHz</p> <p>Model No: <a href="#">PE91192</a></p>	PRICE	1-24	\$80.12	25-49	\$76.11	50-99	\$72.11	100+	\$68.90	 <table border="1"> <thead> <tr><th>PRICE</th></tr> </thead> <tbody> <tr><td>1-24</td><td>\$65.59</td></tr> <tr><td>25-49</td><td>\$62.31</td></tr> <tr><td>50-99</td><td>\$59.03</td></tr> <tr><td>100+</td><td>\$56.01</td></tr> </tbody> </table> <p>7/16 DIN Female to 7/16 DIN Female</p> <p>VSWR 1.25:1 to 6 GHz</p> <p>Model No: <a href="#">PE91229</a></p>	PRICE	1-24	\$65.59	25-49	\$62.31	50-99	\$59.03	100+	\$56.01	 <table border="1"> <thead> <tr><th>PRICE</th></tr> </thead> <tbody> <tr><td>1-9</td><td>\$117.66</td></tr> <tr><td>10-24</td><td>\$111.78</td></tr> <tr><td>25-49</td><td>\$105.89</td></tr> <tr><td>50+</td><td>\$101.19</td></tr> </tbody> </table> <p>Low PIM</p> <p>7/16 DIN Female to 7/16 DIN Female</p> <p>Max. Freq. 8 GHz</p> <p>Model No: <a href="#">PE91029</a></p>	PRICE	1-9	\$117.66	10-24	\$111.78	25-49	\$105.89	50+	\$101.19	 <table border="1"> <thead> <tr><th>PRICE</th></tr> </thead> <tbody> <tr><td>1-9</td><td>\$131.23</td></tr> <tr><td>10-24</td><td>\$124.67</td></tr> <tr><td>25-49</td><td>\$118.11</td></tr> <tr><td>50+</td><td>\$112.86</td></tr> </tbody> </table> <p>7/16 DIN Female to 7/16 DIN Female</p> <p>Model No: <a href="#">PE9409</a></p>	PRICE	1-9	\$131.23	10-24	\$124.67	25-49	\$118.11	50+	\$112.86
	PRICE																																																	
1-9	\$281.43																																																	
10-24	\$267.36																																																	
25-49	\$253.29																																																	
50+	\$242.03																																																	
PRICE																																																		
1-24	\$80.12																																																	
25-49	\$76.11																																																	
50-99	\$72.11																																																	
100+	\$68.90																																																	
PRICE																																																		
1-24	\$65.59																																																	
25-49	\$62.31																																																	
50-99	\$59.03																																																	
100+	\$56.01																																																	
PRICE																																																		
1-9	\$117.66																																																	
10-24	\$111.78																																																	
25-49	\$105.89																																																	
50+	\$101.19																																																	
PRICE																																																		
1-9	\$131.23																																																	
10-24	\$124.67																																																	
25-49	\$118.11																																																	
50+	\$112.86																																																	
7	 <table border="1"> <thead> <tr><th>PRICE</th></tr> </thead> <tbody> <tr><td>1-9</td><td>\$294.61</td></tr> <tr><td>10-24</td><td>\$279.88</td></tr> <tr><td>25-49</td><td>\$265.15</td></tr> <tr><td>50+</td><td>\$253.36</td></tr> </tbody> </table> <p>7/16 DIN Female to 7/16 DIN Female Tee</p> <p>Model No: <a href="#">PE9556</a></p>	PRICE	1-9	\$294.61	10-24	\$279.88	25-49	\$265.15	50+	\$253.36	 <table border="1"> <thead> <tr><th>PRICE</th></tr> </thead> <tbody> <tr><td>1-9</td><td>\$154.56</td></tr> <tr><td>10-24</td><td>\$146.83</td></tr> <tr><td>25-49</td><td>\$139.10</td></tr> <tr><td>50+</td><td>\$132.92</td></tr> </tbody> </table> <p>Low PIM</p> <p>7/16 DIN Female to 7/16 DIN Female Bulkhead</p> <p>Max. Freq. 8 GHz</p> <p>Model No: <a href="#">PE91038</a></p>	PRICE	1-9	\$154.56	10-24	\$146.83	25-49	\$139.10	50+	\$132.92	 <table border="1"> <thead> <tr><th>PRICE</th></tr> </thead> <tbody> <tr><td>1-9</td><td>\$280.39</td></tr> <tr><td>10-24</td><td>\$266.37</td></tr> <tr><td>25-49</td><td>\$252.35</td></tr> <tr><td>50+</td><td>\$241.14</td></tr> </tbody> </table> <p>7/16 DIN Female to 7/16 DIN Female Bulkhead</p> <p>Model No: <a href="#">PE9414</a></p>	PRICE	1-9	\$280.39	10-24	\$266.37	25-49	\$252.35	50+	\$241.14	 <table border="1"> <thead> <tr><th>PRICE</th></tr> </thead> <tbody> <tr><td>1-24</td><td>\$108.90</td></tr> <tr><td>25-49</td><td>\$103.46</td></tr> <tr><td>50-99</td><td>\$98.01</td></tr> <tr><td>100+</td><td>\$93.65</td></tr> </tbody> </table> <p>7/16 DIN Female to 7/16 DIN Female Bulkhead</p> <p>VSWR 1.25:1 to 6 GHz</p> <p>Model No: <a href="#">PE91193</a></p>	PRICE	1-24	\$108.90	25-49	\$103.46	50-99	\$98.01	100+	\$93.65	 <table border="1"> <thead> <tr><th>PRICE</th></tr> </thead> <tbody> <tr><td>1-24</td><td>\$102.50</td></tr> <tr><td>25-49</td><td>\$97.38</td></tr> <tr><td>50-99</td><td>\$92.25</td></tr> <tr><td>100+</td><td>\$88.15</td></tr> </tbody> </table> <p>7/16 DIN Female to 7/16 DIN Female Bulkhead</p> <p>VSWR 1.25:1 to 6 GHz</p> <p>Model No: <a href="#">PE91230</a></p>	PRICE	1-24	\$102.50	25-49	\$97.38	50-99	\$92.25	100+	\$88.15
	PRICE																																																	
1-9	\$294.61																																																	
10-24	\$279.88																																																	
25-49	\$265.15																																																	
50+	\$253.36																																																	
PRICE																																																		
1-9	\$154.56																																																	
10-24	\$146.83																																																	
25-49	\$139.10																																																	
50+	\$132.92																																																	
PRICE																																																		
1-9	\$280.39																																																	
10-24	\$266.37																																																	
25-49	\$252.35																																																	
50+	\$241.14																																																	
PRICE																																																		
1-24	\$108.90																																																	
25-49	\$103.46																																																	
50-99	\$98.01																																																	
100+	\$93.65																																																	
PRICE																																																		
1-24	\$102.50																																																	
25-49	\$97.38																																																	
50-99	\$92.25																																																	
100+	\$88.15																																																	



Technical Support  
+1 (949) 261-1920



Same-Day Shipping,  
Even Custom  
Cable Assemblies

# ADAPTERS

See Adapter Locator on Pages 10-15

See Page 409 for Mounting Holes

Adapters

See Our Website For Current Pricing & Real-Time Stock Availability!

	A	B	C	D	E																																																		
1	<p><b>7/16 DIN Between Series</b></p> 	 <table border="1"> <thead> <tr> <th colspan="2">PRICE</th> </tr> </thead> <tbody> <tr><td>1-24</td><td>\$73.53</td></tr> <tr><td>25-49</td><td>\$69.85</td></tr> <tr><td>50-99</td><td>\$66.18</td></tr> <tr><td>100+</td><td>\$63.24</td></tr> </tbody> </table> <p>7/16 DIN Male to 4.1/9.5 Mini DIN Male VSWR 1.25:1 to 6 GHz Model No: <a href="#">PE91206</a></p>	PRICE		1-24	\$73.53	25-49	\$69.85	50-99	\$66.18	100+	\$63.24	 <table border="1"> <thead> <tr> <th colspan="2">PRICE</th> </tr> </thead> <tbody> <tr><td>1-24</td><td>\$42.91</td></tr> <tr><td>25-49</td><td>\$40.76</td></tr> <tr><td>50-99</td><td>\$38.62</td></tr> <tr><td>100+</td><td>\$36.90</td></tr> </tbody> </table> <p>7/16 DIN Male to 4.1/9.5 Mini DIN Male VSWR 1.3:1 to 6 GHz Model No: <a href="#">PE91243</a></p>	PRICE		1-24	\$42.91	25-49	\$40.76	50-99	\$38.62	100+	\$36.90	 <table border="1"> <thead> <tr> <th colspan="2">PRICE</th> </tr> </thead> <tbody> <tr><td>1-24</td><td>\$85.09</td></tr> <tr><td>25-49</td><td>\$80.84</td></tr> <tr><td>50-99</td><td>\$76.58</td></tr> <tr><td>100+</td><td>\$73.18</td></tr> </tbody> </table> <p>Low PIM 7/16 DIN Male to 4.1/9.5 Mini DIN Male VSWR 1.25:1 to 6 GHz Model No: <a href="#">PE91088</a></p>	PRICE		1-24	\$85.09	25-49	\$80.84	50-99	\$76.58	100+	\$73.18	 <table border="1"> <thead> <tr> <th colspan="2">PRICE</th> </tr> </thead> <tbody> <tr><td>1-24</td><td>\$64.33</td></tr> <tr><td>25-49</td><td>\$61.11</td></tr> <tr><td>50-99</td><td>\$57.90</td></tr> <tr><td>100+</td><td>\$55.32</td></tr> </tbody> </table> <p>7/16 DIN Male to 4.1/9.5 Mini DIN Female VSWR 1.25:1 to 6 GHz Model No: <a href="#">PE91207</a></p>	PRICE		1-24	\$64.33	25-49	\$61.11	50-99	\$57.90	100+	\$55.32										
PRICE																																																							
1-24	\$73.53																																																						
25-49	\$69.85																																																						
50-99	\$66.18																																																						
100+	\$63.24																																																						
PRICE																																																							
1-24	\$42.91																																																						
25-49	\$40.76																																																						
50-99	\$38.62																																																						
100+	\$36.90																																																						
PRICE																																																							
1-24	\$85.09																																																						
25-49	\$80.84																																																						
50-99	\$76.58																																																						
100+	\$73.18																																																						
PRICE																																																							
1-24	\$64.33																																																						
25-49	\$61.11																																																						
50-99	\$57.90																																																						
100+	\$55.32																																																						
2	 <table border="1"> <thead> <tr> <th colspan="2">PRICE</th> </tr> </thead> <tbody> <tr><td>1-24</td><td>\$39.78</td></tr> <tr><td>25-49</td><td>\$37.79</td></tr> <tr><td>50-99</td><td>\$35.80</td></tr> <tr><td>100+</td><td>\$34.21</td></tr> </tbody> </table> <p>7/16 DIN Male to 4.1/9.5 Mini DIN Female VSWR 1.25:1 to 6 GHz Model No: <a href="#">PE91244</a></p>	PRICE		1-24	\$39.78	25-49	\$37.79	50-99	\$35.80	100+	\$34.21	 <table border="1"> <thead> <tr> <th colspan="2">PRICE</th> </tr> </thead> <tbody> <tr><td>1-24</td><td>\$40.72</td></tr> <tr><td>25-49</td><td>\$38.68</td></tr> <tr><td>50-99</td><td>\$36.65</td></tr> <tr><td>100+</td><td>\$35.02</td></tr> </tbody> </table> <p>Low PIM 7/16 DIN Male to 4.3-10 Male VSWR 1.25:1 to 6 GHz Model No: <a href="#">PE91468</a></p>	PRICE		1-24	\$40.72	25-49	\$38.68	50-99	\$36.65	100+	\$35.02	 <table border="1"> <thead> <tr> <th colspan="2">PRICE</th> </tr> </thead> <tbody> <tr><td>1-24</td><td>\$44.10</td></tr> <tr><td>25-49</td><td>\$41.90</td></tr> <tr><td>50-99</td><td>\$39.69</td></tr> <tr><td>100+</td><td>\$37.93</td></tr> </tbody> </table> <p>Low PIM 7/16 DIN Male to 4.3-10 Female VSWR 1.25:1 to 6 GHz Model No: <a href="#">PE91469</a></p>	PRICE		1-24	\$44.10	25-49	\$41.90	50-99	\$39.69	100+	\$37.93	 <table border="1"> <thead> <tr> <th colspan="2">PRICE</th> </tr> </thead> <tbody> <tr><td>1-24</td><td>\$76.11</td></tr> <tr><td>25-49</td><td>\$72.30</td></tr> <tr><td>50-99</td><td>\$68.50</td></tr> <tr><td>100+</td><td>\$65.45</td></tr> </tbody> </table> <p>Low PIM 7/16 DIN Male to 4.3-10 Female VSWR 1.08:1 to 6 GHz Model No: <a href="#">PE91390</a></p>	PRICE		1-24	\$76.11	25-49	\$72.30	50-99	\$68.50	100+	\$65.45	 <table border="1"> <thead> <tr> <th colspan="2">PRICE</th> </tr> </thead> <tbody> <tr><td>1-9</td><td>\$160.81</td></tr> <tr><td>10-24</td><td>\$152.77</td></tr> <tr><td>25-49</td><td>\$144.73</td></tr> <tr><td>50+</td><td>\$138.30</td></tr> </tbody> </table> <p>7/16 DIN Male to HN Female Model No: <a href="#">PE9558</a></p>	PRICE		1-9	\$160.81	10-24	\$152.77	25-49	\$144.73	50+	\$138.30
PRICE																																																							
1-24	\$39.78																																																						
25-49	\$37.79																																																						
50-99	\$35.80																																																						
100+	\$34.21																																																						
PRICE																																																							
1-24	\$40.72																																																						
25-49	\$38.68																																																						
50-99	\$36.65																																																						
100+	\$35.02																																																						
PRICE																																																							
1-24	\$44.10																																																						
25-49	\$41.90																																																						
50-99	\$39.69																																																						
100+	\$37.93																																																						
PRICE																																																							
1-24	\$76.11																																																						
25-49	\$72.30																																																						
50-99	\$68.50																																																						
100+	\$65.45																																																						
PRICE																																																							
1-9	\$160.81																																																						
10-24	\$152.77																																																						
25-49	\$144.73																																																						
50+	\$138.30																																																						
3	 <table border="1"> <thead> <tr> <th colspan="2">PRICE</th> </tr> </thead> <tbody> <tr><td>1-24</td><td>\$71.77</td></tr> <tr><td>25-49</td><td>\$68.18</td></tr> <tr><td>50-99</td><td>\$64.59</td></tr> <tr><td>100+</td><td>\$61.72</td></tr> </tbody> </table> <p>7/16 DIN Male to N Male VSWR 1.15:1 to 6 GHz Model No: <a href="#">PE91211</a></p>	PRICE		1-24	\$71.77	25-49	\$68.18	50-99	\$64.59	100+	\$61.72	 <table border="1"> <thead> <tr> <th colspan="2">PRICE</th> </tr> </thead> <tbody> <tr><td>1-24</td><td>\$89.91</td></tr> <tr><td>25-49</td><td>\$85.41</td></tr> <tr><td>50-99</td><td>\$80.92</td></tr> <tr><td>100+</td><td>\$77.32</td></tr> </tbody> </table> <p>7/16 DIN Male to N Male VSWR 1.25:1 to 6 GHz Model No: <a href="#">PE91248</a></p>	PRICE		1-24	\$89.91	25-49	\$85.41	50-99	\$80.92	100+	\$77.32	 <table border="1"> <thead> <tr> <th colspan="2">PRICE</th> </tr> </thead> <tbody> <tr><td>1-24</td><td>\$69.15</td></tr> <tr><td>25-49</td><td>\$65.69</td></tr> <tr><td>50-99</td><td>\$62.24</td></tr> <tr><td>100+</td><td>\$59.47</td></tr> </tbody> </table> <p>7/16 DIN Male to N Female VSWR 1.15:1 to 6 GHz Model No: <a href="#">PE91212</a></p>	PRICE		1-24	\$69.15	25-49	\$65.69	50-99	\$62.24	100+	\$59.47	 <table border="1"> <thead> <tr> <th colspan="2">PRICE</th> </tr> </thead> <tbody> <tr><td>1-24</td><td>\$52.66</td></tr> <tr><td>25-49</td><td>\$50.03</td></tr> <tr><td>50-99</td><td>\$47.39</td></tr> <tr><td>100+</td><td>\$45.29</td></tr> </tbody> </table> <p>7/16 DIN Male to N Female VSWR 1.25:1 to 6 GHz Model No: <a href="#">PE91249</a></p>	PRICE		1-24	\$52.66	25-49	\$50.03	50-99	\$47.39	100+	\$45.29	 <table border="1"> <thead> <tr> <th colspan="2">PRICE</th> </tr> </thead> <tbody> <tr><td>1-9</td><td>\$196.93</td></tr> <tr><td>10-24</td><td>\$187.08</td></tr> <tr><td>25-49</td><td>\$177.24</td></tr> <tr><td>50+</td><td>\$169.36</td></tr> </tbody> </table> <p>7/16 DIN Male to SC Female VSWR 1.25:1 to 7.5 GHz Model No: <a href="#">PE91444</a></p>	PRICE		1-9	\$196.93	10-24	\$187.08	25-49	\$177.24	50+	\$169.36
PRICE																																																							
1-24	\$71.77																																																						
25-49	\$68.18																																																						
50-99	\$64.59																																																						
100+	\$61.72																																																						
PRICE																																																							
1-24	\$89.91																																																						
25-49	\$85.41																																																						
50-99	\$80.92																																																						
100+	\$77.32																																																						
PRICE																																																							
1-24	\$69.15																																																						
25-49	\$65.69																																																						
50-99	\$62.24																																																						
100+	\$59.47																																																						
PRICE																																																							
1-24	\$52.66																																																						
25-49	\$50.03																																																						
50-99	\$47.39																																																						
100+	\$45.29																																																						
PRICE																																																							
1-9	\$196.93																																																						
10-24	\$187.08																																																						
25-49	\$177.24																																																						
50+	\$169.36																																																						
4	 <table border="1"> <thead> <tr> <th colspan="2">PRICE</th> </tr> </thead> <tbody> <tr><td>1-24</td><td>\$74.94</td></tr> <tr><td>25-49</td><td>\$71.19</td></tr> <tr><td>50-99</td><td>\$67.45</td></tr> <tr><td>100+</td><td>\$64.45</td></tr> </tbody> </table> <p>7/16 DIN Female to 4.1/9.5 Mini DIN Male VSWR 1.25:1 to 6 GHz Model No: <a href="#">PE91209</a></p>	PRICE		1-24	\$74.94	25-49	\$71.19	50-99	\$67.45	100+	\$64.45	 <table border="1"> <thead> <tr> <th colspan="2">PRICE</th> </tr> </thead> <tbody> <tr><td>1-24</td><td>\$37.39</td></tr> <tr><td>25-49</td><td>\$35.52</td></tr> <tr><td>50-99</td><td>\$33.65</td></tr> <tr><td>100+</td><td>\$32.16</td></tr> </tbody> </table> <p>7/16 DIN Female to 4.1/9.5 Mini DIN Male VSWR 1.25:1 to 6 GHz Model No: <a href="#">PE91246</a></p>	PRICE		1-24	\$37.39	25-49	\$35.52	50-99	\$33.65	100+	\$32.16	 <table border="1"> <thead> <tr> <th colspan="2">PRICE</th> </tr> </thead> <tbody> <tr><td>1-24</td><td>\$85.09</td></tr> <tr><td>25-49</td><td>\$80.84</td></tr> <tr><td>50-99</td><td>\$76.58</td></tr> <tr><td>100+</td><td>\$73.18</td></tr> </tbody> </table> <p>Low PIM 7/16 DIN Female to 4.1/9.5 Mini DIN Male VSWR 1.25:1 to 6 GHz Model No: <a href="#">PE91090</a></p>	PRICE		1-24	\$85.09	25-49	\$80.84	50-99	\$76.58	100+	\$73.18	 <table border="1"> <thead> <tr> <th colspan="2">PRICE</th> </tr> </thead> <tbody> <tr><td>1-24</td><td>\$68.11</td></tr> <tr><td>25-49</td><td>\$64.70</td></tr> <tr><td>50-99</td><td>\$61.30</td></tr> <tr><td>100+</td><td>\$58.57</td></tr> </tbody> </table> <p>7/16 DIN Female to 4.1/9.5 Mini DIN Female VSWR 1.25:1 to 6 GHz Model No: <a href="#">PE91208</a></p>	PRICE		1-24	\$68.11	25-49	\$64.70	50-99	\$61.30	100+	\$58.57	 <table border="1"> <thead> <tr> <th colspan="2">PRICE</th> </tr> </thead> <tbody> <tr><td>1-24</td><td>\$36.13</td></tr> <tr><td>25-49</td><td>\$34.32</td></tr> <tr><td>50-99</td><td>\$32.52</td></tr> <tr><td>100+</td><td>\$31.07</td></tr> </tbody> </table> <p>7/16 DIN Female to 4.1/9.5 Mini DIN Female VSWR 1.35:1 to 6 GHz Model No: <a href="#">PE91245</a></p>	PRICE		1-24	\$36.13	25-49	\$34.32	50-99	\$32.52	100+	\$31.07
PRICE																																																							
1-24	\$74.94																																																						
25-49	\$71.19																																																						
50-99	\$67.45																																																						
100+	\$64.45																																																						
PRICE																																																							
1-24	\$37.39																																																						
25-49	\$35.52																																																						
50-99	\$33.65																																																						
100+	\$32.16																																																						
PRICE																																																							
1-24	\$85.09																																																						
25-49	\$80.84																																																						
50-99	\$76.58																																																						
100+	\$73.18																																																						
PRICE																																																							
1-24	\$68.11																																																						
25-49	\$64.70																																																						
50-99	\$61.30																																																						
100+	\$58.57																																																						
PRICE																																																							
1-24	\$36.13																																																						
25-49	\$34.32																																																						
50-99	\$32.52																																																						
100+	\$31.07																																																						
5	 <table border="1"> <thead> <tr> <th colspan="2">PRICE</th> </tr> </thead> <tbody> <tr><td>1-24</td><td>\$85.09</td></tr> <tr><td>25-49</td><td>\$80.84</td></tr> <tr><td>50-99</td><td>\$76.58</td></tr> <tr><td>100+</td><td>\$73.18</td></tr> </tbody> </table> <p>Low PIM 7/16 DIN Female to 4.1/9.5 Mini DIN Female VSWR 1.25:1 to 6 GHz Model No: <a href="#">PE91091</a></p>	PRICE		1-24	\$85.09	25-49	\$80.84	50-99	\$76.58	100+	\$73.18	 <table border="1"> <thead> <tr> <th colspan="2">PRICE</th> </tr> </thead> <tbody> <tr><td>1-24</td><td>\$37.86</td></tr> <tr><td>25-49</td><td>\$35.97</td></tr> <tr><td>50-99</td><td>\$34.07</td></tr> <tr><td>100+</td><td>\$32.56</td></tr> </tbody> </table> <p>7/16 DIN Female to 4.1/9.5 Mini DIN Female Bulkhead VSWR 1.3:1 to 6 GHz Model No: <a href="#">PE91247</a></p>	PRICE		1-24	\$37.86	25-49	\$35.97	50-99	\$34.07	100+	\$32.56	 <table border="1"> <thead> <tr> <th colspan="2">PRICE</th> </tr> </thead> <tbody> <tr><td>1-24</td><td>\$43.25</td></tr> <tr><td>25-49</td><td>\$41.09</td></tr> <tr><td>50-99</td><td>\$38.93</td></tr> <tr><td>100+</td><td>\$37.20</td></tr> </tbody> </table> <p>Low PIM 7/16 DIN Female to 4.3-10 Male VSWR 1.2:1 to 6 GHz Model No: <a href="#">PE91470</a></p>	PRICE		1-24	\$43.25	25-49	\$41.09	50-99	\$38.93	100+	\$37.20	 <table border="1"> <thead> <tr> <th colspan="2">PRICE</th> </tr> </thead> <tbody> <tr><td>1-24</td><td>\$59.55</td></tr> <tr><td>25-49</td><td>\$56.57</td></tr> <tr><td>50-99</td><td>\$53.60</td></tr> <tr><td>100+</td><td>\$51.21</td></tr> </tbody> </table> <p>Low PIM 7/16 DIN Female to QD 4.3-10 Male VSWR 1.2:1 to 6 GHz Model No: <a href="#">PE91472</a></p>	PRICE		1-24	\$59.55	25-49	\$56.57	50-99	\$53.60	100+	\$51.21	 <table border="1"> <thead> <tr> <th colspan="2">PRICE</th> </tr> </thead> <tbody> <tr><td>1-9</td><td>\$121.83</td></tr> <tr><td>10-24</td><td>\$115.74</td></tr> <tr><td>25-49</td><td>\$109.65</td></tr> <tr><td>50+</td><td>\$104.77</td></tr> </tbody> </table> <p>Low PIM 7/16 DIN Female to 4.3-10 Male VSWR 1.08:1 to 6 GHz Model No: <a href="#">PE91391</a></p>	PRICE		1-9	\$121.83	10-24	\$115.74	25-49	\$109.65	50+	\$104.77
PRICE																																																							
1-24	\$85.09																																																						
25-49	\$80.84																																																						
50-99	\$76.58																																																						
100+	\$73.18																																																						
PRICE																																																							
1-24	\$37.86																																																						
25-49	\$35.97																																																						
50-99	\$34.07																																																						
100+	\$32.56																																																						
PRICE																																																							
1-24	\$43.25																																																						
25-49	\$41.09																																																						
50-99	\$38.93																																																						
100+	\$37.20																																																						
PRICE																																																							
1-24	\$59.55																																																						
25-49	\$56.57																																																						
50-99	\$53.60																																																						
100+	\$51.21																																																						
PRICE																																																							
1-9	\$121.83																																																						
10-24	\$115.74																																																						
25-49	\$109.65																																																						
50+	\$104.77																																																						
6	 <table border="1"> <thead> <tr> <th colspan="2">PRICE</th> </tr> </thead> <tbody> <tr><td>1-24</td><td>\$44.10</td></tr> <tr><td>25-49</td><td>\$41.90</td></tr> <tr><td>50-99</td><td>\$39.69</td></tr> <tr><td>100+</td><td>\$37.93</td></tr> </tbody> </table> <p>Low PIM 7/16 DIN Female to 4.3-10 Female VSWR 1.25:1 to 6 GHz Model No: <a href="#">PE91471</a></p>	PRICE		1-24	\$44.10	25-49	\$41.90	50-99	\$39.69	100+	\$37.93	 <table border="1"> <thead> <tr> <th colspan="2">PRICE</th> </tr> </thead> <tbody> <tr><td>1-24</td><td>\$44.18</td></tr> <tr><td>25-49</td><td>\$41.97</td></tr> <tr><td>50-99</td><td>\$39.76</td></tr> <tr><td>100+</td><td>\$37.99</td></tr> </tbody> </table> <p>Low PIM 7/16 DIN Female to QD 4.3-10 Female VSWR 1.2:1 to 6 GHz Model No: <a href="#">PE91473</a></p>	PRICE		1-24	\$44.18	25-49	\$41.97	50-99	\$39.76	100+	\$37.99	 <table border="1"> <thead> <tr> <th colspan="2">PRICE</th> </tr> </thead> <tbody> <tr><td>1-9</td><td>\$175.25</td></tr> <tr><td>10-24</td><td>\$166.49</td></tr> <tr><td>25-49</td><td>\$157.73</td></tr> <tr><td>50+</td><td>\$150.72</td></tr> </tbody> </table> <p>7/16 DIN Female to HN Male Model No: <a href="#">PE9559</a></p>	PRICE		1-9	\$175.25	10-24	\$166.49	25-49	\$157.73	50+	\$150.72	 <table border="1"> <thead> <tr> <th colspan="2">PRICE</th> </tr> </thead> <tbody> <tr><td>1-24</td><td>\$66.45</td></tr> <tr><td>25-49</td><td>\$63.13</td></tr> <tr><td>50-99</td><td>\$59.81</td></tr> <tr><td>100+</td><td>\$57.15</td></tr> </tbody> </table> <p>7/16 DIN Female to N Male VSWR 1.25:1 to 6 GHz Model No: <a href="#">PE91214</a></p>	PRICE		1-24	\$66.45	25-49	\$63.13	50-99	\$59.81	100+	\$57.15	 <table border="1"> <thead> <tr> <th colspan="2">PRICE</th> </tr> </thead> <tbody> <tr><td>1-24</td><td>\$53.37</td></tr> <tr><td>25-49</td><td>\$50.70</td></tr> <tr><td>50-99</td><td>\$48.03</td></tr> <tr><td>100+</td><td>\$45.90</td></tr> </tbody> </table> <p>7/16 DIN Female to N Male VSWR 1.25:1 to 6 GHz Model No: <a href="#">PE91251</a></p>	PRICE		1-24	\$53.37	25-49	\$50.70	50-99	\$48.03	100+	\$45.90
PRICE																																																							
1-24	\$44.10																																																						
25-49	\$41.90																																																						
50-99	\$39.69																																																						
100+	\$37.93																																																						
PRICE																																																							
1-24	\$44.18																																																						
25-49	\$41.97																																																						
50-99	\$39.76																																																						
100+	\$37.99																																																						
PRICE																																																							
1-9	\$175.25																																																						
10-24	\$166.49																																																						
25-49	\$157.73																																																						
50+	\$150.72																																																						
PRICE																																																							
1-24	\$66.45																																																						
25-49	\$63.13																																																						
50-99	\$59.81																																																						
100+	\$57.15																																																						
PRICE																																																							
1-24	\$53.37																																																						
25-49	\$50.70																																																						
50-99	\$48.03																																																						
100+	\$45.90																																																						
7	 <table border="1"> <thead> <tr> <th colspan="2">PRICE</th> </tr> </thead> <tbody> <tr><td>1-24</td><td>\$66.45</td></tr> <tr><td>25-49</td><td>\$63.13</td></tr> <tr><td>50-99</td><td>\$59.81</td></tr> <tr><td>100+</td><td>\$57.15</td></tr> </tbody> </table> <p>7/16 DIN Female to N Female VSWR 1.15:1 to 6 GHz Model No: <a href="#">PE91213</a></p>	PRICE		1-24	\$66.45	25-49	\$63.13	50-99	\$59.81	100+	\$57.15	 <table border="1"> <thead> <tr> <th colspan="2">PRICE</th> </tr> </thead> <tbody> <tr><td>1-24</td><td>\$54.22</td></tr> <tr><td>25-49</td><td>\$51.51</td></tr> <tr><td>50-99</td><td>\$48.80</td></tr> <tr><td>100+</td><td>\$46.63</td></tr> </tbody> </table> <p>7/16 DIN Female to N Female VSWR 1.25:1 to 6 GHz Model No: <a href="#">PE91250</a></p>	PRICE		1-24	\$54.22	25-49	\$51.51	50-99	\$48.80	100+	\$46.63	 <table border="1"> <thead> <tr> <th colspan="2">PRICE</th> </tr> </thead> <tbody> <tr><td>1-24</td><td>\$92.60</td></tr> <tr><td>25-49</td><td>\$87.97</td></tr> <tr><td>50-99</td><td>\$83.34</td></tr> <tr><td>100+</td><td>\$79.64</td></tr> </tbody> </table> <p>7/16 DIN Female to N Female Bulkhead VSWR 1.15:1 to 6 GHz Model No: <a href="#">PE91215</a></p>	PRICE		1-24	\$92.60	25-49	\$87.97	50-99	\$83.34	100+	\$79.64	 <table border="1"> <thead> <tr> <th colspan="2">PRICE</th> </tr> </thead> <tbody> <tr><td>1-24</td><td>\$49.35</td></tr> <tr><td>25-49</td><td>\$46.88</td></tr> <tr><td>50-99</td><td>\$44.42</td></tr> <tr><td>100+</td><td>\$42.44</td></tr> </tbody> </table> <p>7/16 DIN Female to N Female Bulkhead VSWR 1.25:1 to 6 GHz Model No: <a href="#">PE91252</a></p>	PRICE		1-24	\$49.35	25-49	\$46.88	50-99	\$44.42	100+	\$42.44	<p><b>10-32 In-Series</b></p> 										
PRICE																																																							
1-24	\$66.45																																																						
25-49	\$63.13																																																						
50-99	\$59.81																																																						
100+	\$57.15																																																						
PRICE																																																							
1-24	\$54.22																																																						
25-49	\$51.51																																																						
50-99	\$48.80																																																						
100+	\$46.63																																																						
PRICE																																																							
1-24	\$92.60																																																						
25-49	\$87.97																																																						
50-99	\$83.34																																																						
100+	\$79.64																																																						
PRICE																																																							
1-24	\$49.35																																																						
25-49	\$46.88																																																						
50-99	\$44.42																																																						
100+	\$42.44																																																						

# ADAPTERS

See Adapter Locator on Pages 10-15

See Page 409 for Mounting Holes

	A	B	C	D	E																																													
1	 <table border="1"> <thead> <tr><th>PRICE</th></tr> </thead> <tbody> <tr><td>1-24</td><td>\$49.94</td></tr> <tr><td>25-49</td><td>\$47.44</td></tr> <tr><td>50-99</td><td>\$44.95</td></tr> <tr><td>100+</td><td>\$42.95</td></tr> </tbody> </table> <p>10-32 Female to 10-32 Female</p> <p>Model No: <a href="#">PE9756</a></p>	PRICE	1-24	\$49.94	25-49	\$47.44	50-99	\$44.95	100+	\$42.95	 <table border="1"> <thead> <tr><th>PRICE</th></tr> </thead> <tbody> <tr><td>1-24</td><td>\$72.31</td></tr> <tr><td>25-49</td><td>\$68.69</td></tr> <tr><td>50-99</td><td>\$65.08</td></tr> <tr><td>100+</td><td>\$62.19</td></tr> </tbody> </table> <p>10-32 Female to 10-32 Female Bulkhead</p> <p>Model No: <a href="#">PE9757</a></p>	PRICE	1-24	\$72.31	25-49	\$68.69	50-99	\$65.08	100+	\$62.19	<p><b>10-32 Between Series</b></p> <p>→</p>		 <table border="1"> <thead> <tr><th>PRICE</th></tr> </thead> <tbody> <tr><td>1-24</td><td>\$92.50</td></tr> <tr><td>25-49</td><td>\$87.88</td></tr> <tr><td>50-99</td><td>\$83.25</td></tr> <tr><td>100+</td><td>\$79.55</td></tr> </tbody> </table> <p>10-32 Male to BNC Male</p> <p>Model No: <a href="#">PE9751</a></p>	PRICE	1-24	\$92.50	25-49	\$87.88	50-99	\$83.25	100+	\$79.55	 <table border="1"> <thead> <tr><th>PRICE</th></tr> </thead> <tbody> <tr><td>1-24</td><td>\$83.97</td></tr> <tr><td>25-49</td><td>\$79.77</td></tr> <tr><td>50-99</td><td>\$75.57</td></tr> <tr><td>100+</td><td>\$72.21</td></tr> </tbody> </table> <p>10-32 Male to BNC Female</p> <p>Model No: <a href="#">PE9753</a></p>	PRICE	1-24	\$83.97	25-49	\$79.77	50-99	\$75.57	100+	\$72.21								
	PRICE																																																	
1-24	\$49.94																																																	
25-49	\$47.44																																																	
50-99	\$44.95																																																	
100+	\$42.95																																																	
PRICE																																																		
1-24	\$72.31																																																	
25-49	\$68.69																																																	
50-99	\$65.08																																																	
100+	\$62.19																																																	
PRICE																																																		
1-24	\$92.50																																																	
25-49	\$87.88																																																	
50-99	\$83.25																																																	
100+	\$79.55																																																	
PRICE																																																		
1-24	\$83.97																																																	
25-49	\$79.77																																																	
50-99	\$75.57																																																	
100+	\$72.21																																																	
2	 <table border="1"> <thead> <tr><th>PRICE</th></tr> </thead> <tbody> <tr><td>1-24</td><td>\$108.73</td></tr> <tr><td>25-49</td><td>\$103.29</td></tr> <tr><td>50-99</td><td>\$97.86</td></tr> <tr><td>100+</td><td>\$93.51</td></tr> </tbody> </table> <p>10-32 Male to BNC Female Bulkhead</p> <p>Model No: <a href="#">PE9755</a></p>	PRICE	1-24	\$108.73	25-49	\$103.29	50-99	\$97.86	100+	\$93.51	 <table border="1"> <thead> <tr><th>PRICE</th></tr> </thead> <tbody> <tr><td>1-24</td><td>\$69.20</td></tr> <tr><td>25-49</td><td>\$65.74</td></tr> <tr><td>50-99</td><td>\$62.28</td></tr> <tr><td>100+</td><td>\$59.51</td></tr> </tbody> </table> <p>10-32 Female to BNC Male</p> <p>Model No: <a href="#">PE9750</a></p>	PRICE	1-24	\$69.20	25-49	\$65.74	50-99	\$62.28	100+	\$59.51	 <table border="1"> <thead> <tr><th>PRICE</th></tr> </thead> <tbody> <tr><td>1-24</td><td>\$75.43</td></tr> <tr><td>25-49</td><td>\$71.66</td></tr> <tr><td>50-99</td><td>\$67.89</td></tr> <tr><td>100+</td><td>\$64.87</td></tr> </tbody> </table> <p>10-32 Female to BNC Female</p> <p>Model No: <a href="#">PE9752</a></p>	PRICE	1-24	\$75.43	25-49	\$71.66	50-99	\$67.89	100+	\$64.87	 <table border="1"> <thead> <tr><th>PRICE</th></tr> </thead> <tbody> <tr><td>1-24</td><td>\$70.94</td></tr> <tr><td>25-49</td><td>\$67.39</td></tr> <tr><td>50-99</td><td>\$63.85</td></tr> <tr><td>100+</td><td>\$61.01</td></tr> </tbody> </table> <p>10-32 Female to BNC Female Bulkhead</p> <p>Model No: <a href="#">PE9754</a></p>	PRICE	1-24	\$70.94	25-49	\$67.39	50-99	\$63.85	100+	\$61.01	<p><b>BMA In-Series</b></p> <p>→</p>									
	PRICE																																																	
1-24	\$108.73																																																	
25-49	\$103.29																																																	
50-99	\$97.86																																																	
100+	\$93.51																																																	
PRICE																																																		
1-24	\$69.20																																																	
25-49	\$65.74																																																	
50-99	\$62.28																																																	
100+	\$59.51																																																	
PRICE																																																		
1-24	\$75.43																																																	
25-49	\$71.66																																																	
50-99	\$67.89																																																	
100+	\$64.87																																																	
PRICE																																																		
1-24	\$70.94																																																	
25-49	\$67.39																																																	
50-99	\$63.85																																																	
100+	\$61.01																																																	
3	 <table border="1"> <thead> <tr><th>PRICE</th></tr> </thead> <tbody> <tr><td>1-24</td><td>\$59.74</td></tr> <tr><td>25-49</td><td>\$56.75</td></tr> <tr><td>50-99</td><td>\$53.77</td></tr> <tr><td>100+</td><td>\$51.38</td></tr> </tbody> </table> <p>Slide-On BMA Jack to Slide-On BMA Jack</p> <p>VSWR 1.2:1 to 22 GHz</p> <p>Model No: <a href="#">PE91395</a></p>	PRICE	1-24	\$59.74	25-49	\$56.75	50-99	\$53.77	100+	\$51.38	<p><b>BMA Between Series</b></p> <p>→</p>		 <table border="1"> <thead> <tr><th>PRICE</th></tr> </thead> <tbody> <tr><td>1-9</td><td>\$110.97</td></tr> <tr><td>10-24</td><td>\$105.42</td></tr> <tr><td>25-49</td><td>\$99.87</td></tr> <tr><td>50+</td><td>\$95.43</td></tr> </tbody> </table> <p>Slide-On BMA Plug to SMA Male</p> <p>VSWR 1.15:1 to 18 GHz</p> <p>Model No: <a href="#">PE91396</a></p>	PRICE	1-9	\$110.97	10-24	\$105.42	25-49	\$99.87	50+	\$95.43	 <table border="1"> <thead> <tr><th>PRICE</th></tr> </thead> <tbody> <tr><td>1-24</td><td>\$105.14</td></tr> <tr><td>25-49</td><td>\$99.88</td></tr> <tr><td>50-99</td><td>\$94.63</td></tr> <tr><td>100+</td><td>\$90.42</td></tr> </tbody> </table> <p>Slide-On BMA Plug to SMA Male Bulkhead</p> <p>VSWR 1.15:1 to 18 GHz</p> <p>Model No: <a href="#">PE91401</a></p>	PRICE	1-24	\$105.14	25-49	\$99.88	50-99	\$94.63	100+	\$90.42	 <table border="1"> <thead> <tr><th>PRICE</th></tr> </thead> <tbody> <tr><td>1-9</td><td>\$107.96</td></tr> <tr><td>10-24</td><td>\$102.56</td></tr> <tr><td>25-49</td><td>\$97.16</td></tr> <tr><td>50+</td><td>\$92.85</td></tr> </tbody> </table> <p>Slide-On BMA Plug to SMA Female</p> <p>VSWR 1.15:1 to 18 GHz</p> <p>Model No: <a href="#">PE91398</a></p>	PRICE	1-9	\$107.96	10-24	\$102.56	25-49	\$97.16	50+	\$92.85								
	PRICE																																																	
1-24	\$59.74																																																	
25-49	\$56.75																																																	
50-99	\$53.77																																																	
100+	\$51.38																																																	
PRICE																																																		
1-9	\$110.97																																																	
10-24	\$105.42																																																	
25-49	\$99.87																																																	
50+	\$95.43																																																	
PRICE																																																		
1-24	\$105.14																																																	
25-49	\$99.88																																																	
50-99	\$94.63																																																	
100+	\$90.42																																																	
PRICE																																																		
1-9	\$107.96																																																	
10-24	\$102.56																																																	
25-49	\$97.16																																																	
50+	\$92.85																																																	
4	 <table border="1"> <thead> <tr><th>PRICE</th></tr> </thead> <tbody> <tr><td>1-9</td><td>\$128.44</td></tr> <tr><td>10-24</td><td>\$122.02</td></tr> <tr><td>25-49</td><td>\$115.60</td></tr> <tr><td>50+</td><td>\$110.46</td></tr> </tbody> </table> <p>Slide-On BMA Plug to SMA Female Bulkhead</p> <p>VSWR 1.15:1 to 18 GHz</p> <p>Model No: <a href="#">PE91402</a></p>	PRICE	1-9	\$128.44	10-24	\$122.02	25-49	\$115.60	50+	\$110.46	 <table border="1"> <thead> <tr><th>PRICE</th></tr> </thead> <tbody> <tr><td>1-9</td><td>\$132.95</td></tr> <tr><td>10-24</td><td>\$126.30</td></tr> <tr><td>25-49</td><td>\$119.66</td></tr> <tr><td>50+</td><td>\$114.34</td></tr> </tbody> </table> <p>Slide-On BMA Jack to SMA Male</p> <p>VSWR 1.25:1 to 18 GHz</p> <p>Model No: <a href="#">PE91397</a></p>	PRICE	1-9	\$132.95	10-24	\$126.30	25-49	\$119.66	50+	\$114.34	 <table border="1"> <thead> <tr><th>PRICE</th></tr> </thead> <tbody> <tr><td>1-9</td><td>\$156.65</td></tr> <tr><td>10-24</td><td>\$148.82</td></tr> <tr><td>25-49</td><td>\$140.99</td></tr> <tr><td>50+</td><td>\$134.72</td></tr> </tbody> </table> <p>Slide-On BMA Jack to SMA Female</p> <p>VSWR 1.25:1 to 18 GHz</p> <p>Model No: <a href="#">PE91400</a></p>	PRICE	1-9	\$156.65	10-24	\$148.82	25-49	\$140.99	50+	\$134.72	 <table border="1"> <thead> <tr><th>PRICE</th></tr> </thead> <tbody> <tr><td>1-9</td><td>\$142.63</td></tr> <tr><td>10-24</td><td>\$135.50</td></tr> <tr><td>25-49</td><td>\$128.37</td></tr> <tr><td>50+</td><td>\$122.66</td></tr> </tbody> </table> <p>Slide-On BMA Jack to SMA Female 2 Hole Flange</p> <p>VSWR 1.25:1 to 18 GHz</p> <p>Model No: <a href="#">PE91399</a></p>	PRICE	1-9	\$142.63	10-24	\$135.50	25-49	\$128.37	50+	\$122.66	<p><b>BNC In-Series</b></p> <p>→</p>									
	PRICE																																																	
1-9	\$128.44																																																	
10-24	\$122.02																																																	
25-49	\$115.60																																																	
50+	\$110.46																																																	
PRICE																																																		
1-9	\$132.95																																																	
10-24	\$126.30																																																	
25-49	\$119.66																																																	
50+	\$114.34																																																	
PRICE																																																		
1-9	\$156.65																																																	
10-24	\$148.82																																																	
25-49	\$140.99																																																	
50+	\$134.72																																																	
PRICE																																																		
1-9	\$142.63																																																	
10-24	\$135.50																																																	
25-49	\$128.37																																																	
50+	\$122.66																																																	
5	 <table border="1"> <thead> <tr><th>PRICE</th></tr> </thead> <tbody> <tr><td>1-24</td><td>\$23.87</td></tr> <tr><td>25-49</td><td>\$22.68</td></tr> <tr><td>50-99</td><td>\$21.48</td></tr> <tr><td>100+</td><td>\$20.53</td></tr> </tbody> </table> <p>BNC Male to BNC Male</p> <p>VSWR 1.3:1 to 1,000 MHz</p> <p>Model No: <a href="#">PE9000</a></p>	PRICE	1-24	\$23.87	25-49	\$22.68	50-99	\$21.48	100+	\$20.53	 <table border="1"> <thead> <tr><th>PRICE</th></tr> </thead> <tbody> <tr><td>1-24</td><td>\$62.58</td></tr> <tr><td>25-49</td><td>\$59.45</td></tr> <tr><td>50-99</td><td>\$56.32</td></tr> <tr><td>100+</td><td>\$53.82</td></tr> </tbody> </table> <p>BNC Male to BNC Male Right Angle</p> <p>Max. Freq. 4 GHz</p> <p>Model No: <a href="#">PE9758</a></p>	PRICE	1-24	\$62.58	25-49	\$59.45	50-99	\$56.32	100+	\$53.82	 <table border="1"> <thead> <tr><th>PRICE</th></tr> </thead> <tbody> <tr><td>1-24</td><td>\$38.91</td></tr> <tr><td>25-49</td><td>\$36.96</td></tr> <tr><td>50-99</td><td>\$35.02</td></tr> <tr><td>100+</td><td>\$33.46</td></tr> </tbody> </table> <p>BNC Male to BNC Female</p> <p>VSWR 1.3:1 to 4 GHz</p> <p>Model No: <a href="#">PE9269</a></p>	PRICE	1-24	\$38.91	25-49	\$36.96	50-99	\$35.02	100+	\$33.46	 <table border="1"> <thead> <tr><th>PRICE</th></tr> </thead> <tbody> <tr><td>1-24</td><td>\$30.32</td></tr> <tr><td>25-49</td><td>\$28.80</td></tr> <tr><td>50-99</td><td>\$27.29</td></tr> <tr><td>100+</td><td>\$26.08</td></tr> </tbody> </table> <p>BNC Male to BNC Female Right Angle</p> <p>Max. Freq. 4 GHz</p> <p>Model No: <a href="#">PE9085</a></p>	PRICE	1-24	\$30.32	25-49	\$28.80	50-99	\$27.29	100+	\$26.08	 <table border="1"> <thead> <tr><th>PRICE</th></tr> </thead> <tbody> <tr><td>1-24</td><td>\$54.69</td></tr> <tr><td>25-49</td><td>\$51.96</td></tr> <tr><td>50-99</td><td>\$49.22</td></tr> <tr><td>100+</td><td>\$47.03</td></tr> </tbody> </table> <p>BNC Male to BNC Female Tee</p> <p>VSWR 2.1:1 to 100 MHz</p> <p>Model No: <a href="#">PE9174</a></p>	PRICE	1-24	\$54.69	25-49	\$51.96	50-99	\$49.22	100+	\$47.03
	PRICE																																																	
1-24	\$23.87																																																	
25-49	\$22.68																																																	
50-99	\$21.48																																																	
100+	\$20.53																																																	
PRICE																																																		
1-24	\$62.58																																																	
25-49	\$59.45																																																	
50-99	\$56.32																																																	
100+	\$53.82																																																	
PRICE																																																		
1-24	\$38.91																																																	
25-49	\$36.96																																																	
50-99	\$35.02																																																	
100+	\$33.46																																																	
PRICE																																																		
1-24	\$30.32																																																	
25-49	\$28.80																																																	
50-99	\$27.29																																																	
100+	\$26.08																																																	
PRICE																																																		
1-24	\$54.69																																																	
25-49	\$51.96																																																	
50-99	\$49.22																																																	
100+	\$47.03																																																	
6	 <table border="1"> <thead> <tr><th>PRICE</th></tr> </thead> <tbody> <tr><td>1-24</td><td>\$55.53</td></tr> <tr><td>25-49</td><td>\$52.75</td></tr> <tr><td>50-99</td><td>\$49.98</td></tr> <tr><td>100+</td><td>\$47.76</td></tr> </tbody> </table> <p>BNC Male to BNC Female Tee</p> <p>Max. Freq. 100 MHz</p> <p>Model No: <a href="#">PE9484</a></p>	PRICE	1-24	\$55.53	25-49	\$52.75	50-99	\$49.98	100+	\$47.76	 <table border="1"> <thead> <tr><th>PRICE</th></tr> </thead> <tbody> <tr><td>1-24</td><td>\$23.88</td></tr> <tr><td>25-49</td><td>\$22.69</td></tr> <tr><td>50-99</td><td>\$21.49</td></tr> <tr><td>100+</td><td>\$20.54</td></tr> </tbody> </table> <p>BNC Female to BNC Male Tee</p> <p>Max. Freq. 4 GHz</p> <p>Model No: <a href="#">PE9001</a></p>	PRICE	1-24	\$23.88	25-49	\$22.69	50-99	\$21.49	100+	\$20.54	 <table border="1"> <thead> <tr><th>PRICE</th></tr> </thead> <tbody> <tr><td>1-24</td><td>\$14.16</td></tr> <tr><td>25-49</td><td>\$13.45</td></tr> <tr><td>50-99</td><td>\$12.74</td></tr> <tr><td>100+</td><td>\$12.18</td></tr> </tbody> </table> <p>BNC Female to BNC Female</p> <p>VSWR 1.3:1 to 4 GHz</p> <p>Model No: <a href="#">PE9084</a></p>	PRICE	1-24	\$14.16	25-49	\$13.45	50-99	\$12.74	100+	\$12.18	 <table border="1"> <thead> <tr><th>PRICE</th></tr> </thead> <tbody> <tr><td>1-24</td><td>\$26.16</td></tr> <tr><td>25-49</td><td>\$24.85</td></tr> <tr><td>50-99</td><td>\$23.54</td></tr> <tr><td>100+</td><td>\$22.50</td></tr> </tbody> </table> <p>BNC Female to BNC Female Tee</p> <p>VSWR 2.1:1 to 100 MHz</p> <p>Model No: <a href="#">PE9003</a></p>	PRICE	1-24	\$26.16	25-49	\$24.85	50-99	\$23.54	100+	\$22.50	 <table border="1"> <thead> <tr><th>PRICE</th></tr> </thead> <tbody> <tr><td>1-24</td><td>\$92.20</td></tr> <tr><td>25-49</td><td>\$87.59</td></tr> <tr><td>50-99</td><td>\$82.98</td></tr> <tr><td>100+</td><td>\$79.29</td></tr> </tbody> </table> <p>BNC Female to BNC Female Bulkhead-Mounting Hole B06</p> <p>Model No: <a href="#">PE9420</a></p>	PRICE	1-24	\$92.20	25-49	\$87.59	50-99	\$82.98	100+	\$79.29
	PRICE																																																	
1-24	\$55.53																																																	
25-49	\$52.75																																																	
50-99	\$49.98																																																	
100+	\$47.76																																																	
PRICE																																																		
1-24	\$23.88																																																	
25-49	\$22.69																																																	
50-99	\$21.49																																																	
100+	\$20.54																																																	
PRICE																																																		
1-24	\$14.16																																																	
25-49	\$13.45																																																	
50-99	\$12.74																																																	
100+	\$12.18																																																	
PRICE																																																		
1-24	\$26.16																																																	
25-49	\$24.85																																																	
50-99	\$23.54																																																	
100+	\$22.50																																																	
PRICE																																																		
1-24	\$92.20																																																	
25-49	\$87.59																																																	
50-99	\$82.98																																																	
100+	\$79.29																																																	
7	 <table border="1"> <thead> <tr><th>PRICE</th></tr> </thead> <tbody> <tr><td>1-24</td><td>\$29.35</td></tr> <tr><td>25-49</td><td>\$27.88</td></tr> <tr><td>50-99</td><td>\$26.42</td></tr> <tr><td>100+</td><td>\$25.24</td></tr> </tbody> </table> <p>BNC Female to BNC Female Bulkhead</p> <p>VSWR 1.5:1 to 4 GHz</p> <p>Model No: <a href="#">PE9093</a></p>	PRICE	1-24	\$29.35	25-49	\$27.88	50-99	\$26.42	100+	\$25.24	 <table border="1"> <thead> <tr><th>PRICE</th></tr> </thead> <tbody> <tr><td>1-24</td><td>\$31.35</td></tr> <tr><td>25-49</td><td>\$29.78</td></tr> <tr><td>50-99</td><td>\$28.22</td></tr> <tr><td>100+</td><td>\$26.96</td></tr> </tbody> </table> <p>BNC Female to BNC Female Bulkhead</p> <p>VSWR 1.5:1 to 4 GHz</p> <p>Model No: <a href="#">PE9172</a></p>	PRICE	1-24	\$31.35	25-49	\$29.78	50-99	\$28.22	100+	\$26.96	 <table border="1"> <thead> <tr><th>PRICE</th></tr> </thead> <tbody> <tr><td>1-24</td><td>\$24.25</td></tr> <tr><td>25-49</td><td>\$23.04</td></tr> <tr><td>50-99</td><td>\$21.83</td></tr> <tr><td>100+</td><td>\$20.86</td></tr> </tbody> </table> <p>BNC Female to BNC Female 4 Hole Flange-Mounting Hole A03</p> <p>VSWR 1.3:1 to 4 GHz</p> <p>Model No: <a href="#">PE9106</a></p>	PRICE	1-24	\$24.25	25-49	\$23.04	50-99	\$21.83	100+	\$20.86	<p><b>Reverse Polarity BNC In-Series</b></p> <p>→</p>		 <table border="1"> <thead> <tr><th>PRICE</th></tr> </thead> <tbody> <tr><td>1-24</td><td>\$45.04</td></tr> <tr><td>25-49</td><td>\$42.79</td></tr> <tr><td>50-99</td><td>\$40.54</td></tr> <tr><td>100+</td><td>\$38.73</td></tr> </tbody> </table> <p>BNC Male to Rev. Pol. BNC Female</p> <p>Model No: <a href="#">PE9530</a></p>	PRICE	1-24	\$45.04	25-49	\$42.79	50-99	\$40.54	100+	\$38.73								
	PRICE																																																	
1-24	\$29.35																																																	
25-49	\$27.88																																																	
50-99	\$26.42																																																	
100+	\$25.24																																																	
PRICE																																																		
1-24	\$31.35																																																	
25-49	\$29.78																																																	
50-99	\$28.22																																																	
100+	\$26.96																																																	
PRICE																																																		
1-24	\$24.25																																																	
25-49	\$23.04																																																	
50-99	\$21.83																																																	
100+	\$20.86																																																	
PRICE																																																		
1-24	\$45.04																																																	
25-49	\$42.79																																																	
50-99	\$40.54																																																	
100+	\$38.73																																																	



Technical Support  
+1 (949) 261-1920



Same-Day Shipping,  
Even Custom  
Cable Assemblies



# ADAPTERS

See Adapter Locator on Pages 10-15

See Page 409 for Mounting Holes

	A	B	C	D	E																																																		
1	 <table border="1"> <thead> <tr> <th colspan="2">PRICE</th> </tr> </thead> <tbody> <tr> <td>1-24</td> <td>\$61.96</td> </tr> <tr> <td>25-49</td> <td>\$58.86</td> </tr> <tr> <td>50-99</td> <td>\$55.76</td> </tr> <tr> <td>100+</td> <td>\$53.29</td> </tr> </tbody> </table> <p>BNC Female to Rev. Pol. BNC Male</p> <p>Model No: <a href="#">PE9529</a></p>	PRICE		1-24	\$61.96	25-49	\$58.86	50-99	\$55.76	100+	\$53.29	<p style="text-align: center;"><b>BNC Between Series</b></p> <p style="text-align: center;">→</p>	 <table border="1"> <thead> <tr> <th colspan="2">PRICE</th> </tr> </thead> <tbody> <tr> <td>1-24</td> <td>\$27.57</td> </tr> <tr> <td>25-49</td> <td>\$26.19</td> </tr> <tr> <td>50-99</td> <td>\$24.81</td> </tr> <tr> <td>100+</td> <td>\$23.71</td> </tr> </tbody> </table> <p>BNC Male to Double Banana Binding Post Jack</p> <p>Model No: <a href="#">PE9011</a></p>	PRICE		1-24	\$27.57	25-49	\$26.19	50-99	\$24.81	100+	\$23.71	 <table border="1"> <thead> <tr> <th colspan="2">PRICE</th> </tr> </thead> <tbody> <tr> <td>1-24</td> <td>\$90.43</td> </tr> <tr> <td>25-49</td> <td>\$85.91</td> </tr> <tr> <td>50-99</td> <td>\$81.39</td> </tr> <tr> <td>100+</td> <td>\$77.77</td> </tr> </tbody> </table> <p>BNC Male to BNC Triax Female</p> <p>Model No: <a href="#">PE91104</a></p>	PRICE		1-24	\$90.43	25-49	\$85.91	50-99	\$81.39	100+	\$77.77	 <table border="1"> <thead> <tr> <th colspan="2">PRICE</th> </tr> </thead> <tbody> <tr> <td>1-24</td> <td>\$108.46</td> </tr> <tr> <td>25-49</td> <td>\$103.04</td> </tr> <tr> <td>50-99</td> <td>\$97.61</td> </tr> <tr> <td>100+</td> <td>\$93.28</td> </tr> </tbody> </table> <p>BNC Male to C Male</p> <p>Model No: <a href="#">PE9536</a></p>	PRICE		1-24	\$108.46	25-49	\$103.04	50-99	\$97.61	100+	\$93.28										
PRICE																																																							
1-24	\$61.96																																																						
25-49	\$58.86																																																						
50-99	\$55.76																																																						
100+	\$53.29																																																						
PRICE																																																							
1-24	\$27.57																																																						
25-49	\$26.19																																																						
50-99	\$24.81																																																						
100+	\$23.71																																																						
PRICE																																																							
1-24	\$90.43																																																						
25-49	\$85.91																																																						
50-99	\$81.39																																																						
100+	\$77.77																																																						
PRICE																																																							
1-24	\$108.46																																																						
25-49	\$103.04																																																						
50-99	\$97.61																																																						
100+	\$93.28																																																						
2	 <table border="1"> <thead> <tr> <th colspan="2">PRICE</th> </tr> </thead> <tbody> <tr> <td>1-24</td> <td>\$63.29</td> </tr> <tr> <td>25-49</td> <td>\$60.13</td> </tr> <tr> <td>50-99</td> <td>\$56.96</td> </tr> <tr> <td>100+</td> <td>\$54.43</td> </tr> </tbody> </table> <p>BNC Male to C Female</p> <p>Model No: <a href="#">PE9109</a></p>	PRICE		1-24	\$63.29	25-49	\$60.13	50-99	\$56.96	100+	\$54.43	 <table border="1"> <thead> <tr> <th colspan="2">PRICE</th> </tr> </thead> <tbody> <tr> <td>1-24</td> <td>\$26.92</td> </tr> <tr> <td>25-49</td> <td>\$25.57</td> </tr> <tr> <td>50-99</td> <td>\$24.23</td> </tr> <tr> <td>100+</td> <td>\$23.15</td> </tr> </tbody> </table> <p>BNC Male to 75 Ohm F Male</p> <p>Model No: <a href="#">PE9152</a></p>	PRICE		1-24	\$26.92	25-49	\$25.57	50-99	\$24.23	100+	\$23.15	 <table border="1"> <thead> <tr> <th colspan="2">PRICE</th> </tr> </thead> <tbody> <tr> <td>1-24</td> <td>\$33.02</td> </tr> <tr> <td>25-49</td> <td>\$31.37</td> </tr> <tr> <td>50-99</td> <td>\$29.72</td> </tr> <tr> <td>100+</td> <td>\$28.40</td> </tr> </tbody> </table> <p>BNC Male to 75 Ohm F Female VSWR 1.5:1 to 300 MHz</p> <p>Model No: <a href="#">PE9150</a></p>	PRICE		1-24	\$33.02	25-49	\$31.37	50-99	\$29.72	100+	\$28.40	 <table border="1"> <thead> <tr> <th colspan="2">PRICE</th> </tr> </thead> <tbody> <tr> <td>1-9</td> <td>\$121.49</td> </tr> <tr> <td>10-24</td> <td>\$115.42</td> </tr> <tr> <td>25-49</td> <td>\$109.34</td> </tr> <tr> <td>50+</td> <td>\$104.48</td> </tr> </tbody> </table> <p>BNC Male to MHV Female</p> <p>Model No: <a href="#">PE9406</a></p>	PRICE		1-9	\$121.49	10-24	\$115.42	25-49	\$109.34	50+	\$104.48	 <table border="1"> <thead> <tr> <th colspan="2">PRICE</th> </tr> </thead> <tbody> <tr> <td>1-24</td> <td>\$23.73</td> </tr> <tr> <td>25-49</td> <td>\$22.54</td> </tr> <tr> <td>50-99</td> <td>\$21.36</td> </tr> <tr> <td>100+</td> <td>\$20.41</td> </tr> </tbody> </table> <p>BNC Male to 75 Ohm Push-On RCA Jack Max. Freq. 250 MHz</p> <p>Model No: <a href="#">PE9171</a></p>	PRICE		1-24	\$23.73	25-49	\$22.54	50-99	\$21.36	100+	\$20.41
PRICE																																																							
1-24	\$63.29																																																						
25-49	\$60.13																																																						
50-99	\$56.96																																																						
100+	\$54.43																																																						
PRICE																																																							
1-24	\$26.92																																																						
25-49	\$25.57																																																						
50-99	\$24.23																																																						
100+	\$23.15																																																						
PRICE																																																							
1-24	\$33.02																																																						
25-49	\$31.37																																																						
50-99	\$29.72																																																						
100+	\$28.40																																																						
PRICE																																																							
1-9	\$121.49																																																						
10-24	\$115.42																																																						
25-49	\$109.34																																																						
50+	\$104.48																																																						
PRICE																																																							
1-24	\$23.73																																																						
25-49	\$22.54																																																						
50-99	\$21.36																																																						
100+	\$20.41																																																						
3	 <table border="1"> <thead> <tr> <th colspan="2">PRICE</th> </tr> </thead> <tbody> <tr> <td>1-24</td> <td>\$75.56</td> </tr> <tr> <td>25-49</td> <td>\$71.78</td> </tr> <tr> <td>50-99</td> <td>\$68.00</td> </tr> <tr> <td>100+</td> <td>\$64.98</td> </tr> </tbody> </table> <p>BNC Male to 75 Ohm SMB Plug</p> <p>Model No: <a href="#">PE9230</a></p>	PRICE		1-24	\$75.56	25-49	\$71.78	50-99	\$68.00	100+	\$64.98	 <table border="1"> <thead> <tr> <th colspan="2">PRICE</th> </tr> </thead> <tbody> <tr> <td>1-24</td> <td>\$73.73</td> </tr> <tr> <td>25-49</td> <td>\$70.04</td> </tr> <tr> <td>50-99</td> <td>\$66.36</td> </tr> <tr> <td>100+</td> <td>\$63.41</td> </tr> </tbody> </table> <p>BNC Male to 75 Ohm SMC Plug</p> <p>Model No: <a href="#">PE9234</a></p>	PRICE		1-24	\$73.73	25-49	\$70.04	50-99	\$66.36	100+	\$63.41	 <table border="1"> <thead> <tr> <th colspan="2">PRICE</th> </tr> </thead> <tbody> <tr> <td>1-24</td> <td>\$100.16</td> </tr> <tr> <td>25-49</td> <td>\$95.15</td> </tr> <tr> <td>50-99</td> <td>\$90.14</td> </tr> <tr> <td>100+</td> <td>\$86.14</td> </tr> </tbody> </table> <p>BNC Male to 75 Ohm SMC Jack</p> <p>Model No: <a href="#">PE91044</a></p>	PRICE		1-24	\$100.16	25-49	\$95.15	50-99	\$90.14	100+	\$86.14	 <table border="1"> <thead> <tr> <th colspan="2">PRICE</th> </tr> </thead> <tbody> <tr> <td>1-24</td> <td>\$44.85</td> </tr> <tr> <td>25-49</td> <td>\$42.61</td> </tr> <tr> <td>50-99</td> <td>\$40.37</td> </tr> <tr> <td>100+</td> <td>\$38.57</td> </tr> </tbody> </table> <p>BNC Female to C Male VSWR 1.3:1 to 4 GHz</p> <p>Model No: <a href="#">PE9087</a></p>	PRICE		1-24	\$44.85	25-49	\$42.61	50-99	\$40.37	100+	\$38.57	 <table border="1"> <thead> <tr> <th colspan="2">PRICE</th> </tr> </thead> <tbody> <tr> <td>1-24</td> <td>\$107.70</td> </tr> <tr> <td>25-49</td> <td>\$102.32</td> </tr> <tr> <td>50-99</td> <td>\$96.93</td> </tr> <tr> <td>100+</td> <td>\$92.62</td> </tr> </tbody> </table> <p>BNC Female to C Female</p> <p>Model No: <a href="#">PE9537</a></p>	PRICE		1-24	\$107.70	25-49	\$102.32	50-99	\$96.93	100+	\$92.62
PRICE																																																							
1-24	\$75.56																																																						
25-49	\$71.78																																																						
50-99	\$68.00																																																						
100+	\$64.98																																																						
PRICE																																																							
1-24	\$73.73																																																						
25-49	\$70.04																																																						
50-99	\$66.36																																																						
100+	\$63.41																																																						
PRICE																																																							
1-24	\$100.16																																																						
25-49	\$95.15																																																						
50-99	\$90.14																																																						
100+	\$86.14																																																						
PRICE																																																							
1-24	\$44.85																																																						
25-49	\$42.61																																																						
50-99	\$40.37																																																						
100+	\$38.57																																																						
PRICE																																																							
1-24	\$107.70																																																						
25-49	\$102.32																																																						
50-99	\$96.93																																																						
100+	\$92.62																																																						
4	 <table border="1"> <thead> <tr> <th colspan="2">PRICE</th> </tr> </thead> <tbody> <tr> <td>1-24</td> <td>\$107.47</td> </tr> <tr> <td>25-49</td> <td>\$102.10</td> </tr> <tr> <td>50-99</td> <td>\$96.72</td> </tr> <tr> <td>100+</td> <td>\$92.42</td> </tr> </tbody> </table> <p>BNC Female to C Female Bulkhead-Mounting Hole G01</p> <p>Model No: <a href="#">PE9204</a></p>	PRICE		1-24	\$107.47	25-49	\$102.10	50-99	\$96.72	100+	\$92.42	 <table border="1"> <thead> <tr> <th colspan="2">PRICE</th> </tr> </thead> <tbody> <tr> <td>1-24</td> <td>\$26.17</td> </tr> <tr> <td>25-49</td> <td>\$24.86</td> </tr> <tr> <td>50-99</td> <td>\$23.55</td> </tr> <tr> <td>100+</td> <td>\$22.51</td> </tr> </tbody> </table> <p>BNC Female to 75 Ohm F Male VSWR 1.3:1 to 500 MHz</p> <p>Model No: <a href="#">PE9151</a></p>	PRICE		1-24	\$26.17	25-49	\$24.86	50-99	\$23.55	100+	\$22.51	 <table border="1"> <thead> <tr> <th colspan="2">PRICE</th> </tr> </thead> <tbody> <tr> <td>1-24</td> <td>\$20.79</td> </tr> <tr> <td>25-49</td> <td>\$19.75</td> </tr> <tr> <td>50-99</td> <td>\$18.71</td> </tr> <tr> <td>100+</td> <td>\$17.88</td> </tr> </tbody> </table> <p>BNC Female to 75 Ohm F Female</p> <p>Model No: <a href="#">PE9153</a></p>	PRICE		1-24	\$20.79	25-49	\$19.75	50-99	\$18.71	100+	\$17.88	 <table border="1"> <thead> <tr> <th colspan="2">PRICE</th> </tr> </thead> <tbody> <tr> <td>1-24</td> <td>\$21.16</td> </tr> <tr> <td>25-49</td> <td>\$20.10</td> </tr> <tr> <td>50-99</td> <td>\$19.04</td> </tr> <tr> <td>100+</td> <td>\$18.20</td> </tr> </tbody> </table> <p>BNC Female to 75 Ohm RCA Plug Max. Freq. 250 MHz</p> <p>Model No: <a href="#">PE9158</a></p>	PRICE		1-24	\$21.16	25-49	\$20.10	50-99	\$19.04	100+	\$18.20	 <table border="1"> <thead> <tr> <th colspan="2">PRICE</th> </tr> </thead> <tbody> <tr> <td>1-24</td> <td>\$15.40</td> </tr> <tr> <td>25-49</td> <td>\$14.63</td> </tr> <tr> <td>50-99</td> <td>\$13.86</td> </tr> <tr> <td>100+</td> <td>\$13.24</td> </tr> </tbody> </table> <p>BNC Female to 75 Ohm RCA Jack Max. Freq. 250 MHz</p> <p>Model No: <a href="#">PE9015</a></p>	PRICE		1-24	\$15.40	25-49	\$14.63	50-99	\$13.86	100+	\$13.24
PRICE																																																							
1-24	\$107.47																																																						
25-49	\$102.10																																																						
50-99	\$96.72																																																						
100+	\$92.42																																																						
PRICE																																																							
1-24	\$26.17																																																						
25-49	\$24.86																																																						
50-99	\$23.55																																																						
100+	\$22.51																																																						
PRICE																																																							
1-24	\$20.79																																																						
25-49	\$19.75																																																						
50-99	\$18.71																																																						
100+	\$17.88																																																						
PRICE																																																							
1-24	\$21.16																																																						
25-49	\$20.10																																																						
50-99	\$19.04																																																						
100+	\$18.20																																																						
PRICE																																																							
1-24	\$15.40																																																						
25-49	\$14.63																																																						
50-99	\$13.86																																																						
100+	\$13.24																																																						
5	 <table border="1"> <thead> <tr> <th colspan="2">PRICE</th> </tr> </thead> <tbody> <tr> <td>1-24</td> <td>\$66.06</td> </tr> <tr> <td>25-49</td> <td>\$62.76</td> </tr> <tr> <td>50-99</td> <td>\$59.45</td> </tr> <tr> <td>100+</td> <td>\$56.81</td> </tr> </tbody> </table> <p>BNC Female to 75 Ohm SMB Jack VSWR 1.2:1 to 4 GHz</p> <p>Model No: <a href="#">PE9231</a></p>	PRICE		1-24	\$66.06	25-49	\$62.76	50-99	\$59.45	100+	\$56.81	 <table border="1"> <thead> <tr> <th colspan="2">PRICE</th> </tr> </thead> <tbody> <tr> <td>1-24</td> <td>\$88.72</td> </tr> <tr> <td>25-49</td> <td>\$84.28</td> </tr> <tr> <td>50-99</td> <td>\$79.85</td> </tr> <tr> <td>100+</td> <td>\$76.30</td> </tr> </tbody> </table> <p>BNC Female to 75 Ohm SMC Plug</p> <p>Model No: <a href="#">PE9236</a></p>	PRICE		1-24	\$88.72	25-49	\$84.28	50-99	\$79.85	100+	\$76.30	<p style="text-align: center;"><b>C In-Series</b></p> <p style="text-align: center;">→</p>	 <table border="1"> <thead> <tr> <th colspan="2">PRICE</th> </tr> </thead> <tbody> <tr> <td>1-24</td> <td>\$124.74</td> </tr> <tr> <td>25-49</td> <td>\$118.50</td> </tr> <tr> <td>50-99</td> <td>\$112.27</td> </tr> <tr> <td>100+</td> <td>\$107.28</td> </tr> </tbody> </table> <p>C Male to C Male</p> <p>Model No: <a href="#">PE9300</a></p>	PRICE		1-24	\$124.74	25-49	\$118.50	50-99	\$112.27	100+	\$107.28	 <table border="1"> <thead> <tr> <th colspan="2">PRICE</th> </tr> </thead> <tbody> <tr> <td>1-24</td> <td>\$99.95</td> </tr> <tr> <td>25-49</td> <td>\$94.95</td> </tr> <tr> <td>50-99</td> <td>\$89.96</td> </tr> <tr> <td>100+</td> <td>\$85.96</td> </tr> </tbody> </table> <p>C Male to C Female Right Angle</p> <p>Model No: <a href="#">PE9293</a></p>	PRICE		1-24	\$99.95	25-49	\$94.95	50-99	\$89.96	100+	\$85.96										
PRICE																																																							
1-24	\$66.06																																																						
25-49	\$62.76																																																						
50-99	\$59.45																																																						
100+	\$56.81																																																						
PRICE																																																							
1-24	\$88.72																																																						
25-49	\$84.28																																																						
50-99	\$79.85																																																						
100+	\$76.30																																																						
PRICE																																																							
1-24	\$124.74																																																						
25-49	\$118.50																																																						
50-99	\$112.27																																																						
100+	\$107.28																																																						
PRICE																																																							
1-24	\$99.95																																																						
25-49	\$94.95																																																						
50-99	\$89.96																																																						
100+	\$85.96																																																						
6	 <table border="1"> <thead> <tr> <th colspan="2">PRICE</th> </tr> </thead> <tbody> <tr> <td>1-24</td> <td>\$110.00</td> </tr> <tr> <td>25-49</td> <td>\$104.50</td> </tr> <tr> <td>50-99</td> <td>\$99.00</td> </tr> <tr> <td>100+</td> <td>\$94.60</td> </tr> </tbody> </table> <p>C Female to C Male Tee</p> <p>Model No: <a href="#">PE9207</a></p>	PRICE		1-24	\$110.00	25-49	\$104.50	50-99	\$99.00	100+	\$94.60	 <table border="1"> <thead> <tr> <th colspan="2">PRICE</th> </tr> </thead> <tbody> <tr> <td>1-24</td> <td>\$54.08</td> </tr> <tr> <td>25-49</td> <td>\$51.38</td> </tr> <tr> <td>50-99</td> <td>\$48.67</td> </tr> <tr> <td>100+</td> <td>\$46.51</td> </tr> </tbody> </table> <p>C Female to C Female Tee</p> <p>Model No: <a href="#">PE9208</a></p>	PRICE		1-24	\$54.08	25-49	\$51.38	50-99	\$48.67	100+	\$46.51	 <table border="1"> <thead> <tr> <th colspan="2">PRICE</th> </tr> </thead> <tbody> <tr> <td>1-24</td> <td>\$129.35</td> </tr> <tr> <td>25-49</td> <td>\$122.88</td> </tr> <tr> <td>50-99</td> <td>\$116.42</td> </tr> <tr> <td>100+</td> <td>\$111.24</td> </tr> </tbody> </table> <p>C Female to C Female Tee</p> <p>Model No: <a href="#">PE9294</a></p>	PRICE		1-24	\$129.35	25-49	\$122.88	50-99	\$116.42	100+	\$111.24	 <table border="1"> <thead> <tr> <th colspan="2">PRICE</th> </tr> </thead> <tbody> <tr> <td>1-24</td> <td>\$126.83</td> </tr> <tr> <td>25-49</td> <td>\$120.49</td> </tr> <tr> <td>50-99</td> <td>\$114.15</td> </tr> <tr> <td>100+</td> <td>\$109.07</td> </tr> </tbody> </table> <p>C Female to C Female Bulkhead-Mounting Hole B07</p> <p>Model No: <a href="#">PE9186</a></p>	PRICE		1-24	\$126.83	25-49	\$120.49	50-99	\$114.15	100+	\$109.07	<p style="text-align: center;"><b>D-Sub In-Series</b></p> <p style="text-align: center;">→</p>										
PRICE																																																							
1-24	\$110.00																																																						
25-49	\$104.50																																																						
50-99	\$99.00																																																						
100+	\$94.60																																																						
PRICE																																																							
1-24	\$54.08																																																						
25-49	\$51.38																																																						
50-99	\$48.67																																																						
100+	\$46.51																																																						
PRICE																																																							
1-24	\$129.35																																																						
25-49	\$122.88																																																						
50-99	\$116.42																																																						
100+	\$111.24																																																						
PRICE																																																							
1-24	\$126.83																																																						
25-49	\$120.49																																																						
50-99	\$114.15																																																						
100+	\$109.07																																																						
7	 <table border="1"> <thead> <tr> <th colspan="2">PRICE</th> </tr> </thead> <tbody> <tr> <td>1-24</td> <td>\$55.05</td> </tr> <tr> <td>25-49</td> <td>\$52.30</td> </tr> <tr> <td>50-99</td> <td>\$49.55</td> </tr> <tr> <td>100+</td> <td>\$47.34</td> </tr> </tbody> </table> <p>D-Sub Plug to D-Sub Plug</p> <p>Model No: <a href="#">PE9688</a></p>	PRICE		1-24	\$55.05	25-49	\$52.30	50-99	\$49.55	100+	\$47.34	 <table border="1"> <thead> <tr> <th colspan="2">PRICE</th> </tr> </thead> <tbody> <tr> <td>1-24</td> <td>\$54.36</td> </tr> <tr> <td>25-49</td> <td>\$51.64</td> </tr> <tr> <td>50-99</td> <td>\$48.92</td> </tr> <tr> <td>100+</td> <td>\$46.75</td> </tr> </tbody> </table> <p>D-Sub Plug to D-Sub Receptacle</p> <p>Model No: <a href="#">PE9687</a></p>	PRICE		1-24	\$54.36	25-49	\$51.64	50-99	\$48.92	100+	\$46.75	 <table border="1"> <thead> <tr> <th colspan="2">PRICE</th> </tr> </thead> <tbody> <tr> <td>1-24</td> <td>\$77.55</td> </tr> <tr> <td>25-49</td> <td>\$73.67</td> </tr> <tr> <td>50-99</td> <td>\$69.80</td> </tr> <tr> <td>100+</td> <td>\$66.69</td> </tr> </tbody> </table> <p>D-Sub Receptacle to D-Sub Receptacle</p> <p>Model No: <a href="#">PE9689</a></p>	PRICE		1-24	\$77.55	25-49	\$73.67	50-99	\$69.80	100+	\$66.69	<p style="text-align: center;"><b>FME In-Series</b></p> <p style="text-align: center;">→</p>	 <table border="1"> <thead> <tr> <th colspan="2">PRICE</th> </tr> </thead> <tbody> <tr> <td>1-24</td> <td>\$23.32</td> </tr> <tr> <td>25-49</td> <td>\$22.15</td> </tr> <tr> <td>50-99</td> <td>\$20.99</td> </tr> <tr> <td>100+</td> <td>\$20.06</td> </tr> </tbody> </table> <p>FME Plug to FME Plug</p> <p>Model No: <a href="#">PE9696</a></p>	PRICE		1-24	\$23.32	25-49	\$22.15	50-99	\$20.99	100+	\$20.06										
PRICE																																																							
1-24	\$55.05																																																						
25-49	\$52.30																																																						
50-99	\$49.55																																																						
100+	\$47.34																																																						
PRICE																																																							
1-24	\$54.36																																																						
25-49	\$51.64																																																						
50-99	\$48.92																																																						
100+	\$46.75																																																						
PRICE																																																							
1-24	\$77.55																																																						
25-49	\$73.67																																																						
50-99	\$69.80																																																						
100+	\$66.69																																																						
PRICE																																																							
1-24	\$23.32																																																						
25-49	\$22.15																																																						
50-99	\$20.99																																																						
100+	\$20.06																																																						

# ADAPTERS

See Adapter Locator on Pages 10-15  
See Page 409 for Mounting Holes

	A	B	C	D	E																																																		
1	<p><b>FME Between Series</b></p>  <table border="1"> <thead> <tr> <th colspan="2">PRICE</th> </tr> </thead> <tbody> <tr> <td>1-24</td> <td>\$23.32</td> </tr> <tr> <td>25-49</td> <td>\$22.15</td> </tr> <tr> <td>50-99</td> <td>\$20.99</td> </tr> <tr> <td>100+</td> <td>\$20.06</td> </tr> </tbody> </table> <p>FME Plug to BNC Male</p> <p>Model No: <a href="#">PE9697</a></p>	PRICE		1-24	\$23.32	25-49	\$22.15	50-99	\$20.99	100+	\$20.06	 <table border="1"> <thead> <tr> <th colspan="2">PRICE</th> </tr> </thead> <tbody> <tr> <td>1-24</td> <td>\$23.82</td> </tr> <tr> <td>25-49</td> <td>\$22.63</td> </tr> <tr> <td>50-99</td> <td>\$21.44</td> </tr> <tr> <td>100+</td> <td>\$20.49</td> </tr> </tbody> </table> <p>FME Plug to BNC Male Right Angle</p> <p>Model No: <a href="#">PE9698</a></p>	PRICE		1-24	\$23.82	25-49	\$22.63	50-99	\$21.44	100+	\$20.49	 <table border="1"> <thead> <tr> <th colspan="2">PRICE</th> </tr> </thead> <tbody> <tr> <td>1-24</td> <td>\$23.32</td> </tr> <tr> <td>25-49</td> <td>\$22.15</td> </tr> <tr> <td>50-99</td> <td>\$20.99</td> </tr> <tr> <td>100+</td> <td>\$20.06</td> </tr> </tbody> </table> <p>FME Jack to BNC Male</p> <p>Model No: <a href="#">PE9711</a></p>	PRICE		1-24	\$23.32	25-49	\$22.15	50-99	\$20.99	100+	\$20.06	 <table border="1"> <thead> <tr> <th colspan="2">PRICE</th> </tr> </thead> <tbody> <tr> <td>1-24</td> <td>\$18.61</td> </tr> <tr> <td>25-49</td> <td>\$17.68</td> </tr> <tr> <td>50-99</td> <td>\$16.75</td> </tr> <tr> <td>100+</td> <td>\$16.00</td> </tr> </tbody> </table> <p>FME Jack to BNC Female</p> <p>Model No: <a href="#">PE9712</a></p>	PRICE		1-24	\$18.61	25-49	\$17.68	50-99	\$16.75	100+	\$16.00											
PRICE																																																							
1-24	\$23.32																																																						
25-49	\$22.15																																																						
50-99	\$20.99																																																						
100+	\$20.06																																																						
PRICE																																																							
1-24	\$23.82																																																						
25-49	\$22.63																																																						
50-99	\$21.44																																																						
100+	\$20.49																																																						
PRICE																																																							
1-24	\$23.32																																																						
25-49	\$22.15																																																						
50-99	\$20.99																																																						
100+	\$20.06																																																						
PRICE																																																							
1-24	\$18.61																																																						
25-49	\$17.68																																																						
50-99	\$16.75																																																						
100+	\$16.00																																																						
2	<p><b>GR874 In-Series</b></p>  <table border="1"> <thead> <tr> <th colspan="2">PRICE</th> </tr> </thead> <tbody> <tr> <td>1-9</td> <td>\$368.45</td> </tr> <tr> <td>10-24</td> <td>\$350.03</td> </tr> <tr> <td>25-49</td> <td>\$331.61</td> </tr> <tr> <td>50+</td> <td>\$316.87</td> </tr> </tbody> </table> <p>GR874 Sexless to GR874 Sexless Right Angle</p> <p>Model No: <a href="#">PE9286</a></p>	PRICE		1-9	\$368.45	10-24	\$350.03	25-49	\$331.61	50+	\$316.87	 <table border="1"> <thead> <tr> <th colspan="2">PRICE</th> </tr> </thead> <tbody> <tr> <td>1-9</td> <td>\$404.10</td> </tr> <tr> <td>10-24</td> <td>\$383.90</td> </tr> <tr> <td>25-49</td> <td>\$363.69</td> </tr> <tr> <td>50+</td> <td>\$347.53</td> </tr> </tbody> </table> <p>GR874 Sexless to GR874 Sexless Tee</p> <p>Model No: <a href="#">PE9285</a></p>	PRICE		1-9	\$404.10	10-24	\$383.90	25-49	\$363.69	50+	\$347.53	<p><b>GR874 Between Series</b></p>  <table border="1"> <thead> <tr> <th colspan="2">PRICE</th> </tr> </thead> <tbody> <tr> <td>1-9</td> <td>\$176.83</td> </tr> <tr> <td>10-24</td> <td>\$167.99</td> </tr> <tr> <td>25-49</td> <td>\$159.15</td> </tr> <tr> <td>50+</td> <td>\$152.07</td> </tr> </tbody> </table> <p>GR874 Sexless to BNC Male</p> <p>Model No: <a href="#">PE9223</a></p>	PRICE		1-9	\$176.83	10-24	\$167.99	25-49	\$159.15	50+	\$152.07																						
PRICE																																																							
1-9	\$368.45																																																						
10-24	\$350.03																																																						
25-49	\$331.61																																																						
50+	\$316.87																																																						
PRICE																																																							
1-9	\$404.10																																																						
10-24	\$383.90																																																						
25-49	\$363.69																																																						
50+	\$347.53																																																						
PRICE																																																							
1-9	\$176.83																																																						
10-24	\$167.99																																																						
25-49	\$159.15																																																						
50+	\$152.07																																																						
3	 <table border="1"> <thead> <tr> <th colspan="2">PRICE</th> </tr> </thead> <tbody> <tr> <td>1-9</td> <td>\$184.10</td> </tr> <tr> <td>10-24</td> <td>\$174.90</td> </tr> <tr> <td>25-49</td> <td>\$165.69</td> </tr> <tr> <td>50+</td> <td>\$158.33</td> </tr> </tbody> </table> <p>GR874 Sexless to C Female</p> <p>Model No: <a href="#">PE9301</a></p>	PRICE		1-9	\$184.10	10-24	\$174.90	25-49	\$165.69	50+	\$158.33	<p><b>HN In-Series</b></p>  <table border="1"> <thead> <tr> <th colspan="2">PRICE</th> </tr> </thead> <tbody> <tr> <td>1-24</td> <td>\$64.58</td> </tr> <tr> <td>25-49</td> <td>\$61.35</td> </tr> <tr> <td>50-99</td> <td>\$58.12</td> </tr> <tr> <td>100+</td> <td>\$55.54</td> </tr> </tbody> </table> <p>HN Male to HN Male VSWR 1.4:1 to 3 GHz</p> <p>Model No: <a href="#">PE9210</a></p>	PRICE		1-24	\$64.58	25-49	\$61.35	50-99	\$58.12	100+	\$55.54	 <table border="1"> <thead> <tr> <th colspan="2">PRICE</th> </tr> </thead> <tbody> <tr> <td>1-9</td> <td>\$169.07</td> </tr> <tr> <td>10-24</td> <td>\$160.62</td> </tr> <tr> <td>25-49</td> <td>\$152.16</td> </tr> <tr> <td>50+</td> <td>\$145.40</td> </tr> </tbody> </table> <p>HN Male to HN Male Right Angle</p> <p>Model No: <a href="#">PE9577</a></p>	PRICE		1-9	\$169.07	10-24	\$160.62	25-49	\$152.16	50+	\$145.40	 <table border="1"> <thead> <tr> <th colspan="2">PRICE</th> </tr> </thead> <tbody> <tr> <td>1-24</td> <td>\$105.81</td> </tr> <tr> <td>25-49</td> <td>\$100.52</td> </tr> <tr> <td>50-99</td> <td>\$95.23</td> </tr> <tr> <td>100+</td> <td>\$91.00</td> </tr> </tbody> </table> <p>HN Male to HN Female</p> <p>Model No: <a href="#">PE9576</a></p>	PRICE		1-24	\$105.81	25-49	\$100.52	50-99	\$95.23	100+	\$91.00											
PRICE																																																							
1-9	\$184.10																																																						
10-24	\$174.90																																																						
25-49	\$165.69																																																						
50+	\$158.33																																																						
PRICE																																																							
1-24	\$64.58																																																						
25-49	\$61.35																																																						
50-99	\$58.12																																																						
100+	\$55.54																																																						
PRICE																																																							
1-9	\$169.07																																																						
10-24	\$160.62																																																						
25-49	\$152.16																																																						
50+	\$145.40																																																						
PRICE																																																							
1-24	\$105.81																																																						
25-49	\$100.52																																																						
50-99	\$95.23																																																						
100+	\$91.00																																																						
4	 <table border="1"> <thead> <tr> <th colspan="2">PRICE</th> </tr> </thead> <tbody> <tr> <td>1-24</td> <td>\$72.45</td> </tr> <tr> <td>25-49</td> <td>\$68.83</td> </tr> <tr> <td>50-99</td> <td>\$65.21</td> </tr> <tr> <td>100+</td> <td>\$62.31</td> </tr> </tbody> </table> <p>HN Male to HN Female Right Angle VSWR 1.5:1 to 3 GHz</p> <p>Model No: <a href="#">PE9205</a></p>	PRICE		1-24	\$72.45	25-49	\$68.83	50-99	\$65.21	100+	\$62.31	 <table border="1"> <thead> <tr> <th colspan="2">PRICE</th> </tr> </thead> <tbody> <tr> <td>1-9</td> <td>\$211.07</td> </tr> <tr> <td>10-24</td> <td>\$200.52</td> </tr> <tr> <td>25-49</td> <td>\$189.96</td> </tr> <tr> <td>50+</td> <td>\$181.52</td> </tr> </tbody> </table> <p>HN Male to HN Female Tee</p> <p>Model No: <a href="#">PE9578</a></p>	PRICE		1-9	\$211.07	10-24	\$200.52	25-49	\$189.96	50+	\$181.52	 <table border="1"> <thead> <tr> <th colspan="2">PRICE</th> </tr> </thead> <tbody> <tr> <td>1-9</td> <td>\$176.00</td> </tr> <tr> <td>10-24</td> <td>\$167.20</td> </tr> <tr> <td>25-49</td> <td>\$158.40</td> </tr> <tr> <td>50+</td> <td>\$151.36</td> </tr> </tbody> </table> <p>HN Female to HN Male Tee</p> <p>Model No: <a href="#">PE9575</a></p>	PRICE		1-9	\$176.00	10-24	\$167.20	25-49	\$158.40	50+	\$151.36	 <table border="1"> <thead> <tr> <th colspan="2">PRICE</th> </tr> </thead> <tbody> <tr> <td>1-24</td> <td>\$63.60</td> </tr> <tr> <td>25-49</td> <td>\$60.42</td> </tr> <tr> <td>50-99</td> <td>\$57.24</td> </tr> <tr> <td>100+</td> <td>\$54.70</td> </tr> </tbody> </table> <p>HN Female to HN Female</p> <p>Model No: <a href="#">PE9580</a></p>	PRICE		1-24	\$63.60	25-49	\$60.42	50-99	\$57.24	100+	\$54.70	 <table border="1"> <thead> <tr> <th colspan="2">PRICE</th> </tr> </thead> <tbody> <tr> <td>1-9</td> <td>\$146.66</td> </tr> <tr> <td>10-24</td> <td>\$139.33</td> </tr> <tr> <td>25-49</td> <td>\$131.99</td> </tr> <tr> <td>50+</td> <td>\$126.13</td> </tr> </tbody> </table> <p>HN Female to HN Female Tee</p> <p>Model No: <a href="#">PE9574</a></p>	PRICE		1-9	\$146.66	10-24	\$139.33	25-49	\$131.99	50+	\$126.13
PRICE																																																							
1-24	\$72.45																																																						
25-49	\$68.83																																																						
50-99	\$65.21																																																						
100+	\$62.31																																																						
PRICE																																																							
1-9	\$211.07																																																						
10-24	\$200.52																																																						
25-49	\$189.96																																																						
50+	\$181.52																																																						
PRICE																																																							
1-9	\$176.00																																																						
10-24	\$167.20																																																						
25-49	\$158.40																																																						
50+	\$151.36																																																						
PRICE																																																							
1-24	\$63.60																																																						
25-49	\$60.42																																																						
50-99	\$57.24																																																						
100+	\$54.70																																																						
PRICE																																																							
1-9	\$146.66																																																						
10-24	\$139.33																																																						
25-49	\$131.99																																																						
50+	\$126.13																																																						
5	 <table border="1"> <thead> <tr> <th colspan="2">PRICE</th> </tr> </thead> <tbody> <tr> <td>1-24</td> <td>\$81.29</td> </tr> <tr> <td>25-49</td> <td>\$77.23</td> </tr> <tr> <td>50-99</td> <td>\$73.16</td> </tr> <tr> <td>100+</td> <td>\$69.91</td> </tr> </tbody> </table> <p>HN Female to HN Female Bulkhead-Mounting Hole G03 VSWR 1.3:1 to 2 GHz</p> <p>Model No: <a href="#">PE9193</a></p>	PRICE		1-24	\$81.29	25-49	\$77.23	50-99	\$73.16	100+	\$69.91	<p><b>HN Between Series</b></p>  <table border="1"> <thead> <tr> <th colspan="2">PRICE</th> </tr> </thead> <tbody> <tr> <td>1-24</td> <td>\$103.37</td> </tr> <tr> <td>25-49</td> <td>\$98.20</td> </tr> <tr> <td>50-99</td> <td>\$93.03</td> </tr> <tr> <td>100+</td> <td>\$88.90</td> </tr> </tbody> </table> <p>HN Male to BNC Male</p> <p>Model No: <a href="#">PE9567</a></p>	PRICE		1-24	\$103.37	25-49	\$98.20	50-99	\$93.03	100+	\$88.90	 <table border="1"> <thead> <tr> <th colspan="2">PRICE</th> </tr> </thead> <tbody> <tr> <td>1-24</td> <td>\$69.96</td> </tr> <tr> <td>25-49</td> <td>\$66.46</td> </tr> <tr> <td>50-99</td> <td>\$62.96</td> </tr> <tr> <td>100+</td> <td>\$60.17</td> </tr> </tbody> </table> <p>HN Male to BNC Female VSWR 1.5:1 to 4 GHz</p> <p>Model No: <a href="#">PE9126</a></p>	PRICE		1-24	\$69.96	25-49	\$66.46	50-99	\$62.96	100+	\$60.17	 <table border="1"> <thead> <tr> <th colspan="2">PRICE</th> </tr> </thead> <tbody> <tr> <td>1-24</td> <td>\$111.20</td> </tr> <tr> <td>25-49</td> <td>\$105.64</td> </tr> <tr> <td>50-99</td> <td>\$100.08</td> </tr> <tr> <td>100+</td> <td>\$95.63</td> </tr> </tbody> </table> <p>HN Male to C Male Max. Freq. 4 GHz</p> <p>Model No: <a href="#">PE9579</a></p>	PRICE		1-24	\$111.20	25-49	\$105.64	50-99	\$100.08	100+	\$95.63											
PRICE																																																							
1-24	\$81.29																																																						
25-49	\$77.23																																																						
50-99	\$73.16																																																						
100+	\$69.91																																																						
PRICE																																																							
1-24	\$103.37																																																						
25-49	\$98.20																																																						
50-99	\$93.03																																																						
100+	\$88.90																																																						
PRICE																																																							
1-24	\$69.96																																																						
25-49	\$66.46																																																						
50-99	\$62.96																																																						
100+	\$60.17																																																						
PRICE																																																							
1-24	\$111.20																																																						
25-49	\$105.64																																																						
50-99	\$100.08																																																						
100+	\$95.63																																																						
6	 <table border="1"> <thead> <tr> <th colspan="2">PRICE</th> </tr> </thead> <tbody> <tr> <td>1-24</td> <td>\$88.24</td> </tr> <tr> <td>25-49</td> <td>\$83.83</td> </tr> <tr> <td>50-99</td> <td>\$79.42</td> </tr> <tr> <td>100+</td> <td>\$75.89</td> </tr> </tbody> </table> <p>HN Male to C Female</p> <p>Model No: <a href="#">PE9296</a></p>	PRICE		1-24	\$88.24	25-49	\$83.83	50-99	\$79.42	100+	\$75.89	 <table border="1"> <thead> <tr> <th colspan="2">PRICE</th> </tr> </thead> <tbody> <tr> <td>1-9</td> <td>\$229.40</td> </tr> <tr> <td>10-24</td> <td>\$217.93</td> </tr> <tr> <td>25-49</td> <td>\$206.46</td> </tr> <tr> <td>50+</td> <td>\$197.28</td> </tr> </tbody> </table> <p>HN Male to GR874 Sexless</p> <p>Model No: <a href="#">PE9386</a></p>	PRICE		1-9	\$229.40	10-24	\$217.93	25-49	\$206.46	50+	\$197.28	 <table border="1"> <thead> <tr> <th colspan="2">PRICE</th> </tr> </thead> <tbody> <tr> <td>1-9</td> <td>\$155.90</td> </tr> <tr> <td>10-24</td> <td>\$148.11</td> </tr> <tr> <td>25-49</td> <td>\$140.31</td> </tr> <tr> <td>50+</td> <td>\$134.07</td> </tr> </tbody> </table> <p>HN Male to MHV Female</p> <p>Model No: <a href="#">PE9264</a></p>	PRICE		1-9	\$155.90	10-24	\$148.11	25-49	\$140.31	50+	\$134.07	 <table border="1"> <thead> <tr> <th colspan="2">PRICE</th> </tr> </thead> <tbody> <tr> <td>1-24</td> <td>\$73.94</td> </tr> <tr> <td>25-49</td> <td>\$70.24</td> </tr> <tr> <td>50-99</td> <td>\$66.55</td> </tr> <tr> <td>100+</td> <td>\$63.59</td> </tr> </tbody> </table> <p>HN Female to BNC Male</p> <p>Model No: <a href="#">PE9129</a></p>	PRICE		1-24	\$73.94	25-49	\$70.24	50-99	\$66.55	100+	\$63.59	 <table border="1"> <thead> <tr> <th colspan="2">PRICE</th> </tr> </thead> <tbody> <tr> <td>1-24</td> <td>\$133.36</td> </tr> <tr> <td>25-49</td> <td>\$126.69</td> </tr> <tr> <td>50-99</td> <td>\$120.02</td> </tr> <tr> <td>100+</td> <td>\$114.69</td> </tr> </tbody> </table> <p>HN Female to C Male</p> <p>Model No: <a href="#">PE9212</a></p>	PRICE		1-24	\$133.36	25-49	\$126.69	50-99	\$120.02	100+	\$114.69
PRICE																																																							
1-24	\$88.24																																																						
25-49	\$83.83																																																						
50-99	\$79.42																																																						
100+	\$75.89																																																						
PRICE																																																							
1-9	\$229.40																																																						
10-24	\$217.93																																																						
25-49	\$206.46																																																						
50+	\$197.28																																																						
PRICE																																																							
1-9	\$155.90																																																						
10-24	\$148.11																																																						
25-49	\$140.31																																																						
50+	\$134.07																																																						
PRICE																																																							
1-24	\$73.94																																																						
25-49	\$70.24																																																						
50-99	\$66.55																																																						
100+	\$63.59																																																						
PRICE																																																							
1-24	\$133.36																																																						
25-49	\$126.69																																																						
50-99	\$120.02																																																						
100+	\$114.69																																																						
7	 <table border="1"> <thead> <tr> <th colspan="2">PRICE</th> </tr> </thead> <tbody> <tr> <td>1-9</td> <td>\$217.52</td> </tr> <tr> <td>10-24</td> <td>\$206.64</td> </tr> <tr> <td>25-49</td> <td>\$195.77</td> </tr> <tr> <td>50+</td> <td>\$187.07</td> </tr> </tbody> </table> <p>HN Female to GR874 Sexless</p> <p>Model No: <a href="#">PE9387</a></p>	PRICE		1-9	\$217.52	10-24	\$206.64	25-49	\$195.77	50+	\$187.07	<p><b>LC In-Series</b></p>  <table border="1"> <thead> <tr> <th colspan="2">PRICE</th> </tr> </thead> <tbody> <tr> <td>1-9</td> <td>\$327.03</td> </tr> <tr> <td>10-24</td> <td>\$310.68</td> </tr> <tr> <td>25-49</td> <td>\$294.33</td> </tr> <tr> <td>50+</td> <td>\$281.25</td> </tr> </tbody> </table> <p>LC Male to LC Male</p> <p>Model No: <a href="#">PE9569</a></p>	PRICE		1-9	\$327.03	10-24	\$310.68	25-49	\$294.33	50+	\$281.25	 <table border="1"> <thead> <tr> <th colspan="2">PRICE</th> </tr> </thead> <tbody> <tr> <td>1-9</td> <td>\$434.63</td> </tr> <tr> <td>10-24</td> <td>\$412.90</td> </tr> <tr> <td>25-49</td> <td>\$391.17</td> </tr> <tr> <td>50+</td> <td>\$373.78</td> </tr> </tbody> </table> <p>LC Male to LC Female Right Angle</p> <p>Model No: <a href="#">PE9398</a></p>	PRICE		1-9	\$434.63	10-24	\$412.90	25-49	\$391.17	50+	\$373.78	 <table border="1"> <thead> <tr> <th colspan="2">PRICE</th> </tr> </thead> <tbody> <tr> <td>1-9</td> <td>\$271.35</td> </tr> <tr> <td>10-24</td> <td>\$257.78</td> </tr> <tr> <td>25-49</td> <td>\$244.22</td> </tr> <tr> <td>50+</td> <td>\$233.36</td> </tr> </tbody> </table> <p>LC Female to LC Female</p> <p>Model No: <a href="#">PE9419</a></p>	PRICE		1-9	\$271.35	10-24	\$257.78	25-49	\$244.22	50+	\$233.36											
PRICE																																																							
1-9	\$217.52																																																						
10-24	\$206.64																																																						
25-49	\$195.77																																																						
50+	\$187.07																																																						
PRICE																																																							
1-9	\$327.03																																																						
10-24	\$310.68																																																						
25-49	\$294.33																																																						
50+	\$281.25																																																						
PRICE																																																							
1-9	\$434.63																																																						
10-24	\$412.90																																																						
25-49	\$391.17																																																						
50+	\$373.78																																																						
PRICE																																																							
1-9	\$271.35																																																						
10-24	\$257.78																																																						
25-49	\$244.22																																																						
50+	\$233.36																																																						

# ADAPTERS

See Adapter Locator on Pages 10-15  
See Page 409 for Mounting Holes

Adapters

See Our Website For Current Pricing & Real-Time Stock Availability!

	A	B	C	D	E																																																																								
1	<p><b>LC</b> <i>Between Series</i></p>  <table border="1"> <thead> <tr> <th colspan="2">PRICE</th> </tr> </thead> <tbody> <tr> <td>1-9</td> <td>\$329.95</td> </tr> <tr> <td>10-24</td> <td>\$313.45</td> </tr> <tr> <td>25-49</td> <td>\$296.96</td> </tr> <tr> <td>50+</td> <td>\$283.76</td> </tr> </tbody> </table> <p>LC Male to HN Female</p> <p>Model No: <a href="#">PE9181</a></p>	PRICE		1-9	\$329.95	10-24	\$313.45	25-49	\$296.96	50+	\$283.76	<p><b>LC Female to HN Male</b></p>  <table border="1"> <thead> <tr> <th colspan="2">PRICE</th> </tr> </thead> <tbody> <tr> <td>1-9</td> <td>\$304.16</td> </tr> <tr> <td>10-24</td> <td>\$288.95</td> </tr> <tr> <td>25-49</td> <td>\$273.74</td> </tr> <tr> <td>50+</td> <td>\$261.58</td> </tr> </tbody> </table> <p>LC Female to HN Male</p> <p>Model No: <a href="#">PE9413</a></p>	PRICE		1-9	\$304.16	10-24	\$288.95	25-49	\$273.74	50+	\$261.58	<p><b>MCX In-Series</b></p>  <table border="1"> <thead> <tr> <th colspan="2">PRICE</th> </tr> </thead> <tbody> <tr> <td>1-24</td> <td>\$78.35</td> </tr> <tr> <td>25-49</td> <td>\$74.43</td> </tr> <tr> <td>50-99</td> <td>\$70.52</td> </tr> <tr> <td>100+</td> <td>\$67.38</td> </tr> </tbody> </table> <p>MCX Plug to MCX Jack</p> <p>VSWR 1.35:1 to 6 GHz</p> <p>Model No: <a href="#">PE9479</a></p>	PRICE		1-24	\$78.35	25-49	\$74.43	50-99	\$70.52	100+	\$67.38	<p><b>MCX Jack to MCX Jack</b></p>  <table border="1"> <thead> <tr> <th colspan="2">PRICE</th> </tr> </thead> <tbody> <tr> <td>1-24</td> <td>\$24.24</td> </tr> <tr> <td>25-49</td> <td>\$23.03</td> </tr> <tr> <td>50-99</td> <td>\$21.82</td> </tr> <tr> <td>100+</td> <td>\$20.85</td> </tr> </tbody> </table> <p>MCX Jack to MCX Jack</p> <p>Model No: <a href="#">PE9524</a></p>	PRICE		1-24	\$24.24	25-49	\$23.03	50-99	\$21.82	100+	\$20.85	<p><b>MCX Jack to MCX Jack Bulkhead</b></p>  <table border="1"> <thead> <tr> <th colspan="2">PRICE</th> </tr> </thead> <tbody> <tr> <td>1-24</td> <td>\$30.30</td> </tr> <tr> <td>25-49</td> <td>\$28.79</td> </tr> <tr> <td>50-99</td> <td>\$27.27</td> </tr> <tr> <td>100+</td> <td>\$26.06</td> </tr> </tbody> </table> <p>MCX Jack to MCX Jack Bulkhead</p> <p>VSWR 1.35:1 to 3 GHz</p> <p>Model No: <a href="#">PE9474</a></p>	PRICE		1-24	\$30.30	25-49	\$28.79	50-99	\$27.27	100+	\$26.06	<p><b>MCX Plug to BNC Male</b></p>  <table border="1"> <thead> <tr> <th colspan="2">PRICE</th> </tr> </thead> <tbody> <tr> <td>1-24</td> <td>\$106.64</td> </tr> <tr> <td>25-49</td> <td>\$101.31</td> </tr> <tr> <td>50-99</td> <td>\$95.98</td> </tr> <tr> <td>100+</td> <td>\$91.71</td> </tr> </tbody> </table> <p>MCX Plug to BNC Male</p> <p>Model No: <a href="#">PE9469</a></p>	PRICE		1-24	\$106.64	25-49	\$101.31	50-99	\$95.98	100+	\$91.71	<p><b>MCX Plug to BNC Female</b></p>  <table border="1"> <thead> <tr> <th colspan="2">PRICE</th> </tr> </thead> <tbody> <tr> <td>1-24</td> <td>\$90.04</td> </tr> <tr> <td>25-49</td> <td>\$85.54</td> </tr> <tr> <td>50-99</td> <td>\$81.04</td> </tr> <tr> <td>100+</td> <td>\$77.43</td> </tr> </tbody> </table> <p>MCX Plug to BNC Female</p> <p>Model No: <a href="#">PE9467</a></p>	PRICE		1-24	\$90.04	25-49	\$85.54	50-99	\$81.04	100+	\$77.43
PRICE																																																																													
1-9	\$329.95																																																																												
10-24	\$313.45																																																																												
25-49	\$296.96																																																																												
50+	\$283.76																																																																												
PRICE																																																																													
1-9	\$304.16																																																																												
10-24	\$288.95																																																																												
25-49	\$273.74																																																																												
50+	\$261.58																																																																												
PRICE																																																																													
1-24	\$78.35																																																																												
25-49	\$74.43																																																																												
50-99	\$70.52																																																																												
100+	\$67.38																																																																												
PRICE																																																																													
1-24	\$24.24																																																																												
25-49	\$23.03																																																																												
50-99	\$21.82																																																																												
100+	\$20.85																																																																												
PRICE																																																																													
1-24	\$30.30																																																																												
25-49	\$28.79																																																																												
50-99	\$27.27																																																																												
100+	\$26.06																																																																												
PRICE																																																																													
1-24	\$106.64																																																																												
25-49	\$101.31																																																																												
50-99	\$95.98																																																																												
100+	\$91.71																																																																												
PRICE																																																																													
1-24	\$90.04																																																																												
25-49	\$85.54																																																																												
50-99	\$81.04																																																																												
100+	\$77.43																																																																												
2	<p><b>MCX Jack to BNC Male</b></p>  <table border="1"> <thead> <tr> <th colspan="2">PRICE</th> </tr> </thead> <tbody> <tr> <td>1-24</td> <td>\$83.77</td> </tr> <tr> <td>25-49</td> <td>\$79.58</td> </tr> <tr> <td>50-99</td> <td>\$75.39</td> </tr> <tr> <td>100+</td> <td>\$72.04</td> </tr> </tbody> </table> <p>MCX Jack to BNC Male</p> <p>Model No: <a href="#">PE9468</a></p>	PRICE		1-24	\$83.77	25-49	\$79.58	50-99	\$75.39	100+	\$72.04	<p><b>MCX Jack to BNC Female</b></p>  <table border="1"> <thead> <tr> <th colspan="2">PRICE</th> </tr> </thead> <tbody> <tr> <td>1-24</td> <td>\$107.37</td> </tr> <tr> <td>25-49</td> <td>\$102.00</td> </tr> <tr> <td>50-99</td> <td>\$96.63</td> </tr> <tr> <td>100+</td> <td>\$92.34</td> </tr> </tbody> </table> <p>MCX Jack to BNC Female</p> <p>Model No: <a href="#">PE9466</a></p>	PRICE		1-24	\$107.37	25-49	\$102.00	50-99	\$96.63	100+	\$92.34	<p><b>MCX Jack to BNC Female Bulkhead-Mounting Hole B04</b></p>  <table border="1"> <thead> <tr> <th colspan="2">PRICE</th> </tr> </thead> <tbody> <tr> <td>1-24</td> <td>\$107.64</td> </tr> <tr> <td>25-49</td> <td>\$102.26</td> </tr> <tr> <td>50-99</td> <td>\$96.88</td> </tr> <tr> <td>100+</td> <td>\$92.57</td> </tr> </tbody> </table> <p>MCX Jack to BNC Female Bulkhead-Mounting Hole B04</p> <p>Model No: <a href="#">PE9520</a></p>	PRICE		1-24	\$107.64	25-49	\$102.26	50-99	\$96.88	100+	\$92.57	<p><b>MHV In-Series</b></p>  <table border="1"> <thead> <tr> <th colspan="2">PRICE</th> </tr> </thead> <tbody> <tr> <td>1-24</td> <td>\$49.33</td> </tr> <tr> <td>25-49</td> <td>\$46.86</td> </tr> <tr> <td>50-99</td> <td>\$44.40</td> </tr> <tr> <td>100+</td> <td>\$42.42</td> </tr> </tbody> </table> <p>MHV Male to BNC Female</p> <p>VSWR 1.3:1 to 300 MHz</p> <p>Model No: <a href="#">PE9297</a></p>	PRICE		1-24	\$49.33	25-49	\$46.86	50-99	\$44.40	100+	\$42.42																																	
PRICE																																																																													
1-24	\$83.77																																																																												
25-49	\$79.58																																																																												
50-99	\$75.39																																																																												
100+	\$72.04																																																																												
PRICE																																																																													
1-24	\$107.37																																																																												
25-49	\$102.00																																																																												
50-99	\$96.63																																																																												
100+	\$92.34																																																																												
PRICE																																																																													
1-24	\$107.64																																																																												
25-49	\$102.26																																																																												
50-99	\$96.88																																																																												
100+	\$92.57																																																																												
PRICE																																																																													
1-24	\$49.33																																																																												
25-49	\$46.86																																																																												
50-99	\$44.40																																																																												
100+	\$42.42																																																																												
3	<p><b>MHV Male to MHV Female Right Angle</b></p>  <table border="1"> <thead> <tr> <th colspan="2">PRICE</th> </tr> </thead> <tbody> <tr> <td>1-24</td> <td>\$65.74</td> </tr> <tr> <td>25-49</td> <td>\$62.45</td> </tr> <tr> <td>50-99</td> <td>\$59.17</td> </tr> <tr> <td>100+</td> <td>\$56.54</td> </tr> </tbody> </table> <p>MHV Male to MHV Female Right Angle</p> <p>Max. Freq. 50 MHz</p> <p>Model No: <a href="#">PE9266</a></p>	PRICE		1-24	\$65.74	25-49	\$62.45	50-99	\$59.17	100+	\$56.54	<p><b>MHV Female to MHV Male Tee</b></p>  <table border="1"> <thead> <tr> <th colspan="2">PRICE</th> </tr> </thead> <tbody> <tr> <td>1-24</td> <td>\$77.63</td> </tr> <tr> <td>25-49</td> <td>\$73.75</td> </tr> <tr> <td>50-99</td> <td>\$69.87</td> </tr> <tr> <td>100+</td> <td>\$66.76</td> </tr> </tbody> </table> <p>MHV Female to MHV Male Tee</p> <p>Max. Freq. 50 MHz</p> <p>Model No: <a href="#">PE9211</a></p>	PRICE		1-24	\$77.63	25-49	\$73.75	50-99	\$69.87	100+	\$66.76	<p><b>MHV Female to MHV Female</b></p>  <table border="1"> <thead> <tr> <th colspan="2">PRICE</th> </tr> </thead> <tbody> <tr> <td>1-24</td> <td>\$41.53</td> </tr> <tr> <td>25-49</td> <td>\$39.45</td> </tr> <tr> <td>50-99</td> <td>\$37.38</td> </tr> <tr> <td>100+</td> <td>\$35.72</td> </tr> </tbody> </table> <p>MHV Female to MHV Female</p> <p>VSWR 1.3:1 to 300 MHz</p> <p>Model No: <a href="#">PE9267</a></p>	PRICE		1-24	\$41.53	25-49	\$39.45	50-99	\$37.38	100+	\$35.72	<p><b>MHV Female to MHV Female Bulkhead</b></p>  <table border="1"> <thead> <tr> <th colspan="2">PRICE</th> </tr> </thead> <tbody> <tr> <td>1-24</td> <td>\$71.38</td> </tr> <tr> <td>25-49</td> <td>\$67.81</td> </tr> <tr> <td>50-99</td> <td>\$64.24</td> </tr> <tr> <td>100+</td> <td>\$61.39</td> </tr> </tbody> </table> <p>MHV Female to MHV Female Bulkhead</p> <p>Model No: <a href="#">PE9268</a></p>	PRICE		1-24	\$71.38	25-49	\$67.81	50-99	\$64.24	100+	\$61.39																																	
PRICE																																																																													
1-24	\$65.74																																																																												
25-49	\$62.45																																																																												
50-99	\$59.17																																																																												
100+	\$56.54																																																																												
PRICE																																																																													
1-24	\$77.63																																																																												
25-49	\$73.75																																																																												
50-99	\$69.87																																																																												
100+	\$66.76																																																																												
PRICE																																																																													
1-24	\$41.53																																																																												
25-49	\$39.45																																																																												
50-99	\$37.38																																																																												
100+	\$35.72																																																																												
PRICE																																																																													
1-24	\$71.38																																																																												
25-49	\$67.81																																																																												
50-99	\$64.24																																																																												
100+	\$61.39																																																																												
4	<p><b>MHV Male to SHV Plug</b></p>  <table border="1"> <thead> <tr> <th colspan="2">PRICE</th> </tr> </thead> <tbody> <tr> <td>1-24</td> <td>\$112.19</td> </tr> <tr> <td>25-49</td> <td>\$106.58</td> </tr> <tr> <td>50-99</td> <td>\$100.97</td> </tr> <tr> <td>100+</td> <td>\$96.48</td> </tr> </tbody> </table> <p>MHV Male to SHV Plug</p> <p>Model No: <a href="#">PE9340</a></p>	PRICE		1-24	\$112.19	25-49	\$106.58	50-99	\$100.97	100+	\$96.48	<p><b>MHV Male to SHV Jack</b></p>  <table border="1"> <thead> <tr> <th colspan="2">PRICE</th> </tr> </thead> <tbody> <tr> <td>1-9</td> <td>\$144.33</td> </tr> <tr> <td>10-24</td> <td>\$137.11</td> </tr> <tr> <td>25-49</td> <td>\$129.90</td> </tr> <tr> <td>50+</td> <td>\$124.12</td> </tr> </tbody> </table> <p>MHV Male to SHV Jack</p> <p>Model No: <a href="#">PE9335</a></p>	PRICE		1-9	\$144.33	10-24	\$137.11	25-49	\$129.90	50+	\$124.12	<p><b>MHV Female to SHV Plug</b></p>  <table border="1"> <thead> <tr> <th colspan="2">PRICE</th> </tr> </thead> <tbody> <tr> <td>1-9</td> <td>\$123.90</td> </tr> <tr> <td>10-24</td> <td>\$117.71</td> </tr> <tr> <td>25-49</td> <td>\$111.51</td> </tr> <tr> <td>50+</td> <td>\$106.55</td> </tr> </tbody> </table> <p>MHV Female to SHV Plug</p> <p>Model No: <a href="#">PE9265</a></p>	PRICE		1-9	\$123.90	10-24	\$117.71	25-49	\$111.51	50+	\$106.55	<p><b>MHV Female to SHV Jack</b></p>  <table border="1"> <thead> <tr> <th colspan="2">PRICE</th> </tr> </thead> <tbody> <tr> <td>1-24</td> <td>\$74.41</td> </tr> <tr> <td>25-49</td> <td>\$70.69</td> </tr> <tr> <td>50-99</td> <td>\$66.97</td> </tr> <tr> <td>100+</td> <td>\$63.99</td> </tr> </tbody> </table> <p>MHV Female to SHV Jack</p> <p>Model No: <a href="#">PE9339</a></p>	PRICE		1-24	\$74.41	25-49	\$70.69	50-99	\$66.97	100+	\$63.99																																	
PRICE																																																																													
1-24	\$112.19																																																																												
25-49	\$106.58																																																																												
50-99	\$100.97																																																																												
100+	\$96.48																																																																												
PRICE																																																																													
1-9	\$144.33																																																																												
10-24	\$137.11																																																																												
25-49	\$129.90																																																																												
50+	\$124.12																																																																												
PRICE																																																																													
1-9	\$123.90																																																																												
10-24	\$117.71																																																																												
25-49	\$111.51																																																																												
50+	\$106.55																																																																												
PRICE																																																																													
1-24	\$74.41																																																																												
25-49	\$70.69																																																																												
50-99	\$66.97																																																																												
100+	\$63.99																																																																												
5	<p><b>Mini SMP Female to Mini SMP Female</b></p>  <table border="1"> <thead> <tr> <th colspan="2">PRICE</th> </tr> </thead> <tbody> <tr> <td>1-24</td> <td>\$55.26</td> </tr> <tr> <td>25-49</td> <td>\$52.50</td> </tr> <tr> <td>50-99</td> <td>\$49.73</td> </tr> <tr> <td>100+</td> <td>\$47.52</td> </tr> </tbody> </table> <p>Mini SMP Female to Mini SMP Female</p> <p>Max. Freq. 65 GHz</p> <p>Model No: <a href="#">PE9780</a></p>	PRICE		1-24	\$55.26	25-49	\$52.50	50-99	\$49.73	100+	\$47.52	<p><b>Mini SMP Female to Mini SMP Female</b></p>  <table border="1"> <thead> <tr> <th colspan="2">PRICE</th> </tr> </thead> <tbody> <tr> <td>1-24</td> <td>\$31.57</td> </tr> <tr> <td>25-49</td> <td>\$29.99</td> </tr> <tr> <td>50-99</td> <td>\$28.41</td> </tr> <tr> <td>100+</td> <td>\$27.15</td> </tr> </tbody> </table> <p>Mini SMP Female to Mini SMP Female</p> <p>VSWR 1.2:1 to 26.5 GHz</p> <p>Model No: <a href="#">PE91069</a></p>	PRICE		1-24	\$31.57	25-49	\$29.99	50-99	\$28.41	100+	\$27.15	<p><b>Mini UHF In-Series</b></p>  <table border="1"> <thead> <tr> <th colspan="2">PRICE</th> </tr> </thead> <tbody> <tr> <td>1-24</td> <td>\$18.93</td> </tr> <tr> <td>25-49</td> <td>\$17.98</td> </tr> <tr> <td>50-99</td> <td>\$17.04</td> </tr> <tr> <td>100+</td> <td>\$16.28</td> </tr> </tbody> </table> <p>Mini UHF Male to Mini UHF Female Right Angle</p> <p>Model No: <a href="#">PE9347</a></p>	PRICE		1-24	\$18.93	25-49	\$17.98	50-99	\$17.04	100+	\$16.28	<p><b>Mini UHF Female to Mini UHF Male Tee</b></p>  <table border="1"> <thead> <tr> <th colspan="2">PRICE</th> </tr> </thead> <tbody> <tr> <td>1-24</td> <td>\$11.35</td> </tr> <tr> <td>25-49</td> <td>\$10.78</td> </tr> <tr> <td>50-99</td> <td>\$10.22</td> </tr> <tr> <td>100+</td> <td>\$9.76</td> </tr> </tbody> </table> <p>Mini UHF Female to Mini UHF Male Tee</p> <p>Model No: <a href="#">PE9065</a></p>	PRICE		1-24	\$11.35	25-49	\$10.78	50-99	\$10.22	100+	\$9.76																																	
PRICE																																																																													
1-24	\$55.26																																																																												
25-49	\$52.50																																																																												
50-99	\$49.73																																																																												
100+	\$47.52																																																																												
PRICE																																																																													
1-24	\$31.57																																																																												
25-49	\$29.99																																																																												
50-99	\$28.41																																																																												
100+	\$27.15																																																																												
PRICE																																																																													
1-24	\$18.93																																																																												
25-49	\$17.98																																																																												
50-99	\$17.04																																																																												
100+	\$16.28																																																																												
PRICE																																																																													
1-24	\$11.35																																																																												
25-49	\$10.78																																																																												
50-99	\$10.22																																																																												
100+	\$9.76																																																																												
6	<p><b>Mini UHF Female to Mini UHF Female</b></p>  <table border="1"> <thead> <tr> <th colspan="2">PRICE</th> </tr> </thead> <tbody> <tr> <td>1-24</td> <td>\$21.20</td> </tr> <tr> <td>25-49</td> <td>\$20.14</td> </tr> <tr> <td>50-99</td> <td>\$19.08</td> </tr> <tr> <td>100+</td> <td>\$18.23</td> </tr> </tbody> </table> <p>Mini UHF Female to Mini UHF Female</p> <p>Model No: <a href="#">PE9343</a></p>	PRICE		1-24	\$21.20	25-49	\$20.14	50-99	\$19.08	100+	\$18.23	<p><b>Mini UHF Female to Mini UHF Female Tee</b></p>  <table border="1"> <thead> <tr> <th colspan="2">PRICE</th> </tr> </thead> <tbody> <tr> <td>1-24</td> <td>\$19.44</td> </tr> <tr> <td>25-49</td> <td>\$18.47</td> </tr> <tr> <td>50-99</td> <td>\$17.50</td> </tr> <tr> <td>100+</td> <td>\$16.72</td> </tr> </tbody> </table> <p>Mini UHF Female to Mini UHF Female Tee</p> <p>Model No: <a href="#">PE9066</a></p>	PRICE		1-24	\$19.44	25-49	\$18.47	50-99	\$17.50	100+	\$16.72	<p><b>Mini UHF Male to BNC Female</b></p>  <table border="1"> <thead> <tr> <th colspan="2">PRICE</th> </tr> </thead> <tbody> <tr> <td>1-24</td> <td>\$20.20</td> </tr> <tr> <td>25-49</td> <td>\$19.19</td> </tr> <tr> <td>50-99</td> <td>\$18.18</td> </tr> <tr> <td>100+</td> <td>\$17.37</td> </tr> </tbody> </table> <p>Mini UHF Male to BNC Female</p> <p>Model No: <a href="#">PE9342</a></p>	PRICE		1-24	\$20.20	25-49	\$19.19	50-99	\$18.18	100+	\$17.37	<p><b>Mini UHF Male to FME Plug</b></p>  <table border="1"> <thead> <tr> <th colspan="2">PRICE</th> </tr> </thead> <tbody> <tr> <td>1-24</td> <td>\$19.40</td> </tr> <tr> <td>25-49</td> <td>\$18.43</td> </tr> <tr> <td>50-99</td> <td>\$17.46</td> </tr> <tr> <td>100+</td> <td>\$16.68</td> </tr> </tbody> </table> <p>Mini UHF Male to FME Plug</p> <p>Model No: <a href="#">PE9705</a></p>	PRICE		1-24	\$19.40	25-49	\$18.43	50-99	\$17.46	100+	\$16.68																																	
PRICE																																																																													
1-24	\$21.20																																																																												
25-49	\$20.14																																																																												
50-99	\$19.08																																																																												
100+	\$18.23																																																																												
PRICE																																																																													
1-24	\$19.44																																																																												
25-49	\$18.47																																																																												
50-99	\$17.50																																																																												
100+	\$16.72																																																																												
PRICE																																																																													
1-24	\$20.20																																																																												
25-49	\$19.19																																																																												
50-99	\$18.18																																																																												
100+	\$17.37																																																																												
PRICE																																																																													
1-24	\$19.40																																																																												
25-49	\$18.43																																																																												
50-99	\$17.46																																																																												
100+	\$16.68																																																																												
7																																																																													



# ADAPTERS

See Adapter Locator on Pages 10-15  
See Page 409 for Mounting Holes

	A	B	C	D	E																																																		
1	 <table border="1"> <thead> <tr><th colspan="2">PRICE</th></tr> </thead> <tbody> <tr><td>1-24</td><td>\$18.53</td></tr> <tr><td>25-49</td><td>\$17.60</td></tr> <tr><td>50-99</td><td>\$16.68</td></tr> <tr><td>100+</td><td>\$15.94</td></tr> </tbody> </table> <p>Mini UHF Male to FME Plug Right Angle</p> <p>Model No: <a href="#">PE9706</a></p>	PRICE		1-24	\$18.53	25-49	\$17.60	50-99	\$16.68	100+	\$15.94	 <table border="1"> <thead> <tr><th colspan="2">PRICE</th></tr> </thead> <tbody> <tr><td>1-24</td><td>\$16.18</td></tr> <tr><td>25-49</td><td>\$15.37</td></tr> <tr><td>50-99</td><td>\$14.56</td></tr> <tr><td>100+</td><td>\$13.91</td></tr> </tbody> </table> <p>Mini UHF Male to FME Jack</p> <p>Model No: <a href="#">PE9709</a></p>	PRICE		1-24	\$16.18	25-49	\$15.37	50-99	\$14.56	100+	\$13.91	 <table border="1"> <thead> <tr><th colspan="2">PRICE</th></tr> </thead> <tbody> <tr><td>1-24</td><td>\$21.90</td></tr> <tr><td>25-49</td><td>\$20.81</td></tr> <tr><td>50-99</td><td>\$19.71</td></tr> <tr><td>100+</td><td>\$18.83</td></tr> </tbody> </table> <p>Mini UHF Female to BNC Male</p> <p>Model No: <a href="#">PE9341</a></p>	PRICE		1-24	\$21.90	25-49	\$20.81	50-99	\$19.71	100+	\$18.83	 <table border="1"> <thead> <tr><th colspan="2">PRICE</th></tr> </thead> <tbody> <tr><td>1-24</td><td>\$17.14</td></tr> <tr><td>25-49</td><td>\$16.28</td></tr> <tr><td>50-99</td><td>\$15.43</td></tr> <tr><td>100+</td><td>\$14.74</td></tr> </tbody> </table> <p>Mini UHF Female to FME Jack</p> <p>Model No: <a href="#">PE9710</a></p>	PRICE		1-24	\$17.14	25-49	\$16.28	50-99	\$15.43	100+	\$14.74	<p><b>MMCX In-Series</b></p> <p>→</p>										
	PRICE																																																						
1-24	\$18.53																																																						
25-49	\$17.60																																																						
50-99	\$16.68																																																						
100+	\$15.94																																																						
PRICE																																																							
1-24	\$16.18																																																						
25-49	\$15.37																																																						
50-99	\$14.56																																																						
100+	\$13.91																																																						
PRICE																																																							
1-24	\$21.90																																																						
25-49	\$20.81																																																						
50-99	\$19.71																																																						
100+	\$18.83																																																						
PRICE																																																							
1-24	\$17.14																																																						
25-49	\$16.28																																																						
50-99	\$15.43																																																						
100+	\$14.74																																																						
2	 <table border="1"> <thead> <tr><th colspan="2">PRICE</th></tr> </thead> <tbody> <tr><td>1-24</td><td>\$100.59</td></tr> <tr><td>25-49</td><td>\$95.56</td></tr> <tr><td>50-99</td><td>\$90.53</td></tr> <tr><td>100+</td><td>\$86.51</td></tr> </tbody> </table> <p>MMCX Plug to MMCX Jack</p> <p>Model No: <a href="#">PE9480</a></p>	PRICE		1-24	\$100.59	25-49	\$95.56	50-99	\$90.53	100+	\$86.51	 <table border="1"> <thead> <tr><th colspan="2">PRICE</th></tr> </thead> <tbody> <tr><td>1-24</td><td>\$80.36</td></tr> <tr><td>25-49</td><td>\$76.34</td></tr> <tr><td>50-99</td><td>\$72.32</td></tr> <tr><td>100+</td><td>\$69.11</td></tr> </tbody> </table> <p>MMCX Jack to MMCX Jack</p> <p>Model No: <a href="#">PE9523</a></p>	PRICE		1-24	\$80.36	25-49	\$76.34	50-99	\$72.32	100+	\$69.11	 <table border="1"> <thead> <tr><th colspan="2">PRICE</th></tr> </thead> <tbody> <tr><td>1-24</td><td>\$72.00</td></tr> <tr><td>25-49</td><td>\$68.40</td></tr> <tr><td>50-99</td><td>\$64.80</td></tr> <tr><td>100+</td><td>\$61.92</td></tr> </tbody> </table> <p>MMCX Jack to MMCX Jack Bulkhead-Mounting Hole B01</p> <p>Model No: <a href="#">PE9522</a></p>	PRICE		1-24	\$72.00	25-49	\$68.40	50-99	\$64.80	100+	\$61.92	<p><b>MMCX Between Series</b></p> <p>→</p>	 <table border="1"> <thead> <tr><th colspan="2">PRICE</th></tr> </thead> <tbody> <tr><td>1-9</td><td>\$121.30</td></tr> <tr><td>10-24</td><td>\$115.24</td></tr> <tr><td>25-49</td><td>\$109.17</td></tr> <tr><td>50+</td><td>\$104.32</td></tr> </tbody> </table> <p>MMCX Plug to BNC Male</p> <p>Model No: <a href="#">PE9517</a></p>	PRICE		1-9	\$121.30	10-24	\$115.24	25-49	\$109.17	50+	\$104.32										
	PRICE																																																						
1-24	\$100.59																																																						
25-49	\$95.56																																																						
50-99	\$90.53																																																						
100+	\$86.51																																																						
PRICE																																																							
1-24	\$80.36																																																						
25-49	\$76.34																																																						
50-99	\$72.32																																																						
100+	\$69.11																																																						
PRICE																																																							
1-24	\$72.00																																																						
25-49	\$68.40																																																						
50-99	\$64.80																																																						
100+	\$61.92																																																						
PRICE																																																							
1-9	\$121.30																																																						
10-24	\$115.24																																																						
25-49	\$109.17																																																						
50+	\$104.32																																																						
3	 <table border="1"> <thead> <tr><th colspan="2">PRICE</th></tr> </thead> <tbody> <tr><td>1-24</td><td>\$106.13</td></tr> <tr><td>25-49</td><td>\$100.82</td></tr> <tr><td>50-99</td><td>\$95.52</td></tr> <tr><td>100+</td><td>\$91.27</td></tr> </tbody> </table> <p>MMCX Plug to MCX Plug</p> <p>Model No: <a href="#">PE9527</a></p>	PRICE		1-24	\$106.13	25-49	\$100.82	50-99	\$95.52	100+	\$91.27	 <table border="1"> <thead> <tr><th colspan="2">PRICE</th></tr> </thead> <tbody> <tr><td>1-24</td><td>\$125.73</td></tr> <tr><td>25-49</td><td>\$119.44</td></tr> <tr><td>50-99</td><td>\$113.16</td></tr> <tr><td>100+</td><td>\$108.13</td></tr> </tbody> </table> <p>MMCX Plug to MCX Jack</p> <p>Model No: <a href="#">PE9525</a></p>	PRICE		1-24	\$125.73	25-49	\$119.44	50-99	\$113.16	100+	\$108.13	 <table border="1"> <thead> <tr><th colspan="2">PRICE</th></tr> </thead> <tbody> <tr><td>1-24</td><td>\$98.43</td></tr> <tr><td>25-49</td><td>\$93.51</td></tr> <tr><td>50-99</td><td>\$88.59</td></tr> <tr><td>100+</td><td>\$84.65</td></tr> </tbody> </table> <p>MMCX Jack to BNC Male</p> <p>Model No: <a href="#">PE9518</a></p>	PRICE		1-24	\$98.43	25-49	\$93.51	50-99	\$88.59	100+	\$84.65	 <table border="1"> <thead> <tr><th colspan="2">PRICE</th></tr> </thead> <tbody> <tr><td>1-24</td><td>\$104.47</td></tr> <tr><td>25-49</td><td>\$99.25</td></tr> <tr><td>50-99</td><td>\$94.02</td></tr> <tr><td>100+</td><td>\$89.84</td></tr> </tbody> </table> <p>MMCX Jack to BNC Female</p> <p>Model No: <a href="#">PE9516</a></p>	PRICE		1-24	\$104.47	25-49	\$99.25	50-99	\$94.02	100+	\$89.84	 <table border="1"> <thead> <tr><th colspan="2">PRICE</th></tr> </thead> <tbody> <tr><td>1-24</td><td>\$125.08</td></tr> <tr><td>25-49</td><td>\$118.83</td></tr> <tr><td>50-99</td><td>\$112.57</td></tr> <tr><td>100+</td><td>\$107.57</td></tr> </tbody> </table> <p>MMCX Jack to MCX Plug</p> <p>Model No: <a href="#">PE9528</a></p>	PRICE		1-24	\$125.08	25-49	\$118.83	50-99	\$112.57	100+	\$107.57
	PRICE																																																						
1-24	\$106.13																																																						
25-49	\$100.82																																																						
50-99	\$95.52																																																						
100+	\$91.27																																																						
PRICE																																																							
1-24	\$125.73																																																						
25-49	\$119.44																																																						
50-99	\$113.16																																																						
100+	\$108.13																																																						
PRICE																																																							
1-24	\$98.43																																																						
25-49	\$93.51																																																						
50-99	\$88.59																																																						
100+	\$84.65																																																						
PRICE																																																							
1-24	\$104.47																																																						
25-49	\$99.25																																																						
50-99	\$94.02																																																						
100+	\$89.84																																																						
PRICE																																																							
1-24	\$125.08																																																						
25-49	\$118.83																																																						
50-99	\$112.57																																																						
100+	\$107.57																																																						
4	 <table border="1"> <thead> <tr><th colspan="2">PRICE</th></tr> </thead> <tbody> <tr><td>1-24</td><td>\$115.37</td></tr> <tr><td>25-49</td><td>\$109.60</td></tr> <tr><td>50-99</td><td>\$103.83</td></tr> <tr><td>100+</td><td>\$99.22</td></tr> </tbody> </table> <p>MMCX Jack to MCX Jack</p> <p>Model No: <a href="#">PE9526</a></p>	PRICE		1-24	\$115.37	25-49	\$109.60	50-99	\$103.83	100+	\$99.22	<p><b>MMBX In-Series</b></p> <p>→</p>	 <table border="1"> <thead> <tr><th colspan="2">PRICE</th></tr> </thead> <tbody> <tr><td>1-24</td><td>\$9.87</td></tr> <tr><td>25-49</td><td>\$9.38</td></tr> <tr><td>50-99</td><td>\$8.88</td></tr> <tr><td>100+</td><td>\$8.49</td></tr> </tbody> </table> <p>Slide-On MMBX Plug to Snap-On MMBX Plug</p> <p>VSWR 1.08:1 to 12.4 GHz</p> <p>Model No: <a href="#">PE91370</a></p>	PRICE		1-24	\$9.87	25-49	\$9.38	50-99	\$8.88	100+	\$8.49	 <table border="1"> <thead> <tr><th colspan="2">PRICE</th></tr> </thead> <tbody> <tr><td>1-24</td><td>\$14.80</td></tr> <tr><td>25-49</td><td>\$14.06</td></tr> <tr><td>50-99</td><td>\$13.32</td></tr> <tr><td>100+</td><td>\$12.73</td></tr> </tbody> </table> <p>Slide-On MMBX Plug to Slide-On MMBX Plug</p> <p>VSWR 1.15:1 to 12.4 GHz</p> <p>Model No: <a href="#">PE91371</a></p>	PRICE		1-24	\$14.80	25-49	\$14.06	50-99	\$13.32	100+	\$12.73	 <table border="1"> <thead> <tr><th colspan="2">PRICE</th></tr> </thead> <tbody> <tr><td>1-24</td><td>\$18.80</td></tr> <tr><td>25-49</td><td>\$17.86</td></tr> <tr><td>50-99</td><td>\$16.92</td></tr> <tr><td>100+</td><td>\$16.17</td></tr> </tbody> </table> <p>Snap-On MMBX Plug to Slide-On MMBX Plug</p> <p>VSWR 1.25:1 to 12.4 GHz</p> <p>Model No: <a href="#">PE91372</a></p>	PRICE		1-24	\$18.80	25-49	\$17.86	50-99	\$16.92	100+	\$16.17										
	PRICE																																																						
1-24	\$115.37																																																						
25-49	\$109.60																																																						
50-99	\$103.83																																																						
100+	\$99.22																																																						
PRICE																																																							
1-24	\$9.87																																																						
25-49	\$9.38																																																						
50-99	\$8.88																																																						
100+	\$8.49																																																						
PRICE																																																							
1-24	\$14.80																																																						
25-49	\$14.06																																																						
50-99	\$13.32																																																						
100+	\$12.73																																																						
PRICE																																																							
1-24	\$18.80																																																						
25-49	\$17.86																																																						
50-99	\$16.92																																																						
100+	\$16.17																																																						
5	 <table border="1"> <thead> <tr><th colspan="2">PRICE</th></tr> </thead> <tbody> <tr><td>1-24</td><td>\$13.65</td></tr> <tr><td>25-49</td><td>\$12.97</td></tr> <tr><td>50-99</td><td>\$12.29</td></tr> <tr><td>100+</td><td>\$11.74</td></tr> </tbody> </table> <p>Slide-On MMBX Plug to Snap-On MMBX Plug</p> <p>VSWR 1.08:1 to 12.4 GHz</p> <p>Model No: <a href="#">PE91373</a></p>	PRICE		1-24	\$13.65	25-49	\$12.97	50-99	\$12.29	100+	\$11.74	<p><b>N In-Series</b></p> <p>→</p>	 <table border="1"> <thead> <tr><th colspan="2">PRICE</th></tr> </thead> <tbody> <tr><td>1-24</td><td>\$64.05</td></tr> <tr><td>25-49</td><td>\$60.85</td></tr> <tr><td>50-99</td><td>\$57.65</td></tr> <tr><td>100+</td><td>\$55.08</td></tr> </tbody> </table> <p>N Male to N Male</p> <p>VSWR 1.2:1 to 6 GHz</p> <p>Model No: <a href="#">PE91198</a></p>	PRICE		1-24	\$64.05	25-49	\$60.85	50-99	\$57.65	100+	\$55.08	 <table border="1"> <thead> <tr><th colspan="2">PRICE</th></tr> </thead> <tbody> <tr><td>1-24</td><td>\$48.08</td></tr> <tr><td>25-49</td><td>\$45.68</td></tr> <tr><td>50-99</td><td>\$43.27</td></tr> <tr><td>100+</td><td>\$41.35</td></tr> </tbody> </table> <p>N Male to N Male</p> <p>VSWR 1.3:1 to 6 GHz</p> <p>Model No: <a href="#">PE91235</a></p>	PRICE		1-24	\$48.08	25-49	\$45.68	50-99	\$43.27	100+	\$41.35	 <table border="1"> <thead> <tr><th colspan="2">PRICE</th></tr> </thead> <tbody> <tr><td>1-24</td><td>\$22.50</td></tr> <tr><td>25-49</td><td>\$21.38</td></tr> <tr><td>50-99</td><td>\$20.25</td></tr> <tr><td>100+</td><td>\$19.35</td></tr> </tbody> </table> <p>N Male to N Male</p> <p>VSWR 1.3:1 to 6 GHz</p> <p>Model No: <a href="#">PE9007</a></p>	PRICE		1-24	\$22.50	25-49	\$21.38	50-99	\$20.25	100+	\$19.35										
	PRICE																																																						
1-24	\$13.65																																																						
25-49	\$12.97																																																						
50-99	\$12.29																																																						
100+	\$11.74																																																						
PRICE																																																							
1-24	\$64.05																																																						
25-49	\$60.85																																																						
50-99	\$57.65																																																						
100+	\$55.08																																																						
PRICE																																																							
1-24	\$48.08																																																						
25-49	\$45.68																																																						
50-99	\$43.27																																																						
100+	\$41.35																																																						
PRICE																																																							
1-24	\$22.50																																																						
25-49	\$21.38																																																						
50-99	\$20.25																																																						
100+	\$19.35																																																						
6	 <table border="1"> <thead> <tr><th colspan="2">PRICE</th></tr> </thead> <tbody> <tr><td>1-24</td><td>\$103.84</td></tr> <tr><td>25-49</td><td>\$98.65</td></tr> <tr><td>50-99</td><td>\$93.46</td></tr> <tr><td>100+</td><td>\$89.30</td></tr> </tbody> </table> <p>Low PIM</p> <p>N Male to N Male</p> <p>Max. Freq. 12.4 GHz</p> <p>Model No: <a href="#">PE91034</a></p>	PRICE		1-24	\$103.84	25-49	\$98.65	50-99	\$93.46	100+	\$89.30	 <table border="1"> <thead> <tr><th colspan="2">PRICE</th></tr> </thead> <tbody> <tr><td>1-24</td><td>\$91.66</td></tr> <tr><td>25-49</td><td>\$87.08</td></tr> <tr><td>50-99</td><td>\$82.49</td></tr> <tr><td>100+</td><td>\$78.83</td></tr> </tbody> </table> <p>PRECISION NEW</p> <p>N Male to N Male</p> <p>VSWR 1.15:1 to 18 GHz</p> <p>Model No: <a href="#">PE91532</a></p>	PRICE		1-24	\$91.66	25-49	\$87.08	50-99	\$82.49	100+	\$78.83	 <table border="1"> <thead> <tr><th colspan="2">PRICE</th></tr> </thead> <tbody> <tr><td>1-24</td><td>\$44.34</td></tr> <tr><td>25-49</td><td>\$42.12</td></tr> <tr><td>50-99</td><td>\$39.91</td></tr> <tr><td>100+</td><td>\$38.13</td></tr> </tbody> </table> <p>N Male to N Male Right Angle</p> <p>VSWR 1.5:1 to 11 GHz</p> <p>Model No: <a href="#">PE9198</a></p>	PRICE		1-24	\$44.34	25-49	\$42.12	50-99	\$39.91	100+	\$38.13	 <table border="1"> <thead> <tr><th colspan="2">PRICE</th></tr> </thead> <tbody> <tr><td>1-24</td><td>\$104.20</td></tr> <tr><td>25-49</td><td>\$98.99</td></tr> <tr><td>50-99</td><td>\$93.78</td></tr> <tr><td>100+</td><td>\$89.61</td></tr> </tbody> </table> <p>N Male to N Male Tee</p> <p>Model No: <a href="#">PE9390</a></p>	PRICE		1-24	\$104.20	25-49	\$98.99	50-99	\$93.78	100+	\$89.61	 <table border="1"> <thead> <tr><th colspan="2">PRICE</th></tr> </thead> <tbody> <tr><td>1-24</td><td>\$64.05</td></tr> <tr><td>25-49</td><td>\$60.85</td></tr> <tr><td>50-99</td><td>\$57.65</td></tr> <tr><td>100+</td><td>\$55.08</td></tr> </tbody> </table> <p>N Male to N Female</p> <p>VSWR 1.2:1 to 6 GHz</p> <p>Model No: <a href="#">PE91199</a></p>	PRICE		1-24	\$64.05	25-49	\$60.85	50-99	\$57.65	100+	\$55.08
	PRICE																																																						
1-24	\$103.84																																																						
25-49	\$98.65																																																						
50-99	\$93.46																																																						
100+	\$89.30																																																						
PRICE																																																							
1-24	\$91.66																																																						
25-49	\$87.08																																																						
50-99	\$82.49																																																						
100+	\$78.83																																																						
PRICE																																																							
1-24	\$44.34																																																						
25-49	\$42.12																																																						
50-99	\$39.91																																																						
100+	\$38.13																																																						
PRICE																																																							
1-24	\$104.20																																																						
25-49	\$98.99																																																						
50-99	\$93.78																																																						
100+	\$89.61																																																						
PRICE																																																							
1-24	\$64.05																																																						
25-49	\$60.85																																																						
50-99	\$57.65																																																						
100+	\$55.08																																																						
7	 <table border="1"> <thead> <tr><th colspan="2">PRICE</th></tr> </thead> <tbody> <tr><td>1-24</td><td>\$46.37</td></tr> <tr><td>25-49</td><td>\$44.05</td></tr> <tr><td>50-99</td><td>\$41.73</td></tr> <tr><td>100+</td><td>\$39.88</td></tr> </tbody> </table> <p>N Male to N Female</p> <p>VSWR 1.3:1 to 6 GHz</p> <p>Model No: <a href="#">PE91236</a></p>	PRICE		1-24	\$46.37	25-49	\$44.05	50-99	\$41.73	100+	\$39.88	 <table border="1"> <thead> <tr><th colspan="2">PRICE</th></tr> </thead> <tbody> <tr><td>1-24</td><td>\$106.63</td></tr> <tr><td>25-49</td><td>\$101.30</td></tr> <tr><td>50-99</td><td>\$95.97</td></tr> <tr><td>100+</td><td>\$91.70</td></tr> </tbody> </table> <p>Low PIM</p> <p>N Male to N Female</p> <p>Max. Freq. 12.4 GHz</p> <p>Model No: <a href="#">PE91040</a></p>	PRICE		1-24	\$106.63	25-49	\$101.30	50-99	\$95.97	100+	\$91.70	 <table border="1"> <thead> <tr><th colspan="2">PRICE</th></tr> </thead> <tbody> <tr><td>1-24</td><td>\$39.04</td></tr> <tr><td>25-49</td><td>\$37.09</td></tr> <tr><td>50-99</td><td>\$35.14</td></tr> <tr><td>100+</td><td>\$33.57</td></tr> </tbody> </table> <p>Push-On N Male to N Female</p> <p>VSWR 1.22:1 to 18 GHz</p> <p>Model No: <a href="#">PE91114</a></p>	PRICE		1-24	\$39.04	25-49	\$37.09	50-99	\$35.14	100+	\$33.57	 <table border="1"> <thead> <tr><th colspan="2">PRICE</th></tr> </thead> <tbody> <tr><td>1-9</td><td>\$90.18</td></tr> <tr><td>10-24</td><td>\$85.67</td></tr> <tr><td>25-49</td><td>\$81.16</td></tr> <tr><td>50+</td><td>\$77.55</td></tr> </tbody> </table> <p>PRECISION NEW</p> <p>N Male to N Female</p> <p>VSWR 1.15:1 to 18 GHz</p> <p>Model No: <a href="#">PE91531</a></p>	PRICE		1-9	\$90.18	10-24	\$85.67	25-49	\$81.16	50+	\$77.55	 <table border="1"> <thead> <tr><th colspan="2">PRICE</th></tr> </thead> <tbody> <tr><td>1-24</td><td>\$33.58</td></tr> <tr><td>25-49</td><td>\$31.90</td></tr> <tr><td>50-99</td><td>\$30.22</td></tr> <tr><td>100+</td><td>\$28.88</td></tr> </tbody> </table> <p>N Male to N Female</p> <p>VSWR 1.3:1 to 11 GHz</p> <p>Model No: <a href="#">PE9311</a></p>	PRICE		1-24	\$33.58	25-49	\$31.90	50-99	\$30.22	100+	\$28.88
	PRICE																																																						
1-24	\$46.37																																																						
25-49	\$44.05																																																						
50-99	\$41.73																																																						
100+	\$39.88																																																						
PRICE																																																							
1-24	\$106.63																																																						
25-49	\$101.30																																																						
50-99	\$95.97																																																						
100+	\$91.70																																																						
PRICE																																																							
1-24	\$39.04																																																						
25-49	\$37.09																																																						
50-99	\$35.14																																																						
100+	\$33.57																																																						
PRICE																																																							
1-9	\$90.18																																																						
10-24	\$85.67																																																						
25-49	\$81.16																																																						
50+	\$77.55																																																						
PRICE																																																							
1-24	\$33.58																																																						
25-49	\$31.90																																																						
50-99	\$30.22																																																						
100+	\$28.88																																																						



Technical Support  
+1 (949) 261-1920



Same-Day Shipping,  
Even Custom Cable Assemblies

# ADAPTERS

See Adapter Locator on Pages 10-15

See Page 409 for Mounting Holes

Adapters

See Our Website For Current Pricing & Real-Time Stock Availability!

	A	B	C	D	E																																																		
1	 <table border="1"> <thead> <tr> <th colspan="2">PRICE</th> </tr> </thead> <tbody> <tr> <td>1-24</td> <td>\$60.84</td> </tr> <tr> <td>25-49</td> <td>\$57.80</td> </tr> <tr> <td>50-99</td> <td>\$54.76</td> </tr> <tr> <td>100+</td> <td>\$52.32</td> </tr> </tbody> </table> <p><b>N Male to 75 Ohm N Female</b></p> <p>Model No: <a href="#">PE9349</a></p>	PRICE		1-24	\$60.84	25-49	\$57.80	50-99	\$54.76	100+	\$52.32	 <table border="1"> <thead> <tr> <th colspan="2">PRICE</th> </tr> </thead> <tbody> <tr> <td>1-9</td> <td>\$194.68</td> </tr> <tr> <td>10-24</td> <td>\$184.95</td> </tr> <tr> <td>25-49</td> <td>\$175.21</td> </tr> <tr> <td>50+</td> <td>\$167.42</td> </tr> </tbody> </table> <p><b>QD N Male to N Female</b></p> <p>Model No: <a href="#">PE9547</a></p>	PRICE		1-9	\$194.68	10-24	\$184.95	25-49	\$175.21	50+	\$167.42	 <table border="1"> <thead> <tr> <th colspan="2">PRICE</th> </tr> </thead> <tbody> <tr> <td>1-9</td> <td>\$316.24</td> </tr> <tr> <td>10-24</td> <td>\$303.59</td> </tr> <tr> <td>25-49</td> <td>\$294.10</td> </tr> <tr> <td>50+</td> <td>\$287.78</td> </tr> </tbody> </table> <p><b>N Male to N Female Radius Right Angle</b> VSWR 1.25:1 to 18 GHz</p> <p>Model No: <a href="#">PE91350</a></p>	PRICE		1-9	\$316.24	10-24	\$303.59	25-49	\$294.10	50+	\$287.78	 <table border="1"> <thead> <tr> <th colspan="2">PRICE</th> </tr> </thead> <tbody> <tr> <td>1-24</td> <td>\$24.79</td> </tr> <tr> <td>25-49</td> <td>\$23.55</td> </tr> <tr> <td>50-99</td> <td>\$22.31</td> </tr> <tr> <td>100+</td> <td>\$21.32</td> </tr> </tbody> </table> <p><b>N Male to N Female Right Angle</b> VSWR 1.3:1 to 11 GHz</p> <p>Model No: <a href="#">PE9086</a></p>	PRICE		1-24	\$24.79	25-49	\$23.55	50-99	\$22.31	100+	\$21.32	 <table border="1"> <thead> <tr> <th colspan="2">PRICE</th> </tr> </thead> <tbody> <tr> <td>1-24</td> <td>\$106.88</td> </tr> <tr> <td>25-49</td> <td>\$101.54</td> </tr> <tr> <td>50-99</td> <td>\$96.19</td> </tr> <tr> <td>100+</td> <td>\$91.92</td> </tr> </tbody> </table> <p><b>N Male to N Female Tee</b></p> <p>Model No: <a href="#">PE9481</a></p>	PRICE		1-24	\$106.88	25-49	\$101.54	50-99	\$96.19	100+	\$91.92
PRICE																																																							
1-24	\$60.84																																																						
25-49	\$57.80																																																						
50-99	\$54.76																																																						
100+	\$52.32																																																						
PRICE																																																							
1-9	\$194.68																																																						
10-24	\$184.95																																																						
25-49	\$175.21																																																						
50+	\$167.42																																																						
PRICE																																																							
1-9	\$316.24																																																						
10-24	\$303.59																																																						
25-49	\$294.10																																																						
50+	\$287.78																																																						
PRICE																																																							
1-24	\$24.79																																																						
25-49	\$23.55																																																						
50-99	\$22.31																																																						
100+	\$21.32																																																						
PRICE																																																							
1-24	\$106.88																																																						
25-49	\$101.54																																																						
50-99	\$96.19																																																						
100+	\$91.92																																																						
2	 <table border="1"> <thead> <tr> <th colspan="2">PRICE</th> </tr> </thead> <tbody> <tr> <td>1-24</td> <td>\$44.95</td> </tr> <tr> <td>25-49</td> <td>\$42.70</td> </tr> <tr> <td>50-99</td> <td>\$40.46</td> </tr> <tr> <td>100+</td> <td>\$38.66</td> </tr> </tbody> </table> <p><b>N Male to N Female Bulkhead</b> VSWR 1.3:1 to 11 GHz</p> <p>Model No: <a href="#">PE9595</a></p>	PRICE		1-24	\$44.95	25-49	\$42.70	50-99	\$40.46	100+	\$38.66	 <table border="1"> <thead> <tr> <th colspan="2">PRICE</th> </tr> </thead> <tbody> <tr> <td>1-24</td> <td>\$52.64</td> </tr> <tr> <td>25-49</td> <td>\$50.01</td> </tr> <tr> <td>50-99</td> <td>\$47.38</td> </tr> <tr> <td>100+</td> <td>\$45.27</td> </tr> </tbody> </table> <p><b>N Female to 75 Ohm N Male</b> Max. Freq. 500 MHz</p> <p>Model No: <a href="#">PE9350</a></p>	PRICE		1-24	\$52.64	25-49	\$50.01	50-99	\$47.38	100+	\$45.27	 <table border="1"> <thead> <tr> <th colspan="2">PRICE</th> </tr> </thead> <tbody> <tr> <td>1-24</td> <td>\$58.63</td> </tr> <tr> <td>25-49</td> <td>\$55.70</td> </tr> <tr> <td>50-99</td> <td>\$52.77</td> </tr> <tr> <td>100+</td> <td>\$50.42</td> </tr> </tbody> </table> <p><b>N Female to N Male Tee</b> Max. Freq. 11 GHz</p> <p>Model No: <a href="#">PE9102</a></p>	PRICE		1-24	\$58.63	25-49	\$55.70	50-99	\$52.77	100+	\$50.42	 <table border="1"> <thead> <tr> <th colspan="2">PRICE</th> </tr> </thead> <tbody> <tr> <td>1-24</td> <td>\$73.90</td> </tr> <tr> <td>25-49</td> <td>\$70.21</td> </tr> <tr> <td>50-99</td> <td>\$66.51</td> </tr> <tr> <td>100+</td> <td>\$63.55</td> </tr> </tbody> </table> <p><b>N Female to N Female</b> VSWR 1.2:1 to 6 GHz</p> <p>Model No: <a href="#">PE91200</a></p>	PRICE		1-24	\$73.90	25-49	\$70.21	50-99	\$66.51	100+	\$63.55	 <table border="1"> <thead> <tr> <th colspan="2">PRICE</th> </tr> </thead> <tbody> <tr> <td>1-24</td> <td>\$41.65</td> </tr> <tr> <td>25-49</td> <td>\$39.57</td> </tr> <tr> <td>50-99</td> <td>\$37.49</td> </tr> <tr> <td>100+</td> <td>\$35.82</td> </tr> </tbody> </table> <p><b>N Female to N Female</b> VSWR 1.3:1 to 6 GHz</p> <p>Model No: <a href="#">PE91237</a></p>	PRICE		1-24	\$41.65	25-49	\$39.57	50-99	\$37.49	100+	\$35.82
PRICE																																																							
1-24	\$44.95																																																						
25-49	\$42.70																																																						
50-99	\$40.46																																																						
100+	\$38.66																																																						
PRICE																																																							
1-24	\$52.64																																																						
25-49	\$50.01																																																						
50-99	\$47.38																																																						
100+	\$45.27																																																						
PRICE																																																							
1-24	\$58.63																																																						
25-49	\$55.70																																																						
50-99	\$52.77																																																						
100+	\$50.42																																																						
PRICE																																																							
1-24	\$73.90																																																						
25-49	\$70.21																																																						
50-99	\$66.51																																																						
100+	\$63.55																																																						
PRICE																																																							
1-24	\$41.65																																																						
25-49	\$39.57																																																						
50-99	\$37.49																																																						
100+	\$35.82																																																						
3	 <table border="1"> <thead> <tr> <th colspan="2">PRICE</th> </tr> </thead> <tbody> <tr> <td>1-24</td> <td>\$20.00</td> </tr> <tr> <td>25-49</td> <td>\$19.00</td> </tr> <tr> <td>50-99</td> <td>\$18.00</td> </tr> <tr> <td>100+</td> <td>\$17.20</td> </tr> </tbody> </table> <p><b>N Female to N Female</b> VSWR 1.3:1 to 11 GHz</p> <p>Model No: <a href="#">PE9006</a></p>	PRICE		1-24	\$20.00	25-49	\$19.00	50-99	\$18.00	100+	\$17.20	 <table border="1"> <thead> <tr> <th colspan="2">PRICE</th> </tr> </thead> <tbody> <tr> <td>1-24</td> <td>\$78.39</td> </tr> <tr> <td>25-49</td> <td>\$74.47</td> </tr> <tr> <td>50-99</td> <td>\$70.55</td> </tr> <tr> <td>100+</td> <td>\$67.42</td> </tr> </tbody> </table> <p><b>N Female to N Female</b> VSWR 1.2:1 to 6 GHz</p> <p>Model No: <a href="#">PE91140</a></p>	PRICE		1-24	\$78.39	25-49	\$74.47	50-99	\$70.55	100+	\$67.42	 <table border="1"> <thead> <tr> <th colspan="2">PRICE</th> </tr> </thead> <tbody> <tr> <td>1-24</td> <td>\$52.88</td> </tr> <tr> <td>25-49</td> <td>\$50.24</td> </tr> <tr> <td>50-99</td> <td>\$47.59</td> </tr> <tr> <td>100+</td> <td>\$45.48</td> </tr> </tbody> </table> <p><b>N Female to N Female</b> VSWR 1.2:1 to 18 GHz</p> <p>Model No: <a href="#">PE91141</a></p>	PRICE		1-24	\$52.88	25-49	\$50.24	50-99	\$47.59	100+	\$45.48	 <table border="1"> <thead> <tr> <th colspan="2">PRICE</th> </tr> </thead> <tbody> <tr> <td>1-9</td> <td>\$112.93</td> </tr> <tr> <td>10-24</td> <td>\$107.28</td> </tr> <tr> <td>25-49</td> <td>\$101.64</td> </tr> <tr> <td>50+</td> <td>\$97.12</td> </tr> </tbody> </table> <p><b>N Female to N Female</b> VSWR 1.15:1 to 18 GHz</p> <p>Model No: <a href="#">PE91530</a></p>	PRICE		1-9	\$112.93	10-24	\$107.28	25-49	\$101.64	50+	\$97.12	 <table border="1"> <thead> <tr> <th colspan="2">PRICE</th> </tr> </thead> <tbody> <tr> <td>1-24</td> <td>\$58.69</td> </tr> <tr> <td>25-49</td> <td>\$55.76</td> </tr> <tr> <td>50-99</td> <td>\$52.82</td> </tr> <tr> <td>100+</td> <td>\$50.47</td> </tr> </tbody> </table> <p><b>N Female to N Female Right Angle</b></p> <p>Model No: <a href="#">PE9359</a></p>	PRICE		1-24	\$58.69	25-49	\$55.76	50-99	\$52.82	100+	\$50.47
PRICE																																																							
1-24	\$20.00																																																						
25-49	\$19.00																																																						
50-99	\$18.00																																																						
100+	\$17.20																																																						
PRICE																																																							
1-24	\$78.39																																																						
25-49	\$74.47																																																						
50-99	\$70.55																																																						
100+	\$67.42																																																						
PRICE																																																							
1-24	\$52.88																																																						
25-49	\$50.24																																																						
50-99	\$47.59																																																						
100+	\$45.48																																																						
PRICE																																																							
1-9	\$112.93																																																						
10-24	\$107.28																																																						
25-49	\$101.64																																																						
50+	\$97.12																																																						
PRICE																																																							
1-24	\$58.69																																																						
25-49	\$55.76																																																						
50-99	\$52.82																																																						
100+	\$50.47																																																						
4	 <table border="1"> <thead> <tr> <th colspan="2">PRICE</th> </tr> </thead> <tbody> <tr> <td>1-24</td> <td>\$39.44</td> </tr> <tr> <td>25-49</td> <td>\$37.47</td> </tr> <tr> <td>50-99</td> <td>\$35.50</td> </tr> <tr> <td>100+</td> <td>\$33.92</td> </tr> </tbody> </table> <p><b>N Female to N Female Tee</b> VSWR 2:1 to 100 MHz</p> <p>Model No: <a href="#">PE9101</a></p>	PRICE		1-24	\$39.44	25-49	\$37.47	50-99	\$35.50	100+	\$33.92	 <table border="1"> <thead> <tr> <th colspan="2">PRICE</th> </tr> </thead> <tbody> <tr> <td>1-24</td> <td>\$108.90</td> </tr> <tr> <td>25-49</td> <td>\$103.46</td> </tr> <tr> <td>50-99</td> <td>\$98.01</td> </tr> <tr> <td>100+</td> <td>\$93.65</td> </tr> </tbody> </table> <p><b>N Female to N Female Cross</b></p> <p>Model No: <a href="#">PE9548</a></p>	PRICE		1-24	\$108.90	25-49	\$103.46	50-99	\$98.01	100+	\$93.65	 <table border="1"> <thead> <tr> <th colspan="2">PRICE</th> </tr> </thead> <tbody> <tr> <td>1-24</td> <td>\$31.98</td> </tr> <tr> <td>25-49</td> <td>\$30.38</td> </tr> <tr> <td>50-99</td> <td>\$28.78</td> </tr> <tr> <td>100+</td> <td>\$27.50</td> </tr> </tbody> </table> <p><b>N Female to N Female Bulkhead</b> VSWR 1.4:1 to 3 GHz</p> <p>Model No: <a href="#">PE9128</a></p>	PRICE		1-24	\$31.98	25-49	\$30.38	50-99	\$28.78	100+	\$27.50	 <table border="1"> <thead> <tr> <th colspan="2">PRICE</th> </tr> </thead> <tbody> <tr> <td>1-24</td> <td>\$81.11</td> </tr> <tr> <td>25-49</td> <td>\$77.05</td> </tr> <tr> <td>50-99</td> <td>\$73.00</td> </tr> <tr> <td>100+</td> <td>\$69.75</td> </tr> </tbody> </table> <p><b>N Female to N Female Bulkhead</b> Max. Freq. 11 GHz</p> <p>Model No: <a href="#">PE9383</a></p>	PRICE		1-24	\$81.11	25-49	\$77.05	50-99	\$73.00	100+	\$69.75	 <table border="1"> <thead> <tr> <th colspan="2">PRICE</th> </tr> </thead> <tbody> <tr> <td>1-24</td> <td>\$86.83</td> </tr> <tr> <td>25-49</td> <td>\$82.49</td> </tr> <tr> <td>50-99</td> <td>\$78.15</td> </tr> <tr> <td>100+</td> <td>\$74.67</td> </tr> </tbody> </table> <p><b>N Female to N Female Right Angle Bulkhead-Mounting Hole G01</b> Max. Freq. 6 GHz</p> <p>Model No: <a href="#">PE9541</a></p>	PRICE		1-24	\$86.83	25-49	\$82.49	50-99	\$78.15	100+	\$74.67
PRICE																																																							
1-24	\$39.44																																																						
25-49	\$37.47																																																						
50-99	\$35.50																																																						
100+	\$33.92																																																						
PRICE																																																							
1-24	\$108.90																																																						
25-49	\$103.46																																																						
50-99	\$98.01																																																						
100+	\$93.65																																																						
PRICE																																																							
1-24	\$31.98																																																						
25-49	\$30.38																																																						
50-99	\$28.78																																																						
100+	\$27.50																																																						
PRICE																																																							
1-24	\$81.11																																																						
25-49	\$77.05																																																						
50-99	\$73.00																																																						
100+	\$69.75																																																						
PRICE																																																							
1-24	\$86.83																																																						
25-49	\$82.49																																																						
50-99	\$78.15																																																						
100+	\$74.67																																																						
5	 <table border="1"> <thead> <tr> <th colspan="2">PRICE</th> </tr> </thead> <tbody> <tr> <td>1-24</td> <td>\$35.39</td> </tr> <tr> <td>25-49</td> <td>\$33.62</td> </tr> <tr> <td>50-99</td> <td>\$31.85</td> </tr> <tr> <td>100+</td> <td>\$30.44</td> </tr> </tbody> </table> <p><b>N Female to N Female 4 Hole Flange-Mounting Hole A05</b> VSWR 1.5:1 to 11 GHz</p> <p>Model No: <a href="#">PE9173</a></p>	PRICE		1-24	\$35.39	25-49	\$33.62	50-99	\$31.85	100+	\$30.44	 <table border="1"> <thead> <tr> <th colspan="2">PRICE</th> </tr> </thead> <tbody> <tr> <td>1-9</td> <td>\$149.73</td> </tr> <tr> <td>10-24</td> <td>\$142.24</td> </tr> <tr> <td>25-49</td> <td>\$134.76</td> </tr> <tr> <td>50+</td> <td>\$128.77</td> </tr> </tbody> </table> <p><b>N Female to N Female 4 Hole Flange-Mounting Hole A05</b> VSWR 1.15:1 to 18 GHz</p> <p>Model No: <a href="#">PE9429</a></p>	PRICE		1-9	\$149.73	10-24	\$142.24	25-49	\$134.76	50+	\$128.77	 <table border="1"> <thead> <tr> <th colspan="2">PRICE</th> </tr> </thead> <tbody> <tr> <td>1-24</td> <td>\$78.62</td> </tr> <tr> <td>25-49</td> <td>\$74.69</td> </tr> <tr> <td>50-99</td> <td>\$70.76</td> </tr> <tr> <td>100+</td> <td>\$67.61</td> </tr> </tbody> </table> <p><b>N Female to N Female Bulkhead</b> VSWR 1.2:1 to 6 GHz</p> <p>Model No: <a href="#">PE91201</a></p>	PRICE		1-24	\$78.62	25-49	\$74.69	50-99	\$70.76	100+	\$67.61	 <table border="1"> <thead> <tr> <th colspan="2">PRICE</th> </tr> </thead> <tbody> <tr> <td>1-24</td> <td>\$39.89</td> </tr> <tr> <td>25-49</td> <td>\$37.90</td> </tr> <tr> <td>50-99</td> <td>\$35.90</td> </tr> <tr> <td>100+</td> <td>\$34.31</td> </tr> </tbody> </table> <p><b>N Female to N Female Bulkhead</b> VSWR 1.3:1 to 6 GHz</p> <p>Model No: <a href="#">PE91238</a></p>	PRICE		1-24	\$39.89	25-49	\$37.90	50-99	\$35.90	100+	\$34.31	 <table border="1"> <thead> <tr> <th colspan="2">PRICE</th> </tr> </thead> <tbody> <tr> <td>1-24</td> <td>\$70.22</td> </tr> <tr> <td>25-49</td> <td>\$66.71</td> </tr> <tr> <td>50-99</td> <td>\$63.20</td> </tr> <tr> <td>100+</td> <td>\$60.39</td> </tr> </tbody> </table> <p><b>N Female to N Female Bulkhead</b> VSWR 1.2:1 to 6 GHz</p> <p>Model No: <a href="#">PE91179</a></p>	PRICE		1-24	\$70.22	25-49	\$66.71	50-99	\$63.20	100+	\$60.39
PRICE																																																							
1-24	\$35.39																																																						
25-49	\$33.62																																																						
50-99	\$31.85																																																						
100+	\$30.44																																																						
PRICE																																																							
1-9	\$149.73																																																						
10-24	\$142.24																																																						
25-49	\$134.76																																																						
50+	\$128.77																																																						
PRICE																																																							
1-24	\$78.62																																																						
25-49	\$74.69																																																						
50-99	\$70.76																																																						
100+	\$67.61																																																						
PRICE																																																							
1-24	\$39.89																																																						
25-49	\$37.90																																																						
50-99	\$35.90																																																						
100+	\$34.31																																																						
PRICE																																																							
1-24	\$70.22																																																						
25-49	\$66.71																																																						
50-99	\$63.20																																																						
100+	\$60.39																																																						
6	 <table border="1"> <thead> <tr> <th colspan="2">PRICE</th> </tr> </thead> <tbody> <tr> <td>1-9</td> <td>\$182.28</td> </tr> <tr> <td>10-24</td> <td>\$173.17</td> </tr> <tr> <td>25-49</td> <td>\$164.05</td> </tr> <tr> <td>50+</td> <td>\$156.76</td> </tr> </tbody> </table> <p><b>N Female to N Female Bulkhead</b> VSWR 1.15:1 to 18 GHz</p> <p>Model No: <a href="#">PE9500</a></p>	PRICE		1-9	\$182.28	10-24	\$173.17	25-49	\$164.05	50+	\$156.76	 <table border="1"> <thead> <tr> <th colspan="2">PRICE</th> </tr> </thead> <tbody> <tr> <td>1-24</td> <td>\$54.27</td> </tr> <tr> <td>25-49</td> <td>\$51.56</td> </tr> <tr> <td>50-99</td> <td>\$48.84</td> </tr> <tr> <td>100+</td> <td>\$46.67</td> </tr> </tbody> </table> <p><b>N Female to N Female Bulkhead</b> VSWR 1.5:1 to 11 GHz</p> <p>Model No: <a href="#">PE9382</a></p>	PRICE		1-24	\$54.27	25-49	\$51.56	50-99	\$48.84	100+	\$46.67	<p><b>Reverse Polarity N In-Series</b></p> <p>→</p>		 <table border="1"> <thead> <tr> <th colspan="2">PRICE</th> </tr> </thead> <tbody> <tr> <td>1-24</td> <td>\$47.74</td> </tr> <tr> <td>25-49</td> <td>\$45.35</td> </tr> <tr> <td>50-99</td> <td>\$42.97</td> </tr> <tr> <td>100+</td> <td>\$41.06</td> </tr> </tbody> </table> <p><b>N Male to Rev. Pol. N Female</b> Max. Freq. 11 GHz</p> <p>Model No: <a href="#">PE9771</a></p>	PRICE		1-24	\$47.74	25-49	\$45.35	50-99	\$42.97	100+	\$41.06	 <table border="1"> <thead> <tr> <th colspan="2">PRICE</th> </tr> </thead> <tbody> <tr> <td>1-24</td> <td>\$46.13</td> </tr> <tr> <td>25-49</td> <td>\$43.82</td> </tr> <tr> <td>50-99</td> <td>\$41.52</td> </tr> <tr> <td>100+</td> <td>\$39.67</td> </tr> </tbody> </table> <p><b>N Female to Rev. Pol. N Male</b> Max. Freq. 11 GHz</p> <p>Model No: <a href="#">PE9770</a></p>	PRICE		1-24	\$46.13	25-49	\$43.82	50-99	\$41.52	100+	\$39.67									
PRICE																																																							
1-9	\$182.28																																																						
10-24	\$173.17																																																						
25-49	\$164.05																																																						
50+	\$156.76																																																						
PRICE																																																							
1-24	\$54.27																																																						
25-49	\$51.56																																																						
50-99	\$48.84																																																						
100+	\$46.67																																																						
PRICE																																																							
1-24	\$47.74																																																						
25-49	\$45.35																																																						
50-99	\$42.97																																																						
100+	\$41.06																																																						
PRICE																																																							
1-24	\$46.13																																																						
25-49	\$43.82																																																						
50-99	\$41.52																																																						
100+	\$39.67																																																						
7	 <table border="1"> <thead> <tr> <th colspan="2">PRICE</th> </tr> </thead> <tbody> <tr> <td>1-24</td> <td>\$47.74</td> </tr> <tr> <td>25-49</td> <td>\$45.35</td> </tr> <tr> <td>50-99</td> <td>\$42.97</td> </tr> <tr> <td>100+</td> <td>\$41.06</td> </tr> </tbody> </table> <p><b>Rev. Pol. N Female to Rev. Pol. N Female</b> VSWR 1.3:1 to 11 GHz</p> <p>Model No: <a href="#">PE9773</a></p>	PRICE		1-24	\$47.74	25-49	\$45.35	50-99	\$42.97	100+	\$41.06	<p><b>N Between Series</b></p> <p>→</p>		 <table border="1"> <thead> <tr> <th colspan="2">PRICE</th> </tr> </thead> <tbody> <tr> <td>1-9</td> <td>\$340.94</td> </tr> <tr> <td>10-24</td> <td>\$323.89</td> </tr> <tr> <td>25-49</td> <td>\$306.85</td> </tr> <tr> <td>50+</td> <td>\$293.21</td> </tr> </tbody> </table> <p><b>N Male to 7mm Sexless</b> VSWR 1.12:1 to 18 GHz</p> <p>Model No: <a href="#">PE9217</a></p>	PRICE		1-9	\$340.94	10-24	\$323.89	25-49	\$306.85	50+	\$293.21	 <table border="1"> <thead> <tr> <th colspan="2">PRICE</th> </tr> </thead> <tbody> <tr> <td>1-24</td> <td>\$81.38</td> </tr> <tr> <td>25-49</td> <td>\$77.31</td> </tr> <tr> <td>50-99</td> <td>\$73.24</td> </tr> <tr> <td>100+</td> <td>\$69.99</td> </tr> </tbody> </table> <p><b>N Male to 4.3-10 Female</b> VSWR 1.08:1 to 6 GHz</p> <p>Model No: <a href="#">PE91388</a></p>	PRICE		1-24	\$81.38	25-49	\$77.31	50-99	\$73.24	100+	\$69.99	 <table border="1"> <thead> <tr> <th colspan="2">PRICE</th> </tr> </thead> <tbody> <tr> <td>1-24</td> <td>\$93.44</td> </tr> <tr> <td>25-49</td> <td>\$88.77</td> </tr> <tr> <td>50-99</td> <td>\$84.10</td> </tr> <tr> <td>100+</td> <td>\$80.36</td> </tr> </tbody> </table> <p><b>N Male to 7/16 DIN Male</b> Max. Freq. 8 GHz</p> <p>Model No: <a href="#">PE91030</a></p>	PRICE		1-24	\$93.44	25-49	\$88.77	50-99	\$84.10	100+	\$80.36									
PRICE																																																							
1-24	\$47.74																																																						
25-49	\$45.35																																																						
50-99	\$42.97																																																						
100+	\$41.06																																																						
PRICE																																																							
1-9	\$340.94																																																						
10-24	\$323.89																																																						
25-49	\$306.85																																																						
50+	\$293.21																																																						
PRICE																																																							
1-24	\$81.38																																																						
25-49	\$77.31																																																						
50-99	\$73.24																																																						
100+	\$69.99																																																						
PRICE																																																							
1-24	\$93.44																																																						
25-49	\$88.77																																																						
50-99	\$84.10																																																						
100+	\$80.36																																																						

# ADAPTERS

See Adapter Locator on Pages 10-15  
See Page 409 for Mounting Holes

	A	B	C	D	E																																													
1	 <table border="1"> <thead> <tr><th>PRICE</th></tr> </thead> <tbody> <tr><td>1-9</td><td>\$209.41</td></tr> <tr><td>10-24</td><td>\$198.94</td></tr> <tr><td>25-49</td><td>\$188.47</td></tr> <tr><td>50+</td><td>\$180.09</td></tr> </tbody> </table> <p>N Male to 7/16 DIN Male</p> <p>Model No: <a href="#">PE9535</a></p>	PRICE	1-9	\$209.41	10-24	\$198.94	25-49	\$188.47	50+	\$180.09	 <table border="1"> <thead> <tr><th>PRICE</th></tr> </thead> <tbody> <tr><td>1-24</td><td>\$115.11</td></tr> <tr><td>25-49</td><td>\$109.35</td></tr> <tr><td>50-99</td><td>\$103.60</td></tr> <tr><td>100+</td><td>\$98.99</td></tr> </tbody> </table> <p>Low PIM N Male to 7/16 DIN Female</p> <p>Max. Freq. 8 GHz</p> <p>Model No: <a href="#">PE91032</a></p>	PRICE	1-24	\$115.11	25-49	\$109.35	50-99	\$103.60	100+	\$98.99	 <table border="1"> <thead> <tr><th>PRICE</th></tr> </thead> <tbody> <tr><td>1-24</td><td>\$95.98</td></tr> <tr><td>25-49</td><td>\$91.18</td></tr> <tr><td>50-99</td><td>\$86.38</td></tr> <tr><td>100+</td><td>\$82.54</td></tr> </tbody> </table> <p>N Male to 7/16 DIN Female</p> <p>VSWR 1.15:1 to 6 GHz</p> <p>Model No: <a href="#">PE91134</a></p>	PRICE	1-24	\$95.98	25-49	\$91.18	50-99	\$86.38	100+	\$82.54	 <table border="1"> <thead> <tr><th>PRICE</th></tr> </thead> <tbody> <tr><td>1-24</td><td>\$49.46</td></tr> <tr><td>25-49</td><td>\$46.99</td></tr> <tr><td>50-99</td><td>\$44.51</td></tr> <tr><td>100+</td><td>\$42.54</td></tr> </tbody> </table> <p>N Male to BNC Male</p> <p>VSWR 1.3:1 to 4 GHz</p> <p>Model No: <a href="#">PE9127</a></p>	PRICE	1-24	\$49.46	25-49	\$46.99	50-99	\$44.51	100+	\$42.54	 <table border="1"> <thead> <tr><th>PRICE</th></tr> </thead> <tbody> <tr><td>1-9</td><td>\$192.88</td></tr> <tr><td>10-24</td><td>\$183.24</td></tr> <tr><td>25-49</td><td>\$173.59</td></tr> <tr><td>50+</td><td>\$165.88</td></tr> </tbody> </table> <p>PRECISION N Male to BNC Male</p> <p>VSWR 1.2:1 to 8 GHz</p> <p>Model No: <a href="#">PE9489</a></p>	PRICE	1-9	\$192.88	10-24	\$183.24	25-49	\$173.59	50+	\$165.88
	PRICE																																																	
1-9	\$209.41																																																	
10-24	\$198.94																																																	
25-49	\$188.47																																																	
50+	\$180.09																																																	
PRICE																																																		
1-24	\$115.11																																																	
25-49	\$109.35																																																	
50-99	\$103.60																																																	
100+	\$98.99																																																	
PRICE																																																		
1-24	\$95.98																																																	
25-49	\$91.18																																																	
50-99	\$86.38																																																	
100+	\$82.54																																																	
PRICE																																																		
1-24	\$49.46																																																	
25-49	\$46.99																																																	
50-99	\$44.51																																																	
100+	\$42.54																																																	
PRICE																																																		
1-9	\$192.88																																																	
10-24	\$183.24																																																	
25-49	\$173.59																																																	
50+	\$165.88																																																	
2	 <table border="1"> <thead> <tr><th>PRICE</th></tr> </thead> <tbody> <tr><td>1-24</td><td>\$112.51</td></tr> <tr><td>25-49</td><td>\$106.88</td></tr> <tr><td>50-99</td><td>\$101.26</td></tr> <tr><td>100+</td><td>\$96.76</td></tr> </tbody> </table> <p>N Male to BNC Male Right Angle</p> <p>Model No: <a href="#">PE9565</a></p>	PRICE	1-24	\$112.51	25-49	\$106.88	50-99	\$101.26	100+	\$96.76	 <table border="1"> <thead> <tr><th>PRICE</th></tr> </thead> <tbody> <tr><td>1-24</td><td>\$23.25</td></tr> <tr><td>25-49</td><td>\$22.09</td></tr> <tr><td>50-99</td><td>\$20.93</td></tr> <tr><td>100+</td><td>\$20.00</td></tr> </tbody> </table> <p>N Male to BNC Female</p> <p>VSWR 1.3:1 to 2 GHz</p> <p>Model No: <a href="#">PE9002</a></p>	PRICE	1-24	\$23.25	25-49	\$22.09	50-99	\$20.93	100+	\$20.00	 <table border="1"> <thead> <tr><th>PRICE</th></tr> </thead> <tbody> <tr><td>1-9</td><td>\$151.49</td></tr> <tr><td>10-24</td><td>\$143.92</td></tr> <tr><td>25-49</td><td>\$136.34</td></tr> <tr><td>50+</td><td>\$130.28</td></tr> </tbody> </table> <p>PRECISION N Male to BNC Female</p> <p>VSWR 1.2:1 to 8 GHz</p> <p>Model No: <a href="#">PE9491</a></p>	PRICE	1-9	\$151.49	10-24	\$143.92	25-49	\$136.34	50+	\$130.28	 <table border="1"> <thead> <tr><th>PRICE</th></tr> </thead> <tbody> <tr><td>1-24</td><td>\$91.48</td></tr> <tr><td>25-49</td><td>\$86.91</td></tr> <tr><td>50-99</td><td>\$82.33</td></tr> <tr><td>100+</td><td>\$78.67</td></tr> </tbody> </table> <p>N Male to BNC Female Right Angle</p> <p>VSWR 1.2:1 to 4 GHz</p> <p>Model No: <a href="#">PE9278</a></p>	PRICE	1-24	\$91.48	25-49	\$86.91	50-99	\$82.33	100+	\$78.67	 <table border="1"> <thead> <tr><th>PRICE</th></tr> </thead> <tbody> <tr><td>1-24</td><td>\$69.19</td></tr> <tr><td>25-49</td><td>\$65.73</td></tr> <tr><td>50-99</td><td>\$62.27</td></tr> <tr><td>100+</td><td>\$59.50</td></tr> </tbody> </table> <p>N Male to BNC Female 4 Hole Flange</p> <p>Max. Freq. 4 GHz</p> <p>Model No: <a href="#">PE9388</a></p>	PRICE	1-24	\$69.19	25-49	\$65.73	50-99	\$62.27	100+	\$59.50
	PRICE																																																	
1-24	\$112.51																																																	
25-49	\$106.88																																																	
50-99	\$101.26																																																	
100+	\$96.76																																																	
PRICE																																																		
1-24	\$23.25																																																	
25-49	\$22.09																																																	
50-99	\$20.93																																																	
100+	\$20.00																																																	
PRICE																																																		
1-9	\$151.49																																																	
10-24	\$143.92																																																	
25-49	\$136.34																																																	
50+	\$130.28																																																	
PRICE																																																		
1-24	\$91.48																																																	
25-49	\$86.91																																																	
50-99	\$82.33																																																	
100+	\$78.67																																																	
PRICE																																																		
1-24	\$69.19																																																	
25-49	\$65.73																																																	
50-99	\$62.27																																																	
100+	\$59.50																																																	
3	 <table border="1"> <thead> <tr><th>PRICE</th></tr> </thead> <tbody> <tr><td>1-24</td><td>\$108.46</td></tr> <tr><td>25-49</td><td>\$103.04</td></tr> <tr><td>50-99</td><td>\$97.61</td></tr> <tr><td>100+</td><td>\$93.28</td></tr> </tbody> </table> <p>N Male to C Male</p> <p>Model No: <a href="#">PE9538</a></p>	PRICE	1-24	\$108.46	25-49	\$103.04	50-99	\$97.61	100+	\$93.28	 <table border="1"> <thead> <tr><th>PRICE</th></tr> </thead> <tbody> <tr><td>1-24</td><td>\$62.73</td></tr> <tr><td>25-49</td><td>\$59.59</td></tr> <tr><td>50-99</td><td>\$56.46</td></tr> <tr><td>100+</td><td>\$53.95</td></tr> </tbody> </table> <p>N Male to C Female</p> <p>Max. Freq. 11 GHz</p> <p>Model No: <a href="#">PE91446</a></p>	PRICE	1-24	\$62.73	25-49	\$59.59	50-99	\$56.46	100+	\$53.95	 <table border="1"> <thead> <tr><th>PRICE</th></tr> </thead> <tbody> <tr><td>1-24</td><td>\$113.52</td></tr> <tr><td>25-49</td><td>\$107.84</td></tr> <tr><td>50-99</td><td>\$102.17</td></tr> <tr><td>100+</td><td>\$97.63</td></tr> </tbody> </table> <p>N Male to C Female Right Angle</p> <p>Max. Freq. 4 GHz</p> <p>Model No: <a href="#">PE9239</a></p>	PRICE	1-24	\$113.52	25-49	\$107.84	50-99	\$102.17	100+	\$97.63	 <table border="1"> <thead> <tr><th>PRICE</th></tr> </thead> <tbody> <tr><td>1-24</td><td>\$36.20</td></tr> <tr><td>25-49</td><td>\$34.39</td></tr> <tr><td>50-99</td><td>\$32.58</td></tr> <tr><td>100+</td><td>\$31.13</td></tr> </tbody> </table> <p>N Male to 75 Ohm F Female</p> <p>VSWR 1.3:1 to 250 MHz</p> <p>Model No: <a href="#">PE9155</a></p>	PRICE	1-24	\$36.20	25-49	\$34.39	50-99	\$32.58	100+	\$31.13	 <table border="1"> <thead> <tr><th>PRICE</th></tr> </thead> <tbody> <tr><td>1-24</td><td>\$26.96</td></tr> <tr><td>25-49</td><td>\$25.61</td></tr> <tr><td>50-99</td><td>\$24.26</td></tr> <tr><td>100+</td><td>\$23.19</td></tr> </tbody> </table> <p>N Male to FME Plug</p> <p>Model No: <a href="#">PE9704</a></p>	PRICE	1-24	\$26.96	25-49	\$25.61	50-99	\$24.26	100+	\$23.19
	PRICE																																																	
1-24	\$108.46																																																	
25-49	\$103.04																																																	
50-99	\$97.61																																																	
100+	\$93.28																																																	
PRICE																																																		
1-24	\$62.73																																																	
25-49	\$59.59																																																	
50-99	\$56.46																																																	
100+	\$53.95																																																	
PRICE																																																		
1-24	\$113.52																																																	
25-49	\$107.84																																																	
50-99	\$102.17																																																	
100+	\$97.63																																																	
PRICE																																																		
1-24	\$36.20																																																	
25-49	\$34.39																																																	
50-99	\$32.58																																																	
100+	\$31.13																																																	
PRICE																																																		
1-24	\$26.96																																																	
25-49	\$25.61																																																	
50-99	\$24.26																																																	
100+	\$23.19																																																	
4	 <table border="1"> <thead> <tr><th>PRICE</th></tr> </thead> <tbody> <tr><td>1-9</td><td>\$197.50</td></tr> <tr><td>10-24</td><td>\$187.63</td></tr> <tr><td>25-49</td><td>\$177.75</td></tr> <tr><td>50+</td><td>\$169.85</td></tr> </tbody> </table> <p>N Male to GR874 Sexless</p> <p>Model No: <a href="#">PE9257</a></p>	PRICE	1-9	\$197.50	10-24	\$187.63	25-49	\$177.75	50+	\$169.85	 <table border="1"> <thead> <tr><th>PRICE</th></tr> </thead> <tbody> <tr><td>1-24</td><td>\$89.19</td></tr> <tr><td>25-49</td><td>\$84.73</td></tr> <tr><td>50-99</td><td>\$80.27</td></tr> <tr><td>100+</td><td>\$76.70</td></tr> </tbody> </table> <p>N Male to HN Male</p> <p>Model No: <a href="#">PE9554</a></p>	PRICE	1-24	\$89.19	25-49	\$84.73	50-99	\$80.27	100+	\$76.70	 <table border="1"> <thead> <tr><th>PRICE</th></tr> </thead> <tbody> <tr><td>1-24</td><td>\$57.19</td></tr> <tr><td>25-49</td><td>\$54.33</td></tr> <tr><td>50-99</td><td>\$51.47</td></tr> <tr><td>100+</td><td>\$49.18</td></tr> </tbody> </table> <p>N Male to HN Female</p> <p>VSWR 1.3:1 to 4 GHz</p> <p>Model No: <a href="#">PE9125</a></p>	PRICE	1-24	\$57.19	25-49	\$54.33	50-99	\$51.47	100+	\$49.18	 <table border="1"> <thead> <tr><th>PRICE</th></tr> </thead> <tbody> <tr><td>1-9</td><td>\$209.10</td></tr> <tr><td>10-24</td><td>\$198.65</td></tr> <tr><td>25-49</td><td>\$188.19</td></tr> <tr><td>50+</td><td>\$179.83</td></tr> </tbody> </table> <p>N Male to LC Female</p> <p>Model No: <a href="#">PE9299</a></p>	PRICE	1-9	\$209.10	10-24	\$198.65	25-49	\$188.19	50+	\$179.83	 <table border="1"> <thead> <tr><th>PRICE</th></tr> </thead> <tbody> <tr><td>1-24</td><td>\$96.60</td></tr> <tr><td>25-49</td><td>\$92.74</td></tr> <tr><td>50-99</td><td>\$89.84</td></tr> <tr><td>100+</td><td>\$87.91</td></tr> </tbody> </table> <p>N Male to MCX Plug</p> <p>Model No: <a href="#">PE9465</a></p>	PRICE	1-24	\$96.60	25-49	\$92.74	50-99	\$89.84	100+	\$87.91
	PRICE																																																	
1-9	\$197.50																																																	
10-24	\$187.63																																																	
25-49	\$177.75																																																	
50+	\$169.85																																																	
PRICE																																																		
1-24	\$89.19																																																	
25-49	\$84.73																																																	
50-99	\$80.27																																																	
100+	\$76.70																																																	
PRICE																																																		
1-24	\$57.19																																																	
25-49	\$54.33																																																	
50-99	\$51.47																																																	
100+	\$49.18																																																	
PRICE																																																		
1-9	\$209.10																																																	
10-24	\$198.65																																																	
25-49	\$188.19																																																	
50+	\$179.83																																																	
PRICE																																																		
1-24	\$96.60																																																	
25-49	\$92.74																																																	
50-99	\$89.84																																																	
100+	\$87.91																																																	
5	 <table border="1"> <thead> <tr><th>PRICE</th></tr> </thead> <tbody> <tr><td>1-9</td><td>\$138.58</td></tr> <tr><td>10-24</td><td>\$131.65</td></tr> <tr><td>25-49</td><td>\$124.72</td></tr> <tr><td>50+</td><td>\$119.18</td></tr> </tbody> </table> <p>N Male to MCX Jack</p> <p>Max. Freq. 6 GHz</p> <p>Model No: <a href="#">PE9464</a></p>	PRICE	1-9	\$138.58	10-24	\$131.65	25-49	\$124.72	50+	\$119.18	 <table border="1"> <thead> <tr><th>PRICE</th></tr> </thead> <tbody> <tr><td>1-24</td><td>\$27.36</td></tr> <tr><td>25-49</td><td>\$25.99</td></tr> <tr><td>50-99</td><td>\$24.62</td></tr> <tr><td>100+</td><td>\$23.53</td></tr> </tbody> </table> <p>N Male to Mini UHF Female</p> <p>Max. Freq. 2.5 GHz</p> <p>Model No: <a href="#">PE9064</a></p>	PRICE	1-24	\$27.36	25-49	\$25.99	50-99	\$24.62	100+	\$23.53	 <table border="1"> <thead> <tr><th>PRICE</th></tr> </thead> <tbody> <tr><td>1-9</td><td>\$228.67</td></tr> <tr><td>10-24</td><td>\$217.24</td></tr> <tr><td>25-49</td><td>\$205.80</td></tr> <tr><td>50+</td><td>\$196.66</td></tr> </tbody> </table> <p>N Male to QMA Female</p> <p>Max. Freq. 11 GHz</p> <p>Model No: <a href="#">PE9787</a></p>	PRICE	1-9	\$228.67	10-24	\$217.24	25-49	\$205.80	50+	\$196.66	 <table border="1"> <thead> <tr><th>PRICE</th></tr> </thead> <tbody> <tr><td>1-9</td><td>\$131.70</td></tr> <tr><td>10-24</td><td>\$125.12</td></tr> <tr><td>25-49</td><td>\$118.53</td></tr> <tr><td>50+</td><td>\$113.26</td></tr> </tbody> </table> <p>N Male to SC Male</p> <p>VSWR 1.25:1 to 11 GHz</p> <p>Model No: <a href="#">PE9570</a></p>	PRICE	1-9	\$131.70	10-24	\$125.12	25-49	\$118.53	50+	\$113.26	 <table border="1"> <thead> <tr><th>PRICE</th></tr> </thead> <tbody> <tr><td>1-9</td><td>\$117.52</td></tr> <tr><td>10-24</td><td>\$111.64</td></tr> <tr><td>25-49</td><td>\$105.77</td></tr> <tr><td>50+</td><td>\$101.07</td></tr> </tbody> </table> <p>N Male to SC Female</p> <p>VSWR 1.25:1 to 11 GHz</p> <p>Model No: <a href="#">PE9196</a></p>	PRICE	1-9	\$117.52	10-24	\$111.64	25-49	\$105.77	50+	\$101.07
	PRICE																																																	
1-9	\$138.58																																																	
10-24	\$131.65																																																	
25-49	\$124.72																																																	
50+	\$119.18																																																	
PRICE																																																		
1-24	\$27.36																																																	
25-49	\$25.99																																																	
50-99	\$24.62																																																	
100+	\$23.53																																																	
PRICE																																																		
1-9	\$228.67																																																	
10-24	\$217.24																																																	
25-49	\$205.80																																																	
50+	\$196.66																																																	
PRICE																																																		
1-9	\$131.70																																																	
10-24	\$125.12																																																	
25-49	\$118.53																																																	
50+	\$113.26																																																	
PRICE																																																		
1-9	\$117.52																																																	
10-24	\$111.64																																																	
25-49	\$105.77																																																	
50+	\$101.07																																																	
6	 <table border="1"> <thead> <tr><th>PRICE</th></tr> </thead> <tbody> <tr><td>1-24</td><td>\$52.34</td></tr> <tr><td>25-49</td><td>\$49.72</td></tr> <tr><td>50-99</td><td>\$47.11</td></tr> <tr><td>100+</td><td>\$45.01</td></tr> </tbody> </table> <p>Low PIM N Male to SMA Female</p> <p>VSWR 1.2:1 to 6 GHz</p> <p>Model No: <a href="#">PE91177</a></p>	PRICE	1-24	\$52.34	25-49	\$49.72	50-99	\$47.11	100+	\$45.01	 <table border="1"> <thead> <tr><th>PRICE</th></tr> </thead> <tbody> <tr><td>1-24</td><td>\$49.80</td></tr> <tr><td>25-49</td><td>\$47.31</td></tr> <tr><td>50-99</td><td>\$44.82</td></tr> <tr><td>100+</td><td>\$42.83</td></tr> </tbody> </table> <p>PRECISION NEW N Male to SMA Female</p> <p>VSWR 1.25:1 to 18 GHz</p> <p>Model No: <a href="#">PE91339</a></p>	PRICE	1-24	\$49.80	25-49	\$47.31	50-99	\$44.82	100+	\$42.83	 <table border="1"> <thead> <tr><th>PRICE</th></tr> </thead> <tbody> <tr><td>1-24</td><td>\$106.72</td></tr> <tr><td>25-49</td><td>\$101.38</td></tr> <tr><td>50-99</td><td>\$96.05</td></tr> <tr><td>100+</td><td>\$91.78</td></tr> </tbody> </table> <p>N Male to SMB Plug</p> <p>Model No: <a href="#">PE9314</a></p>	PRICE	1-24	\$106.72	25-49	\$101.38	50-99	\$96.05	100+	\$91.78	 <table border="1"> <thead> <tr><th>PRICE</th></tr> </thead> <tbody> <tr><td>1-24</td><td>\$71.13</td></tr> <tr><td>25-49</td><td>\$67.57</td></tr> <tr><td>50-99</td><td>\$64.02</td></tr> <tr><td>100+</td><td>\$61.17</td></tr> </tbody> </table> <p>N Male to SMB Jack</p> <p>Model No: <a href="#">PE9313</a></p>	PRICE	1-24	\$71.13	25-49	\$67.57	50-99	\$64.02	100+	\$61.17	 <table border="1"> <thead> <tr><th>PRICE</th></tr> </thead> <tbody> <tr><td>1-24</td><td>\$105.02</td></tr> <tr><td>25-49</td><td>\$99.77</td></tr> <tr><td>50-99</td><td>\$94.52</td></tr> <tr><td>100+</td><td>\$90.32</td></tr> </tbody> </table> <p>N Male to SMC Plug</p> <p>Model No: <a href="#">PE9318</a></p>	PRICE	1-24	\$105.02	25-49	\$99.77	50-99	\$94.52	100+	\$90.32
	PRICE																																																	
1-24	\$52.34																																																	
25-49	\$49.72																																																	
50-99	\$47.11																																																	
100+	\$45.01																																																	
PRICE																																																		
1-24	\$49.80																																																	
25-49	\$47.31																																																	
50-99	\$44.82																																																	
100+	\$42.83																																																	
PRICE																																																		
1-24	\$106.72																																																	
25-49	\$101.38																																																	
50-99	\$96.05																																																	
100+	\$91.78																																																	
PRICE																																																		
1-24	\$71.13																																																	
25-49	\$67.57																																																	
50-99	\$64.02																																																	
100+	\$61.17																																																	
PRICE																																																		
1-24	\$105.02																																																	
25-49	\$99.77																																																	
50-99	\$94.52																																																	
100+	\$90.32																																																	
7	 <table border="1"> <thead> <tr><th>PRICE</th></tr> </thead> <tbody> <tr><td>1-24</td><td>\$92.84</td></tr> <tr><td>25-49</td><td>\$88.20</td></tr> <tr><td>50-99</td><td>\$83.56</td></tr> <tr><td>100+</td><td>\$79.84</td></tr> </tbody> </table> <p>N Male to SMC Jack</p> <p>Model No: <a href="#">PE9317</a></p>	PRICE	1-24	\$92.84	25-49	\$88.20	50-99	\$83.56	100+	\$79.84	 <table border="1"> <thead> <tr><th>PRICE</th></tr> </thead> <tbody> <tr><td>1-24</td><td>\$27.58</td></tr> <tr><td>25-49</td><td>\$26.20</td></tr> <tr><td>50-99</td><td>\$24.82</td></tr> <tr><td>100+</td><td>\$23.72</td></tr> </tbody> </table> <p>N Male to TNC Male</p> <p>VSWR 1.5:1 to 11 GHz</p> <p>Model No: <a href="#">PE9130</a></p>	PRICE	1-24	\$27.58	25-49	\$26.20	50-99	\$24.82	100+	\$23.72	 <table border="1"> <thead> <tr><th>PRICE</th></tr> </thead> <tbody> <tr><td>1-9</td><td>\$169.77</td></tr> <tr><td>10-24</td><td>\$161.28</td></tr> <tr><td>25-49</td><td>\$152.79</td></tr> <tr><td>50+</td><td>\$146.00</td></tr> </tbody> </table> <p>PRECISION N Male to TNC Male</p> <p>VSWR 1.15:1 to 18 GHz</p> <p>Model No: <a href="#">PE9446</a></p>	PRICE	1-9	\$169.77	10-24	\$161.28	25-49	\$152.79	50+	\$146.00	 <table border="1"> <thead> <tr><th>PRICE</th></tr> </thead> <tbody> <tr><td>1-24</td><td>\$25.69</td></tr> <tr><td>25-49</td><td>\$24.41</td></tr> <tr><td>50-99</td><td>\$23.12</td></tr> <tr><td>100+</td><td>\$22.09</td></tr> </tbody> </table> <p>N Male to TNC Female</p> <p>VSWR 1.5:1 to 1,000 MHz</p> <p>Model No: <a href="#">PE9090</a></p>	PRICE	1-24	\$25.69	25-49	\$24.41	50-99	\$23.12	100+	\$22.09	 <table border="1"> <thead> <tr><th>PRICE</th></tr> </thead> <tbody> <tr><td>1-24</td><td>\$91.77</td></tr> <tr><td>25-49</td><td>\$87.18</td></tr> <tr><td>50-99</td><td>\$82.59</td></tr> <tr><td>100+</td><td>\$78.92</td></tr> </tbody> </table> <p>N Male to TNC Female Right Angle</p> <p>VSWR 1.33:1 to 6 GHz</p> <p>Model No: <a href="#">PE9550</a></p>	PRICE	1-24	\$91.77	25-49	\$87.18	50-99	\$82.59	100+	\$78.92
	PRICE																																																	
1-24	\$92.84																																																	
25-49	\$88.20																																																	
50-99	\$83.56																																																	
100+	\$79.84																																																	
PRICE																																																		
1-24	\$27.58																																																	
25-49	\$26.20																																																	
50-99	\$24.82																																																	
100+	\$23.72																																																	
PRICE																																																		
1-9	\$169.77																																																	
10-24	\$161.28																																																	
25-49	\$152.79																																																	
50+	\$146.00																																																	
PRICE																																																		
1-24	\$25.69																																																	
25-49	\$24.41																																																	
50-99	\$23.12																																																	
100+	\$22.09																																																	
PRICE																																																		
1-24	\$91.77																																																	
25-49	\$87.18																																																	
50-99	\$82.59																																																	
100+	\$78.92																																																	



Technical Support  
+1 (949) 261-1920



Same-Day Shipping,  
Even Custom  
Cable Assemblies



# ADAPTERS

See Adapter Locator on Pages 10-15

See Page 409 for Mounting Holes

	A	B	C	D	E																																																		
1	 <table border="1"> <thead> <tr> <th colspan="2">PRICE</th> </tr> </thead> <tbody> <tr> <td>1-9</td> <td>\$114.76</td> </tr> <tr> <td>10-24</td> <td>\$109.02</td> </tr> <tr> <td>25-49</td> <td>\$103.28</td> </tr> <tr> <td>NEW 50+</td> <td>\$98.69</td> </tr> </tbody> </table> <p><b>N Male to TNC Female</b> VSWR 1.15:1 to 18 GHz</p> <p>Model No: <a href="#">PE91537</a></p>	PRICE		1-9	\$114.76	10-24	\$109.02	25-49	\$103.28	NEW 50+	\$98.69	 <table border="1"> <thead> <tr> <th colspan="2">PRICE</th> </tr> </thead> <tbody> <tr> <td>1-24</td> <td>\$39.10</td> </tr> <tr> <td>25-49</td> <td>\$37.15</td> </tr> <tr> <td>50-99</td> <td>\$35.19</td> </tr> <tr> <td>100+</td> <td>\$33.63</td> </tr> </tbody> </table> <p><b>N Male to UHF Male</b></p> <p>Model No: <a href="#">PE9113</a></p>	PRICE		1-24	\$39.10	25-49	\$37.15	50-99	\$35.19	100+	\$33.63	 <table border="1"> <thead> <tr> <th colspan="2">PRICE</th> </tr> </thead> <tbody> <tr> <td>1-24</td> <td>\$37.33</td> </tr> <tr> <td>25-49</td> <td>\$35.46</td> </tr> <tr> <td>50-99</td> <td>\$33.60</td> </tr> <tr> <td>100+</td> <td>\$32.10</td> </tr> </tbody> </table> <p><b>N Male to UHF Female</b> VSWR 1.3:1 to 300 MHz</p> <p>Model No: <a href="#">PE9111</a></p>	PRICE		1-24	\$37.33	25-49	\$35.46	50-99	\$33.60	100+	\$32.10	 <table border="1"> <thead> <tr> <th colspan="2">PRICE</th> </tr> </thead> <tbody> <tr> <td>1-9</td> <td>\$346.32</td> </tr> <tr> <td>10-24</td> <td>\$332.47</td> </tr> <tr> <td>25-49</td> <td>\$322.08</td> </tr> <tr> <td>PRECISION 50+</td> <td>\$315.15</td> </tr> </tbody> </table> <p><b>N Female to 7mm Sexless</b> VSWR 1.15:1 to 18 GHz</p> <p>Model No: <a href="#">PE9216</a></p>	PRICE		1-9	\$346.32	10-24	\$332.47	25-49	\$322.08	PRECISION 50+	\$315.15	 <table border="1"> <thead> <tr> <th colspan="2">PRICE</th> </tr> </thead> <tbody> <tr> <td>1-24</td> <td>\$107.77</td> </tr> <tr> <td>25-49</td> <td>\$102.38</td> </tr> <tr> <td>50-99</td> <td>\$96.99</td> </tr> <tr> <td>Low PIM 100+</td> <td>\$92.68</td> </tr> </tbody> </table> <p><b>N Female to 7/16 DIN Male</b> Max. Freq. 8 GHz</p> <p>Model No: <a href="#">PE91031</a></p>	PRICE		1-24	\$107.77	25-49	\$102.38	50-99	\$96.99	Low PIM 100+	\$92.68
	PRICE																																																						
1-9	\$114.76																																																						
10-24	\$109.02																																																						
25-49	\$103.28																																																						
NEW 50+	\$98.69																																																						
PRICE																																																							
1-24	\$39.10																																																						
25-49	\$37.15																																																						
50-99	\$35.19																																																						
100+	\$33.63																																																						
PRICE																																																							
1-24	\$37.33																																																						
25-49	\$35.46																																																						
50-99	\$33.60																																																						
100+	\$32.10																																																						
PRICE																																																							
1-9	\$346.32																																																						
10-24	\$332.47																																																						
25-49	\$322.08																																																						
PRECISION 50+	\$315.15																																																						
PRICE																																																							
1-24	\$107.77																																																						
25-49	\$102.38																																																						
50-99	\$96.99																																																						
Low PIM 100+	\$92.68																																																						
2	 <table border="1"> <thead> <tr> <th colspan="2">PRICE</th> </tr> </thead> <tbody> <tr> <td>1-24</td> <td>\$100.12</td> </tr> <tr> <td>25-49</td> <td>\$95.11</td> </tr> <tr> <td>50-99</td> <td>\$90.11</td> </tr> <tr> <td>Low PIM 100+</td> <td>\$86.10</td> </tr> </tbody> </table> <p><b>N Female to 7/16 DIN Female</b> Max. Freq. 8 GHz</p> <p>Model No: <a href="#">PE91033</a></p>	PRICE		1-24	\$100.12	25-49	\$95.11	50-99	\$90.11	Low PIM 100+	\$86.10	 <table border="1"> <thead> <tr> <th colspan="2">PRICE</th> </tr> </thead> <tbody> <tr> <td>1-9</td> <td>\$153.30</td> </tr> <tr> <td>10-24</td> <td>\$145.64</td> </tr> <tr> <td>25-49</td> <td>\$137.97</td> </tr> <tr> <td>Low PIM 50+</td> <td>\$131.84</td> </tr> </tbody> </table> <p><b>N Female to 7/16 DIN Female</b> Max. Freq. 8 GHz</p> <p>Model No: <a href="#">PE9180</a></p>	PRICE		1-9	\$153.30	10-24	\$145.64	25-49	\$137.97	Low PIM 50+	\$131.84	 <table border="1"> <thead> <tr> <th colspan="2">PRICE</th> </tr> </thead> <tbody> <tr> <td>1-24</td> <td>\$24.88</td> </tr> <tr> <td>25-49</td> <td>\$23.64</td> </tr> <tr> <td>50-99</td> <td>\$22.39</td> </tr> <tr> <td>100+</td> <td>\$21.40</td> </tr> </tbody> </table> <p><b>N Female to BNC Male</b> VSWR 1.3:1 to 4 GHz</p> <p>Model No: <a href="#">PE9005</a></p>	PRICE		1-24	\$24.88	25-49	\$23.64	50-99	\$22.39	100+	\$21.40	 <table border="1"> <thead> <tr> <th colspan="2">PRICE</th> </tr> </thead> <tbody> <tr> <td>1-9</td> <td>\$150.35</td> </tr> <tr> <td>10-24</td> <td>\$142.83</td> </tr> <tr> <td>25-49</td> <td>\$135.32</td> </tr> <tr> <td>PRECISION 50+</td> <td>\$129.30</td> </tr> </tbody> </table> <p><b>N Female to BNC Male</b> VSWR 1.2:1 to 8 GHz</p> <p>Model No: <a href="#">PE9490</a></p>	PRICE		1-9	\$150.35	10-24	\$142.83	25-49	\$135.32	PRECISION 50+	\$129.30	 <table border="1"> <thead> <tr> <th colspan="2">PRICE</th> </tr> </thead> <tbody> <tr> <td>1-24</td> <td>\$68.21</td> </tr> <tr> <td>25-49</td> <td>\$64.80</td> </tr> <tr> <td>50-99</td> <td>\$61.39</td> </tr> <tr> <td>100+</td> <td>\$58.66</td> </tr> </tbody> </table> <p><b>N Female to BNC Male Right Angle</b> Max. Freq. 4 GHz</p> <p>Model No: <a href="#">PE9566</a></p>	PRICE		1-24	\$68.21	25-49	\$64.80	50-99	\$61.39	100+	\$58.66
	PRICE																																																						
1-24	\$100.12																																																						
25-49	\$95.11																																																						
50-99	\$90.11																																																						
Low PIM 100+	\$86.10																																																						
PRICE																																																							
1-9	\$153.30																																																						
10-24	\$145.64																																																						
25-49	\$137.97																																																						
Low PIM 50+	\$131.84																																																						
PRICE																																																							
1-24	\$24.88																																																						
25-49	\$23.64																																																						
50-99	\$22.39																																																						
100+	\$21.40																																																						
PRICE																																																							
1-9	\$150.35																																																						
10-24	\$142.83																																																						
25-49	\$135.32																																																						
PRECISION 50+	\$129.30																																																						
PRICE																																																							
1-24	\$68.21																																																						
25-49	\$64.80																																																						
50-99	\$61.39																																																						
100+	\$58.66																																																						
3	 <table border="1"> <thead> <tr> <th colspan="2">PRICE</th> </tr> </thead> <tbody> <tr> <td>1-24</td> <td>\$89.80</td> </tr> <tr> <td>25-49</td> <td>\$85.31</td> </tr> <tr> <td>50-99</td> <td>\$80.82</td> </tr> <tr> <td>100+</td> <td>\$77.23</td> </tr> </tbody> </table> <p><b>N Female to BNC Male 4 Hole Flange-Mounting Hole A05</b></p> <p>Model No: <a href="#">PE9123</a></p>	PRICE		1-24	\$89.80	25-49	\$85.31	50-99	\$80.82	100+	\$77.23	 <table border="1"> <thead> <tr> <th colspan="2">PRICE</th> </tr> </thead> <tbody> <tr> <td>1-24</td> <td>\$26.36</td> </tr> <tr> <td>25-49</td> <td>\$25.04</td> </tr> <tr> <td>50-99</td> <td>\$23.72</td> </tr> <tr> <td>100+</td> <td>\$22.67</td> </tr> </tbody> </table> <p><b>N Female to BNC Female</b> VSWR 1.5:1 to 3 GHz</p> <p>Model No: <a href="#">PE9206</a></p>	PRICE		1-24	\$26.36	25-49	\$25.04	50-99	\$23.72	100+	\$22.67	 <table border="1"> <thead> <tr> <th colspan="2">PRICE</th> </tr> </thead> <tbody> <tr> <td>1-9</td> <td>\$94.39</td> </tr> <tr> <td>10-24</td> <td>\$89.67</td> </tr> <tr> <td>25-49</td> <td>\$84.95</td> </tr> <tr> <td>PRECISION 50+</td> <td>\$81.18</td> </tr> </tbody> </table> <p><b>N Female to BNC Female</b> VSWR 1.2:1 to 8 GHz</p> <p>Model No: <a href="#">PE9492</a></p>	PRICE		1-9	\$94.39	10-24	\$89.67	25-49	\$84.95	PRECISION 50+	\$81.18	 <table border="1"> <thead> <tr> <th colspan="2">PRICE</th> </tr> </thead> <tbody> <tr> <td>1-24</td> <td>\$71.59</td> </tr> <tr> <td>25-49</td> <td>\$68.01</td> </tr> <tr> <td>50-99</td> <td>\$64.43</td> </tr> <tr> <td>100+</td> <td>\$61.57</td> </tr> </tbody> </table> <p><b>N Female to BNC Female Bulkhead-Mounting Hole G01</b></p> <p>Model No: <a href="#">PE9261</a></p>	PRICE		1-24	\$71.59	25-49	\$68.01	50-99	\$64.43	100+	\$61.57	 <table border="1"> <thead> <tr> <th colspan="2">PRICE</th> </tr> </thead> <tbody> <tr> <td>1-24</td> <td>\$63.24</td> </tr> <tr> <td>25-49</td> <td>\$60.08</td> </tr> <tr> <td>50-99</td> <td>\$56.92</td> </tr> <tr> <td>100+</td> <td>\$54.39</td> </tr> </tbody> </table> <p><b>N Female to BNC Female 4 Hole Flange-Mounting Hole A05</b> VSWR 1.2:1 to 6 GHz</p> <p>Model No: <a href="#">PE9238</a></p>	PRICE		1-24	\$63.24	25-49	\$60.08	50-99	\$56.92	100+	\$54.39
	PRICE																																																						
1-24	\$89.80																																																						
25-49	\$85.31																																																						
50-99	\$80.82																																																						
100+	\$77.23																																																						
PRICE																																																							
1-24	\$26.36																																																						
25-49	\$25.04																																																						
50-99	\$23.72																																																						
100+	\$22.67																																																						
PRICE																																																							
1-9	\$94.39																																																						
10-24	\$89.67																																																						
25-49	\$84.95																																																						
PRECISION 50+	\$81.18																																																						
PRICE																																																							
1-24	\$71.59																																																						
25-49	\$68.01																																																						
50-99	\$64.43																																																						
100+	\$61.57																																																						
PRICE																																																							
1-24	\$63.24																																																						
25-49	\$60.08																																																						
50-99	\$56.92																																																						
100+	\$54.39																																																						
4	 <table border="1"> <thead> <tr> <th colspan="2">PRICE</th> </tr> </thead> <tbody> <tr> <td>1-24</td> <td>\$70.64</td> </tr> <tr> <td>25-49</td> <td>\$67.11</td> </tr> <tr> <td>50-99</td> <td>\$63.58</td> </tr> <tr> <td>100+</td> <td>\$60.75</td> </tr> </tbody> </table> <p><b>N Female to BNC Female Bulkhead-Mounting Hole G01</b> Max. Freq. 4 GHz</p> <p>Model No: <a href="#">PE9540</a></p>	PRICE		1-24	\$70.64	25-49	\$67.11	50-99	\$63.58	100+	\$60.75	 <table border="1"> <thead> <tr> <th colspan="2">PRICE</th> </tr> </thead> <tbody> <tr> <td>1-24</td> <td>\$67.81</td> </tr> <tr> <td>25-49</td> <td>\$64.42</td> </tr> <tr> <td>50-99</td> <td>\$61.03</td> </tr> <tr> <td>100+</td> <td>\$58.32</td> </tr> </tbody> </table> <p><b>N Female to C Male</b> VSWR 1.25:1 to 11 GHz</p> <p>Model No: <a href="#">PE9295</a></p>	PRICE		1-24	\$67.81	25-49	\$64.42	50-99	\$61.03	100+	\$58.32	 <table border="1"> <thead> <tr> <th colspan="2">PRICE</th> </tr> </thead> <tbody> <tr> <td>1-24</td> <td>\$99.08</td> </tr> <tr> <td>25-49</td> <td>\$94.13</td> </tr> <tr> <td>50-99</td> <td>\$89.17</td> </tr> <tr> <td>100+</td> <td>\$85.21</td> </tr> </tbody> </table> <p><b>N Female to C Female</b></p> <p>Model No: <a href="#">PE9539</a></p>	PRICE		1-24	\$99.08	25-49	\$94.13	50-99	\$89.17	100+	\$85.21	 <table border="1"> <thead> <tr> <th colspan="2">PRICE</th> </tr> </thead> <tbody> <tr> <td>1-24</td> <td>\$45.74</td> </tr> <tr> <td>25-49</td> <td>\$43.45</td> </tr> <tr> <td>50-99</td> <td>\$41.17</td> </tr> <tr> <td>100+</td> <td>\$39.34</td> </tr> </tbody> </table> <p><b>N Female to 75 Ohm F Male</b> VSWR 1.3:1 to 250 MHz</p> <p>Model No: <a href="#">PE9389</a></p>	PRICE		1-24	\$45.74	25-49	\$43.45	50-99	\$41.17	100+	\$39.34	 <table border="1"> <thead> <tr> <th colspan="2">PRICE</th> </tr> </thead> <tbody> <tr> <td>1-9</td> <td>\$191.83</td> </tr> <tr> <td>10-24</td> <td>\$182.24</td> </tr> <tr> <td>25-49</td> <td>\$172.65</td> </tr> <tr> <td>50+</td> <td>\$164.97</td> </tr> </tbody> </table> <p><b>N Female to GR874 Sexless</b></p> <p>Model No: <a href="#">PE9258</a></p>	PRICE		1-9	\$191.83	10-24	\$182.24	25-49	\$172.65	50+	\$164.97
	PRICE																																																						
1-24	\$70.64																																																						
25-49	\$67.11																																																						
50-99	\$63.58																																																						
100+	\$60.75																																																						
PRICE																																																							
1-24	\$67.81																																																						
25-49	\$64.42																																																						
50-99	\$61.03																																																						
100+	\$58.32																																																						
PRICE																																																							
1-24	\$99.08																																																						
25-49	\$94.13																																																						
50-99	\$89.17																																																						
100+	\$85.21																																																						
PRICE																																																							
1-24	\$45.74																																																						
25-49	\$43.45																																																						
50-99	\$41.17																																																						
100+	\$39.34																																																						
PRICE																																																							
1-9	\$191.83																																																						
10-24	\$182.24																																																						
25-49	\$172.65																																																						
50+	\$164.97																																																						
5	 <table border="1"> <thead> <tr> <th colspan="2">PRICE</th> </tr> </thead> <tbody> <tr> <td>1-24</td> <td>\$58.30</td> </tr> <tr> <td>25-49</td> <td>\$55.39</td> </tr> <tr> <td>50-99</td> <td>\$52.47</td> </tr> <tr> <td>100+</td> <td>\$50.14</td> </tr> </tbody> </table> <p><b>N Female to HN Male</b> VSWR 1.3:1 to 3 GHz</p> <p>Model No: <a href="#">PE9194</a></p>	PRICE		1-24	\$58.30	25-49	\$55.39	50-99	\$52.47	100+	\$50.14	 <table border="1"> <thead> <tr> <th colspan="2">PRICE</th> </tr> </thead> <tbody> <tr> <td>1-24</td> <td>\$83.15</td> </tr> <tr> <td>25-49</td> <td>\$78.99</td> </tr> <tr> <td>50-99</td> <td>\$74.84</td> </tr> <tr> <td>100+</td> <td>\$71.51</td> </tr> </tbody> </table> <p><b>N Female to HN Female</b></p> <p>Model No: <a href="#">PE9360</a></p>	PRICE		1-24	\$83.15	25-49	\$78.99	50-99	\$74.84	100+	\$71.51	 <table border="1"> <thead> <tr> <th colspan="2">PRICE</th> </tr> </thead> <tbody> <tr> <td>1-24</td> <td>\$122.86</td> </tr> <tr> <td>25-49</td> <td>\$116.72</td> </tr> <tr> <td>50-99</td> <td>\$110.57</td> </tr> <tr> <td>100+</td> <td>\$105.66</td> </tr> </tbody> </table> <p><b>N Female to HN Female 4 Hole Flange-Mounting Hole A08</b></p> <p>Model No: <a href="#">PE9553</a></p>	PRICE		1-24	\$122.86	25-49	\$116.72	50-99	\$110.57	100+	\$105.66	 <table border="1"> <thead> <tr> <th colspan="2">PRICE</th> </tr> </thead> <tbody> <tr> <td>1-9</td> <td>\$314.82</td> </tr> <tr> <td>10-24</td> <td>\$299.08</td> </tr> <tr> <td>25-49</td> <td>\$283.34</td> </tr> <tr> <td>50+</td> <td>\$270.75</td> </tr> </tbody> </table> <p><b>N Female to LC Male</b> Max. Freq. 1,000 MHz</p> <p>Model No: <a href="#">PE9237</a></p>	PRICE		1-9	\$314.82	10-24	\$299.08	25-49	\$283.34	50+	\$270.75	 <table border="1"> <thead> <tr> <th colspan="2">PRICE</th> </tr> </thead> <tbody> <tr> <td>1-9</td> <td>\$292.63</td> </tr> <tr> <td>10-24</td> <td>\$278.00</td> </tr> <tr> <td>25-49</td> <td>\$263.37</td> </tr> <tr> <td>50+</td> <td>\$251.66</td> </tr> </tbody> </table> <p><b>N Female to LC Female</b></p> <p>Model No: <a href="#">PE9298</a></p>	PRICE		1-9	\$292.63	10-24	\$278.00	25-49	\$263.37	50+	\$251.66
	PRICE																																																						
1-24	\$58.30																																																						
25-49	\$55.39																																																						
50-99	\$52.47																																																						
100+	\$50.14																																																						
PRICE																																																							
1-24	\$83.15																																																						
25-49	\$78.99																																																						
50-99	\$74.84																																																						
100+	\$71.51																																																						
PRICE																																																							
1-24	\$122.86																																																						
25-49	\$116.72																																																						
50-99	\$110.57																																																						
100+	\$105.66																																																						
PRICE																																																							
1-9	\$314.82																																																						
10-24	\$299.08																																																						
25-49	\$283.34																																																						
50+	\$270.75																																																						
PRICE																																																							
1-9	\$292.63																																																						
10-24	\$278.00																																																						
25-49	\$263.37																																																						
50+	\$251.66																																																						
6	 <table border="1"> <thead> <tr> <th colspan="2">PRICE</th> </tr> </thead> <tbody> <tr> <td>1-24</td> <td>\$109.97</td> </tr> <tr> <td>25-49</td> <td>\$105.57</td> </tr> <tr> <td>50-99</td> <td>\$102.27</td> </tr> <tr> <td>100+</td> <td>\$100.07</td> </tr> </tbody> </table> <p><b>N Female to MCX Plug</b> Max. Freq. 6 GHz</p> <p>Model No: <a href="#">PE9463</a></p>	PRICE		1-24	\$109.97	25-49	\$105.57	50-99	\$102.27	100+	\$100.07	 <table border="1"> <thead> <tr> <th colspan="2">PRICE</th> </tr> </thead> <tbody> <tr> <td>1-9</td> <td>\$138.58</td> </tr> <tr> <td>10-24</td> <td>\$131.65</td> </tr> <tr> <td>25-49</td> <td>\$124.72</td> </tr> <tr> <td>50+</td> <td>\$119.18</td> </tr> </tbody> </table> <p><b>N Female to MCX Jack</b> Max. Freq. 6 GHz</p> <p>Model No: <a href="#">PE9462</a></p>	PRICE		1-9	\$138.58	10-24	\$131.65	25-49	\$124.72	50+	\$119.18	 <table border="1"> <thead> <tr> <th colspan="2">PRICE</th> </tr> </thead> <tbody> <tr> <td>1-24</td> <td>\$28.77</td> </tr> <tr> <td>25-49</td> <td>\$27.33</td> </tr> <tr> <td>50-99</td> <td>\$25.89</td> </tr> <tr> <td>100+</td> <td>\$24.74</td> </tr> </tbody> </table> <p><b>N Female to Mini UHF Male</b> VSWR 1.5:1 to 2.5 GHz</p> <p>Model No: <a href="#">PE9183</a></p>	PRICE		1-24	\$28.77	25-49	\$27.33	50-99	\$25.89	100+	\$24.74	 <table border="1"> <thead> <tr> <th colspan="2">PRICE</th> </tr> </thead> <tbody> <tr> <td>1-9</td> <td>\$118.57</td> </tr> <tr> <td>10-24</td> <td>\$112.64</td> </tr> <tr> <td>25-49</td> <td>\$106.71</td> </tr> <tr> <td>50+</td> <td>\$101.97</td> </tr> </tbody> </table> <p><b>N Female to SC Male</b> VSWR 1.25:1 to 11 GHz</p> <p>Model No: <a href="#">PE9277</a></p>	PRICE		1-9	\$118.57	10-24	\$112.64	25-49	\$106.71	50+	\$101.97	 <table border="1"> <thead> <tr> <th colspan="2">PRICE</th> </tr> </thead> <tbody> <tr> <td>1-9</td> <td>\$119.05</td> </tr> <tr> <td>10-24</td> <td>\$113.10</td> </tr> <tr> <td>25-49</td> <td>\$107.15</td> </tr> <tr> <td>50+</td> <td>\$102.38</td> </tr> </tbody> </table> <p><b>N Female to SC Female</b> VSWR 1.25:1 to 11 GHz</p> <p>Model No: <a href="#">PE9292</a></p>	PRICE		1-9	\$119.05	10-24	\$113.10	25-49	\$107.15	50+	\$102.38
	PRICE																																																						
1-24	\$109.97																																																						
25-49	\$105.57																																																						
50-99	\$102.27																																																						
100+	\$100.07																																																						
PRICE																																																							
1-9	\$138.58																																																						
10-24	\$131.65																																																						
25-49	\$124.72																																																						
50+	\$119.18																																																						
PRICE																																																							
1-24	\$28.77																																																						
25-49	\$27.33																																																						
50-99	\$25.89																																																						
100+	\$24.74																																																						
PRICE																																																							
1-9	\$118.57																																																						
10-24	\$112.64																																																						
25-49	\$106.71																																																						
50+	\$101.97																																																						
PRICE																																																							
1-9	\$119.05																																																						
10-24	\$113.10																																																						
25-49	\$107.15																																																						
50+	\$102.38																																																						
7	 <table border="1"> <thead> <tr> <th colspan="2">PRICE</th> </tr> </thead> <tbody> <tr> <td>1-24</td> <td>\$53.30</td> </tr> <tr> <td>25-49</td> <td>\$50.64</td> </tr> <tr> <td>50-99</td> <td>\$47.97</td> </tr> <tr> <td>Low PIM 100+</td> <td>\$45.84</td> </tr> </tbody> </table> <p><b>N Female to SMA Male</b> VSWR 1.2:1 to 6 GHz</p> <p>Model No: <a href="#">PE91178</a></p>	PRICE		1-24	\$53.30	25-49	\$50.64	50-99	\$47.97	Low PIM 100+	\$45.84	 <table border="1"> <thead> <tr> <th colspan="2">PRICE</th> </tr> </thead> <tbody> <tr> <td>1-24</td> <td>\$78.35</td> </tr> <tr> <td>25-49</td> <td>\$74.43</td> </tr> <tr> <td>50-99</td> <td>\$70.52</td> </tr> <tr> <td>100+</td> <td>\$67.38</td> </tr> </tbody> </table> <p><b>N Female to SMB Plug</b></p> <p>Model No: <a href="#">PE9316</a></p>	PRICE		1-24	\$78.35	25-49	\$74.43	50-99	\$70.52	100+	\$67.38	 <table border="1"> <thead> <tr> <th colspan="2">PRICE</th> </tr> </thead> <tbody> <tr> <td>1-24</td> <td>\$78.35</td> </tr> <tr> <td>25-49</td> <td>\$74.43</td> </tr> <tr> <td>50-99</td> <td>\$70.52</td> </tr> <tr> <td>100+</td> <td>\$67.38</td> </tr> </tbody> </table> <p><b>N Female to SMB Jack</b></p> <p>Model No: <a href="#">PE9315</a></p>	PRICE		1-24	\$78.35	25-49	\$74.43	50-99	\$70.52	100+	\$67.38	 <table border="1"> <thead> <tr> <th colspan="2">PRICE</th> </tr> </thead> <tbody> <tr> <td>1-24</td> <td>\$111.53</td> </tr> <tr> <td>25-49</td> <td>\$105.95</td> </tr> <tr> <td>50-99</td> <td>\$100.38</td> </tr> <tr> <td>100+</td> <td>\$95.92</td> </tr> </tbody> </table> <p><b>N Female to SMC Plug</b></p> <p>Model No: <a href="#">PE9320</a></p>	PRICE		1-24	\$111.53	25-49	\$105.95	50-99	\$100.38	100+	\$95.92	 <table border="1"> <thead> <tr> <th colspan="2">PRICE</th> </tr> </thead> <tbody> <tr> <td>1-24</td> <td>\$90.90</td> </tr> <tr> <td>25-49</td> <td>\$86.36</td> </tr> <tr> <td>50-99</td> <td>\$81.81</td> </tr> <tr> <td>100+</td> <td>\$78.17</td> </tr> </tbody> </table> <p><b>N Female to SMC Jack</b></p> <p>Model No: <a href="#">PE9319</a></p>	PRICE		1-24	\$90.90	25-49	\$86.36	50-99	\$81.81	100+	\$78.17
	PRICE																																																						
1-24	\$53.30																																																						
25-49	\$50.64																																																						
50-99	\$47.97																																																						
Low PIM 100+	\$45.84																																																						
PRICE																																																							
1-24	\$78.35																																																						
25-49	\$74.43																																																						
50-99	\$70.52																																																						
100+	\$67.38																																																						
PRICE																																																							
1-24	\$78.35																																																						
25-49	\$74.43																																																						
50-99	\$70.52																																																						
100+	\$67.38																																																						
PRICE																																																							
1-24	\$111.53																																																						
25-49	\$105.95																																																						
50-99	\$100.38																																																						
100+	\$95.92																																																						
PRICE																																																							
1-24	\$90.90																																																						
25-49	\$86.36																																																						
50-99	\$81.81																																																						
100+	\$78.17																																																						

# ADAPTERS

See Adapter Locator on Pages 10-15  
See Page 409 for Mounting Holes

	A	B	C	D	E																									
1	 <table border="1"> <thead> <tr> <th>PRICE</th> </tr> </thead> <tbody> <tr> <td>1-24 \$21.40</td> </tr> <tr> <td>25-49 \$20.33</td> </tr> <tr> <td>50-99 \$19.26</td> </tr> <tr> <td>100+ \$18.40</td> </tr> </tbody> </table> <p><b>N Female to TNC Male</b> VSWR 1.3:1 to 6 GHz Model No: <a href="#">PE9089</a></p>	PRICE	1-24 \$21.40	25-49 \$20.33	50-99 \$19.26	100+ \$18.40	 <table border="1"> <thead> <tr> <th>PRICE</th> </tr> </thead> <tbody> <tr> <td>1-24 \$150.28</td> </tr> <tr> <td>25-49 \$139.76</td> </tr> <tr> <td>50-99 \$129.24</td> </tr> <tr> <td>100+ \$120.22</td> </tr> </tbody> </table> <p>PRECISION <b>N Female to TNC Male</b> VSWR 1.2:1 to 18 GHz Model No: <a href="#">PE91506</a></p>	PRICE	1-24 \$150.28	25-49 \$139.76	50-99 \$129.24	100+ \$120.22	 <table border="1"> <thead> <tr> <th>PRICE</th> </tr> </thead> <tbody> <tr> <td>1-24 \$70.42</td> </tr> <tr> <td>25-49 \$66.90</td> </tr> <tr> <td>50-99 \$63.38</td> </tr> <tr> <td>100+ \$60.56</td> </tr> </tbody> </table> <p><b>N Female to TNC Male Right Angle</b> VSWR 1.5:1 to 6 GHz Model No: <a href="#">PE9263</a></p>	PRICE	1-24 \$70.42	25-49 \$66.90	50-99 \$63.38	100+ \$60.56	 <table border="1"> <thead> <tr> <th>PRICE</th> </tr> </thead> <tbody> <tr> <td>1-24 \$31.78</td> </tr> <tr> <td>25-49 \$30.19</td> </tr> <tr> <td>50-99 \$28.60</td> </tr> <tr> <td>100+ \$27.33</td> </tr> </tbody> </table> <p><b>N Female to TNC Female</b> VSWR 1.5:1 to 3 GHz Model No: <a href="#">PE9131</a></p>	PRICE	1-24 \$31.78	25-49 \$30.19	50-99 \$28.60	100+ \$27.33	 <table border="1"> <thead> <tr> <th>PRICE</th> </tr> </thead> <tbody> <tr> <td>1-9 \$201.38</td> </tr> <tr> <td>10-24 \$191.31</td> </tr> <tr> <td>25-49 \$181.24</td> </tr> <tr> <td>50+ \$173.19</td> </tr> </tbody> </table> <p>PRECISION <b>N Female to TNC Female</b> VSWR 1.15:1 to 18 GHz Model No: <a href="#">PE9449</a></p>	PRICE	1-9 \$201.38	10-24 \$191.31	25-49 \$181.24	50+ \$173.19
	PRICE																													
1-24 \$21.40																														
25-49 \$20.33																														
50-99 \$19.26																														
100+ \$18.40																														
PRICE																														
1-24 \$150.28																														
25-49 \$139.76																														
50-99 \$129.24																														
100+ \$120.22																														
PRICE																														
1-24 \$70.42																														
25-49 \$66.90																														
50-99 \$63.38																														
100+ \$60.56																														
PRICE																														
1-24 \$31.78																														
25-49 \$30.19																														
50-99 \$28.60																														
100+ \$27.33																														
PRICE																														
1-9 \$201.38																														
10-24 \$191.31																														
25-49 \$181.24																														
50+ \$173.19																														
2	 <table border="1"> <thead> <tr> <th>PRICE</th> </tr> </thead> <tbody> <tr> <td>1-24 \$96.08</td> </tr> <tr> <td>25-49 \$91.28</td> </tr> <tr> <td>50-99 \$86.47</td> </tr> <tr> <td>100+ \$82.63</td> </tr> </tbody> </table> <p><b>N Female to TNC Female 4 Hole Flange-Mounting Hole A05</b> Model No: <a href="#">PE9552</a></p>	PRICE	1-24 \$96.08	25-49 \$91.28	50-99 \$86.47	100+ \$82.63	 <table border="1"> <thead> <tr> <th>PRICE</th> </tr> </thead> <tbody> <tr> <td>1-24 \$51.66</td> </tr> <tr> <td>25-49 \$49.08</td> </tr> <tr> <td>50-99 \$46.49</td> </tr> <tr> <td>100+ \$44.43</td> </tr> </tbody> </table> <p><b>N Female to TNC Female Bulkhead</b> VSWR 1.35:1 to 10 GHz Model No: <a href="#">PE9482</a></p>	PRICE	1-24 \$51.66	25-49 \$49.08	50-99 \$46.49	100+ \$44.43	 <table border="1"> <thead> <tr> <th>PRICE</th> </tr> </thead> <tbody> <tr> <td>1-9 \$159.87</td> </tr> <tr> <td>10-24 \$151.88</td> </tr> <tr> <td>25-49 \$143.88</td> </tr> <tr> <td>50+ \$137.49</td> </tr> </tbody> </table> <p>PRECISION <b>N Female to TNC Female 4 Hole Flange-Mounting Hole A05</b> VSWR 1.15:1 to 18 GHz Model No: <a href="#">PE9450</a></p>	PRICE	1-9 \$159.87	10-24 \$151.88	25-49 \$143.88	50+ \$137.49	 <table border="1"> <thead> <tr> <th>PRICE</th> </tr> </thead> <tbody> <tr> <td>1-24 \$34.60</td> </tr> <tr> <td>25-49 \$32.87</td> </tr> <tr> <td>50-99 \$31.14</td> </tr> <tr> <td>100+ \$29.76</td> </tr> </tbody> </table> <p><b>N Female to UHF Male</b> VSWR 1.3:1 to 300 MHz Model No: <a href="#">PE9112</a></p>	PRICE	1-24 \$34.60	25-49 \$32.87	50-99 \$31.14	100+ \$29.76	 <table border="1"> <thead> <tr> <th>PRICE</th> </tr> </thead> <tbody> <tr> <td>1-24 \$41.19</td> </tr> <tr> <td>25-49 \$39.13</td> </tr> <tr> <td>50-99 \$37.07</td> </tr> <tr> <td>100+ \$35.42</td> </tr> </tbody> </table> <p><b>N Female to UHF Female</b> Max. Freq. 1,000 MHz Model No: <a href="#">PE9385</a></p>	PRICE	1-24 \$41.19	25-49 \$39.13	50-99 \$37.07	100+ \$35.42
	PRICE																													
1-24 \$96.08																														
25-49 \$91.28																														
50-99 \$86.47																														
100+ \$82.63																														
PRICE																														
1-24 \$51.66																														
25-49 \$49.08																														
50-99 \$46.49																														
100+ \$44.43																														
PRICE																														
1-9 \$159.87																														
10-24 \$151.88																														
25-49 \$143.88																														
50+ \$137.49																														
PRICE																														
1-24 \$34.60																														
25-49 \$32.87																														
50-99 \$31.14																														
100+ \$29.76																														
PRICE																														
1-24 \$41.19																														
25-49 \$39.13																														
50-99 \$37.07																														
100+ \$35.42																														
3	<p><b>Reverse Polarity N Between Series</b></p> <p>→</p>		 <table border="1"> <thead> <tr> <th>PRICE</th> </tr> </thead> <tbody> <tr> <td>1-24 \$52.47</td> </tr> <tr> <td>25-49 \$49.85</td> </tr> <tr> <td>50-99 \$47.22</td> </tr> <tr> <td>100+ \$45.12</td> </tr> </tbody> </table> <p><b>N Male to Rev. Pol. TNC Female</b> VSWR 1.3:1 to 6 GHz Model No: <a href="#">PE9730</a></p>	PRICE	1-24 \$52.47	25-49 \$49.85	50-99 \$47.22	100+ \$45.12	 <table border="1"> <thead> <tr> <th>PRICE</th> </tr> </thead> <tbody> <tr> <td>1-24 \$51.30</td> </tr> <tr> <td>25-49 \$48.74</td> </tr> <tr> <td>50-99 \$46.17</td> </tr> <tr> <td>100+ \$44.12</td> </tr> </tbody> </table> <p><b>N Female to Rev. Pol. TNC Male</b> Model No: <a href="#">PE9731</a></p>	PRICE	1-24 \$51.30	25-49 \$48.74	50-99 \$46.17	100+ \$44.12	<p><b>QMA In-Series</b></p> <p>→</p>	 <table border="1"> <thead> <tr> <th>PRICE</th> </tr> </thead> <tbody> <tr> <td>1-24 \$60.78</td> </tr> <tr> <td>25-49 \$57.74</td> </tr> <tr> <td>50-99 \$54.70</td> </tr> <tr> <td>100+ \$52.27</td> </tr> </tbody> </table> <p><b>Snap-On QMA Male to Snap-On QMA Male</b> VSWR 1.08:1 to 6 GHz Model No: <a href="#">PE91341</a></p>	PRICE	1-24 \$60.78	25-49 \$57.74	50-99 \$54.70	100+ \$52.27									
	PRICE																													
1-24 \$52.47																														
25-49 \$49.85																														
50-99 \$47.22																														
100+ \$45.12																														
PRICE																														
1-24 \$51.30																														
25-49 \$48.74																														
50-99 \$46.17																														
100+ \$44.12																														
PRICE																														
1-24 \$60.78																														
25-49 \$57.74																														
50-99 \$54.70																														
100+ \$52.27																														
4	 <table border="1"> <thead> <tr> <th>PRICE</th> </tr> </thead> <tbody> <tr> <td>1-24 \$36.89</td> </tr> <tr> <td>25-49 \$35.05</td> </tr> <tr> <td>50-99 \$33.20</td> </tr> <tr> <td>100+ \$31.73</td> </tr> </tbody> </table> <p><b>Snap-On QMA Male to Snap-On QMA Female</b> VSWR 1.12:1 to 6 GHz Model No: <a href="#">PE91342</a></p>	PRICE	1-24 \$36.89	25-49 \$35.05	50-99 \$33.20	100+ \$31.73	 <table border="1"> <thead> <tr> <th>PRICE</th> </tr> </thead> <tbody> <tr> <td>1-9 \$175.92</td> </tr> <tr> <td>10-24 \$167.12</td> </tr> <tr> <td>25-49 \$158.33</td> </tr> <tr> <td>50+ \$151.29</td> </tr> </tbody> </table> <p><b>Snap-On QMA Female to Snap-On QMA Female</b> VSWR 1.08:1 to 6 GHz Model No: <a href="#">PE91343</a></p>	PRICE	1-9 \$175.92	10-24 \$167.12	25-49 \$158.33	50+ \$151.29	<p><b>QMA Between Series</b></p> <p>→</p>		 <table border="1"> <thead> <tr> <th>PRICE</th> </tr> </thead> <tbody> <tr> <td>1-9 \$181.89</td> </tr> <tr> <td>10-24 \$172.80</td> </tr> <tr> <td>25-49 \$163.70</td> </tr> <tr> <td>50+ \$156.43</td> </tr> </tbody> </table> <p><b>Snap-On QMA Male to Snap-On SMA Male</b> VSWR 1.18:1 to 6 GHz Model No: <a href="#">PE91344</a></p>	PRICE	1-9 \$181.89	10-24 \$172.80	25-49 \$163.70	50+ \$156.43	 <table border="1"> <thead> <tr> <th>PRICE</th> </tr> </thead> <tbody> <tr> <td>1-24 \$65.57</td> </tr> <tr> <td>25-49 \$62.29</td> </tr> <tr> <td>50-99 \$59.01</td> </tr> <tr> <td>100+ \$56.39</td> </tr> </tbody> </table> <p><b>Snap-On QMA Male to SMA Female</b> VSWR 1.18:1 to 6 GHz Model No: <a href="#">PE91345</a></p>	PRICE	1-24 \$65.57	25-49 \$62.29	50-99 \$59.01	100+ \$56.39				
	PRICE																													
1-24 \$36.89																														
25-49 \$35.05																														
50-99 \$33.20																														
100+ \$31.73																														
PRICE																														
1-9 \$175.92																														
10-24 \$167.12																														
25-49 \$158.33																														
50+ \$151.29																														
PRICE																														
1-9 \$181.89																														
10-24 \$172.80																														
25-49 \$163.70																														
50+ \$156.43																														
PRICE																														
1-24 \$65.57																														
25-49 \$62.29																														
50-99 \$59.01																														
100+ \$56.39																														
5	 <table border="1"> <thead> <tr> <th>PRICE</th> </tr> </thead> <tbody> <tr> <td>1-24 \$52.09</td> </tr> <tr> <td>25-49 \$49.49</td> </tr> <tr> <td>50-99 \$46.88</td> </tr> <tr> <td>100+ \$44.80</td> </tr> </tbody> </table> <p><b>Snap-On QMA Female to SMA Male</b> VSWR 1.18:1 to 6 GHz Model No: <a href="#">PE91346</a></p>	PRICE	1-24 \$52.09	25-49 \$49.49	50-99 \$46.88	100+ \$44.80	 <table border="1"> <thead> <tr> <th>PRICE</th> </tr> </thead> <tbody> <tr> <td>1-9 \$111.59</td> </tr> <tr> <td>10-24 \$106.01</td> </tr> <tr> <td>25-49 \$100.43</td> </tr> <tr> <td>50+ \$95.97</td> </tr> </tbody> </table> <p><b>Snap-On QMA Female to Snap-On SMA Female</b> VSWR 1.18:1 to 6 GHz Model No: <a href="#">PE91347</a></p>	PRICE	1-9 \$111.59	10-24 \$106.01	25-49 \$100.43	50+ \$95.97	<p><b>SC In-Series</b></p> <p>→</p>		 <table border="1"> <thead> <tr> <th>PRICE</th> </tr> </thead> <tbody> <tr> <td>1-9 \$121.07</td> </tr> <tr> <td>10-24 \$115.02</td> </tr> <tr> <td>25-49 \$108.96</td> </tr> <tr> <td>50+ \$104.12</td> </tr> </tbody> </table> <p><b>SC Male to SC Male</b> Model No: <a href="#">PE9403</a></p>	PRICE	1-9 \$121.07	10-24 \$115.02	25-49 \$108.96	50+ \$104.12	 <table border="1"> <thead> <tr> <th>PRICE</th> </tr> </thead> <tbody> <tr> <td>1-24 \$90.62</td> </tr> <tr> <td>25-49 \$86.09</td> </tr> <tr> <td>50-99 \$81.56</td> </tr> <tr> <td>100+ \$77.93</td> </tr> </tbody> </table> <p><b>SC Male to SC Female</b> Model No: <a href="#">PE9572</a></p>	PRICE	1-24 \$90.62	25-49 \$86.09	50-99 \$81.56	100+ \$77.93				
	PRICE																													
1-24 \$52.09																														
25-49 \$49.49																														
50-99 \$46.88																														
100+ \$44.80																														
PRICE																														
1-9 \$111.59																														
10-24 \$106.01																														
25-49 \$100.43																														
50+ \$95.97																														
PRICE																														
1-9 \$121.07																														
10-24 \$115.02																														
25-49 \$108.96																														
50+ \$104.12																														
PRICE																														
1-24 \$90.62																														
25-49 \$86.09																														
50-99 \$81.56																														
100+ \$77.93																														
6	 <table border="1"> <thead> <tr> <th>PRICE</th> </tr> </thead> <tbody> <tr> <td>1-9 \$175.25</td> </tr> <tr> <td>10-24 \$166.49</td> </tr> <tr> <td>25-49 \$157.73</td> </tr> <tr> <td>50+ \$150.72</td> </tr> </tbody> </table> <p><b>SC Male to SC Female Right Angle</b> Model No: <a href="#">PE9405</a></p>	PRICE	1-9 \$175.25	10-24 \$166.49	25-49 \$157.73	50+ \$150.72	 <table border="1"> <thead> <tr> <th>PRICE</th> </tr> </thead> <tbody> <tr> <td>1-9 \$284.24</td> </tr> <tr> <td>10-24 \$270.03</td> </tr> <tr> <td>25-49 \$255.82</td> </tr> <tr> <td>50+ \$244.45</td> </tr> </tbody> </table> <p><b>SC Female to SC Male Tee</b> Model No: <a href="#">PE9225</a></p>	PRICE	1-9 \$284.24	10-24 \$270.03	25-49 \$255.82	50+ \$244.45	 <table border="1"> <thead> <tr> <th>PRICE</th> </tr> </thead> <tbody> <tr> <td>1-9 \$127.39</td> </tr> <tr> <td>10-24 \$121.02</td> </tr> <tr> <td>25-49 \$114.65</td> </tr> <tr> <td>50+ \$109.56</td> </tr> </tbody> </table> <p><b>SC Female to SC Female</b> VSWR 1.25:1 to 11 GHz Model No: <a href="#">PE9404</a></p>	PRICE	1-9 \$127.39	10-24 \$121.02	25-49 \$114.65	50+ \$109.56	 <table border="1"> <thead> <tr> <th>PRICE</th> </tr> </thead> <tbody> <tr> <td>1-9 \$163.82</td> </tr> <tr> <td>10-24 \$155.63</td> </tr> <tr> <td>25-49 \$147.44</td> </tr> <tr> <td>50+ \$140.89</td> </tr> </tbody> </table> <p><b>SC Female to SC Female Bulkhead</b> Model No: <a href="#">PE9573</a></p>	PRICE	1-9 \$163.82	10-24 \$155.63	25-49 \$147.44	50+ \$140.89	<p><b>SC Between Series</b></p> <p>→</p>					
	PRICE																													
1-9 \$175.25																														
10-24 \$166.49																														
25-49 \$157.73																														
50+ \$150.72																														
PRICE																														
1-9 \$284.24																														
10-24 \$270.03																														
25-49 \$255.82																														
50+ \$244.45																														
PRICE																														
1-9 \$127.39																														
10-24 \$121.02																														
25-49 \$114.65																														
50+ \$109.56																														
PRICE																														
1-9 \$163.82																														
10-24 \$155.63																														
25-49 \$147.44																														
50+ \$140.89																														
7	 <table border="1"> <thead> <tr> <th>PRICE</th> </tr> </thead> <tbody> <tr> <td>1-24 \$61.07</td> </tr> <tr> <td>25-49 \$58.02</td> </tr> <tr> <td>50-99 \$54.96</td> </tr> <tr> <td>100+ \$52.52</td> </tr> </tbody> </table> <p><b>SC Male to BNC Male</b> Model No: <a href="#">PE9568</a></p>	PRICE	1-24 \$61.07	25-49 \$58.02	50-99 \$54.96	100+ \$52.52	 <table border="1"> <thead> <tr> <th>PRICE</th> </tr> </thead> <tbody> <tr> <td>1-24 \$81.97</td> </tr> <tr> <td>25-49 \$77.87</td> </tr> <tr> <td>50-99 \$73.77</td> </tr> <tr> <td>100+ \$70.49</td> </tr> </tbody> </table> <p><b>SC Female to BNC Female</b> Model No: <a href="#">PE9571</a></p>	PRICE	1-24 \$81.97	25-49 \$77.87	50-99 \$73.77	100+ \$70.49	<p><b>SHV In-Series</b></p> <p>→</p>		 <table border="1"> <thead> <tr> <th>PRICE</th> </tr> </thead> <tbody> <tr> <td>1-9 \$137.84</td> </tr> <tr> <td>10-24 \$130.95</td> </tr> <tr> <td>25-49 \$124.06</td> </tr> <tr> <td>50+ \$118.54</td> </tr> </tbody> </table> <p><b>SHV Plug to SHV Jack</b> Model No: <a href="#">PE9749</a></p>	PRICE	1-9 \$137.84	10-24 \$130.95	25-49 \$124.06	50+ \$118.54	 <table border="1"> <thead> <tr> <th>PRICE</th> </tr> </thead> <tbody> <tr> <td>1-24 \$89.96</td> </tr> <tr> <td>25-49 \$85.46</td> </tr> <tr> <td>50-99 \$80.96</td> </tr> <tr> <td>100+ \$77.37</td> </tr> </tbody> </table> <p><b>SHV Plug to SHV Jack Right Angle</b> Model No: <a href="#">PE9338</a></p>	PRICE	1-24 \$89.96	25-49 \$85.46	50-99 \$80.96	100+ \$77.37				
	PRICE																													
1-24 \$61.07																														
25-49 \$58.02																														
50-99 \$54.96																														
100+ \$52.52																														
PRICE																														
1-24 \$81.97																														
25-49 \$77.87																														
50-99 \$73.77																														
100+ \$70.49																														
PRICE																														
1-9 \$137.84																														
10-24 \$130.95																														
25-49 \$124.06																														
50+ \$118.54																														
PRICE																														
1-24 \$89.96																														
25-49 \$85.46																														
50-99 \$80.96																														
100+ \$77.37																														



Technical Support  
+1 (949) 261-1920



Same-Day Shipping,  
Even Custom Cable Assemblies

# ADAPTERS

See Adapter Locator on Pages 10-15  
See Page 409 for Mounting Holes



Adapters

See Our Website For Current Pricing & Real-Time Stock Availability!

	A	B	C	D	E																																																		
1	 <table border="1"> <thead> <tr><th colspan="2">PRICE</th></tr> </thead> <tbody> <tr><td>1-24</td><td>\$104.33</td></tr> <tr><td>25-49</td><td>\$99.11</td></tr> <tr><td>50-99</td><td>\$93.90</td></tr> <tr><td>100+</td><td>\$89.72</td></tr> </tbody> </table> <p>SHV Jack to SHV Plug Tee VSWR 1.2:1 to 300 MHz</p> <p>Model No: <a href="#">PE9249</a></p>	PRICE		1-24	\$104.33	25-49	\$99.11	50-99	\$93.90	100+	\$89.72	 <table border="1"> <thead> <tr><th colspan="2">PRICE</th></tr> </thead> <tbody> <tr><td>1-24</td><td>\$46.18</td></tr> <tr><td>25-49</td><td>\$43.87</td></tr> <tr><td>50-99</td><td>\$41.56</td></tr> <tr><td>100+</td><td>\$39.71</td></tr> </tbody> </table> <p>SHV Jack to SHV Jack VSWR 1.3:1 to 300 MHz</p> <p>Model No: <a href="#">PE9337</a></p>	PRICE		1-24	\$46.18	25-49	\$43.87	50-99	\$41.56	100+	\$39.71	 <table border="1"> <thead> <tr><th colspan="2">PRICE</th></tr> </thead> <tbody> <tr><td>1-24</td><td>\$70.37</td></tr> <tr><td>25-49</td><td>\$66.85</td></tr> <tr><td>50-99</td><td>\$63.33</td></tr> <tr><td>100+</td><td>\$60.52</td></tr> </tbody> </table> <p>SHV Jack to SHV Jack Bulkhead Max. Freq. 300 MHz</p> <p>Model No: <a href="#">PE9336</a></p>	PRICE		1-24	\$70.37	25-49	\$66.85	50-99	\$63.33	100+	\$60.52	<div style="text-align: center;"> <p><b>SMA In-Series</b></p>  </div>	 <table border="1"> <thead> <tr><th colspan="2">PRICE</th></tr> </thead> <tbody> <tr><td>1-24</td><td>\$19.29</td></tr> <tr><td>25-49</td><td>\$18.33</td></tr> <tr><td>50-99</td><td>\$17.36</td></tr> <tr><td>100+</td><td>\$16.59</td></tr> </tbody> </table> <p>SMA Male to SMA Male VSWR 1.23:1 to 18 GHz</p> <p>Model No: <a href="#">PE91135</a></p>	PRICE		1-24	\$19.29	25-49	\$18.33	50-99	\$17.36	100+	\$16.59										
	PRICE																																																						
1-24	\$104.33																																																						
25-49	\$99.11																																																						
50-99	\$93.90																																																						
100+	\$89.72																																																						
PRICE																																																							
1-24	\$46.18																																																						
25-49	\$43.87																																																						
50-99	\$41.56																																																						
100+	\$39.71																																																						
PRICE																																																							
1-24	\$70.37																																																						
25-49	\$66.85																																																						
50-99	\$63.33																																																						
100+	\$60.52																																																						
PRICE																																																							
1-24	\$19.29																																																						
25-49	\$18.33																																																						
50-99	\$17.36																																																						
100+	\$16.59																																																						
2	 <table border="1"> <thead> <tr><th colspan="2">PRICE</th></tr> </thead> <tbody> <tr><td>1-24</td><td>\$74.01</td></tr> <tr><td>25-49</td><td>\$70.31</td></tr> <tr><td>50-99</td><td>\$66.61</td></tr> <tr><td>100+</td><td>\$63.65</td></tr> </tbody> </table> <p>PRECISION SMA Male to SMA Male VSWR 1.2:1 to 27 GHz</p> <p>Model No: <a href="#">PE9505</a></p>	PRICE		1-24	\$74.01	25-49	\$70.31	50-99	\$66.61	100+	\$63.65	 <table border="1"> <thead> <tr><th colspan="2">PRICE</th></tr> </thead> <tbody> <tr><td>1-24</td><td>\$81.98</td></tr> <tr><td>25-49</td><td>\$77.88</td></tr> <tr><td>50-99</td><td>\$73.78</td></tr> <tr><td>NEW 100+</td><td>\$70.50</td></tr> </tbody> </table> <p>NEW SMA Male to SMA Male Radius Right Angle VSWR 1.35:1 to 26 GHz</p> <p>Model No: <a href="#">PE91496</a></p>	PRICE		1-24	\$81.98	25-49	\$77.88	50-99	\$73.78	NEW 100+	\$70.50	 <table border="1"> <thead> <tr><th colspan="2">PRICE</th></tr> </thead> <tbody> <tr><td>1-24</td><td>\$83.73</td></tr> <tr><td>25-49</td><td>\$79.54</td></tr> <tr><td>50-99</td><td>\$75.36</td></tr> <tr><td>NEW 100+</td><td>\$72.01</td></tr> </tbody> </table> <p>NEW SMA Male to SMA Male Radius Right Angle VSWR 1.35:1 to 26 GHz</p> <p>Model No: <a href="#">PE91497</a></p>	PRICE		1-24	\$83.73	25-49	\$79.54	50-99	\$75.36	NEW 100+	\$72.01	 <table border="1"> <thead> <tr><th colspan="2">PRICE</th></tr> </thead> <tbody> <tr><td>1-24</td><td>\$54.33</td></tr> <tr><td>25-49</td><td>\$51.61</td></tr> <tr><td>50-99</td><td>\$48.90</td></tr> <tr><td>100+</td><td>\$46.72</td></tr> </tbody> </table> <p>SMA Male to SMA Male Right Angle VSWR 1.5:1 to 12.4 GHz</p> <p>Model No: <a href="#">PE9418</a></p>	PRICE		1-24	\$54.33	25-49	\$51.61	50-99	\$48.90	100+	\$46.72	 <table border="1"> <thead> <tr><th colspan="2">PRICE</th></tr> </thead> <tbody> <tr><td>1-24</td><td>\$85.79</td></tr> <tr><td>25-49</td><td>\$81.50</td></tr> <tr><td>50-99</td><td>\$77.21</td></tr> <tr><td>100+</td><td>\$73.78</td></tr> </tbody> </table> <p>SMA Male to SMA Male Tee</p> <p>Model No: <a href="#">PE9379</a></p>	PRICE		1-24	\$85.79	25-49	\$81.50	50-99	\$77.21	100+	\$73.78
	PRICE																																																						
1-24	\$74.01																																																						
25-49	\$70.31																																																						
50-99	\$66.61																																																						
100+	\$63.65																																																						
PRICE																																																							
1-24	\$81.98																																																						
25-49	\$77.88																																																						
50-99	\$73.78																																																						
NEW 100+	\$70.50																																																						
PRICE																																																							
1-24	\$83.73																																																						
25-49	\$79.54																																																						
50-99	\$75.36																																																						
NEW 100+	\$72.01																																																						
PRICE																																																							
1-24	\$54.33																																																						
25-49	\$51.61																																																						
50-99	\$48.90																																																						
100+	\$46.72																																																						
PRICE																																																							
1-24	\$85.79																																																						
25-49	\$81.50																																																						
50-99	\$77.21																																																						
100+	\$73.78																																																						
3	 <table border="1"> <thead> <tr><th colspan="2">PRICE</th></tr> </thead> <tbody> <tr><td>1-24</td><td>\$105.22</td></tr> <tr><td>25-49</td><td>\$99.96</td></tr> <tr><td>50-99</td><td>\$94.70</td></tr> <tr><td>100+</td><td>\$90.49</td></tr> </tbody> </table> <p>PRECISION SMA Male to SMA Male Miter Right Angle VSWR 1.15:1 to 27 GHz</p> <p>Model No: <a href="#">PE91151</a></p>	PRICE		1-24	\$105.22	25-49	\$99.96	50-99	\$94.70	100+	\$90.49	 <table border="1"> <thead> <tr><th colspan="2">PRICE</th></tr> </thead> <tbody> <tr><td>1-24</td><td>\$94.56</td></tr> <tr><td>25-49</td><td>\$89.83</td></tr> <tr><td>50-99</td><td>\$85.10</td></tr> <tr><td>100+</td><td>\$81.32</td></tr> </tbody> </table> <p>SMA Male to SMA Male Miter Right Angle VSWR 1.35:1 to 27 GHz</p> <p>Model No: <a href="#">PE9642</a></p>	PRICE		1-24	\$94.56	25-49	\$89.83	50-99	\$85.10	100+	\$81.32	 <table border="1"> <thead> <tr><th colspan="2">PRICE</th></tr> </thead> <tbody> <tr><td>1-9</td><td>\$221.64</td></tr> <tr><td>10-24</td><td>\$212.77</td></tr> <tr><td>25-49</td><td>\$206.13</td></tr> <tr><td>50+</td><td>\$201.69</td></tr> </tbody> </table> <p>SMA Male to SMA Male 4 Hole Flange-Mounting Hole A01 VSWR 1.2:1 to 18 GHz</p> <p>Model No: <a href="#">PE9669</a></p>	PRICE		1-9	\$221.64	10-24	\$212.77	25-49	\$206.13	50+	\$201.69	 <table border="1"> <thead> <tr><th colspan="2">PRICE</th></tr> </thead> <tbody> <tr><td>1-24</td><td>\$33.57</td></tr> <tr><td>25-49</td><td>\$31.89</td></tr> <tr><td>50-99</td><td>\$30.21</td></tr> <tr><td>NEW 100+</td><td>\$28.87</td></tr> </tbody> </table> <p>SMA Male to SMA Male VSWR 1.2:1 to 27 GHz</p> <p>Model No: <a href="#">PE91535</a></p>	PRICE		1-24	\$33.57	25-49	\$31.89	50-99	\$30.21	NEW 100+	\$28.87	 <table border="1"> <thead> <tr><th colspan="2">PRICE</th></tr> </thead> <tbody> <tr><td>1-24</td><td>\$28.29</td></tr> <tr><td>25-49</td><td>\$26.88</td></tr> <tr><td>50-99</td><td>\$25.46</td></tr> <tr><td>100+</td><td>\$24.33</td></tr> </tbody> </table> <p>SMA Male to SMA Female VSWR 1.25:1 to 18 GHz</p> <p>Model No: <a href="#">PE9103</a></p>	PRICE		1-24	\$28.29	25-49	\$26.88	50-99	\$25.46	100+	\$24.33
	PRICE																																																						
1-24	\$105.22																																																						
25-49	\$99.96																																																						
50-99	\$94.70																																																						
100+	\$90.49																																																						
PRICE																																																							
1-24	\$94.56																																																						
25-49	\$89.83																																																						
50-99	\$85.10																																																						
100+	\$81.32																																																						
PRICE																																																							
1-9	\$221.64																																																						
10-24	\$212.77																																																						
25-49	\$206.13																																																						
50+	\$201.69																																																						
PRICE																																																							
1-24	\$33.57																																																						
25-49	\$31.89																																																						
50-99	\$30.21																																																						
NEW 100+	\$28.87																																																						
PRICE																																																							
1-24	\$28.29																																																						
25-49	\$26.88																																																						
50-99	\$25.46																																																						
100+	\$24.33																																																						
4	 <table border="1"> <thead> <tr><th colspan="2">PRICE</th></tr> </thead> <tbody> <tr><td>1-24</td><td>\$63.16</td></tr> <tr><td>25-49</td><td>\$58.74</td></tr> <tr><td>50-99</td><td>\$54.32</td></tr> <tr><td>PRECISION NEW 100+</td><td>\$50.53</td></tr> </tbody> </table> <p>PRECISION SMA Male to SMA Female VSWR 1.2:1 to 27 GHz</p> <p>Model No: <a href="#">PE9506</a></p>	PRICE		1-24	\$63.16	25-49	\$58.74	50-99	\$54.32	PRECISION NEW 100+	\$50.53	 <table border="1"> <thead> <tr><th colspan="2">PRICE</th></tr> </thead> <tbody> <tr><td>1-24</td><td>\$32.00</td></tr> <tr><td>25-49</td><td>\$30.40</td></tr> <tr><td>50-99</td><td>\$28.80</td></tr> <tr><td>100+</td><td>\$27.52</td></tr> </tbody> </table> <p>QD SMA Male to SMA Female</p> <p>Model No: <a href="#">PE9546</a></p>	PRICE		1-24	\$32.00	25-49	\$30.40	50-99	\$28.80	100+	\$27.52	 <table border="1"> <thead> <tr><th colspan="2">PRICE</th></tr> </thead> <tbody> <tr><td>1-24</td><td>\$53.31</td></tr> <tr><td>25-49</td><td>\$50.64</td></tr> <tr><td>50-99</td><td>\$47.98</td></tr> <tr><td>PRECISION 100+</td><td>\$45.85</td></tr> </tbody> </table> <p>PRECISION SMA Male to SMA Female VSWR 1.2:1 to 18 GHz</p> <p>Model No: <a href="#">PE9694</a></p>	PRICE		1-24	\$53.31	25-49	\$50.64	50-99	\$47.98	PRECISION 100+	\$45.85	 <table border="1"> <thead> <tr><th colspan="2">PRICE</th></tr> </thead> <tbody> <tr><td>1-9</td><td>\$149.17</td></tr> <tr><td>10-24</td><td>\$141.71</td></tr> <tr><td>25-49</td><td>\$134.25</td></tr> <tr><td>PRECISION 50+</td><td>\$128.29</td></tr> </tbody> </table> <p>PRECISION QD SMA Male to SMA Female VSWR 1.14:1 to 18 GHz</p> <p>Model No: <a href="#">PE9774</a></p>	PRICE		1-9	\$149.17	10-24	\$141.71	25-49	\$134.25	PRECISION 50+	\$128.29	 <table border="1"> <thead> <tr><th colspan="2">PRICE</th></tr> </thead> <tbody> <tr><td>1-24</td><td>\$59.11</td></tr> <tr><td>25-49</td><td>\$56.15</td></tr> <tr><td>50-99</td><td>\$53.20</td></tr> <tr><td>100+</td><td>\$50.83</td></tr> </tbody> </table> <p>SMA Male to SMA Female Radius Right Angle VSWR 1.2:1 to 18 GHz</p> <p>Model No: <a href="#">PE91492</a></p>	PRICE		1-24	\$59.11	25-49	\$56.15	50-99	\$53.20	100+	\$50.83
	PRICE																																																						
1-24	\$63.16																																																						
25-49	\$58.74																																																						
50-99	\$54.32																																																						
PRECISION NEW 100+	\$50.53																																																						
PRICE																																																							
1-24	\$32.00																																																						
25-49	\$30.40																																																						
50-99	\$28.80																																																						
100+	\$27.52																																																						
PRICE																																																							
1-24	\$53.31																																																						
25-49	\$50.64																																																						
50-99	\$47.98																																																						
PRECISION 100+	\$45.85																																																						
PRICE																																																							
1-9	\$149.17																																																						
10-24	\$141.71																																																						
25-49	\$134.25																																																						
PRECISION 50+	\$128.29																																																						
PRICE																																																							
1-24	\$59.11																																																						
25-49	\$56.15																																																						
50-99	\$53.20																																																						
100+	\$50.83																																																						
5	 <table border="1"> <thead> <tr><th colspan="2">PRICE</th></tr> </thead> <tbody> <tr><td>1-24</td><td>\$62.16</td></tr> <tr><td>25-49</td><td>\$59.05</td></tr> <tr><td>50-99</td><td>\$55.94</td></tr> <tr><td>100+</td><td>\$53.46</td></tr> </tbody> </table> <p>SMA Male to SMA Female Radius Right Angle VSWR 1.2:1 to 18 GHz</p> <p>Model No: <a href="#">PE91493</a></p>	PRICE		1-24	\$62.16	25-49	\$59.05	50-99	\$55.94	100+	\$53.46	 <table border="1"> <thead> <tr><th colspan="2">PRICE</th></tr> </thead> <tbody> <tr><td>1</td><td>\$89.31</td></tr> </tbody> </table> <p>SMA Male to SMA Female Radius Right Angle VSWR 1.25:1 to 18 GHz</p> <p>Model No: <a href="#">PE91155</a></p>	PRICE		1	\$89.31	 <table border="1"> <thead> <tr><th colspan="2">PRICE</th></tr> </thead> <tbody> <tr><td>1-24</td><td>\$78.82</td></tr> <tr><td>25-49</td><td>\$74.88</td></tr> <tr><td>50-99</td><td>\$70.94</td></tr> <tr><td>100+</td><td>\$67.79</td></tr> </tbody> </table> <p>SMA Male to SMA Female Radius Right Angle VSWR 1.55:1 to 26.5 GHz</p> <p>Model No: <a href="#">PE91222</a></p>	PRICE		1-24	\$78.82	25-49	\$74.88	50-99	\$70.94	100+	\$67.79	 <table border="1"> <thead> <tr><th colspan="2">PRICE</th></tr> </thead> <tbody> <tr><td>1-24</td><td>\$31.77</td></tr> <tr><td>25-49</td><td>\$30.18</td></tr> <tr><td>50-99</td><td>\$28.59</td></tr> <tr><td>100+</td><td>\$27.32</td></tr> </tbody> </table> <p>SMA Male to SMA Female Right Angle VSWR 1.23:1 to 12.4 GHz</p> <p>Model No: <a href="#">PE9068</a></p>	PRICE		1-24	\$31.77	25-49	\$30.18	50-99	\$28.59	100+	\$27.32	 <table border="1"> <thead> <tr><th colspan="2">PRICE</th></tr> </thead> <tbody> <tr><td>1-24</td><td>\$99.91</td></tr> <tr><td>25-49</td><td>\$94.91</td></tr> <tr><td>50-99</td><td>\$89.92</td></tr> <tr><td>PRECISION 100+</td><td>\$85.92</td></tr> </tbody> </table> <p>PRECISION SMA Male to SMA Female 45 Degree Right VSWR 1.3:1 to 27 GHz</p> <p>Model No: <a href="#">PE91332</a></p>	PRICE		1-24	\$99.91	25-49	\$94.91	50-99	\$89.92	PRECISION 100+	\$85.92						
	PRICE																																																						
1-24	\$62.16																																																						
25-49	\$59.05																																																						
50-99	\$55.94																																																						
100+	\$53.46																																																						
PRICE																																																							
1	\$89.31																																																						
PRICE																																																							
1-24	\$78.82																																																						
25-49	\$74.88																																																						
50-99	\$70.94																																																						
100+	\$67.79																																																						
PRICE																																																							
1-24	\$31.77																																																						
25-49	\$30.18																																																						
50-99	\$28.59																																																						
100+	\$27.32																																																						
PRICE																																																							
1-24	\$99.91																																																						
25-49	\$94.91																																																						
50-99	\$89.92																																																						
PRECISION 100+	\$85.92																																																						
6	 <table border="1"> <thead> <tr><th colspan="2">PRICE</th></tr> </thead> <tbody> <tr><td>1-24</td><td>\$85.64</td></tr> <tr><td>25-49</td><td>\$81.36</td></tr> <tr><td>50-99</td><td>\$77.08</td></tr> <tr><td>100+</td><td>\$73.65</td></tr> </tbody> </table> <p>SMA Male to SMA Female Tee VSWR 2.25:1 to 6 GHz</p> <p>Model No: <a href="#">PE9247</a></p>	PRICE		1-24	\$85.64	25-49	\$81.36	50-99	\$77.08	100+	\$73.65	 <table border="1"> <thead> <tr><th colspan="2">PRICE</th></tr> </thead> <tbody> <tr><td>1-24</td><td>\$55.77</td></tr> <tr><td>25-49</td><td>\$52.98</td></tr> <tr><td>50-99</td><td>\$50.19</td></tr> <tr><td>100+</td><td>\$47.96</td></tr> </tbody> </table> <p>SMA Male to SMA Female Bulkhead VSWR 1.3:1 to 18 GHz</p> <p>Model No: <a href="#">PE9621</a></p>	PRICE		1-24	\$55.77	25-49	\$52.98	50-99	\$50.19	100+	\$47.96	 <table border="1"> <thead> <tr><th colspan="2">PRICE</th></tr> </thead> <tbody> <tr><td>1-24</td><td>\$83.81</td></tr> <tr><td>25-49</td><td>\$77.94</td></tr> <tr><td>50-99</td><td>\$72.08</td></tr> <tr><td>NEW 100+</td><td>\$67.05</td></tr> </tbody> </table> <p>SMA Male to SMA Female 4 Hole Flange VSWR 1.2:1 to 18 GHz</p> <p>Model No: <a href="#">PE91453</a></p>	PRICE		1-24	\$83.81	25-49	\$77.94	50-99	\$72.08	NEW 100+	\$67.05	 <table border="1"> <thead> <tr><th colspan="2">PRICE</th></tr> </thead> <tbody> <tr><td>1-24</td><td>\$27.66</td></tr> <tr><td>25-49</td><td>\$26.28</td></tr> <tr><td>50-99</td><td>\$24.89</td></tr> <tr><td>100+</td><td>\$23.79</td></tr> </tbody> </table> <p>Push-On SMA Male to SMA Female Bulkhead VSWR 1.23:1 to 18 GHz</p> <p>Model No: <a href="#">PE91321</a></p>	PRICE		1-24	\$27.66	25-49	\$26.28	50-99	\$24.89	100+	\$23.79	 <table border="1"> <thead> <tr><th colspan="2">PRICE</th></tr> </thead> <tbody> <tr><td>1-24</td><td>\$69.84</td></tr> <tr><td>25-49</td><td>\$66.35</td></tr> <tr><td>50-99</td><td>\$62.86</td></tr> <tr><td>PRECISION 100+</td><td>\$60.06</td></tr> </tbody> </table> <p>PRECISION SMA Male to SMA Female Miter Right Angle VSWR 1.2:1 to 27 GHz</p> <p>Model No: <a href="#">PE91504</a></p>	PRICE		1-24	\$69.84	25-49	\$66.35	50-99	\$62.86	PRECISION 100+	\$60.06
	PRICE																																																						
1-24	\$85.64																																																						
25-49	\$81.36																																																						
50-99	\$77.08																																																						
100+	\$73.65																																																						
PRICE																																																							
1-24	\$55.77																																																						
25-49	\$52.98																																																						
50-99	\$50.19																																																						
100+	\$47.96																																																						
PRICE																																																							
1-24	\$83.81																																																						
25-49	\$77.94																																																						
50-99	\$72.08																																																						
NEW 100+	\$67.05																																																						
PRICE																																																							
1-24	\$27.66																																																						
25-49	\$26.28																																																						
50-99	\$24.89																																																						
100+	\$23.79																																																						
PRICE																																																							
1-24	\$69.84																																																						
25-49	\$66.35																																																						
50-99	\$62.86																																																						
PRECISION 100+	\$60.06																																																						
7	 <table border="1"> <thead> <tr><th colspan="2">PRICE</th></tr> </thead> <tbody> <tr><td>1-24</td><td>\$50.29</td></tr> <tr><td>25-49</td><td>\$47.78</td></tr> <tr><td>50-99</td><td>\$45.26</td></tr> <tr><td>100+</td><td>\$43.25</td></tr> </tbody> </table> <p>SMA Female to SMA Male Tee Max. Freq. 6 GHz</p> <p>Model No: <a href="#">PE9182</a></p>	PRICE		1-24	\$50.29	25-49	\$47.78	50-99	\$45.26	100+	\$43.25	 <table border="1"> <thead> <tr><th colspan="2">PRICE</th></tr> </thead> <tbody> <tr><td>1-24</td><td>\$19.14</td></tr> <tr><td>25-49</td><td>\$18.18</td></tr> <tr><td>50-99</td><td>\$17.23</td></tr> <tr><td>100+</td><td>\$16.46</td></tr> </tbody> </table> <p>SMA Female to SMA Female VSWR 1.25:1 to 18 GHz</p> <p>Model No: <a href="#">PE9070</a></p>	PRICE		1-24	\$19.14	25-49	\$18.18	50-99	\$17.23	100+	\$16.46	 <table border="1"> <thead> <tr><th colspan="2">PRICE</th></tr> </thead> <tbody> <tr><td>1-24</td><td>\$34.76</td></tr> <tr><td>25-49</td><td>\$33.02</td></tr> <tr><td>50-99</td><td>\$31.28</td></tr> <tr><td>100+</td><td>\$29.89</td></tr> </tbody> </table> <p>SMA Female to SMA Female VSWR 1.23:1 to 18 GHz</p> <p>Model No: <a href="#">PE9380</a></p>	PRICE		1-24	\$34.76	25-49	\$33.02	50-99	\$31.28	100+	\$29.89	 <table border="1"> <thead> <tr><th colspan="2">PRICE</th></tr> </thead> <tbody> <tr><td>1-24</td><td>\$65.03</td></tr> <tr><td>25-49</td><td>\$61.78</td></tr> <tr><td>50-99</td><td>\$58.53</td></tr> <tr><td>PRECISION 100+</td><td>\$55.93</td></tr> </tbody> </table> <p>PRECISION SMA Female to SMA Female VSWR 1.2:1 to 27 GHz</p> <p>Model No: <a href="#">PE9507</a></p>	PRICE		1-24	\$65.03	25-49	\$61.78	50-99	\$58.53	PRECISION 100+	\$55.93	 <table border="1"> <thead> <tr><th colspan="2">PRICE</th></tr> </thead> <tbody> <tr><td>1-24</td><td>\$46.39</td></tr> <tr><td>25-49</td><td>\$44.07</td></tr> <tr><td>50-99</td><td>\$41.75</td></tr> <tr><td>PRECISION 100+</td><td>\$39.90</td></tr> </tbody> </table> <p>PRECISION SMA Female to SMA Female VSWR 1.15:1 to 18 GHz</p> <p>Model No: <a href="#">PE9695</a></p>	PRICE		1-24	\$46.39	25-49	\$44.07	50-99	\$41.75	PRECISION 100+	\$39.90
	PRICE																																																						
1-24	\$50.29																																																						
25-49	\$47.78																																																						
50-99	\$45.26																																																						
100+	\$43.25																																																						
PRICE																																																							
1-24	\$19.14																																																						
25-49	\$18.18																																																						
50-99	\$17.23																																																						
100+	\$16.46																																																						
PRICE																																																							
1-24	\$34.76																																																						
25-49	\$33.02																																																						
50-99	\$31.28																																																						
100+	\$29.89																																																						
PRICE																																																							
1-24	\$65.03																																																						
25-49	\$61.78																																																						
50-99	\$58.53																																																						
PRECISION 100+	\$55.93																																																						
PRICE																																																							
1-24	\$46.39																																																						
25-49	\$44.07																																																						
50-99	\$41.75																																																						
PRECISION 100+	\$39.90																																																						

# ADAPTERS

See Adapter Locator on Pages 10-15  
See Page 409 for Mounting Holes

	A	B	C	D	E																																													
1	 <table border="1"> <thead> <tr><th>PRICE</th></tr> </thead> <tbody> <tr><td>1-24</td><td>\$82.56</td></tr> <tr><td>25-49</td><td>\$78.43</td></tr> <tr><td>50-99</td><td>\$74.30</td></tr> <tr><td>NEW 100+</td><td>\$71.00</td></tr> </tbody> </table> <p>SMA Female to SMA Female Radius Right Angle VSWR 1.25:1 to 18 GHz</p> <p>Model No: <a href="#">PE91494</a></p>	PRICE	1-24	\$82.56	25-49	\$78.43	50-99	\$74.30	NEW 100+	\$71.00	 <table border="1"> <thead> <tr><th>PRICE</th></tr> </thead> <tbody> <tr><td>1-24</td><td>\$84.73</td></tr> <tr><td>25-49</td><td>\$80.49</td></tr> <tr><td>50-99</td><td>\$76.26</td></tr> <tr><td>NEW 100+</td><td>\$72.87</td></tr> </tbody> </table> <p>SMA Female to SMA Female Radius Right Angle VSWR 1.25:1 to 18 GHz</p> <p>Model No: <a href="#">PE91495</a></p>	PRICE	1-24	\$84.73	25-49	\$80.49	50-99	\$76.26	NEW 100+	\$72.87	 <table border="1"> <thead> <tr><th>PRICE</th></tr> </thead> <tbody> <tr><td>1-24</td><td>\$97.68</td></tr> <tr><td>25-49</td><td>\$90.84</td></tr> <tr><td>50-99</td><td>\$84.00</td></tr> <tr><td>PRECISION NEW 100+</td><td>\$78.14</td></tr> </tbody> </table> <p>SMA Female to SMA Female Right Angle VSWR 1.15:1 to 27 GHz</p> <p>Model No: <a href="#">PE91153</a></p>	PRICE	1-24	\$97.68	25-49	\$90.84	50-99	\$84.00	PRECISION NEW 100+	\$78.14	 <table border="1"> <thead> <tr><th>PRICE</th></tr> </thead> <tbody> <tr><td>1-24</td><td>\$61.31</td></tr> <tr><td>25-49</td><td>\$58.24</td></tr> <tr><td>50-99</td><td>\$55.18</td></tr> <tr><td>100+</td><td>\$52.73</td></tr> </tbody> </table> <p>SMA Female to SMA Female Right Angle</p> <p>Model No: <a href="#">PE9485</a></p>	PRICE	1-24	\$61.31	25-49	\$58.24	50-99	\$55.18	100+	\$52.73	 <table border="1"> <thead> <tr><th>PRICE</th></tr> </thead> <tbody> <tr><td>1-24</td><td>\$69.03</td></tr> <tr><td>25-49</td><td>\$65.58</td></tr> <tr><td>50-99</td><td>\$62.13</td></tr> <tr><td>100+</td><td>\$59.37</td></tr> </tbody> </table> <p>SMA Female to SMA Female Tee Max. Freq. 6 GHz</p> <p>Model No: <a href="#">PE9246</a></p>	PRICE	1-24	\$69.03	25-49	\$65.58	50-99	\$62.13	100+	\$59.37
	PRICE																																																	
1-24	\$82.56																																																	
25-49	\$78.43																																																	
50-99	\$74.30																																																	
NEW 100+	\$71.00																																																	
PRICE																																																		
1-24	\$84.73																																																	
25-49	\$80.49																																																	
50-99	\$76.26																																																	
NEW 100+	\$72.87																																																	
PRICE																																																		
1-24	\$97.68																																																	
25-49	\$90.84																																																	
50-99	\$84.00																																																	
PRECISION NEW 100+	\$78.14																																																	
PRICE																																																		
1-24	\$61.31																																																	
25-49	\$58.24																																																	
50-99	\$55.18																																																	
100+	\$52.73																																																	
PRICE																																																		
1-24	\$69.03																																																	
25-49	\$65.58																																																	
50-99	\$62.13																																																	
100+	\$59.37																																																	
2	 <table border="1"> <thead> <tr><th>PRICE</th></tr> </thead> <tbody> <tr><td>1-24</td><td>\$64.73</td></tr> <tr><td>25-49</td><td>\$61.49</td></tr> <tr><td>50-99</td><td>\$58.26</td></tr> <tr><td>100+</td><td>\$55.67</td></tr> </tbody> </table> <p>SMA Female to SMA Female Bulkhead-Mounting Hole B02 VSWR 1.23:1 to 18 GHz</p> <p>Model No: <a href="#">PE9014</a></p>	PRICE	1-24	\$64.73	25-49	\$61.49	50-99	\$58.26	100+	\$55.67	 <table border="1"> <thead> <tr><th>PRICE</th></tr> </thead> <tbody> <tr><td>1-24</td><td>\$20.50</td></tr> <tr><td>25-49</td><td>\$19.48</td></tr> <tr><td>50-99</td><td>\$18.45</td></tr> <tr><td>100+</td><td>\$17.63</td></tr> </tbody> </table> <p>SMA Female to SMA Female Bulkhead VSWR 1.25:1 to 18 GHz</p> <p>Model No: <a href="#">PE91258</a></p>	PRICE	1-24	\$20.50	25-49	\$19.48	50-99	\$18.45	100+	\$17.63	 <table border="1"> <thead> <tr><th>PRICE</th></tr> </thead> <tbody> <tr><td>1-9</td><td>\$113.12</td></tr> <tr><td>10-24</td><td>\$107.46</td></tr> <tr><td>25-49</td><td>\$101.81</td></tr> <tr><td>50+</td><td>\$97.28</td></tr> </tbody> </table> <p>SMA Female to SMA Female Bulkhead-Mounting Hole B02 VSWR 1.3:1 to 26.5 GHz</p> <p>Model No: <a href="#">PE9508</a></p>	PRICE	1-9	\$113.12	10-24	\$107.46	25-49	\$101.81	50+	\$97.28	 <table border="1"> <thead> <tr><th>PRICE</th></tr> </thead> <tbody> <tr><td>1-24</td><td>\$47.48</td></tr> <tr><td>25-49</td><td>\$45.11</td></tr> <tr><td>50-99</td><td>\$42.73</td></tr> <tr><td>PRECISION 100+</td><td>\$40.83</td></tr> </tbody> </table> <p>SMA Female to SMA Female Bulkhead-Mounting Hole B02 VSWR 1.15:1 to 18 GHz</p> <p>Model No: <a href="#">PE9620</a></p>	PRICE	1-24	\$47.48	25-49	\$45.11	50-99	\$42.73	PRECISION 100+	\$40.83	 <table border="1"> <thead> <tr><th>PRICE</th></tr> </thead> <tbody> <tr><td>1-9</td><td>\$46.57</td></tr> <tr><td>10-24</td><td>\$44.24</td></tr> <tr><td>25-49</td><td>\$41.91</td></tr> <tr><td>50+</td><td>\$40.05</td></tr> </tbody> </table> <p>SMA Female to SMA Female Bulkhead VSWR 1.35:1 to 18 GHz</p> <p>Model No: <a href="#">PE91393</a></p>	PRICE	1-9	\$46.57	10-24	\$44.24	25-49	\$41.91	50+	\$40.05
	PRICE																																																	
1-24	\$64.73																																																	
25-49	\$61.49																																																	
50-99	\$58.26																																																	
100+	\$55.67																																																	
PRICE																																																		
1-24	\$20.50																																																	
25-49	\$19.48																																																	
50-99	\$18.45																																																	
100+	\$17.63																																																	
PRICE																																																		
1-9	\$113.12																																																	
10-24	\$107.46																																																	
25-49	\$101.81																																																	
50+	\$97.28																																																	
PRICE																																																		
1-24	\$47.48																																																	
25-49	\$45.11																																																	
50-99	\$42.73																																																	
PRECISION 100+	\$40.83																																																	
PRICE																																																		
1-9	\$46.57																																																	
10-24	\$44.24																																																	
25-49	\$41.91																																																	
50+	\$40.05																																																	
3	 <table border="1"> <thead> <tr><th>PRICE</th></tr> </thead> <tbody> <tr><td>1-24</td><td>\$49.03</td></tr> <tr><td>25-49</td><td>\$46.58</td></tr> <tr><td>50-99</td><td>\$44.13</td></tr> <tr><td>100+</td><td>\$42.17</td></tr> </tbody> </table> <p>SMA Female to SMA Female Bulkhead VSWR 1.4:1 to 18 GHz</p> <p>Model No: <a href="#">PE9184</a></p>	PRICE	1-24	\$49.03	25-49	\$46.58	50-99	\$44.13	100+	\$42.17	 <table border="1"> <thead> <tr><th>PRICE</th></tr> </thead> <tbody> <tr><td>1-24</td><td>\$37.17</td></tr> <tr><td>25-49</td><td>\$35.31</td></tr> <tr><td>50-99</td><td>\$33.45</td></tr> <tr><td>100+</td><td>\$31.97</td></tr> </tbody> </table> <p>SMA Female to SMA Female Bulkhead VSWR 1.25:1 to 12.4 GHz</p> <p>Model No: <a href="#">PE9067</a></p>	PRICE	1-24	\$37.17	25-49	\$35.31	50-99	\$33.45	100+	\$31.97	 <table border="1"> <thead> <tr><th>PRICE</th></tr> </thead> <tbody> <tr><td>1-24</td><td>\$67.10</td></tr> <tr><td>25-49</td><td>\$63.75</td></tr> <tr><td>50-99</td><td>\$60.39</td></tr> <tr><td>100+</td><td>\$57.71</td></tr> </tbody> </table> <p>SMA Female to SMA Female 4 Hole Flange-Mounting Hole A01 VSWR 1.25:1 to 18 GHz</p> <p>Model No: <a href="#">PE9312</a></p>	PRICE	1-24	\$67.10	25-49	\$63.75	50-99	\$60.39	100+	\$57.71	 <table border="1"> <thead> <tr><th>PRICE</th></tr> </thead> <tbody> <tr><td>1-24</td><td>\$95.98</td></tr> <tr><td>25-49</td><td>\$91.18</td></tr> <tr><td>50-99</td><td>\$86.38</td></tr> <tr><td>100+</td><td>\$82.54</td></tr> </tbody> </table> <p>SMA Female to SMA Female 4 Hole Flange-Mounting Hole A01 VSWR 1.25:1 to 18 GHz</p> <p>Model No: <a href="#">PE9670</a></p>	PRICE	1-24	\$95.98	25-49	\$91.18	50-99	\$86.38	100+	\$82.54	 <table border="1"> <thead> <tr><th>PRICE</th></tr> </thead> <tbody> <tr><td>1-24</td><td>\$25.90</td></tr> <tr><td>25-49</td><td>\$24.61</td></tr> <tr><td>50-99</td><td>\$23.31</td></tr> <tr><td>100+</td><td>\$22.27</td></tr> </tbody> </table> <p>SMA Female to SMA Female Bulkhead VSWR 1.23:1 to 18 GHz</p> <p>Model No: <a href="#">PE9184NH</a></p>	PRICE	1-24	\$25.90	25-49	\$24.61	50-99	\$23.31	100+	\$22.27
	PRICE																																																	
1-24	\$49.03																																																	
25-49	\$46.58																																																	
50-99	\$44.13																																																	
100+	\$42.17																																																	
PRICE																																																		
1-24	\$37.17																																																	
25-49	\$35.31																																																	
50-99	\$33.45																																																	
100+	\$31.97																																																	
PRICE																																																		
1-24	\$67.10																																																	
25-49	\$63.75																																																	
50-99	\$60.39																																																	
100+	\$57.71																																																	
PRICE																																																		
1-24	\$95.98																																																	
25-49	\$91.18																																																	
50-99	\$86.38																																																	
100+	\$82.54																																																	
PRICE																																																		
1-24	\$25.90																																																	
25-49	\$24.61																																																	
50-99	\$23.31																																																	
100+	\$22.27																																																	
4	 <table border="1"> <thead> <tr><th>PRICE</th></tr> </thead> <tbody> <tr><td>1-24</td><td>\$21.44</td></tr> <tr><td>25-49</td><td>\$20.37</td></tr> <tr><td>50-99</td><td>\$19.30</td></tr> <tr><td>100+</td><td>\$18.44</td></tr> </tbody> </table> <p>SMA Female to SMA Female 2 Hole Flange VSWR 1.25:1 to 18 GHz</p> <p>Model No: <a href="#">PE91290</a></p>	PRICE	1-24	\$21.44	25-49	\$20.37	50-99	\$19.30	100+	\$18.44	 <table border="1"> <thead> <tr><th>PRICE</th></tr> </thead> <tbody> <tr><td>1-24</td><td>\$31.77</td></tr> <tr><td>25-49</td><td>\$30.18</td></tr> <tr><td>50-99</td><td>\$28.59</td></tr> <tr><td>PRECISION NEW 100+</td><td>\$27.32</td></tr> </tbody> </table> <p>SMA Female to SMA Female VSWR 1.2:1 to 27 GHz</p> <p>Model No: <a href="#">PE91549</a></p>	PRICE	1-24	\$31.77	25-49	\$30.18	50-99	\$28.59	PRECISION NEW 100+	\$27.32	 <table border="1"> <thead> <tr><th>PRICE</th></tr> </thead> <tbody> <tr><td>1-24</td><td>\$86.38</td></tr> <tr><td>25-49</td><td>\$82.06</td></tr> <tr><td>50-99</td><td>\$77.74</td></tr> <tr><td>NEW 100+</td><td>\$74.29</td></tr> </tbody> </table> <p>SMA Female to SMA Female Miter Right Angle VSWR 1.2:1 to 27 GHz</p> <p>Model No: <a href="#">PE91176</a></p>	PRICE	1-24	\$86.38	25-49	\$82.06	50-99	\$77.74	NEW 100+	\$74.29	<div style="background-color: black; color: white; padding: 10px; border: 1px solid white;"> <p><b>Reverse Polarity SMA In-Series</b></p> <p>→</p> </div>																			
	PRICE																																																	
1-24	\$21.44																																																	
25-49	\$20.37																																																	
50-99	\$19.30																																																	
100+	\$18.44																																																	
PRICE																																																		
1-24	\$31.77																																																	
25-49	\$30.18																																																	
50-99	\$28.59																																																	
PRECISION NEW 100+	\$27.32																																																	
PRICE																																																		
1-24	\$86.38																																																	
25-49	\$82.06																																																	
50-99	\$77.74																																																	
NEW 100+	\$74.29																																																	
5	 <table border="1"> <thead> <tr><th>PRICE</th></tr> </thead> <tbody> <tr><td>1-24</td><td>\$69.40</td></tr> <tr><td>25-49</td><td>\$65.93</td></tr> <tr><td>50-99</td><td>\$62.46</td></tr> <tr><td>100+</td><td>\$59.68</td></tr> </tbody> </table> <p>QD SMA Male to Rev. Pol. SMA Female VSWR 1.25:1 to 18 GHz</p> <p>Model No: <a href="#">PE91265</a></p>	PRICE	1-24	\$69.40	25-49	\$65.93	50-99	\$62.46	100+	\$59.68	 <table border="1"> <thead> <tr><th>PRICE</th></tr> </thead> <tbody> <tr><td>1-24</td><td>\$43.07</td></tr> <tr><td>25-49</td><td>\$40.92</td></tr> <tr><td>50-99</td><td>\$38.76</td></tr> <tr><td>100+</td><td>\$37.04</td></tr> </tbody> </table> <p>SMA Male to Rev. Pol. SMA Female VSWR 1.25:1 to 18 GHz</p> <p>Model No: <a href="#">PE9534</a></p>	PRICE	1-24	\$43.07	25-49	\$40.92	50-99	\$38.76	100+	\$37.04	 <table border="1"> <thead> <tr><th>PRICE</th></tr> </thead> <tbody> <tr><td>1-24</td><td>\$47.56</td></tr> <tr><td>25-49</td><td>\$45.18</td></tr> <tr><td>50-99</td><td>\$42.80</td></tr> <tr><td>100+</td><td>\$40.90</td></tr> </tbody> </table> <p>SMA Male to Rev. Pol. SMA Female Right Angle VSWR 1.23:1 to 12.4 GHz</p> <p>Model No: <a href="#">PE91264</a></p>	PRICE	1-24	\$47.56	25-49	\$45.18	50-99	\$42.80	100+	\$40.90	 <table border="1"> <thead> <tr><th>PRICE</th></tr> </thead> <tbody> <tr><td>1-24</td><td>\$23.91</td></tr> <tr><td>25-49</td><td>\$22.71</td></tr> <tr><td>50-99</td><td>\$21.52</td></tr> <tr><td>100+</td><td>\$20.56</td></tr> </tbody> </table> <p>SMA Female to Rev. Pol. SMA Male VSWR 1.25:1 to 18 GHz</p> <p>Model No: <a href="#">PE9533</a></p>	PRICE	1-24	\$23.91	25-49	\$22.71	50-99	\$21.52	100+	\$20.56	 <table border="1"> <thead> <tr><th>PRICE</th></tr> </thead> <tbody> <tr><td>1-24</td><td>\$38.26</td></tr> <tr><td>25-49</td><td>\$36.35</td></tr> <tr><td>50-99</td><td>\$34.43</td></tr> <tr><td>100+</td><td>\$32.90</td></tr> </tbody> </table> <p>SMA Female to Rev. Pol. SMA Female VSWR 1.2:1 to 18 GHz</p> <p>Model No: <a href="#">PE91260</a></p>	PRICE	1-24	\$38.26	25-49	\$36.35	50-99	\$34.43	100+	\$32.90
	PRICE																																																	
1-24	\$69.40																																																	
25-49	\$65.93																																																	
50-99	\$62.46																																																	
100+	\$59.68																																																	
PRICE																																																		
1-24	\$43.07																																																	
25-49	\$40.92																																																	
50-99	\$38.76																																																	
100+	\$37.04																																																	
PRICE																																																		
1-24	\$47.56																																																	
25-49	\$45.18																																																	
50-99	\$42.80																																																	
100+	\$40.90																																																	
PRICE																																																		
1-24	\$23.91																																																	
25-49	\$22.71																																																	
50-99	\$21.52																																																	
100+	\$20.56																																																	
PRICE																																																		
1-24	\$38.26																																																	
25-49	\$36.35																																																	
50-99	\$34.43																																																	
100+	\$32.90																																																	
6	 <table border="1"> <thead> <tr><th>PRICE</th></tr> </thead> <tbody> <tr><td>1-24</td><td>\$115.25</td></tr> <tr><td>25-49</td><td>\$109.49</td></tr> <tr><td>50-99</td><td>\$103.73</td></tr> <tr><td>100+</td><td>\$99.12</td></tr> </tbody> </table> <p>QD Rev. Pol. SMA Male to SMA Male VSWR 1.25:1 to 18 GHz</p> <p>Model No: <a href="#">PE91266</a></p>	PRICE	1-24	\$115.25	25-49	\$109.49	50-99	\$103.73	100+	\$99.12	 <table border="1"> <thead> <tr><th>PRICE</th></tr> </thead> <tbody> <tr><td>1-24</td><td>\$76.27</td></tr> <tr><td>25-49</td><td>\$72.46</td></tr> <tr><td>50-99</td><td>\$68.64</td></tr> <tr><td>100+</td><td>\$65.59</td></tr> </tbody> </table> <p>QD Rev. Pol. SMA Male to SMA Female VSWR 1.25:1 to 18 GHz</p> <p>Model No: <a href="#">PE91267</a></p>	PRICE	1-24	\$76.27	25-49	\$72.46	50-99	\$68.64	100+	\$65.59	 <table border="1"> <thead> <tr><th>PRICE</th></tr> </thead> <tbody> <tr><td>1-24</td><td>\$38.97</td></tr> <tr><td>25-49</td><td>\$37.02</td></tr> <tr><td>50-99</td><td>\$35.07</td></tr> <tr><td>100+</td><td>\$33.51</td></tr> </tbody> </table> <p>Rev. Pol. SMA Male to SMA Female Right Angle VSWR 1.23:1 to 12.4 GHz</p> <p>Model No: <a href="#">PE91263</a></p>	PRICE	1-24	\$38.97	25-49	\$37.02	50-99	\$35.07	100+	\$33.51	 <table border="1"> <thead> <tr><th>PRICE</th></tr> </thead> <tbody> <tr><td>1-24</td><td>\$46.26</td></tr> <tr><td>25-49</td><td>\$43.95</td></tr> <tr><td>50-99</td><td>\$41.63</td></tr> <tr><td>100+</td><td>\$39.78</td></tr> </tbody> </table> <p>Rev. Pol. SMA Male to Rev. Pol. SMA Male VSWR 1.2:1 to 18 GHz</p> <p>Model No: <a href="#">PE91261</a></p>	PRICE	1-24	\$46.26	25-49	\$43.95	50-99	\$41.63	100+	\$39.78	 <table border="1"> <thead> <tr><th>PRICE</th></tr> </thead> <tbody> <tr><td>1-24</td><td>\$57.04</td></tr> <tr><td>25-49</td><td>\$54.19</td></tr> <tr><td>50-99</td><td>\$51.34</td></tr> <tr><td>100+</td><td>\$49.05</td></tr> </tbody> </table> <p>Rev. Pol. SMA Male to Rev. Pol. SMA Male VSWR 1.35:1 to 6 GHz</p> <p>Model No: <a href="#">PE91330</a></p>	PRICE	1-24	\$57.04	25-49	\$54.19	50-99	\$51.34	100+	\$49.05
	PRICE																																																	
1-24	\$115.25																																																	
25-49	\$109.49																																																	
50-99	\$103.73																																																	
100+	\$99.12																																																	
PRICE																																																		
1-24	\$76.27																																																	
25-49	\$72.46																																																	
50-99	\$68.64																																																	
100+	\$65.59																																																	
PRICE																																																		
1-24	\$38.97																																																	
25-49	\$37.02																																																	
50-99	\$35.07																																																	
100+	\$33.51																																																	
PRICE																																																		
1-24	\$46.26																																																	
25-49	\$43.95																																																	
50-99	\$41.63																																																	
100+	\$39.78																																																	
PRICE																																																		
1-24	\$57.04																																																	
25-49	\$54.19																																																	
50-99	\$51.34																																																	
100+	\$49.05																																																	
7	 <table border="1"> <thead> <tr><th>PRICE</th></tr> </thead> <tbody> <tr><td>1-24</td><td>\$69.40</td></tr> <tr><td>25-49</td><td>\$65.93</td></tr> <tr><td>50-99</td><td>\$62.46</td></tr> <tr><td>100+</td><td>\$59.68</td></tr> </tbody> </table> <p>QD Rev. Pol. SMA Male to Rev. Pol. SMA Female VSWR 1.25:1 to 18 GHz</p> <p>Model No: <a href="#">PE91268</a></p>	PRICE	1-24	\$69.40	25-49	\$65.93	50-99	\$62.46	100+	\$59.68	 <table border="1"> <thead> <tr><th>PRICE</th></tr> </thead> <tbody> <tr><td>1-24</td><td>\$56.92</td></tr> <tr><td>25-49</td><td>\$54.07</td></tr> <tr><td>50-99</td><td>\$51.23</td></tr> <tr><td>100+</td><td>\$48.95</td></tr> </tbody> </table> <p>Rev. Pol. SMA Male to Rev. Pol. SMA Female VSWR 1.35:1 to 6 GHz</p> <p>Model No: <a href="#">PE91331</a></p>	PRICE	1-24	\$56.92	25-49	\$54.07	50-99	\$51.23	100+	\$48.95	 <table border="1"> <thead> <tr><th>PRICE</th></tr> </thead> <tbody> <tr><td>1-24</td><td>\$38.26</td></tr> <tr><td>25-49</td><td>\$36.35</td></tr> <tr><td>50-99</td><td>\$34.43</td></tr> <tr><td>100+</td><td>\$32.90</td></tr> </tbody> </table> <p>Rev. Pol. SMA Male to Rev. Pol. SMA Female Right Angle VSWR 1.25:1 to 6 GHz</p> <p>Model No: <a href="#">PE9594</a></p>	PRICE	1-24	\$38.26	25-49	\$36.35	50-99	\$34.43	100+	\$32.90	 <table border="1"> <thead> <tr><th>PRICE</th></tr> </thead> <tbody> <tr><td>1-24</td><td>\$46.26</td></tr> <tr><td>25-49</td><td>\$43.95</td></tr> <tr><td>50-99</td><td>\$41.63</td></tr> <tr><td>100+</td><td>\$39.78</td></tr> </tbody> </table> <p>Rev. Pol. SMA Female to Rev. Pol. SMA Female VSWR 1.2:1 to 18 GHz</p> <p>Model No: <a href="#">PE91262</a></p>	PRICE	1-24	\$46.26	25-49	\$43.95	50-99	\$41.63	100+	\$39.78	 <table border="1"> <thead> <tr><th>PRICE</th></tr> </thead> <tbody> <tr><td>1-24</td><td>\$37.53</td></tr> <tr><td>25-49</td><td>\$35.65</td></tr> <tr><td>50-99</td><td>\$33.78</td></tr> <tr><td>100+</td><td>\$32.28</td></tr> </tbody> </table> <p>Rev. Pol. SMA Female to Rev. Pol. SMA Female VSWR 1.35:1 to 6 GHz</p> <p>Model No: <a href="#">PE91334</a></p>	PRICE	1-24	\$37.53	25-49	\$35.65	50-99	\$33.78	100+	\$32.28
	PRICE																																																	
1-24	\$69.40																																																	
25-49	\$65.93																																																	
50-99	\$62.46																																																	
100+	\$59.68																																																	
PRICE																																																		
1-24	\$56.92																																																	
25-49	\$54.07																																																	
50-99	\$51.23																																																	
100+	\$48.95																																																	
PRICE																																																		
1-24	\$38.26																																																	
25-49	\$36.35																																																	
50-99	\$34.43																																																	
100+	\$32.90																																																	
PRICE																																																		
1-24	\$46.26																																																	
25-49	\$43.95																																																	
50-99	\$41.63																																																	
100+	\$39.78																																																	
PRICE																																																		
1-24	\$37.53																																																	
25-49	\$35.65																																																	
50-99	\$33.78																																																	
100+	\$32.28																																																	



Technical Support  
+1 (949) 261-1920



Same-Day Shipping,  
Even Custom Cable Assemblies



# ADAPTERS

See Adapter Locator on Pages 10-15

See Page 409 for Mounting Holes

Adapters

See Our Website For Current Pricing & Real-Time Stock Availability!

	A	B	C	D	E																																																		
1	 <table border="1"> <thead> <tr> <th colspan="2">PRICE</th> </tr> </thead> <tbody> <tr><td>1-24</td><td>\$54.07</td></tr> <tr><td>25-49</td><td>\$51.37</td></tr> <tr><td>50-99</td><td>\$48.66</td></tr> <tr><td>100+</td><td>\$46.50</td></tr> </tbody> </table> <p>Rev. Pol. SMA Female to Rev. Pol. SMA Female Bulkhead-Mounting Hole B02 VSWR 1.25:1 to 18 GHz</p> <p>Model No: <a href="#">PE9593</a></p>	PRICE		1-24	\$54.07	25-49	\$51.37	50-99	\$48.66	100+	\$46.50	 <table border="1"> <thead> <tr> <th colspan="2">PRICE</th> </tr> </thead> <tbody> <tr><td>1-24</td><td>\$47.63</td></tr> <tr><td>25-49</td><td>\$45.25</td></tr> <tr><td>50-99</td><td>\$42.87</td></tr> <tr><td>100+</td><td>\$40.96</td></tr> </tbody> </table> <p>Rev. Pol. SMA Female to Rev. Pol. SMA Female 2 Hole Flange VSWR 1.2:1 to 18 GHz</p> <p>Model No: <a href="#">PE91270</a></p>	PRICE		1-24	\$47.63	25-49	\$45.25	50-99	\$42.87	100+	\$40.96	 <table border="1"> <thead> <tr> <th colspan="2">PRICE</th> </tr> </thead> <tbody> <tr><td>1-24</td><td>\$49.20</td></tr> <tr><td>25-49</td><td>\$46.74</td></tr> <tr><td>50-99</td><td>\$44.28</td></tr> <tr><td>100+</td><td>\$42.31</td></tr> </tbody> </table> <p>Rev. Pol. SMA Female to Rev. Pol. SMA Female 4 Hole Flange VSWR 1.2:1 to 18 GHz</p> <p>Model No: <a href="#">PE91269</a></p>	PRICE		1-24	\$49.20	25-49	\$46.74	50-99	\$44.28	100+	\$42.31	<p style="text-align: center;"><b>Reverse Thread SMA In-Series</b></p> <p style="text-align: center;">→</p>	 <table border="1"> <thead> <tr> <th colspan="2">PRICE</th> </tr> </thead> <tbody> <tr><td>1-24</td><td>\$54.29</td></tr> <tr><td>25-49</td><td>\$51.58</td></tr> <tr><td>50-99</td><td>\$48.86</td></tr> <tr><td>100+</td><td>\$46.69</td></tr> </tbody> </table> <p>SMA Male to Reverse Thread SMA Female</p> <p>Model No: <a href="#">PE9682</a></p>	PRICE		1-24	\$54.29	25-49	\$51.58	50-99	\$48.86	100+	\$46.69										
PRICE																																																							
1-24	\$54.07																																																						
25-49	\$51.37																																																						
50-99	\$48.66																																																						
100+	\$46.50																																																						
PRICE																																																							
1-24	\$47.63																																																						
25-49	\$45.25																																																						
50-99	\$42.87																																																						
100+	\$40.96																																																						
PRICE																																																							
1-24	\$49.20																																																						
25-49	\$46.74																																																						
50-99	\$44.28																																																						
100+	\$42.31																																																						
PRICE																																																							
1-24	\$54.29																																																						
25-49	\$51.58																																																						
50-99	\$48.86																																																						
100+	\$46.69																																																						
2	 <table border="1"> <thead> <tr> <th colspan="2">PRICE</th> </tr> </thead> <tbody> <tr><td>1-24</td><td>\$62.53</td></tr> <tr><td>25-49</td><td>\$59.40</td></tr> <tr><td>50-99</td><td>\$56.28</td></tr> <tr><td>100+</td><td>\$53.78</td></tr> </tbody> </table> <p>SMA Female to Reverse Thread SMA Male</p> <p>Model No: <a href="#">PE9683</a></p>	PRICE		1-24	\$62.53	25-49	\$59.40	50-99	\$56.28	100+	\$53.78	<p style="text-align: center;"><b>SMA Between Series</b></p> <p style="text-align: center;">→</p>	 <table border="1"> <thead> <tr> <th colspan="2">PRICE</th> </tr> </thead> <tbody> <tr><td>1-24</td><td>\$117.37</td></tr> <tr><td>25-49</td><td>\$111.50</td></tr> <tr><td>50-99</td><td>\$105.63</td></tr> <tr><td>100+</td><td>\$100.94</td></tr> </tbody> </table> <p>SMA Male to 1.0/2.3 Plug</p> <p>Model No: <a href="#">PE9692</a></p>	PRICE		1-24	\$117.37	25-49	\$111.50	50-99	\$105.63	100+	\$100.94	 <table border="1"> <thead> <tr> <th colspan="2">PRICE</th> </tr> </thead> <tbody> <tr><td>1-24</td><td>\$97.95</td></tr> <tr><td>25-49</td><td>\$93.05</td></tr> <tr><td>50-99</td><td>\$88.16</td></tr> <tr><td>100+</td><td>\$84.24</td></tr> </tbody> </table> <p>SMA Male to 1.0/2.3 Jack</p> <p>Model No: <a href="#">PE9690</a></p>	PRICE		1-24	\$97.95	25-49	\$93.05	50-99	\$88.16	100+	\$84.24	 <table border="1"> <thead> <tr> <th colspan="2">PRICE</th> </tr> </thead> <tbody> <tr><td>1-9</td><td>\$217.64</td></tr> <tr><td>10-24</td><td>\$206.76</td></tr> <tr><td>25-49</td><td>\$195.88</td></tr> <tr><td>50+</td><td>\$187.17</td></tr> </tbody> </table> <p>SMA Male to 1.85mm Male VSWR 1.3:1 to 18 GHz</p> <p>Model No: <a href="#">PE9727</a></p>	PRICE		1-9	\$217.64	10-24	\$206.76	25-49	\$195.88	50+	\$187.17										
PRICE																																																							
1-24	\$62.53																																																						
25-49	\$59.40																																																						
50-99	\$56.28																																																						
100+	\$53.78																																																						
PRICE																																																							
1-24	\$117.37																																																						
25-49	\$111.50																																																						
50-99	\$105.63																																																						
100+	\$100.94																																																						
PRICE																																																							
1-24	\$97.95																																																						
25-49	\$93.05																																																						
50-99	\$88.16																																																						
100+	\$84.24																																																						
PRICE																																																							
1-9	\$217.64																																																						
10-24	\$206.76																																																						
25-49	\$195.88																																																						
50+	\$187.17																																																						
3	 <table border="1"> <thead> <tr> <th colspan="2">PRICE</th> </tr> </thead> <tbody> <tr><td>1-9</td><td>\$225.66</td></tr> <tr><td>10-24</td><td>\$214.38</td></tr> <tr><td>25-49</td><td>\$203.09</td></tr> <tr><td>50+</td><td>\$194.07</td></tr> </tbody> </table> <p>SMA Male to 1.85mm Female VSWR 1.3:1 to 18 GHz</p> <p>Model No: <a href="#">PE9728</a></p>	PRICE		1-9	\$225.66	10-24	\$214.38	25-49	\$203.09	50+	\$194.07	 <table border="1"> <thead> <tr> <th colspan="2">PRICE</th> </tr> </thead> <tbody> <tr><td>1-9</td><td>\$211.98</td></tr> <tr><td>10-24</td><td>\$201.38</td></tr> <tr><td>25-49</td><td>\$190.78</td></tr> <tr><td>50+</td><td>\$182.30</td></tr> </tbody> </table> <p>PRECISION SMA Male to 2.4mm Male VSWR 1.2:1 to 26.5 GHz</p> <p>Model No: <a href="#">PE9653</a></p>	PRICE		1-9	\$211.98	10-24	\$201.38	25-49	\$190.78	50+	\$182.30	 <table border="1"> <thead> <tr> <th colspan="2">PRICE</th> </tr> </thead> <tbody> <tr><td>1-9</td><td>\$233.32</td></tr> <tr><td>10-24</td><td>\$221.65</td></tr> <tr><td>25-49</td><td>\$209.99</td></tr> <tr><td>50+</td><td>\$200.66</td></tr> </tbody> </table> <p>PRECISION SMA Male to 2.4mm Female VSWR 1.2:1 to 26.5 GHz</p> <p>Model No: <a href="#">PE9654</a></p>	PRICE		1-9	\$233.32	10-24	\$221.65	25-49	\$209.99	50+	\$200.66	 <table border="1"> <thead> <tr> <th colspan="2">PRICE</th> </tr> </thead> <tbody> <tr><td>1-9</td><td>\$218.45</td></tr> <tr><td>10-24</td><td>\$207.53</td></tr> <tr><td>25-49</td><td>\$196.61</td></tr> <tr><td>50+</td><td>\$187.87</td></tr> </tbody> </table> <p>PRECISION SMA Male to 2.92mm Male VSWR 1.2:1 to 26.5 GHz</p> <p>Model No: <a href="#">PE91010</a></p>	PRICE		1-9	\$218.45	10-24	\$207.53	25-49	\$196.61	50+	\$187.87	 <table border="1"> <thead> <tr> <th colspan="2">PRICE</th> </tr> </thead> <tbody> <tr><td>1-9</td><td>\$214.24</td></tr> <tr><td>10-24</td><td>\$203.53</td></tr> <tr><td>25-49</td><td>\$192.82</td></tr> <tr><td>50+</td><td>\$184.25</td></tr> </tbody> </table> <p>PRECISION SMA Male to 2.92mm Female VSWR 1.2:1 to 26.5 GHz</p> <p>Model No: <a href="#">PE91008</a></p>	PRICE		1-9	\$214.24	10-24	\$203.53	25-49	\$192.82	50+	\$184.25
PRICE																																																							
1-9	\$225.66																																																						
10-24	\$214.38																																																						
25-49	\$203.09																																																						
50+	\$194.07																																																						
PRICE																																																							
1-9	\$211.98																																																						
10-24	\$201.38																																																						
25-49	\$190.78																																																						
50+	\$182.30																																																						
PRICE																																																							
1-9	\$233.32																																																						
10-24	\$221.65																																																						
25-49	\$209.99																																																						
50+	\$200.66																																																						
PRICE																																																							
1-9	\$218.45																																																						
10-24	\$207.53																																																						
25-49	\$196.61																																																						
50+	\$187.87																																																						
PRICE																																																							
1-9	\$214.24																																																						
10-24	\$203.53																																																						
25-49	\$192.82																																																						
50+	\$184.25																																																						
4	 <table border="1"> <thead> <tr> <th colspan="2">PRICE</th> </tr> </thead> <tbody> <tr><td>1-9</td><td>\$215.61</td></tr> <tr><td>10-24</td><td>\$204.83</td></tr> <tr><td>25-49</td><td>\$194.05</td></tr> <tr><td>50+</td><td>\$185.42</td></tr> </tbody> </table> <p>SMA Male to 3.5mm Male VSWR 1.25:1 to 18 GHz</p> <p>Model No: <a href="#">PE9722</a></p>	PRICE		1-9	\$215.61	10-24	\$204.83	25-49	\$194.05	50+	\$185.42	 <table border="1"> <thead> <tr> <th colspan="2">PRICE</th> </tr> </thead> <tbody> <tr><td>1-9</td><td>\$164.15</td></tr> <tr><td>10-24</td><td>\$155.94</td></tr> <tr><td>25-49</td><td>\$147.74</td></tr> <tr><td>50+</td><td>\$141.17</td></tr> </tbody> </table> <p>NEW SMA Male to 3.5mm Female VSWR 1.2:1 to 27 GHz</p> <p>Model No: <a href="#">PE91536</a></p>	PRICE		1-9	\$164.15	10-24	\$155.94	25-49	\$147.74	50+	\$141.17	 <table border="1"> <thead> <tr> <th colspan="2">PRICE</th> </tr> </thead> <tbody> <tr><td>1-4</td><td>\$534.33</td></tr> <tr><td>5-9</td><td>\$507.61</td></tr> <tr><td>10-24</td><td>\$480.90</td></tr> <tr><td>25+</td><td>\$459.52</td></tr> </tbody> </table> <p>PRECISION SMA Male to 7mm Sexless VSWR 1.15:1 to 18 GHz</p> <p>Model No: <a href="#">PE9215</a></p>	PRICE		1-4	\$534.33	5-9	\$507.61	10-24	\$480.90	25+	\$459.52	 <table border="1"> <thead> <tr> <th colspan="2">PRICE</th> </tr> </thead> <tbody> <tr><td>1-4</td><td>Call</td></tr> <tr><td>5-9</td><td>Call</td></tr> <tr><td>10-24</td><td>Call</td></tr> <tr><td>25+</td><td>Call</td></tr> </tbody> </table> <p>SMA Male to 7/16 DIN Female</p> <p>Model No: <a href="#">PE9411</a></p>	PRICE		1-4	Call	5-9	Call	10-24	Call	25+	Call	 <table border="1"> <thead> <tr> <th colspan="2">PRICE</th> </tr> </thead> <tbody> <tr><td>1-24</td><td>\$44.95</td></tr> <tr><td>25-49</td><td>\$42.70</td></tr> <tr><td>50-99</td><td>\$40.46</td></tr> <tr><td>100+</td><td>\$38.66</td></tr> </tbody> </table> <p>SMA Male to BNC Male Max. Freq. 4 GHz</p> <p>Model No: <a href="#">PE9072</a></p>	PRICE		1-24	\$44.95	25-49	\$42.70	50-99	\$40.46	100+	\$38.66
PRICE																																																							
1-9	\$215.61																																																						
10-24	\$204.83																																																						
25-49	\$194.05																																																						
50+	\$185.42																																																						
PRICE																																																							
1-9	\$164.15																																																						
10-24	\$155.94																																																						
25-49	\$147.74																																																						
50+	\$141.17																																																						
PRICE																																																							
1-4	\$534.33																																																						
5-9	\$507.61																																																						
10-24	\$480.90																																																						
25+	\$459.52																																																						
PRICE																																																							
1-4	Call																																																						
5-9	Call																																																						
10-24	Call																																																						
25+	Call																																																						
PRICE																																																							
1-24	\$44.95																																																						
25-49	\$42.70																																																						
50-99	\$40.46																																																						
100+	\$38.66																																																						
5	 <table border="1"> <thead> <tr> <th colspan="2">PRICE</th> </tr> </thead> <tbody> <tr><td>1-24</td><td>\$115.32</td></tr> <tr><td>25-49</td><td>\$109.55</td></tr> <tr><td>50-99</td><td>\$103.79</td></tr> <tr><td>100+</td><td>\$99.18</td></tr> </tbody> </table> <p>SMA Male to BNC Male VSWR 1.25:1 to 8 GHz</p> <p>Model No: <a href="#">PE9493</a></p>	PRICE		1-24	\$115.32	25-49	\$109.55	50-99	\$103.79	100+	\$99.18	 <table border="1"> <thead> <tr> <th colspan="2">PRICE</th> </tr> </thead> <tbody> <tr><td>1-24</td><td>\$28.40</td></tr> <tr><td>25-49</td><td>\$26.98</td></tr> <tr><td>50-99</td><td>\$25.56</td></tr> <tr><td>100+</td><td>\$24.42</td></tr> </tbody> </table> <p>SMA Male to BNC Female VSWR 1.3:1 to 4 GHz</p> <p>Model No: <a href="#">PE9074</a></p>	PRICE		1-24	\$28.40	25-49	\$26.98	50-99	\$25.56	100+	\$24.42	 <table border="1"> <thead> <tr> <th colspan="2">PRICE</th> </tr> </thead> <tbody> <tr><td>1-9</td><td>\$150.97</td></tr> <tr><td>10-24</td><td>\$143.42</td></tr> <tr><td>25-49</td><td>\$135.87</td></tr> <tr><td>50+</td><td>\$129.83</td></tr> </tbody> </table> <p>SMA Male to BNC Female VSWR 1.25:1 to 8 GHz</p> <p>Model No: <a href="#">PE9495</a></p>	PRICE		1-9	\$150.97	10-24	\$143.42	25-49	\$135.87	50+	\$129.83	 <table border="1"> <thead> <tr> <th colspan="2">PRICE</th> </tr> </thead> <tbody> <tr><td>1-24</td><td>\$35.98</td></tr> <tr><td>25-49</td><td>\$34.18</td></tr> <tr><td>50-99</td><td>\$32.38</td></tr> <tr><td>100+</td><td>\$30.94</td></tr> </tbody> </table> <p>SMA Male to 75 Ohm F Female Max. Freq. 2 GHz</p> <p>Model No: <a href="#">PE91003</a></p>	PRICE		1-24	\$35.98	25-49	\$34.18	50-99	\$32.38	100+	\$30.94	 <table border="1"> <thead> <tr> <th colspan="2">PRICE</th> </tr> </thead> <tbody> <tr><td>1-24</td><td>\$23.51</td></tr> <tr><td>25-49</td><td>\$22.33</td></tr> <tr><td>50-99</td><td>\$21.16</td></tr> <tr><td>100+</td><td>\$20.22</td></tr> </tbody> </table> <p>SMA Male to FME Jack</p> <p>Model No: <a href="#">PE9707</a></p>	PRICE		1-24	\$23.51	25-49	\$22.33	50-99	\$21.16	100+	\$20.22
PRICE																																																							
1-24	\$115.32																																																						
25-49	\$109.55																																																						
50-99	\$103.79																																																						
100+	\$99.18																																																						
PRICE																																																							
1-24	\$28.40																																																						
25-49	\$26.98																																																						
50-99	\$25.56																																																						
100+	\$24.42																																																						
PRICE																																																							
1-9	\$150.97																																																						
10-24	\$143.42																																																						
25-49	\$135.87																																																						
50+	\$129.83																																																						
PRICE																																																							
1-24	\$35.98																																																						
25-49	\$34.18																																																						
50-99	\$32.38																																																						
100+	\$30.94																																																						
PRICE																																																							
1-24	\$23.51																																																						
25-49	\$22.33																																																						
50-99	\$21.16																																																						
100+	\$20.22																																																						
6	 <table border="1"> <thead> <tr> <th colspan="2">PRICE</th> </tr> </thead> <tbody> <tr><td>1-9</td><td>\$247.78</td></tr> <tr><td>10-24</td><td>\$235.39</td></tr> <tr><td>25-49</td><td>\$223.00</td></tr> <tr><td>50+</td><td>\$213.09</td></tr> </tbody> </table> <p>SMA Male to GR874 Sexless</p> <p>Model No: <a href="#">PE9259</a></p>	PRICE		1-9	\$247.78	10-24	\$235.39	25-49	\$223.00	50+	\$213.09	 <table border="1"> <thead> <tr> <th colspan="2">PRICE</th> </tr> </thead> <tbody> <tr><td>1-24</td><td>\$94.22</td></tr> <tr><td>25-49</td><td>\$89.51</td></tr> <tr><td>50-99</td><td>\$84.80</td></tr> <tr><td>100+</td><td>\$81.03</td></tr> </tbody> </table> <p>SMA Male to HN Male VSWR 1.4:1 to 4 GHz</p> <p>Model No: <a href="#">PE91448</a></p>	PRICE		1-24	\$94.22	25-49	\$89.51	50-99	\$84.80	100+	\$81.03	 <table border="1"> <thead> <tr> <th colspan="2">PRICE</th> </tr> </thead> <tbody> <tr><td>1-9</td><td>\$140.65</td></tr> <tr><td>10-24</td><td>\$133.62</td></tr> <tr><td>25-49</td><td>\$126.59</td></tr> <tr><td>50+</td><td>\$120.96</td></tr> </tbody> </table> <p>SMA Male to HN Female</p> <p>Model No: <a href="#">PE9256</a></p>	PRICE		1-9	\$140.65	10-24	\$133.62	25-49	\$126.59	50+	\$120.96	 <table border="1"> <thead> <tr> <th colspan="2">PRICE</th> </tr> </thead> <tbody> <tr><td>1-24</td><td>\$115.40</td></tr> <tr><td>25-49</td><td>\$109.63</td></tr> <tr><td>50-99</td><td>\$103.86</td></tr> <tr><td>100+</td><td>\$99.24</td></tr> </tbody> </table> <p>SMA Male to MCX Plug</p> <p>Model No: <a href="#">PE9473</a></p>	PRICE		1-24	\$115.40	25-49	\$109.63	50-99	\$103.86	100+	\$99.24	 <table border="1"> <thead> <tr> <th colspan="2">PRICE</th> </tr> </thead> <tbody> <tr><td>1-24</td><td>\$104.58</td></tr> <tr><td>25-49</td><td>\$99.35</td></tr> <tr><td>50-99</td><td>\$94.12</td></tr> <tr><td>100+</td><td>\$89.94</td></tr> </tbody> </table> <p>SMA Male to MCX Jack</p> <p>Model No: <a href="#">PE9472</a></p>	PRICE		1-24	\$104.58	25-49	\$99.35	50-99	\$94.12	100+	\$89.94
PRICE																																																							
1-9	\$247.78																																																						
10-24	\$235.39																																																						
25-49	\$223.00																																																						
50+	\$213.09																																																						
PRICE																																																							
1-24	\$94.22																																																						
25-49	\$89.51																																																						
50-99	\$84.80																																																						
100+	\$81.03																																																						
PRICE																																																							
1-9	\$140.65																																																						
10-24	\$133.62																																																						
25-49	\$126.59																																																						
50+	\$120.96																																																						
PRICE																																																							
1-24	\$115.40																																																						
25-49	\$109.63																																																						
50-99	\$103.86																																																						
100+	\$99.24																																																						
PRICE																																																							
1-24	\$104.58																																																						
25-49	\$99.35																																																						
50-99	\$94.12																																																						
100+	\$89.94																																																						
7	 <table border="1"> <thead> <tr> <th colspan="2">PRICE</th> </tr> </thead> <tbody> <tr><td>1-24</td><td>\$90.72</td></tr> <tr><td>25-49</td><td>\$86.18</td></tr> <tr><td>50-99</td><td>\$81.65</td></tr> <tr><td>100+</td><td>\$78.02</td></tr> </tbody> </table> <p>SMA Male to Full Detent Mini SMP Male VSWR 1.2:1 to 18 GHz</p> <p>Model No: <a href="#">PE91302</a></p>	PRICE		1-24	\$90.72	25-49	\$86.18	50-99	\$81.65	100+	\$78.02	 <table border="1"> <thead> <tr> <th colspan="2">PRICE</th> </tr> </thead> <tbody> <tr><td>1-24</td><td>\$102.28</td></tr> <tr><td>25-49</td><td>\$97.17</td></tr> <tr><td>50-99</td><td>\$92.05</td></tr> <tr><td>100+</td><td>\$87.96</td></tr> </tbody> </table> <p>SMA Male to Smooth Bore Mini SMP Male VSWR 1.2:1 to 18 GHz</p> <p>Model No: <a href="#">PE91303</a></p>	PRICE		1-24	\$102.28	25-49	\$97.17	50-99	\$92.05	100+	\$87.96	 <table border="1"> <thead> <tr> <th colspan="2">PRICE</th> </tr> </thead> <tbody> <tr><td>1-9</td><td>\$191.34</td></tr> <tr><td>10-24</td><td>\$181.77</td></tr> <tr><td>25-49</td><td>\$172.21</td></tr> <tr><td>50+</td><td>\$164.55</td></tr> </tbody> </table> <p>PRECISION SMA Male to Full Detent Mini SMP Male VSWR 1.2:1 to 26.5 GHz</p> <p>Model No: <a href="#">PE91052</a></p>	PRICE		1-9	\$191.34	10-24	\$181.77	25-49	\$172.21	50+	\$164.55	 <table border="1"> <thead> <tr> <th colspan="2">PRICE</th> </tr> </thead> <tbody> <tr><td>1-24</td><td>\$92.42</td></tr> <tr><td>25-49</td><td>\$87.80</td></tr> <tr><td>50-99</td><td>\$83.18</td></tr> <tr><td>100+</td><td>\$79.48</td></tr> </tbody> </table> <p>SMA Male to Mini SMP Female VSWR 1.2:1 to 18 GHz</p> <p>Model No: <a href="#">PE91304</a></p>	PRICE		1-24	\$92.42	25-49	\$87.80	50-99	\$83.18	100+	\$79.48	 <table border="1"> <thead> <tr> <th colspan="2">PRICE</th> </tr> </thead> <tbody> <tr><td>1-9</td><td>\$233.30</td></tr> <tr><td>10-24</td><td>\$221.64</td></tr> <tr><td>25-49</td><td>\$209.97</td></tr> <tr><td>50+</td><td>\$200.64</td></tr> </tbody> </table> <p>PRECISION SMA Male to Mini SMP Female VSWR 1.2:1 to 26.5 GHz</p> <p>Model No: <a href="#">PE91103</a></p>	PRICE		1-9	\$233.30	10-24	\$221.64	25-49	\$209.97	50+	\$200.64
PRICE																																																							
1-24	\$90.72																																																						
25-49	\$86.18																																																						
50-99	\$81.65																																																						
100+	\$78.02																																																						
PRICE																																																							
1-24	\$102.28																																																						
25-49	\$97.17																																																						
50-99	\$92.05																																																						
100+	\$87.96																																																						
PRICE																																																							
1-9	\$191.34																																																						
10-24	\$181.77																																																						
25-49	\$172.21																																																						
50+	\$164.55																																																						
PRICE																																																							
1-24	\$92.42																																																						
25-49	\$87.80																																																						
50-99	\$83.18																																																						
100+	\$79.48																																																						
PRICE																																																							
1-9	\$233.30																																																						
10-24	\$221.64																																																						
25-49	\$209.97																																																						
50+	\$200.64																																																						

# ADAPTERS

See Adapter Locator on Pages 10-15  
See Page 409 for Mounting Holes

	A	B	C	D	E																																													
1	 <table border="1"> <thead> <tr><th>PRICE</th></tr> </thead> <tbody> <tr><td>1-9</td><td>\$129.75</td></tr> <tr><td>10-24</td><td>\$123.26</td></tr> <tr><td>25-49</td><td>\$116.78</td></tr> <tr><td>50+</td><td>\$111.59</td></tr> </tbody> </table> <p>SMA Male to MMCX Plug</p> <p>Model No: <a href="#">PE9476</a></p>	PRICE	1-9	\$129.75	10-24	\$123.26	25-49	\$116.78	50+	\$111.59	 <table border="1"> <thead> <tr><th>PRICE</th></tr> </thead> <tbody> <tr><td>1-24</td><td>\$96.80</td></tr> <tr><td>25-49</td><td>\$91.96</td></tr> <tr><td>50-99</td><td>\$87.12</td></tr> <tr><td>100+</td><td>\$83.25</td></tr> </tbody> </table> <p>SMA Male to MMCX Jack</p> <p>Model No: <a href="#">PE9478</a></p>	PRICE	1-24	\$96.80	25-49	\$91.96	50-99	\$87.12	100+	\$83.25	 <table border="1"> <thead> <tr><th>PRICE</th></tr> </thead> <tbody> <tr><td>1-9</td><td>\$252.30</td></tr> <tr><td>10-24</td><td>\$239.69</td></tr> <tr><td>25-49</td><td>\$227.07</td></tr> <tr><td>50+</td><td>\$216.98</td></tr> </tbody> </table> <p>SMA Male to Snap-On MMBX Plug</p> <p>VSWR 1.2:1 to 12.4 GHz</p> <p>Model No: <a href="#">PE91360</a></p>	PRICE	1-9	\$252.30	10-24	\$239.69	25-49	\$227.07	50+	\$216.98	 <table border="1"> <thead> <tr><th>PRICE</th></tr> </thead> <tbody> <tr><td>1-9</td><td>\$187.57</td></tr> <tr><td>10-24</td><td>\$178.19</td></tr> <tr><td>25-49</td><td>\$168.81</td></tr> <tr><td>50+</td><td>\$161.31</td></tr> </tbody> </table> <p>SMA Male to Snap-On MMBX Jack</p> <p>VSWR 1.08:1 to 12.4 GHz</p> <p>Model No: <a href="#">PE91362</a></p>	PRICE	1-9	\$187.57	10-24	\$178.19	25-49	\$168.81	50+	\$161.31	 <table border="1"> <thead> <tr><th>PRICE</th></tr> </thead> <tbody> <tr><td>1-24</td><td>\$24.85</td></tr> <tr><td>25-49</td><td>\$23.61</td></tr> <tr><td>50-99</td><td>\$22.37</td></tr> <tr><td>100+</td><td>\$21.37</td></tr> </tbody> </table> <p>SMA Male to N Male</p> <p>VSWR 1.3:1 to 11 GHz</p> <p>Model No: <a href="#">PE9080</a></p>	PRICE	1-24	\$24.85	25-49	\$23.61	50-99	\$22.37	100+	\$21.37
	PRICE																																																	
1-9	\$129.75																																																	
10-24	\$123.26																																																	
25-49	\$116.78																																																	
50+	\$111.59																																																	
PRICE																																																		
1-24	\$96.80																																																	
25-49	\$91.96																																																	
50-99	\$87.12																																																	
100+	\$83.25																																																	
PRICE																																																		
1-9	\$252.30																																																	
10-24	\$239.69																																																	
25-49	\$227.07																																																	
50+	\$216.98																																																	
PRICE																																																		
1-9	\$187.57																																																	
10-24	\$178.19																																																	
25-49	\$168.81																																																	
50+	\$161.31																																																	
PRICE																																																		
1-24	\$24.85																																																	
25-49	\$23.61																																																	
50-99	\$22.37																																																	
100+	\$21.37																																																	
2	 <table border="1"> <thead> <tr><th>PRICE</th></tr> </thead> <tbody> <tr><td>1-9</td><td>\$140.50</td></tr> <tr><td>10-24</td><td>\$133.48</td></tr> <tr><td>25-49</td><td>\$126.45</td></tr> <tr><td>50+</td><td>\$120.83</td></tr> </tbody> </table> <p>PRECISION SMA Male to N Male</p> <p>VSWR 1.15:1 to 18 GHz</p> <p>Model No: <a href="#">PE9431</a></p>	PRICE	1-9	\$140.50	10-24	\$133.48	25-49	\$126.45	50+	\$120.83	 <table border="1"> <thead> <tr><th>PRICE</th></tr> </thead> <tbody> <tr><td>1-9</td><td>\$144.84</td></tr> <tr><td>10-24</td><td>\$137.60</td></tr> <tr><td>25-49</td><td>\$130.36</td></tr> <tr><td>50+</td><td>\$124.56</td></tr> </tbody> </table> <p>PRECISION SMA Male to N Male 4 Hole Flange-Mounting Hole A05</p> <p>VSWR 1.15:1 to 18 GHz</p> <p>Model No: <a href="#">PE9499</a></p>	PRICE	1-9	\$144.84	10-24	\$137.60	25-49	\$130.36	50+	\$124.56	 <table border="1"> <thead> <tr><th>PRICE</th></tr> </thead> <tbody> <tr><td>1-24</td><td>\$23.31</td></tr> <tr><td>25-49</td><td>\$22.14</td></tr> <tr><td>50-99</td><td>\$20.98</td></tr> <tr><td>100+</td><td>\$20.05</td></tr> </tbody> </table> <p>PRECISION SMA Male to N Female</p> <p>VSWR 1.3:1 to 11 GHz</p> <p>Model No: <a href="#">PE9082</a></p>	PRICE	1-24	\$23.31	25-49	\$22.14	50-99	\$20.98	100+	\$20.05	 <table border="1"> <thead> <tr><th>PRICE</th></tr> </thead> <tbody> <tr><td>1-24</td><td>\$104.18</td></tr> <tr><td>25-49</td><td>\$98.97</td></tr> <tr><td>50-99</td><td>\$93.76</td></tr> <tr><td>100+</td><td>\$89.59</td></tr> </tbody> </table> <p>PRECISION SMA Male to N Female</p> <p>VSWR 1.15:1 to 18 GHz</p> <p>Model No: <a href="#">PE9433</a></p>	PRICE	1-24	\$104.18	25-49	\$98.97	50-99	\$93.76	100+	\$89.59	 <table border="1"> <thead> <tr><th>PRICE</th></tr> </thead> <tbody> <tr><td>1-9</td><td>\$187.66</td></tr> <tr><td>10-24</td><td>\$178.28</td></tr> <tr><td>25-49</td><td>\$168.89</td></tr> <tr><td>50+</td><td>\$161.39</td></tr> </tbody> </table> <p>PRECISION SMA Male to N Female Bulkhead</p> <p>VSWR 1.15:1 to 18 GHz</p> <p>Model No: <a href="#">PE9487</a></p>	PRICE	1-9	\$187.66	10-24	\$178.28	25-49	\$168.89	50+	\$161.39
	PRICE																																																	
1-9	\$140.50																																																	
10-24	\$133.48																																																	
25-49	\$126.45																																																	
50+	\$120.83																																																	
PRICE																																																		
1-9	\$144.84																																																	
10-24	\$137.60																																																	
25-49	\$130.36																																																	
50+	\$124.56																																																	
PRICE																																																		
1-24	\$23.31																																																	
25-49	\$22.14																																																	
50-99	\$20.98																																																	
100+	\$20.05																																																	
PRICE																																																		
1-24	\$104.18																																																	
25-49	\$98.97																																																	
50-99	\$93.76																																																	
100+	\$89.59																																																	
PRICE																																																		
1-9	\$187.66																																																	
10-24	\$178.28																																																	
25-49	\$168.89																																																	
50+	\$161.39																																																	
3	 <table border="1"> <thead> <tr><th>PRICE</th></tr> </thead> <tbody> <tr><td>1-24</td><td>\$103.44</td></tr> <tr><td>25-49</td><td>\$98.27</td></tr> <tr><td>50-99</td><td>\$93.10</td></tr> <tr><td>100+</td><td>\$88.96</td></tr> </tbody> </table> <p>SMA Male to N Female 4 Hole Flange</p> <p>VSWR 1.4:1 to 18 GHz</p> <p>Model No: <a href="#">PE9105</a></p>	PRICE	1-24	\$103.44	25-49	\$98.27	50-99	\$93.10	100+	\$88.96	 <table border="1"> <thead> <tr><th>PRICE</th></tr> </thead> <tbody> <tr><td>1-9</td><td>\$199.14</td></tr> <tr><td>10-24</td><td>\$189.18</td></tr> <tr><td>25-49</td><td>\$179.23</td></tr> <tr><td>50+</td><td>\$171.26</td></tr> </tbody> </table> <p>PRECISION SMA Male to N Female 4 Hole Flange</p> <p>VSWR 1.15:1 to 18 GHz</p> <p>Model No: <a href="#">PE9497</a></p>	PRICE	1-9	\$199.14	10-24	\$189.18	25-49	\$179.23	50+	\$171.26	 <table border="1"> <thead> <tr><th>PRICE</th></tr> </thead> <tbody> <tr><td>1-9</td><td>\$181.86</td></tr> <tr><td>10-24</td><td>\$172.77</td></tr> <tr><td>25-49</td><td>\$163.67</td></tr> <tr><td>50+</td><td>\$156.40</td></tr> </tbody> </table> <p>PRECISION SMA Male to N Female Bulkhead</p> <p>VSWR 1.15:1 to 18 GHz</p> <p>Model No: <a href="#">PE9488</a></p>	PRICE	1-9	\$181.86	10-24	\$172.77	25-49	\$163.67	50+	\$156.40	 <table border="1"> <thead> <tr><th>PRICE</th></tr> </thead> <tbody> <tr><td>1-24</td><td>\$23.72</td></tr> <tr><td>25-49</td><td>\$22.77</td></tr> <tr><td>50-99</td><td>\$22.06</td></tr> <tr><td>100+</td><td>\$21.59</td></tr> </tbody> </table> <p>Push-On SMA Male to SMA Female</p> <p>VSWR 1.5:1 to 18 GHz</p> <p>Model No: <a href="#">PE91336</a></p>	PRICE	1-24	\$23.72	25-49	\$22.77	50-99	\$22.06	100+	\$21.59	 <table border="1"> <thead> <tr><th>PRICE</th></tr> </thead> <tbody> <tr><td>1-24</td><td>\$90.68</td></tr> <tr><td>25-49</td><td>\$86.15</td></tr> <tr><td>50-99</td><td>\$81.61</td></tr> <tr><td>100+</td><td>\$77.98</td></tr> </tbody> </table> <p>SMA Male to SMB Plug</p> <p>VSWR 1.25:1 to 4 GHz</p> <p>Model No: <a href="#">PE9144</a></p>	PRICE	1-24	\$90.68	25-49	\$86.15	50-99	\$81.61	100+	\$77.98
	PRICE																																																	
1-24	\$103.44																																																	
25-49	\$98.27																																																	
50-99	\$93.10																																																	
100+	\$88.96																																																	
PRICE																																																		
1-9	\$199.14																																																	
10-24	\$189.18																																																	
25-49	\$179.23																																																	
50+	\$171.26																																																	
PRICE																																																		
1-9	\$181.86																																																	
10-24	\$172.77																																																	
25-49	\$163.67																																																	
50+	\$156.40																																																	
PRICE																																																		
1-24	\$23.72																																																	
25-49	\$22.77																																																	
50-99	\$22.06																																																	
100+	\$21.59																																																	
PRICE																																																		
1-24	\$90.68																																																	
25-49	\$86.15																																																	
50-99	\$81.61																																																	
100+	\$77.98																																																	
4	 <table border="1"> <thead> <tr><th>PRICE</th></tr> </thead> <tbody> <tr><td>1-24</td><td>\$24.84</td></tr> <tr><td>25-49</td><td>\$23.60</td></tr> <tr><td>50-99</td><td>\$22.36</td></tr> <tr><td>100+</td><td>\$21.36</td></tr> </tbody> </table> <p>SMA Male to SMB Jack</p> <p>VSWR 1.25:1 to 4 GHz</p> <p>Model No: <a href="#">PE9145</a></p>	PRICE	1-24	\$24.84	25-49	\$23.60	50-99	\$22.36	100+	\$21.36	 <table border="1"> <thead> <tr><th>PRICE</th></tr> </thead> <tbody> <tr><td>1-24</td><td>\$72.20</td></tr> <tr><td>25-49</td><td>\$68.59</td></tr> <tr><td>50-99</td><td>\$64.98</td></tr> <tr><td>100+</td><td>\$62.09</td></tr> </tbody> </table> <p>SMA Male to SMC Plug</p> <p>Max. Freq. 10 GHz</p> <p>Model No: <a href="#">PE9148</a></p>	PRICE	1-24	\$72.20	25-49	\$68.59	50-99	\$64.98	100+	\$62.09	 <table border="1"> <thead> <tr><th>PRICE</th></tr> </thead> <tbody> <tr><td>1-24</td><td>\$61.70</td></tr> <tr><td>25-49</td><td>\$58.62</td></tr> <tr><td>50-99</td><td>\$55.53</td></tr> <tr><td>100+</td><td>\$53.06</td></tr> </tbody> </table> <p>SMA Male to SMC Jack</p> <p>VSWR 1.2:1 to 10 GHz</p> <p>Model No: <a href="#">PE9149</a></p>	PRICE	1-24	\$61.70	25-49	\$58.62	50-99	\$55.53	100+	\$53.06	 <table border="1"> <thead> <tr><th>PRICE</th></tr> </thead> <tbody> <tr><td>1-24</td><td>\$72.93</td></tr> <tr><td>25-49</td><td>\$69.28</td></tr> <tr><td>50-99</td><td>\$65.64</td></tr> <tr><td>100+</td><td>\$62.72</td></tr> </tbody> </table> <p>SMA Male to Full Detent SMP Male</p> <p>VSWR 1.2:1 to 18 GHz</p> <p>Model No: <a href="#">PE91309</a></p>	PRICE	1-24	\$72.93	25-49	\$69.28	50-99	\$65.64	100+	\$62.72	 <table border="1"> <thead> <tr><th>PRICE</th></tr> </thead> <tbody> <tr><td>1-24</td><td>\$71.61</td></tr> <tr><td>25-49</td><td>\$68.03</td></tr> <tr><td>50-99</td><td>\$64.45</td></tr> <tr><td>100+</td><td>\$61.58</td></tr> </tbody> </table> <p>SMA Male to Limited Detent SMP Male</p> <p>VSWR 1.2:1 to 18 GHz</p> <p>Model No: <a href="#">PE91310</a></p>	PRICE	1-24	\$71.61	25-49	\$68.03	50-99	\$64.45	100+	\$61.58
	PRICE																																																	
1-24	\$24.84																																																	
25-49	\$23.60																																																	
50-99	\$22.36																																																	
100+	\$21.36																																																	
PRICE																																																		
1-24	\$72.20																																																	
25-49	\$68.59																																																	
50-99	\$64.98																																																	
100+	\$62.09																																																	
PRICE																																																		
1-24	\$61.70																																																	
25-49	\$58.62																																																	
50-99	\$55.53																																																	
100+	\$53.06																																																	
PRICE																																																		
1-24	\$72.93																																																	
25-49	\$69.28																																																	
50-99	\$65.64																																																	
100+	\$62.72																																																	
PRICE																																																		
1-24	\$71.61																																																	
25-49	\$68.03																																																	
50-99	\$64.45																																																	
100+	\$61.58																																																	
5	 <table border="1"> <thead> <tr><th>PRICE</th></tr> </thead> <tbody> <tr><td>1-24</td><td>\$71.61</td></tr> <tr><td>25-49</td><td>\$68.03</td></tr> <tr><td>50-99</td><td>\$64.45</td></tr> <tr><td>100+</td><td>\$61.58</td></tr> </tbody> </table> <p>SMA Male to Smooth Bore SMP Male</p> <p>VSWR 1.2:1 to 18 GHz</p> <p>Model No: <a href="#">PE91311</a></p>	PRICE	1-24	\$71.61	25-49	\$68.03	50-99	\$64.45	100+	\$61.58	 <table border="1"> <thead> <tr><th>PRICE</th></tr> </thead> <tbody> <tr><td>1-9</td><td>\$128.61</td></tr> <tr><td>10-24</td><td>\$122.18</td></tr> <tr><td>25-49</td><td>\$115.75</td></tr> <tr><td>50+</td><td>\$110.60</td></tr> </tbody> </table> <p>PRECISION SMA Male to Full Detent SMP Male</p> <p>VSWR 1.2:1 to 26.5 GHz</p> <p>Model No: <a href="#">PE91063</a></p>	PRICE	1-9	\$128.61	10-24	\$122.18	25-49	\$115.75	50+	\$110.60	 <table border="1"> <thead> <tr><th>PRICE</th></tr> </thead> <tbody> <tr><td>1-9</td><td>\$170.39</td></tr> <tr><td>10-24</td><td>\$161.87</td></tr> <tr><td>25-49</td><td>\$153.35</td></tr> <tr><td>50+</td><td>\$146.54</td></tr> </tbody> </table> <p>PRECISION SMA Male to Limited Detent SMP Male</p> <p>VSWR 1.2:1 to 18 GHz</p> <p>Model No: <a href="#">PE9511</a></p>	PRICE	1-9	\$170.39	10-24	\$161.87	25-49	\$153.35	50+	\$146.54	 <table border="1"> <thead> <tr><th>PRICE</th></tr> </thead> <tbody> <tr><td>1-24</td><td>\$72.93</td></tr> <tr><td>25-49</td><td>\$69.28</td></tr> <tr><td>50-99</td><td>\$65.64</td></tr> <tr><td>100+</td><td>\$62.72</td></tr> </tbody> </table> <p>SMA Male to SMP Female</p> <p>VSWR 1.2:1 to 18 GHz</p> <p>Model No: <a href="#">PE91312</a></p>	PRICE	1-24	\$72.93	25-49	\$69.28	50-99	\$65.64	100+	\$62.72	 <table border="1"> <thead> <tr><th>PRICE</th></tr> </thead> <tbody> <tr><td>1-9</td><td>\$159.64</td></tr> <tr><td>10-24</td><td>\$151.66</td></tr> <tr><td>25-49</td><td>\$143.68</td></tr> <tr><td>50+</td><td>\$137.29</td></tr> </tbody> </table> <p>PRECISION SMA Male to SMP Female</p> <p>VSWR 1.2:1 to 26.5 GHz</p> <p>Model No: <a href="#">PE91062</a></p>	PRICE	1-9	\$159.64	10-24	\$151.66	25-49	\$143.68	50+	\$137.29
	PRICE																																																	
1-24	\$71.61																																																	
25-49	\$68.03																																																	
50-99	\$64.45																																																	
100+	\$61.58																																																	
PRICE																																																		
1-9	\$128.61																																																	
10-24	\$122.18																																																	
25-49	\$115.75																																																	
50+	\$110.60																																																	
PRICE																																																		
1-9	\$170.39																																																	
10-24	\$161.87																																																	
25-49	\$153.35																																																	
50+	\$146.54																																																	
PRICE																																																		
1-24	\$72.93																																																	
25-49	\$69.28																																																	
50-99	\$65.64																																																	
100+	\$62.72																																																	
PRICE																																																		
1-9	\$159.64																																																	
10-24	\$151.66																																																	
25-49	\$143.68																																																	
50+	\$137.29																																																	
6	 <table border="1"> <thead> <tr><th>PRICE</th></tr> </thead> <tbody> <tr><td>1-9</td><td>\$194.92</td></tr> <tr><td>10-24</td><td>\$185.17</td></tr> <tr><td>25-49</td><td>\$175.43</td></tr> <tr><td>50+</td><td>\$167.63</td></tr> </tbody> </table> <p>PRECISION SMA Male to SMP Female</p> <p>VSWR 1.2:1 to 18 GHz</p> <p>Model No: <a href="#">PE9513</a></p>	PRICE	1-9	\$194.92	10-24	\$185.17	25-49	\$175.43	50+	\$167.63	 <table border="1"> <thead> <tr><th>PRICE</th></tr> </thead> <tbody> <tr><td>1-24</td><td>\$102.21</td></tr> <tr><td>25-49</td><td>\$97.10</td></tr> <tr><td>50-99</td><td>\$91.99</td></tr> <tr><td>100+</td><td>\$87.90</td></tr> </tbody> </table> <p>SMA Male to SSMA Male</p> <p>VSWR 1.25:1 to 26.5 GHz</p> <p>Model No: <a href="#">PE9187</a></p>	PRICE	1-24	\$102.21	25-49	\$97.10	50-99	\$91.99	100+	\$87.90	 <table border="1"> <thead> <tr><th>PRICE</th></tr> </thead> <tbody> <tr><td>1-24</td><td>\$67.36</td></tr> <tr><td>25-49</td><td>\$63.99</td></tr> <tr><td>50-99</td><td>\$60.62</td></tr> <tr><td>100+</td><td>\$57.93</td></tr> </tbody> </table> <p>SMA Male to SSMA Female</p> <p>VSWR 1.4:1 to 18 GHz</p> <p>Model No: <a href="#">PE9063</a></p>	PRICE	1-24	\$67.36	25-49	\$63.99	50-99	\$60.62	100+	\$57.93	 <table border="1"> <thead> <tr><th>PRICE</th></tr> </thead> <tbody> <tr><td>1-24</td><td>\$95.54</td></tr> <tr><td>25-49</td><td>\$90.76</td></tr> <tr><td>50-99</td><td>\$85.99</td></tr> <tr><td>100+</td><td>\$82.16</td></tr> </tbody> </table> <p>SMA Male to SSMB Jack</p> <p>Model No: <a href="#">PE9401</a></p>	PRICE	1-24	\$95.54	25-49	\$90.76	50-99	\$85.99	100+	\$82.16	 <table border="1"> <thead> <tr><th>PRICE</th></tr> </thead> <tbody> <tr><td>1-24</td><td>\$44.70</td></tr> <tr><td>25-49</td><td>\$42.47</td></tr> <tr><td>50-99</td><td>\$40.23</td></tr> <tr><td>100+</td><td>\$38.44</td></tr> </tbody> </table> <p>SMA Male to TNC Male</p> <p>VSWR 1.3:1 to 11 GHz</p> <p>Model No: <a href="#">PE9076</a></p>	PRICE	1-24	\$44.70	25-49	\$42.47	50-99	\$40.23	100+	\$38.44
	PRICE																																																	
1-9	\$194.92																																																	
10-24	\$185.17																																																	
25-49	\$175.43																																																	
50+	\$167.63																																																	
PRICE																																																		
1-24	\$102.21																																																	
25-49	\$97.10																																																	
50-99	\$91.99																																																	
100+	\$87.90																																																	
PRICE																																																		
1-24	\$67.36																																																	
25-49	\$63.99																																																	
50-99	\$60.62																																																	
100+	\$57.93																																																	
PRICE																																																		
1-24	\$95.54																																																	
25-49	\$90.76																																																	
50-99	\$85.99																																																	
100+	\$82.16																																																	
PRICE																																																		
1-24	\$44.70																																																	
25-49	\$42.47																																																	
50-99	\$40.23																																																	
100+	\$38.44																																																	
7	 <table border="1"> <thead> <tr><th>PRICE</th></tr> </thead> <tbody> <tr><td>1-9</td><td>\$139.58</td></tr> <tr><td>10-24</td><td>\$132.60</td></tr> <tr><td>25-49</td><td>\$125.62</td></tr> <tr><td>50+</td><td>\$120.04</td></tr> </tbody> </table> <p>SMA Male to TNC Male</p> <p>VSWR 1.25:1 to 18 GHz</p> <p>Model No: <a href="#">PE9439</a></p>	PRICE	1-9	\$139.58	10-24	\$132.60	25-49	\$125.62	50+	\$120.04	 <table border="1"> <thead> <tr><th>PRICE</th></tr> </thead> <tbody> <tr><td>1-24</td><td>\$46.76</td></tr> <tr><td>25-49</td><td>\$44.42</td></tr> <tr><td>50-99</td><td>\$42.08</td></tr> <tr><td>100+</td><td>\$40.21</td></tr> </tbody> </table> <p>SMA Male to TNC Female</p> <p>VSWR 1.3:1 to 11 GHz</p> <p>Model No: <a href="#">PE9078</a></p>	PRICE	1-24	\$46.76	25-49	\$44.42	50-99	\$42.08	100+	\$40.21	 <table border="1"> <thead> <tr><th>PRICE</th></tr> </thead> <tbody> <tr><td>1-24</td><td>\$111.78</td></tr> <tr><td>25-49</td><td>\$103.96</td></tr> <tr><td>50-99</td><td>\$96.13</td></tr> <tr><td>100+</td><td>\$89.42</td></tr> </tbody> </table> <p>SMA Male to TNC Female</p> <p>VSWR 1.2:1 to 18 GHz</p> <p>Model No: <a href="#">PE91507</a></p>	PRICE	1-24	\$111.78	25-49	\$103.96	50-99	\$96.13	100+	\$89.42	 <table border="1"> <thead> <tr><th>PRICE</th></tr> </thead> <tbody> <tr><td>1-24</td><td>\$97.25</td></tr> <tr><td>25-49</td><td>\$92.39</td></tr> <tr><td>50-99</td><td>\$87.53</td></tr> <tr><td>100+</td><td>\$83.64</td></tr> </tbody> </table> <p>SMA Male to TNC Female 4 Hole Flange-Mounting Hole A04</p> <p>VSWR 1.3:1 to 11 GHz</p> <p>Model No: <a href="#">PE9384</a></p>	PRICE	1-24	\$97.25	25-49	\$92.39	50-99	\$87.53	100+	\$83.64	 <table border="1"> <thead> <tr><th>PRICE</th></tr> </thead> <tbody> <tr><td>1-24</td><td>\$49.16</td></tr> <tr><td>25-49</td><td>\$46.70</td></tr> <tr><td>50-99</td><td>\$44.24</td></tr> <tr><td>100+</td><td>\$42.28</td></tr> </tbody> </table> <p>SMA Male to UHF Female</p> <p>Model No: <a href="#">PE9400</a></p>	PRICE	1-24	\$49.16	25-49	\$46.70	50-99	\$44.24	100+	\$42.28
	PRICE																																																	
1-9	\$139.58																																																	
10-24	\$132.60																																																	
25-49	\$125.62																																																	
50+	\$120.04																																																	
PRICE																																																		
1-24	\$46.76																																																	
25-49	\$44.42																																																	
50-99	\$42.08																																																	
100+	\$40.21																																																	
PRICE																																																		
1-24	\$111.78																																																	
25-49	\$103.96																																																	
50-99	\$96.13																																																	
100+	\$89.42																																																	
PRICE																																																		
1-24	\$97.25																																																	
25-49	\$92.39																																																	
50-99	\$87.53																																																	
100+	\$83.64																																																	
PRICE																																																		
1-24	\$49.16																																																	
25-49	\$46.70																																																	
50-99	\$44.24																																																	
100+	\$42.28																																																	



Technical Support  
+1 (949) 261-1920



Same-Day Shipping,  
Even Custom Cable Assemblies

# ADAPTERS

See Adapter Locator on Pages 10-15

See Page 409 for Mounting Holes

Adapters

See Our Website For Current Pricing & Real-Time Stock Availability!

	A	B	C	D	E																																																		
1	 <table border="1"> <thead> <tr> <th colspan="2">PRICE</th> </tr> </thead> <tbody> <tr> <td>1-24</td> <td>\$30.20</td> </tr> <tr> <td>25-49</td> <td>\$28.69</td> </tr> <tr> <td>50-99</td> <td>\$27.18</td> </tr> <tr> <td>100+</td> <td>\$25.97</td> </tr> </tbody> </table> <p><b>SMA Male to UMCX Jack</b> VSWR 1.3:1 to 6 GHz</p> <p>Model No: <a href="#">PE91007</a></p>	PRICE		1-24	\$30.20	25-49	\$28.69	50-99	\$27.18	100+	\$25.97	 <table border="1"> <thead> <tr> <th colspan="2">PRICE</th> </tr> </thead> <tbody> <tr> <td>1-24</td> <td>\$98.85</td> </tr> <tr> <td>25-49</td> <td>\$93.91</td> </tr> <tr> <td>50-99</td> <td>\$88.97</td> </tr> <tr> <td>100+</td> <td>\$85.01</td> </tr> </tbody> </table> <p><b>SMA Female to 1.0/2.3 Plug</b></p> <p>Model No: <a href="#">PE9691</a></p>	PRICE		1-24	\$98.85	25-49	\$93.91	50-99	\$88.97	100+	\$85.01	 <table border="1"> <thead> <tr> <th colspan="2">PRICE</th> </tr> </thead> <tbody> <tr> <td>1-24</td> <td>\$86.17</td> </tr> <tr> <td>25-49</td> <td>\$81.86</td> </tr> <tr> <td>50-99</td> <td>\$77.55</td> </tr> <tr> <td>100+</td> <td>\$74.11</td> </tr> </tbody> </table> <p><b>SMA Female to 1.0/2.3 Jack</b></p> <p>Model No: <a href="#">PE9693</a></p>	PRICE		1-24	\$86.17	25-49	\$81.86	50-99	\$77.55	100+	\$74.11	 <table border="1"> <thead> <tr> <th colspan="2">PRICE</th> </tr> </thead> <tbody> <tr> <td>1-9</td> <td>\$213.55</td> </tr> <tr> <td>10-24</td> <td>\$202.87</td> </tr> <tr> <td>25-49</td> <td>\$192.20</td> </tr> <tr> <td>50+</td> <td>\$183.65</td> </tr> </tbody> </table> <p><b>SMA Female to 1.85mm Male</b> VSWR 1.3:1 to 18 GHz</p> <p>Model No: <a href="#">PE9726</a></p>	PRICE		1-9	\$213.55	10-24	\$202.87	25-49	\$192.20	50+	\$183.65	 <table border="1"> <thead> <tr> <th colspan="2">PRICE</th> </tr> </thead> <tbody> <tr> <td>1-9</td> <td>\$220.53</td> </tr> <tr> <td>10-24</td> <td>\$209.50</td> </tr> <tr> <td>25-49</td> <td>\$198.48</td> </tr> <tr> <td>50+</td> <td>\$189.66</td> </tr> </tbody> </table> <p><b>SMA Female to 1.85mm Female</b> VSWR 1.3:1 to 18 GHz</p> <p>Model No: <a href="#">PE9729</a></p>	PRICE		1-9	\$220.53	10-24	\$209.50	25-49	\$198.48	50+	\$189.66
	PRICE																																																						
1-24	\$30.20																																																						
25-49	\$28.69																																																						
50-99	\$27.18																																																						
100+	\$25.97																																																						
PRICE																																																							
1-24	\$98.85																																																						
25-49	\$93.91																																																						
50-99	\$88.97																																																						
100+	\$85.01																																																						
PRICE																																																							
1-24	\$86.17																																																						
25-49	\$81.86																																																						
50-99	\$77.55																																																						
100+	\$74.11																																																						
PRICE																																																							
1-9	\$213.55																																																						
10-24	\$202.87																																																						
25-49	\$192.20																																																						
50+	\$183.65																																																						
PRICE																																																							
1-9	\$220.53																																																						
10-24	\$209.50																																																						
25-49	\$198.48																																																						
50+	\$189.66																																																						
2	 <table border="1"> <thead> <tr> <th colspan="2">PRICE</th> </tr> </thead> <tbody> <tr> <td>1-9</td> <td>\$218.61</td> </tr> <tr> <td>10-24</td> <td>\$207.68</td> </tr> <tr> <td>25-49</td> <td>\$196.75</td> </tr> <tr> <td>50+</td> <td>\$188.00</td> </tr> </tbody> </table> <p><b>SMA Female to 2.4mm Male</b> VSWR 1.2:1 to 27 GHz</p> <p>Model No: <a href="#">PE9655</a></p>	PRICE		1-9	\$218.61	10-24	\$207.68	25-49	\$196.75	50+	\$188.00	 <table border="1"> <thead> <tr> <th colspan="2">PRICE</th> </tr> </thead> <tbody> <tr> <td>1-9</td> <td>\$223.31</td> </tr> <tr> <td>10-24</td> <td>\$212.14</td> </tr> <tr> <td>25-49</td> <td>\$200.98</td> </tr> <tr> <td>50+</td> <td>\$192.05</td> </tr> </tbody> </table> <p><b>SMA Female to 2.4mm Female</b> VSWR 1.2:1 to 26.5 GHz</p> <p>Model No: <a href="#">PE9656</a></p>	PRICE		1-9	\$223.31	10-24	\$212.14	25-49	\$200.98	50+	\$192.05	 <table border="1"> <thead> <tr> <th colspan="2">PRICE</th> </tr> </thead> <tbody> <tr> <td>1-9</td> <td>\$210.15</td> </tr> <tr> <td>10-24</td> <td>\$199.64</td> </tr> <tr> <td>25-49</td> <td>\$189.14</td> </tr> <tr> <td>50+</td> <td>\$180.73</td> </tr> </tbody> </table> <p><b>SMA Female to 2.92mm Male</b> VSWR 1.2:1 to 26.5 GHz</p> <p>Model No: <a href="#">PE91009</a></p>	PRICE		1-9	\$210.15	10-24	\$199.64	25-49	\$189.14	50+	\$180.73	 <table border="1"> <thead> <tr> <th colspan="2">PRICE</th> </tr> </thead> <tbody> <tr> <td>1-9</td> <td>\$214.24</td> </tr> <tr> <td>10-24</td> <td>\$203.53</td> </tr> <tr> <td>25-49</td> <td>\$192.82</td> </tr> <tr> <td>50+</td> <td>\$184.25</td> </tr> </tbody> </table> <p><b>SMA Female to 2.92mm Female</b> VSWR 1.2:1 to 26.5 GHz</p> <p>Model No: <a href="#">PE91011</a></p>	PRICE		1-9	\$214.24	10-24	\$203.53	25-49	\$192.82	50+	\$184.25	 <table border="1"> <thead> <tr> <th colspan="2">PRICE</th> </tr> </thead> <tbody> <tr> <td>1-9</td> <td>\$196.00</td> </tr> <tr> <td>10-24</td> <td>\$186.20</td> </tr> <tr> <td>25-49</td> <td>\$176.40</td> </tr> <tr> <td>50+</td> <td>\$168.56</td> </tr> </tbody> </table> <p><b>SMA Female to 3.5mm Male</b> VSWR 1.2:1 to 27 GHz</p> <p>Model No: <a href="#">PE9724</a></p>	PRICE		1-9	\$196.00	10-24	\$186.20	25-49	\$176.40	50+	\$168.56
	PRICE																																																						
1-9	\$218.61																																																						
10-24	\$207.68																																																						
25-49	\$196.75																																																						
50+	\$188.00																																																						
PRICE																																																							
1-9	\$223.31																																																						
10-24	\$212.14																																																						
25-49	\$200.98																																																						
50+	\$192.05																																																						
PRICE																																																							
1-9	\$210.15																																																						
10-24	\$199.64																																																						
25-49	\$189.14																																																						
50+	\$180.73																																																						
PRICE																																																							
1-9	\$214.24																																																						
10-24	\$203.53																																																						
25-49	\$192.82																																																						
50+	\$184.25																																																						
PRICE																																																							
1-9	\$196.00																																																						
10-24	\$186.20																																																						
25-49	\$176.40																																																						
50+	\$168.56																																																						
3	 <table border="1"> <thead> <tr> <th colspan="2">PRICE</th> </tr> </thead> <tbody> <tr> <td>1-9</td> <td>\$201.68</td> </tr> <tr> <td>10-24</td> <td>\$191.60</td> </tr> <tr> <td>25-49</td> <td>\$181.51</td> </tr> <tr> <td>50+</td> <td>\$173.44</td> </tr> </tbody> </table> <p><b>SMA Female to 3.5mm Female</b> VSWR 1.2:1 to 27 GHz</p> <p>Model No: <a href="#">PE9725</a></p>	PRICE		1-9	\$201.68	10-24	\$191.60	25-49	\$181.51	50+	\$173.44	 <table border="1"> <thead> <tr> <th colspan="2">PRICE</th> </tr> </thead> <tbody> <tr> <td>1-9</td> <td>\$235.28</td> </tr> <tr> <td>10-24</td> <td>\$223.52</td> </tr> <tr> <td>25-49</td> <td>\$211.75</td> </tr> <tr> <td>50+</td> <td>\$202.34</td> </tr> </tbody> </table> <p><b>SMA Female to 7mm Sexless</b> VSWR 1.15:1 to 18 GHz</p> <p>Model No: <a href="#">PE9214</a></p>	PRICE		1-9	\$235.28	10-24	\$223.52	25-49	\$211.75	50+	\$202.34	 <table border="1"> <thead> <tr> <th colspan="2">PRICE</th> </tr> </thead> <tbody> <tr> <td>1-4</td> <td>\$593.90</td> </tr> <tr> <td>5-9</td> <td>\$564.21</td> </tr> <tr> <td>10-24</td> <td>\$534.51</td> </tr> <tr> <td>25+</td> <td>\$510.75</td> </tr> </tbody> </table> <p><b>SMA Female to 7mm Sexless 4 Hole Flange-Mounting Hole A05</b> VSWR 1.15:1 to 18 GHz</p> <p>Model No: <a href="#">PE9327</a></p>	PRICE		1-4	\$593.90	5-9	\$564.21	10-24	\$534.51	25+	\$510.75	 <table border="1"> <thead> <tr> <th colspan="2">PRICE</th> </tr> </thead> <tbody> <tr> <td>1-24</td> <td>\$92.67</td> </tr> <tr> <td>25-49</td> <td>\$88.04</td> </tr> <tr> <td>50-99</td> <td>\$83.40</td> </tr> <tr> <td>100+</td> <td>\$79.70</td> </tr> </tbody> </table> <p><b>SMA Female to 7/16 DIN Male</b> VSWR 1.09:1 to 7.5 GHz</p> <p>Model No: <a href="#">PE91036</a></p>	PRICE		1-24	\$92.67	25-49	\$88.04	50-99	\$83.40	100+	\$79.70	 <table border="1"> <thead> <tr> <th colspan="2">PRICE</th> </tr> </thead> <tbody> <tr> <td>1-9</td> <td>\$116.02</td> </tr> <tr> <td>10-24</td> <td>\$110.22</td> </tr> <tr> <td>25-49</td> <td>\$104.42</td> </tr> <tr> <td>50+</td> <td>\$99.78</td> </tr> </tbody> </table> <p><b>SMA Female to 7/16 DIN Male</b> VSWR 1.25:1 to 6 GHz</p> <p>Model No: <a href="#">PE91175</a></p>	PRICE		1-9	\$116.02	10-24	\$110.22	25-49	\$104.42	50+	\$99.78
	PRICE																																																						
1-9	\$201.68																																																						
10-24	\$191.60																																																						
25-49	\$181.51																																																						
50+	\$173.44																																																						
PRICE																																																							
1-9	\$235.28																																																						
10-24	\$223.52																																																						
25-49	\$211.75																																																						
50+	\$202.34																																																						
PRICE																																																							
1-4	\$593.90																																																						
5-9	\$564.21																																																						
10-24	\$534.51																																																						
25+	\$510.75																																																						
PRICE																																																							
1-24	\$92.67																																																						
25-49	\$88.04																																																						
50-99	\$83.40																																																						
100+	\$79.70																																																						
PRICE																																																							
1-9	\$116.02																																																						
10-24	\$110.22																																																						
25-49	\$104.42																																																						
50+	\$99.78																																																						
4	 <table border="1"> <thead> <tr> <th colspan="2">PRICE</th> </tr> </thead> <tbody> <tr> <td>1-24</td> <td>\$93.44</td> </tr> <tr> <td>25-49</td> <td>\$88.77</td> </tr> <tr> <td>50-99</td> <td>\$84.10</td> </tr> <tr> <td>100+</td> <td>\$80.36</td> </tr> </tbody> </table> <p><b>SMA Female to 7/16 DIN Female</b> Max. Freq. 8 GHz</p> <p>Model No: <a href="#">PE91042</a></p>	PRICE		1-24	\$93.44	25-49	\$88.77	50-99	\$84.10	100+	\$80.36	 <table border="1"> <thead> <tr> <th colspan="2">PRICE</th> </tr> </thead> <tbody> <tr> <td>1-24</td> <td>\$21.57</td> </tr> <tr> <td>25-49</td> <td>\$20.49</td> </tr> <tr> <td>50-99</td> <td>\$19.41</td> </tr> <tr> <td>100+</td> <td>\$18.55</td> </tr> </tbody> </table> <p><b>SMA Female to BNC Male</b> VSWR 1.3:1 to 4 GHz</p> <p>Model No: <a href="#">PE9073</a></p>	PRICE		1-24	\$21.57	25-49	\$20.49	50-99	\$19.41	100+	\$18.55	 <table border="1"> <thead> <tr> <th colspan="2">PRICE</th> </tr> </thead> <tbody> <tr> <td>1-24</td> <td>\$82.17</td> </tr> <tr> <td>25-49</td> <td>\$78.06</td> </tr> <tr> <td>50-99</td> <td>\$73.95</td> </tr> <tr> <td>100+</td> <td>\$70.67</td> </tr> </tbody> </table> <p><b>SMA Female to BNC Male</b> VSWR 1.25:1 to 8 GHz</p> <p>Model No: <a href="#">PE9494</a></p>	PRICE		1-24	\$82.17	25-49	\$78.06	50-99	\$73.95	100+	\$70.67	 <table border="1"> <thead> <tr> <th colspan="2">PRICE</th> </tr> </thead> <tbody> <tr> <td>1-24</td> <td>\$46.45</td> </tr> <tr> <td>25-49</td> <td>\$44.13</td> </tr> <tr> <td>50-99</td> <td>\$41.81</td> </tr> <tr> <td>100+</td> <td>\$39.95</td> </tr> </tbody> </table> <p><b>SMA Female to BNC Female</b> VSWR 1.3:1 to 4 GHz</p> <p>Model No: <a href="#">PE9075</a></p>	PRICE		1-24	\$46.45	25-49	\$44.13	50-99	\$41.81	100+	\$39.95	 <table border="1"> <thead> <tr> <th colspan="2">PRICE</th> </tr> </thead> <tbody> <tr> <td>1-24</td> <td>\$115.32</td> </tr> <tr> <td>25-49</td> <td>\$109.55</td> </tr> <tr> <td>50-99</td> <td>\$103.79</td> </tr> <tr> <td>100+</td> <td>\$99.18</td> </tr> </tbody> </table> <p><b>SMA Female to BNC Female</b> VSWR 1.25:1 to 8 GHz</p> <p>Model No: <a href="#">PE9496</a></p>	PRICE		1-24	\$115.32	25-49	\$109.55	50-99	\$103.79	100+	\$99.18
	PRICE																																																						
1-24	\$93.44																																																						
25-49	\$88.77																																																						
50-99	\$84.10																																																						
100+	\$80.36																																																						
PRICE																																																							
1-24	\$21.57																																																						
25-49	\$20.49																																																						
50-99	\$19.41																																																						
100+	\$18.55																																																						
PRICE																																																							
1-24	\$82.17																																																						
25-49	\$78.06																																																						
50-99	\$73.95																																																						
100+	\$70.67																																																						
PRICE																																																							
1-24	\$46.45																																																						
25-49	\$44.13																																																						
50-99	\$41.81																																																						
100+	\$39.95																																																						
PRICE																																																							
1-24	\$115.32																																																						
25-49	\$109.55																																																						
50-99	\$103.79																																																						
100+	\$99.18																																																						
5	 <table border="1"> <thead> <tr> <th colspan="2">PRICE</th> </tr> </thead> <tbody> <tr> <td>1-24</td> <td>\$58.54</td> </tr> <tr> <td>25-49</td> <td>\$55.61</td> </tr> <tr> <td>50-99</td> <td>\$52.69</td> </tr> <tr> <td>100+</td> <td>\$50.34</td> </tr> </tbody> </table> <p><b>SMA Female to BNC Female Bulkhead</b> Max. Freq. 4 GHz</p> <p>Model No: <a href="#">PE9185</a></p>	PRICE		1-24	\$58.54	25-49	\$55.61	50-99	\$52.69	100+	\$50.34	 <table border="1"> <thead> <tr> <th colspan="2">PRICE</th> </tr> </thead> <tbody> <tr> <td>1-24</td> <td>\$65.82</td> </tr> <tr> <td>25-49</td> <td>\$62.53</td> </tr> <tr> <td>50-99</td> <td>\$59.24</td> </tr> <tr> <td>100+</td> <td>\$56.61</td> </tr> </tbody> </table> <p><b>SMA Female to BNC Female Bulkhead</b> Max. Freq. 4 GHz</p> <p>Model No: <a href="#">PE9407</a></p>	PRICE		1-24	\$65.82	25-49	\$62.53	50-99	\$59.24	100+	\$56.61	 <table border="1"> <thead> <tr> <th colspan="2">PRICE</th> </tr> </thead> <tbody> <tr> <td>1-24</td> <td>\$26.54</td> </tr> <tr> <td>25-49</td> <td>\$25.21</td> </tr> <tr> <td>50-99</td> <td>\$23.89</td> </tr> <tr> <td>100+</td> <td>\$22.82</td> </tr> </tbody> </table> <p><b>SMA Female to 75 Ohm F Male</b> VSWR 1.5:1 to 500 MHz</p> <p>Model No: <a href="#">PE91045</a></p>	PRICE		1-24	\$26.54	25-49	\$25.21	50-99	\$23.89	100+	\$22.82	 <table border="1"> <thead> <tr> <th colspan="2">PRICE</th> </tr> </thead> <tbody> <tr> <td>1-24</td> <td>\$56.89</td> </tr> <tr> <td>25-49</td> <td>\$54.05</td> </tr> <tr> <td>50-99</td> <td>\$51.20</td> </tr> <tr> <td>100+</td> <td>\$48.93</td> </tr> </tbody> </table> <p><b>SMA Female to 75 Ohm F Female</b></p> <p>Model No: <a href="#">PE91002</a></p>	PRICE		1-24	\$56.89	25-49	\$54.05	50-99	\$51.20	100+	\$48.93	 <table border="1"> <thead> <tr> <th colspan="2">PRICE</th> </tr> </thead> <tbody> <tr> <td>1-24</td> <td>\$21.64</td> </tr> <tr> <td>25-49</td> <td>\$20.56</td> </tr> <tr> <td>50-99</td> <td>\$19.48</td> </tr> <tr> <td>100+</td> <td>\$18.61</td> </tr> </tbody> </table> <p><b>SMA Female to FME Plug</b></p> <p>Model No: <a href="#">PE9703</a></p>	PRICE		1-24	\$21.64	25-49	\$20.56	50-99	\$19.48	100+	\$18.61
	PRICE																																																						
1-24	\$58.54																																																						
25-49	\$55.61																																																						
50-99	\$52.69																																																						
100+	\$50.34																																																						
PRICE																																																							
1-24	\$65.82																																																						
25-49	\$62.53																																																						
50-99	\$59.24																																																						
100+	\$56.61																																																						
PRICE																																																							
1-24	\$26.54																																																						
25-49	\$25.21																																																						
50-99	\$23.89																																																						
100+	\$22.82																																																						
PRICE																																																							
1-24	\$56.89																																																						
25-49	\$54.05																																																						
50-99	\$51.20																																																						
100+	\$48.93																																																						
PRICE																																																							
1-24	\$21.64																																																						
25-49	\$20.56																																																						
50-99	\$19.48																																																						
100+	\$18.61																																																						
6	 <table border="1"> <thead> <tr> <th colspan="2">PRICE</th> </tr> </thead> <tbody> <tr> <td>1-24</td> <td>\$27.97</td> </tr> <tr> <td>25-49</td> <td>\$26.57</td> </tr> <tr> <td>50-99</td> <td>\$25.17</td> </tr> <tr> <td>100+</td> <td>\$24.05</td> </tr> </tbody> </table> <p><b>SMA Female to FME Jack</b> VSWR 1.3:1 to 900 MHz</p> <p>Model No: <a href="#">PE9708</a></p>	PRICE		1-24	\$27.97	25-49	\$26.57	50-99	\$25.17	100+	\$24.05	 <table border="1"> <thead> <tr> <th colspan="2">PRICE</th> </tr> </thead> <tbody> <tr> <td>1-9</td> <td>\$185.44</td> </tr> <tr> <td>10-24</td> <td>\$176.17</td> </tr> <tr> <td>25-49</td> <td>\$166.90</td> </tr> <tr> <td>50+</td> <td>\$159.48</td> </tr> </tbody> </table> <p><b>SMA Female to GR874 Sexless</b></p> <p>Model No: <a href="#">PE9260</a></p>	PRICE		1-9	\$185.44	10-24	\$176.17	25-49	\$166.90	50+	\$159.48	 <table border="1"> <thead> <tr> <th colspan="2">PRICE</th> </tr> </thead> <tbody> <tr> <td>1-24</td> <td>\$85.15</td> </tr> <tr> <td>25-49</td> <td>\$80.89</td> </tr> <tr> <td>50-99</td> <td>\$76.64</td> </tr> <tr> <td>100+</td> <td>\$73.23</td> </tr> </tbody> </table> <p><b>SMA Female to HN Male</b> Max. Freq. 4 GHz</p> <p>Model No: <a href="#">PE9253</a></p>	PRICE		1-24	\$85.15	25-49	\$80.89	50-99	\$76.64	100+	\$73.23	 <table border="1"> <thead> <tr> <th colspan="2">PRICE</th> </tr> </thead> <tbody> <tr> <td>1-24</td> <td>\$69.81</td> </tr> <tr> <td>25-49</td> <td>\$66.32</td> </tr> <tr> <td>50-99</td> <td>\$62.83</td> </tr> <tr> <td>100+</td> <td>\$60.04</td> </tr> </tbody> </table> <p><b>SMA Female to HN Female</b></p> <p>Model No: <a href="#">PE9255</a></p>	PRICE		1-24	\$69.81	25-49	\$66.32	50-99	\$62.83	100+	\$60.04	 <table border="1"> <thead> <tr> <th colspan="2">PRICE</th> </tr> </thead> <tbody> <tr> <td>1-24</td> <td>\$83.93</td> </tr> <tr> <td>25-49</td> <td>\$79.73</td> </tr> <tr> <td>50-99</td> <td>\$75.54</td> </tr> <tr> <td>100+</td> <td>\$72.18</td> </tr> </tbody> </table> <p><b>SMA Female to MCX Plug</b></p> <p>Model No: <a href="#">PE9471</a></p>	PRICE		1-24	\$83.93	25-49	\$79.73	50-99	\$75.54	100+	\$72.18
	PRICE																																																						
1-24	\$27.97																																																						
25-49	\$26.57																																																						
50-99	\$25.17																																																						
100+	\$24.05																																																						
PRICE																																																							
1-9	\$185.44																																																						
10-24	\$176.17																																																						
25-49	\$166.90																																																						
50+	\$159.48																																																						
PRICE																																																							
1-24	\$85.15																																																						
25-49	\$80.89																																																						
50-99	\$76.64																																																						
100+	\$73.23																																																						
PRICE																																																							
1-24	\$69.81																																																						
25-49	\$66.32																																																						
50-99	\$62.83																																																						
100+	\$60.04																																																						
PRICE																																																							
1-24	\$83.93																																																						
25-49	\$79.73																																																						
50-99	\$75.54																																																						
100+	\$72.18																																																						
7	 <table border="1"> <thead> <tr> <th colspan="2">PRICE</th> </tr> </thead> <tbody> <tr> <td>1-24</td> <td>\$82.52</td> </tr> <tr> <td>25-49</td> <td>\$78.39</td> </tr> <tr> <td>50-99</td> <td>\$74.27</td> </tr> <tr> <td>100+</td> <td>\$70.97</td> </tr> </tbody> </table> <p><b>SMA Female to MCX Jack</b></p> <p>Model No: <a href="#">PE9470</a></p>	PRICE		1-24	\$82.52	25-49	\$78.39	50-99	\$74.27	100+	\$70.97	 <table border="1"> <thead> <tr> <th colspan="2">PRICE</th> </tr> </thead> <tbody> <tr> <td>1-24</td> <td>\$92.42</td> </tr> <tr> <td>25-49</td> <td>\$87.80</td> </tr> <tr> <td>50-99</td> <td>\$83.18</td> </tr> <tr> <td>100+</td> <td>\$79.48</td> </tr> </tbody> </table> <p><b>SMA Female to Full Detent Mini SMP Male</b> VSWR 1.2:1 to 18 GHz</p> <p>Model No: <a href="#">PE91299</a></p>	PRICE		1-24	\$92.42	25-49	\$87.80	50-99	\$83.18	100+	\$79.48	 <table border="1"> <thead> <tr> <th colspan="2">PRICE</th> </tr> </thead> <tbody> <tr> <td>1-24</td> <td>\$102.28</td> </tr> <tr> <td>25-49</td> <td>\$97.17</td> </tr> <tr> <td>50-99</td> <td>\$92.05</td> </tr> <tr> <td>100+</td> <td>\$87.96</td> </tr> </tbody> </table> <p><b>SMA Female to Smooth Bore Mini SMP Male</b> VSWR 1.2:1 to 18 GHz</p> <p>Model No: <a href="#">PE91300</a></p>	PRICE		1-24	\$102.28	25-49	\$97.17	50-99	\$92.05	100+	\$87.96	 <table border="1"> <thead> <tr> <th colspan="2">PRICE</th> </tr> </thead> <tbody> <tr> <td>1-9</td> <td>\$175.00</td> </tr> <tr> <td>10-24</td> <td>\$166.25</td> </tr> <tr> <td>25-49</td> <td>\$157.50</td> </tr> <tr> <td>50+</td> <td>\$150.50</td> </tr> </tbody> </table> <p><b>SMA Female to Full Detent Mini SMP Male</b> VSWR 1.2:1 to 26.5 GHz</p> <p>Model No: <a href="#">PE91129</a></p>	PRICE		1-9	\$175.00	10-24	\$166.25	25-49	\$157.50	50+	\$150.50	 <table border="1"> <thead> <tr> <th colspan="2">PRICE</th> </tr> </thead> <tbody> <tr> <td>1-24</td> <td>\$91.56</td> </tr> <tr> <td>25-49</td> <td>\$86.98</td> </tr> <tr> <td>50-99</td> <td>\$82.40</td> </tr> <tr> <td>100+</td> <td>\$78.74</td> </tr> </tbody> </table> <p><b>SMA Female to Mini SMP Female</b> VSWR 1.2:1 to 18 GHz</p> <p>Model No: <a href="#">PE91301</a></p>	PRICE		1-24	\$91.56	25-49	\$86.98	50-99	\$82.40	100+	\$78.74
	PRICE																																																						
1-24	\$82.52																																																						
25-49	\$78.39																																																						
50-99	\$74.27																																																						
100+	\$70.97																																																						
PRICE																																																							
1-24	\$92.42																																																						
25-49	\$87.80																																																						
50-99	\$83.18																																																						
100+	\$79.48																																																						
PRICE																																																							
1-24	\$102.28																																																						
25-49	\$97.17																																																						
50-99	\$92.05																																																						
100+	\$87.96																																																						
PRICE																																																							
1-9	\$175.00																																																						
10-24	\$166.25																																																						
25-49	\$157.50																																																						
50+	\$150.50																																																						
PRICE																																																							
1-24	\$91.56																																																						
25-49	\$86.98																																																						
50-99	\$82.40																																																						
100+	\$78.74																																																						

# ADAPTERS

See Adapter Locator on Pages 10-15  
See Page 409 for Mounting Holes

	A	B	C	D	E																																													
1	 <table border="1"> <thead> <tr><th>PRICE</th></tr> </thead> <tbody> <tr><td>1-9</td><td>\$157.83</td></tr> <tr><td>10-24</td><td>\$149.94</td></tr> <tr><td>25-49</td><td>\$142.05</td></tr> <tr><td>50+</td><td>\$135.73</td></tr> </tbody> </table> <p>PRECISION</p> <p>SMA Female to Mini SMP Female</p> <p>VSWR 1.2:1 to 26.5 GHz</p> <p>Model No: <a href="#">PE91051</a></p>	PRICE	1-9	\$157.83	10-24	\$149.94	25-49	\$142.05	50+	\$135.73	 <table border="1"> <thead> <tr><th>PRICE</th></tr> </thead> <tbody> <tr><td>1-24</td><td>\$94.72</td></tr> <tr><td>25-49</td><td>\$89.98</td></tr> <tr><td>50-99</td><td>\$85.25</td></tr> <tr><td>100+</td><td>\$81.46</td></tr> </tbody> </table> <p>SMA Female to MMCX Plug</p> <p>Model No: <a href="#">PE9475</a></p>	PRICE	1-24	\$94.72	25-49	\$89.98	50-99	\$85.25	100+	\$81.46	 <table border="1"> <thead> <tr><th>PRICE</th></tr> </thead> <tbody> <tr><td>1-24</td><td>\$84.80</td></tr> <tr><td>25-49</td><td>\$80.56</td></tr> <tr><td>50-99</td><td>\$76.32</td></tr> <tr><td>100+</td><td>\$72.93</td></tr> </tbody> </table> <p>SMA Female to MMCX Jack</p> <p>Model No: <a href="#">PE9477</a></p>	PRICE	1-24	\$84.80	25-49	\$80.56	50-99	\$76.32	100+	\$72.93	 <table border="1"> <thead> <tr><th>PRICE</th></tr> </thead> <tbody> <tr><td>1-9</td><td>\$199.29</td></tr> <tr><td>10-24</td><td>\$189.33</td></tr> <tr><td>25-49</td><td>\$179.36</td></tr> <tr><td>50+</td><td>\$171.39</td></tr> </tbody> </table> <p>SMA Female to Snap-On MMBX Plug</p> <p>VSWR 1.08:1 to 12.4 GHz</p> <p>Model No: <a href="#">PE91361</a></p>	PRICE	1-9	\$199.29	10-24	\$189.33	25-49	\$179.36	50+	\$171.39	 <table border="1"> <thead> <tr><th>PRICE</th></tr> </thead> <tbody> <tr><td>1-9</td><td>\$179.88</td></tr> <tr><td>10-24</td><td>\$170.89</td></tr> <tr><td>25-49</td><td>\$161.89</td></tr> <tr><td>50+</td><td>\$154.70</td></tr> </tbody> </table> <p>SMA Female to Snap-On MMBX Jack</p> <p>VSWR 1.08:1 to 12.4 GHz</p> <p>Model No: <a href="#">PE91363</a></p>	PRICE	1-9	\$179.88	10-24	\$170.89	25-49	\$161.89	50+	\$154.70
	PRICE																																																	
1-9	\$157.83																																																	
10-24	\$149.94																																																	
25-49	\$142.05																																																	
50+	\$135.73																																																	
PRICE																																																		
1-24	\$94.72																																																	
25-49	\$89.98																																																	
50-99	\$85.25																																																	
100+	\$81.46																																																	
PRICE																																																		
1-24	\$84.80																																																	
25-49	\$80.56																																																	
50-99	\$76.32																																																	
100+	\$72.93																																																	
PRICE																																																		
1-9	\$199.29																																																	
10-24	\$189.33																																																	
25-49	\$179.36																																																	
50+	\$171.39																																																	
PRICE																																																		
1-9	\$179.88																																																	
10-24	\$170.89																																																	
25-49	\$161.89																																																	
50+	\$154.70																																																	
2	 <table border="1"> <thead> <tr><th>PRICE</th></tr> </thead> <tbody> <tr><td>1-24</td><td>\$17.32</td></tr> <tr><td>25-49</td><td>\$16.45</td></tr> <tr><td>50-99</td><td>\$15.59</td></tr> <tr><td>100+</td><td>\$14.90</td></tr> </tbody> </table> <p>SMA Female to N Male</p> <p>VSWR 1.3:1 to 11 GHz</p> <p>Model No: <a href="#">PE9081</a></p>	PRICE	1-24	\$17.32	25-49	\$16.45	50-99	\$15.59	100+	\$14.90	 <table border="1"> <thead> <tr><th>PRICE</th></tr> </thead> <tbody> <tr><td>1-9</td><td>\$208.81</td></tr> <tr><td>10-24</td><td>\$198.37</td></tr> <tr><td>25-49</td><td>\$187.93</td></tr> <tr><td>50+</td><td>\$179.58</td></tr> </tbody> </table> <p>SMA Female to QD N Male</p> <p>Model No: <a href="#">PE9684</a></p>	PRICE	1-9	\$208.81	10-24	\$198.37	25-49	\$187.93	50+	\$179.58	 <table border="1"> <thead> <tr><th>PRICE</th></tr> </thead> <tbody> <tr><td>1-24</td><td>\$71.94</td></tr> <tr><td>25-49</td><td>\$68.34</td></tr> <tr><td>50-99</td><td>\$64.75</td></tr> <tr><td>100+</td><td>\$61.87</td></tr> </tbody> </table> <p>SMA Female to N Male Bulkhead</p> <p>Max. Freq. 11 GHz</p> <p>Model No: <a href="#">PE9551</a></p>	PRICE	1-24	\$71.94	25-49	\$68.34	50-99	\$64.75	100+	\$61.87	 <table border="1"> <thead> <tr><th>PRICE</th></tr> </thead> <tbody> <tr><td>1-24</td><td>\$96.86</td></tr> <tr><td>25-49</td><td>\$92.02</td></tr> <tr><td>50-99</td><td>\$87.17</td></tr> <tr><td>100+</td><td>\$83.30</td></tr> </tbody> </table> <p>SMA Female to N Male 4 Hole Flange-Mounting Hole A05</p> <p>VSWR 1.2:1 to 12.4 GHz</p> <p>Model No: <a href="#">PE9275</a></p>	PRICE	1-24	\$96.86	25-49	\$92.02	50-99	\$87.17	100+	\$83.30	 <table border="1"> <thead> <tr><th>PRICE</th></tr> </thead> <tbody> <tr><td>1-9</td><td>\$179.90</td></tr> <tr><td>10-24</td><td>\$170.91</td></tr> <tr><td>25-49</td><td>\$161.91</td></tr> <tr><td>50+</td><td>\$154.71</td></tr> </tbody> </table> <p>PRECISION</p> <p>SMA Female to N Male 4 Hole Flange-Mounting Hole A05</p> <p>VSWR 1.15:1 to 18 GHz</p> <p>Model No: <a href="#">PE9498</a></p>	PRICE	1-9	\$179.90	10-24	\$170.91	25-49	\$161.91	50+	\$154.71
	PRICE																																																	
1-24	\$17.32																																																	
25-49	\$16.45																																																	
50-99	\$15.59																																																	
100+	\$14.90																																																	
PRICE																																																		
1-9	\$208.81																																																	
10-24	\$198.37																																																	
25-49	\$187.93																																																	
50+	\$179.58																																																	
PRICE																																																		
1-24	\$71.94																																																	
25-49	\$68.34																																																	
50-99	\$64.75																																																	
100+	\$61.87																																																	
PRICE																																																		
1-24	\$96.86																																																	
25-49	\$92.02																																																	
50-99	\$87.17																																																	
100+	\$83.30																																																	
PRICE																																																		
1-9	\$179.90																																																	
10-24	\$170.91																																																	
25-49	\$161.91																																																	
50+	\$154.71																																																	
3	 <table border="1"> <thead> <tr><th>PRICE</th></tr> </thead> <tbody> <tr><td>1-24</td><td>\$21.11</td></tr> <tr><td>25-49</td><td>\$20.05</td></tr> <tr><td>50-99</td><td>\$19.00</td></tr> <tr><td>100+</td><td>\$18.15</td></tr> </tbody> </table> <p>SMA Female to N Female</p> <p>VSWR 1.3:1 to 11 GHz</p> <p>Model No: <a href="#">PE9083</a></p>	PRICE	1-24	\$21.11	25-49	\$20.05	50-99	\$19.00	100+	\$18.15	 <table border="1"> <thead> <tr><th>PRICE</th></tr> </thead> <tbody> <tr><td>1-24</td><td>\$102.32</td></tr> <tr><td>25-49</td><td>\$97.20</td></tr> <tr><td>50-99</td><td>\$92.09</td></tr> <tr><td>100+</td><td>\$88.00</td></tr> </tbody> </table> <p>PRECISION</p> <p>SMA Female to N Female</p> <p>VSWR 1.15:1 to 18 GHz</p> <p>Model No: <a href="#">PE9432</a></p>	PRICE	1-24	\$102.32	25-49	\$97.20	50-99	\$92.09	100+	\$88.00	 <table border="1"> <thead> <tr><th>PRICE</th></tr> </thead> <tbody> <tr><td>1-24</td><td>\$25.45</td></tr> <tr><td>25-49</td><td>\$24.18</td></tr> <tr><td>50-99</td><td>\$22.91</td></tr> <tr><td>100+</td><td>\$21.89</td></tr> </tbody> </table> <p>SMA Female to N Female Bulkhead</p> <p>VSWR 1.3:1 to 11 GHz</p> <p>Model No: <a href="#">PE9252</a></p>	PRICE	1-24	\$25.45	25-49	\$24.18	50-99	\$22.91	100+	\$21.89	 <table border="1"> <thead> <tr><th>PRICE</th></tr> </thead> <tbody> <tr><td>1-9</td><td>\$159.88</td></tr> <tr><td>10-24</td><td>\$151.89</td></tr> <tr><td>25-49</td><td>\$143.89</td></tr> <tr><td>50+</td><td>\$137.50</td></tr> </tbody> </table> <p>PRECISION</p> <p>SMA Female to N Female Bulkhead</p> <p>VSWR 1.15:1 to 18 GHz</p> <p>Model No: <a href="#">PE9486</a></p>	PRICE	1-9	\$159.88	10-24	\$151.89	25-49	\$143.89	50+	\$137.50	 <table border="1"> <thead> <tr><th>PRICE</th></tr> </thead> <tbody> <tr><td>1-24</td><td>\$65.60</td></tr> <tr><td>25-49</td><td>\$62.32</td></tr> <tr><td>50-99</td><td>\$59.04</td></tr> <tr><td>100+</td><td>\$56.42</td></tr> </tbody> </table> <p>SMA Female to N Female 4 Hole Flange-Mounting Hole A05</p> <p>VSWR 1.3:1 to 11 GHz</p> <p>Model No: <a href="#">PE9104</a></p>	PRICE	1-24	\$65.60	25-49	\$62.32	50-99	\$59.04	100+	\$56.42
	PRICE																																																	
1-24	\$21.11																																																	
25-49	\$20.05																																																	
50-99	\$19.00																																																	
100+	\$18.15																																																	
PRICE																																																		
1-24	\$102.32																																																	
25-49	\$97.20																																																	
50-99	\$92.09																																																	
100+	\$88.00																																																	
PRICE																																																		
1-24	\$25.45																																																	
25-49	\$24.18																																																	
50-99	\$22.91																																																	
100+	\$21.89																																																	
PRICE																																																		
1-9	\$159.88																																																	
10-24	\$151.89																																																	
25-49	\$143.89																																																	
50+	\$137.50																																																	
PRICE																																																		
1-24	\$65.60																																																	
25-49	\$62.32																																																	
50-99	\$59.04																																																	
100+	\$56.42																																																	
4	 <table border="1"> <thead> <tr><th>PRICE</th></tr> </thead> <tbody> <tr><td>1-9</td><td>\$159.88</td></tr> <tr><td>10-24</td><td>\$151.89</td></tr> <tr><td>25-49</td><td>\$143.89</td></tr> <tr><td>50+</td><td>\$137.50</td></tr> </tbody> </table> <p>PRECISION</p> <p>SMA Female to N Female 4 Hole Flange-Mounting Hole A05</p> <p>VSWR 1.15:1 to 18 GHz</p> <p>Model No: <a href="#">PE9434</a></p>	PRICE	1-9	\$159.88	10-24	\$151.89	25-49	\$143.89	50+	\$137.50	 <table border="1"> <thead> <tr><th>PRICE</th></tr> </thead> <tbody> <tr><td>1-24</td><td>\$76.52</td></tr> <tr><td>25-49</td><td>\$72.69</td></tr> <tr><td>50-99</td><td>\$68.87</td></tr> <tr><td>100+</td><td>\$65.81</td></tr> </tbody> </table> <p>SMA Female to N Female Bulkhead</p> <p>VSWR 1.25:1 to 6 GHz</p> <p>Model No: <a href="#">PE9408</a></p>	PRICE	1-24	\$76.52	25-49	\$72.69	50-99	\$68.87	100+	\$65.81	 <table border="1"> <thead> <tr><th>PRICE</th></tr> </thead> <tbody> <tr><td>1-9</td><td>\$164.13</td></tr> <tr><td>10-24</td><td>\$155.92</td></tr> <tr><td>25-49</td><td>\$147.72</td></tr> <tr><td>50+</td><td>\$141.15</td></tr> </tbody> </table> <p>PRECISION</p> <p>SMA Female to N Female Bulkhead-Mounting Hole G01</p> <p>VSWR 1.15:1 to 18 GHz</p> <p>Model No: <a href="#">PE9435</a></p>	PRICE	1-9	\$164.13	10-24	\$155.92	25-49	\$147.72	50+	\$141.15	 <table border="1"> <thead> <tr><th>PRICE</th></tr> </thead> <tbody> <tr><td>1-24</td><td>\$65.10</td></tr> <tr><td>25-49</td><td>\$61.85</td></tr> <tr><td>50-99</td><td>\$58.59</td></tr> <tr><td>100+</td><td>\$55.99</td></tr> </tbody> </table> <p>SMA Female to QMA Male</p> <p>Max. Freq. 18 GHz</p> <p>Model No: <a href="#">PE9786</a></p>	PRICE	1-24	\$65.10	25-49	\$61.85	50-99	\$58.59	100+	\$55.99	 <table border="1"> <thead> <tr><th>PRICE</th></tr> </thead> <tbody> <tr><td>1-24</td><td>\$28.46</td></tr> <tr><td>25-49</td><td>\$27.04</td></tr> <tr><td>50-99</td><td>\$25.61</td></tr> <tr><td>100+</td><td>\$24.48</td></tr> </tbody> </table> <p>SMA Female to SMB Plug</p> <p>VSWR 1.3:1 to 4 GHz</p> <p>Model No: <a href="#">PE9142</a></p>	PRICE	1-24	\$28.46	25-49	\$27.04	50-99	\$25.61	100+	\$24.48
	PRICE																																																	
1-9	\$159.88																																																	
10-24	\$151.89																																																	
25-49	\$143.89																																																	
50+	\$137.50																																																	
PRICE																																																		
1-24	\$76.52																																																	
25-49	\$72.69																																																	
50-99	\$68.87																																																	
100+	\$65.81																																																	
PRICE																																																		
1-9	\$164.13																																																	
10-24	\$155.92																																																	
25-49	\$147.72																																																	
50+	\$141.15																																																	
PRICE																																																		
1-24	\$65.10																																																	
25-49	\$61.85																																																	
50-99	\$58.59																																																	
100+	\$55.99																																																	
PRICE																																																		
1-24	\$28.46																																																	
25-49	\$27.04																																																	
50-99	\$25.61																																																	
100+	\$24.48																																																	
5	 <table border="1"> <thead> <tr><th>PRICE</th></tr> </thead> <tbody> <tr><td>1-24</td><td>\$59.06</td></tr> <tr><td>25-49</td><td>\$56.11</td></tr> <tr><td>50-99</td><td>\$53.15</td></tr> <tr><td>100+</td><td>\$50.79</td></tr> </tbody> </table> <p>SMA Female to SMB Jack</p> <p>VSWR 1.46:1 to 4 GHz</p> <p>Model No: <a href="#">PE9143</a></p>	PRICE	1-24	\$59.06	25-49	\$56.11	50-99	\$53.15	100+	\$50.79	 <table border="1"> <thead> <tr><th>PRICE</th></tr> </thead> <tbody> <tr><td>1-24</td><td>\$57.20</td></tr> <tr><td>25-49</td><td>\$54.34</td></tr> <tr><td>50-99</td><td>\$51.48</td></tr> <tr><td>100+</td><td>\$49.19</td></tr> </tbody> </table> <p>SMA Female to SMC Plug</p> <p>VSWR 1.2:1 to 10 GHz</p> <p>Model No: <a href="#">PE9146</a></p>	PRICE	1-24	\$57.20	25-49	\$54.34	50-99	\$51.48	100+	\$49.19	 <table border="1"> <thead> <tr><th>PRICE</th></tr> </thead> <tbody> <tr><td>1-24</td><td>\$61.70</td></tr> <tr><td>25-49</td><td>\$58.62</td></tr> <tr><td>50-99</td><td>\$55.53</td></tr> <tr><td>100+</td><td>\$53.06</td></tr> </tbody> </table> <p>SMA Female to SMC Jack</p> <p>Max. Freq. 10 GHz</p> <p>Model No: <a href="#">PE9147</a></p>	PRICE	1-24	\$61.70	25-49	\$58.62	50-99	\$55.53	100+	\$53.06	 <table border="1"> <thead> <tr><th>PRICE</th></tr> </thead> <tbody> <tr><td>1-24</td><td>\$72.93</td></tr> <tr><td>25-49</td><td>\$69.28</td></tr> <tr><td>50-99</td><td>\$65.64</td></tr> <tr><td>100+</td><td>\$62.72</td></tr> </tbody> </table> <p>SMA Female to Full Detent SMP Male</p> <p>VSWR 1.2:1 to 18 GHz</p> <p>Model No: <a href="#">PE91305</a></p>	PRICE	1-24	\$72.93	25-49	\$69.28	50-99	\$65.64	100+	\$62.72	 <table border="1"> <thead> <tr><th>PRICE</th></tr> </thead> <tbody> <tr><td>1-24</td><td>\$72.93</td></tr> <tr><td>25-49</td><td>\$69.28</td></tr> <tr><td>50-99</td><td>\$65.64</td></tr> <tr><td>100+</td><td>\$62.72</td></tr> </tbody> </table> <p>SMA Female to Limited Detent SMP Male</p> <p>VSWR 1.2:1 to 18 GHz</p> <p>Model No: <a href="#">PE91306</a></p>	PRICE	1-24	\$72.93	25-49	\$69.28	50-99	\$65.64	100+	\$62.72
	PRICE																																																	
1-24	\$59.06																																																	
25-49	\$56.11																																																	
50-99	\$53.15																																																	
100+	\$50.79																																																	
PRICE																																																		
1-24	\$57.20																																																	
25-49	\$54.34																																																	
50-99	\$51.48																																																	
100+	\$49.19																																																	
PRICE																																																		
1-24	\$61.70																																																	
25-49	\$58.62																																																	
50-99	\$55.53																																																	
100+	\$53.06																																																	
PRICE																																																		
1-24	\$72.93																																																	
25-49	\$69.28																																																	
50-99	\$65.64																																																	
100+	\$62.72																																																	
PRICE																																																		
1-24	\$72.93																																																	
25-49	\$69.28																																																	
50-99	\$65.64																																																	
100+	\$62.72																																																	
6	 <table border="1"> <thead> <tr><th>PRICE</th></tr> </thead> <tbody> <tr><td>1-24</td><td>\$72.93</td></tr> <tr><td>25-49</td><td>\$69.28</td></tr> <tr><td>50-99</td><td>\$65.64</td></tr> <tr><td>100+</td><td>\$62.72</td></tr> </tbody> </table> <p>SMA Female to Smooth Bore SMP Male</p> <p>VSWR 1.2:1 to 18 GHz</p> <p>Model No: <a href="#">PE91307</a></p>	PRICE	1-24	\$72.93	25-49	\$69.28	50-99	\$65.64	100+	\$62.72	 <table border="1"> <thead> <tr><th>PRICE</th></tr> </thead> <tbody> <tr><td>1-9</td><td>\$133.81</td></tr> <tr><td>10-24</td><td>\$127.12</td></tr> <tr><td>25-49</td><td>\$120.43</td></tr> <tr><td>50+</td><td>\$115.08</td></tr> </tbody> </table> <p>PRECISION</p> <p>SMA Female to Smooth Bore SMP Male</p> <p>VSWR 1.2:1 to 26.5 GHz</p> <p>Model No: <a href="#">PE91049</a></p>	PRICE	1-9	\$133.81	10-24	\$127.12	25-49	\$120.43	50+	\$115.08	 <table border="1"> <thead> <tr><th>PRICE</th></tr> </thead> <tbody> <tr><td>1-9</td><td>\$124.77</td></tr> <tr><td>10-24</td><td>\$118.53</td></tr> <tr><td>25-49</td><td>\$112.29</td></tr> <tr><td>50+</td><td>\$107.30</td></tr> </tbody> </table> <p>PRECISION</p> <p>SMA Female to Limited Detent SMP Male</p> <p>VSWR 1.2:1 to 26.5 GHz</p> <p>Model No: <a href="#">PE91050</a></p>	PRICE	1-9	\$124.77	10-24	\$118.53	25-49	\$112.29	50+	\$107.30	 <table border="1"> <thead> <tr><th>PRICE</th></tr> </thead> <tbody> <tr><td>1-9</td><td>\$124.35</td></tr> <tr><td>10-24</td><td>\$118.13</td></tr> <tr><td>25-49</td><td>\$111.92</td></tr> <tr><td>50+</td><td>\$106.94</td></tr> </tbody> </table> <p>PRECISION</p> <p>SMA Female to Full Detent SMP Male</p> <p>VSWR 1.2:1 to 26.5 GHz</p> <p>Model No: <a href="#">PE91056</a></p>	PRICE	1-9	\$124.35	10-24	\$118.13	25-49	\$111.92	50+	\$106.94	 <table border="1"> <thead> <tr><th>PRICE</th></tr> </thead> <tbody> <tr><td>1-9</td><td>\$182.19</td></tr> <tr><td>10-24</td><td>\$173.08</td></tr> <tr><td>25-49</td><td>\$163.97</td></tr> <tr><td>50+</td><td>\$156.68</td></tr> </tbody> </table> <p>PRECISION</p> <p>SMA Female to Limited Detent SMP Male</p> <p>VSWR 1.2:1 to 18 GHz</p> <p>Model No: <a href="#">PE9512</a></p>	PRICE	1-9	\$182.19	10-24	\$173.08	25-49	\$163.97	50+	\$156.68
	PRICE																																																	
1-24	\$72.93																																																	
25-49	\$69.28																																																	
50-99	\$65.64																																																	
100+	\$62.72																																																	
PRICE																																																		
1-9	\$133.81																																																	
10-24	\$127.12																																																	
25-49	\$120.43																																																	
50+	\$115.08																																																	
PRICE																																																		
1-9	\$124.77																																																	
10-24	\$118.53																																																	
25-49	\$112.29																																																	
50+	\$107.30																																																	
PRICE																																																		
1-9	\$124.35																																																	
10-24	\$118.13																																																	
25-49	\$111.92																																																	
50+	\$106.94																																																	
PRICE																																																		
1-9	\$182.19																																																	
10-24	\$173.08																																																	
25-49	\$163.97																																																	
50+	\$156.68																																																	
7	 <table border="1"> <thead> <tr><th>PRICE</th></tr> </thead> <tbody> <tr><td>1-9</td><td>\$414.68</td></tr> <tr><td>10-24</td><td>\$393.95</td></tr> <tr><td>25-49</td><td>\$373.21</td></tr> <tr><td>50+</td><td>\$356.62</td></tr> </tbody> </table> <p>SMA Female to Limited Detent SMP Male</p> <p>Max. Freq. 26.5 GHz</p> <p>Model No: <a href="#">PE9778</a></p>	PRICE	1-9	\$414.68	10-24	\$393.95	25-49	\$373.21	50+	\$356.62	 <table border="1"> <thead> <tr><th>PRICE</th></tr> </thead> <tbody> <tr><td>1-9</td><td>\$132.14</td></tr> <tr><td>10-24</td><td>\$125.53</td></tr> <tr><td>25-49</td><td>\$118.93</td></tr> <tr><td>50+</td><td>\$113.64</td></tr> </tbody> </table> <p>SMA Female to Full Detent Bulkhead-Mounting Hole F05</p> <p>VSWR 1.3:1 to 26.5 GHz</p> <p>Model No: <a href="#">PE91054</a></p>	PRICE	1-9	\$132.14	10-24	\$125.53	25-49	\$118.93	50+	\$113.64	 <table border="1"> <thead> <tr><th>PRICE</th></tr> </thead> <tbody> <tr><td>1-9</td><td>\$126.30</td></tr> <tr><td>10-24</td><td>\$119.99</td></tr> <tr><td>25-49</td><td>\$113.67</td></tr> <tr><td>50+</td><td>\$108.62</td></tr> </tbody> </table> <p>PRECISION</p> <p>SMA Female to SMP Male 2 Hole Flange-Mounting Hole C05</p> <p>VSWR 1.2:1 to 26.5 GHz</p> <p>Model No: <a href="#">PE91057</a></p>	PRICE	1-9	\$126.30	10-24	\$119.99	25-49	\$113.67	50+	\$108.62	 <table border="1"> <thead> <tr><th>PRICE</th></tr> </thead> <tbody> <tr><td>1-9</td><td>\$125.51</td></tr> <tr><td>10-24</td><td>\$119.23</td></tr> <tr><td>25-49</td><td>\$112.96</td></tr> <tr><td>50+</td><td>\$107.94</td></tr> </tbody> </table> <p>PRECISION</p> <p>SMA Female to Full Detent SMP Male 2 Hole Flange-Mounting Hole C01</p> <p>VSWR 1.2:1 to 26.5 GHz</p> <p>Model No: <a href="#">PE91058</a></p>	PRICE	1-9	\$125.51	10-24	\$119.23	25-49	\$112.96	50+	\$107.94	 <table border="1"> <thead> <tr><th>PRICE</th></tr> </thead> <tbody> <tr><td>1-9</td><td>\$91.56</td></tr> <tr><td>10-24</td><td>\$86.98</td></tr> <tr><td>25-49</td><td>\$82.40</td></tr> <tr><td>50+</td><td>\$78.74</td></tr> </tbody> </table> <p>PRECISION</p> <p>SMA Female to Smooth Bore SMP Male 2 Hole Flange-Mounting Hole C05</p> <p>VSWR 1.2:1 to 26.5 GHz</p> <p>Model No: <a href="#">PE91061</a></p>	PRICE	1-9	\$91.56	10-24	\$86.98	25-49	\$82.40	50+	\$78.74
	PRICE																																																	
1-9	\$414.68																																																	
10-24	\$393.95																																																	
25-49	\$373.21																																																	
50+	\$356.62																																																	
PRICE																																																		
1-9	\$132.14																																																	
10-24	\$125.53																																																	
25-49	\$118.93																																																	
50+	\$113.64																																																	
PRICE																																																		
1-9	\$126.30																																																	
10-24	\$119.99																																																	
25-49	\$113.67																																																	
50+	\$108.62																																																	
PRICE																																																		
1-9	\$125.51																																																	
10-24	\$119.23																																																	
25-49	\$112.96																																																	
50+	\$107.94																																																	
PRICE																																																		
1-9	\$91.56																																																	
10-24	\$86.98																																																	
25-49	\$82.40																																																	
50+	\$78.74																																																	



Technical Support  
+1 (949) 261-1920



Same-Day Shipping,  
Even Custom Cable Assemblies



# ADAPTERS

See Adapter Locator on Pages 10-15

See Page 409 for Mounting Holes

Adapters









See Our Website For Current Pricing & Real-Time Stock Availability!

	A	B	C	D	E																																																		
1	 <table border="1"> <thead> <tr> <th colspan="2">PRICE</th> </tr> </thead> <tbody> <tr> <td>1-9</td> <td>\$137.03</td> </tr> <tr> <td>10-24</td> <td>\$130.18</td> </tr> <tr> <td>25-49</td> <td>\$123.33</td> </tr> <tr> <td>50+</td> <td>\$117.85</td> </tr> </tbody> </table> <p>PRECISION SMA Female to Limited Detent SMP Male 2 Hole Flange-Mounting Hole C05 VSWR 1.2:1 to 26.5 GHz Model No: <a href="#">PE91066</a></p>	PRICE		1-9	\$137.03	10-24	\$130.18	25-49	\$123.33	50+	\$117.85	 <table border="1"> <thead> <tr> <th colspan="2">PRICE</th> </tr> </thead> <tbody> <tr> <td>1-9</td> <td>\$146.82</td> </tr> <tr> <td>10-24</td> <td>\$139.48</td> </tr> <tr> <td>25-49</td> <td>\$132.14</td> </tr> <tr> <td>50+</td> <td>\$126.27</td> </tr> </tbody> </table> <p>PRECISION SMA Female to SMP Male 4 Hole Flange-Mounting Hole A01 VSWR 1.2:1 to 26.5 GHz Model No: <a href="#">PE91059</a></p>	PRICE		1-9	\$146.82	10-24	\$139.48	25-49	\$132.14	50+	\$126.27	 <table border="1"> <thead> <tr> <th colspan="2">PRICE</th> </tr> </thead> <tbody> <tr> <td>1-24</td> <td>\$71.61</td> </tr> <tr> <td>25-49</td> <td>\$68.03</td> </tr> <tr> <td>50-99</td> <td>\$64.45</td> </tr> <tr> <td>100+</td> <td>\$61.58</td> </tr> </tbody> </table> <p>SMA Female to SMP Female VSWR 1.2:1 to 18 GHz Model No: <a href="#">PE91308</a></p>	PRICE		1-24	\$71.61	25-49	\$68.03	50-99	\$64.45	100+	\$61.58	 <table border="1"> <thead> <tr> <th colspan="2">PRICE</th> </tr> </thead> <tbody> <tr> <td>1-9</td> <td>\$124.05</td> </tr> <tr> <td>10-24</td> <td>\$117.85</td> </tr> <tr> <td>25-49</td> <td>\$111.65</td> </tr> <tr> <td>50+</td> <td>\$106.68</td> </tr> </tbody> </table> <p>PRECISION SMA Female to SMP Female VSWR 1.2:1 to 26.5 GHz Model No: <a href="#">PE91064</a></p>	PRICE		1-9	\$124.05	10-24	\$117.85	25-49	\$111.65	50+	\$106.68	 <table border="1"> <thead> <tr> <th colspan="2">PRICE</th> </tr> </thead> <tbody> <tr> <td>1-9</td> <td>\$223.96</td> </tr> <tr> <td>10-24</td> <td>\$212.76</td> </tr> <tr> <td>25-49</td> <td>\$201.56</td> </tr> <tr> <td>50+</td> <td>\$192.61</td> </tr> </tbody> </table> <p>PRECISION SMA Female to SMP Female VSWR 1.2:1 to 18 GHz Model No: <a href="#">PE9779</a></p>	PRICE		1-9	\$223.96	10-24	\$212.76	25-49	\$201.56	50+	\$192.61
PRICE																																																							
1-9	\$137.03																																																						
10-24	\$130.18																																																						
25-49	\$123.33																																																						
50+	\$117.85																																																						
PRICE																																																							
1-9	\$146.82																																																						
10-24	\$139.48																																																						
25-49	\$132.14																																																						
50+	\$126.27																																																						
PRICE																																																							
1-24	\$71.61																																																						
25-49	\$68.03																																																						
50-99	\$64.45																																																						
100+	\$61.58																																																						
PRICE																																																							
1-9	\$124.05																																																						
10-24	\$117.85																																																						
25-49	\$111.65																																																						
50+	\$106.68																																																						
PRICE																																																							
1-9	\$223.96																																																						
10-24	\$212.76																																																						
25-49	\$201.56																																																						
50+	\$192.61																																																						
2	 <table border="1"> <thead> <tr> <th colspan="2">PRICE</th> </tr> </thead> <tbody> <tr> <td>1-24</td> <td>\$52.98</td> </tr> <tr> <td>25-49</td> <td>\$50.33</td> </tr> <tr> <td>50-99</td> <td>\$47.68</td> </tr> <tr> <td>100+</td> <td>\$45.56</td> </tr> </tbody> </table> <p>SMA Female to SSMA Male VSWR 1.3:1 to 18 GHz Model No: <a href="#">PE9188</a></p>	PRICE		1-24	\$52.98	25-49	\$50.33	50-99	\$47.68	100+	\$45.56	 <table border="1"> <thead> <tr> <th colspan="2">PRICE</th> </tr> </thead> <tbody> <tr> <td>1-24</td> <td>\$72.54</td> </tr> <tr> <td>25-49</td> <td>\$68.91</td> </tr> <tr> <td>50-99</td> <td>\$65.29</td> </tr> <tr> <td>100+</td> <td>\$62.38</td> </tr> </tbody> </table> <p>SMA Female to SSMA Female VSWR 1.4:1 to 18 GHz Model No: <a href="#">PE9399</a></p>	PRICE		1-24	\$72.54	25-49	\$68.91	50-99	\$65.29	100+	\$62.38	 <table border="1"> <thead> <tr> <th colspan="2">PRICE</th> </tr> </thead> <tbody> <tr> <td>1-24</td> <td>\$64.17</td> </tr> <tr> <td>25-49</td> <td>\$60.96</td> </tr> <tr> <td>50-99</td> <td>\$57.75</td> </tr> <tr> <td>100+</td> <td>\$55.19</td> </tr> </tbody> </table> <p>SMA Female to SSMB Plug Model No: <a href="#">PE9402</a></p>	PRICE		1-24	\$64.17	25-49	\$60.96	50-99	\$57.75	100+	\$55.19	 <table border="1"> <thead> <tr> <th colspan="2">PRICE</th> </tr> </thead> <tbody> <tr> <td>1-24</td> <td>\$59.03</td> </tr> <tr> <td>25-49</td> <td>\$56.08</td> </tr> <tr> <td>50-99</td> <td>\$53.13</td> </tr> <tr> <td>100+</td> <td>\$50.77</td> </tr> </tbody> </table> <p>SMA Female to SSMC Plug VSWR 1.25:1 to 3 GHz Model No: <a href="#">PE91380</a></p>	PRICE		1-24	\$59.03	25-49	\$56.08	50-99	\$53.13	100+	\$50.77	 <table border="1"> <thead> <tr> <th colspan="2">PRICE</th> </tr> </thead> <tbody> <tr> <td>1-24</td> <td>\$60.47</td> </tr> <tr> <td>25-49</td> <td>\$57.45</td> </tr> <tr> <td>50-99</td> <td>\$54.42</td> </tr> <tr> <td>100+</td> <td>\$52.00</td> </tr> </tbody> </table> <p>SMA Female to SSMC Jack VSWR 1.25:1 to 3 GHz Model No: <a href="#">PE91433</a></p>	PRICE		1-24	\$60.47	25-49	\$57.45	50-99	\$54.42	100+	\$52.00
PRICE																																																							
1-24	\$52.98																																																						
25-49	\$50.33																																																						
50-99	\$47.68																																																						
100+	\$45.56																																																						
PRICE																																																							
1-24	\$72.54																																																						
25-49	\$68.91																																																						
50-99	\$65.29																																																						
100+	\$62.38																																																						
PRICE																																																							
1-24	\$64.17																																																						
25-49	\$60.96																																																						
50-99	\$57.75																																																						
100+	\$55.19																																																						
PRICE																																																							
1-24	\$59.03																																																						
25-49	\$56.08																																																						
50-99	\$53.13																																																						
100+	\$50.77																																																						
PRICE																																																							
1-24	\$60.47																																																						
25-49	\$57.45																																																						
50-99	\$54.42																																																						
100+	\$52.00																																																						
3	 <table border="1"> <thead> <tr> <th colspan="2">PRICE</th> </tr> </thead> <tbody> <tr> <td>1-24</td> <td>\$21.06</td> </tr> <tr> <td>25-49</td> <td>\$20.01</td> </tr> <tr> <td>50-99</td> <td>\$18.95</td> </tr> <tr> <td>100+</td> <td>\$18.11</td> </tr> </tbody> </table> <p>SMA Female to TNC Male VSWR 1.3:1 to 11 GHz Model No: <a href="#">PE9077</a></p>	PRICE		1-24	\$21.06	25-49	\$20.01	50-99	\$18.95	100+	\$18.11	 <table border="1"> <thead> <tr> <th colspan="2">PRICE</th> </tr> </thead> <tbody> <tr> <td>1-9</td> <td>\$118.71</td> </tr> <tr> <td>10-24</td> <td>\$112.77</td> </tr> <tr> <td>25-49</td> <td>\$106.84</td> </tr> <tr> <td>50+</td> <td>\$102.09</td> </tr> </tbody> </table> <p>SMA Female to TNC Male VSWR 1.25:1 to 18 GHz Model No: <a href="#">PE9440</a></p>	PRICE		1-9	\$118.71	10-24	\$112.77	25-49	\$106.84	50+	\$102.09	 <table border="1"> <thead> <tr> <th colspan="2">PRICE</th> </tr> </thead> <tbody> <tr> <td>1-24</td> <td>\$48.90</td> </tr> <tr> <td>25-49</td> <td>\$46.46</td> </tr> <tr> <td>50-99</td> <td>\$44.01</td> </tr> <tr> <td>100+</td> <td>\$42.05</td> </tr> </tbody> </table> <p>SMA Female to TNC Female Max. Freq. 11 GHz Model No: <a href="#">PE9079</a></p>	PRICE		1-24	\$48.90	25-49	\$46.46	50-99	\$44.01	100+	\$42.05	 <table border="1"> <thead> <tr> <th colspan="2">PRICE</th> </tr> </thead> <tbody> <tr> <td>1-9</td> <td>\$153.09</td> </tr> <tr> <td>10-24</td> <td>\$145.44</td> </tr> <tr> <td>25-49</td> <td>\$137.78</td> </tr> <tr> <td>50+</td> <td>\$131.66</td> </tr> </tbody> </table> <p>SMA Female to TNC Female VSWR 1.25:1 to 18 GHz Model No: <a href="#">PE9442</a></p>	PRICE		1-9	\$153.09	10-24	\$145.44	25-49	\$137.78	50+	\$131.66	 <table border="1"> <thead> <tr> <th colspan="2">PRICE</th> </tr> </thead> <tbody> <tr> <td>1-24</td> <td>\$51.75</td> </tr> <tr> <td>25-49</td> <td>\$49.16</td> </tr> <tr> <td>50-99</td> <td>\$46.58</td> </tr> <tr> <td>100+</td> <td>\$44.51</td> </tr> </tbody> </table> <p>SMA Female to TNC Female Bulkhead-Mounting Hole B05 VSWR 1.3:1 to 11 GHz Model No: <a href="#">PE9251</a></p>	PRICE		1-24	\$51.75	25-49	\$49.16	50-99	\$46.58	100+	\$44.51
PRICE																																																							
1-24	\$21.06																																																						
25-49	\$20.01																																																						
50-99	\$18.95																																																						
100+	\$18.11																																																						
PRICE																																																							
1-9	\$118.71																																																						
10-24	\$112.77																																																						
25-49	\$106.84																																																						
50+	\$102.09																																																						
PRICE																																																							
1-24	\$48.90																																																						
25-49	\$46.46																																																						
50-99	\$44.01																																																						
100+	\$42.05																																																						
PRICE																																																							
1-9	\$153.09																																																						
10-24	\$145.44																																																						
25-49	\$137.78																																																						
50+	\$131.66																																																						
PRICE																																																							
1-24	\$51.75																																																						
25-49	\$49.16																																																						
50-99	\$46.58																																																						
100+	\$44.51																																																						
4	 <table border="1"> <thead> <tr> <th colspan="2">PRICE</th> </tr> </thead> <tbody> <tr> <td>1-24</td> <td>\$54.04</td> </tr> <tr> <td>25-49</td> <td>\$51.34</td> </tr> <tr> <td>50-99</td> <td>\$48.64</td> </tr> <tr> <td>100+</td> <td>\$46.47</td> </tr> </tbody> </table> <p>SMA Female to TNC Female 4 Hole Flange-Mounting Hole A03 Model No: <a href="#">PE9276</a></p>	PRICE		1-24	\$54.04	25-49	\$51.34	50-99	\$48.64	100+	\$46.47	 <table border="1"> <thead> <tr> <th colspan="2">PRICE</th> </tr> </thead> <tbody> <tr> <td>1-24</td> <td>\$58.50</td> </tr> <tr> <td>25-49</td> <td>\$55.58</td> </tr> <tr> <td>50-99</td> <td>\$52.65</td> </tr> <tr> <td>100+</td> <td>\$50.31</td> </tr> </tbody> </table> <p>SMA Female to UHF Male VSWR 1.3:1 to 300 MHz Model No: <a href="#">PE9415</a></p>	PRICE		1-24	\$58.50	25-49	\$55.58	50-99	\$52.65	100+	\$50.31	 <table border="1"> <thead> <tr> <th colspan="2">PRICE</th> </tr> </thead> <tbody> <tr> <td>1-24</td> <td>\$24.07</td> </tr> <tr> <td>25-49</td> <td>\$22.87</td> </tr> <tr> <td>50-99</td> <td>\$21.66</td> </tr> <tr> <td>100+</td> <td>\$20.70</td> </tr> </tbody> </table> <p>SMA Female to UMCX Plug VSWR 1.3:1 to 6 GHz Model No: <a href="#">PE91005</a></p>	PRICE		1-24	\$24.07	25-49	\$22.87	50-99	\$21.66	100+	\$20.70	 <table border="1"> <thead> <tr> <th colspan="2">PRICE</th> </tr> </thead> <tbody> <tr> <td>1-24</td> <td>\$29.85</td> </tr> <tr> <td>25-49</td> <td>\$28.36</td> </tr> <tr> <td>50-99</td> <td>\$26.87</td> </tr> <tr> <td>100+</td> <td>\$25.67</td> </tr> </tbody> </table> <p>SMA Female to UMCX Jack VSWR 1.3:1 to 6 GHz Model No: <a href="#">PE91006</a></p>	PRICE		1-24	\$29.85	25-49	\$28.36	50-99	\$26.87	100+	\$25.67	<p><b>Reverse Polarity SMA Between Series</b></p> 										
PRICE																																																							
1-24	\$54.04																																																						
25-49	\$51.34																																																						
50-99	\$48.64																																																						
100+	\$46.47																																																						
PRICE																																																							
1-24	\$58.50																																																						
25-49	\$55.58																																																						
50-99	\$52.65																																																						
100+	\$50.31																																																						
PRICE																																																							
1-24	\$24.07																																																						
25-49	\$22.87																																																						
50-99	\$21.66																																																						
100+	\$20.70																																																						
PRICE																																																							
1-24	\$29.85																																																						
25-49	\$28.36																																																						
50-99	\$26.87																																																						
100+	\$25.67																																																						
5	 <table border="1"> <thead> <tr> <th colspan="2">PRICE</th> </tr> </thead> <tbody> <tr> <td>1-24</td> <td>\$83.64</td> </tr> <tr> <td>25-49</td> <td>\$79.46</td> </tr> <tr> <td>50-99</td> <td>\$75.28</td> </tr> <tr> <td>100+</td> <td>\$71.93</td> </tr> </tbody> </table> <p>SMA Male to Rev. Pol. MCX Plug VSWR 1.2:1 to 6 GHz Model No: <a href="#">PE9581</a></p>	PRICE		1-24	\$83.64	25-49	\$79.46	50-99	\$75.28	100+	\$71.93	 <table border="1"> <thead> <tr> <th colspan="2">PRICE</th> </tr> </thead> <tbody> <tr> <td>1-24</td> <td>\$59.26</td> </tr> <tr> <td>25-49</td> <td>\$56.30</td> </tr> <tr> <td>50-99</td> <td>\$53.33</td> </tr> <tr> <td>100+</td> <td>\$50.96</td> </tr> </tbody> </table> <p>SMA Male to Rev. Pol. TNC Female VSWR 1.25:1 to 11 GHz Model No: <a href="#">PE9600</a></p>	PRICE		1-24	\$59.26	25-49	\$56.30	50-99	\$53.33	100+	\$50.96	 <table border="1"> <thead> <tr> <th colspan="2">PRICE</th> </tr> </thead> <tbody> <tr> <td>1-24</td> <td>\$56.97</td> </tr> <tr> <td>25-49</td> <td>\$54.12</td> </tr> <tr> <td>50-99</td> <td>\$51.27</td> </tr> <tr> <td>100+</td> <td>\$48.99</td> </tr> </tbody> </table> <p>SMA Female to Rev. Pol. TNC Male Max. Freq. 11 GHz Model No: <a href="#">PE9602</a></p>	PRICE		1-24	\$56.97	25-49	\$54.12	50-99	\$51.27	100+	\$48.99	 <table border="1"> <thead> <tr> <th colspan="2">PRICE</th> </tr> </thead> <tbody> <tr> <td>1-24</td> <td>\$81.66</td> </tr> <tr> <td>25-49</td> <td>\$77.58</td> </tr> <tr> <td>50-99</td> <td>\$73.49</td> </tr> <tr> <td>100+</td> <td>\$70.23</td> </tr> </tbody> </table> <p>SMA Female to Rev. Pol. TNC Female VSWR 1.25:1 to 11 GHz Model No: <a href="#">PE9603</a></p>	PRICE		1-24	\$81.66	25-49	\$77.58	50-99	\$73.49	100+	\$70.23	 <table border="1"> <thead> <tr> <th colspan="2">PRICE</th> </tr> </thead> <tbody> <tr> <td>1-24</td> <td>\$78.75</td> </tr> <tr> <td>25-49</td> <td>\$74.81</td> </tr> <tr> <td>50-99</td> <td>\$70.88</td> </tr> <tr> <td>100+</td> <td>\$67.73</td> </tr> </tbody> </table> <p>Rev. Pol. SMA Male to N Female VSWR 1.25:1 to 11 GHz Model No: <a href="#">PE9732</a></p>	PRICE		1-24	\$78.75	25-49	\$74.81	50-99	\$70.88	100+	\$67.73
PRICE																																																							
1-24	\$83.64																																																						
25-49	\$79.46																																																						
50-99	\$75.28																																																						
100+	\$71.93																																																						
PRICE																																																							
1-24	\$59.26																																																						
25-49	\$56.30																																																						
50-99	\$53.33																																																						
100+	\$50.96																																																						
PRICE																																																							
1-24	\$56.97																																																						
25-49	\$54.12																																																						
50-99	\$51.27																																																						
100+	\$48.99																																																						
PRICE																																																							
1-24	\$81.66																																																						
25-49	\$77.58																																																						
50-99	\$73.49																																																						
100+	\$70.23																																																						
PRICE																																																							
1-24	\$78.75																																																						
25-49	\$74.81																																																						
50-99	\$70.88																																																						
100+	\$67.73																																																						
6	 <table border="1"> <thead> <tr> <th colspan="2">PRICE</th> </tr> </thead> <tbody> <tr> <td>1-24</td> <td>\$66.55</td> </tr> <tr> <td>25-49</td> <td>\$63.22</td> </tr> <tr> <td>50-99</td> <td>\$59.90</td> </tr> <tr> <td>100+</td> <td>\$57.23</td> </tr> </tbody> </table> <p>Rev. Pol. SMA Male to TNC Male VSWR 1.2:1 to 11 GHz Model No: <a href="#">PE9597</a></p>	PRICE		1-24	\$66.55	25-49	\$63.22	50-99	\$59.90	100+	\$57.23	 <table border="1"> <thead> <tr> <th colspan="2">PRICE</th> </tr> </thead> <tbody> <tr> <td>1-24</td> <td>\$64.07</td> </tr> <tr> <td>25-49</td> <td>\$60.87</td> </tr> <tr> <td>50-99</td> <td>\$57.66</td> </tr> <tr> <td>100+</td> <td>\$55.10</td> </tr> </tbody> </table> <p>Rev. Pol. SMA Male to TNC Female VSWR 1.2:1 to 11 GHz Model No: <a href="#">PE9596</a></p>	PRICE		1-24	\$64.07	25-49	\$60.87	50-99	\$57.66	100+	\$55.10	 <table border="1"> <thead> <tr> <th colspan="2">PRICE</th> </tr> </thead> <tbody> <tr> <td>1-24</td> <td>\$85.84</td> </tr> <tr> <td>25-49</td> <td>\$81.55</td> </tr> <tr> <td>50-99</td> <td>\$77.26</td> </tr> <tr> <td>100+</td> <td>\$73.82</td> </tr> </tbody> </table> <p>Rev. Pol. SMA Female to N Male VSWR 1.25:1 to 11 GHz Model No: <a href="#">PE9733</a></p>	PRICE		1-24	\$85.84	25-49	\$81.55	50-99	\$77.26	100+	\$73.82	 <table border="1"> <thead> <tr> <th colspan="2">PRICE</th> </tr> </thead> <tbody> <tr> <td>1-24</td> <td>\$65.25</td> </tr> <tr> <td>25-49</td> <td>\$61.99</td> </tr> <tr> <td>50-99</td> <td>\$58.73</td> </tr> <tr> <td>100+</td> <td>\$56.12</td> </tr> </tbody> </table> <p>Rev. Pol. SMA Female to TNC Male VSWR 1.2:1 to 11 GHz Model No: <a href="#">PE9598</a></p>	PRICE		1-24	\$65.25	25-49	\$61.99	50-99	\$58.73	100+	\$56.12	 <table border="1"> <thead> <tr> <th colspan="2">PRICE</th> </tr> </thead> <tbody> <tr> <td>1-24</td> <td>\$65.30</td> </tr> <tr> <td>25-49</td> <td>\$62.04</td> </tr> <tr> <td>50-99</td> <td>\$58.77</td> </tr> <tr> <td>100+</td> <td>\$56.16</td> </tr> </tbody> </table> <p>Rev. Pol. SMA Female to TNC Female VSWR 1.2:1 to 11 GHz Model No: <a href="#">PE9599</a></p>	PRICE		1-24	\$65.30	25-49	\$62.04	50-99	\$58.77	100+	\$56.16
PRICE																																																							
1-24	\$66.55																																																						
25-49	\$63.22																																																						
50-99	\$59.90																																																						
100+	\$57.23																																																						
PRICE																																																							
1-24	\$64.07																																																						
25-49	\$60.87																																																						
50-99	\$57.66																																																						
100+	\$55.10																																																						
PRICE																																																							
1-24	\$85.84																																																						
25-49	\$81.55																																																						
50-99	\$77.26																																																						
100+	\$73.82																																																						
PRICE																																																							
1-24	\$65.25																																																						
25-49	\$61.99																																																						
50-99	\$58.73																																																						
100+	\$56.12																																																						
PRICE																																																							
1-24	\$65.30																																																						
25-49	\$62.04																																																						
50-99	\$58.77																																																						
100+	\$56.16																																																						
7	 <table border="1"> <thead> <tr> <th colspan="2">PRICE</th> </tr> </thead> <tbody> <tr> <td>1-24</td> <td>\$66.55</td> </tr> <tr> <td>25-49</td> <td>\$63.22</td> </tr> <tr> <td>50-99</td> <td>\$59.90</td> </tr> <tr> <td>100+</td> <td>\$57.23</td> </tr> </tbody> </table> <p>Rev. Pol. SMA Male to Rev. Pol. TNC Male VSWR 1.2:1 to 11 GHz Model No: <a href="#">PE9605</a></p>	PRICE		1-24	\$66.55	25-49	\$63.22	50-99	\$59.90	100+	\$57.23	 <table border="1"> <thead> <tr> <th colspan="2">PRICE</th> </tr> </thead> <tbody> <tr> <td>1-24</td> <td>\$85.09</td> </tr> <tr> <td>25-49</td> <td>\$80.84</td> </tr> <tr> <td>50-99</td> <td>\$76.58</td> </tr> <tr> <td>100+</td> <td>\$73.18</td> </tr> </tbody> </table> <p>Rev. Pol. SMA Male to Rev. Pol. TNC Female VSWR 1.25:1 to 11 GHz Model No: <a href="#">PE9604</a></p>	PRICE		1-24	\$85.09	25-49	\$80.84	50-99	\$76.58	100+	\$73.18	 <table border="1"> <thead> <tr> <th colspan="2">PRICE</th> </tr> </thead> <tbody> <tr> <td>1-24</td> <td>\$65.30</td> </tr> <tr> <td>25-49</td> <td>\$62.04</td> </tr> <tr> <td>50-99</td> <td>\$58.77</td> </tr> <tr> <td>100+</td> <td>\$56.16</td> </tr> </tbody> </table> <p>Rev. Pol. SMA Female to Rev. Pol. TNC Male VSWR 1.2:1 to 11 GHz Model No: <a href="#">PE9607</a></p>	PRICE		1-24	\$65.30	25-49	\$62.04	50-99	\$58.77	100+	\$56.16	 <table border="1"> <thead> <tr> <th colspan="2">PRICE</th> </tr> </thead> <tbody> <tr> <td>1-24</td> <td>\$66.55</td> </tr> <tr> <td>25-49</td> <td>\$63.22</td> </tr> <tr> <td>50-99</td> <td>\$59.90</td> </tr> <tr> <td>100+</td> <td>\$57.23</td> </tr> </tbody> </table> <p>Rev. Pol. SMA Female to Rev. Pol. TNC Female VSWR 1.25:1 to 11 GHz Model No: <a href="#">PE9606</a></p>	PRICE		1-24	\$66.55	25-49	\$63.22	50-99	\$59.90	100+	\$57.23	<p><b>SMB In-Series</b></p> 										
PRICE																																																							
1-24	\$66.55																																																						
25-49	\$63.22																																																						
50-99	\$59.90																																																						
100+	\$57.23																																																						
PRICE																																																							
1-24	\$85.09																																																						
25-49	\$80.84																																																						
50-99	\$76.58																																																						
100+	\$73.18																																																						
PRICE																																																							
1-24	\$65.30																																																						
25-49	\$62.04																																																						
50-99	\$58.77																																																						
100+	\$56.16																																																						
PRICE																																																							
1-24	\$66.55																																																						
25-49	\$63.22																																																						
50-99	\$59.90																																																						
100+	\$57.23																																																						

# ADAPTERS

See Adapter Locator on Pages 10-15

See Page 409 for Mounting Holes

	A	B	C	D	E																																																		
1	 <table border="1"> <thead> <tr> <th colspan="2">PRICE</th> </tr> </thead> <tbody> <tr> <td>1-24</td> <td>\$40.18</td> </tr> <tr> <td>25-49</td> <td>\$38.17</td> </tr> <tr> <td>50-99</td> <td>\$36.16</td> </tr> <tr> <td>100+</td> <td>\$34.55</td> </tr> </tbody> </table> <p>SMB Plug to SMB Plug Max. Freq. 4 GHz Model No: <a href="#">PE9118</a></p>	PRICE		1-24	\$40.18	25-49	\$38.17	50-99	\$36.16	100+	\$34.55	 <table border="1"> <thead> <tr> <th colspan="2">PRICE</th> </tr> </thead> <tbody> <tr> <td>1-24</td> <td>\$116.58</td> </tr> <tr> <td>25-49</td> <td>\$110.75</td> </tr> <tr> <td>50-99</td> <td>\$104.92</td> </tr> <tr> <td>100+</td> <td>\$100.26</td> </tr> </tbody> </table> <p>SMB Plug to SMB Plug Tee Max. Freq. 4 GHz Model No: <a href="#">PE9310</a></p>	PRICE		1-24	\$116.58	25-49	\$110.75	50-99	\$104.92	100+	\$100.26	 <table border="1"> <thead> <tr> <th colspan="2">PRICE</th> </tr> </thead> <tbody> <tr> <td>1-24</td> <td>\$64.06</td> </tr> <tr> <td>25-49</td> <td>\$60.86</td> </tr> <tr> <td>50-99</td> <td>\$57.65</td> </tr> <tr> <td>100+</td> <td>\$55.09</td> </tr> </tbody> </table> <p>SMB Plug to SMB Jack VSWR 1.2:1 to 4 GHz Model No: <a href="#">PE9120</a></p>	PRICE		1-24	\$64.06	25-49	\$60.86	50-99	\$57.65	100+	\$55.09	 <table border="1"> <thead> <tr> <th colspan="2">PRICE</th> </tr> </thead> <tbody> <tr> <td>1-24</td> <td>\$76.47</td> </tr> <tr> <td>25-49</td> <td>\$72.65</td> </tr> <tr> <td>50-99</td> <td>\$68.82</td> </tr> <tr> <td>100+</td> <td>\$65.76</td> </tr> </tbody> </table> <p>SMB Plug to SMB Jack Tee Model No: <a href="#">PE9309</a></p>	PRICE		1-24	\$76.47	25-49	\$72.65	50-99	\$68.82	100+	\$65.76	 <table border="1"> <thead> <tr> <th colspan="2">PRICE</th> </tr> </thead> <tbody> <tr> <td>1-24</td> <td>\$46.08</td> </tr> <tr> <td>25-49</td> <td>\$43.78</td> </tr> <tr> <td>50-99</td> <td>\$41.47</td> </tr> <tr> <td>100+</td> <td>\$39.63</td> </tr> </tbody> </table> <p>SMB Jack to SMB Plug Tee Max. Freq. 100 MHz Model No: <a href="#">PE9243</a></p>	PRICE		1-24	\$46.08	25-49	\$43.78	50-99	\$41.47	100+	\$39.63
	PRICE																																																						
1-24	\$40.18																																																						
25-49	\$38.17																																																						
50-99	\$36.16																																																						
100+	\$34.55																																																						
PRICE																																																							
1-24	\$116.58																																																						
25-49	\$110.75																																																						
50-99	\$104.92																																																						
100+	\$100.26																																																						
PRICE																																																							
1-24	\$64.06																																																						
25-49	\$60.86																																																						
50-99	\$57.65																																																						
100+	\$55.09																																																						
PRICE																																																							
1-24	\$76.47																																																						
25-49	\$72.65																																																						
50-99	\$68.82																																																						
100+	\$65.76																																																						
PRICE																																																							
1-24	\$46.08																																																						
25-49	\$43.78																																																						
50-99	\$41.47																																																						
100+	\$39.63																																																						
2	 <table border="1"> <thead> <tr> <th colspan="2">PRICE</th> </tr> </thead> <tbody> <tr> <td>1-24</td> <td>\$54.71</td> </tr> <tr> <td>25-49</td> <td>\$51.97</td> </tr> <tr> <td>50-99</td> <td>\$49.24</td> </tr> <tr> <td>100+</td> <td>\$47.05</td> </tr> </tbody> </table> <p>SMB Jack to SMB Jack VSWR 1.3:1 to 4 GHz Model No: <a href="#">PE9116</a></p>	PRICE		1-24	\$54.71	25-49	\$51.97	50-99	\$49.24	100+	\$47.05	 <table border="1"> <thead> <tr> <th colspan="2">PRICE</th> </tr> </thead> <tbody> <tr> <td>1-24</td> <td>\$55.18</td> </tr> <tr> <td>25-49</td> <td>\$52.42</td> </tr> <tr> <td>50-99</td> <td>\$49.66</td> </tr> <tr> <td>100+</td> <td>\$47.45</td> </tr> </tbody> </table> <p>SMB Jack to SMB Jack Tee Model No: <a href="#">PE9302</a></p>	PRICE		1-24	\$55.18	25-49	\$52.42	50-99	\$49.66	100+	\$47.45	 <table border="1"> <thead> <tr> <th colspan="2">PRICE</th> </tr> </thead> <tbody> <tr> <td>1-24</td> <td>\$37.90</td> </tr> <tr> <td>25-49</td> <td>\$36.01</td> </tr> <tr> <td>50-99</td> <td>\$34.11</td> </tr> <tr> <td>100+</td> <td>\$32.59</td> </tr> </tbody> </table> <p>SMB Jack to SMB Jack Bulkhead-Mounting Hole B01 Max. Freq. 4 GHz Model No: <a href="#">PE9122</a></p>	PRICE		1-24	\$37.90	25-49	\$36.01	50-99	\$34.11	100+	\$32.59	<p><b>SMB Between Series</b></p> 		 <table border="1"> <thead> <tr> <th colspan="2">PRICE</th> </tr> </thead> <tbody> <tr> <td>1-24</td> <td>\$61.95</td> </tr> <tr> <td>25-49</td> <td>\$58.85</td> </tr> <tr> <td>50-99</td> <td>\$55.76</td> </tr> <tr> <td>100+</td> <td>\$53.28</td> </tr> </tbody> </table> <p>SMB Plug to BNC Male Max. Freq. 4 GHz Model No: <a href="#">PE9135</a></p>	PRICE		1-24	\$61.95	25-49	\$58.85	50-99	\$55.76	100+	\$53.28									
	PRICE																																																						
1-24	\$54.71																																																						
25-49	\$51.97																																																						
50-99	\$49.24																																																						
100+	\$47.05																																																						
PRICE																																																							
1-24	\$55.18																																																						
25-49	\$52.42																																																						
50-99	\$49.66																																																						
100+	\$47.45																																																						
PRICE																																																							
1-24	\$37.90																																																						
25-49	\$36.01																																																						
50-99	\$34.11																																																						
100+	\$32.59																																																						
PRICE																																																							
1-24	\$61.95																																																						
25-49	\$58.85																																																						
50-99	\$55.76																																																						
100+	\$53.28																																																						
3	 <table border="1"> <thead> <tr> <th colspan="2">PRICE</th> </tr> </thead> <tbody> <tr> <td>1-24</td> <td>\$65.28</td> </tr> <tr> <td>25-49</td> <td>\$62.02</td> </tr> <tr> <td>50-99</td> <td>\$58.75</td> </tr> <tr> <td>100+</td> <td>\$56.14</td> </tr> </tbody> </table> <p>SMB Plug to BNC Female VSWR 1.3:1 to 4 GHz Model No: <a href="#">PE9137</a></p>	PRICE		1-24	\$65.28	25-49	\$62.02	50-99	\$58.75	100+	\$56.14	 <table border="1"> <thead> <tr> <th colspan="2">PRICE</th> </tr> </thead> <tbody> <tr> <td>1-24</td> <td>\$54.97</td> </tr> <tr> <td>25-49</td> <td>\$52.22</td> </tr> <tr> <td>50-99</td> <td>\$49.47</td> </tr> <tr> <td>100+</td> <td>\$47.27</td> </tr> </tbody> </table> <p>SMB Plug to BNC Female Bulkhead-Mounting Hole B05 Max. Freq. 3 GHz Model No: <a href="#">PE9241</a></p>	PRICE		1-24	\$54.97	25-49	\$52.22	50-99	\$49.47	100+	\$47.27	 <table border="1"> <thead> <tr> <th colspan="2">PRICE</th> </tr> </thead> <tbody> <tr> <td>1-24</td> <td>\$56.28</td> </tr> <tr> <td>25-49</td> <td>\$53.47</td> </tr> <tr> <td>50-99</td> <td>\$50.65</td> </tr> <tr> <td>100+</td> <td>\$48.40</td> </tr> </tbody> </table> <p>SMB Jack to BNC Male Max. Freq. 4 GHz Model No: <a href="#">PE9132</a></p>	PRICE		1-24	\$56.28	25-49	\$53.47	50-99	\$50.65	100+	\$48.40	 <table border="1"> <thead> <tr> <th colspan="2">PRICE</th> </tr> </thead> <tbody> <tr> <td>1-24</td> <td>\$64.11</td> </tr> <tr> <td>25-49</td> <td>\$60.90</td> </tr> <tr> <td>50-99</td> <td>\$57.70</td> </tr> <tr> <td>100+</td> <td>\$55.13</td> </tr> </tbody> </table> <p>SMB Jack to BNC Female Max. Freq. 4 GHz Model No: <a href="#">PE9136</a></p>	PRICE		1-24	\$64.11	25-49	\$60.90	50-99	\$57.70	100+	\$55.13	 <table border="1"> <thead> <tr> <th colspan="2">PRICE</th> </tr> </thead> <tbody> <tr> <td>1-24</td> <td>\$57.27</td> </tr> <tr> <td>25-49</td> <td>\$54.41</td> </tr> <tr> <td>50-99</td> <td>\$51.54</td> </tr> <tr> <td>100+</td> <td>\$49.25</td> </tr> </tbody> </table> <p>SMB Jack to BNC Female Bulkhead VSWR 1.3:1 to 4 GHz Model No: <a href="#">PE9240</a></p>	PRICE		1-24	\$57.27	25-49	\$54.41	50-99	\$51.54	100+	\$49.25
	PRICE																																																						
1-24	\$65.28																																																						
25-49	\$62.02																																																						
50-99	\$58.75																																																						
100+	\$56.14																																																						
PRICE																																																							
1-24	\$54.97																																																						
25-49	\$52.22																																																						
50-99	\$49.47																																																						
100+	\$47.27																																																						
PRICE																																																							
1-24	\$56.28																																																						
25-49	\$53.47																																																						
50-99	\$50.65																																																						
100+	\$48.40																																																						
PRICE																																																							
1-24	\$64.11																																																						
25-49	\$60.90																																																						
50-99	\$57.70																																																						
100+	\$55.13																																																						
PRICE																																																							
1-24	\$57.27																																																						
25-49	\$54.41																																																						
50-99	\$51.54																																																						
100+	\$49.25																																																						
4	<p><b>SMC In-Series</b></p> 		 <table border="1"> <thead> <tr> <th colspan="2">PRICE</th> </tr> </thead> <tbody> <tr> <td>1-24</td> <td>\$36.25</td> </tr> <tr> <td>25-49</td> <td>\$34.44</td> </tr> <tr> <td>50-99</td> <td>\$32.63</td> </tr> <tr> <td>100+</td> <td>\$31.18</td> </tr> </tbody> </table> <p>SMC Plug to SMC Plug Max. Freq. 6 GHz Model No: <a href="#">PE9117</a></p>	PRICE		1-24	\$36.25	25-49	\$34.44	50-99	\$32.63	100+	\$31.18	 <table border="1"> <thead> <tr> <th colspan="2">PRICE</th> </tr> </thead> <tbody> <tr> <td>1-24</td> <td>\$62.20</td> </tr> <tr> <td>25-49</td> <td>\$59.09</td> </tr> <tr> <td>50-99</td> <td>\$55.98</td> </tr> <tr> <td>100+</td> <td>\$53.49</td> </tr> </tbody> </table> <p>SMC Plug to SMC Plug Tee Model No: <a href="#">PE9305</a></p>	PRICE		1-24	\$62.20	25-49	\$59.09	50-99	\$55.98	100+	\$53.49	 <table border="1"> <thead> <tr> <th colspan="2">PRICE</th> </tr> </thead> <tbody> <tr> <td>1-24</td> <td>\$53.82</td> </tr> <tr> <td>25-49</td> <td>\$51.13</td> </tr> <tr> <td>50-99</td> <td>\$48.44</td> </tr> <tr> <td>100+</td> <td>\$46.29</td> </tr> </tbody> </table> <p>SMC Plug to SMC Jack VSWR 1.2:1 to 10 GHz Model No: <a href="#">PE9119</a></p>	PRICE		1-24	\$53.82	25-49	\$51.13	50-99	\$48.44	100+	\$46.29	 <table border="1"> <thead> <tr> <th colspan="2">PRICE</th> </tr> </thead> <tbody> <tr> <td>1-24</td> <td>\$68.41</td> </tr> <tr> <td>25-49</td> <td>\$64.99</td> </tr> <tr> <td>50-99</td> <td>\$61.57</td> </tr> <tr> <td>100+</td> <td>\$58.83</td> </tr> </tbody> </table> <p>SMC Plug to SMC Jack Right Angle Model No: <a href="#">PE9303</a></p>	PRICE		1-24	\$68.41	25-49	\$64.99	50-99	\$61.57	100+	\$58.83									
	PRICE																																																						
1-24	\$36.25																																																						
25-49	\$34.44																																																						
50-99	\$32.63																																																						
100+	\$31.18																																																						
PRICE																																																							
1-24	\$62.20																																																						
25-49	\$59.09																																																						
50-99	\$55.98																																																						
100+	\$53.49																																																						
PRICE																																																							
1-24	\$53.82																																																						
25-49	\$51.13																																																						
50-99	\$48.44																																																						
100+	\$46.29																																																						
PRICE																																																							
1-24	\$68.41																																																						
25-49	\$64.99																																																						
50-99	\$61.57																																																						
100+	\$58.83																																																						
5	 <table border="1"> <thead> <tr> <th colspan="2">PRICE</th> </tr> </thead> <tbody> <tr> <td>1-24</td> <td>\$49.05</td> </tr> <tr> <td>25-49</td> <td>\$46.60</td> </tr> <tr> <td>50-99</td> <td>\$44.15</td> </tr> <tr> <td>100+</td> <td>\$42.18</td> </tr> </tbody> </table> <p>SMC Jack to SMC Plug Tee Max. Freq. 100 MHz Model No: <a href="#">PE9242</a></p>	PRICE		1-24	\$49.05	25-49	\$46.60	50-99	\$44.15	100+	\$42.18	 <table border="1"> <thead> <tr> <th colspan="2">PRICE</th> </tr> </thead> <tbody> <tr> <td>1-24</td> <td>\$71.22</td> </tr> <tr> <td>25-49</td> <td>\$67.66</td> </tr> <tr> <td>50-99</td> <td>\$64.10</td> </tr> <tr> <td>100+</td> <td>\$61.25</td> </tr> </tbody> </table> <p>SMC Jack to SMC Jack Tee Model No: <a href="#">PE9304</a></p>	PRICE		1-24	\$71.22	25-49	\$67.66	50-99	\$64.10	100+	\$61.25	 <table border="1"> <thead> <tr> <th colspan="2">PRICE</th> </tr> </thead> <tbody> <tr> <td>1-24</td> <td>\$37.23</td> </tr> <tr> <td>25-49</td> <td>\$35.37</td> </tr> <tr> <td>50-99</td> <td>\$33.51</td> </tr> <tr> <td>100+</td> <td>\$32.02</td> </tr> </tbody> </table> <p>SMC Jack to SMC Jack Bulkhead-Mounting Hole B01 Max. Freq. 10 GHz Model No: <a href="#">PE91403</a></p>	PRICE		1-24	\$37.23	25-49	\$35.37	50-99	\$33.51	100+	\$32.02	<p><b>SMC Between Series</b></p> 		 <table border="1"> <thead> <tr> <th colspan="2">PRICE</th> </tr> </thead> <tbody> <tr> <td>1-24</td> <td>\$62.94</td> </tr> <tr> <td>25-49</td> <td>\$59.79</td> </tr> <tr> <td>50-99</td> <td>\$56.65</td> </tr> <tr> <td>100+</td> <td>\$54.13</td> </tr> </tbody> </table> <p>SMC Plug to BNC Male Model No: <a href="#">PE9139</a></p>	PRICE		1-24	\$62.94	25-49	\$59.79	50-99	\$56.65	100+	\$54.13									
	PRICE																																																						
1-24	\$49.05																																																						
25-49	\$46.60																																																						
50-99	\$44.15																																																						
100+	\$42.18																																																						
PRICE																																																							
1-24	\$71.22																																																						
25-49	\$67.66																																																						
50-99	\$64.10																																																						
100+	\$61.25																																																						
PRICE																																																							
1-24	\$37.23																																																						
25-49	\$35.37																																																						
50-99	\$33.51																																																						
100+	\$32.02																																																						
PRICE																																																							
1-24	\$62.94																																																						
25-49	\$59.79																																																						
50-99	\$56.65																																																						
100+	\$54.13																																																						
6	 <table border="1"> <thead> <tr> <th colspan="2">PRICE</th> </tr> </thead> <tbody> <tr> <td>1-24</td> <td>\$61.95</td> </tr> <tr> <td>25-49</td> <td>\$58.85</td> </tr> <tr> <td>50-99</td> <td>\$55.76</td> </tr> <tr> <td>100+</td> <td>\$53.28</td> </tr> </tbody> </table> <p>SMC Plug to BNC Female VSWR 1.3:1 to 4 GHz Model No: <a href="#">PE9141</a></p>	PRICE		1-24	\$61.95	25-49	\$58.85	50-99	\$55.76	100+	\$53.28	 <table border="1"> <thead> <tr> <th colspan="2">PRICE</th> </tr> </thead> <tbody> <tr> <td>1-24</td> <td>\$92.90</td> </tr> <tr> <td>25-49</td> <td>\$88.26</td> </tr> <tr> <td>50-99</td> <td>\$83.61</td> </tr> <tr> <td>100+</td> <td>\$79.89</td> </tr> </tbody> </table> <p>SMC Plug to SMB Plug Model No: <a href="#">PE9281</a></p>	PRICE		1-24	\$92.90	25-49	\$88.26	50-99	\$83.61	100+	\$79.89	 <table border="1"> <thead> <tr> <th colspan="2">PRICE</th> </tr> </thead> <tbody> <tr> <td>1-24</td> <td>\$47.31</td> </tr> <tr> <td>25-49</td> <td>\$44.94</td> </tr> <tr> <td>50-99</td> <td>\$42.58</td> </tr> <tr> <td>100+</td> <td>\$40.69</td> </tr> </tbody> </table> <p>SMC Plug to SMB Jack Model No: <a href="#">PE9284</a></p>	PRICE		1-24	\$47.31	25-49	\$44.94	50-99	\$42.58	100+	\$40.69	 <table border="1"> <thead> <tr> <th colspan="2">PRICE</th> </tr> </thead> <tbody> <tr> <td>1-24</td> <td>\$61.95</td> </tr> <tr> <td>25-49</td> <td>\$58.85</td> </tr> <tr> <td>50-99</td> <td>\$55.76</td> </tr> <tr> <td>100+</td> <td>\$53.28</td> </tr> </tbody> </table> <p>SMC Jack to BNC Male Model No: <a href="#">PE9138</a></p>	PRICE		1-24	\$61.95	25-49	\$58.85	50-99	\$55.76	100+	\$53.28	 <table border="1"> <thead> <tr> <th colspan="2">PRICE</th> </tr> </thead> <tbody> <tr> <td>1-24</td> <td>\$72.21</td> </tr> <tr> <td>25-49</td> <td>\$68.60</td> </tr> <tr> <td>50-99</td> <td>\$64.99</td> </tr> <tr> <td>100+</td> <td>\$62.10</td> </tr> </tbody> </table> <p>SMC Jack to BNC Female VSWR 1.35:1 to 4 GHz Model No: <a href="#">PE9140</a></p>	PRICE		1-24	\$72.21	25-49	\$68.60	50-99	\$64.99	100+	\$62.10
	PRICE																																																						
1-24	\$61.95																																																						
25-49	\$58.85																																																						
50-99	\$55.76																																																						
100+	\$53.28																																																						
PRICE																																																							
1-24	\$92.90																																																						
25-49	\$88.26																																																						
50-99	\$83.61																																																						
100+	\$79.89																																																						
PRICE																																																							
1-24	\$47.31																																																						
25-49	\$44.94																																																						
50-99	\$42.58																																																						
100+	\$40.69																																																						
PRICE																																																							
1-24	\$61.95																																																						
25-49	\$58.85																																																						
50-99	\$55.76																																																						
100+	\$53.28																																																						
PRICE																																																							
1-24	\$72.21																																																						
25-49	\$68.60																																																						
50-99	\$64.99																																																						
100+	\$62.10																																																						
7	 <table border="1"> <thead> <tr> <th colspan="2">PRICE</th> </tr> </thead> <tbody> <tr> <td>1-24</td> <td>\$85.11</td> </tr> <tr> <td>25-49</td> <td>\$80.85</td> </tr> <tr> <td>50-99</td> <td>\$76.60</td> </tr> <tr> <td>100+</td> <td>\$73.19</td> </tr> </tbody> </table> <p>SMC Jack to BNC Female Bulkhead Model No: <a href="#">PE9108</a></p>	PRICE		1-24	\$85.11	25-49	\$80.85	50-99	\$76.60	100+	\$73.19	 <table border="1"> <thead> <tr> <th colspan="2">PRICE</th> </tr> </thead> <tbody> <tr> <td>1-24</td> <td>\$60.04</td> </tr> <tr> <td>25-49</td> <td>\$57.04</td> </tr> <tr> <td>50-99</td> <td>\$54.04</td> </tr> <tr> <td>100+</td> <td>\$51.63</td> </tr> </tbody> </table> <p>SMC Jack to SMB Plug Model No: <a href="#">PE9282</a></p>	PRICE		1-24	\$60.04	25-49	\$57.04	50-99	\$54.04	100+	\$51.63	 <table border="1"> <thead> <tr> <th colspan="2">PRICE</th> </tr> </thead> <tbody> <tr> <td>1-24</td> <td>\$61.62</td> </tr> <tr> <td>25-49</td> <td>\$58.54</td> </tr> <tr> <td>50-99</td> <td>\$55.46</td> </tr> <tr> <td>100+</td> <td>\$52.99</td> </tr> </tbody> </table> <p>SMC Jack to SMB Jack Model No: <a href="#">PE9283</a></p>	PRICE		1-24	\$61.62	25-49	\$58.54	50-99	\$55.46	100+	\$52.99	<p><b>SMP In-Series</b></p> 		 <table border="1"> <thead> <tr> <th colspan="2">PRICE</th> </tr> </thead> <tbody> <tr> <td>1-24</td> <td>\$23.95</td> </tr> <tr> <td>25-49</td> <td>\$22.75</td> </tr> <tr> <td>50-99</td> <td>\$21.56</td> </tr> <tr> <td>100+</td> <td>\$20.60</td> </tr> </tbody> </table> <p>SMP Female to SMP Female VSWR 1.2:1 to 12 GHz Model No: <a href="#">PE91102</a></p>	PRICE		1-24	\$23.95	25-49	\$22.75	50-99	\$21.56	100+	\$20.60									
	PRICE																																																						
1-24	\$85.11																																																						
25-49	\$80.85																																																						
50-99	\$76.60																																																						
100+	\$73.19																																																						
PRICE																																																							
1-24	\$60.04																																																						
25-49	\$57.04																																																						
50-99	\$54.04																																																						
100+	\$51.63																																																						
PRICE																																																							
1-24	\$61.62																																																						
25-49	\$58.54																																																						
50-99	\$55.46																																																						
100+	\$52.99																																																						
PRICE																																																							
1-24	\$23.95																																																						
25-49	\$22.75																																																						
50-99	\$21.56																																																						
100+	\$20.60																																																						



Technical Support  
+1 (949) 261-1920



Same-Day Shipping,  
Even Custom  
Cable Assemblies

# ADAPTERS

See Adapter Locator on Pages 10-15

See Page 409 for Mounting Holes

Adapters

See Our Website For Current Pricing & Real-Time Stock Availability!

	A	B	C	D	E																																																		
1	 <table border="1"> <thead> <tr> <th colspan="2">PRICE</th> </tr> </thead> <tbody> <tr> <td>1-24</td> <td>\$81.24</td> </tr> <tr> <td>25-49</td> <td>\$77.18</td> </tr> <tr> <td>50-99</td> <td>\$73.12</td> </tr> <tr> <td>100+</td> <td>\$69.87</td> </tr> </tbody> </table> <p>SMP Female to SMP Female Max. Freq. 26.5 GHz Model No: <a href="#">PE9776</a></p>	PRICE		1-24	\$81.24	25-49	\$77.18	50-99	\$73.12	100+	\$69.87	 <table border="1"> <thead> <tr> <th colspan="2">PRICE</th> </tr> </thead> <tbody> <tr> <td>1-24</td> <td>\$24.47</td> </tr> <tr> <td>25-49</td> <td>\$23.25</td> </tr> <tr> <td>50-99</td> <td>\$22.02</td> </tr> <tr> <td>100+</td> <td>\$21.04</td> </tr> </tbody> </table> <p>SMP Female to SMP Female VSWR 1.2:1 to 8 GHz Model No: <a href="#">PE91068</a></p>	PRICE		1-24	\$24.47	25-49	\$23.25	50-99	\$22.02	100+	\$21.04	 <table border="1"> <thead> <tr> <th colspan="2">PRICE</th> </tr> </thead> <tbody> <tr> <td>1-24</td> <td>\$37.00</td> </tr> <tr> <td>25-49</td> <td>\$35.15</td> </tr> <tr> <td>50-99</td> <td>\$33.30</td> </tr> <tr> <td>100+</td> <td>\$31.82</td> </tr> </tbody> </table> <p>SMP Female to SMP Female Max. Freq. 40 GHz Model No: <a href="#">PE91072</a></p>	PRICE		1-24	\$37.00	25-49	\$35.15	50-99	\$33.30	100+	\$31.82	 <table border="1"> <thead> <tr> <th colspan="2">PRICE</th> </tr> </thead> <tbody> <tr> <td>1-24</td> <td>\$37.28</td> </tr> <tr> <td>25-49</td> <td>\$35.42</td> </tr> <tr> <td>50-99</td> <td>\$33.55</td> </tr> <tr> <td>100+</td> <td>\$32.06</td> </tr> </tbody> </table> <p>SMP Female to SMP Female Max. Freq. 40 GHz Model No: <a href="#">PE91099</a></p>	PRICE		1-24	\$37.28	25-49	\$35.42	50-99	\$33.55	100+	\$32.06	 <table border="1"> <thead> <tr> <th colspan="2">PRICE</th> </tr> </thead> <tbody> <tr> <td>1-24</td> <td>\$16.12</td> </tr> <tr> <td>25-49</td> <td>\$15.31</td> </tr> <tr> <td>50-99</td> <td>\$14.51</td> </tr> <tr> <td>100+</td> <td>\$13.86</td> </tr> </tbody> </table> <p>SMP Female to SMP Female VSWR 1.2:1 to 8 GHz Model No: <a href="#">PE91101</a></p>	PRICE		1-24	\$16.12	25-49	\$15.31	50-99	\$14.51	100+	\$13.86
PRICE																																																							
1-24	\$81.24																																																						
25-49	\$77.18																																																						
50-99	\$73.12																																																						
100+	\$69.87																																																						
PRICE																																																							
1-24	\$24.47																																																						
25-49	\$23.25																																																						
50-99	\$22.02																																																						
100+	\$21.04																																																						
PRICE																																																							
1-24	\$37.00																																																						
25-49	\$35.15																																																						
50-99	\$33.30																																																						
100+	\$31.82																																																						
PRICE																																																							
1-24	\$37.28																																																						
25-49	\$35.42																																																						
50-99	\$33.55																																																						
100+	\$32.06																																																						
PRICE																																																							
1-24	\$16.12																																																						
25-49	\$15.31																																																						
50-99	\$14.51																																																						
100+	\$13.86																																																						
2	 <table border="1"> <thead> <tr> <th colspan="2">PRICE</th> </tr> </thead> <tbody> <tr> <td>1-24</td> <td>\$74.97</td> </tr> <tr> <td>25-49</td> <td>\$71.22</td> </tr> <tr> <td>50-99</td> <td>\$67.47</td> </tr> <tr> <td>100+</td> <td>\$64.47</td> </tr> </tbody> </table> <p>SMP Female to SMP Female Max. Freq. 26.5 GHz Model No: <a href="#">PE9775</a></p>	PRICE		1-24	\$74.97	25-49	\$71.22	50-99	\$67.47	100+	\$64.47	 <table border="1"> <thead> <tr> <th colspan="2">PRICE</th> </tr> </thead> <tbody> <tr> <td>1-24</td> <td>\$48.36</td> </tr> <tr> <td>25-49</td> <td>\$45.94</td> </tr> <tr> <td>50-99</td> <td>\$43.52</td> </tr> <tr> <td>100+</td> <td>\$41.59</td> </tr> </tbody> </table> <p>SMP Female to SMP Female Max. Freq. 26.5 GHz Model No: <a href="#">PE9777</a></p>	PRICE		1-24	\$48.36	25-49	\$45.94	50-99	\$43.52	100+	\$41.59	<p><b>SMP Between Series</b></p> 		 <table border="1"> <thead> <tr> <th colspan="2">PRICE</th> </tr> </thead> <tbody> <tr> <td>1-24</td> <td>\$14.12</td> </tr> <tr> <td>25-49</td> <td>\$13.41</td> </tr> <tr> <td>50-99</td> <td>\$12.71</td> </tr> <tr> <td>100+</td> <td>\$12.14</td> </tr> </tbody> </table> <p>Push-On SMP Female to Snap-On MMBX Plug VSWR 1.25:1 to 6 GHz Model No: <a href="#">PE91364</a></p>	PRICE		1-24	\$14.12	25-49	\$13.41	50-99	\$12.71	100+	\$12.14	 <table border="1"> <thead> <tr> <th colspan="2">PRICE</th> </tr> </thead> <tbody> <tr> <td>1-24</td> <td>\$30.24</td> </tr> <tr> <td>25-49</td> <td>\$28.73</td> </tr> <tr> <td>50-99</td> <td>\$27.22</td> </tr> <tr> <td>100+</td> <td>\$26.01</td> </tr> </tbody> </table> <p>SMP Female to SMP Female Max. Freq. 40 GHz Model No: <a href="#">PE91065</a></p>	PRICE		1-24	\$30.24	25-49	\$28.73	50-99	\$27.22	100+	\$26.01									
PRICE																																																							
1-24	\$74.97																																																						
25-49	\$71.22																																																						
50-99	\$67.47																																																						
100+	\$64.47																																																						
PRICE																																																							
1-24	\$48.36																																																						
25-49	\$45.94																																																						
50-99	\$43.52																																																						
100+	\$41.59																																																						
PRICE																																																							
1-24	\$14.12																																																						
25-49	\$13.41																																																						
50-99	\$12.71																																																						
100+	\$12.14																																																						
PRICE																																																							
1-24	\$30.24																																																						
25-49	\$28.73																																																						
50-99	\$27.22																																																						
100+	\$26.01																																																						
3	<p><b>SSMA In-Series</b></p> 		 <table border="1"> <thead> <tr> <th colspan="2">PRICE</th> </tr> </thead> <tbody> <tr> <td>1-9</td> <td>\$121.65</td> </tr> <tr> <td>10-24</td> <td>\$115.57</td> </tr> <tr> <td>25-49</td> <td>\$109.49</td> </tr> <tr> <td>50+</td> <td>\$104.62</td> </tr> </tbody> </table> <p>SSMA Male to SSMA Male Model No: <a href="#">PE9357</a></p>	PRICE		1-9	\$121.65	10-24	\$115.57	25-49	\$109.49	50+	\$104.62	 <table border="1"> <thead> <tr> <th colspan="2">PRICE</th> </tr> </thead> <tbody> <tr> <td>1-24</td> <td>\$78.35</td> </tr> <tr> <td>25-49</td> <td>\$74.43</td> </tr> <tr> <td>50-99</td> <td>\$70.52</td> </tr> <tr> <td>100+</td> <td>\$67.38</td> </tr> </tbody> </table> <p>SSMA Male to SSMA Female Model No: <a href="#">PE9358</a></p>	PRICE		1-24	\$78.35	25-49	\$74.43	50-99	\$70.52	100+	\$67.38	 <table border="1"> <thead> <tr> <th colspan="2">PRICE</th> </tr> </thead> <tbody> <tr> <td>1-9</td> <td>\$182.03</td> </tr> <tr> <td>10-24</td> <td>\$172.93</td> </tr> <tr> <td>25-49</td> <td>\$163.83</td> </tr> <tr> <td>50+</td> <td>\$156.55</td> </tr> </tbody> </table> <p>QD SSMA Male to SSMA Female Model No: <a href="#">PE9685</a></p>	PRICE		1-9	\$182.03	10-24	\$172.93	25-49	\$163.83	50+	\$156.55	 <table border="1"> <thead> <tr> <th colspan="2">PRICE</th> </tr> </thead> <tbody> <tr> <td>1-24</td> <td>\$97.00</td> </tr> <tr> <td>25-49</td> <td>\$92.15</td> </tr> <tr> <td>50-99</td> <td>\$87.30</td> </tr> <tr> <td>100+</td> <td>\$83.42</td> </tr> </tbody> </table> <p>SSMA Male to SSMA Female Right Angle VSWR 1.3:1 to 18 GHz Model No: <a href="#">PE9334</a></p>	PRICE		1-24	\$97.00	25-49	\$92.15	50-99	\$87.30	100+	\$83.42									
PRICE																																																							
1-9	\$121.65																																																						
10-24	\$115.57																																																						
25-49	\$109.49																																																						
50+	\$104.62																																																						
PRICE																																																							
1-24	\$78.35																																																						
25-49	\$74.43																																																						
50-99	\$70.52																																																						
100+	\$67.38																																																						
PRICE																																																							
1-9	\$182.03																																																						
10-24	\$172.93																																																						
25-49	\$163.83																																																						
50+	\$156.55																																																						
PRICE																																																							
1-24	\$97.00																																																						
25-49	\$92.15																																																						
50-99	\$87.30																																																						
100+	\$83.42																																																						
4	 <table border="1"> <thead> <tr> <th colspan="2">PRICE</th> </tr> </thead> <tbody> <tr> <td>1-24</td> <td>\$69.17</td> </tr> <tr> <td>25-49</td> <td>\$65.71</td> </tr> <tr> <td>50-99</td> <td>\$62.25</td> </tr> <tr> <td>100+</td> <td>\$59.49</td> </tr> </tbody> </table> <p>SSMA Female to SSMA Female VSWR 1.3:1 to 25 GHz Model No: <a href="#">PE9192</a></p>	PRICE		1-24	\$69.17	25-49	\$65.71	50-99	\$62.25	100+	\$59.49	 <table border="1"> <thead> <tr> <th colspan="2">PRICE</th> </tr> </thead> <tbody> <tr> <td>1-24</td> <td>\$71.93</td> </tr> <tr> <td>25-49</td> <td>\$68.33</td> </tr> <tr> <td>50-99</td> <td>\$64.74</td> </tr> <tr> <td>100+</td> <td>\$61.86</td> </tr> </tbody> </table> <p>SSMA Female to SSMA Female Bulkhead-Mounting Hole B01 Model No: <a href="#">PE9189</a></p>	PRICE		1-24	\$71.93	25-49	\$68.33	50-99	\$64.74	100+	\$61.86	<p><b>SSMA Between Series</b></p> 		 <table border="1"> <thead> <tr> <th colspan="2">PRICE</th> </tr> </thead> <tbody> <tr> <td>1-9</td> <td>\$133.51</td> </tr> <tr> <td>10-24</td> <td>\$126.83</td> </tr> <tr> <td>25-49</td> <td>\$120.16</td> </tr> <tr> <td>50+</td> <td>\$114.82</td> </tr> </tbody> </table> <p>SSMA Male to BNC Male Model No: <a href="#">PE9213</a></p>	PRICE		1-9	\$133.51	10-24	\$126.83	25-49	\$120.16	50+	\$114.82	 <table border="1"> <thead> <tr> <th colspan="2">PRICE</th> </tr> </thead> <tbody> <tr> <td>1-24</td> <td>\$120.80</td> </tr> <tr> <td>25-49</td> <td>\$114.76</td> </tr> <tr> <td>50-99</td> <td>\$108.72</td> </tr> <tr> <td>100+</td> <td>\$103.89</td> </tr> </tbody> </table> <p>SSMA Male to BNC Female Model No: <a href="#">PE91046</a></p>	PRICE		1-24	\$120.80	25-49	\$114.76	50-99	\$108.72	100+	\$103.89									
PRICE																																																							
1-24	\$69.17																																																						
25-49	\$65.71																																																						
50-99	\$62.25																																																						
100+	\$59.49																																																						
PRICE																																																							
1-24	\$71.93																																																						
25-49	\$68.33																																																						
50-99	\$64.74																																																						
100+	\$61.86																																																						
PRICE																																																							
1-9	\$133.51																																																						
10-24	\$126.83																																																						
25-49	\$120.16																																																						
50+	\$114.82																																																						
PRICE																																																							
1-24	\$120.80																																																						
25-49	\$114.76																																																						
50-99	\$108.72																																																						
100+	\$103.89																																																						
5	 <table border="1"> <thead> <tr> <th colspan="2">PRICE</th> </tr> </thead> <tbody> <tr> <td>1-24</td> <td>\$105.74</td> </tr> <tr> <td>25-49</td> <td>\$100.45</td> </tr> <tr> <td>50-99</td> <td>\$95.17</td> </tr> <tr> <td>100+</td> <td>\$90.94</td> </tr> </tbody> </table> <p>SSMA Male to N Male Max. Freq. 11 GHz Model No: <a href="#">PE9351</a></p>	PRICE		1-24	\$105.74	25-49	\$100.45	50-99	\$95.17	100+	\$90.94	 <table border="1"> <thead> <tr> <th colspan="2">PRICE</th> </tr> </thead> <tbody> <tr> <td>1-24</td> <td>\$105.81</td> </tr> <tr> <td>25-49</td> <td>\$101.58</td> </tr> <tr> <td>50-99</td> <td>\$98.40</td> </tr> <tr> <td>100+</td> <td>\$96.29</td> </tr> </tbody> </table> <p>SSMA Female to BNC Male Model No: <a href="#">PE9191</a></p>	PRICE		1-24	\$105.81	25-49	\$101.58	50-99	\$98.40	100+	\$96.29	 <table border="1"> <thead> <tr> <th colspan="2">PRICE</th> </tr> </thead> <tbody> <tr> <td>1-24</td> <td>\$94.29</td> </tr> <tr> <td>25-49</td> <td>\$89.58</td> </tr> <tr> <td>50-99</td> <td>\$84.86</td> </tr> <tr> <td>100+</td> <td>\$81.09</td> </tr> </tbody> </table> <p>SSMA Female to N Male Model No: <a href="#">PE9352</a></p>	PRICE		1-24	\$94.29	25-49	\$89.58	50-99	\$84.86	100+	\$81.09	 <table border="1"> <thead> <tr> <th colspan="2">PRICE</th> </tr> </thead> <tbody> <tr> <td>1-24</td> <td>\$86.91</td> </tr> <tr> <td>25-49</td> <td>\$82.56</td> </tr> <tr> <td>50-99</td> <td>\$78.22</td> </tr> <tr> <td>100+</td> <td>\$74.74</td> </tr> </tbody> </table> <p>SSMA Female to N Female Model No: <a href="#">PE9354</a></p>	PRICE		1-24	\$86.91	25-49	\$82.56	50-99	\$78.22	100+	\$74.74	<p><b>SSMB Between Series</b></p> 										
PRICE																																																							
1-24	\$105.74																																																						
25-49	\$100.45																																																						
50-99	\$95.17																																																						
100+	\$90.94																																																						
PRICE																																																							
1-24	\$105.81																																																						
25-49	\$101.58																																																						
50-99	\$98.40																																																						
100+	\$96.29																																																						
PRICE																																																							
1-24	\$94.29																																																						
25-49	\$89.58																																																						
50-99	\$84.86																																																						
100+	\$81.09																																																						
PRICE																																																							
1-24	\$86.91																																																						
25-49	\$82.56																																																						
50-99	\$78.22																																																						
100+	\$74.74																																																						
6	 <table border="1"> <thead> <tr> <th colspan="2">PRICE</th> </tr> </thead> <tbody> <tr> <td>1-24</td> <td>\$94.72</td> </tr> <tr> <td>25-49</td> <td>\$89.98</td> </tr> <tr> <td>50-99</td> <td>\$85.25</td> </tr> <tr> <td>100+</td> <td>\$81.46</td> </tr> </tbody> </table> <p>SSMB Plug to BNC Male Model No: <a href="#">PE9393</a></p>	PRICE		1-24	\$94.72	25-49	\$89.98	50-99	\$85.25	100+	\$81.46	 <table border="1"> <thead> <tr> <th colspan="2">PRICE</th> </tr> </thead> <tbody> <tr> <td>1-24</td> <td>\$116.94</td> </tr> <tr> <td>25-49</td> <td>\$111.09</td> </tr> <tr> <td>50-99</td> <td>\$105.25</td> </tr> <tr> <td>100+</td> <td>\$100.57</td> </tr> </tbody> </table> <p>SSMB Plug to BNC Female Model No: <a href="#">PE9395</a></p>	PRICE		1-24	\$116.94	25-49	\$111.09	50-99	\$105.25	100+	\$100.57	 <table border="1"> <thead> <tr> <th colspan="2">PRICE</th> </tr> </thead> <tbody> <tr> <td>1-24</td> <td>\$120.36</td> </tr> <tr> <td>25-49</td> <td>\$114.34</td> </tr> <tr> <td>50-99</td> <td>\$108.32</td> </tr> <tr> <td>100+</td> <td>\$103.51</td> </tr> </tbody> </table> <p>SSMB Jack to BNC Male Model No: <a href="#">PE9392</a></p>	PRICE		1-24	\$120.36	25-49	\$114.34	50-99	\$108.32	100+	\$103.51	 <table border="1"> <thead> <tr> <th colspan="2">PRICE</th> </tr> </thead> <tbody> <tr> <td>1-24</td> <td>\$120.32</td> </tr> <tr> <td>25-49</td> <td>\$114.30</td> </tr> <tr> <td>50-99</td> <td>\$108.29</td> </tr> <tr> <td>100+</td> <td>\$103.48</td> </tr> </tbody> </table> <p>SSMB Jack to BNC Female Model No: <a href="#">PE9394</a></p>	PRICE		1-24	\$120.32	25-49	\$114.30	50-99	\$108.29	100+	\$103.48	<p><b>SSMC In-Series</b></p> 										
PRICE																																																							
1-24	\$94.72																																																						
25-49	\$89.98																																																						
50-99	\$85.25																																																						
100+	\$81.46																																																						
PRICE																																																							
1-24	\$116.94																																																						
25-49	\$111.09																																																						
50-99	\$105.25																																																						
100+	\$100.57																																																						
PRICE																																																							
1-24	\$120.36																																																						
25-49	\$114.34																																																						
50-99	\$108.32																																																						
100+	\$103.51																																																						
PRICE																																																							
1-24	\$120.32																																																						
25-49	\$114.30																																																						
50-99	\$108.29																																																						
100+	\$103.48																																																						
7	 <table border="1"> <thead> <tr> <th colspan="2">PRICE</th> </tr> </thead> <tbody> <tr> <td>1-24</td> <td>\$57.39</td> </tr> <tr> <td>25-49</td> <td>\$55.09</td> </tr> <tr> <td>50-99</td> <td>\$53.37</td> </tr> <tr> <td>100+</td> <td>\$52.22</td> </tr> </tbody> </table> <p>SSMC Plug to SSMC Plug VSWR 1.25:1 to 12 GHz Model No: <a href="#">PE91436</a></p>	PRICE		1-24	\$57.39	25-49	\$55.09	50-99	\$53.37	100+	\$52.22	 <table border="1"> <thead> <tr> <th colspan="2">PRICE</th> </tr> </thead> <tbody> <tr> <td>1-24</td> <td>\$57.39</td> </tr> <tr> <td>25-49</td> <td>\$54.52</td> </tr> <tr> <td>50-99</td> <td>\$51.65</td> </tr> <tr> <td>100+</td> <td>\$49.36</td> </tr> </tbody> </table> <p>SSMC Plug to SSMC Jack VSWR 1.25:1 to 12 GHz Model No: <a href="#">PE91434</a></p>	PRICE		1-24	\$57.39	25-49	\$54.52	50-99	\$51.65	100+	\$49.36	 <table border="1"> <thead> <tr> <th colspan="2">PRICE</th> </tr> </thead> <tbody> <tr> <td>1-24</td> <td>\$57.39</td> </tr> <tr> <td>25-49</td> <td>\$54.52</td> </tr> <tr> <td>50-99</td> <td>\$51.65</td> </tr> <tr> <td>100+</td> <td>\$49.36</td> </tr> </tbody> </table> <p>SSMC Jack to SSMC Jack Bulkhead VSWR 1.25:1 to 4 GHz Model No: <a href="#">PE91432</a></p>	PRICE		1-24	\$57.39	25-49	\$54.52	50-99	\$51.65	100+	\$49.36	<p><b>TNC In-Series</b></p> 		 <table border="1"> <thead> <tr> <th colspan="2">PRICE</th> </tr> </thead> <tbody> <tr> <td>1-24</td> <td>\$67.62</td> </tr> <tr> <td>25-49</td> <td>\$64.24</td> </tr> <tr> <td>50-99</td> <td>\$60.86</td> </tr> <tr> <td>100+</td> <td>\$58.15</td> </tr> </tbody> </table> <p>Low PIM TNC Male to TNC Male VSWR 1.25:1 to 6 GHz Model No: <a href="#">PE91172</a></p>	PRICE		1-24	\$67.62	25-49	\$64.24	50-99	\$60.86	100+	\$58.15									
PRICE																																																							
1-24	\$57.39																																																						
25-49	\$55.09																																																						
50-99	\$53.37																																																						
100+	\$52.22																																																						
PRICE																																																							
1-24	\$57.39																																																						
25-49	\$54.52																																																						
50-99	\$51.65																																																						
100+	\$49.36																																																						
PRICE																																																							
1-24	\$57.39																																																						
25-49	\$54.52																																																						
50-99	\$51.65																																																						
100+	\$49.36																																																						
PRICE																																																							
1-24	\$67.62																																																						
25-49	\$64.24																																																						
50-99	\$60.86																																																						
100+	\$58.15																																																						

# ADAPTERS

See Adapter Locator on Pages 10-15  
See Page 409 for Mounting Holes

	A	B	C	D	E																																													
1	 <table border="1"> <thead> <tr><th>PRICE</th></tr> </thead> <tbody> <tr><td>1-24</td><td>\$58.24</td></tr> <tr><td>25-49</td><td>\$55.33</td></tr> <tr><td>50-99</td><td>\$52.42</td></tr> <tr><td>100+</td><td>\$50.09</td></tr> </tbody> </table> <p>TNC Male to TNC Male VSWR 1.2:1 to 6 GHz Model No: <a href="#">PE91202</a></p>	PRICE	1-24	\$58.24	25-49	\$55.33	50-99	\$52.42	100+	\$50.09	 <table border="1"> <thead> <tr><th>PRICE</th></tr> </thead> <tbody> <tr><td>1-24</td><td>\$57.20</td></tr> <tr><td>25-49</td><td>\$54.34</td></tr> <tr><td>50-99</td><td>\$51.48</td></tr> <tr><td>100+</td><td>\$49.19</td></tr> </tbody> </table> <p>TNC Male to TNC Male VSWR 1.3:1 to 6 GHz Model No: <a href="#">PE91239</a></p>	PRICE	1-24	\$57.20	25-49	\$54.34	50-99	\$51.48	100+	\$49.19	 <table border="1"> <thead> <tr><th>PRICE</th></tr> </thead> <tbody> <tr><td>1-24</td><td>\$38.32</td></tr> <tr><td>25-49</td><td>\$36.40</td></tr> <tr><td>50-99</td><td>\$34.49</td></tr> <tr><td>100+</td><td>\$32.96</td></tr> </tbody> </table> <p>TNC Male to TNC Male VSWR 1.3:1 to 1,000 MHz Model No: <a href="#">PE9091</a></p>	PRICE	1-24	\$38.32	25-49	\$36.40	50-99	\$34.49	100+	\$32.96	 <table border="1"> <thead> <tr><th>PRICE</th></tr> </thead> <tbody> <tr><td>1-9</td><td>\$169.61</td></tr> <tr><td>10-24</td><td>\$161.13</td></tr> <tr><td>25-49</td><td>\$152.65</td></tr> <tr><td>50+</td><td>\$145.86</td></tr> </tbody> </table> <p>TNC Male to TNC Male VSWR 1.25:1 to 18 GHz Model No: <a href="#">PE9445</a></p>	PRICE	1-9	\$169.61	10-24	\$161.13	25-49	\$152.65	50+	\$145.86	 <table border="1"> <thead> <tr><th>PRICE</th></tr> </thead> <tbody> <tr><td>1-24</td><td>\$102.38</td></tr> <tr><td>25-49</td><td>\$97.26</td></tr> <tr><td>50-99</td><td>\$92.14</td></tr> <tr><td>100+</td><td>\$88.05</td></tr> </tbody> </table> <p>TNC Male to TNC Male Right Angle Model No: <a href="#">PE9560</a></p>	PRICE	1-24	\$102.38	25-49	\$97.26	50-99	\$92.14	100+	\$88.05
	PRICE																																																	
1-24	\$58.24																																																	
25-49	\$55.33																																																	
50-99	\$52.42																																																	
100+	\$50.09																																																	
PRICE																																																		
1-24	\$57.20																																																	
25-49	\$54.34																																																	
50-99	\$51.48																																																	
100+	\$49.19																																																	
PRICE																																																		
1-24	\$38.32																																																	
25-49	\$36.40																																																	
50-99	\$34.49																																																	
100+	\$32.96																																																	
PRICE																																																		
1-9	\$169.61																																																	
10-24	\$161.13																																																	
25-49	\$152.65																																																	
50+	\$145.86																																																	
PRICE																																																		
1-24	\$102.38																																																	
25-49	\$97.26																																																	
50-99	\$92.14																																																	
100+	\$88.05																																																	
2	 <table border="1"> <thead> <tr><th>PRICE</th></tr> </thead> <tbody> <tr><td>1-24</td><td>\$58.24</td></tr> <tr><td>25-49</td><td>\$55.33</td></tr> <tr><td>50-99</td><td>\$52.42</td></tr> <tr><td>100+</td><td>\$50.09</td></tr> </tbody> </table> <p>TNC Male to TNC Female VSWR 1.2:1 to 6 GHz Model No: <a href="#">PE91203</a></p>	PRICE	1-24	\$58.24	25-49	\$55.33	50-99	\$52.42	100+	\$50.09	 <table border="1"> <thead> <tr><th>PRICE</th></tr> </thead> <tbody> <tr><td>1-24</td><td>\$56.87</td></tr> <tr><td>25-49</td><td>\$54.03</td></tr> <tr><td>50-99</td><td>\$51.18</td></tr> <tr><td>100+</td><td>\$48.91</td></tr> </tbody> </table> <p>TNC Male to TNC Female VSWR 1.3:1 to 6 GHz Model No: <a href="#">PE91240</a></p>	PRICE	1-24	\$56.87	25-49	\$54.03	50-99	\$51.18	100+	\$48.91	 <table border="1"> <thead> <tr><th>PRICE</th></tr> </thead> <tbody> <tr><td>1-24</td><td>\$78.69</td></tr> <tr><td>25-49</td><td>\$74.76</td></tr> <tr><td>50-99</td><td>\$70.82</td></tr> <tr><td>100+</td><td>\$67.67</td></tr> </tbody> </table> <p>PRECISION TNC Male to TNC Female VSWR 1.15:1 to 18 GHz Model No: <a href="#">PE91505</a></p>	PRICE	1-24	\$78.69	25-49	\$74.76	50-99	\$70.82	100+	\$67.67	 <table border="1"> <thead> <tr><th>PRICE</th></tr> </thead> <tbody> <tr><td>1-24</td><td>\$64.44</td></tr> <tr><td>25-49</td><td>\$61.22</td></tr> <tr><td>50-99</td><td>\$58.00</td></tr> <tr><td>100+</td><td>\$55.42</td></tr> </tbody> </table> <p>Low PIM TNC Male to TNC Female VSWR 1.25:1 to 6 GHz Model No: <a href="#">PE91173</a></p>	PRICE	1-24	\$64.44	25-49	\$61.22	50-99	\$58.00	100+	\$55.42	 <table border="1"> <thead> <tr><th>PRICE</th></tr> </thead> <tbody> <tr><td>1-24</td><td>\$27.14</td></tr> <tr><td>25-49</td><td>\$25.78</td></tr> <tr><td>50-99</td><td>\$24.43</td></tr> <tr><td>100+</td><td>\$23.34</td></tr> </tbody> </table> <p>TNC Male to TNC Female VSWR 1.5:1 to 11 GHz Model No: <a href="#">PE9270</a></p>	PRICE	1-24	\$27.14	25-49	\$25.78	50-99	\$24.43	100+	\$23.34
	PRICE																																																	
1-24	\$58.24																																																	
25-49	\$55.33																																																	
50-99	\$52.42																																																	
100+	\$50.09																																																	
PRICE																																																		
1-24	\$56.87																																																	
25-49	\$54.03																																																	
50-99	\$51.18																																																	
100+	\$48.91																																																	
PRICE																																																		
1-24	\$78.69																																																	
25-49	\$74.76																																																	
50-99	\$70.82																																																	
100+	\$67.67																																																	
PRICE																																																		
1-24	\$64.44																																																	
25-49	\$61.22																																																	
50-99	\$58.00																																																	
100+	\$55.42																																																	
PRICE																																																		
1-24	\$27.14																																																	
25-49	\$25.78																																																	
50-99	\$24.43																																																	
100+	\$23.34																																																	
3	 <table border="1"> <thead> <tr><th>PRICE</th></tr> </thead> <tbody> <tr><td>1-24</td><td>\$143.45</td></tr> <tr><td>25-49</td><td>\$133.41</td></tr> <tr><td>50-99</td><td>\$123.37</td></tr> <tr><td>100+</td><td>\$114.76</td></tr> </tbody> </table> <p>PRECISION TNC Male to TNC Female VSWR 1.15:1 to 18 GHz Model No: <a href="#">PE9443</a></p>	PRICE	1-24	\$143.45	25-49	\$133.41	50-99	\$123.37	100+	\$114.76	 <table border="1"> <thead> <tr><th>PRICE</th></tr> </thead> <tbody> <tr><td>1-9</td><td>\$203.71</td></tr> <tr><td>10-24</td><td>\$193.52</td></tr> <tr><td>25-49</td><td>\$183.34</td></tr> <tr><td>50+</td><td>\$175.19</td></tr> </tbody> </table> <p>QD TNC Male to TNC Female Model No: <a href="#">PE9561</a></p>	PRICE	1-9	\$203.71	10-24	\$193.52	25-49	\$183.34	50+	\$175.19	 <table border="1"> <thead> <tr><th>PRICE</th></tr> </thead> <tbody> <tr><td>1-24</td><td>\$37.77</td></tr> <tr><td>25-49</td><td>\$35.88</td></tr> <tr><td>50-99</td><td>\$33.99</td></tr> <tr><td>100+</td><td>\$32.48</td></tr> </tbody> </table> <p>TNC Male to TNC Female Right Angle Max. Freq. 11 GHz Model No: <a href="#">PE9100</a></p>	PRICE	1-24	\$37.77	25-49	\$35.88	50-99	\$33.99	100+	\$32.48	 <table border="1"> <thead> <tr><th>PRICE</th></tr> </thead> <tbody> <tr><td>1-24</td><td>\$94.71</td></tr> <tr><td>25-49</td><td>\$89.97</td></tr> <tr><td>50-99</td><td>\$85.24</td></tr> <tr><td>100+</td><td>\$81.45</td></tr> </tbody> </table> <p>TNC Male to TNC Female Tee Model No: <a href="#">PE9290</a></p>	PRICE	1-24	\$94.71	25-49	\$89.97	50-99	\$85.24	100+	\$81.45	 <table border="1"> <thead> <tr><th>PRICE</th></tr> </thead> <tbody> <tr><td>1-24</td><td>\$31.46</td></tr> <tr><td>25-49</td><td>\$29.89</td></tr> <tr><td>50-99</td><td>\$28.31</td></tr> <tr><td>100+</td><td>\$27.06</td></tr> </tbody> </table> <p>TNC Female to TNC Male Tee Max. Freq. 11 GHz Model No: <a href="#">PE9195</a></p>	PRICE	1-24	\$31.46	25-49	\$29.89	50-99	\$28.31	100+	\$27.06
	PRICE																																																	
1-24	\$143.45																																																	
25-49	\$133.41																																																	
50-99	\$123.37																																																	
100+	\$114.76																																																	
PRICE																																																		
1-9	\$203.71																																																	
10-24	\$193.52																																																	
25-49	\$183.34																																																	
50+	\$175.19																																																	
PRICE																																																		
1-24	\$37.77																																																	
25-49	\$35.88																																																	
50-99	\$33.99																																																	
100+	\$32.48																																																	
PRICE																																																		
1-24	\$94.71																																																	
25-49	\$89.97																																																	
50-99	\$85.24																																																	
100+	\$81.45																																																	
PRICE																																																		
1-24	\$31.46																																																	
25-49	\$29.89																																																	
50-99	\$28.31																																																	
100+	\$27.06																																																	
4	 <table border="1"> <thead> <tr><th>PRICE</th></tr> </thead> <tbody> <tr><td>1-24</td><td>\$58.24</td></tr> <tr><td>25-49</td><td>\$55.33</td></tr> <tr><td>50-99</td><td>\$52.42</td></tr> <tr><td>100+</td><td>\$50.09</td></tr> </tbody> </table> <p>TNC Female to TNC Female VSWR 1.2:1 to 6 GHz Model No: <a href="#">PE91204</a></p>	PRICE	1-24	\$58.24	25-49	\$55.33	50-99	\$52.42	100+	\$50.09	 <table border="1"> <thead> <tr><th>PRICE</th></tr> </thead> <tbody> <tr><td>1-24</td><td>\$52.11</td></tr> <tr><td>25-49</td><td>\$49.50</td></tr> <tr><td>50-99</td><td>\$46.90</td></tr> <tr><td>100+</td><td>\$44.81</td></tr> </tbody> </table> <p>TNC Female to TNC Female VSWR 1.3:1 to 6 GHz Model No: <a href="#">PE91241</a></p>	PRICE	1-24	\$52.11	25-49	\$49.50	50-99	\$46.90	100+	\$44.81	 <table border="1"> <thead> <tr><th>PRICE</th></tr> </thead> <tbody> <tr><td>1-24</td><td>\$18.36</td></tr> <tr><td>25-49</td><td>\$17.44</td></tr> <tr><td>50-99</td><td>\$16.52</td></tr> <tr><td>100+</td><td>\$15.79</td></tr> </tbody> </table> <p>TNC Female to TNC Female VSWR 1.3:1 to 5 GHz Model No: <a href="#">PE9099</a></p>	PRICE	1-24	\$18.36	25-49	\$17.44	50-99	\$16.52	100+	\$15.79	 <table border="1"> <thead> <tr><th>PRICE</th></tr> </thead> <tbody> <tr><td>1-24</td><td>\$59.06</td></tr> <tr><td>25-49</td><td>\$56.11</td></tr> <tr><td>50-99</td><td>\$53.15</td></tr> <tr><td>100+</td><td>\$50.79</td></tr> </tbody> </table> <p>Low PIM TNC Female to TNC Female VSWR 1.25:1 to 6 GHz Model No: <a href="#">PE91174</a></p>	PRICE	1-24	\$59.06	25-49	\$56.11	50-99	\$53.15	100+	\$50.79	 <table border="1"> <thead> <tr><th>PRICE</th></tr> </thead> <tbody> <tr><td>1-9</td><td>\$132.84</td></tr> <tr><td>10-24</td><td>\$126.20</td></tr> <tr><td>25-49</td><td>\$119.56</td></tr> <tr><td>50+</td><td>\$114.24</td></tr> </tbody> </table> <p>PRECISION TNC Female to TNC Female VSWR 1.25:1 to 18 GHz Model No: <a href="#">PE9444</a></p>	PRICE	1-9	\$132.84	10-24	\$126.20	25-49	\$119.56	50+	\$114.24
	PRICE																																																	
1-24	\$58.24																																																	
25-49	\$55.33																																																	
50-99	\$52.42																																																	
100+	\$50.09																																																	
PRICE																																																		
1-24	\$52.11																																																	
25-49	\$49.50																																																	
50-99	\$46.90																																																	
100+	\$44.81																																																	
PRICE																																																		
1-24	\$18.36																																																	
25-49	\$17.44																																																	
50-99	\$16.52																																																	
100+	\$15.79																																																	
PRICE																																																		
1-24	\$59.06																																																	
25-49	\$56.11																																																	
50-99	\$53.15																																																	
100+	\$50.79																																																	
PRICE																																																		
1-9	\$132.84																																																	
10-24	\$126.20																																																	
25-49	\$119.56																																																	
50+	\$114.24																																																	
5	 <table border="1"> <thead> <tr><th>PRICE</th></tr> </thead> <tbody> <tr><td>1-24</td><td>\$36.36</td></tr> <tr><td>25-49</td><td>\$34.54</td></tr> <tr><td>50-99</td><td>\$32.72</td></tr> <tr><td>100+</td><td>\$31.27</td></tr> </tbody> </table> <p>TNC Female to TNC Female Tee Model No: <a href="#">PE91381</a></p>	PRICE	1-24	\$36.36	25-49	\$34.54	50-99	\$32.72	100+	\$31.27	 <table border="1"> <thead> <tr><th>PRICE</th></tr> </thead> <tbody> <tr><td>1-24</td><td>\$48.34</td></tr> <tr><td>25-49</td><td>\$45.92</td></tr> <tr><td>50-99</td><td>\$43.51</td></tr> <tr><td>100+</td><td>\$41.57</td></tr> </tbody> </table> <p>NEW TNC Female to TNC Female Bulkhead VSWR 1.35:1 to 12 GHz Model No: <a href="#">PE91430</a></p>	PRICE	1-24	\$48.34	25-49	\$45.92	50-99	\$43.51	100+	\$41.57	 <table border="1"> <thead> <tr><th>PRICE</th></tr> </thead> <tbody> <tr><td>1-24</td><td>\$40.68</td></tr> <tr><td>25-49</td><td>\$38.65</td></tr> <tr><td>50-99</td><td>\$36.61</td></tr> <tr><td>100+</td><td>\$34.98</td></tr> </tbody> </table> <p>TNC Female to TNC Female Bulkhead VSWR 1.3:1 to 6 GHz Model No: <a href="#">PE9154</a></p>	PRICE	1-24	\$40.68	25-49	\$38.65	50-99	\$36.61	100+	\$34.98	 <table border="1"> <thead> <tr><th>PRICE</th></tr> </thead> <tbody> <tr><td>1-24</td><td>\$57.80</td></tr> <tr><td>25-49</td><td>\$54.91</td></tr> <tr><td>50-99</td><td>\$52.02</td></tr> <tr><td>100+</td><td>\$49.71</td></tr> </tbody> </table> <p>TNC Female to TNC Female Bulkhead VSWR 1.2:1 to 6 GHz Model No: <a href="#">PE91205</a></p>	PRICE	1-24	\$57.80	25-49	\$54.91	50-99	\$52.02	100+	\$49.71	 <table border="1"> <thead> <tr><th>PRICE</th></tr> </thead> <tbody> <tr><td>1-24</td><td>\$70.62</td></tr> <tr><td>25-49</td><td>\$67.09</td></tr> <tr><td>50-99</td><td>\$63.56</td></tr> <tr><td>100+</td><td>\$60.73</td></tr> </tbody> </table> <p>TNC Female to TNC Female Bulkhead VSWR 1.3:1 to 6 GHz Model No: <a href="#">PE91242</a></p>	PRICE	1-24	\$70.62	25-49	\$67.09	50-99	\$63.56	100+	\$60.73
	PRICE																																																	
1-24	\$36.36																																																	
25-49	\$34.54																																																	
50-99	\$32.72																																																	
100+	\$31.27																																																	
PRICE																																																		
1-24	\$48.34																																																	
25-49	\$45.92																																																	
50-99	\$43.51																																																	
100+	\$41.57																																																	
PRICE																																																		
1-24	\$40.68																																																	
25-49	\$38.65																																																	
50-99	\$36.61																																																	
100+	\$34.98																																																	
PRICE																																																		
1-24	\$57.80																																																	
25-49	\$54.91																																																	
50-99	\$52.02																																																	
100+	\$49.71																																																	
PRICE																																																		
1-24	\$70.62																																																	
25-49	\$67.09																																																	
50-99	\$63.56																																																	
100+	\$60.73																																																	
6	 <table border="1"> <thead> <tr><th>PRICE</th></tr> </thead> <tbody> <tr><td>1-24</td><td>\$34.09</td></tr> <tr><td>25-49</td><td>\$32.39</td></tr> <tr><td>50-99</td><td>\$30.68</td></tr> <tr><td>100+</td><td>\$29.32</td></tr> </tbody> </table> <p>TNC Female to TNC Female Bulkhead Max. Freq. 11 GHz Model No: <a href="#">PE9287</a></p>	PRICE	1-24	\$34.09	25-49	\$32.39	50-99	\$30.68	100+	\$29.32	 <table border="1"> <thead> <tr><th>PRICE</th></tr> </thead> <tbody> <tr><td>1-24</td><td>\$35.93</td></tr> <tr><td>25-49</td><td>\$34.13</td></tr> <tr><td>50-99</td><td>\$32.34</td></tr> <tr><td>100+</td><td>\$30.90</td></tr> </tbody> </table> <p>TNC Female to TNC Female Bulkhead 4 Hole Flange VSWR 1.3:1 to 11 GHz Model No: <a href="#">PE9288</a></p>	PRICE	1-24	\$35.93	25-49	\$34.13	50-99	\$32.34	100+	\$30.90	<p><b>Reverse Polarity TNC In-Series</b></p> 		 <table border="1"> <thead> <tr><th>PRICE</th></tr> </thead> <tbody> <tr><td>1-24</td><td>\$48.73</td></tr> <tr><td>25-49</td><td>\$46.29</td></tr> <tr><td>50-99</td><td>\$43.86</td></tr> <tr><td>100+</td><td>\$41.91</td></tr> </tbody> </table> <p>TNC Male to Rev. Pol. TNC Female Model No: <a href="#">PE9532</a></p>	PRICE	1-24	\$48.73	25-49	\$46.29	50-99	\$43.86	100+	\$41.91	 <table border="1"> <thead> <tr><th>PRICE</th></tr> </thead> <tbody> <tr><td>1-24</td><td>\$40.00</td></tr> <tr><td>25-49</td><td>\$38.00</td></tr> <tr><td>50-99</td><td>\$36.00</td></tr> <tr><td>100+</td><td>\$34.40</td></tr> </tbody> </table> <p>TNC Female to Rev. Pol. TNC Male VSWR 1.32:1 to 6 GHz Model No: <a href="#">PE9531</a></p>	PRICE	1-24	\$40.00	25-49	\$38.00	50-99	\$36.00	100+	\$34.40								
	PRICE																																																	
1-24	\$34.09																																																	
25-49	\$32.39																																																	
50-99	\$30.68																																																	
100+	\$29.32																																																	
PRICE																																																		
1-24	\$35.93																																																	
25-49	\$34.13																																																	
50-99	\$32.34																																																	
100+	\$30.90																																																	
PRICE																																																		
1-24	\$48.73																																																	
25-49	\$46.29																																																	
50-99	\$43.86																																																	
100+	\$41.91																																																	
PRICE																																																		
1-24	\$40.00																																																	
25-49	\$38.00																																																	
50-99	\$36.00																																																	
100+	\$34.40																																																	
7	 <table border="1"> <thead> <tr><th>PRICE</th></tr> </thead> <tbody> <tr><td>1-24</td><td>\$37.53</td></tr> <tr><td>25-49</td><td>\$35.65</td></tr> <tr><td>50-99</td><td>\$33.78</td></tr> <tr><td>100+</td><td>\$32.28</td></tr> </tbody> </table> <p>Rev. Pol. TNC Male to Rev. Pol. TNC Female Right Angle VSWR 1.25:1 to 6 GHz Model No: <a href="#">PE9918</a></p>	PRICE	1-24	\$37.53	25-49	\$35.65	50-99	\$33.78	100+	\$32.28	<p><b>TNC Between Series</b></p> 		 <table border="1"> <thead> <tr><th>PRICE</th></tr> </thead> <tbody> <tr><td>1-4</td><td>\$757.61</td></tr> <tr><td>5-9</td><td>\$719.73</td></tr> <tr><td>10-24</td><td>\$681.85</td></tr> <tr><td>25+</td><td>\$651.54</td></tr> </tbody> </table> <p>PRECISION TNC Male to 7mm Sexless VSWR 1.15:1 to 18 GHz Model No: <a href="#">PE9219</a></p>	PRICE	1-4	\$757.61	5-9	\$719.73	10-24	\$681.85	25+	\$651.54	 <table border="1"> <thead> <tr><th>PRICE</th></tr> </thead> <tbody> <tr><td>1-9</td><td>\$274.38</td></tr> <tr><td>10-24</td><td>\$260.66</td></tr> <tr><td>25-49</td><td>\$246.94</td></tr> <tr><td>50+</td><td>\$235.97</td></tr> </tbody> </table> <p>TNC Male to 7/16 DIN Female VSWR 1.35:1 to 7.5 GHz Model No: <a href="#">PE9638</a></p>	PRICE	1-9	\$274.38	10-24	\$260.66	25-49	\$246.94	50+	\$235.97	 <table border="1"> <thead> <tr><th>PRICE</th></tr> </thead> <tbody> <tr><td>1-24</td><td>\$33.38</td></tr> <tr><td>25-49</td><td>\$31.04</td></tr> <tr><td>50-99</td><td>\$28.71</td></tr> <tr><td>100+</td><td>\$26.70</td></tr> </tbody> </table> <p>NEW TNC Male to BNC Male VSWR 1.4:1 to 4 GHz Model No: <a href="#">PE91449</a></p>	PRICE	1-24	\$33.38	25-49	\$31.04	50-99	\$28.71	100+	\$26.70								
	PRICE																																																	
1-24	\$37.53																																																	
25-49	\$35.65																																																	
50-99	\$33.78																																																	
100+	\$32.28																																																	
PRICE																																																		
1-4	\$757.61																																																	
5-9	\$719.73																																																	
10-24	\$681.85																																																	
25+	\$651.54																																																	
PRICE																																																		
1-9	\$274.38																																																	
10-24	\$260.66																																																	
25-49	\$246.94																																																	
50+	\$235.97																																																	
PRICE																																																		
1-24	\$33.38																																																	
25-49	\$31.04																																																	
50-99	\$28.71																																																	
100+	\$26.70																																																	



Technical Support  
+1 (949) 261-1920



Same-Day Shipping,  
Even Custom  
Cable Assemblies



# ADAPTERS

See Adapter Locator on Pages 10-15

See Page 409 for Mounting Holes

Adapters

See Our Website For Current Pricing & Real-Time Stock Availability!

	A	B	C	D	E																																																		
1	 <table border="1"> <thead> <tr><th colspan="2">PRICE</th></tr> </thead> <tbody> <tr><td>1-24</td><td>\$22.42</td></tr> <tr><td>25-49</td><td>\$21.30</td></tr> <tr><td>50-99</td><td>\$20.18</td></tr> <tr><td>100+</td><td>\$19.28</td></tr> </tbody> </table> <p>TNC Male to BNC Female VSWR 1.5:1 to 2 GHz</p> <p>Model No: <a href="#">PE9088</a></p>	PRICE		1-24	\$22.42	25-49	\$21.30	50-99	\$20.18	100+	\$19.28	 <table border="1"> <thead> <tr><th colspan="2">PRICE</th></tr> </thead> <tbody> <tr><td>1-24</td><td>\$74.10</td></tr> <tr><td>25-49</td><td>\$70.40</td></tr> <tr><td>50-99</td><td>\$66.69</td></tr> <tr><td>100+</td><td>\$63.73</td></tr> </tbody> </table> <p>TNC Male to BNC Female Right Angle</p> <p>Model No: <a href="#">PE9783</a></p>	PRICE		1-24	\$74.10	25-49	\$70.40	50-99	\$66.69	100+	\$63.73	 <table border="1"> <thead> <tr><th colspan="2">PRICE</th></tr> </thead> <tbody> <tr><td>1-24</td><td>\$125.37</td></tr> <tr><td>25-49</td><td>\$119.10</td></tr> <tr><td>50-99</td><td>\$112.83</td></tr> <tr><td>100+</td><td>\$107.82</td></tr> </tbody> </table> <p>TNC Male to C Female</p> <p>Model No: <a href="#">PE9562</a></p>	PRICE		1-24	\$125.37	25-49	\$119.10	50-99	\$112.83	100+	\$107.82	 <table border="1"> <thead> <tr><th colspan="2">PRICE</th></tr> </thead> <tbody> <tr><td>1-24</td><td>\$22.89</td></tr> <tr><td>25-49</td><td>\$21.75</td></tr> <tr><td>50-99</td><td>\$20.60</td></tr> <tr><td>100+</td><td>\$19.69</td></tr> </tbody> </table> <p>TNC Male to FME Plug</p> <p>Model No: <a href="#">PE9699</a></p>	PRICE		1-24	\$22.89	25-49	\$21.75	50-99	\$20.60	100+	\$19.69	 <table border="1"> <thead> <tr><th colspan="2">PRICE</th></tr> </thead> <tbody> <tr><td>1-24</td><td>\$13.65</td></tr> <tr><td>25-49</td><td>\$12.97</td></tr> <tr><td>50-99</td><td>\$12.29</td></tr> <tr><td>100+</td><td>\$11.74</td></tr> </tbody> </table> <p>TNC Male to FME Plug Right Angle</p> <p>Model No: <a href="#">PE9700</a></p>	PRICE		1-24	\$13.65	25-49	\$12.97	50-99	\$12.29	100+	\$11.74
	PRICE																																																						
1-24	\$22.42																																																						
25-49	\$21.30																																																						
50-99	\$20.18																																																						
100+	\$19.28																																																						
PRICE																																																							
1-24	\$74.10																																																						
25-49	\$70.40																																																						
50-99	\$66.69																																																						
100+	\$63.73																																																						
PRICE																																																							
1-24	\$125.37																																																						
25-49	\$119.10																																																						
50-99	\$112.83																																																						
100+	\$107.82																																																						
PRICE																																																							
1-24	\$22.89																																																						
25-49	\$21.75																																																						
50-99	\$20.60																																																						
100+	\$19.69																																																						
PRICE																																																							
1-24	\$13.65																																																						
25-49	\$12.97																																																						
50-99	\$12.29																																																						
100+	\$11.74																																																						
2	 <table border="1"> <thead> <tr><th colspan="2">PRICE</th></tr> </thead> <tbody> <tr><td>1-24</td><td>\$20.08</td></tr> <tr><td>25-49</td><td>\$19.08</td></tr> <tr><td>50-99</td><td>\$18.07</td></tr> <tr><td>100+</td><td>\$17.27</td></tr> </tbody> </table> <p>TNC Male to FME Jack</p> <p>Model No: <a href="#">PE9713</a></p>	PRICE		1-24	\$20.08	25-49	\$19.08	50-99	\$18.07	100+	\$17.27	 <table border="1"> <thead> <tr><th colspan="2">PRICE</th></tr> </thead> <tbody> <tr><td>1-24</td><td>\$96.31</td></tr> <tr><td>25-49</td><td>\$91.49</td></tr> <tr><td>50-99</td><td>\$86.68</td></tr> <tr><td>100+</td><td>\$82.83</td></tr> </tbody> </table> <p>TNC Male to HN Male</p> <p>Model No: <a href="#">PE9563</a></p>	PRICE		1-24	\$96.31	25-49	\$91.49	50-99	\$86.68	100+	\$82.83	 <table border="1"> <thead> <tr><th colspan="2">PRICE</th></tr> </thead> <tbody> <tr><td>1-24</td><td>\$77.10</td></tr> <tr><td>25-49</td><td>\$73.25</td></tr> <tr><td>50-99</td><td>\$69.39</td></tr> <tr><td>100+</td><td>\$66.31</td></tr> </tbody> </table> <p>TNC Male to MCX Plug</p> <p>Model No: <a href="#">PE9543</a></p>	PRICE		1-24	\$77.10	25-49	\$73.25	50-99	\$69.39	100+	\$66.31	 <table border="1"> <thead> <tr><th colspan="2">PRICE</th></tr> </thead> <tbody> <tr><td>1-24</td><td>\$85.34</td></tr> <tr><td>25-49</td><td>\$81.07</td></tr> <tr><td>50-99</td><td>\$76.81</td></tr> <tr><td>100+</td><td>\$73.39</td></tr> </tbody> </table> <p>TNC Male to MCX Jack</p> <p>Model No: <a href="#">PE9542</a></p>	PRICE		1-24	\$85.34	25-49	\$81.07	50-99	\$76.81	100+	\$73.39	 <table border="1"> <thead> <tr><th colspan="2">PRICE</th></tr> </thead> <tbody> <tr><td>1-24</td><td>\$25.12</td></tr> <tr><td>25-49</td><td>\$23.86</td></tr> <tr><td>50-99</td><td>\$22.61</td></tr> <tr><td>100+</td><td>\$21.60</td></tr> </tbody> </table> <p>TNC Male to Mini UHF Female</p> <p>Model No: <a href="#">PE9345</a></p>	PRICE		1-24	\$25.12	25-49	\$23.86	50-99	\$22.61	100+	\$21.60
	PRICE																																																						
1-24	\$20.08																																																						
25-49	\$19.08																																																						
50-99	\$18.07																																																						
100+	\$17.27																																																						
PRICE																																																							
1-24	\$96.31																																																						
25-49	\$91.49																																																						
50-99	\$86.68																																																						
100+	\$82.83																																																						
PRICE																																																							
1-24	\$77.10																																																						
25-49	\$73.25																																																						
50-99	\$69.39																																																						
100+	\$66.31																																																						
PRICE																																																							
1-24	\$85.34																																																						
25-49	\$81.07																																																						
50-99	\$76.81																																																						
100+	\$73.39																																																						
PRICE																																																							
1-24	\$25.12																																																						
25-49	\$23.86																																																						
50-99	\$22.61																																																						
100+	\$21.60																																																						
3	 <table border="1"> <thead> <tr><th colspan="2">PRICE</th></tr> </thead> <tbody> <tr><td>1-24</td><td>\$71.43</td></tr> <tr><td>25-49</td><td>\$67.86</td></tr> <tr><td>50-99</td><td>\$64.29</td></tr> <tr><td>100+</td><td>\$61.43</td></tr> </tbody> </table> <p>TNC Male to SMC Jack</p> <p>Model No: <a href="#">PE9226</a></p>	PRICE		1-24	\$71.43	25-49	\$67.86	50-99	\$64.29	100+	\$61.43	 <table border="1"> <thead> <tr><th colspan="2">PRICE</th></tr> </thead> <tbody> <tr><td>1-24</td><td>\$30.51</td></tr> <tr><td>25-49</td><td>\$28.98</td></tr> <tr><td>50-99</td><td>\$27.46</td></tr> <tr><td>100+</td><td>\$26.24</td></tr> </tbody> </table> <p>TNC Male to UHF Female Max. Freq. 300 MHz</p> <p>Model No: <a href="#">PE9291</a></p>	PRICE		1-24	\$30.51	25-49	\$28.98	50-99	\$27.46	100+	\$26.24	 <table border="1"> <thead> <tr><th colspan="2">PRICE</th></tr> </thead> <tbody> <tr><td>1-9</td><td>\$616.14</td></tr> <tr><td>10-24</td><td>\$585.33</td></tr> <tr><td>25-49</td><td>\$554.53</td></tr> <tr><td>50+</td><td>\$529.88</td></tr> </tbody> </table> <p>PRECISION TNC Female to 7mm Sexless VSWR 1.15:1 to 18 GHz</p> <p>Model No: <a href="#">PE9218</a></p>	PRICE		1-9	\$616.14	10-24	\$585.33	25-49	\$554.53	50+	\$529.88	 <table border="1"> <thead> <tr><th colspan="2">PRICE</th></tr> </thead> <tbody> <tr><td>1-9</td><td>\$290.86</td></tr> <tr><td>10-24</td><td>\$276.32</td></tr> <tr><td>25-49</td><td>\$261.77</td></tr> <tr><td>50+</td><td>\$250.14</td></tr> </tbody> </table> <p>TNC Female to 7/16 DIN Female Max. Freq. 7.5 GHz</p> <p>Model No: <a href="#">PE91392</a></p>	PRICE		1-9	\$290.86	10-24	\$276.32	25-49	\$261.77	50+	\$250.14	 <table border="1"> <thead> <tr><th colspan="2">PRICE</th></tr> </thead> <tbody> <tr><td>1-24</td><td>\$32.18</td></tr> <tr><td>25-49</td><td>\$30.57</td></tr> <tr><td>50-99</td><td>\$28.96</td></tr> <tr><td>100+</td><td>\$27.67</td></tr> </tbody> </table> <p>TNC Female to BNC Male VSWR 1.3:1 to 4 GHz</p> <p>Model No: <a href="#">PE9098</a></p>	PRICE		1-24	\$32.18	25-49	\$30.57	50-99	\$28.96	100+	\$27.67
	PRICE																																																						
1-24	\$71.43																																																						
25-49	\$67.86																																																						
50-99	\$64.29																																																						
100+	\$61.43																																																						
PRICE																																																							
1-24	\$30.51																																																						
25-49	\$28.98																																																						
50-99	\$27.46																																																						
100+	\$26.24																																																						
PRICE																																																							
1-9	\$616.14																																																						
10-24	\$585.33																																																						
25-49	\$554.53																																																						
50+	\$529.88																																																						
PRICE																																																							
1-9	\$290.86																																																						
10-24	\$276.32																																																						
25-49	\$261.77																																																						
50+	\$250.14																																																						
PRICE																																																							
1-24	\$32.18																																																						
25-49	\$30.57																																																						
50-99	\$28.96																																																						
100+	\$27.67																																																						
4	 <table border="1"> <thead> <tr><th colspan="2">PRICE</th></tr> </thead> <tbody> <tr><td>1-24</td><td>\$43.04</td></tr> <tr><td>25-49</td><td>\$40.89</td></tr> <tr><td>50-99</td><td>\$38.74</td></tr> <tr><td>100+</td><td>\$37.01</td></tr> </tbody> </table> <p>TNC Female to BNC Female VSWR 1.3:1 to 4 GHz</p> <p>Model No: <a href="#">PE9097</a></p>	PRICE		1-24	\$43.04	25-49	\$40.89	50-99	\$38.74	100+	\$37.01	 <table border="1"> <thead> <tr><th colspan="2">PRICE</th></tr> </thead> <tbody> <tr><td>1-9</td><td>\$145.85</td></tr> <tr><td>10-24</td><td>\$138.56</td></tr> <tr><td>25-49</td><td>\$131.27</td></tr> <tr><td>50+</td><td>\$125.43</td></tr> </tbody> </table> <p>TNC Female to C Male Max. Freq. 11 GHz</p> <p>Model No: <a href="#">PE9564</a></p>	PRICE		1-9	\$145.85	10-24	\$138.56	25-49	\$131.27	50+	\$125.43	 <table border="1"> <thead> <tr><th colspan="2">PRICE</th></tr> </thead> <tbody> <tr><td>1-24</td><td>\$6.21</td></tr> <tr><td>25-49</td><td>\$5.90</td></tr> <tr><td>50-99</td><td>\$5.59</td></tr> <tr><td>100+</td><td>\$5.34</td></tr> </tbody> </table> <p>TNC Female to FME Jack</p> <p>Model No: <a href="#">PE9714</a></p>	PRICE		1-24	\$6.21	25-49	\$5.90	50-99	\$5.59	100+	\$5.34	 <table border="1"> <thead> <tr><th colspan="2">PRICE</th></tr> </thead> <tbody> <tr><td>1-24</td><td>\$84.09</td></tr> <tr><td>25-49</td><td>\$79.89</td></tr> <tr><td>50-99</td><td>\$75.68</td></tr> <tr><td>100+</td><td>\$72.32</td></tr> </tbody> </table> <p>TNC Female to MCX Plug</p> <p>Model No: <a href="#">PE9545</a></p>	PRICE		1-24	\$84.09	25-49	\$79.89	50-99	\$75.68	100+	\$72.32	 <table border="1"> <thead> <tr><th colspan="2">PRICE</th></tr> </thead> <tbody> <tr><td>1-24</td><td>\$88.98</td></tr> <tr><td>25-49</td><td>\$84.53</td></tr> <tr><td>50-99</td><td>\$80.08</td></tr> <tr><td>100+</td><td>\$76.52</td></tr> </tbody> </table> <p>TNC Female to MCX Jack</p> <p>Model No: <a href="#">PE9544</a></p>	PRICE		1-24	\$88.98	25-49	\$84.53	50-99	\$80.08	100+	\$76.52
	PRICE																																																						
1-24	\$43.04																																																						
25-49	\$40.89																																																						
50-99	\$38.74																																																						
100+	\$37.01																																																						
PRICE																																																							
1-9	\$145.85																																																						
10-24	\$138.56																																																						
25-49	\$131.27																																																						
50+	\$125.43																																																						
PRICE																																																							
1-24	\$6.21																																																						
25-49	\$5.90																																																						
50-99	\$5.59																																																						
100+	\$5.34																																																						
PRICE																																																							
1-24	\$84.09																																																						
25-49	\$79.89																																																						
50-99	\$75.68																																																						
100+	\$72.32																																																						
PRICE																																																							
1-24	\$88.98																																																						
25-49	\$84.53																																																						
50-99	\$80.08																																																						
100+	\$76.52																																																						
5	 <table border="1"> <thead> <tr><th colspan="2">PRICE</th></tr> </thead> <tbody> <tr><td>1-24</td><td>\$103.19</td></tr> <tr><td>25-49</td><td>\$98.03</td></tr> <tr><td>50-99</td><td>\$92.87</td></tr> <tr><td>100+</td><td>\$88.74</td></tr> </tbody> </table> <p>TNC Female to MCX Jack Bulkhead-Mounting Hole B04</p> <p>Model No: <a href="#">PE9521</a></p>	PRICE		1-24	\$103.19	25-49	\$98.03	50-99	\$92.87	100+	\$88.74	 <table border="1"> <thead> <tr><th colspan="2">PRICE</th></tr> </thead> <tbody> <tr><td>1-24</td><td>\$22.79</td></tr> <tr><td>25-49</td><td>\$21.65</td></tr> <tr><td>50-99</td><td>\$20.51</td></tr> <tr><td>100+</td><td>\$19.60</td></tr> </tbody> </table> <p>TNC Female to Mini UHF Male Max. Freq. 2.5 GHz</p> <p>Model No: <a href="#">PE9346</a></p>	PRICE		1-24	\$22.79	25-49	\$21.65	50-99	\$20.51	100+	\$19.60	 <table border="1"> <thead> <tr><th colspan="2">PRICE</th></tr> </thead> <tbody> <tr><td>1-9</td><td>\$229.36</td></tr> <tr><td>10-24</td><td>\$217.89</td></tr> <tr><td>25-49</td><td>\$206.42</td></tr> <tr><td>50+</td><td>\$197.25</td></tr> </tbody> </table> <p>TNC Female to Limited Detent SMP Male Bulkhead VSWR 1.3:1 to 8 GHz</p> <p>Model No: <a href="#">PE91073</a></p>	PRICE		1-9	\$229.36	10-24	\$217.89	25-49	\$206.42	50+	\$197.25	 <table border="1"> <thead> <tr><th colspan="2">PRICE</th></tr> </thead> <tbody> <tr><td>1-24</td><td>\$39.94</td></tr> <tr><td>25-49</td><td>\$37.94</td></tr> <tr><td>50-99</td><td>\$35.95</td></tr> <tr><td>100+</td><td>\$34.35</td></tr> </tbody> </table> <p>TNC Female to UHF Male VSWR 1.3:1 to 300 MHz</p> <p>Model No: <a href="#">PE9372</a></p>	PRICE		1-24	\$39.94	25-49	\$37.94	50-99	\$35.95	100+	\$34.35	<p><b>Reverse Polarity TNC Between Series</b></p> <p>→</p>										
	PRICE																																																						
1-24	\$103.19																																																						
25-49	\$98.03																																																						
50-99	\$92.87																																																						
100+	\$88.74																																																						
PRICE																																																							
1-24	\$22.79																																																						
25-49	\$21.65																																																						
50-99	\$20.51																																																						
100+	\$19.60																																																						
PRICE																																																							
1-9	\$229.36																																																						
10-24	\$217.89																																																						
25-49	\$206.42																																																						
50+	\$197.25																																																						
PRICE																																																							
1-24	\$39.94																																																						
25-49	\$37.94																																																						
50-99	\$35.95																																																						
100+	\$34.35																																																						
6	 <table border="1"> <thead> <tr><th colspan="2">PRICE</th></tr> </thead> <tbody> <tr><td>1-24</td><td>\$39.47</td></tr> <tr><td>25-49</td><td>\$37.50</td></tr> <tr><td>50-99</td><td>\$35.52</td></tr> <tr><td>100+</td><td>\$33.94</td></tr> </tbody> </table> <p>Rev. Pol. TNC Female to BNC Male Max. Freq. 4 GHz</p> <p>Model No: <a href="#">PE91087</a></p>	PRICE		1-24	\$39.47	25-49	\$37.50	50-99	\$35.52	100+	\$33.94	<p><b>UHF In-Series</b></p> <p>→</p>	 <table border="1"> <thead> <tr><th colspan="2">PRICE</th></tr> </thead> <tbody> <tr><td>1-24</td><td>\$22.85</td></tr> <tr><td>25-49</td><td>\$21.71</td></tr> <tr><td>50-99</td><td>\$20.57</td></tr> <tr><td>100+</td><td>\$19.65</td></tr> </tbody> </table> <p>UHF Male to UHF Male VSWR 1.3:1 to 300 MHz</p> <p>Model No: <a href="#">PE91487</a></p>	PRICE		1-24	\$22.85	25-49	\$21.71	50-99	\$20.57	100+	\$19.65	 <table border="1"> <thead> <tr><th colspan="2">PRICE</th></tr> </thead> <tbody> <tr><td>1-24</td><td>\$34.30</td></tr> <tr><td>25-49</td><td>\$32.59</td></tr> <tr><td>50-99</td><td>\$30.87</td></tr> <tr><td>100+</td><td>\$29.50</td></tr> </tbody> </table> <p>UHF Male to UHF Female Right Angle Max. Freq. 300 MHz</p> <p>Model No: <a href="#">PE9209</a></p>	PRICE		1-24	\$34.30	25-49	\$32.59	50-99	\$30.87	100+	\$29.50	 <table border="1"> <thead> <tr><th colspan="2">PRICE</th></tr> </thead> <tbody> <tr><td>1-24</td><td>\$28.57</td></tr> <tr><td>25-49</td><td>\$27.14</td></tr> <tr><td>50-99</td><td>\$25.71</td></tr> <tr><td>100+</td><td>\$24.57</td></tr> </tbody> </table> <p>UHF Female to UHF Male Tee</p> <p>Model No: <a href="#">PE9095</a></p>	PRICE		1-24	\$28.57	25-49	\$27.14	50-99	\$25.71	100+	\$24.57										
	PRICE																																																						
1-24	\$39.47																																																						
25-49	\$37.50																																																						
50-99	\$35.52																																																						
100+	\$33.94																																																						
PRICE																																																							
1-24	\$22.85																																																						
25-49	\$21.71																																																						
50-99	\$20.57																																																						
100+	\$19.65																																																						
PRICE																																																							
1-24	\$34.30																																																						
25-49	\$32.59																																																						
50-99	\$30.87																																																						
100+	\$29.50																																																						
PRICE																																																							
1-24	\$28.57																																																						
25-49	\$27.14																																																						
50-99	\$25.71																																																						
100+	\$24.57																																																						
7	 <table border="1"> <thead> <tr><th colspan="2">PRICE</th></tr> </thead> <tbody> <tr><td>1-24</td><td>\$20.72</td></tr> <tr><td>25-49</td><td>\$19.68</td></tr> <tr><td>50-99</td><td>\$18.65</td></tr> <tr><td>100+</td><td>\$17.82</td></tr> </tbody> </table> <p>UHF Female to UHF Female VSWR 1.3:1 to 300 MHz</p> <p>Model No: <a href="#">PE9094</a></p>	PRICE		1-24	\$20.72	25-49	\$19.68	50-99	\$18.65	100+	\$17.82	<p><b>UHF Between Series</b></p> <p>→</p>	 <table border="1"> <thead> <tr><th colspan="2">PRICE</th></tr> </thead> <tbody> <tr><td>1-24</td><td>\$52.55</td></tr> <tr><td>25-49</td><td>\$49.92</td></tr> <tr><td>50-99</td><td>\$47.30</td></tr> <tr><td>100+</td><td>\$45.19</td></tr> </tbody> </table> <p>UHF Female to UHF Female Bulkhead-Mounting Hole F03 Max. Freq. 300 MHz</p> <p>Model No: <a href="#">PE9114</a></p>	PRICE		1-24	\$52.55	25-49	\$49.92	50-99	\$47.30	100+	\$45.19	 <table border="1"> <thead> <tr><th colspan="2">PRICE</th></tr> </thead> <tbody> <tr><td>1-24</td><td>\$30.95</td></tr> <tr><td>25-49</td><td>\$29.40</td></tr> <tr><td>50-99</td><td>\$27.86</td></tr> <tr><td>100+</td><td>\$26.62</td></tr> </tbody> </table> <p>UHF Male to BNC Male</p> <p>Model No: <a href="#">PE9201</a></p>	PRICE		1-24	\$30.95	25-49	\$29.40	50-99	\$27.86	100+	\$26.62	 <table border="1"> <thead> <tr><th colspan="2">PRICE</th></tr> </thead> <tbody> <tr><td>1-24</td><td>\$15.61</td></tr> <tr><td>25-49</td><td>\$14.83</td></tr> <tr><td>50-99</td><td>\$14.05</td></tr> <tr><td>100+</td><td>\$13.42</td></tr> </tbody> </table> <p>UHF Male to BNC Female VSWR 1.3:1 to 300 MHz</p> <p>Model No: <a href="#">PE91328</a></p>	PRICE		1-24	\$15.61	25-49	\$14.83	50-99	\$14.05	100+	\$13.42										
	PRICE																																																						
1-24	\$20.72																																																						
25-49	\$19.68																																																						
50-99	\$18.65																																																						
100+	\$17.82																																																						
PRICE																																																							
1-24	\$52.55																																																						
25-49	\$49.92																																																						
50-99	\$47.30																																																						
100+	\$45.19																																																						
PRICE																																																							
1-24	\$30.95																																																						
25-49	\$29.40																																																						
50-99	\$27.86																																																						
100+	\$26.62																																																						
PRICE																																																							
1-24	\$15.61																																																						
25-49	\$14.83																																																						
50-99	\$14.05																																																						
100+	\$13.42																																																						

# ADAPTERS

See Adapter Locator on Pages 10-15  
See Page 409 for Mounting Holes

	A	B	C	D	E																																																		
1	 <table border="1"> <thead> <tr> <th colspan="2">PRICE</th> </tr> </thead> <tbody> <tr> <td>1-24</td> <td>\$40.55</td> </tr> <tr> <td>25-49</td> <td>\$38.52</td> </tr> <tr> <td>50-99</td> <td>\$36.50</td> </tr> <tr> <td>100+</td> <td>\$34.87</td> </tr> </tbody> </table> <p>UHF Male to 75 Ohm F Female</p> <p>Model No: <a href="#">PE9165</a></p>	PRICE		1-24	\$40.55	25-49	\$38.52	50-99	\$36.50	100+	\$34.87	 <table border="1"> <thead> <tr> <th colspan="2">PRICE</th> </tr> </thead> <tbody> <tr> <td>1-24</td> <td>\$22.21</td> </tr> <tr> <td>25-49</td> <td>\$21.10</td> </tr> <tr> <td>50-99</td> <td>\$19.99</td> </tr> <tr> <td>100+</td> <td>\$19.10</td> </tr> </tbody> </table> <p>UHF Male to FME Plug</p> <p>Model No: <a href="#">PE9701</a></p>	PRICE		1-24	\$22.21	25-49	\$21.10	50-99	\$19.99	100+	\$19.10	 <table border="1"> <thead> <tr> <th colspan="2">PRICE</th> </tr> </thead> <tbody> <tr> <td>1-24</td> <td>\$23.21</td> </tr> <tr> <td>25-49</td> <td>\$22.05</td> </tr> <tr> <td>50-99</td> <td>\$20.89</td> </tr> <tr> <td>100+</td> <td>\$19.96</td> </tr> </tbody> </table> <p>UHF Male to Mini UHF Female</p> <p>Model No: <a href="#">PE9348</a></p>	PRICE		1-24	\$23.21	25-49	\$22.05	50-99	\$20.89	100+	\$19.96	 <table border="1"> <thead> <tr> <th colspan="2">PRICE</th> </tr> </thead> <tbody> <tr> <td>1-24</td> <td>\$18.91</td> </tr> <tr> <td>25-49</td> <td>\$17.96</td> </tr> <tr> <td>50-99</td> <td>\$17.02</td> </tr> <tr> <td>100+</td> <td>\$16.26</td> </tr> </tbody> </table> <p>UHF Female to BNC Male</p> <p>VSWR 1.3:1 to 300 MHz</p> <p>Model No: <a href="#">PE91329</a></p>	PRICE		1-24	\$18.91	25-49	\$17.96	50-99	\$17.02	100+	\$16.26	 <table border="1"> <thead> <tr> <th colspan="2">PRICE</th> </tr> </thead> <tbody> <tr> <td>1-24</td> <td>\$28.57</td> </tr> <tr> <td>25-49</td> <td>\$27.14</td> </tr> <tr> <td>50-99</td> <td>\$25.71</td> </tr> <tr> <td>100+</td> <td>\$24.57</td> </tr> </tbody> </table> <p>UHF Female to BNC Female</p> <p>Model No: <a href="#">PE9421</a></p>	PRICE		1-24	\$28.57	25-49	\$27.14	50-99	\$25.71	100+	\$24.57
	PRICE																																																						
1-24	\$40.55																																																						
25-49	\$38.52																																																						
50-99	\$36.50																																																						
100+	\$34.87																																																						
PRICE																																																							
1-24	\$22.21																																																						
25-49	\$21.10																																																						
50-99	\$19.99																																																						
100+	\$19.10																																																						
PRICE																																																							
1-24	\$23.21																																																						
25-49	\$22.05																																																						
50-99	\$20.89																																																						
100+	\$19.96																																																						
PRICE																																																							
1-24	\$18.91																																																						
25-49	\$17.96																																																						
50-99	\$17.02																																																						
100+	\$16.26																																																						
PRICE																																																							
1-24	\$28.57																																																						
25-49	\$27.14																																																						
50-99	\$25.71																																																						
100+	\$24.57																																																						
2	 <table border="1"> <thead> <tr> <th colspan="2">PRICE</th> </tr> </thead> <tbody> <tr> <td>1-24</td> <td>\$36.65</td> </tr> <tr> <td>25-49</td> <td>\$34.82</td> </tr> <tr> <td>50-99</td> <td>\$32.99</td> </tr> <tr> <td>100+</td> <td>\$31.52</td> </tr> </tbody> </table> <p>UHF Female to 75 Ohm F Female</p> <p>Model No: <a href="#">PE9167</a></p>	PRICE		1-24	\$36.65	25-49	\$34.82	50-99	\$32.99	100+	\$31.52	 <table border="1"> <thead> <tr> <th colspan="2">PRICE</th> </tr> </thead> <tbody> <tr> <td>1-24</td> <td>\$17.11</td> </tr> <tr> <td>25-49</td> <td>\$16.25</td> </tr> <tr> <td>50-99</td> <td>\$15.40</td> </tr> <tr> <td>100+</td> <td>\$14.71</td> </tr> </tbody> </table> <p>UHF Female to Mini UHF Male</p> <p>VSWR 1.3:1 to 300 MHz</p> <p>Model No: <a href="#">PE91447</a></p>	PRICE		1-24	\$17.11	25-49	\$16.25	50-99	\$15.40	100+	\$14.71	<p><b>75 Ohm BNC In-Series</b></p> <p>→</p>		 <table border="1"> <thead> <tr> <th colspan="2">PRICE</th> </tr> </thead> <tbody> <tr> <td>1-24</td> <td>\$31.42</td> </tr> <tr> <td>25-49</td> <td>\$29.85</td> </tr> <tr> <td>50-99</td> <td>\$28.28</td> </tr> <tr> <td>100+</td> <td>\$27.02</td> </tr> </tbody> </table> <p>75 Ohm BNC Male to 75 Ohm BNC Male</p> <p>VSWR 1.5:1 to 300 MHz</p> <p>Model No: <a href="#">PE9364</a></p>	PRICE		1-24	\$31.42	25-49	\$29.85	50-99	\$28.28	100+	\$27.02	 <table border="1"> <thead> <tr> <th colspan="2">PRICE</th> </tr> </thead> <tbody> <tr> <td>1-24</td> <td>\$44.73</td> </tr> <tr> <td>25-49</td> <td>\$42.49</td> </tr> <tr> <td>50-99</td> <td>\$40.26</td> </tr> <tr> <td>100+</td> <td>\$38.47</td> </tr> </tbody> </table> <p>75 Ohm BNC Male to 75 Ohm BNC Female Right Angle</p> <p>Max. Freq. 4 GHz</p> <p>Model No: <a href="#">PE9361</a></p>	PRICE		1-24	\$44.73	25-49	\$42.49	50-99	\$40.26	100+	\$38.47									
	PRICE																																																						
1-24	\$36.65																																																						
25-49	\$34.82																																																						
50-99	\$32.99																																																						
100+	\$31.52																																																						
PRICE																																																							
1-24	\$17.11																																																						
25-49	\$16.25																																																						
50-99	\$15.40																																																						
100+	\$14.71																																																						
PRICE																																																							
1-24	\$31.42																																																						
25-49	\$29.85																																																						
50-99	\$28.28																																																						
100+	\$27.02																																																						
PRICE																																																							
1-24	\$44.73																																																						
25-49	\$42.49																																																						
50-99	\$40.26																																																						
100+	\$38.47																																																						
3	 <table border="1"> <thead> <tr> <th colspan="2">PRICE</th> </tr> </thead> <tbody> <tr> <td>1-24</td> <td>\$54.48</td> </tr> <tr> <td>25-49</td> <td>\$51.76</td> </tr> <tr> <td>50-99</td> <td>\$49.03</td> </tr> <tr> <td>100+</td> <td>\$46.85</td> </tr> </tbody> </table> <p>75 Ohm BNC Female to 75 Ohm BNC Male Tee</p> <p>Max. Freq. 100 MHz</p> <p>Model No: <a href="#">PE9365</a></p>	PRICE		1-24	\$54.48	25-49	\$51.76	50-99	\$49.03	100+	\$46.85	 <table border="1"> <thead> <tr> <th colspan="2">PRICE</th> </tr> </thead> <tbody> <tr> <td>1-24</td> <td>\$31.54</td> </tr> <tr> <td>25-49</td> <td>\$29.96</td> </tr> <tr> <td>50-99</td> <td>\$28.39</td> </tr> <tr> <td>100+</td> <td>\$27.12</td> </tr> </tbody> </table> <p>75 Ohm BNC Female to 75 Ohm BNC Female</p> <p>VSWR 1.3:1 to 1,000 MHz</p> <p>Model No: <a href="#">PE9362</a></p>	PRICE		1-24	\$31.54	25-49	\$29.96	50-99	\$28.39	100+	\$27.12	 <table border="1"> <thead> <tr> <th colspan="2">PRICE</th> </tr> </thead> <tbody> <tr> <td>1-24</td> <td>\$43.64</td> </tr> <tr> <td>25-49</td> <td>\$41.46</td> </tr> <tr> <td>50-99</td> <td>\$39.28</td> </tr> <tr> <td>100+</td> <td>\$37.53</td> </tr> </tbody> </table> <p>75 Ohm BNC Female to 75 Ohm BNC Female Bulkhead</p> <p>VSWR 1.3:1 to 1,000 MHz</p> <p>Model No: <a href="#">PE9363</a></p>	PRICE		1-24	\$43.64	25-49	\$41.46	50-99	\$39.28	100+	\$37.53	 <table border="1"> <thead> <tr> <th colspan="2">PRICE</th> </tr> </thead> <tbody> <tr> <td>1-24</td> <td>\$47.99</td> </tr> <tr> <td>25-49</td> <td>\$45.59</td> </tr> <tr> <td>50-99</td> <td>\$43.19</td> </tr> <tr> <td>100+</td> <td>\$41.27</td> </tr> </tbody> </table> <p>75 Ohm BNC Female to 75 Ohm BNC Female 4 Hole Flange-Mounting Hole A03</p> <p>Max. Freq. 1,000 MHz</p> <p>Model No: <a href="#">PE9367</a></p>	PRICE		1-24	\$47.99	25-49	\$45.59	50-99	\$43.19	100+	\$41.27	 <table border="1"> <thead> <tr> <th colspan="2">PRICE</th> </tr> </thead> <tbody> <tr> <td>1-24</td> <td>\$13.28</td> </tr> <tr> <td>25-49</td> <td>\$12.62</td> </tr> <tr> <td>50-99</td> <td>\$11.95</td> </tr> <tr> <td>100+</td> <td>\$11.42</td> </tr> </tbody> </table> <p>75 Ohm BNC Female to 75 Ohm BNC Female Bulkhead</p> <p>VSWR 1.5:1 to 500 MHz</p> <p>Model No: <a href="#">PE9791</a></p>	PRICE		1-24	\$13.28	25-49	\$12.62	50-99	\$11.95	100+	\$11.42
	PRICE																																																						
1-24	\$54.48																																																						
25-49	\$51.76																																																						
50-99	\$49.03																																																						
100+	\$46.85																																																						
PRICE																																																							
1-24	\$31.54																																																						
25-49	\$29.96																																																						
50-99	\$28.39																																																						
100+	\$27.12																																																						
PRICE																																																							
1-24	\$43.64																																																						
25-49	\$41.46																																																						
50-99	\$39.28																																																						
100+	\$37.53																																																						
PRICE																																																							
1-24	\$47.99																																																						
25-49	\$45.59																																																						
50-99	\$43.19																																																						
100+	\$41.27																																																						
PRICE																																																							
1-24	\$13.28																																																						
25-49	\$12.62																																																						
50-99	\$11.95																																																						
100+	\$11.42																																																						
4	<p><b>75 Ohm BNC Between Series</b></p> <p>→</p>		 <table border="1"> <thead> <tr> <th colspan="2">PRICE</th> </tr> </thead> <tbody> <tr> <td>1-24</td> <td>\$27.58</td> </tr> <tr> <td>25-49</td> <td>\$26.20</td> </tr> <tr> <td>50-99</td> <td>\$24.82</td> </tr> <tr> <td>100+</td> <td>\$23.72</td> </tr> </tbody> </table> <p>75 Ohm BNC Female to 75 Ohm F Female Bulkhead</p> <p>VSWR 1.3:1 to 1,000 MHz</p> <p>Model No: <a href="#">PE91324</a></p>	PRICE		1-24	\$27.58	25-49	\$26.20	50-99	\$24.82	100+	\$23.72	<p><b>75 Ohm F In-Series</b></p> <p>→</p>		 <table border="1"> <thead> <tr> <th colspan="2">PRICE</th> </tr> </thead> <tbody> <tr> <td>1-24</td> <td>\$45.23</td> </tr> <tr> <td>25-49</td> <td>\$42.97</td> </tr> <tr> <td>50-99</td> <td>\$40.71</td> </tr> <tr> <td>100+</td> <td>\$38.90</td> </tr> </tbody> </table> <p>PRECISION 75 Ohm F Male to 75 Ohm F Male</p> <p>VSWR 1.17:1 to 3 GHz</p> <p>Model No: <a href="#">PE91348</a></p>	PRICE		1-24	\$45.23	25-49	\$42.97	50-99	\$40.71	100+	\$38.90	 <table border="1"> <thead> <tr> <th colspan="2">PRICE</th> </tr> </thead> <tbody> <tr> <td>1-24</td> <td>\$112.48</td> </tr> <tr> <td>25-49</td> <td>\$106.86</td> </tr> <tr> <td>50-99</td> <td>\$101.23</td> </tr> <tr> <td>100+</td> <td>\$96.73</td> </tr> </tbody> </table> <p>75 Ohm F Male to 75 Ohm F Male</p> <p>VSWR 1.3:1 to 3 GHz</p> <p>Model No: <a href="#">PE9760</a></p>	PRICE		1-24	\$112.48	25-49	\$106.86	50-99	\$101.23	100+	\$96.73																		
	PRICE																																																						
1-24	\$27.58																																																						
25-49	\$26.20																																																						
50-99	\$24.82																																																						
100+	\$23.72																																																						
PRICE																																																							
1-24	\$45.23																																																						
25-49	\$42.97																																																						
50-99	\$40.71																																																						
100+	\$38.90																																																						
PRICE																																																							
1-24	\$112.48																																																						
25-49	\$106.86																																																						
50-99	\$101.23																																																						
100+	\$96.73																																																						
5	 <table border="1"> <thead> <tr> <th colspan="2">PRICE</th> </tr> </thead> <tbody> <tr> <td>1-24</td> <td>\$10.55</td> </tr> <tr> <td>25-49</td> <td>\$10.02</td> </tr> <tr> <td>50-99</td> <td>\$9.50</td> </tr> <tr> <td>100+</td> <td>\$9.07</td> </tr> </tbody> </table> <p>75 Ohm Push-On F Male to 75 Ohm F Female</p> <p>VSWR 1.5:1 to 1,000 MHz</p> <p>Model No: <a href="#">PE9160</a></p>	PRICE		1-24	\$10.55	25-49	\$10.02	50-99	\$9.50	100+	\$9.07	 <table border="1"> <thead> <tr> <th colspan="2">PRICE</th> </tr> </thead> <tbody> <tr> <td>1-24</td> <td>\$110.82</td> </tr> <tr> <td>25-49</td> <td>\$105.28</td> </tr> <tr> <td>50-99</td> <td>\$99.74</td> </tr> <tr> <td>100+</td> <td>\$95.31</td> </tr> </tbody> </table> <p>75 Ohm F Male to 75 Ohm F Female</p> <p>VSWR 1.3:1 to 3 GHz</p> <p>Model No: <a href="#">PE9759</a></p>	PRICE		1-24	\$110.82	25-49	\$105.28	50-99	\$99.74	100+	\$95.31	 <table border="1"> <thead> <tr> <th colspan="2">PRICE</th> </tr> </thead> <tbody> <tr> <td>1-24</td> <td>\$12.29</td> </tr> <tr> <td>25-49</td> <td>\$11.68</td> </tr> <tr> <td>50-99</td> <td>\$11.06</td> </tr> <tr> <td>100+</td> <td>\$10.57</td> </tr> </tbody> </table> <p>75 Ohm F Male to 75 Ohm F Female Right Angle</p> <p>Max. Freq. 1,000 MHz</p> <p>Model No: <a href="#">PE9166</a></p>	PRICE		1-24	\$12.29	25-49	\$11.68	50-99	\$11.06	100+	\$10.57	 <table border="1"> <thead> <tr> <th colspan="2">PRICE</th> </tr> </thead> <tbody> <tr> <td>1-24</td> <td>\$28.26</td> </tr> <tr> <td>25-49</td> <td>\$26.85</td> </tr> <tr> <td>50-99</td> <td>\$25.43</td> </tr> <tr> <td>100+</td> <td>\$24.30</td> </tr> </tbody> </table> <p>PRECISION 75 Ohm F Female to 75 Ohm F Female</p> <p>VSWR 1.28:1 to 3 GHz</p> <p>Model No: <a href="#">PE91349</a></p>	PRICE		1-24	\$28.26	25-49	\$26.85	50-99	\$25.43	100+	\$24.30	 <table border="1"> <thead> <tr> <th colspan="2">PRICE</th> </tr> </thead> <tbody> <tr> <td>1-24</td> <td>\$3.27</td> </tr> <tr> <td>25-49</td> <td>\$3.11</td> </tr> <tr> <td>50-99</td> <td>\$2.94</td> </tr> <tr> <td>100+</td> <td>\$2.81</td> </tr> </tbody> </table> <p>75 Ohm F Female to 75 Ohm F Female</p> <p>VSWR 1.35:1 to 500 MHz</p> <p>Model No: <a href="#">PE9164</a></p>	PRICE		1-24	\$3.27	25-49	\$3.11	50-99	\$2.94	100+	\$2.81
	PRICE																																																						
1-24	\$10.55																																																						
25-49	\$10.02																																																						
50-99	\$9.50																																																						
100+	\$9.07																																																						
PRICE																																																							
1-24	\$110.82																																																						
25-49	\$105.28																																																						
50-99	\$99.74																																																						
100+	\$95.31																																																						
PRICE																																																							
1-24	\$12.29																																																						
25-49	\$11.68																																																						
50-99	\$11.06																																																						
100+	\$10.57																																																						
PRICE																																																							
1-24	\$28.26																																																						
25-49	\$26.85																																																						
50-99	\$25.43																																																						
100+	\$24.30																																																						
PRICE																																																							
1-24	\$3.27																																																						
25-49	\$3.11																																																						
50-99	\$2.94																																																						
100+	\$2.81																																																						
6	 <table border="1"> <thead> <tr> <th colspan="2">PRICE</th> </tr> </thead> <tbody> <tr> <td>1-24</td> <td>\$9.76</td> </tr> <tr> <td>25-49</td> <td>\$9.27</td> </tr> <tr> <td>50-99</td> <td>\$8.78</td> </tr> <tr> <td>100+</td> <td>\$8.39</td> </tr> </tbody> </table> <p>75 Ohm F Female to 75 Ohm F Female Bulkhead-Mounting Hole B04</p> <p>VSWR 1.3:1 to 250 MHz</p> <p>Model No: <a href="#">PE9734</a></p>	PRICE		1-24	\$9.76	25-49	\$9.27	50-99	\$8.78	100+	\$8.39	<p><b>75 Ohm F Between Series</b></p> <p>→</p>		 <table border="1"> <thead> <tr> <th colspan="2">PRICE</th> </tr> </thead> <tbody> <tr> <td>1-9</td> <td>\$138.58</td> </tr> <tr> <td>10-24</td> <td>\$131.65</td> </tr> <tr> <td>25-49</td> <td>\$124.72</td> </tr> <tr> <td>50+</td> <td>\$119.18</td> </tr> </tbody> </table> <p>75 Ohm F Male to 75 Ohm BNC Male</p> <p>VSWR 1.3:1 to 3 GHz</p> <p>Model No: <a href="#">PE9742</a></p>	PRICE		1-9	\$138.58	10-24	\$131.65	25-49	\$124.72	50+	\$119.18	 <table border="1"> <thead> <tr> <th colspan="2">PRICE</th> </tr> </thead> <tbody> <tr> <td>1-9</td> <td>\$147.44</td> </tr> <tr> <td>10-24</td> <td>\$140.07</td> </tr> <tr> <td>25-49</td> <td>\$132.70</td> </tr> <tr> <td>50+</td> <td>\$126.80</td> </tr> </tbody> </table> <p>75 Ohm F Male to 75 Ohm BNC Female</p> <p>VSWR 1.3:1 to 3 GHz</p> <p>Model No: <a href="#">PE9743</a></p>	PRICE		1-9	\$147.44	10-24	\$140.07	25-49	\$132.70	50+	\$126.80	 <table border="1"> <thead> <tr> <th colspan="2">PRICE</th> </tr> </thead> <tbody> <tr> <td>1-24</td> <td>\$21.12</td> </tr> <tr> <td>25-49</td> <td>\$20.06</td> </tr> <tr> <td>50-99</td> <td>\$19.01</td> </tr> <tr> <td>100+</td> <td>\$18.16</td> </tr> </tbody> </table> <p>75 Ohm F Male to 75 Ohm PAL Plug</p> <p>Model No: <a href="#">PE9633</a></p>	PRICE		1-24	\$21.12	25-49	\$20.06	50-99	\$19.01	100+	\$18.16									
	PRICE																																																						
1-24	\$9.76																																																						
25-49	\$9.27																																																						
50-99	\$8.78																																																						
100+	\$8.39																																																						
PRICE																																																							
1-9	\$138.58																																																						
10-24	\$131.65																																																						
25-49	\$124.72																																																						
50+	\$119.18																																																						
PRICE																																																							
1-9	\$147.44																																																						
10-24	\$140.07																																																						
25-49	\$132.70																																																						
50+	\$126.80																																																						
PRICE																																																							
1-24	\$21.12																																																						
25-49	\$20.06																																																						
50-99	\$19.01																																																						
100+	\$18.16																																																						
7	 <table border="1"> <thead> <tr> <th colspan="2">PRICE</th> </tr> </thead> <tbody> <tr> <td>1-24</td> <td>\$21.12</td> </tr> <tr> <td>25-49</td> <td>\$20.06</td> </tr> <tr> <td>50-99</td> <td>\$19.01</td> </tr> <tr> <td>100+</td> <td>\$18.16</td> </tr> </tbody> </table> <p>75 Ohm F Male to 75 Ohm PAL Jack</p> <p>Model No: <a href="#">PE9632</a></p>	PRICE		1-24	\$21.12	25-49	\$20.06	50-99	\$19.01	100+	\$18.16	 <table border="1"> <thead> <tr> <th colspan="2">PRICE</th> </tr> </thead> <tbody> <tr> <td>1-9</td> <td>\$156.39</td> </tr> <tr> <td>10-24</td> <td>\$148.57</td> </tr> <tr> <td>25-49</td> <td>\$140.75</td> </tr> <tr> <td>50+</td> <td>\$134.50</td> </tr> </tbody> </table> <p>75 Ohm F Female to 75 Ohm BNC Male</p> <p>VSWR 1.3:1 to 3 GHz</p> <p>Model No: <a href="#">PE9741</a></p>	PRICE		1-9	\$156.39	10-24	\$148.57	25-49	\$140.75	50+	\$134.50	 <table border="1"> <thead> <tr> <th colspan="2">PRICE</th> </tr> </thead> <tbody> <tr> <td>1-9</td> <td>\$163.22</td> </tr> <tr> <td>10-24</td> <td>\$155.06</td> </tr> <tr> <td>25-49</td> <td>\$146.90</td> </tr> <tr> <td>50+</td> <td>\$140.37</td> </tr> </tbody> </table> <p>75 Ohm F Female to 75 Ohm BNC Female</p> <p>VSWR 1.3:1 to 3 GHz</p> <p>Model No: <a href="#">PE9744</a></p>	PRICE		1-9	\$163.22	10-24	\$155.06	25-49	\$146.90	50+	\$140.37	 <table border="1"> <thead> <tr> <th colspan="2">PRICE</th> </tr> </thead> <tbody> <tr> <td>1-24</td> <td>\$21.12</td> </tr> <tr> <td>25-49</td> <td>\$20.06</td> </tr> <tr> <td>50-99</td> <td>\$19.01</td> </tr> <tr> <td>100+</td> <td>\$18.16</td> </tr> </tbody> </table> <p>75 Ohm F Female to 75 Ohm PAL Jack</p> <p>Model No: <a href="#">PE9634</a></p>	PRICE		1-24	\$21.12	25-49	\$20.06	50-99	\$19.01	100+	\$18.16	 <table border="1"> <thead> <tr> <th colspan="2">PRICE</th> </tr> </thead> <tbody> <tr> <td>1-24</td> <td>\$20.44</td> </tr> <tr> <td>25-49</td> <td>\$19.42</td> </tr> <tr> <td>50-99</td> <td>\$18.40</td> </tr> <tr> <td>100+</td> <td>\$17.58</td> </tr> </tbody> </table> <p>75 Ohm F Female to 75 Ohm RCA Plug</p> <p>Model No: <a href="#">PE9163</a></p>	PRICE		1-24	\$20.44	25-49	\$19.42	50-99	\$18.40	100+	\$17.58
	PRICE																																																						
1-24	\$21.12																																																						
25-49	\$20.06																																																						
50-99	\$19.01																																																						
100+	\$18.16																																																						
PRICE																																																							
1-9	\$156.39																																																						
10-24	\$148.57																																																						
25-49	\$140.75																																																						
50+	\$134.50																																																						
PRICE																																																							
1-9	\$163.22																																																						
10-24	\$155.06																																																						
25-49	\$146.90																																																						
50+	\$140.37																																																						
PRICE																																																							
1-24	\$21.12																																																						
25-49	\$20.06																																																						
50-99	\$19.01																																																						
100+	\$18.16																																																						
PRICE																																																							
1-24	\$20.44																																																						
25-49	\$19.42																																																						
50-99	\$18.40																																																						
100+	\$17.58																																																						

# ADAPTERS

See Adapter Locator on Pages 10-15

See Page 409 for Mounting Holes

Adapters

See Our Website For Current Pricing & Real-Time Stock Availability!

	A	B	C	D	E																																																		
1	<p><b>75 Ohm Mini SMB In-Series</b></p>  <table border="1"> <thead> <tr> <th colspan="2">PRICE</th> </tr> </thead> <tbody> <tr><td>1-24</td><td>\$41.25</td></tr> <tr><td>25-49</td><td>\$39.19</td></tr> <tr><td>50-99</td><td>\$37.13</td></tr> <tr><td>100+</td><td>\$35.48</td></tr> </tbody> </table> <p>75 Ohm Mini SMB Plug to 75 Ohm Mini SMB Plug</p> <p>Model No: <a href="#">PE9609</a></p>	PRICE		1-24	\$41.25	25-49	\$39.19	50-99	\$37.13	100+	\$35.48	 <table border="1"> <thead> <tr> <th colspan="2">PRICE</th> </tr> </thead> <tbody> <tr><td>1-24</td><td>\$58.64</td></tr> <tr><td>25-49</td><td>\$55.71</td></tr> <tr><td>50-99</td><td>\$52.78</td></tr> <tr><td>100+</td><td>\$50.43</td></tr> </tbody> </table> <p>75 Ohm Mini SMB Plug to 75 Ohm Mini SMB Jack</p> <p>Model No: <a href="#">PE9610</a></p>	PRICE		1-24	\$58.64	25-49	\$55.71	50-99	\$52.78	100+	\$50.43	 <table border="1"> <thead> <tr> <th colspan="2">PRICE</th> </tr> </thead> <tbody> <tr><td>1-24</td><td>\$41.25</td></tr> <tr><td>25-49</td><td>\$39.19</td></tr> <tr><td>50-99</td><td>\$37.13</td></tr> <tr><td>100+</td><td>\$35.48</td></tr> </tbody> </table> <p>75 Ohm Mini SMB Jack to 75 Ohm Mini SMB Jack</p> <p>Model No: <a href="#">PE9608</a></p>	PRICE		1-24	\$41.25	25-49	\$39.19	50-99	\$37.13	100+	\$35.48	 <table border="1"> <thead> <tr> <th colspan="2">PRICE</th> </tr> </thead> <tbody> <tr><td>1-24</td><td>\$53.26</td></tr> <tr><td>25-49</td><td>\$50.60</td></tr> <tr><td>50-99</td><td>\$47.93</td></tr> <tr><td>100+</td><td>\$45.80</td></tr> </tbody> </table> <p>75 Ohm Mini SMB Jack to 75 Ohm Mini SMB Jack Bulkhead</p> <p>Model No: <a href="#">PE9611</a></p>	PRICE		1-24	\$53.26	25-49	\$50.60	50-99	\$47.93	100+	\$45.80											
PRICE																																																							
1-24	\$41.25																																																						
25-49	\$39.19																																																						
50-99	\$37.13																																																						
100+	\$35.48																																																						
PRICE																																																							
1-24	\$58.64																																																						
25-49	\$55.71																																																						
50-99	\$52.78																																																						
100+	\$50.43																																																						
PRICE																																																							
1-24	\$41.25																																																						
25-49	\$39.19																																																						
50-99	\$37.13																																																						
100+	\$35.48																																																						
PRICE																																																							
1-24	\$53.26																																																						
25-49	\$50.60																																																						
50-99	\$47.93																																																						
100+	\$45.80																																																						
2	<p><b>75 Ohm Mini SMB Between Series</b></p>  <table border="1"> <thead> <tr> <th colspan="2">PRICE</th> </tr> </thead> <tbody> <tr><td>1-24</td><td>\$84.84</td></tr> <tr><td>25-49</td><td>\$80.60</td></tr> <tr><td>50-99</td><td>\$76.36</td></tr> <tr><td>100+</td><td>\$72.96</td></tr> </tbody> </table> <p>75 Ohm Mini SMB Plug to 75 Ohm BNC Male</p> <p>Model No: <a href="#">PE9616</a></p>	PRICE		1-24	\$84.84	25-49	\$80.60	50-99	\$76.36	100+	\$72.96	 <table border="1"> <thead> <tr> <th colspan="2">PRICE</th> </tr> </thead> <tbody> <tr><td>1-24</td><td>\$70.62</td></tr> <tr><td>25-49</td><td>\$67.09</td></tr> <tr><td>50-99</td><td>\$63.56</td></tr> <tr><td>100+</td><td>\$60.73</td></tr> </tbody> </table> <p>75 Ohm Mini SMB Plug to 75 Ohm BNC Female</p> <p>Model No: <a href="#">PE9617</a></p>	PRICE		1-24	\$70.62	25-49	\$67.09	50-99	\$63.56	100+	\$60.73	 <table border="1"> <thead> <tr> <th colspan="2">PRICE</th> </tr> </thead> <tbody> <tr><td>1-24</td><td>\$90.06</td></tr> <tr><td>25-49</td><td>\$85.56</td></tr> <tr><td>50-99</td><td>\$81.05</td></tr> <tr><td>100+</td><td>\$77.45</td></tr> </tbody> </table> <p>75 Ohm Mini SMB Jack to 75 Ohm BNC Male</p> <p>Model No: <a href="#">PE9618</a></p>	PRICE		1-24	\$90.06	25-49	\$85.56	50-99	\$81.05	100+	\$77.45	 <table border="1"> <thead> <tr> <th colspan="2">PRICE</th> </tr> </thead> <tbody> <tr><td>1-24</td><td>\$100.51</td></tr> <tr><td>25-49</td><td>\$95.48</td></tr> <tr><td>50-99</td><td>\$90.46</td></tr> <tr><td>100+</td><td>\$86.44</td></tr> </tbody> </table> <p>75 Ohm Mini SMB Jack to 75 Ohm BNC Female</p> <p>Model No: <a href="#">PE9619</a></p>	PRICE		1-24	\$100.51	25-49	\$95.48	50-99	\$90.46	100+	\$86.44											
PRICE																																																							
1-24	\$84.84																																																						
25-49	\$80.60																																																						
50-99	\$76.36																																																						
100+	\$72.96																																																						
PRICE																																																							
1-24	\$70.62																																																						
25-49	\$67.09																																																						
50-99	\$63.56																																																						
100+	\$60.73																																																						
PRICE																																																							
1-24	\$90.06																																																						
25-49	\$85.56																																																						
50-99	\$81.05																																																						
100+	\$77.45																																																						
PRICE																																																							
1-24	\$100.51																																																						
25-49	\$95.48																																																						
50-99	\$90.46																																																						
100+	\$86.44																																																						
3	<p><b>75 Ohm N In-Series</b></p>  <table border="1"> <thead> <tr> <th colspan="2">PRICE</th> </tr> </thead> <tbody> <tr><td>1-24</td><td>\$41.41</td></tr> <tr><td>25-49</td><td>\$39.34</td></tr> <tr><td>50-99</td><td>\$37.27</td></tr> <tr><td>100+</td><td>\$35.61</td></tr> </tbody> </table> <p>75 Ohm N Male to 75 Ohm N Male</p> <p>Max. Freq. 1.5 GHz</p> <p>Model No: <a href="#">PE9308</a></p>	PRICE		1-24	\$41.41	25-49	\$39.34	50-99	\$37.27	100+	\$35.61	 <table border="1"> <thead> <tr> <th colspan="2">PRICE</th> </tr> </thead> <tbody> <tr><td>1-24</td><td>\$45.00</td></tr> <tr><td>25-49</td><td>\$42.75</td></tr> <tr><td>50-99</td><td>\$40.50</td></tr> <tr><td>100+</td><td>\$38.70</td></tr> </tbody> </table> <p>75 Ohm N Male to 75 Ohm N Female</p> <p>Max. Freq. 1.5 GHz</p> <p>Model No: <a href="#">PE9391</a></p>	PRICE		1-24	\$45.00	25-49	\$42.75	50-99	\$40.50	100+	\$38.70	 <table border="1"> <thead> <tr> <th colspan="2">PRICE</th> </tr> </thead> <tbody> <tr><td>1-24</td><td>\$52.64</td></tr> <tr><td>25-49</td><td>\$50.01</td></tr> <tr><td>50-99</td><td>\$47.38</td></tr> <tr><td>100+</td><td>\$45.27</td></tr> </tbody> </table> <p>75 Ohm N Male to 75 Ohm N Female Right Angle</p> <p>Max. Freq. 1.5 GHz</p> <p>Model No: <a href="#">PE9307</a></p>	PRICE		1-24	\$52.64	25-49	\$50.01	50-99	\$47.38	100+	\$45.27	 <table border="1"> <thead> <tr> <th colspan="2">PRICE</th> </tr> </thead> <tbody> <tr><td>1-24</td><td>\$39.62</td></tr> <tr><td>25-49</td><td>\$37.64</td></tr> <tr><td>50-99</td><td>\$35.66</td></tr> <tr><td>100+</td><td>\$34.07</td></tr> </tbody> </table> <p>75 Ohm N Female to 75 Ohm N Female</p> <p>VSWR 1.3:1 to 1,000 MHz</p> <p>Model No: <a href="#">PE9306</a></p>	PRICE		1-24	\$39.62	25-49	\$37.64	50-99	\$35.66	100+	\$34.07											
PRICE																																																							
1-24	\$41.41																																																						
25-49	\$39.34																																																						
50-99	\$37.27																																																						
100+	\$35.61																																																						
PRICE																																																							
1-24	\$45.00																																																						
25-49	\$42.75																																																						
50-99	\$40.50																																																						
100+	\$38.70																																																						
PRICE																																																							
1-24	\$52.64																																																						
25-49	\$50.01																																																						
50-99	\$47.38																																																						
100+	\$45.27																																																						
PRICE																																																							
1-24	\$39.62																																																						
25-49	\$37.64																																																						
50-99	\$35.66																																																						
100+	\$34.07																																																						
4	 <table border="1"> <thead> <tr> <th colspan="2">PRICE</th> </tr> </thead> <tbody> <tr><td>1-24</td><td>\$123.30</td></tr> <tr><td>25-49</td><td>\$117.14</td></tr> <tr><td>50-99</td><td>\$110.97</td></tr> <tr><td>100+</td><td>\$106.04</td></tr> </tbody> </table> <p>75 Ohm N Female to 75 Ohm N Female Bulkhead-Mounting Hole G01</p> <p>Model No: <a href="#">PE9417</a></p>	PRICE		1-24	\$123.30	25-49	\$117.14	50-99	\$110.97	100+	\$106.04	 <table border="1"> <thead> <tr> <th colspan="2">PRICE</th> </tr> </thead> <tbody> <tr><td>1-24</td><td>\$65.96</td></tr> <tr><td>25-49</td><td>\$62.66</td></tr> <tr><td>50-99</td><td>\$59.36</td></tr> <tr><td>100+</td><td>\$56.73</td></tr> </tbody> </table> <p>75 Ohm N Female to 75 Ohm N Female Bulkhead</p> <p>VSWR 1.35:1 to 1.5 GHz</p> <p>Model No: <a href="#">PE9416</a></p>	PRICE		1-24	\$65.96	25-49	\$62.66	50-99	\$59.36	100+	\$56.73	<p><b>75 Ohm N Between Series</b></p>  <table border="1"> <thead> <tr> <th colspan="2">PRICE</th> </tr> </thead> <tbody> <tr><td>1-24</td><td>\$77.67</td></tr> <tr><td>25-49</td><td>\$73.79</td></tr> <tr><td>50-99</td><td>\$69.90</td></tr> <tr><td>100+</td><td>\$66.80</td></tr> </tbody> </table> <p>75 Ohm N Male to 75 Ohm BNC Male</p> <p>Max. Freq. 1,000 MHz</p> <p>Model No: <a href="#">PE9370</a></p>	PRICE		1-24	\$77.67	25-49	\$73.79	50-99	\$69.90	100+	\$66.80	 <table border="1"> <thead> <tr> <th colspan="2">PRICE</th> </tr> </thead> <tbody> <tr><td>1-24</td><td>\$37.13</td></tr> <tr><td>25-49</td><td>\$35.27</td></tr> <tr><td>50-99</td><td>\$33.42</td></tr> <tr><td>100+</td><td>\$31.93</td></tr> </tbody> </table> <p>75 Ohm N Male to 75 Ohm BNC Female</p> <p>VSWR 1.3:1 to 1,000 MHz</p> <p>Model No: <a href="#">PE9369</a></p>	PRICE		1-24	\$37.13	25-49	\$35.27	50-99	\$33.42	100+	\$31.93											
PRICE																																																							
1-24	\$123.30																																																						
25-49	\$117.14																																																						
50-99	\$110.97																																																						
100+	\$106.04																																																						
PRICE																																																							
1-24	\$65.96																																																						
25-49	\$62.66																																																						
50-99	\$59.36																																																						
100+	\$56.73																																																						
PRICE																																																							
1-24	\$77.67																																																						
25-49	\$73.79																																																						
50-99	\$69.90																																																						
100+	\$66.80																																																						
PRICE																																																							
1-24	\$37.13																																																						
25-49	\$35.27																																																						
50-99	\$33.42																																																						
100+	\$31.93																																																						
5	 <table border="1"> <thead> <tr> <th colspan="2">PRICE</th> </tr> </thead> <tbody> <tr><td>1-9</td><td>\$201.12</td></tr> <tr><td>10-24</td><td>\$191.06</td></tr> <tr><td>25-49</td><td>\$181.01</td></tr> <tr><td>50+</td><td>\$172.96</td></tr> </tbody> </table> <p>75 Ohm N Male to 75 Ohm F Male</p> <p>VSWR 1.3:1 to 3 GHz</p> <p>Model No: <a href="#">PE9738</a></p>	PRICE		1-9	\$201.12	10-24	\$191.06	25-49	\$181.01	50+	\$172.96	 <table border="1"> <thead> <tr> <th colspan="2">PRICE</th> </tr> </thead> <tbody> <tr><td>1-24</td><td>\$51.43</td></tr> <tr><td>25-49</td><td>\$48.86</td></tr> <tr><td>50-99</td><td>\$46.29</td></tr> <tr><td>100+</td><td>\$44.23</td></tr> </tbody> </table> <p>75 Ohm N Male to 75 Ohm F Female</p> <p>Max. Freq. 1,000 MHz</p> <p>Model No: <a href="#">PE9396</a></p>	PRICE		1-24	\$51.43	25-49	\$48.86	50-99	\$46.29	100+	\$44.23	 <table border="1"> <thead> <tr> <th colspan="2">PRICE</th> </tr> </thead> <tbody> <tr><td>1-24</td><td>\$109.74</td></tr> <tr><td>25-49</td><td>\$104.25</td></tr> <tr><td>50-99</td><td>\$98.77</td></tr> <tr><td>100+</td><td>\$94.38</td></tr> </tbody> </table> <p>75 Ohm N Male to 75 Ohm Mini SMB Plug</p> <p>Model No: <a href="#">PE9612</a></p>	PRICE		1-24	\$109.74	25-49	\$104.25	50-99	\$98.77	100+	\$94.38	 <table border="1"> <thead> <tr> <th colspan="2">PRICE</th> </tr> </thead> <tbody> <tr><td>1-24</td><td>\$94.34</td></tr> <tr><td>25-49</td><td>\$89.62</td></tr> <tr><td>50-99</td><td>\$84.91</td></tr> <tr><td>100+</td><td>\$81.13</td></tr> </tbody> </table> <p>75 Ohm N Male to 75 Ohm Mini SMB Jack</p> <p>Model No: <a href="#">PE9614</a></p>	PRICE		1-24	\$94.34	25-49	\$89.62	50-99	\$84.91	100+	\$81.13	 <table border="1"> <thead> <tr> <th colspan="2">PRICE</th> </tr> </thead> <tbody> <tr><td>1-24</td><td>\$119.65</td></tr> <tr><td>25-49</td><td>\$113.67</td></tr> <tr><td>50-99</td><td>\$107.69</td></tr> <tr><td>100+</td><td>\$102.90</td></tr> </tbody> </table> <p>75 Ohm N Male to 75 Ohm SMB Plug</p> <p>Model No: <a href="#">PE9584</a></p>	PRICE		1-24	\$119.65	25-49	\$113.67	50-99	\$107.69	100+	\$102.90
PRICE																																																							
1-9	\$201.12																																																						
10-24	\$191.06																																																						
25-49	\$181.01																																																						
50+	\$172.96																																																						
PRICE																																																							
1-24	\$51.43																																																						
25-49	\$48.86																																																						
50-99	\$46.29																																																						
100+	\$44.23																																																						
PRICE																																																							
1-24	\$109.74																																																						
25-49	\$104.25																																																						
50-99	\$98.77																																																						
100+	\$94.38																																																						
PRICE																																																							
1-24	\$94.34																																																						
25-49	\$89.62																																																						
50-99	\$84.91																																																						
100+	\$81.13																																																						
PRICE																																																							
1-24	\$119.65																																																						
25-49	\$113.67																																																						
50-99	\$107.69																																																						
100+	\$102.90																																																						
6	 <table border="1"> <thead> <tr> <th colspan="2">PRICE</th> </tr> </thead> <tbody> <tr><td>1-24</td><td>\$96.07</td></tr> <tr><td>25-49</td><td>\$91.27</td></tr> <tr><td>50-99</td><td>\$86.46</td></tr> <tr><td>100+</td><td>\$82.62</td></tr> </tbody> </table> <p>75 Ohm N Male to 75 Ohm SMB Jack</p> <p>Model No: <a href="#">PE9582</a></p>	PRICE		1-24	\$96.07	25-49	\$91.27	50-99	\$86.46	100+	\$82.62	 <table border="1"> <thead> <tr> <th colspan="2">PRICE</th> </tr> </thead> <tbody> <tr><td>1-24</td><td>\$97.57</td></tr> <tr><td>25-49</td><td>\$92.69</td></tr> <tr><td>50-99</td><td>\$87.81</td></tr> <tr><td>100+</td><td>\$83.91</td></tr> </tbody> </table> <p>75 Ohm N Male to 75 Ohm SMC Jack</p> <p>Model No: <a href="#">PE9586</a></p>	PRICE		1-24	\$97.57	25-49	\$92.69	50-99	\$87.81	100+	\$83.91	 <table border="1"> <thead> <tr> <th colspan="2">PRICE</th> </tr> </thead> <tbody> <tr><td>1-24</td><td>\$83.78</td></tr> <tr><td>25-49</td><td>\$79.59</td></tr> <tr><td>50-99</td><td>\$75.40</td></tr> <tr><td>100+</td><td>\$72.05</td></tr> </tbody> </table> <p>75 Ohm N Male to 75 Ohm TNC Male</p> <p>Max. Freq. 500 MHz</p> <p>Model No: <a href="#">PE9626</a></p>	PRICE		1-24	\$83.78	25-49	\$79.59	50-99	\$75.40	100+	\$72.05	 <table border="1"> <thead> <tr> <th colspan="2">PRICE</th> </tr> </thead> <tbody> <tr><td>1-24</td><td>\$58.64</td></tr> <tr><td>25-49</td><td>\$55.71</td></tr> <tr><td>50-99</td><td>\$52.78</td></tr> <tr><td>100+</td><td>\$50.43</td></tr> </tbody> </table> <p>75 Ohm N Male to 75 Ohm TNC Female</p> <p>Max. Freq. 500 MHz</p> <p>Model No: <a href="#">PE9627</a></p>	PRICE		1-24	\$58.64	25-49	\$55.71	50-99	\$52.78	100+	\$50.43	 <table border="1"> <thead> <tr> <th colspan="2">PRICE</th> </tr> </thead> <tbody> <tr><td>1-24</td><td>\$41.41</td></tr> <tr><td>25-49</td><td>\$39.34</td></tr> <tr><td>50-99</td><td>\$37.27</td></tr> <tr><td>100+</td><td>\$35.61</td></tr> </tbody> </table> <p>75 Ohm N Female to 75 Ohm BNC Male</p> <p>Max. Freq. 1,000 MHz</p> <p>Model No: <a href="#">PE9368</a></p>	PRICE		1-24	\$41.41	25-49	\$39.34	50-99	\$37.27	100+	\$35.61
PRICE																																																							
1-24	\$96.07																																																						
25-49	\$91.27																																																						
50-99	\$86.46																																																						
100+	\$82.62																																																						
PRICE																																																							
1-24	\$97.57																																																						
25-49	\$92.69																																																						
50-99	\$87.81																																																						
100+	\$83.91																																																						
PRICE																																																							
1-24	\$83.78																																																						
25-49	\$79.59																																																						
50-99	\$75.40																																																						
100+	\$72.05																																																						
PRICE																																																							
1-24	\$58.64																																																						
25-49	\$55.71																																																						
50-99	\$52.78																																																						
100+	\$50.43																																																						
PRICE																																																							
1-24	\$41.41																																																						
25-49	\$39.34																																																						
50-99	\$37.27																																																						
100+	\$35.61																																																						
7	 <table border="1"> <thead> <tr> <th colspan="2">PRICE</th> </tr> </thead> <tbody> <tr><td>1-24</td><td>\$54.12</td></tr> <tr><td>25-49</td><td>\$51.41</td></tr> <tr><td>50-99</td><td>\$48.71</td></tr> <tr><td>100+</td><td>\$46.54</td></tr> </tbody> </table> <p>75 Ohm N Female to 75 Ohm BNC Female</p> <p>Max. Freq. 1,000 MHz</p> <p>Model No: <a href="#">PE9371</a></p>	PRICE		1-24	\$54.12	25-49	\$51.41	50-99	\$48.71	100+	\$46.54	 <table border="1"> <thead> <tr> <th colspan="2">PRICE</th> </tr> </thead> <tbody> <tr><td>1-24</td><td>\$52.94</td></tr> <tr><td>25-49</td><td>\$50.29</td></tr> <tr><td>50-99</td><td>\$47.65</td></tr> <tr><td>100+</td><td>\$45.53</td></tr> </tbody> </table> <p>75 Ohm N Female to 75 Ohm F Male</p> <p>VSWR 1.3:1 to 3 GHz</p> <p>Model No: <a href="#">PE9397</a></p>	PRICE		1-24	\$52.94	25-49	\$50.29	50-99	\$47.65	100+	\$45.53	 <table border="1"> <thead> <tr> <th colspan="2">PRICE</th> </tr> </thead> <tbody> <tr><td>1-24</td><td>\$117.50</td></tr> <tr><td>25-49</td><td>\$111.63</td></tr> <tr><td>50-99</td><td>\$105.75</td></tr> <tr><td>100+</td><td>\$101.05</td></tr> </tbody> </table> <p>75 Ohm N Female to 75 Ohm F Male</p> <p>VSWR 1.3:1 to 3 GHz</p> <p>Model No: <a href="#">PE9739</a></p>	PRICE		1-24	\$117.50	25-49	\$111.63	50-99	\$105.75	100+	\$101.05	 <table border="1"> <thead> <tr> <th colspan="2">PRICE</th> </tr> </thead> <tbody> <tr><td>1-9</td><td>\$166.77</td></tr> <tr><td>10-24</td><td>\$158.43</td></tr> <tr><td>25-49</td><td>\$150.09</td></tr> <tr><td>50+</td><td>\$143.42</td></tr> </tbody> </table> <p>75 Ohm N Female to 75 Ohm F Female</p> <p>VSWR 1.3:1 to 3 GHz</p> <p>Model No: <a href="#">PE9740</a></p>	PRICE		1-9	\$166.77	10-24	\$158.43	25-49	\$150.09	50+	\$143.42	 <table border="1"> <thead> <tr> <th colspan="2">PRICE</th> </tr> </thead> <tbody> <tr><td>1-9</td><td>\$124.76</td></tr> <tr><td>10-24</td><td>\$118.52</td></tr> <tr><td>25-49</td><td>\$112.28</td></tr> <tr><td>50+</td><td>\$107.29</td></tr> </tbody> </table> <p>75 Ohm N Female to 75 Ohm Mini SMB Plug</p> <p>Model No: <a href="#">PE9613</a></p>	PRICE		1-9	\$124.76	10-24	\$118.52	25-49	\$112.28	50+	\$107.29
PRICE																																																							
1-24	\$54.12																																																						
25-49	\$51.41																																																						
50-99	\$48.71																																																						
100+	\$46.54																																																						
PRICE																																																							
1-24	\$52.94																																																						
25-49	\$50.29																																																						
50-99	\$47.65																																																						
100+	\$45.53																																																						
PRICE																																																							
1-24	\$117.50																																																						
25-49	\$111.63																																																						
50-99	\$105.75																																																						
100+	\$101.05																																																						
PRICE																																																							
1-9	\$166.77																																																						
10-24	\$158.43																																																						
25-49	\$150.09																																																						
50+	\$143.42																																																						
PRICE																																																							
1-9	\$124.76																																																						
10-24	\$118.52																																																						
25-49	\$112.28																																																						
50+	\$107.29																																																						

# ADAPTERS

See Adapter Locator on Pages 10-15  
See Page 409 for Mounting Holes

	A	B	C	D	E																									
1	 <table border="1"> <thead> <tr> <th>PRICE</th> </tr> </thead> <tbody> <tr> <td>1-24 \$98.11</td> </tr> <tr> <td>25-49 \$93.20</td> </tr> <tr> <td>50-99 \$88.30</td> </tr> <tr> <td>100+ \$84.37</td> </tr> </tbody> </table> <p>75 Ohm N Female to 75 Ohm Mini SMB Jack Max. Freq. 1,000 MHz Model No: <a href="#">PE9615</a></p>	PRICE	1-24 \$98.11	25-49 \$93.20	50-99 \$88.30	100+ \$84.37	 <table border="1"> <thead> <tr> <th>PRICE</th> </tr> </thead> <tbody> <tr> <td>1-24 \$129.35</td> </tr> <tr> <td>25-49 \$122.88</td> </tr> <tr> <td>50-99 \$116.42</td> </tr> <tr> <td>100+ \$111.24</td> </tr> </tbody> </table> <p>75 Ohm N Female to 75 Ohm SMB Plug Model No: <a href="#">PE9585</a></p>	PRICE	1-24 \$129.35	25-49 \$122.88	50-99 \$116.42	100+ \$111.24	 <table border="1"> <thead> <tr> <th>PRICE</th> </tr> </thead> <tbody> <tr> <td>1-24 \$111.20</td> </tr> <tr> <td>25-49 \$105.64</td> </tr> <tr> <td>50-99 \$100.08</td> </tr> <tr> <td>100+ \$95.63</td> </tr> </tbody> </table> <p>75 Ohm N Female to 75 Ohm SMB Jack Model No: <a href="#">PE9583</a></p>	PRICE	1-24 \$111.20	25-49 \$105.64	50-99 \$100.08	100+ \$95.63	 <table border="1"> <thead> <tr> <th>PRICE</th> </tr> </thead> <tbody> <tr> <td>1-24 \$104.84</td> </tr> <tr> <td>25-49 \$99.60</td> </tr> <tr> <td>50-99 \$94.36</td> </tr> <tr> <td>100+ \$90.16</td> </tr> </tbody> </table> <p>75 Ohm N Female to 75 Ohm SMC Plug Model No: <a href="#">PE9589</a></p>	PRICE	1-24 \$104.84	25-49 \$99.60	50-99 \$94.36	100+ \$90.16	 <table border="1"> <thead> <tr> <th>PRICE</th> </tr> </thead> <tbody> <tr> <td>1-24 \$104.41</td> </tr> <tr> <td>25-49 \$99.19</td> </tr> <tr> <td>50-99 \$93.97</td> </tr> <tr> <td>100+ \$89.79</td> </tr> </tbody> </table> <p>75 Ohm N Female to 75 Ohm SMC Jack Model No: <a href="#">PE9587</a></p>	PRICE	1-24 \$104.41	25-49 \$99.19	50-99 \$93.97	100+ \$89.79
PRICE																														
1-24 \$98.11																														
25-49 \$93.20																														
50-99 \$88.30																														
100+ \$84.37																														
PRICE																														
1-24 \$129.35																														
25-49 \$122.88																														
50-99 \$116.42																														
100+ \$111.24																														
PRICE																														
1-24 \$111.20																														
25-49 \$105.64																														
50-99 \$100.08																														
100+ \$95.63																														
PRICE																														
1-24 \$104.84																														
25-49 \$99.60																														
50-99 \$94.36																														
100+ \$90.16																														
PRICE																														
1-24 \$104.41																														
25-49 \$99.19																														
50-99 \$93.97																														
100+ \$89.79																														
2	 <table border="1"> <thead> <tr> <th>PRICE</th> </tr> </thead> <tbody> <tr> <td>1-24 \$58.64</td> </tr> <tr> <td>25-49 \$55.71</td> </tr> <tr> <td>50-99 \$52.78</td> </tr> <tr> <td>100+ \$50.43</td> </tr> </tbody> </table> <p>75 Ohm N Female to 75 Ohm TNC Male Max. Freq. 500 MHz Model No: <a href="#">PE9628</a></p>	PRICE	1-24 \$58.64	25-49 \$55.71	50-99 \$52.78	100+ \$50.43	 <table border="1"> <thead> <tr> <th>PRICE</th> </tr> </thead> <tbody> <tr> <td>1-24 \$58.64</td> </tr> <tr> <td>25-49 \$55.71</td> </tr> <tr> <td>50-99 \$52.78</td> </tr> <tr> <td>100+ \$50.43</td> </tr> </tbody> </table> <p>75 Ohm N Female to 75 Ohm TNC Female Max. Freq. 1,000 MHz Model No: <a href="#">PE9629</a></p>	PRICE	1-24 \$58.64	25-49 \$55.71	50-99 \$52.78	100+ \$50.43	<p>75 Ohm PAL In-Series</p> <p>→</p>		 <table border="1"> <thead> <tr> <th>PRICE</th> </tr> </thead> <tbody> <tr> <td>1-24 \$13.62</td> </tr> <tr> <td>25-49 \$12.94</td> </tr> <tr> <td>50-99 \$12.26</td> </tr> <tr> <td>100+ \$11.71</td> </tr> </tbody> </table> <p>75 Ohm PAL Plug to 75 Ohm PAL Plug Model No: <a href="#">PE9680</a></p>	PRICE	1-24 \$13.62	25-49 \$12.94	50-99 \$12.26	100+ \$11.71	<p>75 Ohm SMB In-Series</p> <p>→</p>									
PRICE																														
1-24 \$58.64																														
25-49 \$55.71																														
50-99 \$52.78																														
100+ \$50.43																														
PRICE																														
1-24 \$58.64																														
25-49 \$55.71																														
50-99 \$52.78																														
100+ \$50.43																														
PRICE																														
1-24 \$13.62																														
25-49 \$12.94																														
50-99 \$12.26																														
100+ \$11.71																														
3	 <table border="1"> <thead> <tr> <th>PRICE</th> </tr> </thead> <tbody> <tr> <td>1-24 \$67.34</td> </tr> <tr> <td>25-49 \$63.97</td> </tr> <tr> <td>50-99 \$60.61</td> </tr> <tr> <td>100+ \$57.91</td> </tr> </tbody> </table> <p>75 Ohm SMB Plug to 75 Ohm SMB Plug Model No: <a href="#">PE9271</a></p>	PRICE	1-24 \$67.34	25-49 \$63.97	50-99 \$60.61	100+ \$57.91	 <table border="1"> <thead> <tr> <th>PRICE</th> </tr> </thead> <tbody> <tr> <td>1-24 \$73.06</td> </tr> <tr> <td>25-49 \$69.41</td> </tr> <tr> <td>50-99 \$65.75</td> </tr> <tr> <td>100+ \$62.83</td> </tr> </tbody> </table> <p>75 Ohm SMB Jack to 75 Ohm SMB Plug Tee Model No: <a href="#">PE9245</a></p>	PRICE	1-24 \$73.06	25-49 \$69.41	50-99 \$65.75	100+ \$62.83	 <table border="1"> <thead> <tr> <th>PRICE</th> </tr> </thead> <tbody> <tr> <td>1-24 \$73.53</td> </tr> <tr> <td>25-49 \$69.85</td> </tr> <tr> <td>50-99 \$66.18</td> </tr> <tr> <td>100+ \$63.24</td> </tr> </tbody> </table> <p>75 Ohm SMB Jack to 75 Ohm SMB Jack Max. Freq. 4 GHz Model No: <a href="#">PE9248</a></p>	PRICE	1-24 \$73.53	25-49 \$69.85	50-99 \$66.18	100+ \$63.24	<p>75 Ohm SMB Between Series</p> <p>→</p>		 <table border="1"> <thead> <tr> <th>PRICE</th> </tr> </thead> <tbody> <tr> <td>1-24 \$72.71</td> </tr> <tr> <td>25-49 \$69.07</td> </tr> <tr> <td>50-99 \$65.44</td> </tr> <tr> <td>100+ \$62.53</td> </tr> </tbody> </table> <p>75 Ohm SMB Plug to BNC Female Model No: <a href="#">PE9232</a></p>	PRICE	1-24 \$72.71	25-49 \$69.07	50-99 \$65.44	100+ \$62.53				
PRICE																														
1-24 \$67.34																														
25-49 \$63.97																														
50-99 \$60.61																														
100+ \$57.91																														
PRICE																														
1-24 \$73.06																														
25-49 \$69.41																														
50-99 \$65.75																														
100+ \$62.83																														
PRICE																														
1-24 \$73.53																														
25-49 \$69.85																														
50-99 \$66.18																														
100+ \$63.24																														
PRICE																														
1-24 \$72.71																														
25-49 \$69.07																														
50-99 \$65.44																														
100+ \$62.53																														
4	 <table border="1"> <thead> <tr> <th>PRICE</th> </tr> </thead> <tbody> <tr> <td>1-24 \$69.90</td> </tr> <tr> <td>25-49 \$66.41</td> </tr> <tr> <td>50-99 \$62.91</td> </tr> <tr> <td>100+ \$60.11</td> </tr> </tbody> </table> <p>75 Ohm SMB Plug to 75 Ohm Mini SMB Jack Max. Freq. 2 GHz Model No: <a href="#">PE9736</a></p>	PRICE	1-24 \$69.90	25-49 \$66.41	50-99 \$62.91	100+ \$60.11	 <table border="1"> <thead> <tr> <th>PRICE</th> </tr> </thead> <tbody> <tr> <td>1-24 \$68.68</td> </tr> <tr> <td>25-49 \$65.25</td> </tr> <tr> <td>50-99 \$61.81</td> </tr> <tr> <td>100+ \$59.06</td> </tr> </tbody> </table> <p>75 Ohm SMB Jack to BNC Male Model No: <a href="#">PE9229</a></p>	PRICE	1-24 \$68.68	25-49 \$65.25	50-99 \$61.81	100+ \$59.06	 <table border="1"> <thead> <tr> <th>PRICE</th> </tr> </thead> <tbody> <tr> <td>1-24 \$78.35</td> </tr> <tr> <td>25-49 \$74.43</td> </tr> <tr> <td>50-99 \$70.52</td> </tr> <tr> <td>100+ \$67.38</td> </tr> </tbody> </table> <p>75 Ohm SMB Jack to 75 Ohm Mini SMB Plug Model No: <a href="#">PE9735</a></p>	PRICE	1-24 \$78.35	25-49 \$74.43	50-99 \$70.52	100+ \$67.38	<p>75 Ohm SMC In-Series</p> <p>→</p>		 <table border="1"> <thead> <tr> <th>PRICE</th> </tr> </thead> <tbody> <tr> <td>1-24 \$62.18</td> </tr> <tr> <td>25-49 \$59.07</td> </tr> <tr> <td>50-99 \$55.96</td> </tr> <tr> <td>100+ \$53.47</td> </tr> </tbody> </table> <p>75 Ohm SMC Jack to 75 Ohm SMC Plug Tee Model No: <a href="#">PE9244</a></p>	PRICE	1-24 \$62.18	25-49 \$59.07	50-99 \$55.96	100+ \$53.47				
PRICE																														
1-24 \$69.90																														
25-49 \$66.41																														
50-99 \$62.91																														
100+ \$60.11																														
PRICE																														
1-24 \$68.68																														
25-49 \$65.25																														
50-99 \$61.81																														
100+ \$59.06																														
PRICE																														
1-24 \$78.35																														
25-49 \$74.43																														
50-99 \$70.52																														
100+ \$67.38																														
PRICE																														
1-24 \$62.18																														
25-49 \$59.07																														
50-99 \$55.96																														
100+ \$53.47																														
5	 <table border="1"> <thead> <tr> <th>PRICE</th> </tr> </thead> <tbody> <tr> <td>1-24 \$47.23</td> </tr> <tr> <td>25-49 \$44.87</td> </tr> <tr> <td>50-99 \$42.51</td> </tr> <tr> <td>100+ \$40.62</td> </tr> </tbody> </table> <p>75 Ohm SMC Jack to 75 Ohm SMC Jack Model No: <a href="#">PE9227</a></p>	PRICE	1-24 \$47.23	25-49 \$44.87	50-99 \$42.51	100+ \$40.62	 <table border="1"> <thead> <tr> <th>PRICE</th> </tr> </thead> <tbody> <tr> <td>1-24 \$62.05</td> </tr> <tr> <td>25-49 \$58.95</td> </tr> <tr> <td>50-99 \$55.85</td> </tr> <tr> <td>100+ \$53.36</td> </tr> </tbody> </table> <p>75 Ohm SMC Jack to 75 Ohm SMC Jack Bulkhead-Mounting Hole B03 Model No: <a href="#">PE9228</a></p>	PRICE	1-24 \$62.05	25-49 \$58.95	50-99 \$55.85	100+ \$53.36	<p>75 Ohm SMC Between Series</p> <p>→</p>		 <table border="1"> <thead> <tr> <th>PRICE</th> </tr> </thead> <tbody> <tr> <td>1-24 \$68.58</td> </tr> <tr> <td>25-49 \$65.15</td> </tr> <tr> <td>50-99 \$61.72</td> </tr> <tr> <td>100+ \$58.98</td> </tr> </tbody> </table> <p>75 Ohm SMC Jack to BNC Female Model No: <a href="#">PE9235</a></p>	PRICE	1-24 \$68.58	25-49 \$65.15	50-99 \$61.72	100+ \$58.98	<p>75 Ohm TNC In-Series</p> <p>→</p>									
PRICE																														
1-24 \$47.23																														
25-49 \$44.87																														
50-99 \$42.51																														
100+ \$40.62																														
PRICE																														
1-24 \$62.05																														
25-49 \$58.95																														
50-99 \$55.85																														
100+ \$53.36																														
PRICE																														
1-24 \$68.58																														
25-49 \$65.15																														
50-99 \$61.72																														
100+ \$58.98																														
6	 <table border="1"> <thead> <tr> <th>PRICE</th> </tr> </thead> <tbody> <tr> <td>1-24 \$105.72</td> </tr> <tr> <td>25-49 \$100.43</td> </tr> <tr> <td>50-99 \$95.15</td> </tr> <tr> <td>100+ \$90.92</td> </tr> </tbody> </table> <p>75 Ohm TNC Male to 75 Ohm TNC Female Right Angle Model No: <a href="#">PE9623</a></p>	PRICE	1-24 \$105.72	25-49 \$100.43	50-99 \$95.15	100+ \$90.92	 <table border="1"> <thead> <tr> <th>PRICE</th> </tr> </thead> <tbody> <tr> <td>1-24 \$42.42</td> </tr> <tr> <td>25-49 \$40.30</td> </tr> <tr> <td>50-99 \$38.18</td> </tr> <tr> <td>100+ \$36.48</td> </tr> </tbody> </table> <p>75 Ohm TNC Female to 75 Ohm TNC Female Max. Freq. 1,000 MHz Model No: <a href="#">PE9622</a></p>	PRICE	1-24 \$42.42	25-49 \$40.30	50-99 \$38.18	100+ \$36.48	 <table border="1"> <thead> <tr> <th>PRICE</th> </tr> </thead> <tbody> <tr> <td>1-24 \$58.64</td> </tr> <tr> <td>25-49 \$55.71</td> </tr> <tr> <td>50-99 \$52.78</td> </tr> <tr> <td>100+ \$50.43</td> </tr> </tbody> </table> <p>75 Ohm TNC Female to 75 Ohm TNC Female Bulkhead-Mounting Hole B06 Max. Freq. 1,000 MHz Model No: <a href="#">PE9625</a></p>	PRICE	1-24 \$58.64	25-49 \$55.71	50-99 \$52.78	100+ \$50.43	 <table border="1"> <thead> <tr> <th>PRICE</th> </tr> </thead> <tbody> <tr> <td>1-24 \$100.05</td> </tr> <tr> <td>25-49 \$95.05</td> </tr> <tr> <td>50-99 \$90.05</td> </tr> <tr> <td>100+ \$86.04</td> </tr> </tbody> </table> <p>75 Ohm TNC Female to 75 Ohm TNC Female Bulkhead Model No: <a href="#">PE9624</a></p>	PRICE	1-24 \$100.05	25-49 \$95.05	50-99 \$90.05	100+ \$86.04	<p>75 Ohm TNC Between Series</p> <p>→</p>					
PRICE																														
1-24 \$105.72																														
25-49 \$100.43																														
50-99 \$95.15																														
100+ \$90.92																														
PRICE																														
1-24 \$42.42																														
25-49 \$40.30																														
50-99 \$38.18																														
100+ \$36.48																														
PRICE																														
1-24 \$58.64																														
25-49 \$55.71																														
50-99 \$52.78																														
100+ \$50.43																														
PRICE																														
1-24 \$100.05																														
25-49 \$95.05																														
50-99 \$90.05																														
100+ \$86.04																														
7	 <table border="1"> <thead> <tr> <th>PRICE</th> </tr> </thead> <tbody> <tr> <td>1-24 \$31.83</td> </tr> <tr> <td>25-49 \$30.24</td> </tr> <tr> <td>50-99 \$28.65</td> </tr> <tr> <td>100+ \$27.37</td> </tr> </tbody> </table> <p>75 Ohm TNC Male to 75 Ohm BNC Female Max. Freq. 500 MHz Model No: <a href="#">PE9631</a></p>	PRICE	1-24 \$31.83	25-49 \$30.24	50-99 \$28.65	100+ \$27.37	 <table border="1"> <thead> <tr> <th>PRICE</th> </tr> </thead> <tbody> <tr> <td>1-24 \$88.72</td> </tr> <tr> <td>25-49 \$84.28</td> </tr> <tr> <td>50-99 \$79.85</td> </tr> <tr> <td>100+ \$76.30</td> </tr> </tbody> </table> <p>75 Ohm TNC Male to 75 Ohm F Male VSWR 1.35:1 to 2 GHz Model No: <a href="#">PE91081</a></p>	PRICE	1-24 \$88.72	25-49 \$84.28	50-99 \$79.85	100+ \$76.30	 <table border="1"> <thead> <tr> <th>PRICE</th> </tr> </thead> <tbody> <tr> <td>1-24 \$78.88</td> </tr> <tr> <td>25-49 \$74.94</td> </tr> <tr> <td>50-99 \$70.99</td> </tr> <tr> <td>100+ \$67.84</td> </tr> </tbody> </table> <p>75 Ohm TNC Male to 75 Ohm F Female VSWR 1.35:1 to 2 GHz Model No: <a href="#">PE91080</a></p>	PRICE	1-24 \$78.88	25-49 \$74.94	50-99 \$70.99	100+ \$67.84	 <table border="1"> <thead> <tr> <th>PRICE</th> </tr> </thead> <tbody> <tr> <td>1-24 \$58.64</td> </tr> <tr> <td>25-49 \$55.71</td> </tr> <tr> <td>50-99 \$52.78</td> </tr> <tr> <td>100+ \$50.43</td> </tr> </tbody> </table> <p>75 Ohm TNC Female to 75 Ohm BNC Male Max. Freq. 1,000 MHz Model No: <a href="#">PE9630</a></p>	PRICE	1-24 \$58.64	25-49 \$55.71	50-99 \$52.78	100+ \$50.43	 <table border="1"> <thead> <tr> <th>PRICE</th> </tr> </thead> <tbody> <tr> <td>1-24 \$104.17</td> </tr> <tr> <td>25-49 \$98.96</td> </tr> <tr> <td>50-99 \$93.75</td> </tr> <tr> <td>100+ \$89.59</td> </tr> </tbody> </table> <p>75 Ohm TNC Female to 75 Ohm F Male VSWR 1.35:1 to 2 GHz Model No: <a href="#">PE91083</a></p>	PRICE	1-24 \$104.17	25-49 \$98.96	50-99 \$93.75	100+ \$89.59
PRICE																														
1-24 \$31.83																														
25-49 \$30.24																														
50-99 \$28.65																														
100+ \$27.37																														
PRICE																														
1-24 \$88.72																														
25-49 \$84.28																														
50-99 \$79.85																														
100+ \$76.30																														
PRICE																														
1-24 \$78.88																														
25-49 \$74.94																														
50-99 \$70.99																														
100+ \$67.84																														
PRICE																														
1-24 \$58.64																														
25-49 \$55.71																														
50-99 \$52.78																														
100+ \$50.43																														
PRICE																														
1-24 \$104.17																														
25-49 \$98.96																														
50-99 \$93.75																														
100+ \$89.59																														



Technical Support  
+1 (949) 261-1920



Same-Day Shipping,  
Even Custom Cable Assemblies



# ADAPTERS

See Adapter Locator on Pages 10-15

See Page 409 for Mounting Holes

Adapters

See Our Website For Current Pricing & Real-Time Stock Availability!

	A	B	C	D	E																																								
1	 <table border="1"> <thead> <tr> <th colspan="2">PRICE</th> </tr> </thead> <tbody> <tr> <td>1-24</td> <td>\$88.73</td> </tr> <tr> <td>25-49</td> <td>\$85.18</td> </tr> <tr> <td>50-99</td> <td>\$82.52</td> </tr> <tr> <td>100+</td> <td>\$80.74</td> </tr> </tbody> </table> <p>75 Ohm TNC Female to 75 Ohm F Female</p> <p>VSWR 1.35:1 to 2 GHz</p> <p>Model No: <a href="#">PE91082</a></p>	PRICE		1-24	\$88.73	25-49	\$85.18	50-99	\$82.52	100+	\$80.74	<p><b>BNC Twinax In-Series</b></p> <p>→</p>	 <table border="1"> <thead> <tr> <th colspan="2">PRICE</th> </tr> </thead> <tbody> <tr> <td>1-24</td> <td>\$94.04</td> </tr> <tr> <td>25-49</td> <td>\$89.34</td> </tr> <tr> <td>50-99</td> <td>\$84.64</td> </tr> <tr> <td>100+</td> <td>\$80.87</td> </tr> </tbody> </table> <p>78 Ohm BNC Twinax Plug to 78 Ohm BNC Twinax Plug</p> <p>Model No: <a href="#">PE9376</a></p>	PRICE		1-24	\$94.04	25-49	\$89.34	50-99	\$84.64	100+	\$80.87	 <table border="1"> <thead> <tr> <th colspan="2">PRICE</th> </tr> </thead> <tbody> <tr> <td>1-24</td> <td>\$93.42</td> </tr> <tr> <td>25-49</td> <td>\$88.75</td> </tr> <tr> <td>50-99</td> <td>\$84.08</td> </tr> <tr> <td>100+</td> <td>\$80.34</td> </tr> </tbody> </table> <p>78 Ohm BNC Twinax Plug to 78 Ohm BNC Twinax Jack Right Angle</p> <p>Model No: <a href="#">PE9377</a></p>	PRICE		1-24	\$93.42	25-49	\$88.75	50-99	\$84.08	100+	\$80.34	 <table border="1"> <thead> <tr> <th colspan="2">PRICE</th> </tr> </thead> <tbody> <tr> <td>1-24</td> <td>\$92.99</td> </tr> <tr> <td>25-49</td> <td>\$88.34</td> </tr> <tr> <td>50-99</td> <td>\$83.69</td> </tr> <tr> <td>100+</td> <td>\$79.97</td> </tr> </tbody> </table> <p>78 Ohm BNC Twinax Jack to 78 Ohm BNC Twinax Plug Tee</p> <p>Model No: <a href="#">PE9375</a></p>	PRICE		1-24	\$92.99	25-49	\$88.34	50-99	\$83.69	100+	\$79.97
PRICE																																													
1-24	\$88.73																																												
25-49	\$85.18																																												
50-99	\$82.52																																												
100+	\$80.74																																												
PRICE																																													
1-24	\$94.04																																												
25-49	\$89.34																																												
50-99	\$84.64																																												
100+	\$80.87																																												
PRICE																																													
1-24	\$93.42																																												
25-49	\$88.75																																												
50-99	\$84.08																																												
100+	\$80.34																																												
PRICE																																													
1-24	\$92.99																																												
25-49	\$88.34																																												
50-99	\$83.69																																												
100+	\$79.97																																												
2	 <table border="1"> <thead> <tr> <th colspan="2">PRICE</th> </tr> </thead> <tbody> <tr> <td>1-24</td> <td>\$42.14</td> </tr> <tr> <td>25-49</td> <td>\$40.03</td> </tr> <tr> <td>50-99</td> <td>\$37.93</td> </tr> <tr> <td>100+</td> <td>\$36.24</td> </tr> </tbody> </table> <p>78 Ohm BNC Twinax Jack to 78 Ohm BNC Twinax Jack</p> <p>Max. Freq. 500 MHz</p> <p>Model No: <a href="#">PE9378</a></p>	PRICE		1-24	\$42.14	25-49	\$40.03	50-99	\$37.93	100+	\$36.24	 <table border="1"> <thead> <tr> <th colspan="2">PRICE</th> </tr> </thead> <tbody> <tr> <td>1-24</td> <td>\$58.75</td> </tr> <tr> <td>25-49</td> <td>\$55.81</td> </tr> <tr> <td>50-99</td> <td>\$52.88</td> </tr> <tr> <td>100+</td> <td>\$50.53</td> </tr> </tbody> </table> <p>78 Ohm BNC Twinax Jack to 78 Ohm BNC Twinax Jack Bulkhead</p> <p>Max. Freq. 500 MHz</p> <p>Model No: <a href="#">PE9280</a></p>	PRICE		1-24	\$58.75	25-49	\$55.81	50-99	\$52.88	100+	\$50.53	<p><b>3/4"-20 Twinax In-Series</b></p> <p>→</p>	 <table border="1"> <thead> <tr> <th colspan="2">PRICE</th> </tr> </thead> <tbody> <tr> <td>1-24</td> <td>\$44.69</td> </tr> <tr> <td>25-49</td> <td>\$42.46</td> </tr> <tr> <td>50-99</td> <td>\$40.22</td> </tr> <tr> <td>100+</td> <td>\$38.43</td> </tr> </tbody> </table> <p>95 Ohm 3/4"-20 Twinax Female to 95 Ohm 3/4"-20 Twinax Male Tee</p> <p>Max. Freq. 400 MHz</p> <p>Model No: <a href="#">PE9374</a></p>	PRICE		1-24	\$44.69	25-49	\$42.46	50-99	\$40.22	100+	\$38.43	 <table border="1"> <thead> <tr> <th colspan="2">PRICE</th> </tr> </thead> <tbody> <tr> <td>1-24</td> <td>\$33.56</td> </tr> <tr> <td>25-49</td> <td>\$31.88</td> </tr> <tr> <td>50-99</td> <td>\$30.20</td> </tr> <tr> <td>100+</td> <td>\$28.86</td> </tr> </tbody> </table> <p>95 Ohm 3/4"-20 Twinax Female to 95 Ohm 3/4"-20 Twinax Female</p> <p>Model No: <a href="#">PE9199</a></p>	PRICE		1-24	\$33.56	25-49	\$31.88	50-99	\$30.20	100+	\$28.86
PRICE																																													
1-24	\$42.14																																												
25-49	\$40.03																																												
50-99	\$37.93																																												
100+	\$36.24																																												
PRICE																																													
1-24	\$58.75																																												
25-49	\$55.81																																												
50-99	\$52.88																																												
100+	\$50.53																																												
PRICE																																													
1-24	\$44.69																																												
25-49	\$42.46																																												
50-99	\$40.22																																												
100+	\$38.43																																												
PRICE																																													
1-24	\$33.56																																												
25-49	\$31.88																																												
50-99	\$30.20																																												
100+	\$28.86																																												
3	 <table border="1"> <thead> <tr> <th colspan="2">PRICE</th> </tr> </thead> <tbody> <tr> <td>1-24</td> <td>\$57.44</td> </tr> <tr> <td>25-49</td> <td>\$54.57</td> </tr> <tr> <td>50-99</td> <td>\$51.70</td> </tr> <tr> <td>100+</td> <td>\$49.40</td> </tr> </tbody> </table> <p>95 Ohm 3/4"-20 Twinax Female to 95 Ohm 3/4"-20 Twinax Female Bulkhead</p> <p>Model No: <a href="#">PE9373</a></p>	PRICE		1-24	\$57.44	25-49	\$54.57	50-99	\$51.70	100+	\$49.40	<p><b>Banana Between Series</b></p> <p>→</p>	 <table border="1"> <thead> <tr> <th colspan="2">PRICE</th> </tr> </thead> <tbody> <tr> <td>1-24</td> <td>\$52.92</td> </tr> <tr> <td>25-49</td> <td>\$50.27</td> </tr> <tr> <td>50-99</td> <td>\$47.63</td> </tr> <tr> <td>100+</td> <td>\$45.51</td> </tr> </tbody> </table> <p>Banana Plug to BNC Female</p> <p>Model No: <a href="#">PE9175</a></p>	PRICE		1-24	\$52.92	25-49	\$50.27	50-99	\$47.63	100+	\$45.51	<p><b>Double Banana Between Series</b></p> <p>→</p>	 <table border="1"> <thead> <tr> <th colspan="2">PRICE</th> </tr> </thead> <tbody> <tr> <td>1-24</td> <td>\$27.33</td> </tr> <tr> <td>25-49</td> <td>\$25.96</td> </tr> <tr> <td>50-99</td> <td>\$24.60</td> </tr> <tr> <td>NEW 100+</td> <td>\$23.50</td> </tr> </tbody> </table> <p>Double Banana Plug to BNC Male</p> <p>Model No: <a href="#">PE9009</a></p>	PRICE		1-24	\$27.33	25-49	\$25.96	50-99	\$24.60	NEW 100+	\$23.50										
PRICE																																													
1-24	\$57.44																																												
25-49	\$54.57																																												
50-99	\$51.70																																												
100+	\$49.40																																												
PRICE																																													
1-24	\$52.92																																												
25-49	\$50.27																																												
50-99	\$47.63																																												
100+	\$45.51																																												
PRICE																																													
1-24	\$27.33																																												
25-49	\$25.96																																												
50-99	\$24.60																																												
NEW 100+	\$23.50																																												
4	 <table border="1"> <thead> <tr> <th colspan="2">PRICE</th> </tr> </thead> <tbody> <tr> <td>1-24</td> <td>\$27.57</td> </tr> <tr> <td>25-49</td> <td>\$26.19</td> </tr> <tr> <td>50-99</td> <td>\$24.81</td> </tr> <tr> <td>NEW 100+</td> <td>\$23.71</td> </tr> </tbody> </table> <p>Double Banana Plug to BNC Female</p> <p>Model No: <a href="#">PE9008</a></p>	PRICE		1-24	\$27.57	25-49	\$26.19	50-99	\$24.81	NEW 100+	\$23.71	<p><b>Banana Binding Post Between Series</b></p> <p>→</p>	 <table border="1"> <thead> <tr> <th colspan="2">PRICE</th> </tr> </thead> <tbody> <tr> <td>1-24</td> <td>\$21.53</td> </tr> <tr> <td>25-49</td> <td>\$20.45</td> </tr> <tr> <td>50-99</td> <td>\$19.38</td> </tr> <tr> <td>NEW 100+</td> <td>\$18.52</td> </tr> </tbody> </table> <p>Banana Binding Post Jack to BNC Male</p> <p>Model No: <a href="#">PE9169</a></p>	PRICE		1-24	\$21.53	25-49	\$20.45	50-99	\$19.38	NEW 100+	\$18.52	<p><b>Double Banana Binding Post Between Series</b></p> <p>→</p>	 <table border="1"> <thead> <tr> <th colspan="2">PRICE</th> </tr> </thead> <tbody> <tr> <td>1-24</td> <td>\$31.41</td> </tr> <tr> <td>25-49</td> <td>\$29.84</td> </tr> <tr> <td>50-99</td> <td>\$28.27</td> </tr> <tr> <td>NEW 100+</td> <td>\$27.01</td> </tr> </tbody> </table> <p>Double Banana Binding Post Jack to BNC Female</p> <p>Model No: <a href="#">PE9013</a></p>	PRICE		1-24	\$31.41	25-49	\$29.84	50-99	\$28.27	NEW 100+	\$27.01										
PRICE																																													
1-24	\$27.57																																												
25-49	\$26.19																																												
50-99	\$24.81																																												
NEW 100+	\$23.71																																												
PRICE																																													
1-24	\$21.53																																												
25-49	\$20.45																																												
50-99	\$19.38																																												
NEW 100+	\$18.52																																												
PRICE																																													
1-24	\$31.41																																												
25-49	\$29.84																																												
50-99	\$28.27																																												
NEW 100+	\$27.01																																												
5	<p><b>Non Constant Ohm BNC Triax In-Series</b></p> <p>→</p>	 <table border="1"> <thead> <tr> <th colspan="2">PRICE</th> </tr> </thead> <tbody> <tr> <td>1-9</td> <td>\$165.76</td> </tr> <tr> <td>10-24</td> <td>\$157.47</td> </tr> <tr> <td>25-49</td> <td>\$149.18</td> </tr> <tr> <td>50+</td> <td>\$142.55</td> </tr> </tbody> </table> <p>BNC Triax Male to BNC Triax Female Tee</p> <p>Max. Freq. 500 MHz</p> <p>Model No: <a href="#">PE91106</a></p>	PRICE		1-9	\$165.76	10-24	\$157.47	25-49	\$149.18	50+	\$142.55	 <table border="1"> <thead> <tr> <th colspan="2">PRICE</th> </tr> </thead> <tbody> <tr> <td>1-24</td> <td>\$46.85</td> </tr> <tr> <td>25-49</td> <td>\$44.51</td> </tr> <tr> <td>50-99</td> <td>\$42.17</td> </tr> <tr> <td>100+</td> <td>\$40.29</td> </tr> </tbody> </table> <p>BNC Triax Female to BNC Triax Female</p> <p>Max. Freq. 500 MHz</p> <p>Model No: <a href="#">PE91107</a></p>	PRICE		1-24	\$46.85	25-49	\$44.51	50-99	\$42.17	100+	\$40.29	 <table border="1"> <thead> <tr> <th colspan="2">PRICE</th> </tr> </thead> <tbody> <tr> <td>1-9</td> <td>\$159.50</td> </tr> <tr> <td>10-24</td> <td>\$151.53</td> </tr> <tr> <td>25-49</td> <td>\$143.55</td> </tr> <tr> <td>50+</td> <td>\$137.17</td> </tr> </tbody> </table> <p>BNC Triax Female to BNC Triax Female Bulkhead-Mounting Hole B15</p> <p>Max. Freq. 500 MHz</p> <p>Model No: <a href="#">PE91105</a></p>	PRICE		1-9	\$159.50	10-24	\$151.53	25-49	\$143.55	50+	\$137.17	<p>Visit <a href="http://pasternack.com">pasternack.com</a> for our complete offering of adapters</p>										
PRICE																																													
1-9	\$165.76																																												
10-24	\$157.47																																												
25-49	\$149.18																																												
50+	\$142.55																																												
PRICE																																													
1-24	\$46.85																																												
25-49	\$44.51																																												
50-99	\$42.17																																												
100+	\$40.29																																												
PRICE																																													
1-9	\$159.50																																												
10-24	\$151.53																																												
25-49	\$143.55																																												
50+	\$137.17																																												

# Amplifiers Selection Guide

## 3 Easy Ways to Find your Product.....

### 1. Search by PE Part Number

If you know the PE part number you are searching for, please reference our Part Number Index on Page [395](#).

### 2. Quick Reference Guide

Bi Directional Amplifiers.....	<a href="#">51</a>
Broadband Amplifiers.....	<a href="#">51</a>
USB Controlled.....	<a href="#">52</a>
Bench Top.....	<a href="#">52</a>
DC Coupled Amplifiers.....	<a href="#">53</a>
Gain Block Amplifiers.....	<a href="#">53</a>
Limiting Amplifiers.....	<a href="#">53</a>
Log Amplifiers.....	<a href="#">54</a>
Low Noise Amplifiers.....	<a href="#">54</a>
Standard.....	<a href="#">54</a>
Input Protected.....	<a href="#">55</a>
Power Amplifiers.....	<a href="#">55</a>
Power Amplifiers (<4W).....	<a href="#">55</a>
High Power Amplifiers (>4W).....	<a href="#">57</a>
GaN High Power Amplifiers.....	<a href="#">58</a>
Variable Amplifiers.....	<a href="#">59</a>
Amplifier Accessories.....	<a href="#">59</a>

### 3. Amplifiers Locator

Frequency	Model No.	Page C/R	Frequency	Model No.	Page C/R	Frequency	Model No.	Page C/R	Frequency	Model No.	Page C/R
<b>DC to:</b>			<b>10 MHz to:</b>			<b>20 MHz to:</b>			<b>100 MHz to:</b>		
1.5 GHz	<a href="#">PE15A86001</a>	<a href="#">53</a> 31	1 GHz	<a href="#">PE15A63000</a>	<a href="#">55</a> 3	3 GHz	<a href="#">PE15A1008</a>	<a href="#">54</a> 62	18 GHz	<a href="#">PE15A3255</a>	<a href="#">52</a> 65
17 MHz	<a href="#">PE15A86002</a>	<a href="#">53</a> 30		<a href="#">PE15A63001</a>	<a href="#">55</a> 4	4 GHz	<a href="#">PE15A4017</a>	<a href="#">55</a> 27		<a href="#">PE15A3256</a>	<a href="#">52</a> 66
2 GHz	<a href="#">PE15A86000</a>	<a href="#">53</a> 32		<a href="#">PE15A1011</a>	<a href="#">54</a> 52	520 MHz	<a href="#">PE15A1061</a>	<a href="#">54</a> 63		<a href="#">PE15A4052</a>	<a href="#">56</a> 31
<b>0.009 MHz to:</b>				<a href="#">PE15A1049</a>	<a href="#">54</a> 53	<b>30 MHz to:</b>				<a href="#">PE15A4052F</a>	<a href="#">56</a> 32
3 GHz	<a href="#">PE15A1007</a>	<a href="#">54</a> 41		<a href="#">PE15A1012</a>	<a href="#">54</a> 54	1.5 GHz	<a href="#">PE15A63002</a>	<a href="#">55</a> 5		<a href="#">PE15A7000</a>	<a href="#">59</a> 62
<b>0.01 MHz to:</b>				<a href="#">PE15A1013</a>	<a href="#">54</a> 55	2.5 GHz	<a href="#">PE15A63003</a>	<a href="#">55</a> 6	2 GHz	<a href="#">PE15A1066</a>	<a href="#">54</a> 69
1.4 GHz	<a href="#">PE15A1055</a>	<a href="#">54</a> 43	<a href="#">PE15A1052</a>	<a href="#">54</a> 56	20 GHz	<a href="#">PE15A5011</a>	<a href="#">58</a> 39	26.5 GHz	<a href="#">PE15A3267</a>	<a href="#">52</a> 67	
2 GHz	<a href="#">PE15A1059</a>	<a href="#">54</a> 44	1.3 GHz	<a href="#">PE15A1054</a>	<a href="#">54</a> 57	2.7 GHz	<a href="#">PE15B5003</a>	<a href="#">51</a> 1	3 GHz	<a href="#">PE1516</a>	<a href="#">53</a> 18
3 GHz	<a href="#">PE15A3308</a>	<a href="#">52</a> 57	15 GHz	<a href="#">PE15A3037</a>	<a href="#">52</a> 98	40 GHz	<a href="#">PE15A5086</a>	<a href="#">58</a> 40	6 GHz	<a href="#">PE15A5027</a>	<a href="#">58</a> 41
500 MHz	<a href="#">PE15A1046</a>	<a href="#">54</a> 42	<a href="#">PE15A3036</a>	<a href="#">51</a> 8	20 GHz	<a href="#">PE15A3254</a>	<a href="#">52</a> 63	<b>110 MHz to:</b>			
<b>0.03 MHz to:</b>			<a href="#">PE15A4029</a>	<a href="#">51</a> 9	26.5 GHz	<a href="#">PE15A3312</a>	<a href="#">52</a> 64	10 GHz	<a href="#">PE15A3001</a>	<a href="#">51</a> 13	
600 MHz	<a href="#">PE15A1047</a>	<a href="#">54</a> 45	250 MHz	<a href="#">PE15A1043</a>	<a href="#">54</a> 47	3 GHz	<a href="#">PE15A4018</a>	<a href="#">56</a> 28	6 GHz	<a href="#">PE15A3004</a>	<a href="#">51</a> 12
<b>0.1 MHz to:</b>			<a href="#">PE1514</a>	<a href="#">53</a> 11	40 GHz	<a href="#">PE15A3023</a>	<a href="#">51</a> 10	<b>200 MHz to:</b>			
10 GHz	<a href="#">PE15A3311</a>	<a href="#">52</a> 58	3 GHz	<a href="#">PE1528</a>	<a href="#">53</a> 12	<b>40 MHz to:</b>			2.5 GHz	<a href="#">PE1525</a>	<a href="#">53</a> 19
<b>0.15 MHz to:</b>			<a href="#">PE1513</a>	<a href="#">53</a> 13	3 GHz	<a href="#">PE15A1060</a>	<a href="#">54</a> 64	2.6 GHz	<a href="#">PE15A5084</a>	<a href="#">56</a> 33	
230 MHz	<a href="#">PE15A5028</a>	<a href="#">57</a> 94	550 MHz	<a href="#">PE15A1009</a>	<a href="#">54</a> 58	<b>50 MHz to:</b>			<b>225 MHz to:</b>		
500 MHz	<a href="#">PE15A5028F</a>	<a href="#">57</a> 95	<a href="#">PE15A1044</a>	<a href="#">54</a> 48	1 GHz	<a href="#">PE1517</a>	<a href="#">53</a> 15	512 MHz	<a href="#">PE15B5007</a>	<a href="#">51</a> 2	
<b>0.3 MHz to:</b>			<a href="#">PE15A4032</a>	<a href="#">51</a> 7	1 GHz	<a href="#">PE15A1050</a>	<a href="#">54</a> 65	<b>300 MHz to:</b>			
6.5 GHz	<a href="#">PE15A3310</a>	<a href="#">52</a> 59	6 GHz	<a href="#">PE15A3269</a>	<a href="#">52</a> 61	1.2 GHz	<a href="#">PE15A1014</a>	<a href="#">54</a> 66	18 GHz	<a href="#">PE15A3021</a>	<a href="#">51</a> 14
<b>0.5 MHz to:</b>			<a href="#">PE15A8001</a>	<a href="#">53</a> 14	600 MHz	<a href="#">PE15A1053</a>	<a href="#">54</a> 67	<b>500 MHz to:</b>			
500 MHz	<a href="#">PE15A5029</a>	<a href="#">57</a> 96	800 MHz	<a href="#">PE15A1048</a>	<a href="#">54</a> 50	18 GHz	<a href="#">PE15A3900</a>	<a href="#">52</a> 96	1 GHz	<a href="#">PE15A5058</a>	<a href="#">56</a> 34
500 MHz	<a href="#">PE15A5029F</a>	<a href="#">57</a> 97	<a href="#">PE15A1065</a>	<a href="#">54</a> 51	1 GHz	<a href="#">PE1518</a>	<a href="#">53</a> 16	10 GHz	<a href="#">PE15A3005</a>	<a href="#">51</a> 20	
<b>1 MHz to:</b>			<b>20 MHz to:</b>			2 GHz	<a href="#">PE15A1042</a>	<a href="#">54</a> 68	18 GHz	<a href="#">PE15A3263</a>	<a href="#">51</a> 22
1 GHz	<a href="#">PE15A5030</a>	<a href="#">55</a> 20	1 GHz	<a href="#">PE15A1051</a>	<a href="#">54</a> 59	4 GHz	<a href="#">PE15A8000</a>	<a href="#">53</a> 17	18 GHz	<a href="#">PE15A2003</a>	<a href="#">54</a> 38
1 GHz	<a href="#">PE15A5030F</a>	<a href="#">55</a> 21	1 GHz	<a href="#">PE15A1064</a>	<a href="#">54</a> 60	40 GHz	<a href="#">PE15A3901</a>	<a href="#">52</a> 97	2 GHz	<a href="#">PE15A4038</a>	<a href="#">51</a> 15
3 GHz	<a href="#">PE15A3309</a>	<a href="#">52</a> 60	1 GHz	<a href="#">PE15A5031</a>	<a href="#">57</a> 98	60 MHz to:	<a href="#">PE15A4019</a>	<a href="#">56</a> 30	2 GHz	<a href="#">PE15A3015</a>	<a href="#">51</a> 17
500 MHz	<a href="#">PE15A1045</a>	<a href="#">54</a> 46	1 GHz	<a href="#">PE15A5031F</a>	<a href="#">57</a> 99	100 MHz to:	<a href="#">PE15A8004</a>	<a href="#">53</a> 20	2 GHz	<a href="#">PE15A8005</a>	<a href="#">53</a> 21
<b>1.5 MHz to:</b>			1 GHz	<a href="#">PE15A4072</a>	<a href="#">55</a> 25	12 GHz	<a href="#">PE15A3007</a>	<a href="#">51</a> 11	2 GHz	<a href="#">PE15A7001</a>	<a href="#">59</a> 63
100 MHz	<a href="#">PE15A5056</a>	<a href="#">55</a> 23	1.5 GHz	<a href="#">PE15A5057</a>	<a href="#">55</a> 26						
30 MHz	<a href="#">PE15A5055</a>	<a href="#">55</a> 22		<a href="#">PE15A1057</a>	<a href="#">54</a> 61						

Amplifiers

See Our Website For Current Pricing & Real-Time Stock Availability!

# Amplifiers Locator

Amplifiers

See Our Website For Current Pricing & Real-Time Stock Availability!

Frequency	Model No.	Page	C/R
<b>500 MHz to:</b>			
2.5 GHz	<a href="#">PE15A4039</a>	51	18
	<a href="#">PE15A5059</a>	58	42
	<a href="#">PE15A5060</a>	58	43
20 GHz	<a href="#">PE15A3253</a>	52	68
	<a href="#">PE15A1017</a>	54	70
3 GHz	<a href="#">PE15A1018</a>	54	71
	<a href="#">PE15A5032</a>	57	1
	<a href="#">PE15A1068</a>	54	72
4 GHz	<a href="#">PE15A4053</a>	56	35
	<a href="#">PE15A4053F</a>	56	36
	<a href="#">PE15A7002</a>	59	64
	<a href="#">PE15A4037</a>	51	19
<b>6 GHz</b>			
<b>700 MHz to:</b>			
2.2 GHz	<a href="#">PE15A5004</a>	57	2
	<a href="#">PE15A1067</a>	54	73
2.7 GHz	<a href="#">PE15A5033</a>	58	45
	<a href="#">PE15A5033F</a>	58	46
6 GHz	<a href="#">PE15A5017</a>	58	47
<b>800 MHz to:</b>			
1 GHz	<a href="#">PE15A5061</a>	56	37
	<a href="#">PE15A5035F</a>	57	5
2 GHz	<a href="#">PE15A5077</a>	56	38
	<a href="#">PE15A5078</a>	56	39
2.5 GHz	<a href="#">PE15A5020</a>	57	6
	<a href="#">PE15A5034F</a>	56	40
4.2 GHz	<a href="#">PE15A5034</a>	56	41
	<a href="#">PE15A5062</a>	58	48
5.5 GHz	<a href="#">PE15A3264</a>	51	23
960 MHz	<a href="#">PE15A5040</a>	57	3
	<a href="#">PE15A5041</a>	57	4
<b>820 MHz to:</b>			
960 MHz	<a href="#">PE15A4026</a>	56	42
<b>860 MHz to:</b>			
960 MHz	<a href="#">PE15A5042</a>	57	7
	<a href="#">PE15A5039</a>	57	8
<b>900 MHz to:</b>			
1.2 GHz	<a href="#">PE15A63004</a>	55	7
	<a href="#">PE15A63005</a>	55	8
<b>1 GHz to:</b>			
1.4 GHz	<a href="#">PE15A63006</a>	55	9
12 GHz	<a href="#">PE15A1031</a>	54	77
	<a href="#">PE15A3262</a>	51	24
18 GHz	<a href="#">PE15A7009</a>	59	65
	<a href="#">PE15A6002</a>	53	33
2 GHz	<a href="#">PE15A1000</a>	54	74
	<a href="#">PE15A1019</a>	54	75
	<a href="#">PE15A4025</a>	56	43
	<a href="#">PE15A4016</a>	56	44
	<a href="#">PE15A5063</a>	58	49
	<a href="#">PE15A5036F</a>	57	9
	<a href="#">PE15A5036</a>	57	10
2.5 GHz	<a href="#">PE15A5082</a>	57	11
	<a href="#">PE15A5081</a>	57	12
	<a href="#">PE15A5085</a>	56	45
	<a href="#">PE15A5083</a>	56	46
20 GHz	<a href="#">PE15A3500</a>	53	1
	<a href="#">PE15A3512</a>	53	2
	<a href="#">PE15A3513</a>	53	3
23 GHz	<a href="#">PE15A1074</a>	55	11
26.5 GHz	<a href="#">PE15A7010</a>	59	66
3 GHz	<a href="#">PE15A5037</a>	58	13
	<a href="#">PE15A5037F</a>	58	14
4 GHz	<a href="#">PE15A5026</a>	58	50
	<a href="#">PE1519</a>	53	22
40 GHz	<a href="#">PE15A1070</a>	54	76
	<a href="#">PE15A3514</a>	53	4
	<a href="#">PE15A3515</a>	53	5
	<a href="#">PE15A3595</a>	53	6
7 GHz	<a href="#">PE15A7011</a>	59	67
7 GHz	<a href="#">PE15A1075</a>	55	10
<b>1.2 GHz to:</b>			
1.4 GHz	<a href="#">PE15A1023</a>	54	78
	<a href="#">PE15A1024</a>	54	79
	<a href="#">PE15A1005</a>	54	80
1.6 GHz	<a href="#">PE15A5001</a>	58	15
	<a href="#">PE15A1028</a>	54	81
<a href="#">PE15A5064</a>	59	51	

Frequency	Model No.	Page	C/R
<b>1.215 GHz to:</b>			
1.4 GHz	<a href="#">PE15A1039</a>	55	12
	<a href="#">PE15A1040</a>	55	13
<b>1.5 GHz to:</b>			
3.5 GHz	<a href="#">PE15A5005</a>	58	16
5 GHz	<a href="#">PE15A1034</a>	54	82
<b>1.7 GHz to:</b>			
2.4 GHz	<a href="#">PE15A5073</a>	58	17
2.5 GHz	<a href="#">PE15A5015</a>	58	18
<b>1.8 GHz to:</b>			
4.2 GHz	<a href="#">PE15A3276</a>	52	69
<b>2 GHz to:</b>			
12 GHz	<a href="#">PE15A4055</a>	56	51
	<a href="#">PE15A4055F</a>	56	52
18 GHz	<a href="#">PE15A4051</a>	51	32
	<a href="#">PE15A3265</a>	51	33
	<a href="#">PE15A3022</a>	51	34
	<a href="#">PE15A3301</a>	52	72
	<a href="#">PE15A3257</a>	52	73
	<a href="#">PE15A3258</a>	52	74
	<a href="#">PE1524</a>	53	25
	<a href="#">PE15A1030</a>	54	86
	<a href="#">PE15A4056</a>	56	53
	<a href="#">PE15A4056F</a>	56	54
	<a href="#">PE15A4057</a>	56	55
2.6 GHz	<a href="#">PE15A4057F</a>	56	56
	<a href="#">PE15A5068</a>	59	56
20 GHz	<a href="#">PE15A63007</a>	55	14
	<a href="#">PE15A5074</a>	56	47
24 GHz	<a href="#">PE15A4027</a>	51	35
	<a href="#">PE15A4030</a>	51	36
	<a href="#">PE15A3271</a>	52	75
	<a href="#">PE15A3270</a>	52	76
	<a href="#">PE15A4058</a>	56	57
	<a href="#">PE15A4058F</a>	56	58
	<a href="#">PE15A3009</a>	51	37
	<a href="#">PE15A3038</a>	51	38
	<a href="#">PE1520</a>	53	23
	<a href="#">PE15A6015</a>	53	34
4 GHz	<a href="#">PE15A1001</a>	54	83
	<a href="#">PE15A1041</a>	54	84
	<a href="#">PE15A5038</a>	58	19
	<a href="#">PE15A5038F</a>	58	20
4.4 GHz	<a href="#">PE15A4011</a>	56	48
	<a href="#">PE15A4040</a>	51	25
6 GHz	<a href="#">PE15A4041</a>	51	26
	<a href="#">PE15A4003</a>	51	27
	<a href="#">PE15A4005</a>	51	28
	<a href="#">PE15A4042</a>	51	29
	<a href="#">PE15A4043</a>	51	30
	<a href="#">PE15A3503</a>	52	53
	<a href="#">PE1521</a>	53	24
	<a href="#">PE15A6007</a>	53	35
	<a href="#">PE15A2001</a>	54	39
	<a href="#">PE15A1010</a>	54	85
	<a href="#">PE15A5047</a>	58	21
	<a href="#">PE15A5047F</a>	58	22
	<a href="#">PE15A5066</a>	59	52
	<a href="#">PE15A5067</a>	59	53
<a href="#">PE15A5024</a>	59	54	
<a href="#">PE15A5025</a>	59	55	
<a href="#">PE15A7003</a>	59	68	
8 GHz	<a href="#">PE15A3016</a>	51	31
	<a href="#">PE15A3290</a>	52	70
	<a href="#">PE15A3291</a>	52	71
	<a href="#">PE15A6008</a>	53	36
	<a href="#">PE15A4054</a>	56	49
	<a href="#">PE15A4054F</a>	56	50
<a href="#">PE15A7004</a>	59	69	
<b>2.3 GHz to:</b>			
2.7 GHz	<a href="#">PE15A5018</a>	58	23
<b>2.4 GHz to:</b>			
2.5 GHz	<a href="#">PE15B5000</a>	51	3
<b>2.5 GHz to:</b>			
4 GHz	<a href="#">PE15A5006</a>	58	24
<b>2.6 GHz to:</b>			
3.1 GHz	<a href="#">PE15A63008</a>	55	15
	<a href="#">PE15A63009</a>	55	16

Frequency	Model No.	Page	C/R
<b>2.6 GHz to:</b>			
4.2 GHz	<a href="#">PE15A5007</a>	58	25
<b>3 GHz to:</b>			
8 GHz	<a href="#">PE15A1035</a>	54	87
<b>3.1 GHz to:</b>			
3.5 GHz	<a href="#">PE15A4046</a>	51	39
	<a href="#">PE15A63010</a>	55	17
	<a href="#">PE15A63011</a>	55	18
	<a href="#">PE15A1006</a>	55	88
	<a href="#">PE15A5003</a>	58	26
<a href="#">PE15A5002</a>	56	59	
<b>3.5 GHz to:</b>			
7 GHz	<a href="#">PE15A5008</a>	58	27
	<a href="#">PE15A4012</a>	56	60
<b>4 GHz to:</b>			
12 GHz	<a href="#">PE15A7005</a>	59	70
8 GHz	<a href="#">PE1522</a>	53	26
	<a href="#">PE15A1002</a>	55	89
<b>4.4 GHz to:</b>			
4.9 GHz	<a href="#">PE15B5004</a>	51	4
	<a href="#">PE15A5079</a>	56	61
<a href="#">PE15A5080</a>	56	62	
5.1 GHz	<a href="#">PE15B5005</a>	51	5
<b>5 GHz to:</b>			
13 GHz	<a href="#">PE15A1073</a>	55	19
9 GHz	<a href="#">PE15A9002</a>	55	90
<b>5.125 GHz to:</b>			
5.875 GHz	<a href="#">PE15B5006</a>	51	6
<b>5.5 GHz to:</b>			
9.5 GHz	<a href="#">PE15A5009</a>	58	28
<b>6 GHz to:</b>			
10 GHz	<a href="#">PE15A5069</a>	59	57
	<a href="#">PE15A4044</a>	51	40
	<a href="#">PE15A4045</a>	51	41
	<a href="#">PE15A4001</a>	51	42
	<a href="#">PE15A4004</a>	51	43
	<a href="#">PE15A3506</a>	52	54
	<a href="#">PE15A3505</a>	52	55
	<a href="#">PE15A3292</a>	52	77
	<a href="#">PE15A3293</a>	52	78
	<a href="#">PE15A8006</a>	53	27
	<a href="#">PE15A1032</a>	55	91
	<a href="#">PE15A1072</a>	55	92
	<a href="#">PE15A4060</a>	56	63
	<a href="#">PE15A4060F</a>	56	64
	<a href="#">PE15A3018</a>	51	44
	<a href="#">PE15A3019</a>	51	45
	<a href="#">PE15A3017</a>	51	46
<a href="#">PE15A3020</a>	51	47	
<a href="#">PE15A3295</a>	52	79	
<a href="#">PE15A3294</a>	52	80	
<a href="#">PE15A3302</a>	52	81	
<a href="#">PE15A3259</a>	52	82	
<a href="#">PE15A8007</a>	53	28	
<a href="#">PE1523</a>	53	29	
<a href="#">PE15A6012</a>	53	37	
<a href="#">PE15A2004</a>	54	40	
18 GHz	<a href="#">PE15A1071</a>	55	93
	<a href="#">PE15A5050</a>	58	29
	<a href="#">PE15A5050F</a>	58	30
	<a href="#">PE15A5049</a>	58	31
	<a href="#">PE15A5049F</a>	58	32
<a href="#">PE15A4061F</a>	56	65	
<a href="#">PE15A4061</a>	56	66	
<a href="#">PE15A5048</a>	56	67	
<a href="#">PE15A5048F</a>	56	68	
<a href="#">PE15A4062</a>	56	69	
<a href="#">PE15A4062F</a>	56	70	
<a href="#">PE15A5070</a>	59	58	
<a href="#">PE15A7006</a>	59	71	
<b>6.4 GHz to:</b>			
7.1 GHz	<a href="#">PE15A5016</a>	59	59
<b>7 GHz to:</b>			
11 GHz	<a href="#">PE15A1033</a>	55	94
17 GHz	<a href="#">PE15A3273</a>	52	83
<b>7.5 GHz to:</b>			
11 GHz	<a href="#">PE15A4013</a>	56	71

Frequency	Model No.	Page	C/R
<b>8 GHz to:</b>			
11 GHz	<a href="#">PE15A4014</a>	56	72
	<a href="#">PE15A4015</a>	56	73
	<a href="#">PE15A1027</a>	55	95
12 GHz	<a href="#">PE15A1026</a>	55	96
	<a href="#">PE15A1003M</a>	55	97
	<a href="#">PE15A1003</a>	55	98
	<a href="#">PE15A1025</a>	55	99
	<a href="#">PE15A5053</a>	58	33
	<a href="#">PE15A5053F</a>	58	34
	<a href="#">PE15A5052</a>	58	35
	<a href="#">PE15A5051</a>	56	74
	<a href="#">PE15A5051F</a>	56	75
	<a href="#">PE15A4008</a>	57	76
	<a href="#">PE15A5071</a>	59	60
12.4 GHz	<a href="#">PE15A5072</a>	59	61
	<a href="#">PE15A4063F</a>	57	77
<a href="#">PE15A4063</a>	57	78	
<b>8.5 GHz to:</b>			
10.5 GHz	<a href="#">PE15A5044</a>	58	36
	<a href="#">PE15A5043</a>	58	37
11 GHz	<a href="#">PE15A4006</a>	57	79
	<a href="#">PE15A4007</a>	57	80
<b>12 GHz to:</b>			
18 GHz	<a href="#">PE15A4002</a>	51	48
	<a href="#">PE15A3507</a>	52	56
	<a href="#">PE15A3296</a>	52	84
<a href="#">PE15A1004</a>	55	1	
<b>12.4 GHz to:</b>			
26.5 GHz	<a href="#">PE15A3024</a>	51	49
<b>14.4 GHz to:</b>			
15.4 GHz	<a href="#">PE15A5021</a>	57	81
<b>17 GHz to:</b>			
24 GHz	<a href="#">PE15A4028</a>	51	50
27 GHz	<a href="#">PE15A3274</a>	52	85
<b>17.5 GHz to:</b>			
21.5 GHz	<a href="#">PE15A4020</a>	58	38
<b>18 GHz to:</b>			
26.5 GHz	<a href="#">PE15A3303</a>	52	86
	<a href="#">PE15A3260</a>	52	87
	<a href="#">PE15A4064</a>	57	82
	<a href="#">PE15A4064F</a>	57	83
	<a href="#">PE15A4021</a>	57	84
	<a href="#">PE15A5054</a>	57	85
	<a href="#">PE15A5054F</a>	57	86
	<a href="#">PE15A7007</a>	59	72
	<a href="#">PE15A3025</a>	51	51
	<a href="#">PE15A3268</a>	52	88
40 GHz	<a href="#">PE15A3304</a>	52	89
	<a href="#">PE15A3305</a>	52	90
	<a href="#">PE15A4065</a>	57	87
	<a href="#">PE15A4065F</a>	57	88
	<a href="#">PE15A7012</a>	59	73
<b>20 GHz to:</b>			
40 GHz	<a href="#">PE15A3508</a>	53	7
	<a href="#">PE15A3509</a>	53	8
	<a href="#">PE15A3510</a>	53	9
	<a href="#">PE15A3511</a>	53	10
<b>26.5 GHz to:</b>			
40 GHz	<a href="#">PE15A4022</a>	51	52
	<a href="#">PE15A3261</a>	52	91
	<a href="#">PE15A3266</a>	52	92
	<a href="#">PE15A3306</a>	52	93
	<a href="#">PE15A3307</a>	52	94
	<a href="#">PE15A3300</a>	55	2
	<a href="#">PE15A4050</a>	57	89
	<a href="#">PE15A4067</a>	57	90
	<a href="#">PE15A4067F</a>	57	91
	<a href="#">PE15A7008</a>	59	74
<b>29 GHz to:</b>			
36 GHz	<a href="#">PE15A3275</a>	52	95
<b>30 GHz to:</b>			
40 GHz	<a href="#">PE15A4069</a>	57	92
	<a href="#">PE15A4069F</a>	57	93

## BI-DIRECTIONAL AMPLIFIERS



Amplifier Type	Frequency Band (GHz.)	Tx Gain (dB)	Gain Var. ±(dB)	P1dB (W) Linear (dBm)	Rx P1dB (dBm)	Rx NF (dB)	DC Power		ECCN	Model No	Power (W)				ROW
							Tx (V/mA)				1	2-4	5-9	10+	
Bi Directional, High Power	30 MHz - 2.7	36	2			2	12/1,400	EAR99	<a href="#">PE15B5003</a>	\$7,342.43	\$6,901.88	\$6,534.76	\$6,241.07	1	
Bi Directional	225 MHz - 512 MHz						28/1,600	5A991.G	<a href="#">PE15B5007</a>	\$13,456.59	\$12,918.33	\$12,380.06	\$11,841.80	2	
Bi Directional, High Power, High Rel	2.4 - 2.5	20	0.5	0.1	20	2.5	28/	EAR99	<a href="#">PE15B5000</a>	\$6,786.20	\$6,514.75	\$6,243.30	\$5,971.86	3	
Bi Directional	4.4 - 4.9	45	1			3.5	28/4,600	5A991.G	<a href="#">PE15B5004</a>	\$17,919.10	\$17,202.34	\$16,485.57	\$15,768.81	4	
	4.4 - 5.1	10					28/1,750	EAR99	<a href="#">PE15B5005</a>	\$15,409.38	\$14,793.00	\$14,176.63	\$13,560.25	5	
	5.125 - 5.875	43					1.25	28/2,500	EAR99	<a href="#">PE15B5006</a>	\$15,346.46	\$14,732.60	\$14,118.74	\$13,504.88	6

Amplifiers

## BROADBAND AMPLIFIERS



Amplifier Type	Frequency Band (GHz.)	Gain (dB)	Gain Var. ±(dB)	NF (dB)	P1dB (dBm)	Pstat (dBm)	DC Power		ECCN	Model No	Power (W)				ROW			
							V/mA				1	2-4	5-9	10+				
Broadband, High Rel	10 MHz - 6	24	0.75	5	29.5		15/740	EAR99	<a href="#">PE15A4032</a>	\$6,560.18	\$6,297.77	\$6,035.37	\$5,772.96	7				
	10 MHz - 15	12	0.3	4.5	28	29	14/360	EAR99	<a href="#">PE15A3036</a>	\$6,945.03	\$6,667.23	\$6,389.43	\$6,111.63	8				
	10 MHz - 20	13	0.75	3	23	25	15/225	EAR99	<a href="#">PE15A4029</a>	\$5,341.82	\$5,128.15	\$4,914.47	\$4,700.80	9				
Broadband	30 MHz - 40	25	2.5	6	20		11/400	EAR99	<a href="#">PE15A3023</a>	\$9,148.43	\$8,782.49	\$8,416.56	\$8,050.62	10				
	100 MHz - 12	18	1	3	25	28	12/300	EAR99	<a href="#">PE15A3007</a>	\$2,427.27	\$2,330.18	\$2,233.09	\$2,136.00	11				
	110 MHz - 6	11	1.25	6.5	27	30	12/300	EAR99	<a href="#">PE15A3004</a>	\$2,552.07	\$2,449.99	\$2,347.90	\$2,245.82	12				
	110 MHz - 10	10	1.5				12/300	EAR99	<a href="#">PE15A3001</a>	\$2,865.04	\$2,750.44	\$2,635.84	\$2,521.24	13				
Broadband, High Rel	300 MHz - 18	37	2		30.5		15/750	EAR99	<a href="#">PE15A3021</a>	\$5,877.79	\$5,642.68	\$5,407.57	\$5,172.46	14				
		14	0.4				12/180	EAR99	<a href="#">PE15A4038</a>	\$1,073.26	\$1,030.33	\$987.40	\$944.47	15				
	500 MHz - 2	30	0.6	2.7	24		12/240	EAR99	<a href="#">PE15A3014</a>	\$1,193.18	\$1,145.45	\$1,097.73	\$1,050.00	16				
	46	0.8	12/300	EAR99			<a href="#">PE15A3015</a>	\$1,433.65	\$1,376.30	\$1,318.96	\$1,261.61	17						
Broadband	500 MHz - 2.5	24	0.5	3.5	33	33	12/240	EAR99	<a href="#">PE15A4039</a>	\$1,358.18	\$1,303.85	\$1,249.53	\$1,195.20	18				
	500 MHz - 10	32	1	28/600			EAR99	<a href="#">PE15A4037</a>	\$4,579.26	\$4,396.09	\$4,212.92	\$4,029.75	19					
	500 MHz - 18	27	2.5	3	25	12/375	EAR99	<a href="#">PE15A3005</a>	\$2,871.90	\$2,757.02	\$2,642.15	\$2,527.27	20					
Broadband, High Rel	500 MHz - 18	33	1.5	4	15	20	12/330	EAR99	<a href="#">PE15A3008</a>	\$3,360.29	\$3,242.68	\$3,125.07	\$3,024.26	21				
		27	1.5	4	15		12/220	EAR99	<a href="#">PE15A3263</a>	\$2,577.15	\$2,474.06	\$2,370.98	\$2,267.89	22				
	800 MHz - 5.5	20	0.5		25	28	12/750	EAR99	<a href="#">PE15A3264</a>	\$1,642.96	\$1,577.24	\$1,511.52	\$1,445.80	23				
		30	1.5				19	20	12/240	EAR99	<a href="#">PE15A3262</a>	\$3,080.90	\$2,957.66	\$2,834.43	\$2,711.19	24		
	2 - 6	13	0.4	5.4	23		12/180	EAR99	<a href="#">PE15A4040</a>	\$1,629.29	\$1,564.12	\$1,498.95	\$1,433.78	25				
			22				0.6	12/420	EAR99	<a href="#">PE15A4041</a>	\$2,339.46	\$2,245.88	\$2,152.30	\$2,058.72	26			
		32	1	5	30		15/1,700	EAR99	<a href="#">PE15A4003</a>	\$3,990.31	\$3,830.70	\$3,671.09	\$3,511.47	27				
		33					12/1,000	EAR99	<a href="#">PE15A4005</a>	\$3,321.30	\$3,188.45	\$3,055.60	\$2,922.74	28				
		36	1.5	6	34		15/2,200	EAR99	<a href="#">PE15A4042</a>	\$3,863.74	\$3,709.19	\$3,554.64	\$3,400.09	29				
							44	1	4.5	35	12/4,200	EAR99	<a href="#">PE15A4043</a>	\$4,461.15	\$4,282.70	\$4,104.26	\$3,925.81	30
2 - 8	33		29.4			8.5/941	EAR99	<a href="#">PE15A3016</a>	\$2,769.87	\$2,659.08	\$2,548.28	\$2,437.49	31					
12	16					12/65	EAR99	<a href="#">PE15A4051</a>	\$1,705.14	\$1,636.93	\$1,568.73	\$1,500.52	32					
Broadband, High Rel	2 - 18	33	1.5	3.5	13		12/180	EAR99	<a href="#">PE15A3265</a>	\$2,647.63	\$2,541.72	\$2,435.82	\$2,329.91	33				
Broadband	2 - 20	37			30.5		15/800	EAR99	<a href="#">PE15A3022</a>	\$5,550.00	\$5,328.00	\$5,106.00	\$4,884.00	34				
Broadband, High Rel		15					0.75	3	26		12/310	EAR99	<a href="#">PE15A4027</a>	\$6,258.74	\$6,008.39	\$5,758.04	\$5,507.69	35
Broadband		31									15/400	EAR99	<a href="#">PE15A4030</a>	\$4,099.83	\$3,935.84	\$3,771.84	\$3,607.85	36
Broadband	2 - 24	12	0.4	4	18	18.5	12/260	EAR99	<a href="#">PE15A3009</a>	\$2,218.54	\$2,140.89	\$2,063.24	\$1,996.69	37				
Broadband, High Rel	2 - 35						30	0.7	4.5	30	16/	3A001, B.4.C	<a href="#">PE15A3038</a>	\$7,509.75	\$7,209.36	\$6,908.97	\$6,608.58	38
Broadband, High Rel	3.1 - 3.5	16	0.6	5	27		12/900	EAR99	<a href="#">PE15A4046</a>	\$2,527.61	\$2,426.51	\$2,325.40	\$2,224.30	39				
		28	0.8				12/400	EAR99	<a href="#">PE15A4044</a>	\$2,146.52	\$2,060.66	\$1,974.80	\$1,888.94	40				
	6 - 12	12	500	EAR99	<a href="#">PE15A4045</a>	\$2,565.46	\$2,462.84	\$2,360.22	\$2,257.60	41								
		37	1.5	6	33	15/2,500	EAR99	<a href="#">PE15A4001</a>	\$3,849.56	\$3,695.58	\$3,541.60	\$3,387.61	42					
	6 - 18	38	1	5	30		15/1,300	EAR99	<a href="#">PE15A4004</a>	\$3,646.51	\$3,500.65	\$3,354.79	\$3,208.93	43				
		30					1.5	3.5	28	12/1,300	EAR99	<a href="#">PE15A3018</a>	\$3,243.78	\$3,114.03	\$2,984.28	\$2,854.53	44	
		36	2	5.4	27		18/1,700	EAR99	<a href="#">PE15A3019</a>	\$4,117.53	\$3,952.83	\$3,788.13	\$3,623.43	45				
		42					15/800	EAR99	<a href="#">PE15A3017</a>	\$3,489.75	\$3,350.16	\$3,210.57	\$3,070.98	46				
	12 - 18	33	6	30	12/900	EAR99	<a href="#">PE15A3020</a>	\$3,439.61	\$3,302.03	\$3,164.44	\$3,026.86	47						
	Broadband	12.4 - 26.5	35		3	24.5		15/2,000	EAR99	<a href="#">PE15A4002</a>	\$3,933.34	\$3,776.01	\$3,618.67	\$3,461.34	48			
Broadband, High Rel	17 - 24	22	24					12/500	EAR99	<a href="#">PE15A3024</a>	\$7,927.58	\$7,610.48	\$7,293.37	\$6,976.27	49			
Broadband	18 - 40	30	2.5	6.5	20		12/350	EAR99	<a href="#">PE15A3025</a>	\$6,853.53	\$6,579.39	\$6,305.25	\$6,031.11	51				
			2	6			12/350	EAR99	<a href="#">PE15A4022</a>	\$5,723.70	\$5,494.75	\$5,265.80	\$5,036.86	52				

See Our Website For Current Pricing & Real-Time Stock Availability!



## BROADBAND AMPLIFIERS



Amplifiers

Amplifier Type	Frequency Band (GHz.)	Gain (dB)	Gain Var. ±(dB)	NF (dB)	P1dB (dBm)	Psat (dBm)	DC Power (V/mA)	ECCN	Model No	1 Pc. Price	See Web for Volume Pricing	ROW
High Gain, High Rel	2 - 6	44	1	5	30	24	15/1,050	EAR99	<a href="#">PE15A3503</a>	\$3,212.43	See Web for Volume Pricing	53
	6 - 12	47	1.5	6	33		15/2,500	EAR99	<a href="#">PE15A3506</a>	\$4,146.29		54
		48	1	5	30		15/1,350	EAR99	<a href="#">PE15A3505</a>	\$3,492.58		55
	12 - 18	43	2	6	30		15/2,000	EAR99	<a href="#">PE15A3507</a>	\$3,925.62		56
Low Noise	0.01 MHz - 3	16	1.5	4	12	18	15/47	EAR99	<a href="#">PE15A3308</a>	\$784.33	See Web for Volume Pricing	57
	0.1 MHz - 10	33	6.5	5	13		12/110	EAR99	<a href="#">PE15A3311</a>	\$985.02		58
	0.3 MHz - 6.5	39	4.5	4	17		12/120	EAR99	<a href="#">PE15A3310</a>	\$950.74		59
	1 MHz - 3	21	1.5	2	22		15/110	EAR99	<a href="#">PE15A3309</a>	\$920.55		60
	10 MHz - 6	34	1	14.5	14.5		12/130	EAR99	<a href="#">PE15A3269</a>	\$663.13		61
Low Noise, High Rel	10 MHz - 20	15	0.5	3	22	24	12/195	EAR99	<a href="#">PE15A3272</a>	\$5,633.24	See Web for Volume Pricing	62
	30 MHz - 20		2.5	20	15/180		EAR99	<a href="#">PE15A3254</a>	\$3,444.54	63		
	30 MHz - 26.5		2	5.5	15/230		EAR99	<a href="#">PE15A3312</a>	\$3,416.18	64		
Low Noise	100 MHz - 18	14	1.5	3	16	18	12/80	EAR99	<a href="#">PE15A3255</a>	\$1,462.83	See Web for Volume Pricing	65
		28	2.5	3	16		12/160	EAR99	<a href="#">PE15A3256</a>	\$2,991.79		66
Low Noise, High Rel	100 MHz - 26.5	15	2	5	15	17.5	15/200	EAR99	<a href="#">PE15A3267</a>	\$5,414.68	See Web for Volume Pricing	67
	500 MHz - 20	14	1.75	3	14		15/75	EAR99	<a href="#">PE15A3253</a>	\$2,925.19		68
		1.8 - 4.2	26		1.2		15.5	12/105	EAR99	<a href="#">PE15A3276</a>		\$6,609.47
	2 - 8	14		2.5	13		12/120	EAR99	<a href="#">PE15A3290</a>	\$1,788.79		70
Low Noise	2 - 18	30	2.5	3.2	14	21	12/150	EAR99	<a href="#">PE15A3291</a>	\$2,263.64	See Web for Volume Pricing	71
		22	2	3			12/100	EAR99	<a href="#">PE15A3301</a>	\$5,609.59		72
		26	2	3			12/150	EAR99	<a href="#">PE15A3257</a>	\$1,892.38		73
		33	1	3			12/180	EAR99	<a href="#">PE15A3258</a>	\$2,332.82		74
		13	0.5	2			16	12/	EAR99	<a href="#">PE15A3271</a>		\$3,887.73
Low Noise, High Rel	2 - 20	15			13	15.5	12/78	EAR99	<a href="#">PE15A3270</a>	\$4,654.12	See Web for Volume Pricing	76
		17		2.5	7	12/100	EAR99	<a href="#">PE15A3292</a>	\$2,094.81	77		
		30				12/200	EAR99	<a href="#">PE15A3293</a>	\$2,414.53	78		
Low Noise	6 - 18	14		3	13	15	12/100	EAR99	<a href="#">PE15A3295</a>	\$2,003.44	See Web for Volume Pricing	79
		30		2.5	10		12/200	EAR99	<a href="#">PE15A3294</a>	\$2,637.91		80
		32	1.5	2.3	14		12/150	EAR99	<a href="#">PE15A3302</a>	\$5,473.63		81
		38	2	2.5	22		12/280	EAR99	<a href="#">PE15A3259</a>	\$1,687.09		82
		22		2.5	14		12/93	EAR99	<a href="#">PE15A3273</a>	\$3,887.73		83
Low Noise, High Rel	7 - 17	22		3.5	13	15	12/100	EAR99	<a href="#">PE15A3296</a>	\$1,931.87	See Web for Volume Pricing	84
	12 - 18	18		2.75	13.5		12/96	EAR99	<a href="#">PE15A3274</a>	\$5,934.97		85
	17 - 27	19					12/250	EAR99	<a href="#">PE15A3303</a>	\$6,117.59		86
Low Noise	18 - 26.5	32	2.5	2.3	11	15	12/150	EAR99	<a href="#">PE15A3260</a>	\$2,264.71	See Web for Volume Pricing	87
		40		2.5	13		12/150	EAR99	<a href="#">PE15A3260</a>	\$2,264.71		88
Low Noise, High Rel	18 - 40	18	2	5.5	10	15	15/250	3A001. B.4.C	<a href="#">PE15A3268</a>	\$7,925.95	See Web for Volume Pricing	89
		32			12		12/200	EAR99	<a href="#">PE15A3304</a>	\$9,312.34		90
Low Noise	26.5 - 40	44	4	4	11	15	12/250	EAR99	<a href="#">PE15A3305</a>	\$10,281.84	See Web for Volume Pricing	91
		22	1	3.5	13.5		12/125	EAR99	<a href="#">PE15A3261</a>	\$2,080.02		92
		30	2	2	11		12/150	EAR99	<a href="#">PE15A3266</a>	\$5,974.85		93
		35	2.5	2.4	10.5		12/150	EAR99	<a href="#">PE15A3306</a>	\$8,410.80		94
		52	3.5	3.3	12		12/375	EAR99	<a href="#">PE15A3307</a>	\$10,178.08		95
Low Noise, High Rel	29 - 36	20		2.9	11		3/80	EAR99	<a href="#">PE15A3275</a>	\$3,945.93	See Web for Volume Pricing	95

## USB CONTROLLED BROADBAND AMPS.



Amplifier Type	Frequency Band (GHz.)	Gain (dB)	NF (dB)	P1dB (dBm)	Control	ECCN	Model No	1	2-4	5-9	10+	ROW
USB	50 MHz - 18	12	4.5	10	USB	EAR99	<a href="#">PE15A3900</a>	\$3,364.41	\$3,229.83	\$3,095.26	\$2,960.68	96
	50 MHz - 40		5				<a href="#">PE15A3901</a>	\$5,554.22	\$5,332.05	\$5,109.88	\$4,887.71	97

## BENCH-TOP AMPLIFIERS



Amplifier Type	Frequency Band (GHz.)	Gain (dB)	Gain Var. ±(dB)	NF (dB)	P1dB (dBm)	DC Power (Optional DC In) (V)	AC Power (V/Cycle)	ECCN	Model No	1	2-4	5-9	10+	ROW
Broadband, High Rel	10 MHz - 15	12	0.3	4	28	16/360		EAR99	<a href="#">PE15A3037</a>	\$6,762.00	\$6,491.52	\$6,221.04	\$5,950.56	98

See Our Website For Current Pricing & Real-Time Stock Availability!

## BENCH-TOP AMPLIFIERS



Amplifier Type	Frequency Band (GHz.)	Gain (dB)	Gain Var. ±(dB)	NF (dB)	P1dB (dBm)	DC Power (Optional DC In) (V)	AC Power (V/Cycle)	ECCN	Model No	1	2-4	5-9	10+	ROW
High Gain, High Rel	1 - 20	60	3	5	10		115/60	EAR99	<a href="#">PE15A3500</a>	\$13,056.69	\$12,534.42	\$12,012.15	\$11,489.89	1
							100/	EAR99	<a href="#">PE15A3512</a>	\$11,787.62	\$11,316.12	\$10,844.61	\$10,373.11	2
	220/	EAR99	<a href="#">PE15A3513</a>				\$12,524.34	\$12,023.37	\$11,522.39	\$11,021.42	3			
	100/	EAR99	<a href="#">PE15A3514</a>				\$16,080.66	\$15,437.43	\$14,794.21	\$14,150.98	4			
	1 - 40	40	2.5		12/	220/	EAR99	<a href="#">PE15A3515</a>	\$16,080.66	\$15,437.43	\$14,794.21	\$14,150.98	5	
						120/60	EAR99	<a href="#">PE15A3595</a>	\$16,731.16	\$16,145.57	\$15,559.98	\$15,058.04	6	
	20 - 40	30	2		10	100/60	EAR99	<a href="#">PE15A3508</a>	\$12,321.03	\$11,828.19	\$11,335.35	\$10,842.51	7	
						220/	EAR99	<a href="#">PE15A3509</a>	\$12,321.03	\$11,828.19	\$11,335.35	\$10,842.51	8	
						100/	EAR99	<a href="#">PE15A3510</a>	\$15,007.40	\$14,407.10	\$13,806.81	\$13,206.51	9	
						220/	EAR99	<a href="#">PE15A3511</a>	\$15,007.40	\$14,407.10	\$13,806.81	\$13,206.51	10	

## GAIN BLOCK AMPLIFIERS



Amplifier Type	Frequency Band (GHz.)	Gain (dB)	Gain Var. ±(dB)	NF (dB)	P1dB (dBm)	IP3 (dBm)	DC Power (V/mA)	ECCN	Model No	1 Pc. Price	See Web for Volume Pricing	ROW	
Gain Block	10 MHz - 3	12	10	5.5	10		15/40	EAR99	<a href="#">PE1514</a>	\$489.79	See Web for Volume Pricing	11	
		15	2	3	11	12	18/40	EAR99	<a href="#">PE1528</a>	\$160.93		12	
		20	14	2.7	13		15/50	EAR99	<a href="#">PE1513</a>	\$485.91		13	
	10 MHz - 6	15	0.35	4.5		26	12/50	EAR99	<a href="#">PE15A8001</a>	\$753.78		14	
	50 MHz - 1	22	0.75		12		12/150	EAR99	<a href="#">PE1517</a>	\$531.64		15	
	50 MHz - 2						12/150	EAR99	<a href="#">PE1518</a>	\$663.80		16	
	50 MHz - 4	26	1		5	22	35	12/120	EAR99	<a href="#">PE15A8000</a>		\$849.81	17
	100 MHz - 3	18	18		6	16		15/120	EAR99	<a href="#">PE1516</a>		\$564.00	18
Gain Block, High Rel	200 MHz - 2.5	22	1.25		15		15/120	EAR99	<a href="#">PE1525</a>	\$562.28	19		
		17	0.4	1.8		25	12/70	EAR99	<a href="#">PE15A8004</a>	\$965.94	20		
Gain Block	500 MHz - 2	50	1.8				12/180	EAR99	<a href="#">PE15A8005</a>	\$1,282.73	21		
		26		2.5	15		12/120	EAR99	<a href="#">PE1519</a>	\$1,045.47	22		
	2 - 4	25	0.5				12/120	EAR99	<a href="#">PE1520</a>	\$1,086.20	23		
	2 - 6	26		3			12/120	EAR99	<a href="#">PE1521</a>	\$917.09	24		
	2 - 18	23	1	3.5	13		12/150	EAR99	<a href="#">PE1524</a>	\$1,313.73	25		
Gain Block, High Rel	4 - 8	26	0.5	3	15		12/100	EAR99	<a href="#">PE1522</a>	\$1,126.13	26		
		6 - 12	12	0.4	2.3	10	20	12/80	EAR99	<a href="#">PE15A8006</a>	\$1,433.65	27	
Gain Block	6 - 18	17	0.6		20		12/160	EAR99	<a href="#">PE15A8007</a>	\$1,999.56	28		
		22	1	4.5	13		12/150	EAR99	<a href="#">PE1523</a>	\$1,493.50	29		

## DC COUPLED AMPLIFIERS



Amplifier Type	Frequency Band (GHz.)	Gain (dB)	Gain Var. ±(dB)	NF (dB)	P1dB (dBm)	IP3 (dBm)	DC Power (V/mA)	ECCN	Model No	1-4	5-9	10-24	25+	ROW
DC Coupled	DC - 17 MHz	30			14		/45	EAR99	<a href="#">PE15A86002</a>	\$637.59	\$605.71	\$573.83	\$548.33	30
	DC - 1.5	14			11	25	/45	EAR99	<a href="#">PE15A86001</a>	\$920.55	\$874.52	\$828.50	\$791.67	31
	DC - 2	8		16			12/45	EAR99	<a href="#">PE15A86000</a>	\$885.99	\$841.69	\$797.39	\$761.95	32

## LIMITING AMPLIFIERS



Amplifier Type	Frequency Band (GHz.)	Gain (dB)	Gain Var. ±(dB)	NF (dB)	Input Power (dBm)	Psat (dBm)	DC Power (V/mA)	ECCN	Model No	1	2-4	5-9	10+	ROW
Limitings, High Rel	1 - 2	60	3	3	-40 to 10	19	13/250	EAR99	<a href="#">PE15A6002</a>	\$2,421.09	\$2,324.25	\$2,227.40	\$2,130.56	33
	2 - 4	40			-20 to 10		15/200	EAR99	<a href="#">PE15A6015</a>	\$2,468.50	\$2,369.76	\$2,271.02	\$2,172.28	34
	2 - 6	80	3		4	-61 to 10	15	13/550	EAR99	<a href="#">PE15A6007</a>	\$3,103.42	\$2,979.28	\$2,855.15	\$2,731.01
	2 - 8	40	2	5	-20 to 20	19	13/300	EAR99	<a href="#">PE15A6008</a>	\$2,386.50	\$2,291.04	\$2,195.58	\$2,100.12	36
	6 - 18			4			13/300	EAR99	<a href="#">PE15A6012</a>	\$2,905.00	\$2,788.80	\$2,672.60	\$2,556.40	37



Technical Support  
+1 (949) 261-1920



Same-Day Shipping,  
Even Custom  
Cable Assemblies

Amplifiers

See Our Website For Current Pricing & Real-Time Stock Availability!

## LOG AMPLIFIERS



Amplifiers

Amplifier Type	Frequency Band (GHz.)	Typ Recovery Time (ns)	Min TSS (dBm)	Log Linearity ± (dB)	Log Range (dBm)	Rise Time (ns)	Log Slope (mV/dB)	ECCN	Model No	1	2-4	5-9	10+	ROW
Log, High Rel	500 MHz - 18	150	-65	1.75	-65 to 5	20	20	EAR99	<a href="#">PE15A2003</a>	\$17,303.47	\$16,611.33	\$15,919.19	\$15,227.05	38
	2 - 6	60	-73		-70 to 5	15	40	EAR99	<a href="#">PE15A2001</a>	\$11,009.25	\$10,568.88	\$10,128.51	\$9,688.14	39
	6 - 18	150	-40	1	-40 to 0	20	50	EAR99	<a href="#">PE15A2004</a>	\$8,118.03	\$7,793.31	\$7,468.59	\$7,143.87	40

## LOW NOISE AMPLIFIERS

### Standard



Amplifier Type	Frequency Band (GHz.)	Gain (dB)	Gain Var. ±(dB)	NF (dB)	P1dB (dBm)	IP3 (dBm)	DC Power (V/mA)	ECCN	Model No	1 Pc. Price	See Web for Volume Pricing	ROW
Low Noise	0.009 MHz - 3	32	1.25	2.5	16	29	15/110	EAR99	<a href="#">PE15A1007</a>	\$457.08	See Web for Volume Pricing	41
	0.01 MHz - 500 MHz	45	0.5		11	23	16/75	EAR99	<a href="#">PE15A1046</a>	\$719.51		42
	0.01 MHz - 1.4	42	1	3	19	32	16/120	EAR99	<a href="#">PE15A1055</a>	\$836.76		43
	0.01 MHz - 2	28	2	3.2	13	23	18/45	EAR99	<a href="#">PE15A1059</a>	\$606.34		44
	0.03 MHz - 600 MHz	50	1.2	2.2	14	24	18/85	EAR99	<a href="#">PE15A1047</a>	\$909.51		45
	1 MHz - 500 MHz	33.5	1.5	2	13		30/40	EAR99	<a href="#">PE15A1045</a>	\$606.34		46
	10 MHz - 250 MHz	17	0.5	1.4	22	39	5.25/160	EAR99	<a href="#">PE15A1043</a>	\$836.76		47
	10 MHz - 550 MHz	29.7	0.3	1.7	19	34	15/105	EAR99	<a href="#">PE15A1044</a>	\$759.96		48
	10 MHz - 600 MHz	40.5	0.8	0.9		30	15/140	EAR99	<a href="#">PE15A1063</a>	\$1,216.71		49
	10 MHz - 800 MHz	42	0.7	2	17	30	15/100	EAR99	<a href="#">PE15A1048</a>	\$720.63		50
	60	1.5	2.1	27		15/160	EAR99	<a href="#">PE15A1065</a>	\$1,358.18	51		
High Gain	10 MHz - 1	30	0.7	1			15/110	EAR99	<a href="#">PE15A1011</a>	\$502.39	52	
		32		2	12	23	15/40	EAR99	<a href="#">PE15A1049</a>	\$540.47	53	
		40	1	0.8	17	31.5	15/110	EAR99	<a href="#">PE15A1012</a>	\$481.12	54	
		50	1.25	1	18	28	15/140	EAR99	<a href="#">PE15A1013</a>	\$569.87	55	
		51	0.8	2.2	13	22	15/88	EAR99	<a href="#">PE15A1052</a>	\$824.41	56	
Low Noise	10 MHz - 1.3	35	0.5	1.5	20	34	15/165	EAR99	<a href="#">PE15A1054</a>	\$990.35	57	
	10 MHz - 3	34	0.75	1.4	11	25	15/95	EAR99	<a href="#">PE15A1009</a>	\$738.40	58	
	20 MHz - 1	30	0.5	1.3	18	32	18/140	EAR99	<a href="#">PE15A1051</a>	\$793.47	59	
	20 MHz - 1.5	30.5	0.8		19	34	15/140	EAR99	<a href="#">PE15A1064</a>	\$1,216.71	60	
	20 MHz - 3	20	1.2	1	17	35	18/70	EAR99	<a href="#">PE15A1057</a>	\$719.51	61	
	20 MHz - 4	25	0.75	1.6	13.5	25	15/75	EAR99	<a href="#">PE15A1008</a>	\$685.54	62	
	40 MHz - 3	16	1.6	1.3	7	22	3.3/18	EAR99	<a href="#">PE15A1060</a>	\$731.43	63	
	50 MHz - 1	18	0.5	1	16	32	18/70	EAR99	<a href="#">PE15A1050</a>	\$682.29	64	
		19			18	36	12/90	EAR99	<a href="#">PE15A1014</a>	\$303.05	65	
	50 MHz - 1.2	47	1	2.2	13	23	15/88	EAR99	<a href="#">PE15A1053</a>	\$836.76	66	
	50 MHz - 2	27	0.75	1.8	22	37	13.5/160	EAR99	<a href="#">PE15A1042</a>	\$692.87	67	
	100 MHz - 2	61.5	1	2.5	19	33	15/170	EAR99	<a href="#">PE15A1066</a>	\$1,483.48	68	
	500 MHz - 3	14.5	0.4	2	20	35	12/90	EAR99	<a href="#">PE15A1017</a>	\$354.50	69	
	500 MHz - 4	29	1	2.6		34	12/190	EAR99	<a href="#">PE15A1018</a>	\$448.62	70	
	700 MHz - 2.7	23	2.5	0.7	17	35	15/65	EAR99	<a href="#">PE15A1068</a>	\$836.76	71	
			18		15/65		EAR99	<a href="#">PE15A1067</a>	\$836.76	72		
Low Noise, High Rel	1 - 2	35	1	1.5	10		13/200	EAR99	<a href="#">PE15A1000</a>	\$1,332.30	73	
High Gain		40		0.8	11	25	12/120	EAR99	<a href="#">PE15A1019</a>	\$1,059.33	74	
Low Noise	1 - 4	20	1.2	20	41	15/120	EAR99	<a href="#">PE15A1070</a>	\$836.76	75		
Low Noise, High Rel	1 - 12	16	1.75	1.5	10		6/60	EAR99	<a href="#">PE15A1031</a>	\$5,588.46	76	
		25					13.2/150	EAR99	<a href="#">PE15A1023</a>	\$632.48	77	
		35					13.2/180	EAR99	<a href="#">PE15A1024</a>	\$709.12	78	
High Gain, High Rel	1.2 - 1.4	40	0.75	1.5	15		13.2/200	EAR99	<a href="#">PE15A1005</a>	\$1,180.72	79	
Low Noise		1.2 - 1.6				0.5	0.8	12	15/100	EAR99	<a href="#">PE15A1028</a>	\$679.09
Low Phase Noise, High Rel	1.5 - 5	14		4.5	17	27	9/170	EAR99	<a href="#">PE15A1034</a>	\$6,101.05	81	
Low Noise, High Rel	2 - 4	38	1	2	13		13/200	EAR99	<a href="#">PE15A1001</a>	\$1,589.37	82	
Low Noise		40				0.7	14	15/100	EAR99	<a href="#">PE15A1041</a>	\$1,073.26	83
High Gain	2 - 6			0.9	14	25	15/110	EAR99	<a href="#">PE15A1010</a>	\$1,086.68	84	
Low Phase Noise, High Rel	2 - 18	12.5		6.5	13		5/80	EAR99	<a href="#">PE15A1030</a>	\$10,151.46	85	
	3 - 8	11		6	14	25	7/250	EAR99	<a href="#">PE15A1035</a>	\$6,101.05	86	
											87	

See Our Website For Current Pricing & Real-Time Stock Availability!

## Standard



Amplifier Type	Frequency Band (GHz.)	Gain (dB)	Gain Var. ±(dB)	NF (dB)	P1dB (dBm)	IP3 (dBm)	DC Power (V/mA)	ECCN	Model No	1	2-4	5-9	10+	ROW
High Gain, High Rel	3.1 - 3.5	40	0.3	1.1	15		17/150	EAR99	<a href="#">PE15A1006</a>	\$1,953.88	\$1,875.72	\$1,797.57	\$1,719.41	88
Low Noise, High Rel	4 - 8	38	1	2	13		13/250	EAR99	<a href="#">PE15A1002</a>	\$1,948.14	\$1,870.21	\$1,792.29	\$1,714.36	89
	5 - 9	22.5		1.75	14.8	25	12/105	EAR99	<a href="#">PE15A9002</a>	\$7,257.75	\$6,967.44	\$6,677.13	\$6,386.82	90
Low Phase Noise, High Rel	6 - 12	11	1	4.5	20	34	7/200	EAR99	<a href="#">PE15A1032</a>	\$6,433.88	\$6,176.52	\$5,919.17	\$5,661.81	91
Low Noise			25	0.7	2.1			5.5/65	EAR99	<a href="#">PE15A1072</a>	\$1,633.07	\$1,567.75	\$1,502.42	\$1,437.10
		26	2.5	1.9	11	25	5.5/65	EAR99	<a href="#">PE15A1071</a>	\$1,709.85	\$1,641.46	\$1,573.06	\$1,504.67	93
Low Phase Noise, High Rel	7 - 11	9		6	22	33	7/300	EAR99	<a href="#">PE15A1033</a>	\$7,224.46	\$6,935.48	\$6,646.50	\$6,357.52	94
Low Noise, High Rel	8 - 12	18	1	2.2	13		13/150	EAR99	<a href="#">PE15A1027</a>	\$1,697.72	\$1,629.81	\$1,561.90	\$1,493.99	95
		13/200					EAR99	<a href="#">PE15A1026</a>	\$2,072.88	\$1,989.96	\$1,907.05	\$1,824.13	96	
		13/250					EAR99	<a href="#">PE15A1003M</a>	\$2,063.70	\$1,981.15	\$1,898.60	\$1,816.06	97	
		13/250					EAR99	<a href="#">PE15A1003</a>	\$2,304.22	\$2,212.05	\$2,119.88	\$2,027.71	98	
		13/300					EAR99	<a href="#">PE15A1025</a>	\$2,452.85	\$2,354.74	\$2,256.62	\$2,158.51	99	
		13/300					EAR99	<a href="#">PE15A1004</a>	\$2,518.20	\$2,417.47	\$2,316.74	\$2,216.02	1	
Low Noise	26.5 - 40	43	2	2	12	20	15/110	EAR99	<a href="#">PE15A3300</a>	\$3,366.75	\$3,232.08	\$3,097.41	\$2,962.74	2

## Input Protected



Amplifier Type	Frequency Band (GHz.)	Gain (dB)	Gain Var. ±(dB)	NF (dB)	P1dB (dBm)	IP3 (dBm)	DC Power (V/mA)	ECCN	Model No	1 Pc. Price	See Web for Volume Pricing	ROW
Input Protected Low Noise	10 MHz - 1	30	0.7	1	17	32	15/120	EAR99	<a href="#">PE15A63000</a>	\$718.42	See Web for Volume Pricing	3
		40	1			31.5	15/110	EAR99	<a href="#">PE15A63001</a>	\$714.41		4
	30 MHz - 1.5	25	0.5	1.6	22	15/150	EAR99	<a href="#">PE15A63002</a>	\$664.39	5		
		29			23	39	15/160	EAR99	<a href="#">PE15A63003</a>	\$664.39		6
	900 MHz - 1.2	30	1	1.2	10	12/100	EAR99	<a href="#">PE15A63004</a>	\$622.51	7		
		40				12/100	EAR99	<a href="#">PE15A63005</a>	\$622.51	8		
	1 - 1.4	30					12/110	EAR99	<a href="#">PE15A63006</a>	\$622.51	9	
GaN Input Protected Low Noise	1 - 7	42	3.5	1.5	22	31	28/200	EAR99	<a href="#">PE15A1075</a>	\$6,211.34	10	
	1 - 23	29	1.5	3.5	20	32	28/250	EAR99	<a href="#">PE15A1074</a>	\$5,806.63	11	
Integrated Band Pass Filter Low Noise	1.215 - 1.4	25	0.75	0.5	16		12/130	EAR99	<a href="#">PE15A1039</a>	\$1,018.07	12	
		35					12/130	EAR99	<a href="#">PE15A1040</a>	\$943.18	13	
Input Protected Low Noise	2 - 2.6	30	0.35	0.85	12		15/110	EAR99	<a href="#">PE15A63007</a>	\$971.79	14	
		40	1	1.2	10		12/120	EAR99	<a href="#">PE15A63008</a>	\$962.62	15	
	2.6 - 3.1	28	0.5	0.8	8	20	12/120	EAR99	<a href="#">PE15A63009</a>	\$869.35	16	
		35	1	0.85	13	15/45	EAR99	<a href="#">PE15A63010</a>	\$869.35	17		
	3.1 - 3.5	35	1	0.85	13	20	12/100	EAR99	<a href="#">PE15A63011</a>	\$916.78	18	
GaN Input Protected Low Noise	5 - 13	44	2.5	1.8	22	31	28/160	EAR99	<a href="#">PE15A1073</a>	\$6,580.85	19	

## POWER AMPLIFIERS (<4W)



Amplifier Type	Frequency Band (GHz.)	Gain (dB)	Gain Var. ±(dB)	NF (dB)	P1dB (dBm)	Psat (dBm)	DC Power (V/mA)	ECCN	Model No	1 Pc. Price	See Web for Volume Pricing	ROW
High Power, Class AB	1 MHz - 1	36	1.5		33	36	28/1,200	EAR99	<a href="#">PE15A5030</a>	\$3,087.89	See Web for Volume Pricing	20
High Power, Class AB, Power with Fan							28/1,700	EAR99	<a href="#">PE15A5030F</a>	\$3,879.26		21
High Power, Class AB	1.5 MHz - 30 MHz	47	2		47		28/5,000	EAR99	<a href="#">PE15A5055</a>	\$5,273.60	22	
	1.5 MHz - 100 MHz						28/5,000	EAR99	<a href="#">PE15A5056</a>	\$6,798.00	23	
Power	20 MHz - 520 MHz	51					28/9,000	EAR99	<a href="#">PE15A5065</a>	\$6,384.04	24	
Power	20 MHz - 1	40	0.5	6			24/630	EAR99	<a href="#">PE15A4072</a>	\$2,165.53	25	
High Power, Class AB		49	2		49	28/11,000	EAR99	<a href="#">PE15A5057</a>	\$7,814.28	26		
Power	20 MHz - 3	27	0.75		30		12/220	EAR99	<a href="#">PE15A4017</a>	\$848.39	27	





# POWER AMPLIFIERS (<4W)



Amplifiers

See Our Website For Current Pricing & Real-Time Stock Availability!

Amplifier Type	Frequency Band (GHz.)	Gain (dB)	Gain Var. ±(dB)	NF (dB)	P1dB (dBm)	Psat (dBm)	DC Power (V/mA)	ECCN	Model No	1 Pc. Price	See Web for Volume Pricing	ROW
Power	30 MHz - 3	38	1	5	30	28	12/270	EAR99	<a href="#">PE15A4018</a>	\$973.42	See Web for Volume Pricing	28
	50 MHz - 1	26	0.75				12/450	EAR99	<a href="#">PE15A4009</a>	\$1,379.13		29
	60 MHz - 6	36	1.5				15/530	EAR99	<a href="#">PE15A4019</a>	\$2,718.96		30
High Rel	100 MHz - 18	25	3	8	29	10	15/1,000	EAR99	<a href="#">PE15A4052</a>	\$11,591.93		31
High Rel, Power with Fan							15/2,160	EAR99	<a href="#">PE15A4052F</a>	\$11,266.88		32
Power, Class AB	200 MHz - 2.6	46	4	6	33	10	28/1,400	EAR99	<a href="#">PE15A5084</a>	\$10,940.75		33
High Power, Class AB	500 MHz - 1	50	2				50	28/10,000	EAR99	<a href="#">PE15A5058</a>		\$6,798.00
High Rel	500 MHz - 4	30	3	30	30	30	12/1,500	EAR99	<a href="#">PE15A4053</a>	\$4,066.98		35
High Rel, Power with Fan							12/2,660	EAR99	<a href="#">PE15A4053F</a>	\$4,985.53		36
High Power, Class AB	800 MHz - 1	53	2	31	46	53	28/25,000	EAR99	<a href="#">PE15A5061</a>	\$6,798.00		37
Power, Class AB	800 MHz - 2	55	2.5				28/3,000	EAR99	<a href="#">PE15A5077</a>	\$11,462.49		38
Power, Class AB, Power with Fan		60	5	28/3,000	EAR99	<a href="#">PE15A5078</a>	\$12,725.63	39				
Power, Class AB	800 MHz - 4.2	31	2	30.8	31.8	13/1,000	13/800	EAR99	<a href="#">PE15A5034F</a>	\$3,110.21		40
Power, Class AB							13/800	EAR99	<a href="#">PE15A5034</a>	\$1,954.96		41
Power	820 MHz - 960 MHz	15	0.5	2	30	30	12/500	EAR99	<a href="#">PE15A4026</a>	\$547.65		42
							12/600	EAR99	<a href="#">PE15A4025</a>	\$1,381.65		43
High Power	1 - 2	35	0.75	1.5	33	36	12/800	EAR99	<a href="#">PE15A4016</a>	\$1,613.89		44
							20	EAR99	<a href="#">PE15A5085</a>	\$9,330.62		45
Power, Class AB	1 - 2.5	14	3	33	7	30	28/2,200	EAR99	<a href="#">PE15A5083</a>	\$10,312.99		46
							28/650	EAR99	<a href="#">PE15A5074</a>	\$9,854.74		47
High Power	2 - 2.6	54	2.5	31	30	37	28/2,400	EAR99	<a href="#">PE15A4011</a>	\$2,508.51		48
							12/1,200	EAR99	<a href="#">PE15A4054</a>	\$5,741.95		49
High Rel	2 - 8	38	2.5	5.5	30	30	12/2,360	EAR99	<a href="#">PE15A4054F</a>	\$6,928.48		50
High Rel, Power with Fan							15/4,500	EAR99	<a href="#">PE15A4055</a>	\$13,323.78		51
High Rel	2 - 12	35	4	33	30	30	15/5,660	EAR99	<a href="#">PE15A4055F</a>	\$15,314.82		52
High Rel, Power with Fan							12/2,500	EAR99	<a href="#">PE15A4056</a>	\$12,074.18		53
High Rel	2 - 18	30	4	30	33	33	12/3,660	EAR99	<a href="#">PE15A4056F</a>	\$13,005.48		54
High Rel, Power with Fan							12/5,000	EAR99	<a href="#">PE15A4057</a>	\$14,151.92		55
Power	2 - 20	30	4	31	31	31	12/6,160	EAR99	<a href="#">PE15A4057F</a>	\$15,025.89		56
Power with Fan							12/4,500	EAR99	<a href="#">PE15A4058</a>	\$14,526.47		57
High Rel	2 - 20	5.5	31	31	31	31	12/5,660	EAR99	<a href="#">PE15A4058F</a>	\$14,341.03	58	
High Rel, Power with Fan							15/5,000	EAR99	<a href="#">PE15A5002</a>	\$3,162.44	59	
High Power	3.1 - 3.5	45	1.5	4	40	37	15/5,000	EAR99	<a href="#">PE15A5002</a>	\$3,162.44	59	
							3.5 - 7	26	2	11	36	37
Power, Class AB, Power with Fan	4.4 - 4.9	48	5	33	20	20	28/3,600	5A991.G	<a href="#">PE15A5079</a>	\$15,310.66	61	
							28/3,600	5A991.G	<a href="#">PE15A5080</a>	\$17,230.20	62	
High Rel	6 - 12	47	2.5	6.5	30.5	27	12/1,500	EAR99	<a href="#">PE15A4060</a>	\$5,015.70	63	
High Rel, Power with Fan							12/2,660	EAR99	<a href="#">PE15A4060F</a>	\$6,678.92	64	
High Rel	6 - 18	30	7	27	33	33	12/1,380	EAR99	<a href="#">PE15A4061F</a>	\$6,614.54	65	
							12/800	EAR99	<a href="#">PE15A4061</a>	\$5,851.47	66	
High Rel	6 - 18	35	3.5	10	30	30	12/2,500	EAR99	<a href="#">PE15A5048</a>	\$11,313.43	67	
High Rel, Power with Fan							12/3,660	EAR99	<a href="#">PE15A5048F</a>	\$12,263.06	68	
High Rel	6 - 18	38	10	30	30	30	12/1,800	EAR99	<a href="#">PE15A4062</a>	\$10,060.03	69	
High Rel, Power with Fan							12/2,960	EAR99	<a href="#">PE15A4062F</a>	\$11,072.50	70	
High Power	7.5 - 11	25	2	33	37	37	EAR99	<a href="#">PE15A4013</a>	\$2,510.32	71		
Power							EAR99	<a href="#">PE15A4014</a>	\$2,115.01	72		
High Power	8 - 11	28	3	32	36	36	EAR99	<a href="#">PE15A4015</a>	\$2,145.64	73		
High Rel							12/2,500	EAR99	<a href="#">PE15A5051</a>	\$6,899.53	74	
High Rel, Power with Fan	8 - 12	30	2	33	33	33	12/3,660	EAR99	<a href="#">PE15A5051F</a>	\$8,067.33	75	

## POWER AMPLIFIERS (<4W)



Amplifier Type	Frequency Band (GHz.)	Gain (dB)	Gain Var. ±(dB)	NF (dB)	P1dB (dBm)	Psat (dBm)	DC Power (V/mA)	ECCN	Model No	1	2-4	5-9	10+	ROW
Power	8 - 12	41	1	3.5	30	31	12/1,200	EAR99	<a href="#">PE15A4008</a>	\$3,586.61	\$3,443.15	\$3,299.68	\$3,156.22	76
High Rel, Power with Fan	8 - 12.4	30	1.75	6	27		12/1,380	EAR99	<a href="#">PE15A4063F</a>	\$4,988.63	\$4,789.08	\$4,589.54	\$4,389.99	77
High Rel							12/800	EAR99	<a href="#">PE15A4063</a>	\$4,277.44	\$4,106.34	\$3,935.24	\$3,764.15	78
Power	8.5 - 11	43	0.5	3	30		15/900	EAR99	<a href="#">PE15A4006</a>	\$2,913.62	\$2,797.08	\$2,680.53	\$2,563.99	79
	14.4 - 15.4						0.75	5	36	12/4,500	EAR99	<a href="#">PE15A4007</a>	\$3,996.87	\$3,837.00
High Rel		18 - 26.5	28	1.25	5	31	15/1,500	EAR99	<a href="#">PE15A5021</a>	\$8,049.45	\$7,727.47	\$7,405.49	\$7,083.52	81
High Rel, Power with Fan	12/1,150						EAR99	<a href="#">PE15A4064</a>	\$9,795.30	\$9,403.49	\$9,011.68	\$8,619.86	82	
High Rel, Power with Fan	18 - 26.5	33	3	9	23		12/1,730	EAR99	<a href="#">PE15A4064F</a>	\$10,344.63	\$9,930.84	\$9,517.06	\$9,103.27	83
Power							12/1,800	EAR99	<a href="#">PE15A4021</a>	\$4,425.55	\$4,248.53	\$4,071.51	\$3,894.48	84
High Rel	18 - 40	35	4	10			12/3,500	EAR99	<a href="#">PE15A5054</a>	\$13,125.15	\$12,600.14	\$12,075.14	\$11,550.13	85
High Rel, Power with Fan							12/4,660	EAR99	<a href="#">PE15A5054F</a>	\$13,239.92	\$12,710.32	\$12,180.73	\$11,651.13	86
High Rel	18 - 40	20	2	4.5	20	22	12/1,000	EAR99	<a href="#">PE15A4065</a>	\$11,612.38	\$11,147.88	\$10,683.39	\$10,218.89	87
High Rel, Power with Fan							12/1,580	EAR99	<a href="#">PE15A4065F</a>	\$11,854.98	\$11,380.78	\$10,906.58	\$10,432.38	88
Power	26.5 - 40	4	10				12/270	EAR99	<a href="#">PE15A4050</a>	\$3,206.44	\$3,078.18	\$2,949.92	\$2,821.67	89
High Rel							12/3,000	EAR99	<a href="#">PE15A4067</a>	\$13,206.00	\$12,743.79	\$12,281.58	\$11,885.40	90
High Rel, Power with Fan	30 - 40	20	2				12/3,160	EAR99	<a href="#">PE15A4067F</a>	\$14,311.43	\$13,810.53	\$13,309.63	\$12,880.29	91
High Rel							12/350	EAR99	<a href="#">PE15A4069</a>	\$8,310.61	\$7,978.19	\$7,645.76	\$7,313.34	92
High Rel, Power with Fan	30 - 40	20	2				12/930	EAR99	<a href="#">PE15A4069F</a>	\$8,919.80	\$8,563.01	\$8,206.22	\$7,849.42	93

Amplifiers

## HIGH POWER AMPLIFIERS (>4W)



Amplifier Type	Frequency Band (GHz.)	Gain (dB)	Gain Var. ±(dB)	NF (dB)	P1dB (dBm)	Psat (dBm)	DC Power (V/mA)	ECCN	Model No	1	2-4	5-9	10+	ROW
High Power, Class AB	0.15 MHz - 230 MHz	43	1.5	10	41.8	44	28/5,000	EAR99	<a href="#">PE15A5028</a>	\$4,904.86	\$4,708.67	\$4,512.47	\$4,316.28	94
							28/5,500	EAR99	<a href="#">PE15A5028F</a>	\$5,305.50	\$5,093.28	\$4,881.06	\$4,668.84	95
							28/2,000	EAR99	<a href="#">PE15A5029</a>	\$2,589.71	\$2,486.12	\$2,382.53	\$2,278.94	96
High Power, Class AB, Power with Fan	0.5 MHz - 500 MHz	44	1.5	10	40	39	28/2,000	EAR99	<a href="#">PE15A5029F</a>	\$2,758.17	\$2,647.84	\$2,537.52	\$2,427.19	97
High Power, Class AB							20 MHz - 1	46	1.5	40	44	28/5,200	EAR99	<a href="#">PE15A5031</a>
High Power, Class AB, Power with Fan	500 MHz - 3	48	2	10	44	47						28/5,800	EAR99	<a href="#">PE15A5031F</a>
High Power, Class AB							700 MHz - 2.2	30	1	3	38	38.5	36/8,333	EAR99
High Power	800 MHz - 960 MHz	37	1	3	38	38.5							EAR99	<a href="#">PE15A5004</a>
							12/1,800	EAR99	<a href="#">PE15A5040</a>	\$1,395.54	\$1,339.72	\$1,283.90	\$1,228.08	3
High Power, Class AB	800 MHz - 2	41	1.5	3.5	40	40.8	12/1,800	EAR99	<a href="#">PE15A5041</a>	\$1,463.45	\$1,404.91	\$1,346.37	\$1,287.84	4
High Power, Class A							800 MHz - 2.5	40	2	41	42.5	12/2,800	EAR99	<a href="#">PE15A5035F</a>
High Power	860 MHz - 960 MHz	42	1	3.5	44	42.5							12/6,500	EAR99
High Power, Class AB, Power with Fan							1 - 2.5	40	1.5	3.5	39	40	13/5,500	EAR99
High Power, Class AB	1 - 2.5	44	1.5	3.5	41	40							13/5,000	EAR99
Power, Class AB, Power with Fan							1 - 2.5	47	3	3.5	38	18	28/1,900	EAR99
Power, Class AB	1 - 2.5	50	3	3.5	38	18							28/1,900	EAR99

See Our Website For Current Pricing & Real-Time Stock Availability!



Technical Support  
+1 (949) 261-1920



Same-Day Shipping,  
Even Custom  
Cable Assemblies

## HIGH POWER AMPLIFIERS (>4W)



Amplifiers

Amplifier Type	Frequency Band (GHz.)	Gain (dB)	Gain Var. ±(dB)	NF (dB)	P1dB (dBm)	Psat (dBm)	DC Power (V/mA)	ECCN	Model No	1	2-4	5-9	10+	ROW		
High Power, Class AB	1 - 3	44	1.5		37.8	39	13/3,000	EAR99	<a href="#">PE15A5037</a>	\$5,519.84	\$5,299.05	\$5,078.25	\$4,857.46	13		
High Power, Class AB, Power with Fan							13/4,000	EAR99	<a href="#">PE15A5037F</a>	\$6,554.80	\$6,292.61	\$6,030.42	\$5,768.22	14		
High Power	1.2 - 1.4	40	0.3	10	38.5	39	12/4,000	EAR99	<a href="#">PE15A5001</a>	\$4,323.37	\$4,150.44	\$3,977.50	\$3,804.57	15		
	1.5 - 3.5	20	1.25				EAR99	<a href="#">PE15A5005</a>	\$2,636.59	\$2,531.13	\$2,425.66	\$2,320.20	16			
Power, Class AB	1.7 - 2.4	54	3		42	35	28/3,600	EAR99	<a href="#">PE15A5073</a>	\$9,395.13	\$9,019.32	\$8,643.52	\$8,267.71	17		
High Power	1.7 - 2.5	11	0.5				37	12/800	EAR99	<a href="#">PE15A5015</a>	\$2,646.46	\$2,540.60	\$2,434.74	\$2,328.88	18	
Power, Class AB	2 - 4	39	1.5		37.8	39	13/3,000	EAR99	<a href="#">PE15A5038</a>	\$5,709.75	\$5,481.36	\$5,252.97	\$5,024.58	19		
							13/5,500	EAR99	<a href="#">PE15A5038F</a>	\$6,128.78	\$5,883.63	\$5,638.48	\$5,393.33	20		
High Rel	2 - 6	40	3.5		37		12/7,000	EAR99	<a href="#">PE15A5047</a>	\$11,637.22	\$11,171.73	\$10,706.24	\$10,240.75	21		
High Rel, Power with Fan							12/8,160	EAR99	<a href="#">PE15A5047F</a>	\$12,747.77	\$12,237.86	\$11,727.95	\$11,218.04	22		
High Power	2.3 - 2.7	55	0.5	8	38	38.5	12/5,500	EAR99	<a href="#">PE15A5018</a>	\$6,082.67	\$5,839.36	\$5,596.06	\$5,352.75	23		
	2.5 - 4	19					EAR99	<a href="#">PE15A5006</a>	\$1,680.70	\$1,613.47	\$1,546.24	\$1,479.02	24			
	2.6 - 4.2	1	9	39	39	EAR99	<a href="#">PE15A5007</a>	\$1,746.25	\$1,676.40	\$1,606.55	\$1,536.70	25				
	3.1 - 3.5	47	1.5	3.5	43	12/9,000	EAR99	<a href="#">PE15A5003</a>	\$4,323.37	\$4,150.44	\$3,977.50	\$3,804.57	26			
	3.5 - 7	19	2	12	37	38	EAR99	<a href="#">PE15A5008</a>	\$3,498.52	\$3,358.58	\$3,218.64	\$3,078.70	27			
	5.5 - 9.5	24		8.5			EAR99	<a href="#">PE15A5009</a>	\$3,074.14	\$2,951.17	\$2,828.21	\$2,705.24	28			
High Rel	6 - 18	40	5		40		12/13,000	EAR99	<a href="#">PE15A5050</a>	\$21,007.15	\$20,271.90	\$19,536.65	\$18,906.44	29		
High Rel, Power with Fan							15/14,160	EAR99	<a href="#">PE15A5050F</a>	\$23,430.44	\$22,610.37	\$21,790.31	\$21,087.40	30		
High Rel		41					37	12/7,500	EAR99	<a href="#">PE15A5049</a>	\$17,697.50	\$17,078.09	\$16,458.68	\$15,927.75	31	
High Rel, Power with Fan								12/8,660	EAR99	<a href="#">PE15A5049F</a>	\$19,109.37	\$18,440.54	\$17,771.71	\$17,198.43	32	
High Rel		8 - 12	30				2.5	40	12/14,000	EAR99	<a href="#">PE15A5053</a>	\$17,547.81	\$16,933.64	\$16,319.46	\$15,793.03	33
High Rel, Power with Fan									12/15,160	EAR99	<a href="#">PE15A5053F</a>	\$18,655.88	\$18,002.92	\$17,349.97	\$16,790.29	34
High Rel	40		2	37	12/6,000	EAR99	<a href="#">PE15A5052</a>		\$13,014.04	\$12,493.48	\$11,972.92	\$11,452.36	35			
High Power	8.5 - 10.5	36	1.5	5	38.5		12/4,000	EAR99	<a href="#">PE15A5044</a>	\$4,829.08	\$4,635.92	\$4,442.75	\$4,249.59	36		
	8.5 - 11	30	0.75				12/7,500	EAR99	<a href="#">PE15A5043</a>	\$5,044.05	\$4,842.29	\$4,640.53	\$4,438.76	37		
	17.5 - 21.5	40	1.5				37	12/3,500	EAR99	<a href="#">PE15A4020</a>	\$4,773.72	\$4,582.77	\$4,391.82	\$4,200.87	38	

## GaN HIGH POWER AMPLIFIERS



See Our Website For Current Pricing & Real-Time Stock Availability!

Amplifier Type	Frequency Band (GHz.)	Gain (dB)	Gain Var. ±(dB)	NF (dB)	P1dB (dBm)	Psat (dBm)	DC Power (V/mA)	ECCN	Model No	1	2-4	5-9	10+	ROW	
High Power	30 MHz - 2.5	43	2	10		40	12/2,800	EAR99	<a href="#">PE15A5011</a>	\$8,575.35	\$8,232.34	\$7,889.32	\$7,546.31	39	
	30 MHz - 2.7	35	1.5				39	1/1,400	EAR99	<a href="#">PE15A5086</a>	\$11,642.43	\$11,176.73	\$10,711.04	\$10,245.34	40
	100 MHz - 6	60	1.25				40	28/2,200	EAR99	<a href="#">PE15A5027</a>	\$19,358.10	\$18,583.78	\$17,809.45	\$17,035.13	41
High Power, Class AB	500 MHz - 2.5	48	2		44	47	28/7,000	EAR99	<a href="#">PE15A5059</a>	\$5,673.15	\$5,332.76	\$5,049.10	\$4,822.18	42	
		50					28/13,000	EAR99	<a href="#">PE15A5060</a>	\$12,974.58	\$12,196.11	\$11,547.38	\$11,028.39	43	
	500 MHz - 3	48	36/8,333				EAR99	<a href="#">PE15A5032</a>	\$16,016.50	\$15,375.84	\$14,735.18	\$14,094.52	44		
High Power, Class AB, Power with Fan	700 MHz - 2.7	45	1.5		50	30/8,733	EAR99	<a href="#">PE15A5033</a>	\$15,177.59	\$14,570.49	\$13,963.38	\$13,356.28	45		
						30/8,733	EAR99	<a href="#">PE15A5033F</a>	\$15,645.44	\$15,019.62	\$14,393.80	\$13,767.99	46		
High Power	700 MHz - 6	43	2		40	32/2,000	EAR99	<a href="#">PE15A5017</a>	\$9,969.23	\$9,570.46	\$9,171.69	\$8,772.92	47		
High Power, Class AB	800 MHz - 4.2	47				47	28/13,000	EAR99	<a href="#">PE15A5062</a>	\$8,845.71	\$8,314.97	\$7,872.68	\$7,518.85	48	
	High Power	1 - 2	53	1.5	10	47	28/20,000	EAR99	<a href="#">PE15A5063</a>	\$10,358.38	\$9,736.88	\$9,218.96	\$8,804.62	49	
1 - 3		50	1.25	EAR99				<a href="#">PE15A5026</a>	\$19,201.56	\$18,433.50	\$17,665.44	\$16,897.37	50		

## GaN HIGH POWER AMPLIFIERS



Amplifier Type	Frequency Band (GHz.)	Gain (dB)	Gain Var. ±(dB)	NF (dB)	P1dB (dBm)	Psat (dBm)	DC Power (V/mA)	ECCN	Model No	1	2-4	5-9	10+	ROW
High Power, Class AB	1.2 - 1.6	48	2.5			47	28/8,000	EAR99	<a href="#">PE15A5064</a>	\$4,837.58	\$4,547.33	\$4,305.45	\$4,111.94	51
		43	2			43	28/5,000	EAR99	<a href="#">PE15A5066</a>	\$8,624.71	\$8,107.23	\$7,675.99	\$7,331.00	52
High Power	2 - 6	46	1.25	7		46	28/6,000	EAR99	<a href="#">PE15A5067</a>	\$14,135.03	\$13,286.93	\$12,580.18	\$12,014.78	53
		44				28/3,000	EAR99	<a href="#">PE15A5024</a>	\$15,796.36	\$15,243.49	\$14,690.61	\$14,216.72	54	
		47				28/6,000	EAR99	<a href="#">PE15A5025</a>	\$20,282.43	\$19,471.13	\$18,659.84	\$17,848.54	55	
High Power, Class AB	2 - 18	37	3.5			37	22/2,500	EAR99	<a href="#">PE15A5068</a>	\$17,561.50	\$16,507.81	\$15,629.74	\$14,927.28	56
	6 - 10	43	2			43	24/7,000	EAR99	<a href="#">PE15A5069</a>	\$16,455.98	\$15,468.62	\$14,645.82	\$13,987.58	57
	6 - 18	40	3			40	28/3,000	EAR99	<a href="#">PE15A5070</a>	\$14,949.49	\$14,052.52	\$13,305.05	\$12,707.07	58
High Power	6.4 - 7.1	58	2			43	33/2,300	EAR99	<a href="#">PE15A5016</a>	\$10,021.26	\$9,620.41	\$9,219.56	\$8,818.71	59
High Power, Class AB	8 - 12	43				28/5,000	EAR99	<a href="#">PE15A5071</a>	\$11,795.81	\$11,088.06	\$10,498.27	\$10,026.44	60	
		46	28/9,000	EAR99	<a href="#">PE15A5072</a>	\$18,869.81	\$17,737.62	\$16,794.13	\$16,039.34	61				

## VARIABLE GAIN AMPLIFIERS



Amplifier Type	Frequency Band (GHz.)	Gain (dB)	Gain Var. ±(dB)	NF (dB)	Atten. Range (dB)	Output P1dB (dBm)	Voltage	ECCN	Model No	1	2-4	5-9	10+	ROW	
Variable Gain, High Rel	100 MHz - 18	50	2	6.5	60	14	120 VAC	EAR99	<a href="#">PE15A7000</a>	\$18,119.27	\$17,394.50	\$16,669.73	\$15,944.96	62	
Variable Gain	500 MHz - 2	45		3.5	20	18	15 VDC		EAR99	<a href="#">PE15A7001</a>	\$7,084.09	\$6,800.73	\$6,517.36	\$6,234.00	63
	500 MHz - 4	43	4	EAR99					<a href="#">PE15A7002</a>	\$8,270.05	\$7,939.25	\$7,608.45	\$7,277.64	64	
	1 - 18	48	3	3.5					EAR99	<a href="#">PE15A7009</a>	\$10,011.60	\$9,611.14	\$9,210.67	\$8,810.21	65
	1 - 26.5	43	4	5.5					EAR99	<a href="#">PE15A7010</a>	\$13,475.84	\$12,936.81	\$12,397.77	\$11,858.74	66
	1 - 40	43	5	5					EAR99	<a href="#">PE15A7011</a>	\$14,505.84	\$13,925.61	\$13,345.37	\$12,765.14	67
	2 - 6	42	2	2					EAR99	<a href="#">PE15A7003</a>	\$8,270.05	\$7,939.25	\$7,608.45	\$7,277.64	68
	2 - 8	43	3	2.5					EAR99	<a href="#">PE15A7004</a>	\$8,657.15	\$8,310.86	\$7,964.58	\$7,618.29	69
	4 - 12	47		3.5					EAR99	<a href="#">PE15A7005</a>	\$8,222.84	\$7,893.93	\$7,565.01	\$7,236.10	70
	6 - 18	45	3	3					EAR99	<a href="#">PE15A7006</a>	\$8,956.29	\$8,598.04	\$8,239.79	\$7,881.54	71
	18 - 26.5	43	5	5.5					EAR99	<a href="#">PE15A7007</a>	\$11,227.00	\$10,777.92	\$10,328.84	\$9,879.76	72
	18 - 40	48		5					10	EAR99	<a href="#">PE15A7012</a>	\$13,424.34	\$12,887.37	\$12,350.39	\$11,813.42
	26.5 - 40	46	4	5					EAR99	<a href="#">PE15A7008</a>	\$12,349.70	\$11,855.71	\$11,361.72	\$10,867.74	74

## AMPLIFIER ACCESSORIES

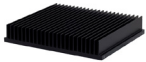

Model No	Description	1 Pc. Price	See Web for Volume Pricing	ROW
<a href="#">PE15C5013</a>	Heat Sink for Most RF Power Amplifier PE15A5000 Series	\$471.61	See Web for Volume Pricing	75
<a href="#">PE15C5022</a>	Heat Sink for Rf Power Amplifier PE15A5022	\$633.83		76
<a href="#">PE15C5013F</a>	Heat Sink with 12V Fan for Most RF Power Amplifier PE15A5000 Series	\$1,352.02		77
<a href="#">PE15C5011F</a>	Heat Sink with 24V Fan for RF Amplifier PE15A5011, PE15A5016, PE15A5017, PE15A5019	\$1,180.50		78
<a href="#">PE15C5022F</a>	Heat Sink with 24V Fan for RF Power Amplifier PE15A5022	\$1,018.63		79
<a href="#">PE15A5990</a>	Heat Sink with Fan for RF Power Amplifier PE15A5024, PE15A5025 and PE15A5027	\$2,143.23		80
<a href="#">PE15C5014</a>	Heatsink for amplifier models PE15A4011-4015 and PE15A5004-5009	\$669.83		81
<a href="#">PE15G5060F</a>	Heatsink for amplifier models PE15A5055-5059, PE15A5064-5065, PE15A5068 and PE15A5070	\$738.77		82
<a href="#">PE15G5068F</a>	Heatsink for amplifier models PE15A5060-5063, PE15A5066-5067, PE15A5069, PE15A5071-5072	\$923.46		83
<a href="#">PE15J5011</a>	Power and Control Cable for RF Amplifier PE15A5011, PE15A5014, PE15A5016, PE15A5017, PE15A5018, PE15A5019, PE15A5020 and PE15A5022	\$242.54		84
<a href="#">PE15J5015</a>	Power and Control Cable for RF Amplifier PE15A5015, PE15A5023	\$128.80		85
<a href="#">PE15K5000</a>	Power and Control Cable for RF Amplifier PE15B5000 and PE15B5001	\$151.68		86
<a href="#">PE15K5002</a>	Power and Control Cable for RF Amplifier PE15B5002	\$121.29		87
<a href="#">PE15J000</a>	Power and Control Cable for RF Bi-Directional Amplifier PE15B5003	\$343.33		88



Technical Support  
+1 (949) 261-1920



Same-Day Shipping,  
Even Custom  
Cable Assemblies

Amplifiers

See Our Website For Current Pricing & Real-Time Stock Availability!



# INDEX GUIDE TO ANTENNAS

Antennas

<b>ANTENNAS.....</b>	<b>60</b>
<b>DIRECTIONAL ANTENNAS.....</b>	<b>60</b>
Dish.....	61
Fixed.....	60
Yagi.....	61
Log.....	61
Panel.....	60
Sector.....	61
<b>OMNI DIRECTIONAL ANTENNAS.....</b>	<b>62</b>
Ceiling.....	62
Dome.....	62
Duplexed Antenna Kits.....	67
Fixed.....	62
GPS Active.....	63
GPS Passive.....	63
Mobile.....	63
Omni.....	64
Panel.....	64
PCB.....	64
Portable.....	65
Rubber Duck.....	66
Vehicular.....	67
<b>ANTENNA MOUNTS.....</b>	<b>67</b>

## Directional Antennas

### Panel Antennas



RF Frequency Range (MHz)	VSWR	Gain Nominal	Polarization	Model No	1 Pc. Price	See Web for Volume Pricing	R O W
617-960 1710-2700 3300-4200 4900-6000	2:1	5.5 / 6 dBi	±45 Deg. Slant	<a href="#">PE51FP1012</a>	\$298.20		1
698-960 1710-2700 3400-4200	1.8:1	5 / 6 dBi	Vertical	<a href="#">PE51FP1013</a>	\$87.74	See Web for Volume Pricing	2
	2:1		Vertical / Horizontal	<a href="#">PE51239</a>	\$246.65		3
			Vertical / Horizontal	<a href="#">PE51FP1014</a>	\$234.91		4
824 - 960	1.8:1	9 dBi	Vertical / Horizontal	<a href="#">PE51FP1006</a>	\$78.02		5
902 - 928	1.2:1		LHCP	<a href="#">PE51025</a>	\$168.50		6
		RHCP	<a href="#">PE51024</a>	\$181.96	7		
	1.5:1	LHCP	<a href="#">PE51FP1007</a>	\$68.61	8		
		RHCP	<a href="#">PE51FP1008</a>	\$68.61	9		
		RHCP	<a href="#">PE51FP1008-1</a>	\$141.92	10		
		RHCP	<a href="#">PE51FP1008-3</a>	\$141.92	11		
		RHCP	<a href="#">PE51FP1008-2</a>	\$141.92	12		
		Vertical / Horizontal	<a href="#">PE51FP1005</a>	\$82.08	13		
	1.8:1	Vertical / Horizontal	<a href="#">PE51FP1005-1</a>	\$77.49	14		
		Vertical / Horizontal	<a href="#">PE51FP1005-2</a>	\$77.49	15		
2,400 - 2,500 4,900 - 5,850	2:1	9 / 10 dBi	Vertical / Horizontal	<a href="#">PE51FP1002</a>	\$199.01	21	
		8 / 10 dBi	Vertical / Horizontal	<a href="#">PE51FP1001</a>	\$52.84	22	
4,900 - 5,850	1.5:1	23 dBi	Vertical / Horizontal	<a href="#">PE51FP1010</a>	\$122.86	23	
	1.8:1		Vertical / Horizontal	<a href="#">PE51FP1011</a>	\$125.30	24	
5,725 - 5,850	1.5:1	19 dBi	Vertical / Horizontal	<a href="#">PE51050</a>	\$248.03	25	

### Fixed Antennas



RF Frequency Range (MHz)	VSWR	Gain Nominal	Polarization	Model No	1-4	5-9	10-24	25+	R O W
4,400 - 6,400	1.5:1	9 dBi	Vertical	<a href="#">PE51129</a>	\$565.41	\$542.79	\$525.83	\$514.52	26

See Our Website For Current Pricing & Real-Time Stock Availability!

### Yagi Antennas



RF Frequency Range (MHz)	VSWR	Gain Nominal	Polarization	Model No	1 Pc. Price	See Web for Volume Pricing			ROW
400 - 435 435 - 470	1.7:1	10 dBi	Linear	<a href="#">PE51YA1015</a>	\$140.83				27
824 - 960	1.5:1	3 dBi	Vertical / Horizontal	<a href="#">PE51YA1007</a>	\$41.90	See Web for Volume Pricing			28
		6 dBi	Vertical / Horizontal	<a href="#">PE51YA1008</a>	\$46.56				29
		9 dBi	Vertical / Horizontal	<a href="#">PE51YA1009</a>	\$51.58				30
		12 dBi	Vertical / Horizontal	<a href="#">PE51YA1010</a>	\$54.84				31
880 - 928 928 - 960	1.5:1	14 dBi	Vertical / Horizontal	<a href="#">PE51YA1011</a>	\$65.42				32
		11 / 12 dBi	Linear	<a href="#">PE51YA1017</a>	\$141.92				33
		13 dBi	Linear	<a href="#">PE51YA1016</a>	\$152.83				34
		7 / 8 dBi	Linear	<a href="#">PE51YA1019</a>	\$120.08				35
890 - 960	2.1:1	9 dBi	Linear	<a href="#">PE51YA1018</a>	\$136.46				36
		9 dBi	Vertical / Horizontal	<a href="#">PE51YA1012</a>	\$54.10				37
900 - 928	2.1:1	13 dBi	Vertical / Horizontal	<a href="#">PE51YA1013</a>	\$81.79	38			
2,400 - 2,483		11 dBi	Vertical / Horizontal	<a href="#">PE51171</a>	\$383.58	39			
2,400 - 2,500	1.5:1	14 dBi	Vertical / Horizontal	<a href="#">PE51YA1014</a>	\$178.14	40			
		12 dBi	Vertical	<a href="#">PE51YA1004</a>	\$68.61	41			
9 dBi		Vertical / Horizontal	<a href="#">PE51YA1001</a>	\$73.66	42				
12 dBi		Vertical / Horizontal	<a href="#">PE51YA1002</a>	\$82.08	43				
2,400 - 2,500	1.5:1	12 dBi	Vertical / Horizontal	<a href="#">PE51YA1002</a>	\$82.08	43			
4,900 - 5,850		14.5 dBi	Vertical / Horizontal	<a href="#">PE51YA1003</a>	\$80.99	44			
4,900 - 5,850	1.5:1	14.5 dBi	Vertical / Horizontal	<a href="#">PE51YA1003</a>	\$80.99	44			
5,725 - 5,825		17 dBi	Vertical / Horizontal	<a href="#">PE51YA1006</a>	\$222.36	45			
5,725 - 5,825	1.5:1	17 dBi	Vertical / Horizontal	<a href="#">PE51YA1006</a>	\$222.36	45			
		17 dBi	Vertical	<a href="#">PE51YA1005</a>	\$103.31	46			

### Dish Antennas



RF Frequency Range (MHz)	VSWR	Gain Nominal	Polarization	Model No	1-24	25-49	50-99	100+	ROW
2,400 - 2,500	1.5:1	18 dBi	H / V / 45 Deg. Slant	<a href="#">PE51PD1004</a>	\$171.99	\$163.39	\$154.79	\$147.91	47
		22 dBi	H / V / 45 Deg. Slant	<a href="#">PE51PD1005</a>	\$205.15	\$194.89	\$184.64	\$176.43	48
		25 dBi	H / V / 45 Deg. Slant	<a href="#">PE51PD1006</a>	\$370.98	\$352.43	\$333.88	\$319.04	49
4,750 - 5,850		34 dBi	H / V / 45 Deg. Slant	<a href="#">PE51PD1003</a>	\$383.27	\$364.11	\$344.94	\$329.61	50
5,400 - 5,800		30 dBi	H / V / 45 Deg. Slant	<a href="#">PE51PD1002</a>	\$218.66	\$207.73	\$196.79	\$188.05	51
4,750 - 5,850	25 dBi	H / V / 45 Deg. Slant	<a href="#">PE51PD1001</a>	\$185.49	\$176.22	\$166.94	\$159.52	52	

### Log Antennas



RF Frequency Range (MHz)	VSWR	Gain Nominal	Polarization	Model No	1-24	25-49	50-99	100+	ROW
698 - 960 1,710 - 2,500	1.6:1	10 dBi	Vertical / Horizontal	<a href="#">PE51LP1001</a>	\$90.96	\$86.41	\$81.86	\$78.23	53
2,400 - 6,500	1.5:1	8 dBi	Vertical	<a href="#">PE51LP1002</a>	\$98.44	\$93.52	\$88.60	\$84.66	54

### Sector Antennas



RF Frequency Range (MHz)	VSWR	Gain Nominal	Polarization	Model No	1-24	25-49	50-99	100+	ROW
698 - 960 1,710 - 2,700	1.6:1	14 dBi	Vertical	<a href="#">PE51SE1006</a>	\$408.11	\$387.70	\$367.30	\$350.97	55
	1.8:1	12 dBi	Vertical	<a href="#">PE51SE1005</a>	\$392.77	\$373.13	\$353.49	\$337.78	56
	1.9:1	9 dBi	45 Deg. Slant	<a href="#">PE51SE1004</a>	\$264.12	\$250.91	\$237.71	\$227.14	57
900 - 930	2:1	13 dBi	Horizontal	<a href="#">PE51SE1003</a>	\$313.25	\$297.59	\$281.93	\$269.40	58
902 - 928	1.5:1		Vertical / Horizontal	<a href="#">PE51FP1009</a>	\$435.57	\$413.79	\$392.01	\$374.59	59
2,400 - 2,500	1.3:1	2 dBi	Vertical	<a href="#">PE51SE1009</a>	\$528.22	\$501.81	\$475.40	\$454.27	60
	1.5:1	14 dBi	Vertical / Horizontal	<a href="#">PE51SE1001</a>	\$254.30	\$241.59	\$228.87	\$218.70	61

Antennas

See Our Website For Current Pricing & Real-Time Stock Availability!



Technical Support  
+1 (949) 261-1920



Same-Day Shipping,  
Even Custom  
Cable Assemblies

### Sector Antennas



RF Frequency Range (MHz)	VSWR	Gain Nominal	Polarization	Model No	1-24	25-49	50-99	100+	ROW
2,400 - 2,500 4,900 - 5,850	1.5/2:1	13 / 15 dBi	Vertical / Horizontal	<a href="#">PE51SE1002</a>	\$493.11	\$468.45	\$443.80	\$424.07	62
4,900 - 5,850	1.7:1	16 dBi	Vertical / Horizontal	<a href="#">PE51SE1008</a>	\$147.43	\$140.06	\$132.69	\$126.79	63
2,400 - 2,500 5,725 - 5,875	1.5:1	5 dBi	Vertical / Horizontal	<a href="#">PE51SE1007</a>	\$67.19	\$63.83	\$60.47	\$57.78	64

### Omni Directional Antennas

#### Ceiling Antennas



RF Frequency Range (MHz)	VSWR	Gain Nominal	Polarization	Model No	1-24	25-49	50-99	100+	ROW
617 - 960 1350 - 2700 3300 - 3800 4900 - 6000	1.8:1	1.5 / 3.5 dBi	Linear	<a href="#">PE51217</a>	\$102.71	\$97.57	\$92.44	\$88.33	65
			Linear	<a href="#">PE51223</a>	\$107.85	\$102.46	\$97.07	\$92.75	66
			Linear / Horizontal	<a href="#">PE51218</a>	\$189.61	\$180.13	\$170.65	\$163.06	67
			Linear / Horizontal	<a href="#">PE51224</a>	\$199.09	\$189.14	\$179.18	\$171.22	68
617 - 960 1710 - 2700 3400 - 4200 4900 - 6000	1.8:1	1.8 / 2 dBi	vertical	<a href="#">PE51219</a>	\$102.97	\$97.82	\$92.67	\$88.55	69
			vertical	<a href="#">PE51225</a>	\$106.62	\$101.29	\$95.96	\$91.69	70
698 - 960 1350 - 2700 3300 - 4200	2:1	2.2 / 3.5 dBi	Linear	<a href="#">PE51220</a>	\$71.67	\$68.09	\$64.50	\$61.64	71
			Linear	<a href="#">PE51226</a>	\$75.26	\$71.50	\$67.73	\$64.72	72
			Linear / Horizontal	<a href="#">PE51221</a>	\$95.07	\$90.32	\$85.56	\$81.76	73
698 - 960 1710 - 2700	2:1	1.5 / 2.2 dBi	Linear / Horizontal	<a href="#">PE51227</a>	\$99.82	\$94.83	\$89.84	\$85.85	74
			Vertical / Horizontal	<a href="#">PE51222</a>	\$96.50	\$91.68	\$86.85	\$82.99	75
			Vertical / Horizontal	<a href="#">PE51228</a>	\$101.33	\$96.26	\$91.20	\$87.14	76

#### Dome Antennas



RF Frequency Range (MHz)	VSWR	Gain Nominal	Polarization	Model No	1 Pc. Price	See Web for Volume Pricing			ROW
698 - 960 1,710 - 2,700	1.7:1	2 / 5 dBi	Vertical	<a href="#">PE51158</a>	\$39.27	See Web for Volume Pricing			77
800 - 3,000	2:1	3 dBi	Vertical	<a href="#">PE51059</a>	\$444.57				78
		7.5 dBi	Vertical	<a href="#">PE51058</a>	\$357.31				79
806 - 960 1,710 - 2,500	1.5:1	3 dBi	Vertical	<a href="#">PE51096</a>	\$52.77				80

#### Fixed Antennas



RF Frequency Range (MHz)	VSWR	Gain Nominal	Polarization	Model No	1 Pc. Price	See Web for Volume Pricing			ROW
902 - 928	2:1	5 dBi	Vertical	<a href="#">PE51028</a>	\$242.78	See Web for Volume Pricing			81
2,250 - 2,350	1.43:1	3 dB	Vertical	<a href="#">PE51062</a>	\$142.75				82
2,350 - 2,450	1.3:1	3 dBi	Vertical	<a href="#">PE51063</a>	\$307.74				83
2,400 - 2,500	2.1:1	8 dBi	Vertical	<a href="#">PE51172</a>	\$176.57				84
	2:1		Vertical	<a href="#">PE51061</a>	\$283.77				85
2,450 - 2,550	1.43:1	3 dB	Vertical	<a href="#">PE51064</a>	\$169.23				86
3,400 - 3,600	1.5:1	11 dBi	Vertical	<a href="#">PE51034</a>	\$111.77				87
3,450 - 3,550	1.4:1	3 dBi	Vertical	<a href="#">PE51065</a>	\$145.47				88

### Fixed Antennas



RF Frequency Range (MHz)	VSWR	Gain Nominal	Polarization	Model No	1-24	25-49	50-99	100+	ROW
5,470 - 5,725	1.5:1	12 dBi	Vertical	<a href="#">PE51037</a>	\$89.02	\$84.57	\$80.12	\$76.56	89
5,725 - 5,850			Vertical	<a href="#">PE51040</a>	\$126.56	\$120.23	\$113.90	\$108.84	90

### GPS Active Antennas



RF Frequency Range (MHz)	VSWR	Gain Nominal	Polarization	Model No	1 Pc. Price	See Web for Volume Pricing			ROW
824 - 2,170	2.5:1	5 dBic		<a href="#">PE51212</a>	\$13.50		See Web for Volume Pricing		91
1,570 - 1,580	1.3:1	32 dBic	RHCP	<a href="#">PE51067</a>	\$411.16			92	
1,574 - 1,610	2:1	32 dBi	RHCP	<a href="#">PE51TM1000</a>	\$174.10			93	

### GPS Passive Antennas



RF Frequency Range (MHz)	VSWR	Gain Nominal	Polarization	Model No	1 Pc. Price	See Web for Volume Pricing			ROW
1,220 - 1,230 1,530 - 1,580	2:1	6 dBic	RHCP	<a href="#">PE51068</a>	\$1,139.45		See Web for Volume Pricing		94
1,572.42 - 1,578.42	1.5:1	3 dBi	RHCP	<a href="#">PE51066-1</a>	\$140.18			95	
			RHCP	<a href="#">PE51066-2</a>	\$108.25			96	
1,574 - 1,610	2:1	32 dBic		<a href="#">PE51TM1001</a>	\$208.80			97	
1,575 - 1,615		3 dB	RHCP	<a href="#">PE51GPS1004</a>	\$32.05			98	

### Mobile Antennas



RF Frequency Range (MHz)	VSWR	Gain Nominal	Polarization	Model No	1-24	25-49	50-99	100+	ROW
824 - 960 1,710 - 2,200 2,400 - 2,500	2:1	2 / 2 dBi	Vertical	<a href="#">PE51GM1002</a>	\$27.94	\$25.98	\$24.03	\$22.35	99
880 - 965 1,710 - 2,170			Vertical	<a href="#">PE51113-1</a>	\$55.25	\$52.49	\$49.73	\$47.52	1
			Vertical	<a href="#">PE51113-2</a>	\$61.15	\$58.09	\$55.04	\$52.59	2
			Vertical	<a href="#">PE51113-3</a>	\$48.43	\$46.01	\$43.59	\$41.65	3
900 - 960 2,400 - 2,500	1.5:1	3 / 3 dBi	Vertical	<a href="#">PE51113-4</a>	\$50.44	\$47.92	\$45.40	\$43.38	4
			Vertical	<a href="#">PE51MO1001</a>	\$77.99	\$74.09	\$70.19	\$67.07	5
900 - 960 2,400 - 2,500		3 dBi	Vertical	<a href="#">PE51MO1002</a>	\$70.78	\$67.24	\$63.70	\$60.87	6
900 - 960 2,400 - 2,500		3 dBi	Vertical	<a href="#">PE51OM1022</a>	\$101.68	\$96.60	\$91.51	\$87.44	7
902 - 928	2:1	4 dBi	Vertical	<a href="#">PE51027</a>	\$45.69	\$43.41	\$41.12	\$39.29	8
2,400 - 2,500	1.5:1	3 dBi	Vertical	<a href="#">PE51MO1003</a>	\$98.93	\$93.98	\$89.04	\$85.08	9
			Vertical	<a href="#">PE51OM1023</a>	\$95.90	\$91.11	\$86.31	\$82.47	10
			Vertical	<a href="#">PE51MO1004</a>	\$73.17	\$69.51	\$65.85	\$62.93	11
		3 dB	Vertical	<a href="#">PE51136</a>	\$123.50	\$117.33	\$111.15	\$106.21	12

Antennas

See Our Website For Current Pricing & Real-Time Stock Availability!



Technical Support  
+1 (949) 261-1920



Same-Day Shipping,  
Even Custom  
Cable Assemblies



### Omni Antennas



RF Frequency Range (MHz)	VSWR	Gain Nominal	Polarization	Model No	1-24	25-49	50-99	100+	ROW
698 - 960 1,710 - 2,700	1.6:1	4 dBi	Vertical	<a href="#">PE51OM1020</a>	\$61.65	\$58.57	\$55.49	\$53.02	13
824 - 928 900 - 928	1.7:1	8.5 / 10 dBi	Vertical / Horizontal	<a href="#">PE51OM1021</a>	\$818.72	\$777.78	\$736.85	\$704.10	14
824 - 960	1.5:1	6 dBi	Vertical	<a href="#">PE51OM1014</a>	\$82.67	\$78.54	\$74.40	\$71.10	15
		3 / 6 dBi	Vertical	<a href="#">PE51OM1013</a>	\$74.76	\$71.02	\$67.28	\$64.29	16
900 - 928	1.5:1	6 dBi	Vertical	<a href="#">PE51OM1015</a>	\$125.32	\$119.05	\$112.79	\$107.78	17
		8 dBi	Vertical	<a href="#">PE51OM1016</a>	\$182.50	\$173.38	\$164.25	\$156.95	18
	1.6:1	3 / 6 dBi	Vertical	<a href="#">PE51OM1017</a>	\$128.89	\$122.45	\$116.00	\$110.85	19
		6 / 6 dBi	Vertical	<a href="#">PE51OM1018</a>	\$77.99	\$74.09	\$70.19	\$67.07	20
2,400 - 2,500	1.5:1	4 dBi	Vertical	<a href="#">PE51OM1024</a>	\$95.98	\$91.18	\$86.38	\$82.54	21
		7.4 dBi	Vertical	<a href="#">PE51OM1025</a>	\$97.18	\$92.32	\$87.46	\$83.57	22
	2:1	8 dBi	Vertical	<a href="#">PE51OM1026</a>	\$124.11	\$117.90	\$111.70	\$106.73	23
		6 dBi	Vertical / Horizontal	<a href="#">PE51OM1009</a>	\$92.10	\$87.50	\$82.89	\$79.21	24
2,400 - 2,500 5,100 - 5,800	1.6:1	6 / 11 dBi	Vertical / Horizontal	<a href="#">PE51OM1008</a>	\$252.92	\$240.27	\$227.63	\$217.51	25
		6 / 6 dBi	Vertical / Horizontal	<a href="#">PE51OM1010</a>	\$368.53	\$350.10	\$331.68	\$316.94	26
		6 / 9 dBi	Vertical / Horizontal	<a href="#">PE51OM1007</a>	\$313.13	\$297.47	\$281.82	\$269.29	27
		6 / 11 dBi	Vertical / Horizontal	<a href="#">PE51OM1011</a>	\$307.10	\$291.75	\$276.39	\$264.11	28
2,400 - 2,500 5,725 - 5,850	1.6/1.9:1	6 / 11 dBi	Vertical / Horizontal	<a href="#">PE51OM1004</a>	\$388.28	\$368.87	\$349.45	\$333.92	29
	1.5:1	6 / 6 dBi	Vertical	<a href="#">PE51OM1005</a>	\$135.14	\$128.38	\$121.63	\$116.22	30
2,400 - 2,500 4,900 - 5,850	1.6:1	9 / 9 dBi	Vertical	<a href="#">PE51OM1005</a>	\$147.43	\$140.06	\$132.69	\$126.79	31
	1.8:1	4 / 6 dBi	Vertical	<a href="#">PE51OM1012</a>	\$165.85	\$157.56	\$149.27	\$142.63	32
	2.5:1	5 / 6 dBi	Vertical	<a href="#">PE51OM1002</a>	\$59.83	\$56.84	\$53.85	\$51.45	33
		7 / 8 dBi	Vertical	<a href="#">PE51OM1003</a>	\$69.78	\$66.29	\$62.80	\$60.01	34
2,400 - 2,500 5,100 - 5,900	1.8:1	3.5 / 4 dBi	Vertical	<a href="#">PE51OM1001</a>	\$51.58	\$49.00	\$46.42	\$44.36	35
698 - 806 806 - 960		6 / 6 dBi	Vertical / Horizontal	<a href="#">PE51OM1006</a>	\$245.69	\$233.41	\$221.12	\$211.29	36
698 - 806 806 - 960	1.8:1	3 / 3 dBi	Vertical	<a href="#">PE51OM1031</a>	\$69.42	\$65.95	\$62.48	\$59.70	37
			Vertical	<a href="#">PE51OM1032</a>	\$72.88	\$69.24	\$65.59	\$62.68	38

### Panel Antennas



RF Frequency Range (MHz)	VSWR	Gain Nominal	Polarization	Model No	1-24	25-49	50-99	100+	ROW
617 - 698 698 - 960 1,710 - 2,700 3,400 - 4,200 4,900 - 6,000	2:1	5.5 / 6 dBi	±45 Deg. Slant	<a href="#">PE51FP1015</a>	\$313.11	\$297.45	\$281.80	\$269.27	39
698 - 806 806 - 960 1,710 - 2,700 2,200 - 2,700 3,400 - 4,200	1.8:1	5 / 6 dBi	Vertical	<a href="#">PE51FP1016</a>	\$92.13	\$87.52	\$82.92	\$79.23	40

### PCB Antennas



RF Frequency Range (MHz)	VSWR	Gain Nominal	Polarization	Model No	1-24	25-49	50-99	100+	ROW
698 - 960 1,710 - 2,170 2,300 - 2,700	2.5:1	5 / 3 dBi	Vertical	<a href="#">PE51200</a>	\$6.49	\$6.23	\$6.04	\$5.91	41
704 - 960 1,574 - 1,576 1,710 - 2,200 2,496 - 2,690	2:1	3 dBi		<a href="#">PE51199</a>	\$7.31	\$7.02	\$6.80	\$6.65	42

Antennas

See Our Website For Current Pricing & Real-Time Stock Availability!

### PCB Antennas



RF Frequency Range (MHz)	VSWR	Gain Nominal	Polarization	Model No	1-24	25-49	50-99	100+	ROW
824 - 960	3:1	0 dBi	Vertical	<a href="#">PE51195</a>	\$9.35	\$8.98	\$8.70	\$8.51	43
824 - 960 1,710 - 2,200	2.5:1	2 dBi	Vertical	<a href="#">PE51198</a>	\$7.31	\$7.02	\$6.80	\$6.65	44
	2:1			<a href="#">PE51197</a>	\$16.02	\$15.38	\$14.90	\$14.58	45
				<a href="#">PE51196</a>	\$9.35	\$8.98	\$8.70	\$8.51	46
824 - 960 1,710 - 1,880 1,900 - 2,200	3:1	0 dBi	Vertical	<a href="#">PE51194</a>	\$9.35	\$8.98	\$8.70	\$8.51	47
860 - 960	2.3:1	2 dBi	Vertical	<a href="#">PE51216</a>	\$13.92	\$13.36	\$12.95	\$12.67	48
2,400 - 2,500		Vertical / Horizontal	<a href="#">PE51213</a>	\$14.04	\$13.48	\$13.06	\$12.78	49	
	1 dBi	<a href="#">PE51206</a>	\$5.56	\$5.34	\$5.17	\$5.06	50		
	2 dBi	<a href="#">PE51204</a>	\$4.39	\$4.21	\$4.08	\$3.99	51		
	2:1	2 dBi	<a href="#">PE51208</a>	\$5.56	\$5.34	\$5.17	\$5.06	52	
		Vertical	<a href="#">PE51209</a>	\$9.30	\$8.93	\$8.65	\$8.46	53	
		2.6 dBi	<a href="#">PE51205</a>	\$4.39	\$4.21	\$4.08	\$3.99	54	
		<a href="#">PE51207</a>	\$5.56	\$5.34	\$5.17	\$5.06	55		
	3.5 dBi	Vertical	<a href="#">PE51210</a>	\$9.30	\$8.93	\$8.65	\$8.46	56	
2,400 - 2,500 4,900 - 5,900	2.5:1	4.5 / 4.5 dBi	DHCP	<a href="#">PE51203</a>	\$6.96	\$6.68	\$6.47	\$6.33	57
2,400 - 2,500 5,100 - 5,900	2:1	2.5 dBi	Vertical / Horizontal	<a href="#">PE51201</a>	\$6.73	\$6.46	\$6.26	\$6.12	58
		<a href="#">PE51202</a>		\$6.96	\$6.68	\$6.47	\$6.33	59	
	3 / 6 dBi	<a href="#">PE51214</a>	\$17.99	\$17.27	\$16.73	\$16.37	60		
4,900 - 5,900	2:1	4.5 dBi	Horizontal	<a href="#">PE51215</a>	\$16.70	\$16.03	\$15.53	\$15.20	61
5,150 - 5,850		3 dBi	<a href="#">PE51211</a>	\$4.62	\$4.44	\$4.30	\$4.20	62	

### Portable Antennas



RF Frequency Range (MHz)	VSWR	Gain Nominal	Polarization	Model No	1-24	25-49	50-99	100+	ROW
118 - 174	2:1	0 dBi	Vertical	<a href="#">PE51TW1000</a>	\$34.61	\$32.19	\$29.76	\$27.69	63
400 - 420			Vertical	<a href="#">PE51146</a>	\$23.50	\$22.33	\$21.15	\$20.21	64
420 - 450			Vertical	<a href="#">PE51159</a>	\$27.64	\$26.26	\$24.88	\$23.77	65
470 - 512			Vertical	<a href="#">PE51160</a>	\$18.14	\$17.23	\$16.33	\$15.60	66
			Vertical	<a href="#">PE51161</a>	\$22.17	\$21.06	\$19.95	\$19.07	67
615 - 960 1,710 - 2,690	3:1	3 dBi	Vertical	<a href="#">PE51OM1030</a>	\$75.60	\$70.31	\$65.02	\$60.48	68
615 - 960 1,710 - 2,700		3.5 / 3.5 dBi	Vertical	<a href="#">PE51OM1027</a>	\$75.60	\$70.31	\$65.02	\$60.48	69
		Vertical	<a href="#">PE51OM1029</a>	\$75.60	\$70.31	\$65.02	\$60.48	70	
615 - 960 1,400 - 2,700 3,300 - 4,200	3:1	4.5 / 4.5 dBi	Vertical	<a href="#">PE51RD1031</a>	\$22.35	\$20.79	\$19.22	\$17.88	71
615 - 960 1,710 - 2,700 3,300 - 4,200 5,150 - 7,150		3.5 / 2 dBi	Vertical	<a href="#">PE51RD1030</a>	\$31.32	\$29.13	\$26.94	\$25.06	72
617 - 960 1,710 - 2,690	3.5:1	3 dBi	Vertical	<a href="#">PE51OM1028</a>	\$75.60	\$70.31	\$65.02	\$60.48	73
617 - 960 1,427 - 2,700 3,300 - 5,580		2 dBi	Vertical	<a href="#">PE51RD1032</a>	\$26.82	\$24.94	\$23.07	\$21.46	74
698 - 780	2:1	0 dBi	Vertical	<a href="#">PE51157</a>	\$20.99	\$19.94	\$18.89	\$18.05	75
698 - 870	2.3:1	2 dBi	Vertical	<a href="#">PE51154</a>	\$27.31	\$25.94	\$24.58	\$23.49	76
	2:1		Vertical	<a href="#">PE51152</a>	\$22.79	\$21.65	\$20.51	\$19.60	77
698 - 960 1,710 - 2,700	4.5:1	3 dBi	Vertical	<a href="#">PE51RD1027</a>	\$16.80	\$15.62	\$14.45	\$13.44	78
700 - 960 1,710 - 2,170 2,500 - 2,700	2.5:1	4 dBi	Vertical	<a href="#">PE51RD1028</a>	\$16.80	\$15.62	\$14.45	\$13.44	79
760 - 870	2:1	0 dBi	Vertical	<a href="#">PE51166</a>	\$25.66	\$24.38	\$23.09	\$22.07	80
880 - 960			Vertical	<a href="#">PE51164</a>	\$17.67	\$16.79	\$15.90	\$15.20	81
			Vertical	<a href="#">PE51165</a>	\$21.92	\$20.82	\$19.73	\$18.85	82
			Vertical	<a href="#">PE51089-1</a>	\$48.02	\$45.62	\$43.22	\$41.30	83
		Vertical	<a href="#">PE51089-2</a>	\$41.60	\$39.52	\$37.44	\$35.78	84	
890 - 960 1,710 - 1,880		Vertical	<a href="#">PE51089-3</a>	\$39.53	\$37.55	\$35.58	\$34.00	85	
		Vertical	<a href="#">PE51089-4</a>	\$39.78	\$37.79	\$35.80	\$34.21	86	

Antennas

See Our Website For Current Pricing & Real-Time Stock Availability!

### Portable Antennas



Antennas

RF Frequency Range (MHz)	VSWR	Gain Nominal	Polarization	Model No	1 Pc. Price	See Web for Volume Pricing			ROW
900 - 960	1.5:1	0 dBi	Vertical	<a href="#">PE51056</a>	\$51.86	See Web for Volume Pricing			87
	2.1:1	3 dBi	Vertical	<a href="#">PE51055</a>	\$102.92				88
902 - 928	2:1	3.5 dBi	Vertical	<a href="#">PE51026</a>	\$26.39				89
1,700 - 1,850		3.5 dBi	Vertical	<a href="#">PE51119</a>	\$567.22				90
1,700 - 2,500		2 dBi	Vertical	<a href="#">PE51117A</a>	\$771.37				91
		2 dBi	Vertical	<a href="#">PE51173</a>	\$473.34				92
1,900 - 2,500		3.5 dBi	Vertical	<a href="#">PE51121</a>	\$733.73				93
2,200 - 2,500		6 dBi	Vertical	<a href="#">PE51123</a>	\$747.60				94
2,300 - 2,700		6.5 dBi	Vertical	<a href="#">PE51090</a>	\$18.46				95
2,400 - 2,500	1.43:1	3 dBi	Vertical	<a href="#">PE51133</a>	\$197.61				96
	2:1	2.2 dBi	Vertical / Horizontal	<a href="#">PE51077</a>	\$39.71				97
2,400 - 2,500 4,900 - 5,800		2.5:1	5.5 dBi	Vertical	<a href="#">PE51078</a>				\$23.98
	2 dBi		Vertical	<a href="#">PE51088</a>	\$39.71				99
2,400 - 2,500 4,900 - 5,825	2:1	2 dBi	Vertical	<a href="#">PE51087</a>	\$29.71				1
			Vertical	<a href="#">PE51080</a>	\$34.45				2
			Vertical	<a href="#">PE51082</a>	\$26.06				3
		2 / 3 dBi	Vertical	<a href="#">PE51083</a>	\$21.84				4
			Vertical	<a href="#">PE51081</a>	\$26.67				5
			Vertical	<a href="#">PE51142</a>	\$31.21	6			
2,400 - 2,500 5,000 - 5,900	3.5 / 6 dBi	Vertical	<a href="#">PE51143</a>	\$20.57	7				
		Vertical	<a href="#">PE51144</a>	\$19.41	8				
		Vertical	<a href="#">PE51RD1025</a>	\$25.54	9				
2,400 - 7,125	1.7:1	3 dBi	Vertical	<a href="#">PE51RD1026</a>	\$25.54	10			
Vertical			<a href="#">PE51084</a>	\$37.46	11				
3,300 - 3,800	2:1	2 dBi	Vertical	<a href="#">PE51085</a>	\$21.28	12			
3,400 - 3,800		5 dBi	Vertical	<a href="#">PE51135A</a>	\$579.76	13			
4,400 - 5,000		Vertical	<a href="#">PE51134</a>	\$911.91	14				
		3.8 dBi	Vertical	<a href="#">PE51125A</a>	\$573.13	15			
5,250 - 5,850		6 dBi	Vertical	<a href="#">PE51127</a>	\$601.29	16			

### Rubber Duck Antennas



See Our Website For Current Pricing & Real-Time Stock Availability!

RF Frequency Range (MHz)	VSWR	Gain Nominal	Polarization	Model No	1-24	25-49	50-99	100+	ROW		
860 - 960	2:1	3 dBi	Vertical	<a href="#">PE51RD1008</a>	\$24.12	\$22.43	\$20.74	\$19.30	17		
			Vertical	<a href="#">PE51RD1009</a>	\$24.12	\$22.43	\$20.74	\$19.30	18		
900 - 930	2.5:1	5 dBi	Vertical	<a href="#">PE51RD1019</a>	\$33.00	\$30.69	\$28.38	\$26.40	19		
			Vertical	<a href="#">PE51RD1010</a>	\$33.00	\$30.69	\$28.38	\$26.40	20		
			Vertical	<a href="#">PE51RD1011</a>	\$33.00	\$30.69	\$28.38	\$26.40	21		
			Vertical	<a href="#">PE51RD1012</a>	\$33.00	\$30.69	\$28.38	\$26.40	22		
			Linear	<a href="#">PE51RD1018</a>	\$20.10	\$18.69	\$17.29	\$16.08	23		
			Linear	<a href="#">PE51RD1020</a>	\$10.08	\$9.37	\$8.67	\$8.06	24		
2,400 - 2,500	2:1	2 dBi	Linear	<a href="#">PE51RD1022</a>	\$8.19	\$7.62	\$7.04	\$6.55	25		
			Linear	<a href="#">PE51RD1013</a>	\$5.85	\$5.44	\$5.03	\$4.68	26		
		3 dBi	Linear	<a href="#">PE51RD1023</a>	\$5.85	\$5.44	\$5.03	\$4.68	27		
			Linear	<a href="#">PE51RD1024</a>	\$8.19	\$7.62	\$7.04	\$6.55	28		
		4.52 dBi	Linear	<a href="#">PE51RD1014</a>	\$15.98	\$14.86	\$13.74	\$12.78	29		
			Linear	<a href="#">PE51RD1015</a>	\$11.48	\$10.68	\$9.87	\$9.18	30		
			Linear	<a href="#">PE51RD1016</a>	\$15.98	\$14.86	\$13.74	\$12.78	31		
			Vertical	<a href="#">PE51RD1007</a>	\$15.67	\$14.89	\$14.10	\$13.48	32		
		2,400 - 2,500 4,900 - 5,350 5,725 - 5,850	2:1	7 dBi	Linear	<a href="#">PE51RD1017</a>	\$14.93	\$13.88	\$12.84	\$11.94	33
					Vertical	<a href="#">PE51RD1001</a>	\$21.97	\$20.87	\$19.77	\$18.89	34
3 / 3 dBi	Vertical			<a href="#">PE51RD1002</a>	\$21.35	\$20.28	\$19.22	\$18.36	35		
	Vertical			<a href="#">PE51RD1003</a>	\$21.97	\$20.87	\$19.77	\$18.89	36		
	Vertical			<a href="#">PE51RD1004</a>	\$21.54	\$20.46	\$19.39	\$18.52	37		
	Vertical			<a href="#">PE51RD1006</a>	\$33.96	\$32.26	\$30.56	\$29.21	38		
2,400 - 2,500 5,150 - 5,850	4.5 / 7 dBi			Vertical							
3 / 5 dBi					Vertical	<a href="#">PE51RD1005</a>	\$27.15	\$25.79	\$24.44	\$23.35	39
2,400 - 2,483 5,100 - 5,900	2 dBi	Linear									
				<a href="#">PE51RD1021</a>	\$4.68	\$4.35	\$4.02	\$3.74	40		

## Vehicular Antennas

RF Frequency Range (MHz)	VSWR	Gain Nominal	Polarization	Model No	1-24	25-49	50-99	100+	ROW
108 - 520	2:1	2 dBi	Linear, Vertical	<a href="#">PE51MP1000</a>	\$60.03	\$55.83	\$51.63	\$48.02	41
132 - 174	1.5:1	3 dB	Linear, Vertical	<a href="#">PE51MP1001</a>	\$73.53	\$68.38	\$63.24	\$58.82	42
	2:1	2 dBi	Linear, Vertical	<a href="#">PE51MP1002</a>	\$80.40	\$74.77	\$69.14	\$64.32	43
144 - 174	1.5:1	3 dB	Linear, Vertical	<a href="#">PE51MP1004</a>	\$73.53	\$68.38	\$63.24	\$58.82	44
	2:1	2 dBi	Linear, Vertical	<a href="#">PE51MP1003</a>	\$107.17	\$99.67	\$92.17	\$85.74	45
			Linear, Vertical	<a href="#">PE51MP1009</a>	\$80.40	\$74.77	\$69.14	\$64.32	46
380 - 520	1.5:1	3 dB	Linear, Vertical	<a href="#">PE51MP1005</a>	\$73.80	\$68.63	\$63.47	\$59.04	47
420 - 470			Linear, Vertical	<a href="#">PE51MP1006</a>	\$67.96	\$63.20	\$58.45	\$54.37	48
440 - 480	2:1	5 dB	Linear, Vertical	<a href="#">PE51MP1007</a>	\$77.91	\$72.46	\$67.00	\$62.33	49
450 - 520		3 dBd	Linear, Vertical	<a href="#">PE51MP1008</a>	\$83.31	\$77.48	\$71.65	\$66.65	50
746 - 960		2 dBi	Linear, Vertical	<a href="#">PE51MP1011</a>	\$64.70	\$60.17	\$55.64	\$51.76	51
698 - 960	2:1	2 / 3 dBi	Linear, Vertical	<a href="#">PE51MP1010</a>	\$59.40	\$55.24	\$51.08	\$47.52	52
1,710 - 2,150									
2,150 - 2,700	2:1	2 dBi	Vertical	<a href="#">PE51GM1001</a>	\$20.53	\$19.09	\$17.66	\$16.42	53
824 - 960									
1,710 - 1,990									

## Duplexed Antenna Kits

RF Frequency Range (MHz)	VSWR	Contains	Model No	1-24	25-49	50-99	100+	ROW
100 - 180 380 - 520	1.6:1	Duplexer (VHF/UHF 108-174 MHz/380-870 MHz), with integral N-type (m) Connectors (3 ea.); Low Loss 195 NMO mount with cable (1 ea.); RG-58/U NMO mount with cable (1 ea.); Field Tunable Antennas (2 ea.)//RG-58/U Feed Cable (1 ea.)	<a href="#">PE51AK1000</a>	\$272.80	\$253.70	\$234.61	\$218.24	54
		Duplexer (VHF/UHF 108-174MHz/380-870MHz) with integral N-Type (m) Connectors (3 ea.); Low Loss PE51GPS1000 NMO Combination mount with integrated GPS antenna (1 ea.); RG-58/U NMO mount (1 ea.); Field Tunable Antennas (2 ea.); RG-58/U Feed Cable (1 ea.); PE51GPS1000 NMO Combination mount with integrated GPS antenna	<a href="#">PE51AK1001</a>	\$348.99	\$324.56	\$300.13	\$279.19	55
		Duplexer (VHF/UHF 108-174MHz/450-520MHz/746-870MHz) with integral N-Type (m) Connectors (3 ea.); Low Loss PE51GPS1000 NMO Combination mount with integrated GPS antenna (1 ea.); RG-58/U NMO mount (1 ea.); PE51MP1011 multiband antenna (1 ea.); PE51MP1000 tunable VHF/UHF antenna (1 ea.)//RG-58/U Feed Cable (1 ea.)	<a href="#">PE51AK1002</a>	\$454.67	\$422.84	\$391.02	\$363.74	56
		Duplexer (VHF/UHF 108-174MHz/450-520MHz/746-870MHz) with integral N-type (m) Connectors (3 ea.); Low loss 195 NMO mount (1 ea.); RG-58/U NMO mount (1 ea.); PE51MP1011 multiband antenna (1 ea.); PE51MP1000 tunable VHF/UHF antenna (1 ea.); RG-58/U Feed Cable (1 ea.)	<a href="#">PE51AK1003</a>	\$360.46	\$335.23	\$310.00	\$288.37	57

## Antenna Mounts

RF Frequency Range (MHz)	VSWR	Gain Nominal	Description	Model No	1-24	25-49	50-99	100+	ROW
1,166 - 1,606		43 dBi	Multi Band 43dBi Timing GPS/GLNSS Antenna 1,166-1,606 MHz N Type Female Connector	<a href="#">PE51GPS1005</a>	Call	Call	Call	Call	58
1,575 - 1,615	2:1	28 dB	NMO Mount Combo 28 dB GPS Vehicular Antenna NMO Mount/SMA Connectors RG58 cable	<a href="#">PE51GPS1002</a>	\$135.17	\$125.71	\$116.25	\$108.14	59
			NMO Mount Combo 28 dB GPS Vehicular Antenna NMO Mount/SMA Connectors LL195 cable	<a href="#">PE51GPS1003</a>	\$153.61	\$142.86	\$132.10	\$122.89	60
N/A			Base Station Antenna Ground Plane Converter Kit NMO Mount/N Type Connectors	<a href="#">PE51AK1004</a>	\$50.31	\$46.79	\$43.27	\$40.25	61
1,575 - 1,615	2:1	30 dB	NMO Mount Combo 30 dB GPS/GLNSS Vehicular Antenna NMO Mount/SMA Connectors RG58 cable	<a href="#">PE51GPS1000</a>	\$135.17	\$125.71	\$116.25	\$108.14	62
			NMO Mount Combo 30 dB GPS Vehicular Antenna NMO Mount/SMA Connectors LL195 cable	<a href="#">PE51GPS1001</a>	\$153.61	\$142.86	\$132.10	\$122.89	63

Antennas

See Our Website For Current Pricing & Real-Time Stock Availability!



Technical Support  
+1 (949) 261-1920



Same-Day Shipping,  
Even Custom Cable Assemblies



# Attenuators and Equalizers Selection Guide

## 3 Easy Ways to Find your Product.....

### 1. Search by PE Part Number

If you know the PE part number you are searching for, please reference our Part Number Index on Page [395](#).

### 2. Quick Reference Guide

Attenuators & Equalizers

Attenuators.....	<a href="#">68</a>
CMOS, Relay, TTL and USB Controlled Attenuators.....	<a href="#">85</a>
Continuously Variable Attenuators	
50 Ohm.....	<a href="#">85</a>
DC Bias Attenuators	
50 Ohm.....	<a href="#">84</a>
75 Ohm.....	<a href="#">84</a>
Fixed Attenuators	
50 Ohm.....	<a href="#">70</a>
75 Ohm.....	<a href="#">82</a>
Step Attenuators, Push Button	
50 Ohm.....	<a href="#">83</a>
75 Ohm.....	<a href="#">83</a>
Step Attenuators, Rotary	
50 Ohm.....	<a href="#">84</a>
75 Ohm.....	<a href="#">84</a>
Step Attenuators, Toggle	
75 Ohm.....	<a href="#">83</a>
Voltage Variable Attenuators.....	<a href="#">85</a>
Equalizers.....	<a href="#">86</a>

### 3. Attenuators Locator

Connector In-Out	Max Freq.	Power	Model No.	Page		
<b>1.85mm Male</b>						
1.85mm Female	65 GHz	1 W	<a href="#">PE7403</a>	<a href="#">70</a>		
<b>2.4mm Female</b>						
2.4mm Female	40 GHz	0.25 W	<a href="#">PE70A6001</a>	<a href="#">85</a>		
<b>2.4mm Male</b>						
2.4mm Female	50 GHz	1 W	<a href="#">PE7089</a>	<a href="#">70</a>		
<b>2.92mm Female</b>						
2.92mm Female	18 GHz	0.25 W	<a href="#">PE70A5001</a>	<a href="#">85</a>		
		0.1 W	<a href="#">PE70A3901</a>			
	40 GHz	0.25 W	<a href="#">PE70A5002</a>			
<b>2.92mm Male</b>						
2.92mm Female	26.5 GHz	2 W	<a href="#">PE7024</a>	<a href="#">71</a>		
			<a href="#">PE7024/SP</a>			
	40 GHz	0.5 W	<a href="#">PE7AP412</a>		<a href="#">70</a>	
			<a href="#">PE7046</a>			
		<a href="#">PE7AP412</a>				
		<a href="#">PE7088</a>				
		<a href="#">PE7090</a>				
		1 W	<a href="#">PE7395</a>			<a href="#">71</a>
		2 W	<a href="#">PE7395</a>			<a href="#">72</a>
		10 W	<a href="#">PE7AP402</a>			<a href="#">75</a>
<b>4.3-10 Male</b>						
4.3-10 Female	6 GHz	15 W	<a href="#">PE7AP1001</a>	<a href="#">76</a>		
<b>7/16 DIN Female</b>						
7/16 DIN Female	6 GHz	25 W	<a href="#">PE7380</a>	<a href="#">76</a>		
		50 W	<a href="#">PE7313</a>	<a href="#">77</a>		
		100 W	<a href="#">PE7204</a>	<a href="#">79</a>		
	7.5 GHz	25 W	<a href="#">PE7380</a>	<a href="#">76</a>		
				<a href="#">77</a>		
		50 W	<a href="#">PE7313</a>	<a href="#">78</a>		

Connector In-Out	Max Freq.	Power	Model No.	Page
<b>7/16 DIN Female</b>				
7/16 DIN Male	6 GHz	50 W	<a href="#">PE7310</a>	<a href="#">77</a>
	7.5 GHz	50 W	<a href="#">PE7201</a>	<a href="#">79</a>
N Female	6 GHz	50 W	<a href="#">PE7316</a>	<a href="#">78</a>
		100 W	<a href="#">PE7321</a>	<a href="#">80</a>
	7.5 GHz	50 W	<a href="#">PE7212</a>	<a href="#">80</a>
N Male	18 GHz	50 W	<a href="#">PE7316</a>	<a href="#">78</a>
	6 GHz	100 W	<a href="#">PE7321</a>	<a href="#">80</a>
<b>7/16 DIN Male</b>				
7/16 DIN Female	6 GHz	25 W	<a href="#">PE7379</a>	<a href="#">76</a>
		50 W	<a href="#">PE7312</a>	<a href="#">77</a>
		100 W	<a href="#">PE7203</a>	<a href="#">79</a>
	7.5 GHz	5 W	<a href="#">PE7039</a>	<a href="#">74</a>
		10 W	<a href="#">PE7040</a>	<a href="#">75</a>
		25 W	<a href="#">PE7041</a>	<a href="#">76</a>
		50 W	<a href="#">PE7379</a>	<a href="#">76</a>
		50 W	<a href="#">PE7042</a>	<a href="#">77</a>
		50 W	<a href="#">PE7312</a>	<a href="#">77</a>
		100 W	<a href="#">PE7211</a>	<a href="#">79</a>
N Female	6 GHz	100 W	<a href="#">PE7211</a>	<a href="#">79</a>
<b>BNC Female</b>				
BNC Female	0.5 GHz	1 W	<a href="#">PE7008</a>	<a href="#">83</a>
			<a href="#">PE7035</a>	<a href="#">84</a>
	0.75 GHz	1 W	<a href="#">PE7008</a>	<a href="#">83</a>
			<a href="#">PE70A1021</a>	
			<a href="#">PE7008</a>	
	1 GHz	1 W	<a href="#">PE70A1001</a>	<a href="#">84</a>
			<a href="#">PE7034</a>	
	2GHz	2 W	<a href="#">PE7035</a>	<a href="#">84</a>
			<a href="#">PE7034</a>	
	2.2 GHz	2 W	<a href="#">PE70A1024</a>	<a href="#">84</a>
<a href="#">PE70A1022</a>				

# Attenuators Locator

Connector In-Out	Max Freq.	Power	Model No.	Page
<b>BNC Male</b>				
BNC Female	1 GHz	1 W	<a href="#">PE7009</a>	<a href="#">82</a>
		100 W	<a href="#">PE7026</a>	<a href="#">80</a>
	2 GHz	1 W	<a href="#">PE7000</a>	<a href="#">70</a>
		10 W	<a href="#">PE7025</a>	<a href="#">75</a>
4 GHz	2 W	<a href="#">PE7049</a>	<a href="#">72</a>	
			<a href="#">PE7050</a>	<a href="#">82</a>
<b>F Female</b>				
F Female	1 GHz	1 W	<a href="#">PE70A8003</a>	<a href="#">85</a>
			<a href="#">PE70A8004</a>	
			<a href="#">PE70A1008</a>	
	2.15 GHz	0 W	<a href="#">PE70A5011</a>	<a href="#">85</a>
		30 W	<a href="#">PE70A5012</a>	
<b>F Male</b>				
F Female	1 GHz	2 W	<a href="#">PE7057</a>	<a href="#">82</a>
	2 GHz		<a href="#">PE7064</a>	<a href="#">84</a>
	3 GHz		<a href="#">PE7396</a>	<a href="#">82</a>
<b>N Female</b>				
7/16 DIN Female	6 GHz	25 W	<a href="#">PE7369</a>	<a href="#">77</a>
		50 W	<a href="#">PE7315</a>	<a href="#">78</a>
		100 W	<a href="#">PE7206</a>	<a href="#">81</a>
	7.5 GHz	25 W	<a href="#">PE7369</a>	<a href="#">77</a>
		50 W	<a href="#">PE7315</a>	<a href="#">78</a>
7/16 DIN Male	6 GHz	25 W	<a href="#">PE7370</a>	<a href="#">76</a>
		50 W	<a href="#">PE7311</a>	<a href="#">78</a>
		100 W	<a href="#">PE7202</a>	<a href="#">81</a>
	7.5 GHz	25 W	<a href="#">PE7370</a>	<a href="#">76</a>
		50 W	<a href="#">PE7311</a>	<a href="#">78</a>
		50 W	<a href="#">PE7323</a>	<a href="#">79</a>
N Female	6 GHz	100 W	<a href="#">PE7214</a>	<a href="#">81</a>
	8 GHz	25 W	<a href="#">PE7371</a>	<a href="#">77</a>
	18 GHz	50 W	<a href="#">PE7323</a>	<a href="#">79</a>
N Male	6 GHz	50 W	<a href="#">PE7317</a>	<a href="#">79</a>
	18 GHz	50 W	<a href="#">PE7317</a>	<a href="#">79</a>
TNC Female	18 GHz	25 W	<a href="#">PE7372</a>	<a href="#">77</a>
<b>N Male</b>				
7/16 DIN Female	6 GHz	25 W	<a href="#">PE7366</a>	<a href="#">76</a>
		50 W	<a href="#">PE7314</a>	<a href="#">78</a>
		100 W	<a href="#">PE7205</a>	<a href="#">80</a>
	7.5 GHz	25 W	<a href="#">PE7366</a>	<a href="#">76</a>
		50 W	<a href="#">PE7314</a>	<a href="#">78</a>
N Female	1 GHz	1 W	<a href="#">PE7029</a>	<a href="#">82</a>
		300 W	<a href="#">PE7031</a>	
		500 W	<a href="#">PE7032</a>	
		100 W	<a href="#">PE7021</a>	
	1.5 GHz	2 W	<a href="#">PE7062</a>	<a href="#">84</a>
	2 GHz	10 W	<a href="#">PE7010</a>	<a href="#">75</a>
	2.4 GHz	500 W	<a href="#">PE7085</a>	<a href="#">82</a>
	2.5 GHz	1000 W	<a href="#">PE7423</a>	
	3 GHz	1 W	<a href="#">PE7002</a>	<a href="#">71</a>
		5 W	<a href="#">PE7390</a>	<a href="#">74</a>
		10 W	<a href="#">PE7386</a>	<a href="#">75</a>
		50 W	<a href="#">PE7388</a>	<a href="#">78</a>
		100 W	<a href="#">PE7385</a>	<a href="#">80</a>
		200 W	<a href="#">PE7387</a>	<a href="#">81</a>
4 GHz	500 W	<a href="#">PE7AP418</a>	<a href="#">82</a>	
	2 W	<a href="#">PE7044</a>		
	25 W	<a href="#">PE7392</a>	<a href="#">76</a>	
	50 W	<a href="#">PE7394</a>	<a href="#">78</a>	
6 GHz	100 W	<a href="#">PE7421</a>	<a href="#">80</a>	
	5 W	<a href="#">PE7AP006</a>	<a href="#">74</a>	
	50 W	<a href="#">PE7322</a>	<a href="#">78</a>	
8 GHz	100 W	<a href="#">PE7213</a>	<a href="#">80</a>	
	25 W	<a href="#">PE7367</a>	<a href="#">76</a>	
8.5 GHz	150 W	<a href="#">PE7AP150</a>	<a href="#">81</a>	
12.4 GHz	250 W	<a href="#">PE7AP250</a>	<a href="#">82</a>	
18 GHz	10 W	<a href="#">PE7048</a>	<a href="#">75</a>	
	2 W	<a href="#">PE7004</a>	<a href="#">72</a>	
		<a href="#">PE7047</a>		
		<a href="#">PE7014</a>	<a href="#">74</a>	
	5 W	<a href="#">PE7015</a>	<a href="#">75</a>	
		<a href="#">PE7017</a>		
		<a href="#">PE7426</a>	<a href="#">76</a>	
	25 W	<a href="#">PE7367</a>		
		<a href="#">PE7019</a>	<a href="#">78</a>	
		<a href="#">PE7322</a>		
<a href="#">PE7424</a>		<a href="#">80</a>		
100 W	<a href="#">PE7AP200</a>	<a href="#">82</a>		
200 W	<a href="#">PE7237</a>	<a href="#">80</a>		
TNC Female	6 GHz	100 W	<a href="#">PE7237</a>	<a href="#">80</a>
<b>QMA Male</b>				
QMA Female	6 GHz	1 W	<a href="#">PE7AP1002</a>	<a href="#">71</a>

Connector In-Out	Max Freq.	Power	Model No.	Page		
<b>QN Male</b>						
QN Female	3 GHz	1 W	<a href="#">PE7AP1000</a>	<a href="#">71</a>		
<b>SMA Female</b>						
SMA Female	1 GHz	0.5 W	<a href="#">PE70A8000</a>	<a href="#">85</a>		
		1 W	<a href="#">PE70A8001</a>			
	1.5 GHz	1 W	<a href="#">PE70A8005</a>			
	2 GHz	0.5 W	<a href="#">PE70A8002</a>			
	2.2 GHz	2 W	<a href="#">PE70A1025</a>	<a href="#">84</a>		
			<a href="#">PE70A1023</a>			
			<a href="#">PE70A1031</a>			
	3 GHz	0 W	<a href="#">PE70A5004</a>	<a href="#">85</a>		
			<a href="#">PE70A5006</a>			
			<a href="#">PE70A5005</a>			
			<a href="#">PE70A5007</a>			
			<a href="#">PE70A5008</a>			
	4 GHz	5 W	<a href="#">PE70A2000</a>	<a href="#">85</a>		
			<a href="#">PE7422</a>			
	6 GHz	0 W	<a href="#">PE70A1000</a>	<a href="#">85</a>		
			<a href="#">PE70A5009</a>			
			<a href="#">PE70A5013</a>			
			<a href="#">PE70A5010</a>			
			<a href="#">PE70A3902</a>			
			<a href="#">PE70A5000</a>			
	0.1 W	<a href="#">PE7228</a>	<a href="#">81</a>			
	100 W					
	8 GHz	0 W	<a href="#">PE70A2001</a>			
	12 GHz	0 W	<a href="#">PE70A2002</a>	<a href="#">85</a>		
13 GHz	0.16 W	<a href="#">PE70A4000</a>				
	0.32 W	<a href="#">PE70A5003</a>	<a href="#">85</a>			
18 GHz	0 W	<a href="#">PE70A2003</a>	<a href="#">86</a>			
	0.1 W	<a href="#">PE70A3900</a>				
	1 W	<a href="#">PE70A6000</a>				
	20 W	<a href="#">PE70A2900</a>				
	25 W	<a href="#">PE7363</a>		<a href="#">77</a>		
	50 W	<a href="#">PE7337</a>		<a href="#">79</a>		
20 GHz	18 W	<a href="#">PE70A1017</a>	<a href="#">85</a>			
SMA Male	6 GHz	100 W	<a href="#">PE7221</a>	<a href="#">81</a>		
<b>SMA Male</b>						
SMA Female	1.5 GHz	100 W	<a href="#">PE7022</a>	<a href="#">81</a>		
	2 GHz	1 W	<a href="#">PE7161</a>	<a href="#">71</a>		
	2 GHz	2 W	<a href="#">PE7061</a>	<a href="#">84</a>		
		5 W	<a href="#">PE7001</a>	<a href="#">72</a>		
	3 GHz	5 W	<a href="#">PE7391</a>	<a href="#">74</a>		
		25 W	<a href="#">PE7393</a>	<a href="#">77</a>		
	6 GHz	2 W	<a href="#">PE70A1009</a>	<a href="#">72</a>		
			<a href="#">PE70A1010</a>			
			<a href="#">PE70A1011</a>			
			<a href="#">PE70A1012</a>			
			<a href="#">PE70A1014</a>			
			<a href="#">PE70A1015</a>			
			<a href="#">PE7091</a>		<a href="#">73</a>	
			<a href="#">PE7162</a>			
			10 W		<a href="#">PE7428</a>	<a href="#">75</a>
			25 W		<a href="#">PE7357</a>	<a href="#">77</a>
	100 W	<a href="#">PE7227</a>	<a href="#">81</a>			
	12.4 GHz	2 W	<a href="#">PE7045</a>	<a href="#">73</a>		
			<a href="#">PE7005</a>			
			<a href="#">PE7092</a>			
	18 GHz	5 W	<a href="#">PE7013</a>	<a href="#">75</a>		
			10 W	<a href="#">PE7016</a>	<a href="#">76</a>	
			25 W	<a href="#">PE7018</a>	<a href="#">77</a>	
			50 W	<a href="#">PE7357</a>	<a href="#">77</a>	
100 W			<a href="#">PE7020</a>	<a href="#">79</a>		
26 GHz	2 W	<a href="#">PE7427</a>	<a href="#">81</a>			
		<a href="#">PE7425</a>	<a href="#">81</a>			
			<a href="#">PE7087</a>	<a href="#">73</a>		
			<a href="#">PE7087</a>	<a href="#">74</a>		
<b>TNC Female</b>						
N Female	6 GHz	100 W	<a href="#">PE7218</a>	<a href="#">81</a>		
N Male	6 GHz	100 W	<a href="#">PE7210</a>	<a href="#">81</a>		
TNC Female	18 GHz	50 W	<a href="#">PE7351</a>	<a href="#">79</a>		
<b>TNC Male</b>						
TNC Female	1.5 GHz	100 W	<a href="#">PE7056</a>	<a href="#">81</a>		
		1 W	<a href="#">PE7003</a>	<a href="#">71</a>		
	2 GHz	2 W	<a href="#">PE7063</a>	<a href="#">84</a>		
			<a href="#">PE7051</a>	<a href="#">74</a>		
			<a href="#">PE7030</a>	<a href="#">74</a>		
	12.4 GHz	5 W	<a href="#">PE7052</a>	<a href="#">75</a>		
			<a href="#">PE7053</a>	<a href="#">76</a>		
	18 GHz	25 W	<a href="#">PE7054</a>	<a href="#">77</a>		
			<a href="#">PE7375</a>	<a href="#">77</a>		
			<a href="#">PE7055</a>	<a href="#">79</a>		
			10 W	<a href="#">PE7053</a>	<a href="#">76</a>	
			5 W	<a href="#">PE7054</a>	<a href="#">77</a>	

Attenuators & Equalizers



Technical Support  
+1 (949) 261-1920



Same-Day Shipping,  
Even Custom  
Cable Assemblies

# PASSIVE ATTENUATORS

## Fixed Attenuators

50 Ohm

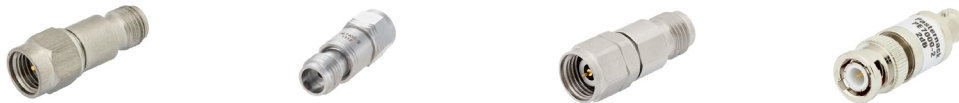

Attenuators & Equalizers

See Our Website For Current Pricing & Real-Time Stock Availability!

Max. Power (Watts)	Connector Input	Connector Output	Max. Freq.	Construction Material	VSWR Max.	Bi-Dir.*	ATTN. (dB)	Model No	1 Pc. Price	See Web for Volume Pricing	ROW				
0.5 W	2.92mm Male	2.92mm Female	40 GHz	Passivated Stainless Steel	1.4:1		0	<a href="#">PE7AP412-00</a>	\$253.32	See Web for Volume Pricing					
							1	<a href="#">PE7AP412-01</a>	\$253.12						
							2	<a href="#">PE7AP412-02</a>	\$253.12						
							3	<a href="#">PE7AP412-03</a>	\$252.23						
						Yes	3	<a href="#">PE7046-3</a>	\$504.51						
						Yes	6	<a href="#">PE7046-6</a>	\$504.51						
						Yes	10	<a href="#">PE7046-10</a>	\$488.43						
						Yes	20	<a href="#">PE7046-20</a>	\$497.06						
						Yes	30	<a href="#">PE7046-30</a>	\$504.51						
							4	<a href="#">PE7AP412-04</a>	\$274.04						
						5	<a href="#">PE7AP412-05</a>	\$263.77							
						6	<a href="#">PE7AP412-06</a>	\$268.53							
						8	<a href="#">PE7AP412-08</a>	\$278.86							
						9	<a href="#">PE7AP412-09</a>	\$264.42							
						10	<a href="#">PE7AP412-10</a>	\$274.04							
					1.5:1								12	<a href="#">PE7AP412-12</a>	\$259.87
													15	<a href="#">PE7AP412-15</a>	\$259.87
													20	<a href="#">PE7AP412-20</a>	\$274.04
													30	<a href="#">PE7AP412-30</a>	\$273.14
						1.65:1	1.85mm Male	1.85mm Female	65 GHz			Passivated Stainless Steel			1
	2	<a href="#">PE7403-2</a>	\$758.96												
	3-3	<a href="#">PE7403-3</a>	\$662.31												
	4	<a href="#">PE7403-4</a>	\$719.68												
	5	<a href="#">PE7403-5</a>	\$730.46												
	6-6	<a href="#">PE7403-6</a>	\$650.47												
	7	<a href="#">PE7403-7</a>	\$719.68												
	8	<a href="#">PE7403-8</a>	\$719.68												
	9	<a href="#">PE7403-9</a>	\$719.68												
	10-10	<a href="#">PE7403-10</a>	\$652.53												
	20-20	<a href="#">PE7403-20</a>	\$662.60												
	30-30	<a href="#">PE7403-30</a>	\$684.54												
Yes	10	<a href="#">PE7089-10</a>	\$411.39												
Yes	12	<a href="#">PE7089-12</a>	\$411.39												
Yes	15	<a href="#">PE7089-15</a>	\$411.39												
Yes	20	<a href="#">PE7089-20</a>	\$411.19												
Yes	30	<a href="#">PE7089-30</a>	\$410.27												
Yes	0	<a href="#">PE7089-0</a>	\$390.10												
Yes	1	<a href="#">PE7089-1</a>	\$411.39												
Yes	2	<a href="#">PE7089-2</a>	\$411.39												
Yes	3	<a href="#">PE7089-3</a>	\$399.76												
Yes	4	<a href="#">PE7089-4</a>	\$390.10												
Yes	5	<a href="#">PE7089-5</a>	\$395.94												
Yes	6	<a href="#">PE7089-6</a>	\$405.47												
Yes	7	<a href="#">PE7089-7</a>	\$390.10												
Yes	8	<a href="#">PE7089-8</a>	\$411.39												
Yes	9	<a href="#">PE7089-9</a>	\$395.94												
1.75:1	2.4mm Male	2.4mm Female	50 GHz	Passivated Stainless Steel			Yes	0	<a href="#">PE7088-0</a>	\$352.53					
							Yes	1	<a href="#">PE7088-1</a>	\$336.52					
							Yes	2	<a href="#">PE7088-2</a>	\$336.52					
							Yes	3	<a href="#">PE7088-3</a>	\$309.00					
							Yes	4	<a href="#">PE7088-4</a>	\$352.53					
							Yes	5	<a href="#">PE7088-5</a>	\$352.53					
							Yes	6	<a href="#">PE7088-6</a>	\$308.78					
							Yes	7	<a href="#">PE7088-7</a>	\$352.53					
							Yes	8	<a href="#">PE7088-8</a>	\$352.53					
							Yes	9	<a href="#">PE7088-9</a>	\$347.33					
							Yes	10	<a href="#">PE7088-10</a>	\$315.94					
							Yes	12	<a href="#">PE7088-12</a>	\$352.53					
							Yes	15	<a href="#">PE7088-15</a>	\$336.52					
							Yes	20	<a href="#">PE7088-20</a>	\$308.78					
							Yes	30	<a href="#">PE7088-30</a>	\$331.55					
1 W	2.92mm Male	2.92mm Female	40 GHz	Passivated Stainless Steel	1.4:1		Yes	1	<a href="#">PE7000-1</a>	\$56.38					
							Yes	2	<a href="#">PE7000-2</a>	\$57.46					
							Yes	3	<a href="#">PE7000-3</a>	\$59.92					
							Yes	6	<a href="#">PE7000-6</a>	\$58.36					
							Yes	10	<a href="#">PE7000-10</a>	\$56.79					
							Yes	20	<a href="#">PE7000-20</a>	\$55.73					
							Yes	30	<a href="#">PE7000-30</a>	\$58.36					
						BNC Male	BNC Female	2 GHz	Nickel Plated Brass	1.2:1		Yes	1	<a href="#">PE7000-1</a>	\$56.38
												Yes	2	<a href="#">PE7000-2</a>	\$57.46
												Yes	3	<a href="#">PE7000-3</a>	\$59.92
	Yes	6	<a href="#">PE7000-6</a>	\$58.36											
	Yes	10	<a href="#">PE7000-10</a>	\$56.79											
	Yes	20	<a href="#">PE7000-20</a>	\$55.73											

\* Bi-Dir is Bi-Directional. If No then Attenuator is Directional. Maximum power applies to input connector only.

## Fixed Attenuators

50 Ohm



Max. Power (Watts)	Connector Input	Connector Output	Max. Freq.	Construction Material	VSWR Max.	Bi-Dir.*	ATTN. (dB)	Model No	1 Pc. Price	See Web for Volume Pricing	ROW		
1 W	N Male	N Female	3 GHz	Nickel Plated Brass	1.2:1	Yes	1	<a href="#">PE7002-1</a>	\$103.53	See Web for Volume Pricing	8		
						Yes	2	<a href="#">PE7002-2</a>	\$103.53				
						Yes	3	<a href="#">PE7002-3</a>	\$91.19				
						Yes	6	<a href="#">PE7002-6</a>	\$93.19				
						Yes	10	<a href="#">PE7002-10</a>	\$91.20				
						Yes	20	<a href="#">PE7002-20</a>	\$93.19				
						Yes	30	<a href="#">PE7002-30</a>	\$93.19				
	Yes	40	<a href="#">PE7002-40</a>	\$103.53									
	QMA Male	QMA Female	6 GHz	Tri-Metal Plated Brass	1.2:1		12	<a href="#">PE7AP1002-12</a>	\$96.65				
							15	<a href="#">PE7AP1002-15</a>	\$100.42				
							0	<a href="#">PE7AP1002-0</a>	\$100.42				
							20	<a href="#">PE7AP1002-20</a>	\$100.42				
							1	<a href="#">PE7AP1002-1</a>	\$96.65				
							2	<a href="#">PE7AP1002-2</a>	\$96.65				
							3	<a href="#">PE7AP1002-3</a>	\$96.65				
							6	<a href="#">PE7AP1002-6</a>	\$100.42				
							9	<a href="#">PE7AP1002-9</a>	\$100.42				
							0	<a href="#">PE7AP1000-0</a>	\$133.67				
	QN Male	QN Female	3 GHz	Tri-Metal Plated Brass	1.2:1		1	<a href="#">PE7AP1000-1</a>	\$133.67				
							2	<a href="#">PE7AP1000-2</a>	\$133.67				
							3	<a href="#">PE7AP1000-3</a>	\$133.67				
							6	<a href="#">PE7AP1000-6</a>	\$140.96				
							9	<a href="#">PE7AP1000-9</a>	\$140.96				
							12	<a href="#">PE7AP1000-12</a>	\$133.67				
							15	<a href="#">PE7AP1000-15</a>	\$133.67				
							18	<a href="#">PE7AP1000-18</a>	\$133.67				
							20	<a href="#">PE7AP1000-20</a>	\$140.96				
						SMA Male	SMA Female	2 GHz	Passivated Stainless Steel		1.2:1	Yes	1
Yes	2	<a href="#">PE7161-2</a>	\$72.58										
Yes	3	<a href="#">PE7161-3</a>	\$70.08										
Yes	4	<a href="#">PE7161-4</a>	\$73.97										
Yes	5	<a href="#">PE7161-5</a>	\$72.58										
Yes	6	<a href="#">PE7161-6</a>	\$66.23										
Yes	8	<a href="#">PE7161-8</a>	\$57.90										
Yes	9	<a href="#">PE7161-9</a>	\$60.51										
Yes	10	<a href="#">PE7161-10</a>	\$71.11										
Yes	12	<a href="#">PE7161-12</a>	\$64.85										
Yes	20	<a href="#">PE7161-20</a>	\$69.20										
Yes	30	<a href="#">PE7161-30</a>	\$71.11										
Yes	40	<a href="#">PE7161-40</a>	\$74.60										
TNC Male	TNC Female		Nickel Plated Brass	1.2:1	Yes					1		<a href="#">PE7003-1</a>	\$90.57
					Yes					10		<a href="#">PE7003-10</a>	\$83.09
					Yes	20	<a href="#">PE7003-20</a>	\$77.80					
					Yes	30	<a href="#">PE7003-30</a>	\$85.37					
					Yes	40	<a href="#">PE7003-40</a>	\$86.25					
					2 W	2.92mm Male	26.5 GHz	Passivated Stainless Steel	1.4:1	Yes	1	<a href="#">PE7024-1</a>	\$331.65
										Yes	2	<a href="#">PE7024-2</a>	\$331.65
Yes	3	<a href="#">PE7024-3</a>	\$321.92										
Yes	6	<a href="#">PE7024-6</a>	\$321.92										
Yes	10	<a href="#">PE7024-10</a>	\$314.06										
Yes	20	<a href="#">PE7024-20</a>	\$321.92										
Yes	30	<a href="#">PE7024-30</a>	\$315.62										
Yes	30	<a href="#">PE7024/SP-30</a>	\$216.75										
40 GHz	Passivated Stainless Steel	1.6:1	Yes	3			<a href="#">PE7090-3</a>	\$464.91					
			Yes	10			<a href="#">PE7090-10</a>	\$433.91					
			Yes	15			<a href="#">PE7090-15</a>	\$464.91					
			Yes	20			<a href="#">PE7090-20</a>	\$433.91					
			Yes	30			<a href="#">PE7090-30</a>	\$419.40					
				0-0			<a href="#">PE7395-0</a>	\$200.00					
				1-1			<a href="#">PE7395-1</a>	\$205.49					
				2-2			<a href="#">PE7395-2</a>	\$205.49					
	3-3	<a href="#">PE7395-3</a>	\$199.97										
	4-4	<a href="#">PE7395-4</a>	\$198.85										
	5-5	<a href="#">PE7395-5</a>	\$198.85										
	6-6	<a href="#">PE7395-6</a>	\$196.81										
	7-7	<a href="#">PE7395-7</a>	\$235.03										
	8-8	<a href="#">PE7395-8</a>	\$235.03										
	9-9	<a href="#">PE7395-9</a>	\$198.85										
	10-10	<a href="#">PE7395-10</a>	\$199.97										
	12-12	<a href="#">PE7395-12</a>	\$211.57										

\* Bi-Dir is Bi-Directional. If No then Attenuator is Directional. Maximum power applies to input connector only.



Technical Support  
+1 (949) 261-1920



Same-Day Shipping,  
Even Custom  
Cable Assemblies

Attenuators & Equalizers

See Our Website For Current Pricing & Real-Time Stock Availability!



## Fixed Attenuators

50 Ohm



Max. Power (Watts)	Connector Input	Connector Output	Max. Freq.	Construction Material	VSWR Max.	Bi-Dir.*	ATTN. (dB)	Model No	1 Pc. Price	See Web for Volume Pricing	ROW
2 W	2.92mm Male	2.92mm Female	40 GHz	Passivated Stainless Steel	1.6:1		15-15	<a href="#">PE7395-15</a>	\$202.28	See Web for Volume Pricing	16
							20-20	<a href="#">PE7395-20</a>	\$205.49		
	BNC Male	BNC Female	4 GHz	Nickel Plated Brass	1.25:1	Yes	1	<a href="#">PE7049-1</a>	\$126.44		17
						Yes	2	<a href="#">PE7049-2</a>	\$125.81		
						Yes	3	<a href="#">PE7049-3</a>	\$119.55		
						Yes	6	<a href="#">PE7049-6</a>	\$119.55		
						Yes	10	<a href="#">PE7049-10</a>	\$130.02		
						Yes	20	<a href="#">PE7049-20</a>	\$119.55		
	N Male	N Female	18 GHz	Passivated Stainless Steel	1.35:1	Yes	1	<a href="#">PE7004-1</a>	\$236.44		18
						Yes	2	<a href="#">PE7004-2</a>	\$235.44		
						Yes	3	<a href="#">PE7004-3</a>	\$220.09		
						Yes	4	<a href="#">PE7004-4</a>	\$235.44		
						Yes	5	<a href="#">PE7004-5</a>	\$236.44		
						Yes	6	<a href="#">PE7004-6</a>	\$216.63		
						Yes	7	<a href="#">PE7004-7</a>	\$232.94		
Yes						8	<a href="#">PE7004-8</a>	\$190.55			
Yes						9	<a href="#">PE7004-9</a>	\$207.70			
Yes						10	<a href="#">PE7004-10</a>	\$202.65			
Yes						12	<a href="#">PE7004-12</a>	\$222.99			
Yes						15	<a href="#">PE7004-15</a>	\$228.46			
Yes						20	<a href="#">PE7004-20</a>	\$220.09			
Yes						30	<a href="#">PE7004-30</a>	\$219.87			
SMA Male	SMA Female	6 GHz	Copper	1.22:1		3	<a href="#">PE70A1009</a>	\$150.86	20		
						3	<a href="#">PE70A1010</a>	\$60.24			
						6	<a href="#">PE70A1011</a>	\$159.67			
			Brass			6	<a href="#">PE70A1012</a>	\$60.24			
						12	<a href="#">PE70A1014</a>	\$60.24			
						16	<a href="#">PE70A1015</a>	\$65.60			
		3 GHz	Passivated Stainless Steel	1.2:1	Yes	1	<a href="#">PE7001-1</a>	\$100.76		26	
					Yes	2	<a href="#">PE7001-2</a>	\$100.76			
					Yes	3	<a href="#">PE7001-3</a>	\$89.93			
					Yes	4	<a href="#">PE7001-4</a>	\$98.93			
					Yes	5	<a href="#">PE7001-5</a>	\$103.53			
					Yes	6	<a href="#">PE7001-6</a>	\$94.95			
					Yes	7	<a href="#">PE7001-7</a>	\$103.53			
					Yes	8	<a href="#">PE7001-8</a>	\$84.77			
Yes	9	<a href="#">PE7001-9</a>	\$94.95								
Yes	10	<a href="#">PE7001-10</a>	\$93.41								
Yes	12	<a href="#">PE7001-12</a>	\$94.95								
Yes	15	<a href="#">PE7001-15</a>	\$94.95								
Yes	20	<a href="#">PE7001-20</a>	\$93.41								
Yes	30	<a href="#">PE7001-30</a>	\$94.95								
Yes	40	<a href="#">PE7001-40</a>	\$103.53								
6 GHz	Passivated Stainless Steel	1.35:1	Yes	0	<a href="#">PE7091-0</a>	\$42.24	27				
			Yes	1	<a href="#">PE7091-1</a>	\$46.55					
			Yes	2	<a href="#">PE7091-2</a>	\$51.47					
			Yes	3	<a href="#">PE7091-3</a>	\$39.84					
			Yes	4	<a href="#">PE7091-4</a>	\$51.47					
			Yes	5	<a href="#">PE7091-5</a>	\$51.41					
			Yes	6	<a href="#">PE7091-6</a>	\$43.09					
			Yes	7	<a href="#">PE7091-7</a>	\$51.47					
			Yes	10	<a href="#">PE7091-10</a>	\$46.75					
			Yes	12	<a href="#">PE7091-12</a>	\$45.62					
Yes	15	<a href="#">PE7091-15</a>	\$44.76								

\* Bi-Dir is Bi-Directional. If No then Attenuator is Directional. Maximum power applies to input connector only.

Attenuators & Equalizers

See Our Website For Current Pricing & Real-Time Stock Availability!

## Fixed Attenuators

50 Ohm



Max. Power (Watts)	Connector Input	Connector Output	Max. Freq.	Construction Material	VSWR Max.	Bi-Dir.*	ATTN. (dB)	Model No	1 Pc. Price	See Web for Volume Pricing	ROW
2 W	SMA Male	SMA Female	6 GHz	Passivated Stainless Steel	1.35:1	Yes	20	<a href="#">PE7091-20</a>	\$45.02	See Web for Volume Pricing	27
						Yes	30	<a href="#">PE7091-30</a>	\$46.78		
						Yes	40	<a href="#">PE7091-40</a>	\$57.05		
						Yes	1	<a href="#">PE7162-1</a>	\$53.71		
						Yes	2	<a href="#">PE7162-2</a>	\$53.60		
						Yes	3	<a href="#">PE7162-3</a>	\$29.56		
						Yes	4	<a href="#">PE7162-4</a>	\$52.64		
						Yes	5	<a href="#">PE7162-5</a>	\$53.29		
						Yes	6	<a href="#">PE7162-6</a>	\$33.67		
						Yes	7	<a href="#">PE7162-7</a>	\$49.72		
						Yes	8	<a href="#">PE7162-8</a>	\$49.72		
						Yes	9	<a href="#">PE7162-9</a>	\$45.52		
						Yes	10	<a href="#">PE7162-10</a>	\$39.97		
						Yes	12	<a href="#">PE7162-12</a>	\$47.36		
						Yes	15	<a href="#">PE7162-15</a>	\$48.26		
						Yes	20	<a href="#">PE7162-20</a>	\$39.80		
						Yes	30	<a href="#">PE7162-30</a>	\$47.44		
						Yes	40	<a href="#">PE7162-40</a>	\$54.74		
						Yes	1	<a href="#">PE7045-1</a>	\$137.46		
						Yes	2	<a href="#">PE7045-2</a>	\$135.80		
			Yes		3	<a href="#">PE7045-3</a>	\$123.34				
			Yes		4	<a href="#">PE7045-4</a>	\$124.58				
			Yes		5	<a href="#">PE7045-5</a>	\$137.46				
			Yes		6	<a href="#">PE7045-6</a>	\$124.86				
			Yes		7	<a href="#">PE7045-7</a>	\$117.10				
			Yes		8	<a href="#">PE7045-8</a>	\$104.97				
			Yes		9	<a href="#">PE7045-9</a>	\$117.10				
			Yes		10	<a href="#">PE7045-10</a>	\$122.05				
			Yes		12	<a href="#">PE7045-12</a>	\$117.10				
			Yes		15	<a href="#">PE7045-15</a>	\$126.73				
			Yes		20	<a href="#">PE7045-20</a>	\$126.73				
			Yes		30	<a href="#">PE7045-30</a>	\$126.73				
			Yes		40	<a href="#">PE7045-40</a>	\$134.15				
			Yes		1	<a href="#">PE7005-1</a>	\$74.13				
			Yes		2	<a href="#">PE7005-2</a>	\$69.20				
			Yes		3	<a href="#">PE7005-3</a>	\$67.46				
			Yes		4	<a href="#">PE7005-4</a>	\$81.15				
			Yes		5	<a href="#">PE7005-5</a>	\$75.52				
			Yes		6	<a href="#">PE7005-6</a>	\$71.39				
			Yes		7	<a href="#">PE7005-7</a>	\$82.03				
Yes	8	<a href="#">PE7005-8</a>	\$82.03								
Yes	9	<a href="#">PE7005-9</a>	\$72.73								
Yes	10	<a href="#">PE7005-10</a>	\$67.46								
Yes	12	<a href="#">PE7005-12</a>	\$76.37								
Yes	15	<a href="#">PE7005-15</a>	\$67.35								
Yes	20	<a href="#">PE7005-20</a>	\$66.97								
Yes	30	<a href="#">PE7005-30</a>	\$69.30								
Yes	40	<a href="#">PE7005-40</a>	\$79.79								
Yes	1	<a href="#">PE7092-1</a>	\$51.41								
Yes	2	<a href="#">PE7092-2</a>	\$51.41								
Yes	3	<a href="#">PE7092-3</a>	\$44.10								
Yes	4	<a href="#">PE7092-4</a>	\$52.80								
Yes	5	<a href="#">PE7092-5</a>	\$53.06								
Yes	6	<a href="#">PE7092-6</a>	\$46.75								
Yes	7	<a href="#">PE7092-7</a>	\$52.63								
Yes	8	<a href="#">PE7092-8</a>	\$49.82								
Yes	9	<a href="#">PE7092-9</a>	\$44.76								
Yes	10	<a href="#">PE7092-10</a>	\$46.75								
Yes	12	<a href="#">PE7092-12</a>	\$45.62								
Yes	15	<a href="#">PE7092-15</a>	\$51.65								
Yes	20	<a href="#">PE7092-20</a>	\$46.75								
Yes	30	<a href="#">PE7092-30</a>	\$45.68								
Yes	40	<a href="#">PE7092-40</a>	\$67.77								
Yes	0	<a href="#">PE7087-0</a>	\$109.45								
Yes	1	<a href="#">PE7087-1</a>	\$123.16								
Yes	2	<a href="#">PE7087-2</a>	\$123.16								
Yes	3	<a href="#">PE7087-3</a>	\$104.36								
Yes	4	<a href="#">PE7087-4</a>	\$122.07								
Yes	5	<a href="#">PE7087-5</a>	\$120.26								
Yes	6	<a href="#">PE7087-6</a>	\$107.86								
			12.4 GHz		1.25:1						28
			18 GHz		1.35:1						29
			26 GHz		1.4:1						30
											31
											32

\* Bi-Dir is Bi-Directional. If No then Attenuator is Directional. Maximum power applies to input connector only.



Technical Support  
+1 (949) 261-1920



Same-Day Shipping,  
Even Custom  
Cable Assemblies

Attenuators & Equalizers

See Our Website For Current Pricing & Real-Time Stock Availability!

## Fixed Attenuators

50 Ohm



Max. Power (Watts)	Connector Input	Connector Output	Max. Freq.	Construction Material	VSWR Max.	Bi-Dir.*	ATTN. (dB)	Model No	1 Pc. Price	See Web for Volume Pricing	ROW		
2 W	SMA Male	SMA Female	26 GHz	Passivated Stainless Steel	1.4:1	Yes	7	<a href="#">PE7087-7</a>	\$122.07	See Web for Volume Pricing	32		
						Yes	8	<a href="#">PE7087-8</a>	\$122.07				
						Yes	9	<a href="#">PE7087-9</a>	\$115.22				
						Yes	10	<a href="#">PE7087-10</a>	\$106.27				
						Yes	12	<a href="#">PE7087-12</a>	\$116.59				
						Yes	15	<a href="#">PE7087-15</a>	\$123.16				
						Yes	20	<a href="#">PE7087-20</a>	\$107.86				
	TNC Male	TNC Female	2 GHz	Nickel Plated Brass	1.15:1	Yes	2	<a href="#">PE7003-2</a>	\$80.80				
						Yes	3	<a href="#">PE7003-3</a>	\$76.22				
						Yes	6	<a href="#">PE7003-6</a>	\$85.37				
						Yes	1	<a href="#">PE7051-1</a>	\$185.62				
						Yes	2	<a href="#">PE7051-2</a>	\$185.62				
						Yes	3	<a href="#">PE7051-3</a>	\$165.22				
						Yes	6	<a href="#">PE7051-6</a>	\$169.98				
			12.4 GHz	Nickel Plated Brass	1.25:1	Yes	10	<a href="#">PE7051-10</a>	\$170.96				
						Yes	20	<a href="#">PE7051-20</a>	\$189.48				
						Yes	30	<a href="#">PE7051-30</a>	\$183.88				
						Yes	40	<a href="#">PE7051-40</a>	\$170.29				
						18 GHz	Passivated Stainless Steel	1.35:1	Yes		1	<a href="#">PE7030-1</a>	\$268.86
									Yes		2	<a href="#">PE7030-2</a>	\$307.42
									Yes		3	<a href="#">PE7030-3</a>	\$319.42
Yes	6	<a href="#">PE7030-6</a>	\$319.42										
Yes	10	<a href="#">PE7030-10</a>	\$319.42										
Yes	20	<a href="#">PE7030-20</a>	\$322.63										
Yes	30	<a href="#">PE7030-30</a>	\$293.06										
7/16 DIN Male	7/16 DIN Female	7.5 GHz	Tri-Metal Plated Brass	1.25:1	Yes	3	<a href="#">PE7039-3</a>	\$224.06					
					Yes	6	<a href="#">PE7039-6</a>	\$224.06					
					Yes	10	<a href="#">PE7039-10</a>	\$244.23					
					Yes	20	<a href="#">PE7039-20</a>	\$224.06					
					Yes	30	<a href="#">PE7039-30</a>	\$291.03					
					N Male	N Female	3 GHz	Aluminum	1.2:1	Yes	1	<a href="#">PE7390-1</a>	\$74.15
Yes	2	<a href="#">PE7390-2</a>	\$74.15										
Yes	3	<a href="#">PE7390-3</a>	\$69.28										
Yes	6	<a href="#">PE7390-6</a>	\$69.28										
Yes	10	<a href="#">PE7390-10</a>	\$69.48										
Yes	15	<a href="#">PE7390-15</a>	\$68.36										
Yes	20	<a href="#">PE7390-20</a>	\$69.28										
6 GHz	Black Anodized Aluminum Heatsink	1.25:1	Yes	30			<a href="#">PE7390-30</a>	\$67.98					
			Yes	1			<a href="#">PE7AP006-01</a>	\$114.40					
			Yes	2			<a href="#">PE7AP006-02</a>	\$118.87					
			Yes	3			<a href="#">PE7AP006-03</a>	\$113.15					
			Yes	4			<a href="#">PE7AP006-04</a>	\$118.87					
			Yes	5			<a href="#">PE7AP006-05</a>	\$118.87					
			Yes	6			<a href="#">PE7AP006-06</a>	\$113.15					
18 GHz	Black Anodized Aluminum Heatsink	1.4:1	Yes	9	<a href="#">PE7AP006-09</a>	\$109.78							
			Yes	10	<a href="#">PE7AP006-10</a>	\$114.06							
			Yes	12	<a href="#">PE7AP006-12</a>	\$109.78							
			Yes	15	<a href="#">PE7AP006-15</a>	\$103.40							
			Yes	20	<a href="#">PE7AP006-20</a>	\$144.56							
			Yes	30	<a href="#">PE7AP006-30</a>	\$114.06							
			Yes	40	<a href="#">PE7AP006-40</a>	\$125.48							
SMA Male	SMA Female	3 GHz	Aluminum	1.2:1	Yes	1	<a href="#">PE7014-1</a>	\$318.86					
					Yes	2	<a href="#">PE7014-2</a>	\$318.86					
					Yes	3	<a href="#">PE7014-3</a>	\$335.10					
					Yes	6	<a href="#">PE7014-6</a>	\$335.10					
					Yes	10	<a href="#">PE7014-10</a>	\$328.96					
					Yes	20	<a href="#">PE7014-20</a>	\$335.10					
					Yes	30	<a href="#">PE7014-30</a>	\$328.96					
					Yes	40	<a href="#">PE7014-40</a>	\$347.55					
					Black Anodized Aluminum Heatsink	Yes	1	<a href="#">PE7391-1</a>	\$71.84				
						Yes	2	<a href="#">PE7391-2</a>	\$74.15				
Yes	3	<a href="#">PE7391-3</a>	\$68.36										
Yes	6	<a href="#">PE7391-6</a>	\$68.36										
Aluminum	Yes	10	<a href="#">PE7391-10</a>	\$68.36									
	Yes	15	<a href="#">PE7391-15</a>	\$68.36									
	Yes	20	<a href="#">PE7391-20</a>	\$69.28									
Yes	30	<a href="#">PE7391-30</a>	\$67.98										

\* Bi-Dir is Bi-Directional. If No then Attenuator is Directional. Maximum power applies to input connector only.

Attenuators & Equalizers

See Our Website For Current Pricing & Real-Time Stock Availability!

## Fixed Attenuators

50 Ohm



Max. Power (Watts)	Connector Input	Connector Output	Max. Freq.	Construction Material	VSWR Max.	Bi-Dir.*	ATTN. (dB)	Model No	1 Pc. Price	See Web for Volume Pricing	ROW
5 W	SMA Male	SMA Female	18 GHz	Black Anodized Aluminum Heatsink	1.35:1	Yes	1	<a href="#">PE7013-1</a>	\$188.98	See Web for Volume Pricing	41
						Yes	2	<a href="#">PE7013-2</a>	\$198.07		
						Yes	3	<a href="#">PE7013-3</a>	\$178.05		
						Yes	6	<a href="#">PE7013-6</a>	\$182.82		
						Yes	10	<a href="#">PE7013-10</a>	\$178.26		
						Yes	20	<a href="#">PE7013-20</a>	\$183.18		
						Yes	30	<a href="#">PE7013-30</a>	\$178.05		
	Yes	40	<a href="#">PE7013-40</a>	\$199.07							
	TNC Male	TNC Female	18 GHz	Black Anodized Aluminum Heatsink	1.35:1	Yes	1	<a href="#">PE7052-1</a>	\$317.64		
						Yes	2	<a href="#">PE7052-2</a>	\$330.35		
						Yes	3	<a href="#">PE7052-3</a>	\$330.35		
						Yes	6	<a href="#">PE7052-6</a>	\$330.35		
						Yes	10	<a href="#">PE7052-10</a>	\$330.35		
						Yes	20	<a href="#">PE7052-20</a>	\$330.35		
Yes						30	<a href="#">PE7052-30</a>	\$330.28			
10 W	2.92mm Male	2.92mm Female	40 GHz	Black Anodized Aluminum Heatsink	1.5:1	No	10	<a href="#">PE7AP402-10</a>	\$1,039.72		
						No	20	<a href="#">PE7AP402-20</a>	\$984.98		
						Yes	3	<a href="#">PE7AP402-3</a>	\$1,022.76		
	7/16 DIN Male	7/16 DIN Female	7.5 GHz		1.45:1	Yes	6	<a href="#">PE7AP402-6</a>	\$1,022.73		
						No	30	<a href="#">PE7AP402-30</a>	\$1,039.72		
						Yes	6	<a href="#">PE7040-6</a>	\$318.76		
	BNC Male	BNC Female	2 GHz		1.6:1	Yes	10	<a href="#">PE7040-10</a>	\$368.21		
						Yes	20	<a href="#">PE7040-20</a>	\$209.29		
						Yes	2	<a href="#">PE7025-2</a>	\$341.71		
						Yes	3	<a href="#">PE7025-3</a>	\$360.01		
						Yes	6	<a href="#">PE7025-6</a>	\$343.50		
						Yes	10	<a href="#">PE7025-10</a>	\$353.41		
						Yes	20	<a href="#">PE7025-20</a>	\$348.19		
						Yes	30	<a href="#">PE7025-30</a>	\$336.87		
Yes				40		<a href="#">PE7025-40</a>	\$395.19				
Yes				2		<a href="#">PE7010-2</a>	\$250.28				
Yes				3		<a href="#">PE7010-3</a>	\$261.35				
N Male	N Female	3 GHz	1.2:1	Yes	6	<a href="#">PE7010-6</a>	\$261.35				
				Yes	10	<a href="#">PE7010-10</a>	\$261.35				
				Yes	20	<a href="#">PE7010-20</a>	\$261.35				
				Yes	30	<a href="#">PE7010-30</a>	\$260.37				
				Yes	40	<a href="#">PE7010-40</a>	\$217.67				
				Yes	3	<a href="#">PE7386-3</a>	\$156.51				
				Yes	6	<a href="#">PE7386-6</a>	\$158.86				
				Yes	10	<a href="#">PE7386-10</a>	\$158.86				
				Yes	15	<a href="#">PE7386-15</a>	\$130.63				
				Yes	20	<a href="#">PE7386-20</a>	\$158.86				
				Yes	30	<a href="#">PE7386-30</a>	\$158.86				
SMA Male	SMA Female	12.4 GHz	1.35:1	Yes	40	<a href="#">PE7386-40</a>	\$170.29				
				Yes	1	<a href="#">PE7048-1</a>	\$414.54				
				Yes	2	<a href="#">PE7048-2</a>	\$414.54				
				Yes	3	<a href="#">PE7048-3</a>	\$409.84				
				Yes	6	<a href="#">PE7048-6</a>	\$408.25				
		18 GHz		1.4:1	Yes	10	<a href="#">PE7048-10</a>	\$402.32			
					Yes	20	<a href="#">PE7048-20</a>	\$402.92			
					Yes	30	<a href="#">PE7048-30</a>	\$391.98			
					Yes	40	<a href="#">PE7048-40</a>	\$402.92			
					Yes	1	<a href="#">PE7015-1</a>	\$314.13			
					Yes	2	<a href="#">PE7015-2</a>	\$328.49			
6 GHz	1.2:1	6 GHz	Yes	3	<a href="#">PE7015-3</a>	\$402.92					
			Yes	6	<a href="#">PE7015-6</a>	\$403.87					
			Yes	10	<a href="#">PE7015-10</a>	\$396.97					
			Yes	20	<a href="#">PE7015-20</a>	\$390.26					
			Yes	30	<a href="#">PE7015-30</a>	\$403.87					
			Yes	40	<a href="#">PE7015-40</a>	\$414.81					
			1	<a href="#">PE7428-01</a>	\$185.89						
			2	<a href="#">PE7428-02</a>	\$170.49						
			3	<a href="#">PE7428-03</a>	\$166.12						
			6	<a href="#">PE7428-06</a>	\$219.12						
18 GHz	1.4:1	10	<a href="#">PE7428-10</a>	\$172.60							
		15	<a href="#">PE7428-15</a>	\$172.60							
20	<a href="#">PE7428-20</a>	\$172.60									
30	<a href="#">PE7428-30</a>	\$172.60									
Yes	1	<a href="#">PE7016-1</a>	\$402.32								
Yes	2	<a href="#">PE7016-2</a>	\$367.67								

Attenuators & Equalizers

See Our Website For Current Pricing & Real-Time Stock Availability!

\* Bi-Dir is Bi-Directional. If No then Attenuator is Directional. Maximum power applies to input connector only.



Technical Support  
+1 (949) 261-1920



Same-Day Shipping,  
Even Custom  
Cable Assemblies



## Fixed Attenuators

50 Ohm



Max. Power (Watts)	Connector Input	Connector Output	Max. Freq.	Construction Material	VSWR Max.	Bi-Dir.*	ATTN. (dB)	Model No	1 Pc. Price	See Web for Volume Pricing	ROW	
10 W	SMA Male	SMA Female	18 GHz	Black Anodized Aluminum Heatsink	1.4:1	Yes	3	<a href="#">PE7016-3</a>	\$380.10	See Web for Volume Pricing	51	
						Yes	6	<a href="#">PE7016-6</a>	\$372.79			
						Yes	10	<a href="#">PE7016-10</a>	\$371.17			
						Yes	20	<a href="#">PE7016-20</a>	\$372.98			
	Yes	30				<a href="#">PE7016-30</a>	\$380.10					
	Yes	40				<a href="#">PE7016-40</a>	\$402.92					
	Yes	6				<a href="#">PE7053-6</a>	\$461.14					
	Yes	10				<a href="#">PE7053-10</a>	\$472.16					
TNC Male	TNC Female	Yes	20	<a href="#">PE7053-20</a>	\$513.28							
		Yes	40	<a href="#">PE7053-40</a>	\$505.56							
		Yes	10	<a href="#">PE7AP1001-10</a>	\$342.85							
		Yes	3	<a href="#">PE7AP1001-3</a>	\$312.38							
15 W	4.3-10 Male	4.3-10 Female	6 GHz	Aluminum	1.15:1	Yes	6	<a href="#">PE7AP1001-6</a>	\$312.38		53	
						Yes	20	<a href="#">PE7AP1001-20</a>	\$312.38			
						Yes	3	<a href="#">PE7379-3</a>	\$473.89			
						Yes	6	<a href="#">PE7379-6</a>	\$473.89			
25 W	7/16 DIN Male	7/16 DIN Female	6 GHz	Black Anodized Aluminum Heatsink	1.3:1	Yes	50	<a href="#">PE7379-50</a>	\$473.89		54	
						Yes	10	<a href="#">PE7041-10</a>	\$618.25			
						Yes	10	<a href="#">PE7379-10</a>	\$619.79			
						Yes	20	<a href="#">PE7379-20</a>	\$497.10			
						Yes	30	<a href="#">PE7379-30</a>	\$473.89			
						Yes	40	<a href="#">PE7379-40</a>	\$473.89			
			7.5 GHz		1.45:1	Yes	3	<a href="#">PE7379-3</a>	\$480.99			
						Yes	6	<a href="#">PE7379-6</a>	\$473.89			
						6 GHz	1.3:1	Yes	50	<a href="#">PE7380-50</a>		\$480.74
								Yes	3	<a href="#">PE7380-3</a>		\$480.74
								Yes	6	<a href="#">PE7380-6</a>		\$480.74
								Yes	10	<a href="#">PE7380-10</a>		\$480.74
	Yes	20	<a href="#">PE7380-20</a>		\$480.74							
	Yes	30	<a href="#">PE7380-30</a>		\$480.74							
	7.5 GHz	1.45:1	Yes		40	<a href="#">PE7380-40</a>	\$480.74					
			6 GHz		1.3:1	Yes	50	<a href="#">PE7366-50</a>	\$419.53			
						Yes	10	<a href="#">PE7366-10</a>	\$419.53			
						Yes	20	<a href="#">PE7366-20</a>	\$419.53			
						Yes	30	<a href="#">PE7366-30</a>	\$442.42			
						Yes	40	<a href="#">PE7366-40</a>	\$442.42			
	7.5 GHz	1.45:1				Yes	3	<a href="#">PE7366-3</a>	\$419.53			
			Yes		6	<a href="#">PE7366-6</a>	\$419.53					
			4 GHz		1.25:1	Yes	1	<a href="#">PE7392-1</a>	\$227.43			
						Yes	2	<a href="#">PE7392-2</a>	\$227.43			
Yes				3		<a href="#">PE7392-3</a>	\$213.25					
Yes				6		<a href="#">PE7392-6</a>	\$216.00					
Yes	10	<a href="#">PE7392-10</a>		\$216.00								
Yes	20	<a href="#">PE7392-20</a>		\$216.91								
8 GHz	1.6:1	Yes	30	<a href="#">PE7392-30</a>	\$216.91							
		Yes	40	<a href="#">PE7392-40</a>	\$227.43							
		Yes	50	<a href="#">PE7367-50</a>	\$490.27							
		N Male	1.4:1	Yes	1	<a href="#">PE7017-1</a>	\$581.34					
				Yes	2	<a href="#">PE7017-2</a>	\$670.51					
				Yes	3	<a href="#">PE7017-3</a>	\$590.05					
Yes	6			<a href="#">PE7017-6</a>	\$585.68							
Yes	10			<a href="#">PE7017-10</a>	\$590.05							
Yes	20			<a href="#">PE7017-20</a>	\$581.34							
N Female	7/16 DIN Male	18 GHz	Yes	30	<a href="#">PE7017-30</a>	\$590.05						
			Yes	40	<a href="#">PE7017-40</a>	\$684.32						
			Yes	3	<a href="#">PE7426-03</a>	\$340.76						
			Yes	6	<a href="#">PE7426-06</a>	\$346.26						
			Yes	10	<a href="#">PE7367-10</a>	\$485.57						
			Yes	10	<a href="#">PE7426-10</a>	\$354.45						
			Yes	20	<a href="#">PE7367-20</a>	\$485.57						
			Yes	20	<a href="#">PE7426-20</a>	\$360.08						
			Yes	30	<a href="#">PE7367-30</a>	\$473.72						
			Yes	30	<a href="#">PE7426-30</a>	\$346.23						
			Yes	40	<a href="#">PE7367-40</a>	\$490.27						
			Yes	40	<a href="#">PE7426-40</a>	\$371.34						
6 GHz	1.3:1	Yes	3	<a href="#">PE7367-3</a>	\$485.57							
		Yes	6	<a href="#">PE7367-6</a>	\$485.57							
		Yes	50	<a href="#">PE7370-50</a>	\$411.23							
		Yes	3	<a href="#">PE7370-3</a>	\$411.23							
7.5 GHz	1.45:1	Yes	6	<a href="#">PE7370-6</a>	\$411.23							
		Yes	10	<a href="#">PE7370-10</a>	\$411.23							
		Yes	20	<a href="#">PE7370-20</a>	\$411.23							
		Yes	20	<a href="#">PE7370-20</a>	\$411.23							

\* Bi-Dir is Bi-Directional. If No then Attenuator is Directional. Maximum power applies to input connector only.

Attenuators & Equalizers

See Our Website For Current Pricing & Real-Time Stock Availability!

## Fixed Attenuators

50 Ohm



Max. Power (Watts)	Connector Input	Connector Output	Max. Freq.	Construction Material	VSWR Max.	Bi-Dir.*	ATTN. (dB)	Model No	1 Pc. Price	See Web for Volume Pricing	ROW	
25 W	N Female	7/16 DIN Male	7.5 GHz	Black Anodized Aluminum Heatsink	1.45:1	Yes	30	<a href="#">PE7370-30</a>	\$411.23	See Web for Volume Pricing	72	
		7/16 DIN Female	7.5 GHz		1.3:1	Yes	40	<a href="#">PE7370-40</a>	\$411.23		73	
					1.45:1	Yes	50	<a href="#">PE7369-50</a>	\$418.08		74	
						Yes	10	<a href="#">PE7369-10</a>	\$418.08			
						Yes	20	<a href="#">PE7369-20</a>	\$418.08			
						Yes	30	<a href="#">PE7369-30</a>	\$418.08			
						Yes	40	<a href="#">PE7369-40</a>	\$418.08			
		Yes	3			<a href="#">PE7369-3</a>	\$418.08					
		N Female	8 GHz		1.6:1	Yes	50	<a href="#">PE7371-50</a>	\$393.24		75	
						Yes	10	<a href="#">PE7371-10</a>	\$461.11			
						1.6:1	Yes	3	<a href="#">PE7371-3</a>			\$461.11
							Yes	6	<a href="#">PE7371-6</a>			\$461.11
							Yes	20	<a href="#">PE7371-20</a>			\$460.57
							Yes	30	<a href="#">PE7371-30</a>			\$460.57
	Yes	40	<a href="#">PE7371-40</a>	\$478.85								
	Yes	30	<a href="#">PE7372-30</a>	\$401.46	76							
	SMA Male	SMA Female	4 GHz	1.25:1	Yes	3	<a href="#">PE7393-3</a>	\$167.92	77			
					Yes	10	<a href="#">PE7393-10</a>	\$206.54				
					Yes	20	<a href="#">PE7393-20</a>	\$206.54				
					Yes	30	<a href="#">PE7393-30</a>	\$206.54				
					Yes	40	<a href="#">PE7393-40</a>	\$224.07				
					1.3:1	Yes	50	<a href="#">PE7357-50</a>			\$362.55	
						Yes	1	<a href="#">PE7018-1</a>			\$570.27	
		Yes	2	<a href="#">PE7018-2</a>		\$570.27						
		Yes	3	<a href="#">PE7018-3</a>		\$650.58						
		Yes	6	<a href="#">PE7018-6</a>		\$640.98						
		Yes	10	<a href="#">PE7018-10</a>		\$650.58						
		Yes	20	<a href="#">PE7018-20</a>		\$572.50						
1.4:1		Yes	30	<a href="#">PE7018-30</a>	\$650.58							
		Yes	40	<a href="#">PE7018-40</a>	\$684.32							
	1.6:1	Yes	10	<a href="#">PE7357-10</a>	\$445.94							
		Yes	20	<a href="#">PE7357-20</a>	\$362.55							
		Yes	30	<a href="#">PE7357-30</a>	\$445.94							
		Yes	40	<a href="#">PE7357-40</a>	\$455.98							
		Yes	3	<a href="#">PE7357-3</a>	\$445.94							
Yes		6	<a href="#">PE7357-6</a>	\$345.63								
Yes		10	<a href="#">PE7363-10</a>	\$442.09								
SMA Female	18 GHz	1.6:1	Yes	20	<a href="#">PE7363-20</a>	\$442.09	78					
			Yes	30	<a href="#">PE7363-30</a>	\$442.09						
			Yes	6	<a href="#">PE7363-6</a>	\$435.57						
			Yes	40	<a href="#">PE7363-40</a>	\$478.85						
			Yes	10	<a href="#">PE7054-10</a>	\$818.90						
			Yes	20	<a href="#">PE7054-20</a>	\$775.78						
			Yes	30	<a href="#">PE7054-30</a>	\$775.78						
TNC Male	TNC Female	1.4:1	Yes	20	<a href="#">PE7375-20</a>	\$426.54	79					
			Yes	30	<a href="#">PE7375-30</a>	\$406.62						
			Yes	40	<a href="#">PE7375-40</a>	\$421.69						
			1.6:1	No	50	<a href="#">PE7312-50</a>		\$523.42				
				No	10	<a href="#">PE7042-10</a>		\$717.13				
				No	30	<a href="#">PE7042-30</a>		\$661.69				
				No	3	<a href="#">PE7312-3</a>		\$549.08				
No	6	<a href="#">PE7312-6</a>		\$523.42								
No	10	<a href="#">PE7312-10</a>		\$549.08								
No	20	<a href="#">PE7312-20</a>		\$551.97								
7/16 DIN Male	7/16 DIN Female	6 GHz	1.3:1	No	50	<a href="#">PE7310-50</a>	\$523.42	80				
				No	3	<a href="#">PE7310-3</a>	\$549.08					
				No	6	<a href="#">PE7310-6</a>	\$523.42					
				No	10	<a href="#">PE7310-10</a>	\$549.08					
				No	20	<a href="#">PE7310-20</a>	\$523.42					
				No	30	<a href="#">PE7310-30</a>	\$523.42					
				No	40	<a href="#">PE7310-40</a>	\$523.42					
	7.5 GHz	1.45:1	No	50	<a href="#">PE7313-50</a>	\$530.30						
			No	3	<a href="#">PE7313-3</a>	\$530.30						
			No	6	<a href="#">PE7313-6</a>	\$626.34						
			No	10	<a href="#">PE7313-10</a>	\$530.30						
			1.45:1	No	10	<a href="#">PE7312-10</a>	\$549.08					
				No	20	<a href="#">PE7312-20</a>	\$523.42					
				No	30	<a href="#">PE7312-30</a>	\$523.42					
No	40	<a href="#">PE7312-40</a>		\$523.42								
No	50	<a href="#">PE7313-50</a>		\$530.30								
No	3	<a href="#">PE7313-3</a>		\$530.30								
No	6	<a href="#">PE7313-6</a>		\$626.34								
50 W	7/16 DIN Male	7/16 DIN Female	6 GHz	1.3:1	No	50	<a href="#">PE7310-50</a>	\$523.42	81			
					No	3	<a href="#">PE7310-3</a>	\$549.08				
					No	6	<a href="#">PE7310-6</a>	\$523.42				
					No	10	<a href="#">PE7310-10</a>	\$549.08				
					No	20	<a href="#">PE7310-20</a>	\$523.42				
					No	30	<a href="#">PE7310-30</a>	\$523.42				
					No	40	<a href="#">PE7310-40</a>	\$523.42				
	7.5 GHz	1.45:1	No	50	<a href="#">PE7313-50</a>	\$530.30						
			No	3	<a href="#">PE7313-3</a>	\$530.30						
			No	6	<a href="#">PE7313-6</a>	\$626.34						
			No	10	<a href="#">PE7313-10</a>	\$530.30						
			1.45:1	No	10	<a href="#">PE7312-10</a>	\$549.08					
				No	20	<a href="#">PE7312-20</a>	\$523.42					
				No	30	<a href="#">PE7312-30</a>	\$523.42					
No	40	<a href="#">PE7312-40</a>		\$523.42								
No	50	<a href="#">PE7313-50</a>		\$530.30								
No	3	<a href="#">PE7313-3</a>		\$530.30								
No	6	<a href="#">PE7313-6</a>		\$626.34								

\* Bi-Dir is Bi-Directional. If No then Attenuator is Directional. Maximum power applies to input connector only.



Technical Support  
+1 (949) 261-1920



Same-Day Shipping,  
Even Custom  
Cable Assemblies

Attenuators & Equalizers

See Our Website For Current Pricing & Real-Time Stock Availability!

## Fixed Attenuators

**50 Ohm**



**Attenuators & Equalizers**

**See Our Website For Current Pricing & Real-Time Stock Availability!**

Max. Power (Watts)	Connector Input	Connector Output	Max. Freq.	Construction Material	VSWR Max.	Bi-Dir.*	ATTN. (dB)	Model No	1 Pc. Price	See Web for Volume Pricing	ROW	
50 W	7/16 DIN Female	7/16 DIN Female	7.5 GHz	Black Anodized Aluminum Heatsink	1.45:1	No	20	<a href="#">PE7313-20</a>	\$530.30	See Web for Volume Pricing	87	
		N Female	6 GHz			1.3:1	No	30	<a href="#">PE7313-30</a>			\$530.30
							No	40	<a href="#">PE7313-40</a>			\$626.34
					No		50	<a href="#">PE7316-50</a>	\$492.04			
			7.5 GHz		1.45:1	No	50	<a href="#">PE7321-50</a>	\$467.67			
						No	3	<a href="#">PE7316-3</a>	\$469.06			
						No	6	<a href="#">PE7316-6</a>	\$469.06			
					1.6:1	No	10	<a href="#">PE7316-10</a>	\$469.06			
						No	20	<a href="#">PE7316-20</a>	\$469.06			
						No	30	<a href="#">PE7316-30</a>	\$469.06			
			18 GHz		1.6:1	No	40	<a href="#">PE7316-40</a>	\$469.06			
						No	3	<a href="#">PE7321-3</a>	\$467.67			
	No					6	<a href="#">PE7321-6</a>	\$467.67				
	1.3:1	No			10	<a href="#">PE7321-10</a>	\$467.67					
		No			20	<a href="#">PE7321-20</a>	\$467.67					
		No			30	<a href="#">PE7321-30</a>	\$467.67					
	7/16 DIN Female	6 GHz	1.3:1		No	40	<a href="#">PE7321-40</a>	\$467.67				
					No	50	<a href="#">PE7314-50</a>	\$469.06				
					No	3	<a href="#">PE7314-3</a>	\$469.06				
		7.5 GHz	1.45:1		No	6	<a href="#">PE7314-6</a>	\$469.06				
					No	10	<a href="#">PE7314-10</a>	\$469.06				
					No	20	<a href="#">PE7314-20</a>	\$469.06				
			1.15:1		No	30	<a href="#">PE7314-30</a>	\$476.09				
					No	40	<a href="#">PE7314-40</a>	\$469.06				
					No	3	<a href="#">PE7388-3</a>	\$272.71				
		N Male	N Female		3 GHz	No	6	<a href="#">PE7388-6</a>	\$272.71			
						No	10	<a href="#">PE7388-10</a>	\$279.74			
						No	15	<a href="#">PE7388-15</a>	\$279.74			
	No					20	<a href="#">PE7388-20</a>	\$280.87				
	No					30	<a href="#">PE7388-30</a>	\$270.22				
	No					40	<a href="#">PE7388-40</a>	\$300.34				
	N Female		4 GHz		1.35:1	Yes	3	<a href="#">PE7389-3</a>	\$238.85			
						Yes	6	<a href="#">PE7389-6</a>	\$238.85			
						Yes	10	<a href="#">PE7389-10</a>	\$238.85			
						Yes	15	<a href="#">PE7389-15</a>	\$238.85			
						Yes	20	<a href="#">PE7389-20</a>	\$236.23			
						Yes	30	<a href="#">PE7389-30</a>	\$239.78			
	6 GHz	1.35:1	Yes		40	<a href="#">PE7389-40</a>	\$251.20					
			Yes		2	<a href="#">PE7394-2</a>	\$314.28					
			Yes		3	<a href="#">PE7394-3</a>	\$366.05					
			Yes		6	<a href="#">PE7394-6</a>	\$297.60					
			Yes		10	<a href="#">PE7394-10</a>	\$297.60					
Yes			30	<a href="#">PE7394-30</a>	\$312.78							
18 GHz	1.3:1	Yes	40	<a href="#">PE7394-40</a>	\$315.12							
		No	50	<a href="#">PE7322-50</a>	\$499.54							
		No	6	<a href="#">PE7019-6</a>	\$644.79							
	1.45:1	No	10	<a href="#">PE7019-10</a>	\$707.90							
		No	20	<a href="#">PE7019-20</a>	\$687.01							
		No	30	<a href="#">PE7019-30</a>	\$664.40							
		No	40	<a href="#">PE7019-40</a>	\$651.93							
		1.6:1	No	3	<a href="#">PE7322-3</a>	\$570.27						
			No	6	<a href="#">PE7322-6</a>	\$570.27						
	No		10	<a href="#">PE7322-10</a>	\$570.27							
	6 GHz	1.3:1	No	20	<a href="#">PE7322-20</a>	\$662.20						
			No	30	<a href="#">PE7322-30</a>	\$573.10						
No			40	<a href="#">PE7322-40</a>	\$499.54							
1.45:1		No	50	<a href="#">PE7311-50</a>	\$485.94							
		No	3	<a href="#">PE7311-3</a>	\$460.80							
		No	6	<a href="#">PE7311-6</a>	\$460.80							
7.5 GHz	1.45:1	No	10	<a href="#">PE7311-10</a>	\$460.80							
		No	20	<a href="#">PE7311-20</a>	\$478.77							
		No	30	<a href="#">PE7311-30</a>	\$478.77							
	1.3:1	No	40	<a href="#">PE7311-40</a>	\$460.80							
		No	50	<a href="#">PE7315-50</a>	\$467.67							
		No	3	<a href="#">PE7315-3</a>	\$467.67							
7/16 DIN Female	7.5 GHz	1.45:1	No	6	<a href="#">PE7315-6</a>	\$467.67						
			No	10	<a href="#">PE7315-10</a>	\$467.67						
			No	20	<a href="#">PE7315-20</a>	\$467.67						
	6 GHz	1.45:1	No	30	<a href="#">PE7315-30</a>	\$467.67						
			No	40	<a href="#">PE7315-40</a>	\$490.60						
			No	40	<a href="#">PE7315-40</a>	\$490.60						

\* Bi-Dir is Bi-Directional. If No then Attenuator is Directional. Maximum power applies to input connector only.

## Fixed Attenuators

50 Ohm



Max. Power (Watts)	Connector Input	Connector Output	Max. Freq.	Construction Material	VSWR Max.	Bi-Dir.*	ATTN. (dB)	Model No	1 Pc. Price	See Web for Volume Pricing	ROW	
50 W	N Female	N Male	6 GHz	Black Anodized Aluminum Heatsink	1.3:1	No	50	<a href="#">PE7317-50</a>	\$588.55	See Web for Volume Pricing	2	
						No	3	<a href="#">PE7317-3</a>	\$561.85			
			18 GHz			No	6	<a href="#">PE7317-6</a>	\$570.27			
						No	10	<a href="#">PE7317-10</a>	\$570.27			
						No	20	<a href="#">PE7317-20</a>	\$591.01			
						No	30	<a href="#">PE7317-30</a>	\$570.27			
		No			40	<a href="#">PE7317-40</a>	\$581.69					
		No			50	<a href="#">PE7323-50</a>	\$474.61					
		N Female	6 GHz		1.3:1	No	3	<a href="#">PE7323-3</a>	\$497.85			
						No	6	<a href="#">PE7323-6</a>	\$497.85			
			1.6:1			No	10	<a href="#">PE7323-10</a>	\$576.26			
						No	20	<a href="#">PE7323-20</a>	\$661.30			
	No					30	<a href="#">PE7323-30</a>	\$578.98				
	No					40	<a href="#">PE7323-40</a>	\$581.69				
	SMA Male	SMA Female	18 GHz		1.45:1	No	6	<a href="#">PE7020-6</a>	\$766.61			
						No	10	<a href="#">PE7020-10</a>	\$766.61			
						No	20	<a href="#">PE7020-20</a>	\$684.18			
						No	30	<a href="#">PE7020-30</a>	\$676.95			
						No	40	<a href="#">PE7020-40</a>	\$674.93			
						1.35:1	Yes	3	<a href="#">PE7427-03</a>			\$580.18
							Yes	6	<a href="#">PE7427-06</a>			\$571.62
							Yes	10	<a href="#">PE7427-10</a>			\$580.18
							Yes	15	<a href="#">PE7427-15</a>			\$550.16
							Yes	20	<a href="#">PE7427-20</a>			\$580.18
Yes				30			<a href="#">PE7427-30</a>	\$580.18				
SMA Female				SMA Female		1.6:1	No	40	<a href="#">PE7427-40</a>	\$558.40		
	No	6	<a href="#">PE7337-6</a>		\$552.33							
	No	10	<a href="#">PE7337-10</a>		\$552.33							
	No	20	<a href="#">PE7337-20</a>		\$552.33							
	No	30	<a href="#">PE7337-30</a>		\$552.33							
	No	40	<a href="#">PE7337-40</a>		\$558.84							
TNC Male	TNC Female	1.45:1	No	50	<a href="#">PE7337-50</a>	\$656.95						
			No	30	<a href="#">PE7055-30</a>	\$833.12						
TNC Female	TNC Female	1.6:1	No	40	<a href="#">PE7055-40</a>	\$807.94						
			No	10	<a href="#">PE7351-10</a>	\$529.45						
			No	20	<a href="#">PE7351-20</a>	\$529.45						
			No	40	<a href="#">PE7351-40</a>	\$635.33						
			No	50	<a href="#">PE7351-50</a>	\$529.45						
			No	3	<a href="#">PE7203-3</a>	\$886.12						
100 W	7/16 DIN Male	7/16 DIN Female	6 GHz	Black Anodized Aluminum Heatsink	1.45:1	No	6	<a href="#">PE7203-6</a>	\$840.27	See Web for Volume Pricing	9	
						No	10	<a href="#">PE7203-10</a>	\$886.12			
						No	20	<a href="#">PE7203-20</a>	\$929.55			
						No	30	<a href="#">PE7203-30</a>	\$840.27			
						No	40	<a href="#">PE7203-40</a>	\$946.94			
						No	50	<a href="#">PE7203-50</a>	\$946.94			
		N Female				N Female	No	60	<a href="#">PE7203-60</a>			\$1,026.87
							No	3	<a href="#">PE7211-3</a>			\$768.73
							No	6	<a href="#">PE7211-6</a>			\$768.73
							No	10	<a href="#">PE7211-10</a>			\$768.73
							No	20	<a href="#">PE7211-20</a>			\$768.73
							No	30	<a href="#">PE7211-30</a>			\$806.41
	7/16 DIN Female	7/16 DIN Male			7/16 DIN Female	No	40	<a href="#">PE7211-40</a>	\$1,017.34			
						No	50	<a href="#">PE7211-50</a>	\$1,017.34			
						No	60	<a href="#">PE7211-60</a>	\$826.35			
						No	3	<a href="#">PE7201-3</a>	\$852.86			
						No	6	<a href="#">PE7201-6</a>	\$852.86			
						No	10	<a href="#">PE7201-10</a>	\$886.12			
		7/16 DIN Female				7/16 DIN Female	No	20	<a href="#">PE7201-20</a>			\$881.46
							No	30	<a href="#">PE7201-30</a>			\$840.27
							No	40	<a href="#">PE7201-40</a>			\$897.95
							No	50	<a href="#">PE7201-50</a>			\$897.95
							No	60	<a href="#">PE7201-60</a>			\$911.40
							No	3	<a href="#">PE7204-3</a>			\$848.15
7/16 DIN Female	7/16 DIN Male	7/16 DIN Female	No	6	<a href="#">PE7204-6</a>	\$848.15						
			No	10	<a href="#">PE7204-10</a>	\$848.15						
			No	20	<a href="#">PE7204-20</a>	\$848.15						
			No	30	<a href="#">PE7204-30</a>	\$848.15						
			No	40	<a href="#">PE7204-40</a>	\$905.81						
			No	50	<a href="#">PE7204-50</a>	\$905.81						
	7/16 DIN Female		7/16 DIN Female	No	60	<a href="#">PE7204-60</a>	\$905.81					

\* Bi-Dir is Bi-Directional. If No then Attenuator is Directional. Maximum power applies to input connector only.



Technical Support  
+1 (949) 261-1920



Same-Day Shipping,  
Even Custom  
Cable Assemblies

Attenuators & Equalizers

See Our Website For Current Pricing & Real-Time Stock Availability!



## Fixed Attenuators

50 Ohm



Attenuators & Equalizers

See Our Website For Current Pricing & Real-Time Stock Availability!

Max. Power (Watts)	Connector Input	Connector Output	Max. Freq.	Construction Material	VSWR Max.	Bi-Dir.*	ATTN. (dB)	Model No	1 Pc. Price	See Web for Volume Pricing	ROW		
100 W	7/16 DIN Female	N Male	6 GHz	Black Anodized Aluminum Heatsink	1.45:1	No	3	<a href="#">PE7207-3</a>	\$778.15	See Web for Volume Pricing	13		
						No	6	<a href="#">PE7207-6</a>	\$778.15				
						No	10	<a href="#">PE7207-10</a>	\$778.15				
						No	20	<a href="#">PE7207-20</a>	\$778.15				
						No	30	<a href="#">PE7207-30</a>	\$778.15				
						No	40	<a href="#">PE7207-40</a>	\$835.83				
						No	50	<a href="#">PE7207-50</a>	\$835.83				
		No				60	<a href="#">PE7207-60</a>	\$835.83					
		No				3	<a href="#">PE7212-3</a>	\$776.59	14				
		No				6	<a href="#">PE7212-6</a>	\$776.59					
		No				10	<a href="#">PE7212-10</a>	\$776.59					
		No				20	<a href="#">PE7212-20</a>	\$776.59					
		No				30	<a href="#">PE7212-30</a>	\$776.59					
		No				40	<a href="#">PE7212-40</a>	\$834.22					
	No	50	<a href="#">PE7212-50</a>		\$834.22								
	No	60	<a href="#">PE7212-60</a>		\$834.22								
	BNC Male	BNC Female	1,000 MHz		1.4:1	No	3	<a href="#">PE7026-3</a>	\$920.31		15		
						No	6	<a href="#">PE7026-6</a>	\$930.04				
						No	10	<a href="#">PE7026-10</a>	\$821.70				
						No	20	<a href="#">PE7026-20</a>	\$930.04				
						No	30	<a href="#">PE7026-30</a>	\$855.97				
						No	40	<a href="#">PE7026-40</a>	\$930.04				
	N Male	7/16 DIN Female	6 GHz		1.45:1	No	3	<a href="#">PE7205-3</a>	\$778.15		16		
No				6		<a href="#">PE7205-6</a>	\$778.15						
No				10		<a href="#">PE7205-10</a>	\$778.15						
No				20		<a href="#">PE7205-20</a>	\$778.15						
No				30		<a href="#">PE7205-30</a>	\$778.15						
No				40		<a href="#">PE7205-40</a>	\$835.83						
No				50		<a href="#">PE7205-50</a>	\$835.83						
No				60		<a href="#">PE7205-60</a>	\$835.83						
No				6		<a href="#">PE7021-6</a>	\$917.64	17					
No				10		<a href="#">PE7021-10</a>	\$795.13						
No		20	<a href="#">PE7021-20</a>	\$779.84									
No		30	<a href="#">PE7021-30</a>	\$843.41									
No		40	<a href="#">PE7021-40</a>	\$825.78									
Yes		3	<a href="#">PE7385-3</a>	\$478.85									
Yes		6	<a href="#">PE7385-6</a>	\$478.85	18								
Yes		10	<a href="#">PE7385-10</a>	\$478.85									
Yes		20	<a href="#">PE7385-20</a>	\$478.85									
Yes		30	<a href="#">PE7385-30</a>	\$478.85									
Yes		40	<a href="#">PE7385-40</a>	\$490.27									
Yes		3	<a href="#">PE7421-3</a>	\$558.84									
Yes		6	<a href="#">PE7421-6</a>	\$558.84	19								
Yes		10	<a href="#">PE7421-10</a>	\$570.27									
Yes		20	<a href="#">PE7421-20</a>	\$562.75									
Yes	30	<a href="#">PE7421-30</a>	\$604.56										
No	40	<a href="#">PE7421-40</a>	\$699.17										
No	3	<a href="#">PE7213-3</a>	\$745.16	20									
No	6	<a href="#">PE7213-6</a>	\$810.93										
No	10	<a href="#">PE7213-10</a>	\$837.14										
No	20	<a href="#">PE7213-20</a>	\$842.06										
No	30	<a href="#">PE7213-30</a>	\$828.22										
No	40	<a href="#">PE7213-40</a>	\$853.53										
No	50	<a href="#">PE7213-50</a>	\$869.92										
No	60	<a href="#">PE7213-60</a>	\$845.39										
No	3	<a href="#">PE7424-03</a>	\$1,098.82		21								
No	6	<a href="#">PE7424-06</a>	\$955.83										
No	10	<a href="#">PE7424-10</a>	\$934.85										
No	20	<a href="#">PE7424-20</a>	\$967.70										
No	30	<a href="#">PE7424-30</a>	\$1,005.44										
No	40	<a href="#">PE7424-40</a>	\$1,017.07										
N Female	7/16 DIN Male	6 GHz	1.45:1	No	30	<a href="#">PE7237-30</a>	\$749.42	22					
				No	3	<a href="#">PE7202-3</a>	\$768.73						
				No	6	<a href="#">PE7202-6</a>	\$768.73						
				No	10	<a href="#">PE7202-10</a>	\$768.73						
				No	20	<a href="#">PE7202-20</a>	\$768.73						
				No	30	<a href="#">PE7202-30</a>	\$810.67						
				No	40	<a href="#">PE7202-40</a>	\$826.35						
				No	50	<a href="#">PE7202-50</a>	\$826.35						
				N Female	TNC Female	6 GHz	1.45:1		No	30	<a href="#">PE7237-30</a>	\$749.42	23
									No	30	<a href="#">PE7237-30</a>	\$749.42	

\* Bi-Dir is Bi-Directional. If No then Attenuator is Directional. Maximum power applies to input connector only.

## Fixed Attenuators

50 Ohm



Max. Power (Watts)	Connector Input	Connector Output	Max. Freq.	Construction Material	VSWR Max.	Bi-Dir.*	ATTN. (dB)	Model No	1 Pc. Price	See Web for Volume Pricing	ROW			
100 W	N Female	7/16 DIN Male	6 GHz	Black Anodized Aluminum Heatsink	1.45:1	No	60	<a href="#">PE7202-60</a>	\$826.35	See Web for Volume Pricing	23			
		7/16 DIN Female				No	3	<a href="#">PE7206-3</a>	\$917.24		24			
						No	6	<a href="#">PE7206-6</a>	\$776.59					
						No	10	<a href="#">PE7206-10</a>	\$776.59					
						No	20	<a href="#">PE7206-20</a>	\$917.25					
						No	30	<a href="#">PE7206-30</a>	\$776.59					
						No	40	<a href="#">PE7206-40</a>	\$834.22					
		N Male				No	50	<a href="#">PE7206-50</a>	\$834.22					
						No	60	<a href="#">PE7206-60</a>	\$834.22					
						No	3	<a href="#">PE7208-3</a>	\$781.68					
						No	6	<a href="#">PE7208-6</a>	\$834.59					
						No	10	<a href="#">PE7208-10</a>	\$781.68					
						No	20	<a href="#">PE7208-20</a>	\$837.14					
						No	30	<a href="#">PE7208-30</a>	\$803.76					
						No	40	<a href="#">PE7208-40</a>	\$853.53					
						No	50	<a href="#">PE7208-50</a>	\$845.39					
						No	60	<a href="#">PE7208-60</a>	\$845.39					
						N Female	No	3	<a href="#">PE7214-3</a>		\$827.96			
							No	6	<a href="#">PE7214-6</a>		\$811.26			
		No					10	<a href="#">PE7214-10</a>	\$819.83					
		No					20	<a href="#">PE7214-20</a>	\$827.96					
		No					30	<a href="#">PE7214-30</a>	\$827.96					
		No					40	<a href="#">PE7214-40</a>	\$843.68					
		SMA Male				SMA Female	6 GHz	1.25:1	No		6	<a href="#">PE7022-6</a>	\$920.31	
	No		20	<a href="#">PE7022-20</a>	\$623.40									
	No		30	<a href="#">PE7022-30</a>	\$921.27									
	No		40	<a href="#">PE7022-40</a>	\$851.61									
	SMA Male		SMA Female	1.45:1	No				3		<a href="#">PE7227-3</a>	\$683.43		
					No				6		<a href="#">PE7227-6</a>	\$673.34		
					No	10			<a href="#">PE7227-10</a>		\$673.34			
					No	20			<a href="#">PE7227-20</a>		\$673.34			
					No	30			<a href="#">PE7227-30</a>		\$673.34			
					No	40			<a href="#">PE7227-40</a>		\$730.94			
	SMA Female		SMA Male		18 GHz	1.35:1			No		50	<a href="#">PE7227-50</a>	\$770.82	
									No		60	<a href="#">PE7227-60</a>	\$836.83	
		No					10	<a href="#">PE7425-10</a>	\$1,061.67					
No		20					<a href="#">PE7425-20</a>	\$979.27						
No		30					<a href="#">PE7425-30</a>	\$1,074.01						
No		40					<a href="#">PE7425-40</a>	\$1,085.44						
SMA Female	SMA Male	6 GHz	1.45:1	No		3	<a href="#">PE7221-3</a>	\$706.33						
				No		6	<a href="#">PE7221-6</a>	\$733.88						
				No		10	<a href="#">PE7221-10</a>	\$744.87						
				No		20	<a href="#">PE7221-20</a>	\$744.87						
				No		40	<a href="#">PE7221-40</a>	\$808.58						
				No		50	<a href="#">PE7221-50</a>	\$766.76						
	SMA Female			SMA Female	1.15:1	1.15:1	No	60	<a href="#">PE7221-60</a>	\$836.83				
							No	3	<a href="#">PE7228-3</a>	\$741.29				
							No	20	<a href="#">PE7228-20</a>	\$791.43				
							No	30	<a href="#">PE7228-30</a>	\$830.24				
							No	50	<a href="#">PE7228-50</a>	\$836.83				
							TNC Male	TNC Female	1.5 GHz	No	30	<a href="#">PE7056-30</a>	\$896.32	
TNC Female	N Male	6 GHz	1.45:1	No		30	<a href="#">PE7210-30</a>	\$721.29						
	N Female			No		3	<a href="#">PE7218-3</a>	\$730.48						
150 W	N Male	N Female	8 GHz	Black Anodized Aluminum Heatsink		1.5:1	No	3	<a href="#">PE7AP150-03</a>	\$725.73				
							No	6	<a href="#">PE7AP150-06</a>	\$714.15				
							No	10	<a href="#">PE7AP150-10</a>	\$753.11				
							No	20	<a href="#">PE7AP150-20</a>	\$753.11				
					No		30	<a href="#">PE7AP150-30</a>	\$798.81					
					No		40	<a href="#">PE7AP150-40</a>	\$753.27					
200 W	N Male	N Female	3 GHz	Black Anodized Aluminum Heatsink	1.35:1	No	10	<a href="#">PE7387-10</a>	\$682.20					
						No	20	<a href="#">PE7387-20</a>	\$684.54					
						No	30	<a href="#">PE7387-30</a>	\$685.46					
						No	40	<a href="#">PE7387-40</a>	\$708.16					

\* Bi-Dir is Bi-Directional. If No then Attenuator is Directional. Maximum power applies to input connector only.



Technical Support  
+1 (949) 261-1920



Same-Day Shipping,  
Even Custom  
Cable Assemblies

Attenuators & Equalizers

See Our Website For Current Pricing & Real-Time Stock Availability!

## Fixed Attenuators

### 50 Ohm



Max. Power (Watts)	Connector Input	Connector Output	Max. Freq.	Construction Material	VSWR Max.	Bi-Dir.*	ATTN. (dB)	Model No	1	2-4	5-9	10+	ROW
200 W	N Male	N Female	18 GHz	Black Anodized Aluminum Heatsink	1.5:1	No	20	<a href="#">PE7AP200-20</a>	\$2,943.63	\$2,825.88	\$2,708.14	\$2,590.39	37
								No 10	<a href="#">PE7AP250-10</a>	\$912.68	\$876.17	\$839.67	\$803.16
250 W	N Male	N Female	8.5 GHz	Black Anodized Aluminum Heatsink	1.45:1	No	20	<a href="#">PE7AP250-20</a>	\$948.26	\$910.33	\$872.40	\$834.47	
							30	<a href="#">PE7AP250-30</a>	\$948.26	\$910.33	\$872.40	\$834.47	
							40	<a href="#">PE7AP250-40</a>	\$1,027.50	\$986.40	\$945.30	\$904.20	
300 W	N Male	N Female	1,000 MHz	Black Anodized Aluminum Heatsink	1.4:1	No	3	<a href="#">PE7031-3</a>	\$2,151.81	\$2,065.74	\$1,979.67	\$1,893.59	39
							10	<a href="#">PE7031-10</a>	\$1,934.76	\$1,857.37	\$1,779.98	\$1,702.59	
500 W	N Male	N Female	1,000 MHz	Black Anodized Aluminum Heatsink	1.15:1	No	6	<a href="#">PE7032-6</a>	\$2,319.45	\$2,238.27	\$2,157.09	\$2,087.51	40
							30	<a href="#">PE7032-30</a>	\$2,319.45	\$2,238.27	\$2,157.09	\$2,087.51	
			2.4 GHz		1.35:1	No	2	<a href="#">PE7085-2</a>	\$2,513.02	\$2,425.06	\$2,337.11	\$2,261.72	41
							20	<a href="#">PE7085-20</a>	\$2,056.14	\$1,973.89	\$1,891.65	\$1,809.40	
			3 GHz		1.35:1	No	3	<a href="#">PE7AP418-03</a>	\$2,017.27	\$2,017.27	\$1,944.11	\$1,881.40	42
							10	<a href="#">PE7AP418-10</a>	\$2,090.44	\$2,006.82	\$1,923.20	\$1,839.59	
							20	<a href="#">PE7AP418-20</a>	\$2,090.44	\$2,006.82	\$1,923.20	\$1,839.59	
							30	<a href="#">PE7AP418-30</a>	\$2,090.44	\$2,006.82	\$1,923.20	\$1,839.59	
1000 W	N Male	N Female	2.5 GHz	Black Aluminum Heatsink	1.35:1	No	30-30	<a href="#">PE7423-30</a>	\$4,020.22	\$3,879.51	\$3,738.80	\$3,618.20	43
							40	<a href="#">PE7423-40</a>	\$4,020.22	\$3,879.51	\$3,738.80	\$3,618.20	

### 75 Ohm



Max. Power (Watts)	Connector Input	Connector Output	Max. Freq.	Construction Material	VSWR Max.	Bi-Dir.*	ATTN. (dB)	Model No	1 Pc. Price	See Web for Volume Pricing	ROW	
1 W	BNC Male	BNC Female	1,000 MHz	Nickel Plated Brass	1.2:1	Yes	1	<a href="#">PE7009-1</a>	\$70.08	See Web for Volume Pricing	44	
							2	<a href="#">PE7009-2</a>	\$70.08			
							3	<a href="#">PE7009-3</a>	\$62.40			
							6	<a href="#">PE7009-6</a>	\$64.62			
							10	<a href="#">PE7009-10</a>	\$63.58			
	N Male	N Female	1,000 MHz	Nickel Plated Brass	1.2:1	Yes	20	<a href="#">PE7009-20</a>	\$63.58			
							30	<a href="#">PE7009-30</a>	\$63.58			
							3	<a href="#">PE7029-3</a>	\$84.77			45
							6	<a href="#">PE7029-6</a>	\$84.77			
							10	<a href="#">PE7029-10</a>	\$94.95			
20	<a href="#">PE7029-20</a>	\$75.70										
30	<a href="#">PE7029-30</a>	\$85.26										
2 W	BNC Male	BNC Female	4 GHz	Nickel Plated Brass	1.35:1	Yes	2	<a href="#">PE7050-2</a>	\$147.44	See Web for Volume Pricing	46	
							3	<a href="#">PE7050-3</a>	\$136.01			
							6	<a href="#">PE7050-6</a>	\$136.01			
							10	<a href="#">PE7050-10</a>	\$163.20			
							20	<a href="#">PE7050-20</a>	\$163.20			
	F Male	F Female	1,000 MHz	Tri-Metal Plated Brass	1.3:1	Yes	30	<a href="#">PE7050-30</a>	\$136.01			
							1	<a href="#">PE7057-1</a>	\$92.87			47
							2	<a href="#">PE7057-2</a>	\$92.87			
							3	<a href="#">PE7057-3</a>	\$122.46			
							6	<a href="#">PE7057-6</a>	\$122.46			
N Male	N Female	4 GHz	Passivated Stainless Steel	1.3:1	Yes	10	<a href="#">PE7057-10</a>	\$124.58				
						1	<a href="#">PE7396-1</a>	\$78.44	48			
						2	<a href="#">PE7396-2</a>	\$79.93				
						3	<a href="#">PE7396-3</a>	\$75.07				
						4	<a href="#">PE7396-4</a>	\$95.92				
						5	<a href="#">PE7396-5</a>	\$91.35				
						6	<a href="#">PE7396-6</a>	\$74.15				
						7	<a href="#">PE7396-7</a>	\$95.92				
						8	<a href="#">PE7396-8</a>	\$95.92				
						9	<a href="#">PE7396-9</a>	\$88.97				
10	<a href="#">PE7396-10</a>	\$89.90										
16	<a href="#">PE7396-16</a>	\$95.92										
20	<a href="#">PE7396-20</a>	\$74.15										
N Male	N Female	4 GHz	Passivated Stainless Steel	1.3:1	Yes	1	<a href="#">PE7044-1</a>	\$170.29	49			
						2	<a href="#">PE7044-2</a>	\$170.29				
						3	<a href="#">PE7044-3</a>	\$167.76				

\* Bi-Dir is Bi-Directional. If No then Attenuator is Directional. Maximum power applies to input connector only.

Attenuators & Equalizers

See Our Website For Current Pricing & Real-Time Stock Availability!

## Fixed Attenuators

**75 Ohm**



Max. Power (Watts)	Connector Input	Connector Output	Max. Freq.	Construction Material	VSWR Max.	Bi-Dir.*	ATTN. (dB)	Model No	1-9	10--24	25-49	50+	ROW
<b>2 W</b>	N Male	N Female	4 GHz	Passivated Stainless Steel	1.3:1	Yes	6	<a href="#">PE7044-6</a>	\$190.64	\$183.01	\$177.30	\$173.48	49
						Yes	10	<a href="#">PE7044-10</a>	\$167.76	\$159.37	\$150.98	\$144.27	
						Yes	20	<a href="#">PE7044-20</a>	\$167.76	\$159.37	\$150.98	\$144.27	
						Yes	30	<a href="#">PE7044-30</a>	\$167.76	\$159.37	\$150.98	\$144.27	

## Step Attenuators, Push Button

**50 Ohm**



Max. Power (Watts)	Conn. Input	Conn. Output	Frequency Range (MHz)	Construction Material	VSWR Max. (MHz)	ATTN. Range (dB)	Step Size (dB)	Model No	1 Pc. Price	See Web for Volume Pricing			ROW
<b>1 W</b>	BNC Female	BNC Female	DC-750	Brass	DC-100: 1.1:1 100-300: 1.25:1 300-500: 1.25:1 500-750: 1.4:1	0-65	1.0	<a href="#">PE7008-1</a>	\$954.15	See Web for Volume Pricing			50
					1.4:1	0-82.5		<a href="#">PE70A1021</a>	\$1,521.12				51
					DC-100: 1.1:1 100-300: 1.25:1 300-500: 1.25:1 500-750: 1.4:1	0-45.5	0.5	<a href="#">PE7008-2</a>	\$1,001.74				52
					1.4:1	0-82.5	0.5	<a href="#">PE7008-6</a>	\$1,212.36				
						0-102	1.0	<a href="#">PE7008-5</a>	\$1,315.77				

**75 Ohm**



Max. Power (Watts)	Conn. Input	Conn. Output	Frequency Range (MHz)	Construction Material	VSWR Max. (MHz)	ATTN. Range (dB)	Step Size (dB)	Model No	1-4	5-9	10-24	25+	ROW
<b>1 W</b>	BNC Female	BNC Female	DC-500	Brass	DC-100: 1.1:1 100-300: 1.2:1 300-500: 1.3:1	0-65	1.0	<a href="#">PE7008-3</a>	\$966.55	\$918.22	\$869.90	\$831.23	52

## Step Attenuators, Toggle

**75 Ohm**



Max. Power (Watts)	Conn. Input	Conn. Output	Frequency Range (MHz)	Construction Material	VSWR Max. (MHz)	ATTN. Range (dB)	Step Size (dB)	Model No	1-4	5-9	10-24	25+	ROW
<b>1 W</b>	BNC Female	BNC Female	DC-1,000	Aluminum	1.3:1	0-42		<a href="#">PE70A1001</a>	\$758.06	\$720.16	\$682.25	\$651.93	53
	F Female	F Female	0.3-1,000		1.37:1	0-71		<a href="#">PE70A1008</a>	\$827.56	\$786.18	\$744.80	\$711.70	54

\* Bi-Dir is Bi-Directional. If No then Attenuator is Directional. Maximum power applies to input connector only.



Technical Support  
+1 (949) 261-1920



Same-Day Shipping,  
Even Custom  
Cable Assemblies

Attenuators & Equalizers

See Our Website For Current Pricing & Real-Time Stock Availability!



### Step Attenuators, Rotary

#### 50 Ohm



Max. Power (Watts)	Conn. Input	Conn. Output	Frequency Range (MHz)	Construction Material	VSWR Max. (MHz)	ATTN. Range (dB)	Step Size (dB)	Model No	1 Pc. Price	See Web for Volume Pricing			ROW
1 W	BNC Female	BNC Female	DC-1,000	Aluminum	1.2:1	0-1	0.1	<a href="#">PE7034-1</a>	\$650.25				55
					DC-1,000: 1.2:1	0-100	10.0	<a href="#">PE7034-2</a>	\$772.72				
2 W	BNC Female	BNC Female	DC-2,000	Aluminum	1.3:1	0-1	0.1	<a href="#">PE7034-6</a>	\$679.82	See Web for Volume Pricing			56
					DC-2,200	0-10	1.0	<a href="#">PE70A1024</a>	\$672.12				57
			0-70			10.0	<a href="#">PE70A1022</a>	\$862.16	58				
			0-10			1.0	<a href="#">PE70A1025</a>	\$639.00	59				
			0-70		10.0	<a href="#">PE70A1023</a>	\$690.74						

#### 75 Ohm



Max. Power (Watts)	Conn. Input	Conn. Output	Frequency Range (MHz)	Construction Material	VSWR Max. (MHz)	ATTN. Range (dB)	Step Size (dB)	Model No	1 Pc. Price	See Web for Volume Pricing			ROW
1 W	BNC Female	BNC Female	DC-500	Aluminum	1.3:1	0-10	1.0	<a href="#">PE7035-2</a>	\$448.19		See Web for Volume Pricing		60
			DC-1,000		DC-500: 1.3:1 500-1,000: 1.4:1	0-1	0.1	<a href="#">PE7035-5</a>	\$1,015.96				

### DC Bias Attenuators

#### 50 Ohm



Max. Power (Watts)	Conn. Input	Conn. Output	Frequency Range (MHz)	Construction Material	VSWR Max.	Max. V (V)	Max. I (Amp)	ATTN. (dB)	Model No	1-9	10-24	25-49	50+	ROW
2 W	N Male	N Female	500-2,000	Passivated Stainless Steel	1.35:1	100	2	6	<a href="#">PE7062-6</a>	\$180.86	\$171.82	\$162.77	\$155.54	61
								10	<a href="#">PE7062-10</a>	\$177.57	\$168.69	\$159.81	\$152.71	
								20	<a href="#">PE7062-20</a>	\$152.31	\$144.69	\$137.08	\$130.99	
	SMA Male	SMA Female						6	<a href="#">PE7061-6</a>	\$150.43	\$142.91	\$135.39	\$129.37	62
								10	<a href="#">PE7061-10</a>	\$150.43	\$142.91	\$135.39	\$129.37	
								20	<a href="#">PE7061-20</a>	\$163.20	\$155.04	\$146.88	\$140.35	
	TNC Male	TNC Female						6	<a href="#">PE7063-6</a>	\$165.22	\$156.96	\$148.70	\$142.09	63
								10	<a href="#">PE7063-10</a>	\$190.64	\$181.11	\$171.58	\$163.95	
								20	<a href="#">PE7063-20</a>	\$190.64	\$181.11	\$171.58	\$163.95	

#### 75 Ohm



Max. Power (Watts)	Conn. Input	Conn. Output	Frequency Range (MHz)	Construction Material	VSWR Max.	Max. V (V)	Max. I (Amp)	ATTN. (dB)	Model No	1-9	10-24	25-49	50+	ROW
2 W	F Male	F Female	500-2,000	Brass	1.45:1	100	2	6	<a href="#">PE7064-6</a>	\$193.14	\$183.48	\$173.83	\$166.10	64
								10	<a href="#">PE7064-10</a>	\$193.14	\$183.48	\$173.83	\$166.10	
								20	<a href="#">PE7064-20</a>	\$190.29	\$180.78	\$171.26	\$163.65	

## Continuously Variable Attenuators

50 Ohm



Max. Power (Watts)	Conn. Input	Conn. Output	Frequency Range (MHz)	Construction Material	VSWR Max.	ATTN. (dB)	Model No	1	2-4	5-9	10+	ROW
5 W	SMA Female	SMA Female	DC-4,000		DC-1,000: 1.5:1 1,000-2,000: 1.6:1 2,000-3,000: 1.7:1 3,000-4,000: 1.8:1	5-95	<a href="#">PE7422</a>	\$1,731.32	\$1,662.07	\$1,592.81	\$1,523.56	65

## ACTIVE ATTENUATORS

TTL, USB, CMOS and Relay



Type	Frequency Range (GHz)	Atten. Range (dB)	IL (dB)	Step Resolution (dB)	Switching Speed (µs)	Input/Output Connector	Model No	1 Pc. Price	See Web for Volume Pricing			ROW			
CMOS	DC - 13	0 - 31.5	5	0.5	6,000,000	SMA Female	<a href="#">PE70A5003</a>	\$4,956.42				66			
	DC - 1		1.5				<a href="#">PE70A8001</a>	\$925.30				67			
	DC - 1	0 - 63	1.5	<a href="#">PE70A8000</a>			\$975.78	68							
	DC - 1		2.2	<a href="#">PE70A8003</a>			\$1,796.30	69							
	DC - 1		2.5	<a href="#">PE70A8004</a>			\$2,138.65	70							
Relay	DC - 1.5	0 - 127	3.2	1	45	SMA Female	<a href="#">PE70A8005</a>	\$2,326.58	See Web for Volume Pricing			71			
	DC - 2		3.0				<a href="#">PE70A8002</a>	\$3,180.46				72			
	DC - 13	0 - 31.5	5.5	0.25			<a href="#">PE70A4000</a>	\$5,334.73				73			
	TTL	5 MHz - 2.15	0 - 63	5.25			1	1,000				F Female	<a href="#">PE70A5012</a>	\$2,117.04	74
		30 MHz - 3		2.5			0.25						<a href="#">PE70A5004</a>	\$1,686.30	75
		30 MHz - 3		0 - 63	4	1	<a href="#">PE70A5006</a>						\$1,665.85	76	
		30 MHz - 3		0 - 63.5	4	0.5	<a href="#">PE70A5005</a>						\$1,618.14	77	
		30 MHz - 3		0 - 95	6	1	<a href="#">PE70A5007</a>						\$2,163.25	78	
	TTL	30 MHz - 6	0 - 60	4	0.25	50,000	SMA Female	<a href="#">PE70A5000</a>				\$6,488.89	79		
		100 MHz - 18		5	1			2.92mm Female				<a href="#">PE70A5001</a>	\$7,584.26	80	
		100 MHz - 40	8	<a href="#">PE70A5002</a>		\$11,042.46	81								
		200 MHz - 6	0 - 63	5.5	1	1,000	SMA Female	<a href="#">PE70A5009</a>				\$1,687.65	82		
		200 MHz - 6		8				<a href="#">PE70A5010</a>				\$2,051.34	83		
		TTL	450 MHz - 2.15	0 - 127	4.5	1	2,000	F Female				<a href="#">PE70A5011</a>	\$2,142.01	84	
			500 MHz - 18		4.5							0.06	<a href="#">PE70A6000</a>	\$7,427.18	85
700 MHz - 3			0 - 127	6	1	5,000	SMA Female	<a href="#">PE70A5008</a>	\$2,079.00	86					
18 - 40				6	0.03			<a href="#">PE70A6001</a>	\$8,147.25	87					
USB			100 MHz - 18	0 - 30	5	1		SMA Female	<a href="#">PE70A3900</a>	\$4,506.94	88				
	100 MHz - 40	5	2.92mm Female		<a href="#">PE70A3901</a>				\$6,128.09	89					
	200 MHz - 6	8.3			SMA Female				<a href="#">PE70A3902</a>	\$2,163.25	90				
Bench-Top TTL	200 MHz - 6	0 - 95	8	1,000		<a href="#">PE70A5013</a>	\$10,080.79	91							

## Variable Voltage Attenuators



Frequency Range (GHz)	Atten. Range (dB)	Insertion Loss (dB)	Switching Speed (µsec)	Input / Output Connectors	Model No	1	2-4	5-9	10+	ROW
DC - 20	0 - 30	2.5	500	SMA Female	<a href="#">PE70A1017</a>	\$8,851.71	\$8,497.64	\$8,143.57	\$7,789.50	92
50 MHz - 2.2	0 - 20	3			<a href="#">PE70A1031</a>	\$1,439.67	\$1,382.08	\$1,324.50	\$1,266.91	93
400 MHz - 6	0 - 40	4			<a href="#">PE70A1000</a>	\$6,759.53	\$6,489.15	\$6,218.77	\$5,948.39	94
500 MHz - 18	0 - 60	4.5			<a href="#">PE70A2900</a>	\$6,738.50	\$6,468.96	\$6,199.42	\$5,929.88	95
		2			<a href="#">PE70A2000</a>	\$5,760.40	\$5,529.98	\$5,299.57	\$5,069.15	96
4 - 8		2.5	<a href="#">PE70A2001</a>	\$6,750.45	\$6,480.43	\$6,210.41	\$5,940.40	97		

Attenuators & Equalizers

See Our Website For Current Pricing & Real-Time Stock Availability!

## Variable Voltage Attenuators



Frequency Range (GHz)	Atten. Range (dB)	Insertion Loss (dB)	Switching Speed (µsec)	Input / Output Connectors	Model No	1	2-4	5-9	10+	ROW
6 - 12	0 - 60	2.8	500	SMA Female	<a href="#">PE70A2002</a>	\$7,083.10	\$6,799.78	\$6,516.45	\$6,233.13	98
8 - 18		3.7			<a href="#">PE70A2003</a>	\$7,412.97	\$7,116.45	\$6,819.93	\$6,523.41	99

## EQUALIZERS

### Positive Slope



Frequency Range (GHz)	Typ. Equalizing Value (dB)	Typ. Small Signal IL (dB)	Typ Input-Output VSWR	Max. RF Input Power (dBm)	In-Out Connectors (Field Replaceable)	Model No	1-4	5-9	10-24	25+	ROW
0.5 MHz - 2	2	1.4	1.8:1	+30	SMA Female	<a href="#">PE70A9000</a>	\$712.56	\$676.93	\$641.30	\$612.80	1
	4	1				<a href="#">PE70A9001</a>	\$730.92	\$694.37	\$657.83	\$628.59	2
	6	1.8				<a href="#">PE70A9002</a>	\$741.94	\$704.84	\$667.75	\$638.07	3
1 - 18	4	1				<a href="#">PE70A9003</a>	\$1,270.84	\$1,207.30	\$1,143.76	\$1,092.92	4
	6	1				<a href="#">PE70A9004</a>	\$1,270.84	\$1,207.30	\$1,143.76	\$1,092.92	5
	8	1.5				<a href="#">PE70A9005</a>	\$1,270.84	\$1,207.30	\$1,143.76	\$1,092.92	6
2 - 6	2	1				<a href="#">PE70A9006</a>	\$1,017.41	\$966.54	\$915.67	\$874.97	7
	4	1.5				<a href="#">PE70A9007</a>	\$1,057.80	\$1,004.91	\$952.02	\$909.71	8
2 - 12	4	1.5				<a href="#">PE70A9008</a>	\$1,017.41	\$966.54	\$915.67	\$874.97	9
	8	1.5				<a href="#">PE70A9009</a>	\$1,101.88	\$1,046.79	\$991.69	\$947.62	10
	2	1.5				<a href="#">PE70A9010</a>	\$1,219.42	\$1,158.45	\$1,097.48	\$1,048.70	11
6 - 18	4	1.5				<a href="#">PE70A9011</a>	\$1,241.46	\$1,179.39	\$1,117.31	\$1,067.66	12
	6	2				<a href="#">PE70A9012</a>	\$1,270.84	\$1,207.30	\$1,143.76	\$1,092.92	13
	8	1.5				<a href="#">PE70A9013</a>	\$1,300.22	\$1,235.21	\$1,170.20	\$1,118.19	14
	2	2				<a href="#">PE70A9014</a>	\$1,425.10	\$1,353.85	\$1,282.59	\$1,225.59	15
18 - 40	4	2				<a href="#">PE70A9015</a>	\$1,458.16	\$1,385.25	\$1,312.34	\$1,254.02	16
	6	2				<a href="#">PE70A9016</a>	\$1,483.87	\$1,409.68	\$1,335.48	\$1,276.13	17
26.5 - 40	4	3				<a href="#">PE70A9017</a>	\$1,425.10	\$1,353.85	\$1,282.59	\$1,225.59	18
	5	2.5	<a href="#">PE70A9018</a>	\$1,447.14	\$1,374.78	\$1,302.43	\$1,244.54	19			

## BALUNS



Frequency Range (MHz)	Balanced Impedance (Ω)	Unbalanced Impedance (Ω)	Package	Model No	1-9	10-24	25-49	50+	ROW
20 - 520	25	50	Surface Mount	<a href="#">PE2BL1001</a>	\$260.75	\$247.71	\$234.68	\$224.25	20
20 - 1,000				<a href="#">PE2BL1002</a>	\$252.30	\$239.69	\$227.07	\$216.98	21
80 - 1,000				<a href="#">PE2BL1003</a>	\$231.27	\$219.71	\$208.14	\$198.89	22
100 - 520				<a href="#">PE2BL1004</a>	\$252.30	\$239.69	\$227.07	\$216.98	23
225 - 2,000				<a href="#">PE2BL1000</a>	\$245.48	\$233.21	\$220.93	\$211.11	24
500 - 2,000				<a href="#">PE2BL1005</a>	\$232.78	\$221.14	\$209.50	\$200.19	25
800 - 2,500				<a href="#">PE2BL1006</a>	\$287.41	\$273.04	\$258.67	\$247.17	26

\* Bi-Dir is Bi-Directional. If No then Attenuator is Directional. Maximum power applies to input connector only.

Attenuators & Equalizers

Baluns

See Our Website For Current Pricing & Real-Time Stock Availability!

# BIAS TEES AND DC BLOCKS

## Bias Tees



Impedance	Frequency Range (MHz.)	Max. V (V)	Max. I (mA)	Connector	Bias Connector	Model No	1 Pc. Price	See Web for Volume Pricing	ROW
50 Ohm	0.03 - 70,000	25	500	1.85mm	SMA	<a href="#">PE1619</a>	\$3,070.64	See Web for Volume Pricing	27
	0.03 - 85,000					<a href="#">PE1620</a>	\$3,302.70		28
	0.05 - 50,000	25	250	2.4mm	SMA	<a href="#">PE1610</a>	\$1,988.56		29
	10 - 40,000	16	250	2.92mm	Pin	<a href="#">PE1621</a>	\$1,256.86		39
	500 - 40,000	50	1000			<a href="#">PE1622</a>	\$1,485.42		45
	0.1 - 26,500	24	750	3.5mm	Solder Pin	<a href="#">PE1608</a>	\$1,309.36		32
	10 - 6,000	100	2500	N	Solder Pin	<a href="#">PE1612</a>	\$332.84		35
						<a href="#">PE1614</a>	\$456.27		36
						<a href="#">PE1616</a>	\$434.95		38
						<a href="#">PE1618</a>	\$903.76		42
						<a href="#">PE1606A</a>	\$689.00		30
						<a href="#">PE1BT1002</a>	\$731.06		31
	250 - 2,500	24	750	SMA	Solder Pin	<a href="#">PE1611</a>	\$369.24		33
	0.1 - 12,400					<a href="#">PE1613</a>	\$495.91		34
	0.1 - 18,000	<a href="#">PE1615</a>	\$343.74			37			
	10 - 2,500	100	2500			<a href="#">PE1604</a>	\$345.68		40
	10 - 4,000	50	500			<a href="#">PE1617</a>	\$732.38		41
	10 - 6,000	100	7000			<a href="#">PE1605</a>	\$537.57		43
	100 - 6,000	50	200			<a href="#">PE1BT1000</a>	\$1,038.96		44
	250 - 2,500	50	700			<a href="#">PE1603</a>	\$344.44		46
400 - 10,000	50	1000							
500 - 10,000	50	1000							
1,000 - 5,000	50	1000							

Bias Tees & DC Blocks

## DC Blocks



Impedance	Connector	Frequency Range (MHz.)	Type	Max. V (V)	Model No	1 Pc. Price	See Web for Volume Pricing	ROW
50 Ohm	1.85mm	10 - 65,000	Inner	200	<a href="#">PE8258</a>	\$727.42	See Web for Volume Pricing	47
			Inner		<a href="#">PE8237</a>	\$1,527.39		48
	2.4mm	100 - 50,000	Inner/Outer	<a href="#">PE8239</a>	\$1,852.97	49		
			Inner	<a href="#">PE8222</a>	\$302.25	50		
	2.92mm	10 - 26,500	Outer	<a href="#">PE8223</a>	\$363.62	51		
			Inner/Outer	<a href="#">PE8224</a>	\$490.46	52		
			Inner	<a href="#">PE8225</a>	\$750.91	53		
			Outer	<a href="#">PE8226</a>	\$1,554.18	54		
	BNC	10 - 4,000	10 - 4,000	Inner/Outer	<a href="#">PE8227</a>	\$1,291.13		55
				Inner	<a href="#">PE8216</a>	\$204.06		56
				Outer	<a href="#">PE8217</a>	\$282.97		57
				Inner/Outer	<a href="#">PE8218</a>	\$320.51		58
				Inner	<a href="#">PE8213</a>	\$155.90		59
				Outer	<a href="#">PE8214</a>	\$245.57		60
	N	10 - 18,000	10 - 18,000	Inner/Outer	<a href="#">PE8215</a>	\$281.30		61
				Inner	<a href="#">PE8251</a>	\$208.30		62
				Inner	<a href="#">PE8210</a>	\$115.25		63
				Outer	<a href="#">PE8211</a>	\$181.68		64
	SMA	10 - 18,000	10 - 18,000	Inner/Outer	<a href="#">PE8212</a>	\$255.09		65
				Inner	<a href="#">PE8250</a>	\$155.86		66
Inner				<a href="#">PE8219</a>	\$245.09	67		
Outer				<a href="#">PE8220</a>	\$345.08	68		
Inner/Outer				<a href="#">PE8221</a>	\$415.75	69		
Inner				<a href="#">PE8252</a>	\$315.57	70		
75 Ohm	BNC	100 - 4,000	Inner	200	<a href="#">PE8231</a>	\$322.70	71	
			Outer		<a href="#">PE8232</a>	\$194.07	72	
	F	10 - 2,000	Inner/Outer	<a href="#">PE8233</a>	\$386.16	73		
			Inner	<a href="#">PE8240</a>	\$134.26	74		
	N	100 - 4,000	100 - 4,000	Inner/Outer	<a href="#">PE8242</a>	\$264.48	75	
				Inner	<a href="#">PE8234</a>	\$276.50	76	
				Inner/Outer	<a href="#">PE8236</a>	\$271.25	77	

See Our Website For Current Pricing & Real-Time Stock Availability!



Technical Support  
+1 (949) 261-1920



Same-Day Shipping,  
Even Custom  
Cable Assemblies



# The Cable Creator™

Configure and Customize Your  
Cable Assemblies Online



**Over 250,000 Custom Cable Configurations Available to Ship Same Day!**



- Choose from over 2,030 RF coax connectors
- 123 coaxial cable types, including Twinax
- Choose your desired length (metric or standard)
- Includes high-reliability and low PIM assembly types
- ISO 9001:2015 certified production facility
- Optional Customizations:
  - Lead-free solder
  - Heat shrink
  - Labeling
  - Test plots
  - Clocking of right angle connectors

# Our Latest Cable Assembly Additions

Available in Standard and Custom Lengths! In-Stock and Shipped Same Day



## High-Reliability Cable Assemblies

- MIL-DTL-17 and Temperature Conditioned, Low Loss Options
- Maximum Frequency Levels as High as 18 GHz
- J-STD Soldering Processes
- IPC/WHMA-A-620 Workmanship
- Lot Traceability for Cables, Connectors, Heat Shrink and Solder
- Detailed Test Reports and Plots

## Low PIM Cable Assemblies

- Maximum PIM Levels as Low as -160dBc
- 100% PIM Tested with Results Marked on the Cable
- Low Loss, Excellent VSWR
- Lightweight, Extremely Flexible
- UL-Rated, Fire-Rated, Outdoor-Rated Cable Types
- Available with 4.3-10, 7/16 DIN, 4.1/9.5 Mini-DIN, Type-N, NEX10, SMA, and QMA Connector Series



## 40 GHz and 67 GHz Skew Matched Cable Pairs

- 1 ps Delay Match
- Excellent VSWR of 1.4:1
- 100% Tested Up to 40 or 67 GHz
- Extremely Flexible
- Polarity Indicators on Cable Ends

## Handheld RF Analyzer Rugged Phase Stable Cable Assemblies

- VSWR as Low as 1.2:1
- Phase Stability with Flexure as Low as  $\pm 1.5$  Degrees
- Amplitude Stability with Flexure as Low as  $\pm 0.1$  dB
- Rugged Armor with 1200 PSI Crush Resistance, Protects Cable During Field Measurements
- UV Resistant Jacket
- Test Data Included with Each Serialized Cable



## PE-P160LL Low Loss Cable Assemblies

- Triple-Shielded Low Loss Cable
- Maximum Frequency Levels as High as 18 GHz
- Shielding Effectivity >90 dB
- FEP Jacket
- 83% Phase Velocity
- Available with Type-N, SMA, and TNC Connector Series with Bulkhead and Right Angle Options

# Coaxial Cable Assemblies Selection Guide

Do you need a cable assembly that isn't in our RF Product Guide?  
Visit our website to view our entire selection of available assemblies or  
to build your own custom length cable assembly!

## 3 Easy Ways to Find your Product.....

### 1. Search by PE Part Number

If you know the PE part number you are searching for, please reference our Part Number Index on Page [395](#)

### 2. Quick Reference Guide

(Page number refers to first appearance of product in the Cable Assemblies Section)

Cable Connector	Page	Cable Connector	Page	Cable Connector	Page	Cable Connector	Page	Cable Connector	Page
1.0/2.3	<a href="#">97</a>	7/16 DIN	<a href="#">108</a>	BMA	<a href="#">113</a>	Mini UHF	<a href="#">132</a>	SHV	<a href="#">159</a>
1.0mm	<a href="#">97</a>	75 Ohm 1.6/5.6	<a href="#">216</a>	BNC	<a href="#">118</a>	MMBX	<a href="#">132</a>	SMA	<a href="#">159</a>
1.85mm	<a href="#">97</a>	75 Ohm BNC	<a href="#">217</a>	C	<a href="#">125</a>	MMCX	<a href="#">135</a>	SMB	<a href="#">195</a>
1.85mm NMD	<a href="#">214</a>	75 Ohm F	<a href="#">218</a>	D-Sub	<a href="#">215</a>	N	<a href="#">139</a>	SMC	<a href="#">198</a>
10-32	<a href="#">112</a>	75 Ohm Mini SMB	<a href="#">219</a>	FAKRA	<a href="#">125</a>	NEX10	<a href="#">214</a>	SMP	<a href="#">201</a>
2.2-5	<a href="#">98</a>	75 Ohm N	<a href="#">219</a>	FME	<a href="#">128</a>	NMO Mount	<a href="#">157</a>	SSMA	<a href="#">202</a>
2.4mm	<a href="#">99</a>	75 Ohm RCA	<a href="#">220</a>	GR874	<a href="#">129</a>	QMA	<a href="#">157</a>	SSMB	<a href="#">202</a>
2.4mm NMD	<a href="#">214</a>	75 Ohm SMB	<a href="#">220</a>	HMCX32 1.2	<a href="#">213</a>	QN	<a href="#">158</a>	SSMC	<a href="#">203</a>
2.92mm	<a href="#">100</a>	75 Ohm SMC	<a href="#">221</a>	HN	<a href="#">129</a>	Reverse Polarity SMA	<a href="#">179</a>	TNC	<a href="#">204</a>
2.92mm NMD	<a href="#">214</a>	75 Ohm TNC	<a href="#">221</a>	LC	<a href="#">129</a>	Reverse Polarity TNC	<a href="#">209</a>	UHF	<a href="#">212</a>
3.5mm	<a href="#">101</a>	78 Ohm BNC Twinax	<a href="#">221</a>	MC-Card	<a href="#">130</a>	Reverse Thread SMA	<a href="#">180</a>	UMCX	<a href="#">213</a>
3.5mm NMD	<a href="#">215</a>	95 Ohm 3/4"-20 Twinax	<a href="#">221</a>	MCX	<a href="#">130</a>	SC	<a href="#">158</a>	UMCX 2.1	<a href="#">213</a>
4.1/9.5 Mini DIN	<a href="#">102</a>	Banana	<a href="#">221</a>	MHV	<a href="#">131</a>			UMCX 2.5	<a href="#">213</a>
4.3-10	<a href="#">104</a>			Mini SMP	<a href="#">132</a>			WMCX 1.6	<a href="#">214</a>

### 3. Cable Assembly Locator

(Cable Assembly Locator on Page [89-92](#) to locate the Cable Assembly you need by either connector end.)



SMA Female Bulkhead to MCX Plug Right Angle  
PE39421-12

SMA FEMALE BULKHEAD TO:	EXAMPLE	MCX PLUG RIGHT ANGLE TO:	EXAMPLE
MCX PLUG RIGHT ANGLE.....	<a href="#">23</a>	MCX PLUG.....	78
MMCX PLUG RIGHT ANGLE.....	23	MCX PLUG RIGHT ANGLE.....	79
SMA FEMALE BULKHEAD.....	43	N FEMALE BULKHEAD.....	25
SMA MALE.....	17,23,31,32	SMA FEMALE BULKHEAD.....	<a href="#">23</a>
SMA MALE RIGHT ANGLE.....	17,23,40,41	TNC FEMALE BULKHEAD.....	27
UMCX PLUG.....	76	UMCX PLUG.....	76

The Cable Assembly Locator example above includes Between-Series Cable Assembly part numbers in two configurations:  
**Connector 1 to Connector 2 as well as Connector 2 to Connector 1 will be found in the same location.**

Products can only be found under the first instance of the series combination. As an example, PE39421-12 above will be found in only one location in the Cable Assembly Section.

All Pasternack coaxial cable assembly part number indicate the length of the assembly (in inches) following the hyphen.  
Example: PE300-24 and PE300-26.5 are 24 inches and 26.5 inches in length respectively

**NOTE:** All cable assemblies have a length tolerance of 1.5% or  $\pm 3/8"$ , whichever is greater.

# Cable Assembly Locator

Connector Type	Page
<b>1.0/2.3 Jack Bulkhead To:</b>	
1.0/2.3 JACK BULKHEAD .....	97
<b>1.0/2.3 Plug To:</b>	
BNC FEMALE BULKHEAD .....	97
<b>1.0/2.3 Plug Right Angle To:</b>	
BNC MALE .....	97
<b>1.0mm Male To:</b>	
1.0mm FEMALE .....	97
1.0mm MALE .....	97
<b>1.85mm Female To:</b>	
1.85mm FEMALE .....	98
<b>1.85mm Male To:</b>	
1.85mm FEMALE .....	97
1.85mm MALE .....	97
1.85mm MALE RIGHT ANGLE .....	97
2.4mm MALE .....	97
2.92mm MALE .....	98
<b>1.85mm NMD Female To:</b>	
1.85mm FEMALE .....	214
1.85mm MALE .....	214
<b>10-32 Female To:</b>	
BNC MALE .....	113
<b>10-32 Male To:</b>	
10-32 MALE .....	112
10-32 MALE RIGHT ANGLE .....	112
BNC MALE .....	113
<b>10-32 Male Right Angle To:</b>	
10-32 MALE RIGHT ANGLE .....	113
BNC FEMALE .....	113
SMP FEMALE .....	113
<b>2.2-5 Female To:</b>	
4.3-10 FEMALE .....	99
4.3-10 FEMALE BULKHEAD .....	99
4.3-10 MALE .....	99
4.3-10 MALE RIGHT ANGLE .....	99
N FEMALE .....	99
N FEMALE BULKHEAD .....	99
N MALE .....	99
N MALE RIGHT ANGLE .....	99
<b>2.2-5 Male To:</b>	
2.2-5 FEMALE .....	98
2.2-5 FEMALE BULKHEAD .....	98
2.2-5 MALE .....	98
2.2-5 MALE RIGHT ANGLE .....	98
4.3-10 FEMALE .....	98
4.3-10 FEMALE 4 HOLE FLANGE .....	98
4.3-10 FEMALE BULKHEAD .....	98
4.3-10 MALE .....	98
4.3-10 MALE RIGHT ANGLE .....	98
N FEMALE .....	98
N FEMALE BULKHEAD .....	98
N MALE .....	98
N MALE RIGHT ANGLE .....	98
<b>2.2-5 Male Right Angle To:</b>	
2.2-5 FEMALE .....	99
2.2-5 FEMALE BULKHEAD .....	99
2.2-5 MALE RIGHT ANGLE .....	99
<b>2.4mm Female To:</b>	
2.4mm FEMALE .....	100
<b>2.4mm Female Bulkhead To:</b>	
SMA MALE .....	100
<b>2.4mm Male To:</b>	
1.85mm MALE .....	99
2.4mm FEMALE .....	100
2.4mm MALE .....	99
2.4mm MALE RIGHT ANGLE .....	100
<b>2.4mm NMD Female To:</b>	
2.4mm FEMALE .....	214
2.4mm MALE .....	214

Connector Type	Page
<b>2.92mm Female Bulkhead To:</b>	
Straight Cut Lead Sexless .....	215
<b>2.92mm Male To:</b>	
1.85mm MALE .....	100
2.4mm MALE .....	100
2.92mm FEMALE .....	101
2.92mm FEMALE BULKHEAD .....	101
2.92mm MALE .....	100
<b>2.92mm NMD Female To:</b>	
2.92mm FEMALE .....	214
2.92mm MALE .....	214
<b>3.5mm Female To:</b>	
3.5mm FEMALE .....	102
3.5mm NMD FEMALE .....	215
Straight Cut Lead Sexless .....	215
<b>3.5mm Male To:</b>	
1.85mm MALE .....	101
3.5mm FEMALE .....	101
3.5mm FEMALE BULKHEAD .....	101
3.5mm MALE .....	101
<b>3.5mm NMD Female To:</b>	
3.5mm MALE .....	215
<b>4.1/9.5 Mini DIN Female To:</b>	
4.3-10 MALE .....	96
7/16 DIN MALE .....	96
N MALE .....	96
QMA MALE .....	96
SMA MALE .....	96
<b>4.1/9.5 Mini DIN Male To:</b>	
4.1/9.5 MINI DIN FEMALE .....	96
4.1/9.5 MINI DIN FEMALE BULKHEAD .....	102
4.1/9.5 MINI DIN MALE .....	96
4.1/9.5 MINI DIN MALE RIGHT ANGLE .....	102
4.3-10 FEMALE .....	96
4.3-10 MALE .....	96
7/16 DIN FEMALE .....	96
7/16 DIN MALE .....	96
N FEMALE .....	96
N MALE .....	96
QMA FEMALE .....	96
QMA MALE .....	96
QMA MALE RIGHT ANGLE .....	102
SMA FEMALE .....	96
SMA MALE .....	96
SMA MALE RIGHT ANGLE .....	103
<b>4.1/9.5 Mini DIN Male Right Angle To:</b>	
4.1/9.5 MINI DIN FEMALE .....	103
4.1/9.5 MINI DIN FEMALE BULKHEAD .....	103
4.1/9.5 MINI DIN MALE RIGHT ANGLE .....	103
4.3-10 FEMALE .....	103
4.3-10 MALE .....	103
7/16 DIN MALE .....	103
N MALE .....	103
N MALE RIGHT ANGLE .....	103
QMA MALE .....	103
SMA MALE .....	103
<b>4.3-10 Female To:</b>	
4.3-10 FEMALE .....	107
7/16 DIN MALE .....	96
7/16 DIN MALE RIGHT ANGLE .....	108
N MALE .....	96
N MALE RIGHT ANGLE .....	108
NEX10 MALE .....	108
QMA MALE .....	96
SMA MALE .....	96
<b>4.3-10 Male To:</b>	
4.3-10 FEMALE .....	96
4.3-10 FEMALE 4 HOLE FLANGE .....	105
4.3-10 FEMALE BULKHEAD .....	104
4.3-10 MALE .....	96
4.3-10 MALE RIGHT ANGLE .....	104
7/16 DIN FEMALE .....	96
7/16 DIN MALE .....	96
7/16 DIN MALE RIGHT ANGLE .....	105
N FEMALE .....	105

Connector Type	Page
N FEMALE BULKHEAD .....	106
N MALE .....	105
N MALE RIGHT ANGLE .....	105
NEX10 MALE .....	106
QMA FEMALE .....	96
QMA MALE .....	96
QMA MALE RIGHT ANGLE .....	106
SMA FEMALE .....	96
SMA MALE .....	96
SMA MALE RIGHT ANGLE .....	106
<b>4.3-10 Male Right Angle To:</b>	
4.3-10 FEMALE .....	106
4.3-10 FEMALE 4 HOLE FLANGE .....	107
4.3-10 FEMALE BULKHEAD .....	107
4.3-10 MALE .....	106
4.3-10 MALE RIGHT ANGLE .....	106
7/16 DIN FEMALE .....	107
7/16 DIN MALE .....	107
7/16 DIN MALE RIGHT ANGLE .....	107
N FEMALE BULKHEAD .....	107
N MALE .....	107
N MALE RIGHT ANGLE .....	107
NEX10 MALE .....	107
SMA MALE .....	107
SMA MALE RIGHT ANGLE .....	107
<b>7/16 DIN Female To:</b>	
7/16 DIN FEMALE .....	112
N MALE .....	96
N MALE RIGHT ANGLE .....	112
NEX10 MALE .....	112
QMA MALE .....	96
SMA MALE .....	96
<b>7/16 DIN Male To:</b>	
4.3-10 FEMALE .....	108
7/16 DIN FEMALE .....	96
7/16 DIN FEMALE BULKHEAD .....	110
7/16 DIN MALE .....	96
7/16 DIN MALE RIGHT ANGLE .....	109
N FEMALE .....	110
N FEMALE BULKHEAD .....	110
N MALE .....	110
N MALE RIGHT ANGLE .....	110
NEX10 MALE .....	111
QMA FEMALE .....	96
QMA MALE .....	96
QMA MALE RIGHT ANGLE .....	111
SC MALE .....	111
SMA FEMALE .....	96
SMA MALE .....	96
SMA MALE RIGHT ANGLE .....	111
<b>7/16 DIN Male Right Angle To:</b>	
7/16 DIN FEMALE .....	111
7/16 DIN FEMALE BULKHEAD .....	111
7/16 DIN MALE .....	111
7/16 DIN MALE RIGHT ANGLE .....	111
N FEMALE .....	112
N FEMALE BULKHEAD .....	112
N MALE .....	111
N MALE RIGHT ANGLE .....	112
NEX10 MALE .....	112
<b>75 Ohm 1.6/5.6 Plug To:</b>	
75 Ohm 1.6/5.6 PLUG .....	216
75 Ohm 1.6/5.6 PLUG RIGHT ANGLE .....	216
75 Ohm BNC MALE .....	216
<b>75 Ohm 1.6/5.6 Plug Right Angle To:</b>	
75 Ohm 1.6/5.6 PLUG RIGHT ANGLE .....	217
<b>75 Ohm BNC Female To:</b>	
75 Ohm BNC FEMALE .....	218
<b>75 Ohm BNC Female Bulkhead To:</b>	
75 Ohm BNC FEMALE BULKHEAD .....	218
<b>75 Ohm BNC Male To:</b>	
75 Ohm BNC FEMALE .....	217
75 Ohm BNC FEMALE BULKHEAD .....	217
75 Ohm BNC MALE .....	217
75 Ohm BNC MALE RIGHT ANGLE .....	217
Straight Cut Lead Sexless .....	221





# Cable Assembly Locator

Connector Type	Page
<b>75 Ohm BNC Male Right Angle To:</b>	
75 Ohm BNC MALE RIGHT ANGLE.....	217
<b>75 Ohm F Female To:</b>	
75 Ohm F FEMALE.....	219
<b>75 Ohm F Male To:</b>	
75 Ohm BNC MALE.....	218
75 Ohm F FEMALE.....	218
75 Ohm F FEMALE BULKHEAD.....	219
75 Ohm F MALE.....	218
75 Ohm F MALE RIGHT ANGLE.....	218
<b>75 Ohm Mini SMB Plug To:</b>	
75 Ohm BNC MALE.....	219
75 Ohm MINI SMB JACK.....	219
75 Ohm MINI SMB PLUG.....	219
75 Ohm MINI SMB PLUG RIGHT ANGLE.....	219
75 Ohm TNC MALE.....	219
<b>75 Ohm Mini SMB Plug Right Angle To:</b>	
75 Ohm F FEMALE BULKHEAD.....	219
75 Ohm MINI SMB PLUG RIGHT ANGLE.....	219
<b>75 Ohm N Female To:</b>	
75 Ohm N FEMALE.....	220
<b>75 Ohm N Male To:</b>	
75 Ohm BNC MALE.....	219
75 Ohm F FEMALE.....	220
75 Ohm F MALE.....	220
75 Ohm N FEMALE.....	220
75 Ohm N MALE.....	220
<b>75 Ohm RCA Male To:</b>	
75 Ohm RCA FEMALE BULKHEAD.....	220
75 Ohm RCA MALE.....	220
75 Ohm RCA MALE RIGHT ANGLE.....	220
<b>75 Ohm SMB Plug To:</b>	
75 Ohm BNC MALE.....	220
75 Ohm SMB PLUG.....	221
<b>75 Ohm SMC Plug To:</b>	
75 Ohm BNC MALE.....	221
75 Ohm SMC PLUG.....	221
<b>75 Ohm TNC Male To:</b>	
75 Ohm BNC MALE.....	221
75 Ohm TNC MALE.....	221
<b>78 Ohm BNC Twinax Plug To:</b>	
78 Ohm BNC TWINAX PLUG.....	221
<b>95 Ohm 3/4"-20 Twinax Male To:</b>	
95 Ohm 3/4"-20 TWINAX MALE.....	221
<b>Banana Plug To:</b>	
SMA MALE.....	221
<b>BMA Jack To:</b>	
BMA JACK.....	115
BNC MALE.....	115
N MALE.....	116
SMA MALE.....	116
SMA MALE RIGHT ANGLE.....	116
SMP FEMALE.....	116
SMP FEMALE RIGHT ANGLE.....	116
TNC MALE.....	116
<b>BMA Jack 2 Hole Flange To:</b>	
BMA JACK 2 HOLE FLANGE.....	117
BNC MALE.....	117
N MALE.....	117
SMA MALE.....	117
SMA MALE RIGHT ANGLE.....	117
SMP FEMALE.....	117
SMP FEMALE RIGHT ANGLE.....	118
TNC MALE.....	118
<b>BMA Jack Bulkhead To:</b>	
BMA JACK BULKHEAD.....	117
<b>BMA Jack Right Angle 2 Hole Flange To:</b>	
BMA JACK RIGHT ANGLE 2 HOLE FLANGE.....	118

Connector Type	Page
<b>BMA Plug Bulkhead To:</b>	
BMA JACK.....	113
BMA JACK 2 HOLE FLANGE.....	114
BMA JACK BULKHEAD.....	113
BMA JACK RIGHT ANGLE 2 HOLE FLANGE.....	114
BMA PLUG BULKHEAD.....	113
BNC MALE.....	114
N MALE.....	114
SMA MALE.....	114
SMA MALE RIGHT ANGLE.....	115
SMP FEMALE.....	115
SMP FEMALE RIGHT ANGLE.....	115
TNC MALE.....	115
<b>BNC Female To:</b>	
BNC FEMALE.....	124
BNC MALE RIGHT ANGLE.....	124
NMO Mount Sexless.....	215
SMA MALE.....	125
<b>BNC Female Bulkhead To:</b>	
SMA MALE.....	125
<b>BNC Male To:</b>	
7/16 DIN FEMALE.....	121
BNC FEMALE.....	121
BNC FEMALE BULKHEAD.....	122
BNC MALE.....	93
BNC MALE RIGHT ANGLE.....	121
FAKRA PLUG.....	122
MCX JACK BULKHEAD.....	122
MHV MALE.....	122
N FEMALE.....	93
N FEMALE BULKHEAD.....	118
N MALE.....	93
N MALE RIGHT ANGLE.....	123
NMO Mount Sexless.....	215
SHV PLUG.....	123
SMA FEMALE.....	93
SMA FEMALE BULKHEAD.....	119
SMA MALE.....	93
SMA MALE RIGHT ANGLE.....	119
SSMC JACK BULKHEAD.....	123
SSMC PLUG.....	123
SSMC PLUG RIGHT ANGLE.....	123
Straight Cut Lead Sexless.....	215
TNC MALE.....	93
UHF FEMALE.....	123
<b>BNC Male Right Angle To:</b>	
BNC FEMALE BULKHEAD.....	124
BNC MALE RIGHT ANGLE.....	124
SMA FEMALE.....	124
TNC MALE RIGHT ANGLE.....	124
<b>C Male To:</b>	
C MALE.....	125
<b>D-Subminiature Receptacle To:</b>	
BNC MALE.....	215
<b>FAKRA Jack To:</b>	
FAKRA JACK.....	127
FAKRA JACK RIGHT ANGLE.....	128
MCX PLUG.....	128
REVERSE POLARITY TNC MALE.....	128
SMA FEMALE.....	128
<b>FAKRA Jack Right Angle To:</b>	
FAKRA PLUG.....	128
<b>FAKRA Plug To:</b>	
FAKRA JACK.....	126
FAKRA JACK RIGHT ANGLE.....	126
FAKRA PLUG.....	125
SMA MALE.....	127
<b>FME Jack To:</b>	
BNC MALE.....	128
FME JACK.....	128
NMO Mount Sexless.....	215
<b>FME Plug To:</b>	
BNC MALE.....	128
FME PLUG.....	128

Connector Type	Page
NMO Mount Sexless.....	215
<b>FME Plug Bulkhead To:</b>	
UMCX PLUG RIGHT ANGLE.....	128
<b>GR874 Sexless To:</b>	
BNC MALE.....	129
GR874 Sexless.....	129
<b>HMCX32 1.2 Plug To:</b>	
HMCX32 1.2 PLUG.....	213
<b>HN Male To:</b>	
7/16 DIN MALE RIGHT ANGLE.....	129
HN MALE.....	129
<b>HN Male Right Angle To:</b>	
HN FEMALE.....	129
<b>LC Male To:</b>	
LC MALE.....	129
<b>LC Male Right Angle To:</b>	
HN MALE.....	130
<b>MC-Card Plug To:</b>	
MC-Card PLUG.....	130
MC-Card PLUG RIGHT ANGLE.....	130
<b>MC-Card Plug Right Angle To:</b>	
MC-Card PLUG RIGHT ANGLE.....	130
<b>MCX Jack To:</b>	
MCX JACK.....	131
<b>MCX Plug To:</b>	
75 Ohm BNC MALE.....	215
BNC MALE.....	130
MCX PLUG.....	130
MCX PLUG RIGHT ANGLE.....	130
SMA MALE.....	130
TNC FEMALE BULKHEAD.....	131
<b>MCX Plug Right Angle To:</b>	
BNC FEMALE 4 HOLE FLANGE.....	131
MCX JACK BULKHEAD.....	131
MCX PLUG RIGHT ANGLE.....	131
SMA MALE.....	131
<b>MHV Male To:</b>	
MHV MALE.....	131
MHV MALE RIGHT ANGLE.....	132
SHV PLUG.....	132
<b>Mini SMP Female To:</b>	
MINI SMP FEMALE RIGHT ANGLE.....	132
SMA MALE RIGHT ANGLE.....	132
<b>Mini UHF Female To:</b>	
NMO Mount Sexless.....	215
<b>Mini UHF Male To:</b>	
MINI UHF MALE.....	132
NMO Mount Sexless.....	215
<b>MMBX Plug To:</b>	
MMBX PLUG.....	132
MMBX PLUG RIGHT ANGLE.....	133
N FEMALE BULKHEAD.....	133
REVERSE POLARITY SMA FEMALE BULKHEAD.....	134
SMA FEMALE.....	133
SMA FEMALE BULKHEAD.....	133
SMA MALE.....	133
SMA MALE RIGHT ANGLE.....	133
SSMB JACK BULKHEAD.....	134
TNC FEMALE BULKHEAD.....	134
<b>MMBX Plug Right Angle To:</b>	
MMBX PLUG RIGHT ANGLE.....	134
N FEMALE BULKHEAD.....	134
REVERSE POLARITY SMA FEMALE BULKHEAD.....	135
SMA FEMALE.....	135
SMA FEMALE BULKHEAD.....	135
SMA MALE.....	134
SMA MALE RIGHT ANGLE.....	134
TNC FEMALE BULKHEAD.....	135

# Cable Assembly Locator

Connector Type	Page
<b>MMCX Plug To:</b>	
MMCX PLUG	135
MMCX PLUG RIGHT ANGLE	135
N FEMALE BULKHEAD	136
SMC PLUG	136
<b>MMCX Plug Right Angle To:</b>	
BNC FEMALE BULKHEAD	136
MMCX PLUG	136
SMA FEMALE	136
SMA MALE RIGHT ANGLE	136
<b>N Female To:</b>	
7/16 DIN MALE	96
N FEMALE	93
N FEMALE BULKHEAD	152
N MALE	94
NEX10 MALE	154
NMO Mount Sexless	215
QN MALE	154
QN MALE RIGHT ANGLE	154
SMA MALE	93
SMA MALE RIGHT ANGLE	153
TNC MALE	93
<b>N Female 4 Hole Flange To:</b>	
MMCX PLUG RIGHT ANGLE	157
N MALE RIGHT ANGLE	157
<b>N Female Bulkhead To:</b>	
HMCX32 1.2 PLUG	156
MCX PLUG RIGHT ANGLE	155
MMCX PLUG RIGHT ANGLE	155
N FEMALE BULKHEAD	154
N MALE	155
N MALE RIGHT ANGLE	155
NEX10 MALE	157
QMA MALE RIGHT ANGLE	155
REVERSE POLARITY SMA MALE RIGHT ANGLE	156
SMA FEMALE	156
SMA FEMALE BULKHEAD	156
SMA MALE	154
SMA MALE RIGHT ANGLE	154
SMP FEMALE RIGHT ANGLE	156
TNC FEMALE BULKHEAD	156
TNC MALE	155
TNC MALE RIGHT ANGLE	156
UMCX 2.1 PLUG	156
UMCX 2.5 PLUG	156
WMCX 1.6 PLUG	156
<b>N Male To:</b>	
4-1/9.5 MINI DIN MALE	96
4.3-10 MALE	96
7/16 DIN FEMALE	96
7/16 DIN MALE	96
7/16 DIN MALE RIGHT ANGLE	144
BNC FEMALE BULKHEAD	145
BNC MALE	144
BNC MALE RIGHT ANGLE	145
C FEMALE	145
GR874 Sexless	145
MCX PLUG RIGHT ANGLE	145
MINI UHF MALE	145
N FEMALE	93
N FEMALE 4 HOLE FLANGE	143
N FEMALE BULKHEAD	142
N MALE	93
N MALE RIGHT ANGLE	139
NEX10 MALE	149
NMO Mount Sexless	215
QMA FEMALE	96
QMA MALE	96
QMA MALE RIGHT ANGLE	145
QN MALE	146
QN MALE RIGHT ANGLE	146
REVERSE POLARITY TNC MALE	149
REVERSE POLARITY TNC MALE RIGHT ANGLE	149
SHV PLUG	146
SMA FEMALE	96
SMA FEMALE BULKHEAD	147
SMA MALE	93
SMA MALE RIGHT ANGLE	147

Connector Type	Page
SSMC JACK BULKHEAD	147
SSMC PLUG	147
SSMC PLUG RIGHT ANGLE	147
TNC FEMALE	149
TNC FEMALE BULKHEAD	149
TNC MALE	93
TNC MALE RIGHT ANGLE	149
UMCX PLUG RIGHT ANGLE	149
<b>N Male Right Angle To:</b>	
BNC MALE	149
BNC MALE RIGHT ANGLE	149
N FEMALE	151
N FEMALE BULKHEAD	151
N MALE	150
N MALE RIGHT ANGLE	150
NEX10 MALE	152
SMA FEMALE BULKHEAD	152
SMA MALE	152
SMA MALE RIGHT ANGLE	152
TNC FEMALE BULKHEAD	152
TNC MALE	152
TNC MALE RIGHT ANGLE	152
UHF MALE	152
<b>NEX10 Male To:</b>	
NEX10 FEMALE	214
NEX10 FEMALE BULKHEAD	214
NEX10 MALE	214
NEX10 MALE RIGHT ANGLE	214
<b>NEX10 Male Right Angle To:</b>	
NEX10 FEMALE	214
NEX10 FEMALE BULKHEAD	214
NEX10 MALE RIGHT ANGLE	214
<b>NMO Mount Sexless To:</b>	
TNC MALE	157
<b>QMA Female To:</b>	
SMA MALE	96
<b>QMA Male To:</b>	
QMA FEMALE	96
QMA FEMALE BULKHEAD	157
QMA MALE	96
QMA MALE RIGHT ANGLE	157
SMA FEMALE	96
SMA MALE	96
SMA MALE RIGHT ANGLE	157
<b>QMA Male Right Angle To:</b>	
QMA FEMALE	158
QMA FEMALE BULKHEAD	158
QMA MALE RIGHT ANGLE	157
SMA MALE	158
<b>QN Male To:</b>	
QN MALE	158
QN MALE RIGHT ANGLE	158
<b>QN Male Right Angle To:</b>	
N FEMALE	158
<b>Reverse Polarity SMA Female Bulkhead To:</b>	
HMCX32 1.2 PLUG	194
SMA MALE	194
SMA MALE RIGHT ANGLE	194
UMCX 2.1 PLUG	194
UMCX 2.5 PLUG	194
UMCX PLUG RIGHT ANGLE	194
WMCX 1.6 PLUG	195
<b>Reverse Polarity SMA Male To:</b>	
BNC MALE	179
MCX PLUG RIGHT ANGLE	179
N FEMALE BULKHEAD	179
N MALE	179
REVERSE POLARITY SMA FEMALE	180
REVERSE POLARITY SMA MALE	179
TNC MALE	180
<b>Reverse Polarity SMA Male Right Angle To:</b>	
N MALE	187
N MALE RIGHT ANGLE	187

Connector Type	Page
SMA MALE	187
<b>Reverse Polarity TNC Female To:</b>	
REVERSE POLARITY SMA MALE	210
<b>Reverse Polarity TNC Female Bulkhead To:</b>	
MMCX PLUG	212
REVERSE POLARITY SMA MALE	212
REVERSE POLARITY TNC MALE	212
SSMC PLUG RIGHT ANGLE	212
UMCX PLUG	212
<b>Reverse Polarity TNC Male To:</b>	
BNC MALE	209
<b>Reverse Thread SMA Female Bulkhead To:</b>	
UMCX PLUG RIGHT ANGLE	195
<b>Reverse Thread SMA Male To:</b>	
Reverse Thread SMA MALE	180
<b>SC Male To:</b>	
SC MALE	158
<b>SHV Jack Bulkhead To:</b>	
SHV PLUG	159
<b>SHV Plug To:</b>	
SHV JACK BULKHEAD	159
SHV PLUG	159
<b>SMA Female To:</b>	
FAKRA JACK	188
FAKRA PLUG	187
MCX PLUG RIGHT ANGLE	188
MMCX PLUG	188
N FEMALE	94
N FEMALE BULKHEAD	189
N MALE	94
N MALE RIGHT ANGLE	189
NMO Mount Sexless	216
QMA MALE	189
SMA FEMALE	94
SMA FEMALE BULKHEAD	190
SMA MALE	94
SMA MALE RIGHT ANGLE	189
SSMC JACK BULKHEAD	190
SSMC PLUG	190
SSMC PLUG RIGHT ANGLE	190
Straight Cut Lead Sexless	216
TNC FEMALE	94
TNC FEMALE BULKHEAD	190
TNC MALE	94
TNC MALE RIGHT ANGLE	190
Trimmed Lead Sexless	216
<b>SMA Female 2 Hole Flange To:</b>	
SMA FEMALE 2 HOLE FLANGE	195
SMP FEMALE	195
SMP FEMALE RIGHT ANGLE	195
<b>SMA Female 4 Hole Flange To:</b>	
MMCX PLUG RIGHT ANGLE	195
SMA FEMALE 4 HOLE FLANGE	195
<b>SMA Female Bulkhead To:</b>	
HMCX32 1.2 PLUG	194
MCX PLUG RIGHT ANGLE	191
MMCX PLUG	191
MMCX PLUG RIGHT ANGLE	191
N FEMALE BULKHEAD	191
N MALE	191
N MALE RIGHT ANGLE	191
REVERSE POLARITY SMA MALE	193
SMA FEMALE	192
SMA FEMALE BULKHEAD	191
SMA MALE	191
SMA MALE RIGHT ANGLE	192
SMB PLUG RIGHT ANGLE	193
SMP FEMALE	193
SMP FEMALE RIGHT ANGLE	193
SSMC JACK BULKHEAD	193
SSMC PLUG	193
SSMC PLUG RIGHT ANGLE	193
TNC FEMALE BULKHEAD	194



# Cable Assembly Locator

Connector Type	Page
<b>SMA Female Bulkhead To:</b>	
TNC MALE.....	191
TNC MALE RIGHT ANGLE.....	193
UMCX 2.1 PLUG.....	194
UMCX 2.5 PLUG.....	194
UMCX PLUG RIGHT ANGLE.....	194
WMCX 1.6 PLUG.....	194
<b>SMA Female Right Angle To:</b>	
SMA FEMALE BULKHEAD.....	190
<b>SMA Male To:</b>	
1.85mm MALE.....	159
2.4mm MALE.....	159
2.92mm MALE.....	160
7/16 DIN MALE.....	96
BNC MALE.....	160
BNC MALE RIGHT ANGLE.....	161
FAKRA JACK.....	161
FAKRA PLUG.....	161
HMCX32 1.2 PLUG.....	178
MC-Card PLUG.....	162
MCX PLUG.....	162
MINI UHF MALE.....	162
MMCX PLUG.....	162
MMCX PLUG RIGHT ANGLE.....	163
N FEMALE.....	94
N FEMALE BULKHEAD.....	164
N MALE.....	94
N MALE RIGHT ANGLE.....	164
NEX10 MALE.....	179
NMO Mount Sexless.....	215
QMA MALE.....	166
REVERSE POLARITY SMA MALE.....	173
REVERSE POLARITY SMA MALE RIGHT ANGLE.....	173
REVERSE POLARITY TNC MALE.....	178
Reverse Thread SMA MALE.....	173
SMA FEMALE.....	94
SMA FEMALE BULKHEAD.....	170
SMA MALE.....	94
SMA MALE RIGHT ANGLE.....	168
SMB JACK.....	174
SMB PLUG.....	174
SMB PLUG RIGHT ANGLE.....	174
SMC PLUG.....	174
SMP FEMALE.....	175
SMP FEMALE RIGHT ANGLE.....	175
SSMA MALE.....	175
SSMC JACK.....	176
SSMC JACK BULKHEAD.....	176
SSMC PLUG.....	175
SSMC PLUG RIGHT ANGLE.....	175
Straight Cut Lead Sexless.....	216
TNC FEMALE.....	94
TNC FEMALE BULKHEAD.....	178
TNC MALE.....	94
TNC MALE RIGHT ANGLE.....	177
UMCX 2.1 PLUG.....	178
UMCX 2.5 PLUG.....	178
UMCX PLUG.....	178
WMCX 1.6 PLUG.....	179
<b>SMA Male Right Angle To:</b>	
BNC FEMALE BULKHEAD.....	181
BNC MALE.....	181
MCX JACK.....	181
MCX PLUG RIGHT ANGLE.....	181
MMCX PLUG RIGHT ANGLE.....	181
N FEMALE.....	182
N FEMALE BULKHEAD.....	182
N MALE.....	181
N MALE RIGHT ANGLE.....	182
NEX10 MALE.....	187
REVERSE POLARITY SMA FEMALE.....	185
REVERSE POLARITY SMA MALE RIGHT ANGLE.....	185
REVERSE POLARITY TNC MALE RIGHT ANGLE.....	187
SMA FEMALE.....	184
SMA FEMALE BULKHEAD.....	180
SMA MALE.....	182
SMA MALE RIGHT ANGLE.....	180
SMB PLUG.....	185
SMB PLUG RIGHT ANGLE.....	185
SMC PLUG RIGHT ANGLE.....	186

Connector Type	Page
SSMC JACK BULKHEAD.....	186
SSMC PLUG.....	186
SSMC PLUG RIGHT ANGLE.....	186
TNC FEMALE BULKHEAD.....	186
TNC MALE.....	180
TNC MALE RIGHT ANGLE.....	186
<b>SMB Plug To:</b>	
BNC MALE.....	195
N FEMALE.....	196
SMB JACK BULKHEAD.....	197
SMB PLUG.....	196
SMB PLUG RIGHT ANGLE.....	196
SMP FEMALE.....	197
SSMA MALE.....	197
<b>SMB Plug Right Angle To:</b>	
BNC MALE.....	197
SMA MALE.....	197
SMB JACK BULKHEAD.....	198
SMB PLUG RIGHT ANGLE.....	197
SSMB PLUG.....	198
<b>SMC Jack Bulkhead To:</b>	
UMCX PLUG RIGHT ANGLE.....	201
<b>SMC Plug To:</b>	
10-32 MALE RIGHT ANGLE.....	198
BNC MALE.....	198
MCX PLUG.....	198
SMA MALE.....	198
SMC JACK BULKHEAD.....	199
SMC PLUG.....	198
SMC PLUG RIGHT ANGLE.....	199
<b>SMC Plug Right Angle To:</b>	
BNC MALE.....	200
SMC JACK BULKHEAD.....	200
SMC PLUG RIGHT ANGLE.....	200
TNC FEMALE BULKHEAD.....	200
<b>SMP Female To:</b>	
SMA MALE.....	201
SMP FEMALE.....	201
SMP FEMALE RIGHT ANGLE.....	201
<b>SMP Female Right Angle To:</b>	
BNC MALE.....	201
MMCX PLUG RIGHT ANGLE.....	201
N FEMALE BULKHEAD.....	201
REVERSE POLARITY TNC FEMALE BULKHEAD.....	202
SMA FEMALE.....	201
SMA FEMALE 2 HOLE FLANGE.....	202
SMA MALE RIGHT ANGLE.....	201
SMP FEMALE.....	202
SMP FEMALE RIGHT ANGLE.....	202
<b>SMP Male Bulkhead To:</b>	
SMA MALE.....	201
SMP FEMALE RIGHT ANGLE.....	201
<b>SSMA Male To:</b>	
SSMA MALE.....	202
SSMA MALE RIGHT ANGLE.....	202
Trimmed Lead Sexless.....	216
<b>SSMA Male Right Angle To:</b>	
SSMA MALE RIGHT ANGLE.....	202
<b>SSMB Plug To:</b>	
SMA MALE.....	202
SSMB PLUG.....	202
<b>SSMB Plug Right Angle To:</b>	
SSMB PLUG RIGHT ANGLE.....	203
Straight Cut Lead Sexless.....	216
<b>SSMC Jack Bulkhead To:</b>	
SSMC JACK BULKHEAD.....	204
SSMC JACK RIGHT ANGLE BULKHEAD.....	204
TNC MALE.....	204
<b>SSMC Jack Right Angle Bulkhead To:</b>	
SSMC JACK RIGHT ANGLE BULKHEAD.....	204
<b>SSMC Plug To:</b>	
SMB JACK BULKHEAD.....	203

Connector Type	Page
SSMC JACK BULKHEAD.....	203
SSMC JACK RIGHT ANGLE BULKHEAD.....	203
SSMC PLUG.....	203
SSMC PLUG RIGHT ANGLE.....	203
TNC MALE.....	203
<b>SSMC Plug Right Angle To:</b>	
SMA MALE.....	203
SSMC JACK BULKHEAD.....	204
SSMC JACK RIGHT ANGLE BULKHEAD.....	204
SSMC PLUG RIGHT ANGLE.....	203
TNC FEMALE BULKHEAD.....	204
TNC MALE.....	204
<b>TNC Female To:</b>	
N FEMALE.....	95
N MALE.....	95
NMO Mount Sexless.....	216
REVERSE POLARITY TNC MALE.....	210
SMA MALE.....	210
TNC FEMALE.....	95
TNC MALE.....	95
<b>TNC Female Bulkhead To:</b>	
MCX PLUG RIGHT ANGLE.....	210
MMCX PLUG RIGHT ANGLE.....	210
N FEMALE BULKHEAD.....	211
N MALE.....	211
N MALE RIGHT ANGLE.....	211
SMA MALE.....	211
SMA MALE RIGHT ANGLE.....	211
SMC PLUG RIGHT ANGLE.....	211
SMP FEMALE RIGHT ANGLE.....	211
SSMC PLUG RIGHT ANGLE.....	211
TNC FEMALE BULKHEAD.....	211
TNC MALE.....	211
TNC MALE RIGHT ANGLE.....	211
UMCX PLUG RIGHT ANGLE.....	212
<b>TNC Male To:</b>	
BNC MALE.....	204
MINI UHF MALE.....	205
N FEMALE.....	95
N FEMALE BULKHEAD.....	205
N MALE.....	95
N MALE RIGHT ANGLE.....	205
REVERSE POLARITY TNC MALE.....	208
SMA MALE.....	206
SMA MALE RIGHT ANGLE.....	206
SMP FEMALE RIGHT ANGLE.....	206
TNC FEMALE.....	95
TNC FEMALE BULKHEAD.....	208
TNC MALE.....	94
TNC MALE RIGHT ANGLE.....	208
<b>TNC Male Right Angle To:</b>	
N FEMALE BULKHEAD.....	209
N MALE.....	209
N MALE RIGHT ANGLE.....	209
TNC FEMALE.....	210
TNC FEMALE BULKHEAD.....	210
TNC MALE.....	209
TNC MALE RIGHT ANGLE.....	209
<b>UHF Male To:</b>	
BNC MALE.....	212
UHF MALE.....	213
<b>UMCX 2.1 Plug To:</b>	
UMCX 2.1 PLUG.....	213
<b>UMCX 2.5 Plug To:</b>	
UMCX 2.5 PLUG.....	213
<b>UMCX Plug Right Angle To:</b>	
MCX JACK BULKHEAD.....	213
MCX PLUG.....	213
MCX PLUG RIGHT ANGLE.....	213
MMCX PLUG RIGHT ANGLE.....	213
REVERSE POLARITY MCX JACK BULKHEAD.....	213
SSMB PLUG.....	213
Straight Cut Lead Sexless.....	216
<b>WMCX 1.6 Plug To:</b>	
WMCX 1.6 PLUG.....	214

## HIGH-RELIABILITY RF CABLE ASSEMBLIES

### Product Features

- Max. Frequency as High as 18 GHz
- Double and Triple Shielded Versions
- Lot Traceability
- J-STD-Soldering
- High-Reliability Cable and Connectors
- RF Test Plots
- Detailed Test Report
- In-Stock and Shipped Same Day

### Applications

- Hi-Rel
- MIL-DTL-17 Requirements
- Avionics
- IFF
- SATCOM
- ECM



MIL-DTL-17 Cable Assembly Series



Temperature Conditioned, Low Loss Cable Assembly Series

Pasternack's MIL-DTL-17 Cable Assemblies and Temperature-Conditioned, Low-Loss Cable Assemblies are part of a full line of high-reliability RF components that are in-stock and available for shipment same day. These Commercial-Off-The-Shelf (COTS) assemblies offer a combination of superior materials, processes, and acceptance testing designed to ensure rugged, highly reliable performance for your mission critical applications.

Each assembly is manufactured using J-STD soldering processes and WHMA-A-620 workmanship and is also traceable to its component lots for every material used (RF connectors, coax cable, heat shrink, and solder). There is 100% test sampling of assemblies for connector gaging, insertion loss, VSWR, DWV, workmanship, configuration, and marking, with sampled (AQL) inspections performed for length and mass. A detailed test report accompanies each assembled lot.

Whether the need is to provide a high-reliability MIL-SPEC connection or a rugged, dependable cable assembly, Pasternack has the right assembly for the job. Visit us online at [www.pasternack.com](http://www.pasternack.com) to configure and customize your order, or sign up for our mailing list to receive the latest news and product information.

Cable Assemblies

MIL-DTL-17 BNC CABLE ASSEMBLY SERIES						
Model No	Cable Type	Velocity of Propagation (%)	Connector 1	Connector 2	Frequency Max. (GHz)	ROW
<b>M17/28-RG058</b>						
<a href="#">PE3M0115</a>	M17/28-RG058	65.9	BNC, Male	BNC, Male	1	1
<a href="#">PE3M0116</a>				SMA, Male		2
<a href="#">PE3M0117</a>				SMA, Male, RA		3
<a href="#">PE3M0118</a>				TNC, Male		4
<b>M17/60-RG142</b>						
<a href="#">PE3M0001</a>	M17/60-RG142	69.5	BNC, Male	BNC, Male	4	5
<a href="#">PE3M0002</a>				N, Male		6
<a href="#">PE3M0003</a>				N, Female		7
<a href="#">PE3M0004</a>				SMA, Male		8
<a href="#">PE3M0005</a>				SMA, Male, RA		9
<a href="#">PE3M0006</a>				SMA, Male, RA		10
<a href="#">PE3M0007</a>				TNC, Male		11
<b>M17/84-RG223</b>						
<a href="#">PE3M0029</a>	M17/84-RG223	65.9	BNC, Male	BNC, Male	4	12
<a href="#">PE3M0030</a>				N, Male		13
<a href="#">PE3M0031</a>				N, Female		14
<a href="#">PE3M0032</a>				SMA, Male		15
<a href="#">PE3M0033</a>				SMA, Male, RA		16
<a href="#">PE3M0034</a>				TNC, Male		17
<a href="#">PE3M0035</a>	TNC, Male	18				
<b>M17/113-RG316</b>						
<a href="#">PE3M0085</a>	M17/113-RG316	69.5	BNC, Male	BNC, Male	3	19
<a href="#">PE3M0086</a>				SMA, Male		20
<a href="#">PE3M0087</a>				SMA, Male, RA		21
<a href="#">PE3M0088</a>				SMA, Female		22
<a href="#">PE3M0089</a>				TNC, Male		23
<b>M17/119-RG174</b>						
<a href="#">PE3M0100</a>	M17/119-RG174	65.9	BNC, Male	BNC, Male	1	24
<a href="#">PE3M0101</a>				SMA, Male		25
<a href="#">PE3M0102</a>				SMA, Male, RA		26
<a href="#">PE3M0103</a>				SMA, Female		27
<a href="#">PE3M0104</a>				TNC, Male		28
<b>M17/128-RG400</b>						
<a href="#">PE3M0057</a>	M17/128-RG400	69.5	BNC, Male	BNC, Male	4	29
<a href="#">PE3M0058</a>				N, Male		30
<a href="#">PE3M0059</a>				N, Female		31
<a href="#">PE3M0060</a>				SMA, Male		32
<a href="#">PE3M0061</a>				SMA, Male, RA		33
<a href="#">PE3M0062</a>				SMA, Male, RA		34
<a href="#">PE3M0063</a>				TNC, Male		35

MIL-DTL-17 N TYPE CABLE ASSEMBLY SERIES						
Model No	Cable Type	Velocity of Propagation (%)	Connector 1	Connector 2	Frequency Max. (GHz)	ROW
<b>M17/60-RG142</b>						
<a href="#">PE3M0008</a>	M17/60-RG142	69.5	N, Male	N, Male	11	36
<a href="#">PE3M0009</a>				N, Female		37
<a href="#">PE3M0010</a>				SMA, Male		38
<a href="#">PE3M0014</a>				SMA, Male, RA		39
<a href="#">PE3M0015</a>				TNC, Male		40
<a href="#">PE3M0016</a>				TNC, Male		41
<a href="#">PE3M0011</a>				N, Female		42
<a href="#">PE3M0012</a>				N, Female		43
<a href="#">PE3M0013</a>				SMA, Male		44
<a href="#">PE3M0017</a>				SMA, Male		45
<a href="#">PE3M0020</a>				SMA, Male, RA		46
<a href="#">PE3M0018</a>	SMA, Male, RA	47				
<a href="#">PE3M0021</a>	TNC, Male	48				
<a href="#">PE3M0019</a>	TNC, Male	49				
<a href="#">PE3M0022</a>	TNC, Male	50				
<b>M17/84-RG223</b>						
<a href="#">PE3M0036</a>	M17/84-RG223	65.9	N, Male	N, Male	11	51
<a href="#">PE3M0037</a>				N, Female		52
<a href="#">PE3M0038</a>				SMA, Male		53
<a href="#">PE3M0042</a>				SMA, Male, RA		54
<a href="#">PE3M0043</a>				TNC, Male		55
<a href="#">PE3M0044</a>				TNC, Male		56
<a href="#">PE3M0039</a>				N, Female		57
<a href="#">PE3M0040</a>				N, Female		58
<a href="#">PE3M0041</a>				SMA, Male		59
<a href="#">PE3M0045</a>				SMA, Male		60
<a href="#">PE3M0048</a>	SMA, Male, RA	61				
<a href="#">PE3M0046</a>	SMA, Male, RA	62				
<a href="#">PE3M0049</a>	TNC, Male	63				
<a href="#">PE3M0047</a>	TNC, Male	64				
<a href="#">PE3M0050</a>	TNC, Male	65				
<b>M17/128-RG400</b>						
<a href="#">PE3M0064</a>	M17/128-RG400	69.5	N, Male	N, Male	11	66
<a href="#">PE3M0065</a>				N, Female		67
<a href="#">PE3M0066</a>				SMA, Male		68
<a href="#">PE3M0070</a>				SMA, Male, RA		69
<a href="#">PE3M0071</a>				SMA, Male, RA		70
<a href="#">PE3M0072</a>				TNC, Male		71
<a href="#">PE3M0067</a>				N, Female		72
<a href="#">PE3M0068</a>				N, Female		73

See Our Website For Current Pricing & Real-Time Stock Availability!

For Custom Lengths, Metric Lengths or Special Configurations, Please call (949) 261-1920



Technical Support  
+1 (949) 261-1920



Same-Day Shipping,  
Even Custom  
Cable Assemblies



For our complete selection of cable assemblies, please visit our website

**MIL-DTL-17 N TYPE CABLE ASSEMBLY SERIES**

Model No	Cable Type	Velocity of Propagation (%)	Connector 1	Connector 2	Frequency Max. (GHz)	R O W
<b>M17/128-RG400</b>						
PE3M0069	M17/128-RG400	69.5	N, Female	N, Female	11	74
PE3M0073				SMA, Male		75
PE3M0076				SMA, Male, RA		76
PE3M0074						77
PE3M0077						78
PE3M0075				TNC, Male		79
PE3M0078						80

**MIL-DTL-17 SMA CABLE ASSEMBLY SERIES**

Model No	Cable Type	Velocity of Propagation (%)	Connector 1	Connector 2	Frequency Max. (GHz)	R O W				
<b>M17/28-RG058</b>										
PE3M0119	M17/28-RG058	65.9	SMA, Male	SMA, Male	1	81				
PE3M0120				SMA, Male, RA		82				
PE3M0121				TNC, Male		83				
PE3M0122				SMA, Male, RA		SMA, Male, RA	84			
PE3M0123						TNC, Male	85			
<b>M17/60-RG142</b>										
PE3M0023	M17/60-RG142	69.5	SMA, Male	SMA, Male	12.4	86				
PE3M0024				SMA, Male, RA		87				
PE3M0026				TNC, Male		88				
PE3M0025				SMA, Male, RA		SMA, Male, RA	89			
PE3M0027						TNC, Male	90			
<b>M17/84-RG223</b>										
PE3M0051	M17/84-RG223	65.9	SMA, Male	SMA, Male	12.4	91				
PE3M0052				SMA, Male, RA		92				
PE3M0054				TNC, Male		93				
PE3M0053				SMA, Male, RA		SMA, Male, RA	94			
PE3M0055						TNC, Male	95			
<b>M17/113-RG316</b>										
PE3M0090	M17/113-RG316	69.5	SMA, Male	SMA, Male	3	96				
PE3M0091				SMA, Male, RA		97				
PE3M0092				SMA, Female		98				
PE3M0096				TNC, Male		99				
PE3M0093				SMA, Male, RA		SMA, Male, RA	1			
PE3M0094						SMA, Female	2			
PE3M0097						TNC, Male	3			
PE3M0095				SMA, Female		SMA, Female	4			
PE3M0098						TNC, Male	5			
<b>M17/119-RG174</b>										
PE3M0105	M17/119-RG174	65.9	SMA, Male	SMA, Male	1	6				
PE3M0106				SMA, Male, RA		7				
PE3M0107				SMA, Female		8				
PE3M0111				TNC, Male		9				
PE3M0108				SMA, Male, RA		SMA, Male, RA	10			
PE3M0109						SMA, Female	11			
PE3M0112						TNC, Male	12			
PE3M0110				SMA, Female		SMA, Female	13			
PE3M0113						TNC, Male	14			
<b>M17/128-RG400</b>										
PE3M0079				M17/128-RG400		69.5	SMA, Male	SMA, Male	12.4	15
PE3M0080								SMA, Male, RA		16
PE3M0082								TNC, Male		17
PE3M0081								SMA, Male, RA		SMA, Male, RA
PE3M0083	TNC, Male	19								

**MIL-DTL-17 TNC CABLE ASSEMBLY SERIES**

Model No	Cable Type	Velocity of Propagation (%)	Connector 1	Connector 2	Frequency Max. (GHz)	R O W
<b>M17/28-RG058</b>						
PE3M0124	M17/28-RG058	65.9	TNC, Male	TNC, Male	1	20
<b>M17/60-RG142</b>						
PE3M0028	M17/60-RG142	69.5	TNC, Male	TNC, Male	11	21
<b>M17/84-RG223</b>						
PE3M0056	M17/84-RG223	65.9	TNC, Male	TNC, Male	11	22
<b>M17/113-RG316</b>						
PE3M0099	M17/113-RG316	69.5	TNC, Male	TNC, Male	3	23

Model No	Cable Type	Velocity of Propagation (%)	Connector 1	Connector 2	Frequency Max. (GHz)	R O W
<b>M17/119-RG174</b>						
PE3M0114	M17/119-RG174	65.9	TNC, Male	TNC, Male	1	24
<b>M17/128-RG400</b>						
PE3M0084	M17/128-RG400	69.5	TNC, Male	TNC, Male	11	25

**TEMPERATURE CONDITIONED, LOW LOSS N TYPE CABLE ASSEMBLY SERIES**

Model No	Cable Type	Velocity of Propagation (%)	Connector 1	Connector 2	Frequency Max. (GHz)	R O W
<b>PE-P142LL</b>						
PE3M0174	PE-P142LL	80	N, Male	N, Male	18	26
PE3M0176				N, Male, RA		27
PE3M0175				N, Female		28
PE3M0179				N, Male, RA		29
PE3M0178				N, Male, RA		30
PE3M0177				N, Female		31
<b>PE-P160LL</b>						
PE3M0219	PE-P160LL	82.5	N, Male	N, Male	18	32
PE3M0221				N, Male, RA		33
PE3M0220				N, Female		34
PE3M0224				N, Male, RA		35
PE3M0223				N, Male, RA		36
PE3M0222				N, Female		37
<b>PE-P300LL</b>						
PE3M0247	PE-P300LL	83	N, Male	N, Male	18	38
PE3M0249				N, Male, RA		39
PE3M0248				N, Female		40
PE3M0252				N, Male, RA		41
PE3M0251				N, Male, RA		42
PE3M0250				N, Female		43

**TEMPERATURE CONDITIONED, LOW LOSS SMA CABLE ASSEMBLY SERIES**

Model No	Cable Type	Velocity of Propagation (%)	Connector 1	Connector 2	Frequency Max. (GHz)	R O W				
<b>PE-P142LL</b>										
PE3M0132	PE-P142LL	80	SMA, Male	N, Male	18	44				
PE3M0134				N, Male, RA		45				
PE3M0133				N, Female		46				
PE3M0125				SMA, Male		47				
PE3M0128				SMA, Male, RA		48				
PE3M0126				SMA, Female		49				
PE3M0127				SMA, Female		50				
PE3M0129				TNC, Male		51				
PE3M0131				TNC, Male, RA		52				
PE3M0130				TNC, Female		53				
PE3M0156				N, Male		54				
PE3M0158				N, Male, RA		55				
PE3M0157				N, Female		56				
PE3M0152				SMA, Male, RA		SMA, Male, RA	57			
PE3M0153						TNC, Male	58			
PE3M0155						TNC, Male, RA	59			
PE3M0154				TNC, Female		TNC, Female	60			
PE3M0141						61				
PE3M0149				N, Male		62				
PE3M0143				N, Male, RA		63				
PE3M0151				SMA, Female		N, Female	64			
PE3M0142						65				
PE3M0150						66				
PE3M0137						SMA, Male, RA	67			
PE3M0145						68				
PE3M0135						SMA, Female	69			
PE3M0136						SMA, Female	70			
PE3M0144						71				
PE3M0138						TNC, Male	72			
PE3M0146						TNC, Male, RA	73			
PE3M0140				TNC, Male, RA		74				
PE3M0148				TNC, Female		TNC, Female	75			
PE3M0139						76				
PE3M0147						77				
<b>PE-P160LL</b>										
PE3M0186				PE-P160LL		82.5	SMA, Male	N, Male	18	78
PE3M0188								N, Male, RA		79
PE3M0187								N, Female		80

Cable Assemblies

See Our Website For Current Pricing & Real-Time Stock Availability!

\*Coax Performance at 1 GHz Notes: Cable assembly max frequency may be lower than connector or coax max frequency

For our complete selection of cable assemblies, please visit our website

Model No	Cable Type	Velocity of Propagation (%)	Connector 1	Connector 2	Frequency Max. (GHz)	R O W
<b>PE-P160LL</b>						
PE3M0180	PE-P160LL	82.5	SMA, Male	SMA, Male	18	81
PE3M0182				SMA, Male, RA		82
PE3M0181				SMA, Female		83
PE3M0183				TNC, Male		84
PE3M0185				TNC, Male, RA		85
PE3M0184				TNC, Female		86
PE3M0201				N, Male		87
PE3M0203				N, Male, RA		88
PE3M0202				N, Female		89
PE3M0197				SMA, Male, RA		90
PE3M0198			TNC, Male	91		
PE3M0200			TNC, Male, RA	92		
PE3M0199			TNC, Female	93		
PE3M0194			N, Male	94		
PE3M0196			N, Male, RA	95		
PE3M0195			N, Female	96		
PE3M0190			SMA, Male, RA	97		
PE3M0189			SMA, Female	98		
PE3M0191			TNC, Male	99		
PE3M0193			TNC, Male, RA	1		
PE3M0192	TNC, Female	2				
<b>PE-P300LL</b>						
PE3M0229	PE-P300LL	83	SMA, Male	N, Male	18	3
PE3M0231				N, Male, RA		4
PE3M0230				N, Female		5
PE3M0225				SMA, Male		6
PE3M0226				SMA, Male, RA		7
PE3M0227				TNC, Male		8
PE3M0228				TNC, Male, RA		9
PE3M0235				N, Male		10
PE3M0237			N, Male, RA	11		
PE3M0236			N, Female	12		
PE3M0232			SMA, Male, RA	13		
PE3M0233			TNC, Male	14		
PE3M0234			TNC, Male, RA	15		

**TEMPERATURE CONDITIONED,  
LOW LOSS TNC CABLE ASSEMBLY SERIES**

Model No	Cable Type	Velocity of Propagation (%)	Connector 1	Connector 2	Frequency Max. (GHz)	R O W
<b>PE-P142LL</b>						
PE3M0162	PE-P142LL	80	TNC, Male	N, Male	18	16

Model No	Cable Type	Velocity of Propagation (%)	Connector 1	Connector 2	Frequency Max. (GHz)	R O W
<b>PE-P142LL</b>						
PE3M0164	PE-P142LL	80	TNC, Male	N, Male, RA	18	17
PE3M0163				N, Female		18
PE3M0159				TNC, Male		19
PE3M0161				TNC, Male, RA		20
PE3M0160				TNC, Female		21
PE3M0171				N, Male		22
PE3M0173			N, Male, RA	23		
PE3M0172			N, Female	24		
PE3M0170			TNC, Male, RA	25		
PE3M0167			N, Male	26		
PE3M0169			N, Male, RA	27		
PE3M0168			N, Female	28		
PE3M0166			TNC, Male, RA	29		
PE3M0165			TNC, Female	30		
<b>PE-P160LL</b>						
PE3M0207	PE-P160LL	82.5	TNC, Male	N, Male	18	31
PE3M0209				N, Male, RA		32
PE3M0208				N, Female		33
PE3M0204				TNC, Male		34
PE3M0206				TNC, Male, RA		35
PE3M0205				TNC, Female		36
PE3M0216				N, Male		37
PE3M0218				N, Male, RA		38
PE3M0217			N, Female	39		
PE3M0215			TNC, Male, RA	40		
PE3M0212			N, Male	41		
PE3M0214			N, Male, RA	42		
PE3M0213			N, Female	43		
PE3M0211			TNC, Male, RA	44		
PE3M0210			TNC, Female	45		
<b>PE-P300LL</b>						
PE3M0240	PE-P300LL	83	TNC, Male	N, Male	18	46
PE3M0242				N, Male, RA		47
PE3M0241				N, Female		48
PE3M0238				TNC, Male		49
PE3M0239				TNC, Male, RA		50
PE3M0244			N, Male	51		
PE3M0246			N, Male, RA	52		
PE3M0245			N, Female	53		
PE3M0243			TNC, Male, RA	54		

Cable Assemblies

See Our Website For Current Pricing & Real-Time Stock Availability!

**LOW PIM CABLE ASSEMBLIES**

**Product Features**

- 100% PIM Tested, Results Marked on Cable
- Max Frequency 6 GHz
- Low PIM: < -160 dBc Max
- 76% Phase Velocity
- FEP Jacket
- UL910 Plenum-Rated Cable
- Lightweight and Extremely Flexible
- Low Loss with Excellent VSWR

- IP67 (when mated)
- Shielding Effectivity > 100 dB
- Connector Options: 4.3-10, SMA, QMA, 7/16 DIN, 4.1/9.5, Type-N

**Applications**

- Low PIM Applications
- Distributed Antenna Systems (DAS)
- Plenum Installations
- Multi-Carrier Communication Systems
- PIM Testing



Low PIM Cable Assemblies

Pasternack's Low PIM Cable Assemblies offer a wide range of connector options: 4.3-10, SMA, QMA, 7/16 DIN, 4.1/9.5, and Type-N. These assemblies deliver low PIM performance to support Distributed Antenna Systems (DAS) and other complex, multi-carrier cable installations. All low PIM assemblies are 100% PIM tested with test results marked on the cable.

Whether the need is to provide a low PIM jumper connection, low PIM test cable, or simply create a custom assembly, Pasternack has the right cable for the job. Low PIM assemblies are part of Pasternack's full line of RF components that are available for same-day shipping. We are continually adding new cables and connectors to the low PIM family. So please visit us online at [www.pasternack.com](http://www.pasternack.com) to see the newest additions, or sign up for our mailing list to receive the latest news and product information.

For Custom Lengths, Metric Lengths or Special Configurations, Please call (949) 261-1920



Technical Support  
+1 (949) 261-1920



Same-Day Shipping,  
Even Custom Cable Assemblies

For our complete selection of cable assemblies, please visit our website

**4.1/9.5 MINI DIN LOW PIM PLENUM RATED CABLE ASSEMBLY SERIES**

Model No	Cable Type	Velocity of Propagation (%)	Connector 1	Connector 2	Freq. Max. (GHz)	PIM (dBc)	R O W
<b>SPP-250-LLPL</b>							
<a href="#">PE3C4143</a>	SPP-250-LLPL	76	4.1/9.5 Mini DIN, Male	4.1/9.5 Mini DIN, Male	5.8	-160	1
<a href="#">PE3C5847</a>				4.1/9.5 Mini DIN, Male, RA			2
<a href="#">PE3C5841</a>				4.1/9.5 Mini DIN, Female			3
<a href="#">PE3C5834</a>				4.3-10, Female			4
<a href="#">PE3C4134</a>				7/16 DIN, Male			5
<a href="#">PE3C5854</a>				7/16 DIN, Female			6
<a href="#">PE3W07481</a>				N, Female			7
<a href="#">PE3C5866</a>				QMA, Male			8
<a href="#">PE3C5872</a>				QMA, Male, RA			9
<a href="#">PE3C5860</a>				QMA, Female			10
<a href="#">PE3C5885</a>				SMA, Male			11
<a href="#">PE3C5890</a>				SMA, Male, RA			12
<a href="#">PE3C5879</a>				SMA, Female			13
<a href="#">PE3C5852</a>				4.1/9.5 Mini DIN, Male, RA			14
<a href="#">PE3C5846</a>				4.3-10, Male			15
<a href="#">PE3C5950</a>				4.3-10, Female			16
<a href="#">PE3C5848</a>				7/16 DIN, Male			17
<a href="#">PE3C5849</a>				N, Male			18
<a href="#">PE3C5850</a>				QMA, Male			19
<a href="#">PE3C5851</a>				SMA, Male			20
<a href="#">PE3C5840</a>				4.3-10, Male			21
<a href="#">PE3C5842</a>				7/16 DIN, Male			22
<a href="#">PE3C5843</a>				N, Male			23
<a href="#">PE3C5844</a>				QMA, Male			24
<a href="#">PE3C5845</a>				SMA, Male			25
<b>PE-SR402FLJ Low PIM</b>							
<a href="#">PE3C2009</a>	PE-SR402FLJ Low PIM	70	4.1/9.5 Mini DIN, Male	4.1/9.5 Mini DIN, Male	3	-160	26
<a href="#">PE3C2010</a>				4.1/9.5 Mini DIN, Female			27

**4.3/10 DIN LOW PIM PLENUM RATED CABLE ASSEMBLY SERIES**

Model No	Cable Type	Velocity of Propagation (%)	Connector 1	Connector 2	Freq. Max. (GHz)	PIM (dBc)	R O W
<b>SPP-250-LLPL</b>							
<a href="#">PE3C4142</a>	SPP-250-LLPL	76	4.3-10, Male	4.3-10, Male	5.8	-160	28
<a href="#">PE3C5833</a>				4.3-10, Female			29
<a href="#">PE3C4135</a>				7/16 DIN, Male			30
<a href="#">PE3C5853</a>				7/16 DIN, Female			31
<a href="#">PE3C5865</a>				QMA, Male			32
<a href="#">PE3C5871</a>				QMA, Male, RA			33
<a href="#">PE3C5859</a>				QMA, Female			34
<a href="#">PE3C5884</a>				SMA, Male			35
<a href="#">PE3C5889</a>				SMA, Male, RA			36
<a href="#">PE3C5878</a>				SMA, Female			37
<a href="#">PE3C4147</a>				4.3-10, Male, RA			38
<a href="#">PE3C4146</a>				4.3-10, Male, RA			39
<a href="#">PE3C5836</a>				7/16 DIN, Male			40
<a href="#">PE3C5837</a>				N, Male			41
<a href="#">PE3C5838</a>				QMA, Male			42
<a href="#">PE3C5839</a>				SMA, Male			43

**7/16 DIN LOW PIM PLENUM RATED CABLE ASSEMBLY SERIES**

Model No	Cable Type	Velocity of Propagation (%)	Connector 1	Connector 2	Freq. Max. (GHz)	PIM (dBc)	R O W			
<b>SPP-250-LLPL</b>										
<a href="#">PE3C4130</a>	SPP-250-LLPL	76	7/16 DIN, Male	7/16 DIN, Male	5.8	-160	44			
<a href="#">PE3C5855</a>				7/16 DIN, Female			45			
<a href="#">PE3C5867</a>				QMA, Male			46			
<a href="#">PE3C5873</a>				QMA, Male, RA			47			
<a href="#">PE3C5861</a>				QMA, Female			48			
<a href="#">PE3C5886</a>				SMA, Male			49			
<a href="#">PE3C5891</a>				SMA, Male, RA			50			
<a href="#">PE3C5880</a>				SMA, Female			51			
<a href="#">PE3C4131</a>				7/16 DIN, Male, RA			7/16 DIN, Male	6	-160	52

Model No	Cable Type	Velocity of Propagation (%)	Connector 1	Connector 2	Freq. Max. (GHz)	PIM (dBc)	R O W
<b>SPP-250-LLPL</b>							
<a href="#">PE3C4144</a>	SPP-250-LLPL	76	7/16 DIN, Male, RA	7/16 DIN, Male, RA	5.8	-160	53
<a href="#">PE3C5856</a>				N, Male			54
<a href="#">PE3C5857</a>				QMA, Male			55
<a href="#">PE3C5858</a>				SMA, Male			56
<b>PE-SR402FLJ Low PIM</b>							
<a href="#">PE3C2003</a>	PE-SR402FLJ Low PIM	70	7/16 DIN, Male	7/16 DIN, Male	3	-160	57
<a href="#">PE3C2004</a>				7/16 DIN, Female			58
<b>PE-SR401FLJ Low PIM</b>							
<a href="#">PE3C2013</a>	PE-SR401FLJ Low PIM	70	7/16 DIN, Male	7/16 DIN, Male	3	-160	59
<a href="#">PE3C2015</a>				7/16 DIN, Female			60

**QMA LOW PIM PLENUM RATED CABLE ASSEMBLY SERIES**

Model No	Cable Type	Velocity of Propagation (%)	Connector 1	Connector 2	Freq. Max. (GHz)	PIM (dBc)	R O W		
<b>SPP-250-LLPL</b>									
<a href="#">PE3C5869</a>	SPP-250-LLPL	76	QMA, Male	QMA, Male	5.8	-150	61		
<a href="#">PE3C5875</a>				QMA, Male, RA			62		
<a href="#">PE3C5863</a>				QMA, Female			63		
<a href="#">PE3C5870</a>				SMA, Male			64		
<a href="#">PE3C5893</a>				SMA, Male, RA			65		
<a href="#">PE3C5882</a>				SMA, Female			66		
<a href="#">PE3C5877</a>				QMA, Male, RA			67		
<a href="#">PE3C5876</a>				QMA, Male, RA			68		
<a href="#">PE3C5864</a>				QMA, Female			SMA, Male	-150	69

**SMA LOW PIM PLENUM RATED CABLE ASSEMBLY SERIES**

Model No	Cable Type	Velocity of Propagation (%)	Connector 1	Connector 2	Freq. Max. (GHz)	PIM (dBc)	R O W
<b>SPP-250-LLPL</b>							
<a href="#">PE3C5888</a>	SPP-250-LLPL	76	SMA, Male	SMA, Male	5.8	-155	70
<a href="#">PE3C5894</a>				SMA, Male, RA			71
<a href="#">PE3C5883</a>				SMA, Female			72
<a href="#">PE3C5895</a>				SMA, Male, RA			73
<b>PE-SR402FLJ Low PIM</b>							
<a href="#">PE3C2007</a>	PE-SR402FLJ Low PIM	70	SMA, Male	7/16 DIN, Male	3	-150	74
<a href="#">PE3C2008</a>				SMA, Male			75

**TYPE N LOW PIM PLENUM RATED CABLE ASSEMBLY SERIES**

Model No	Cable Type	Velocity of Propagation (%)	Connector 1	Connector 2	Freq. Max. (GHz)	PIM (dBc)	R O W					
<b>SPP-250-LLPL</b>												
<a href="#">PE3C4140</a>	SPP-250-LLPL	76	N, Male	4.1/9.5 Mini DIN, Male	5.8	-160	76					
<a href="#">PE3C4141</a>				4.3-10, Male			77					
<a href="#">PE3C4132</a>				7/16 DIN, Male			78					
<a href="#">PE3C4136</a>				7/16 DIN, Male, RA			79					
<a href="#">PE3C4137</a>				N, Male			80					
<a href="#">PE3C5868</a>				QMA, Male			-150	81				
<a href="#">PE3C5874</a>				QMA, Male, RA			-145	82				
<a href="#">PE3C5862</a>				QMA, Female			-150	83				
<a href="#">PE3C5887</a>				SMA, Male			-155	84				
<a href="#">PE3C5892</a>				SMA, Male, RA				85				
<a href="#">PE3C5881</a>				SMA, Female				86				
<a href="#">PE3C4139</a>				N, Male, RA			N, Male	6	87			
<a href="#">PE3C4145</a>							N, Male, RA	5.8	-160	88		
<a href="#">PE3C4133</a>							7/16 DIN, Male	6	89			
<a href="#">PE3C4138</a>				N, Female			N, Male	5.8	90			
<a href="#">PE3W07489</a>							N, Female	5.8	91			
<b>PE-SR402FLJ Low PIM</b>												
<a href="#">PE3C2002</a>				PE-SR402FLJ Low PIM			70	N, Male	7/16 DIN, Male	3	-160	92
<a href="#">PE3C2005</a>									7/16 DIN, Female			93
<a href="#">PE3C2000</a>									N, Male			94
<a href="#">PE3C2001</a>	N, Female	95										
<a href="#">PE3C2006</a>	SMA, Male	-150	96									
<b>PE-SR401FLJ Low PIM</b>												
<a href="#">PE3C2012</a>	PE-SR401FLJ Low PIM	70	N, Male	7/16 DIN, Male	3	-160	97					
<a href="#">PE3C2014</a>				7/16 DIN, Female			98					
<a href="#">PE3C2011</a>				N, Male			99					

Cable Assemblies

See Our Website For Current Pricing & Real-Time Stock Availability!

\*Coax Performance at 1 GHz Notes: Cable assembly max frequency may be lower than connector or coax max frequency

For our complete selection of cable assemblies, please visit our website

1.0/2.3 PLUG TO BNC FEMALE BULKHEAD						
SEE MOUNTING HOLE SECTION ON PAGE 409						
Flexible Cable Assemblies						
LMR-100A-PVC Coax, 50 Ohm						
Part No. <a href="#">PE3W05192</a>	Cable Dia.	Attn. @ 1 GHz	Power @ 1 GHz			
1 piece price shown. See web or call for volume pricing.						
12"	24"	36"	48"	60"	50CM	Custom Len.
\$41.75	\$42.57	\$43.38	\$44.17	\$44.98	\$42.28	See Web
1.0/2.3 PLUG RIGHT ANGLE TO BNC MALE						
Standard Flexible Cable Assemblies						
RG316/U Coax, 50 Ohm						
Part No. <a href="#">PE3C3469</a>	Cable Dia.	Attn. @ 1 GHz	Power @ 1 GHz			
1 piece price shown. See web or call for volume pricing.						
12"	24"	36"	48"	60"	50CM	Custom Len.
\$50.54	\$51.04	\$54.41	\$57.23	\$60.58	\$49.83	See Web
1.0/2.3 JACK BULKHEAD TO 1.0/2.3 JACK BULKHEAD						
SEE MOUNTING HOLE SECTION ON PAGE 409						
Standard Flexible Cable Assemblies						
RG316/U Coax, 50 Ohm						
Part No. <a href="#">PE3C0441</a>	Cable Dia.	Attn. @ 1 GHz	Power @ 1 GHz			
1 piece price shown. See web or call for volume pricing.						
12"	24"	36"	48"	60"	72"	Custom Len.
\$52.79	\$55.47	\$58.67	\$61.88	\$65.06	\$68.24	See Web
1.0MM MALE TO 1.0MM MALE						
Precision Flexible Cable Assemblies						
PE-110TC Coax, 50 Ohm						
Part No. <a href="#">PE3TC1220</a>	Cable Dia.	Attn. @ 1 GHz	Power @ 1 GHz			
1 piece price shown. See web or call for volume pricing.						
6"	12"	24"	100CM	-	-	Custom Len.
\$6,373.75	\$8,529.33	Call	Call	-	-	See Web
1.0MM MALE TO 1.0MM FEMALE						
Precision Flexible Cable Assemblies						
PE-110TC Coax, 50 Ohm						
Part No. <a href="#">PE3TC1221</a>	Cable Dia.	Attn. @ 1 GHz	Power @ 1 GHz			
1 piece price shown. See web or call for volume pricing.						
10CM	13CM	6"	12"	18"	-	Custom Len.
Call	Call	\$6,373.75	\$6,652.90	Call	-	See Web
1.85MM MALE TO 1.85MM MALE						
Low Loss Flexible Cable Assemblies						
PE-P106LL Coax, 50 Ohm						
Part No. <a href="#">PE3C5998</a>	Cable Dia.	Attn. @ 1 GHz	Power @ 1 GHz			
1 piece price shown. See web or call for volume pricing.						
6"	12"	24"	36"	50CM	100CM	Custom Len.
\$617.74	\$641.49	\$640.87	\$704.81	\$619.87	\$726.11	See Web
Low Loss Semi-Rigid Cable Assemblies						
PECX001 Coax, 50 Ohm						
Part No. <a href="#">PE3C6484</a>	Cable Dia.	Attn. @ 1 GHz	Power @ 1 GHz			
1 piece price shown. See web or call for volume pricing.						
6"	12"	18"	24"	36"	48"	Custom Len.
\$288.18	\$288.18	\$288.72	\$289.23	\$290.27	\$291.33	See Web
PECX002 Coax, 50 Ohm						
Part No. <a href="#">PE3C6487</a>	Cable Dia.	Attn. @ 1 GHz	Power @ 1 GHz			
1 piece price shown. See web or call for volume pricing.						
6"	12"	18"	24"	36"	48"	Custom Len.
\$292.39	\$292.39	\$293.10	\$293.80	\$295.20	\$296.60	See Web
PECX003 Coax, 50 Ohm						
Part No. <a href="#">PE3C6490</a>	Cable Dia.	Attn. @ 1 GHz	Power @ 1 GHz			
1 piece price shown. See web or call for volume pricing.						
6"	12"	18"	24"	36"	48"	Custom Len.
\$295.62	\$295.62	\$296.47	\$297.30	\$298.97	\$300.64	See Web
PECX004 Coax, 50 Ohm						
Part No. <a href="#">PE3C6491</a>	Cable Dia.	Attn. @ 1 GHz	Power @ 1 GHz			
1 piece price shown. See web or call for volume pricing.						
6"	12"	18"	24"	36"	48"	Custom Len.
\$298.13	\$298.13	\$299.08	\$300.03	\$301.90	\$303.79	See Web

Precision Flexible Cable Assemblies						
PE-VNA-HF Coax, 50 Ohm						
Part No. <a href="#">PE3TC0800</a>	Cable Dia.	Attn. @ 1 GHz	Power @ 1 GHz			
1 piece price shown. See web or call for volume pricing.						
30CM	60CM	24"	36"	48"	241"	Custom Len.
Call	Call	\$3,127.53	\$3,168.72	\$3,279.23	Call	See Web
Standard Formable Cable Assemblies						
PE-SR047FL Coax, 50 Ohm						
Part No. <a href="#">PE36521</a>	Cable Dia.	Attn. @ 1 GHz	Power @ 1 GHz			
1 piece price shown. See web or call for volume pricing.						
6"	12"	18"	24"	36"	48"	Custom Len.
\$410.49	\$410.49	\$414.49	\$418.49	\$426.48	\$434.46	See Web
PE-SR405FL Coax, 50 Ohm						
Part No. <a href="#">PE36525</a>	Cable Dia.	Attn. @ 1 GHz	Power @ 1 GHz			
1 piece price shown. See web or call for volume pricing.						
6"	12"	18"	24"	36"	48"	Custom Len.
\$364.34	\$364.34	\$370.16	\$375.96	\$387.55	\$399.15	See Web
Standard Flexible Cable Assemblies						
PE-P086 Coax, 50 Ohm						
Part No. <a href="#">PE3C0752</a>	Cable Dia.	Attn. @ 1 GHz	Power @ 1 GHz			
1 piece price shown. See web or call for volume pricing.						
12"	24"	36"	48"	60"	50CM	Custom Len.
\$244.42	\$253.03	\$261.64	\$270.74	\$254.32	\$234.38	See Web
PE-P103 Coax, 50 Ohm						
Part No. <a href="#">PE3C6638</a>	Cable Dia.	Attn. @ 1 GHz	Power @ 1 GHz			
1 piece price shown. See web or call for volume pricing.						
12"	24"	36"	48"	60"	50CM	Custom Len.
\$277.16	\$305.35	\$333.58	\$361.79	\$390.02	\$295.20	See Web
Standard Semi-Rigid Cable Assemblies						
PE-047SR Coax, 50 Ohm						
Part No. <a href="#">PE36519</a>	Cable Dia.	Attn. @ 1 GHz	Power @ 1 GHz			
1 piece price shown. See web or call for volume pricing.						
6"	12"	18"	24"	36"	48"	Custom Len.
\$432.66	\$413.66	\$419.20	\$450.48	\$435.86	\$446.96	See Web
RG405/U Coax, 50 Ohm						
Part No. <a href="#">PE36523</a>	Cable Dia.	Attn. @ 1 GHz	Power @ 1 GHz			
1 piece price shown. See web or call for volume pricing.						
6"	12"	18"	24"	36"	48"	Custom Len.
\$360.08	\$360.08	\$363.80	\$367.53	\$374.97	\$382.41	See Web
Skew Matched Pair Flexible Cable Assemblies						
PE-P106LL Coax, 50 Ohm						
Part No. <a href="#">PE3C5835</a>	Cable Dia.	Attn. @ 1 GHz	Power @ 1 GHz			
1 piece price shown. See web or call for volume pricing.						
12"	24"	36"	48"	-	-	Custom Len.
\$3,383.88	\$3,606.16	\$4,339.86	\$4,559.14	-	-	See Web
1.85MM MALE TO 1.85MM MALE RIGHT ANGLE						
Precision Flexible Cable Assemblies						
PE-VNA-HF Coax, 50 Ohm						
Part No. <a href="#">PE3TC1000</a>	Cable Dia.	Attn. @ 1 GHz	Power @ 1 GHz			
1 piece price shown. See web or call for volume pricing.						
24"	36"	48"	-	-	-	Custom Len.
\$3,637.51	Call	\$3,792.44	-	-	-	See Web
1.85MM MALE TO 1.85MM FEMALE						
Precision Flexible Cable Assemblies						
PE-VNA-HF Coax, 50 Ohm						
Part No. <a href="#">PE3TC0900</a>	Cable Dia.	Attn. @ 1 GHz	Power @ 1 GHz			
1 piece price shown. See web or call for volume pricing.						
24"	36"	48"	-	-	-	Custom Len.
\$3,127.53	\$3,168.72	\$3,279.23	-	-	-	See Web
1.85MM MALE TO 2.4MM MALE						
Standard Flexible Cable Assemblies						
PE-P103 Coax, 50 Ohm						
Part No. <a href="#">PE3C6639</a>	Cable Dia.	Attn. @ 1 GHz	Power @ 1 GHz			
1 piece price shown. See web or call for volume pricing.						
12"	24"	36"	48"	60"	50CM	Custom Len.
\$281.11	\$308.42	\$335.70	\$363.00	\$390.28	\$298.59	See Web
1.85MM MALE TO 2.92MM MALE						
Low Loss Semi-Rigid Cable Assemblies						

Cable Assemblies

See Our Website For Current Pricing & Real-Time Stock Availability!

Continued on Next Page

For Custom Lengths, Metric Lengths or Special Configurations, Please call (949) 261-1920



Technical Support  
+1 (949) 261-1920



Same-Day Shipping,  
Even Custom Cable Assemblies



For our complete selection of cable assemblies, please visit our website

Cable Assemblies

See Our Website For Current Pricing & Real-Time Stock Availability!

PEXC001 Coax, 50 Ohm						
Part No. <a href="#">PE3C6485</a>		Cable Dia.	Attn. @ 1 GHz	Power @ 1 GHz	22	
1 piece price shown. See web or call for volume pricing.						
6"	12"	18"	24"	36"	48"	Custom Len.
\$279.80	\$279.80	\$280.33	\$280.85	\$281.89	\$282.94	See Web
PEXC002 Coax, 50 Ohm						
Part No. <a href="#">PE3C6488</a>		Cable Dia.	Attn. @ 1 GHz	Power @ 1 GHz	23	
1 piece price shown. See web or call for volume pricing.						
6"	12"	18"	24"	36"	48"	Custom Len.
\$284.01	\$284.01	\$284.72	\$285.41	\$286.82	\$288.22	See Web
Standard Formable Cable Assemblies						
PE-SR405FLJ Coax, 50 Ohm						
Part No. <a href="#">PE3W07895</a>		Cable Dia.	Attn. @ 1 GHz	Power @ 1 GHz	24	
1 piece price shown. See web or call for volume pricing.						
12"	18"	36"	48"	60"	Custom Len.	
\$277.39	\$271.67	\$276.33	\$285.68	\$295.02	\$304.37	See Web
1.85MM FEMALE TO 1.85MM FEMALE						
Precision Flexible Cable Assemblies						
PE-VNA-HF Coax, 50 Ohm						
Part No. <a href="#">PE3TC0950</a>		Cable Dia.	Attn. @ 1 GHz	Power @ 1 GHz	25	
1 piece price shown. See web or call for volume pricing.						
24"	48"	-	-	-	-	Custom Len.
\$3,295.73	\$3,444.42	-	-	-	-	See Web
2.2-5 MALE TO 4.3-10 MALE						
Low PIM Corrugated Cable Assemblies						
PE-1/4SFHC Coax, 50 Ohm						
Part No. <a href="#">PE3C8050</a>		Cable Dia.	Attn. @ 1 GHz	Power @ 1 GHz	26	
1 piece price shown. See web or call for volume pricing.						
12"	24"	36"	48"	60"	50CM	Custom Len.
\$72.08	\$75.75	\$79.41	\$83.07	\$86.73	\$70.77	See Web
2.2-5 MALE TO 4.3-10 MALE RIGHT ANGLE						
Low PIM Corrugated Cable Assemblies						
PE-1/4SFHC Coax, 50 Ohm						
Part No. <a href="#">PE3C8051</a>		Cable Dia.	Attn. @ 1 GHz	Power @ 1 GHz	27	
1 piece price shown. See web or call for volume pricing.						
12"	24"	36"	48"	60"	50CM	Custom Len.
\$74.24	\$77.91	\$81.57	\$85.23	\$88.89	\$72.93	See Web
2.2-5 MALE TO 4.3-10 FEMALE						
Low PIM Corrugated Cable Assemblies						
PE-1/4SFHC Coax, 50 Ohm						
Part No. <a href="#">PE3C8052</a>		Cable Dia.	Attn. @ 1 GHz	Power @ 1 GHz	28	
1 piece price shown. See web or call for volume pricing.						
12"	24"	36"	48"	60"	50CM	Custom Len.
\$73.16	\$76.83	\$80.49	\$84.15	\$87.81	\$71.85	See Web
2.2-5 MALE TO 4.3-10 FEMALE BULKHEAD						
SEE MOUNTING HOLE SECTION ON PAGE 409						
Low PIM Corrugated Cable Assemblies						
PE-1/4SFHC Coax, 50 Ohm						
Part No. <a href="#">PE3C8053</a>		Cable Dia.	Attn. @ 1 GHz	Power @ 1 GHz	29	
1 piece price shown. See web or call for volume pricing.						
12"	24"	36"	48"	60"	50CM	Custom Len.
\$74.24	\$77.91	\$81.57	\$85.23	\$88.89	\$72.93	See Web
2.2-5 MALE TO 4.3-10 FEMALE 4 HOLE FLANGE						
SEE MOUNTING HOLE SECTION ON PAGE 409						
Low PIM Corrugated Cable Assemblies						
PE-1/4SFHC Coax, 50 Ohm						
Part No. <a href="#">PE3C8054</a>		Cable Dia.	Attn. @ 1 GHz	Power @ 1 GHz	30	
1 piece price shown. See web or call for volume pricing.						
12"	24"	36"	48"	60"	50CM	Custom Len.
\$75.32	\$78.99	\$82.65	\$86.31	\$89.97	\$74.01	See Web
2.2-5 MALE TO N MALE						
Low PIM Corrugated Cable Assemblies						

PE-1/4SFHC Coax, 50 Ohm						
Part No. <a href="#">PE3C8059</a>		Cable Dia.	Attn. @ 1 GHz	Power @ 1 GHz	31	
1 piece price shown. See web or call for volume pricing.						
12"	24"	36"	48"	60"	50CM	Custom Len.
\$66.68	\$70.35	\$74.01	\$77.67	\$81.33	\$65.37	See Web
2.2-5 MALE TO N MALE RIGHT ANGLE						
Low PIM Corrugated Cable Assemblies						
PE-1/4SFHC Coax, 50 Ohm						
Part No. <a href="#">PE3C8060</a>		Cable Dia.	Attn. @ 1 GHz	Power @ 1 GHz	32	
1 piece price shown. See web or call for volume pricing.						
12"	24"	36"	48"	60"	50CM	Custom Len.
\$69.38	\$73.05	\$76.71	\$80.37	\$84.03	\$68.07	See Web
2.2-5 MALE TO N FEMALE						
Low PIM Corrugated Cable Assemblies						
PE-1/4SFHC Coax, 50 Ohm						
Part No. <a href="#">PE3C8061</a>		Cable Dia.	Attn. @ 1 GHz	Power @ 1 GHz	33	
1 piece price shown. See web or call for volume pricing.						
12"	24"	36"	48"	60"	50CM	Custom Len.
\$66.68	\$70.35	\$74.01	\$77.67	\$81.33	\$65.37	See Web
2.2-5 MALE TO N FEMALE BULKHEAD						
SEE MOUNTING HOLE SECTION ON PAGE 409						
Low PIM Corrugated Cable Assemblies						
PE-1/4SFHC Coax, 50 Ohm						
Part No. <a href="#">PE3C8062</a>		Cable Dia.	Attn. @ 1 GHz	Power @ 1 GHz	34	
1 piece price shown. See web or call for volume pricing.						
12"	24"	36"	48"	60"	50CM	Custom Len.
\$66.68	\$70.35	\$74.01	\$77.67	\$81.33	\$65.37	See Web
2.2-5 MALE TO 2.2-5 MALE						
Low PIM Corrugated Cable Assemblies						
PE-1/4SFHC Coax, 50 Ohm						
Part No. <a href="#">PE3C7856</a>		Cable Dia.	Attn. @ 1 GHz	Power @ 1 GHz	35	
1 piece price shown. See web or call for volume pricing.						
12"	24"	36"	48"	60"	50CM	Custom Len.
\$69.11	\$72.84	\$76.57	\$80.29	\$84.02	\$71.50	See Web
2.2-5 MALE TO 2.2-5 MALE RIGHT ANGLE						
Low PIM Corrugated Cable Assemblies						
PE-1/4SFHC Coax, 50 Ohm						
Part No. <a href="#">PE3C7857</a>		Cable Dia.	Attn. @ 1 GHz	Power @ 1 GHz	36	
1 piece price shown. See web or call for volume pricing.						
12"	24"	36"	48"	60"	50CM	Custom Len.
\$75.70	\$79.44	\$83.16	\$86.89	\$90.62	\$78.09	See Web
2.2-5 MALE TO 2.2-5 FEMALE						
Low PIM Corrugated Cable Assemblies						
PE-1/4SFHC Coax, 50 Ohm						
Part No. <a href="#">PE3C7858</a>		Cable Dia.	Attn. @ 1 GHz	Power @ 1 GHz	37	
1 piece price shown. See web or call for volume pricing.						
12"	24"	36"	48"	60"	50CM	Custom Len.
\$69.11	\$72.84	\$76.57	\$80.29	\$84.02	\$71.50	See Web
2.2-5 MALE TO 2.2-5 FEMALE BULKHEAD						
SEE MOUNTING HOLE SECTION ON PAGE 409						
Low PIM Corrugated Cable Assemblies						
PE-1/4SFHC Coax, 50 Ohm						
Part No. <a href="#">PE3C7859</a>		Cable Dia.	Attn. @ 1 GHz	Power @ 1 GHz	38	
1 piece price shown. See web or call for volume pricing.						
12"	24"	36"	48"	60"	50CM	Custom Len.
\$71.86	\$75.58	\$79.31	\$83.04	\$86.77	\$74.24	See Web
2.2-5 MALE RIGHT ANGLE TO 2.2-5 MALE RIGHT ANGLE						
Low PIM Corrugated Cable Assemblies						

\*Coax Performance at 1 GHz Notes: Cable assembly max frequency may be lower than connector or coax max frequency

For our complete selection of cable assemblies, please visit our website

PE-1/4SFHC Coax, 50 Ohm						
Part No. <a href="#">PE3C7860</a>	Cable Dia.			Attn. @ 1 GHz	Power @ 1 GHz	39
1 piece price shown. See web or call for volume pricing.	0.303" dia.			5.85 dB/100ft		
12"	24"	36"	48"	60"	50CM	Custom Len.
\$82.30	\$86.03	\$89.75	\$93.49	\$97.22	\$84.69	See Web

**2.2-5 MALE RIGHT ANGLE TO 2.2-5 FEMALE**



**Low PIM Corrugated Cable Assemblies**

PE-1/4SFHC Coax, 50 Ohm						
Part No. <a href="#">PE3C7861</a>	Cable Dia.			Attn. @ 1 GHz	Power @ 1 GHz	40
1 piece price shown. See web or call for volume pricing.	0.303" dia.			5.85 dB/100ft		
12"	24"	36"	48"	60"	50CM	Custom Len.
\$75.70	\$79.44	\$83.16	\$86.89	\$90.62	\$78.09	See Web

**2.2-5 MALE RIGHT ANGLE TO 2.2-5 FEMALE BULKHEAD**

SEE MOUNTING HOLE SECTION ON PAGE 409



**Low PIM Corrugated Cable Assemblies**

PE-1/4SFHC Coax, 50 Ohm						
Part No. <a href="#">PE3C7862</a>	Cable Dia.			Attn. @ 1 GHz	Power @ 1 GHz	41
1 piece price shown. See web or call for volume pricing.	0.303" dia.			5.85 dB/100ft		
12"	24"	36"	48"	60"	50CM	Custom Len.
\$78.46	\$82.18	\$85.91	\$89.63	\$93.36	\$80.84	See Web

**2.2-5 FEMALE TO 4.3-10 MALE**



**Low PIM Corrugated Cable Assemblies**

PE-1/4SFHC Coax, 50 Ohm						
Part No. <a href="#">PE3C8055</a>	Cable Dia.			Attn. @ 1 GHz	Power @ 1 GHz	42
1 piece price shown. See web or call for volume pricing.	0.303" dia.			5.85 dB/100ft		
12"	24"	36"	48"	60"	50CM	Custom Len.
\$72.08	\$75.75	\$79.41	\$83.07	\$86.73	\$70.77	See Web

**2.2-5 FEMALE TO 4.3-10 MALE RIGHT ANGLE**



**Low PIM Corrugated Cable Assemblies**

PE-1/4SFHC Coax, 50 Ohm						
Part No. <a href="#">PE3C8056</a>	Cable Dia.			Attn. @ 1 GHz	Power @ 1 GHz	43
1 piece price shown. See web or call for volume pricing.	0.303" dia.			5.85 dB/100ft		
12"	24"	36"	48"	60"	50CM	Custom Len.
\$74.24	\$77.91	\$81.57	\$85.23	\$88.89	\$72.93	See Web

**2.2-5 FEMALE TO 4.3-10 FEMALE**



**Low PIM Corrugated Cable Assemblies**

PE-1/4SFHC Coax, 50 Ohm						
Part No. <a href="#">PE3C8057</a>	Cable Dia.			Attn. @ 1 GHz	Power @ 1 GHz	44
1 piece price shown. See web or call for volume pricing.	0.303" dia.			5.85 dB/100ft		
12"	24"	36"	48"	60"	50CM	Custom Len.
\$73.16	\$76.83	\$80.49	\$84.15	\$87.81	\$71.85	See Web

**2.2-5 FEMALE TO 4.3-10 FEMALE BULKHEAD**

SEE MOUNTING HOLE SECTION ON PAGE 409



**Low PIM Corrugated Cable Assemblies**

PE-1/4SFHC Coax, 50 Ohm						
Part No. <a href="#">PE3C8058</a>	Cable Dia.			Attn. @ 1 GHz	Power @ 1 GHz	45
1 piece price shown. See web or call for volume pricing.	0.303" dia.			5.85 dB/100ft		
12"	24"	36"	48"	60"	50CM	Custom Len.
\$74.24	\$77.91	\$81.57	\$85.23	\$88.89	\$72.93	See Web

**2.2-5 FEMALE TO N MALE**



**Low PIM Corrugated Cable Assemblies**

PE-1/4SFHC Coax, 50 Ohm						
Part No. <a href="#">PE3C8063</a>	Cable Dia.			Attn. @ 1 GHz	Power @ 1 GHz	46
1 piece price shown. See web or call for volume pricing.	0.303" dia.			5.85 dB/100ft		
12"	24"	36"	48"	60"	50CM	Custom Len.
\$66.68	\$70.35	\$74.01	\$77.67	\$81.33	\$65.37	See Web

**2.2-5 FEMALE TO N MALE RIGHT ANGLE**



**Low PIM Corrugated Cable Assemblies**

PE-1/4SFHC Coax, 50 Ohm						
Part No. <a href="#">PE3C8064</a>	Cable Dia.			Attn. @ 1 GHz	Power @ 1 GHz	47
1 piece price shown. See web or call for volume pricing.	0.303" dia.			5.85 dB/100ft		
12"	24"	36"	48"	60"	50CM	Custom Len.
\$69.38	\$73.05	\$76.71	\$80.37	\$84.03	\$68.07	See Web

**2.2-5 FEMALE TO N FEMALE**



**Low PIM Corrugated Cable Assemblies**

PE-1/4SFHC Coax, 50 Ohm						
Part No. <a href="#">PE3C8065</a>	Cable Dia.			Attn. @ 1 GHz	Power @ 1 GHz	48
1 piece price shown. See web or call for volume pricing.	0.303" dia.			5.85 dB/100ft		
12"	24"	36"	48"	60"	50CM	Custom Len.
\$66.68	\$70.35	\$74.01	\$77.67	\$81.33	\$65.37	See Web

**2.2-5 FEMALE TO N FEMALE BULKHEAD**

SEE MOUNTING HOLE SECTION ON PAGE 409



**Low PIM Corrugated Cable Assemblies**

PE-1/4SFHC Coax, 50 Ohm						
Part No. <a href="#">PE3C8066</a>	Cable Dia.			Attn. @ 1 GHz	Power @ 1 GHz	49
1 piece price shown. See web or call for volume pricing.	0.303" dia.			5.85 dB/100ft		
12"	24"	36"	48"	60"	50CM	Custom Len.
\$66.68	\$70.35	\$74.01	\$77.67	\$81.33	\$65.37	See Web

**2.4MM MALE TO 1.85MM MALE**



**Standard Formable Cable Assemblies**

PE-SR405FLJ Coax, 50 Ohm						
Part No. <a href="#">PE3W08014</a>	Cable Dia.			Attn. @ 1 GHz	Power @ 1 GHz	50
1 piece price shown. See web or call for volume pricing.	0.105" dia.			19.5 dB/100ft	121.5 W	
12"	18"	24"	36"	48"	60"	Custom Len.
\$285.72	\$279.68	\$284.36	\$293.70	\$303.05	\$312.39	See Web

**2.4MM MALE TO 2.4MM MALE**



**Flexible Flexible Cable Assemblies**

PE-P086HF Coax, 50 Ohm						
Part No. <a href="#">PE3C7803</a>	Cable Dia.			Attn. @ 1 GHz	Power @ 1 GHz	51
1 piece price shown. See web or call for volume pricing.	0.104" dia.			21.1 dB/100ft		
12"	18"	24"	36"	48"	60"	Custom Len.
Call	Call	Call	Call	Call	Call	See Web

**Precision Flexible Cable Assemblies**

PE-VNA-HF Coax, 50 Ohm						
Part No. <a href="#">PE3TC0500</a>	Cable Dia.			Attn. @ 1 GHz	Power @ 1 GHz	52
1 piece price shown. See web or call for volume pricing.	0.27" dia.					
24"	36"	48"	-	-	-	Custom Len.
\$3,024.23	Call	\$3,179.00	-	-	-	See Web

**Test Flexible Cable Assemblies**

PE-P160 Coax, 50 Ohm						
Part No. <a href="#">PE363</a>	Cable Dia.			Attn. @ 1 GHz	Power @ 1 GHz	53
1 piece price shown. See web or call for volume pricing.	0.16" dia.			12.62 dB/100ft		
12"	24"	36"	48"	60"	50CM	Custom Len.
Call	Call	\$367.89	\$395.96	Call	Call	See Web

**Standard Flexible Cable Assemblies**

PE-P086HF Coax, 50 Ohm						
Part No. <a href="#">PE3C5984</a>	Cable Dia.			Attn. @ 1 GHz	Power @ 1 GHz	54
1 piece price shown. See web or call for volume pricing.	0.104" dia.			21.1 dB/100ft		
12"	24"	36"	48"	60"	50CM	Custom Len.
\$219.66	\$227.87	\$236.08	\$244.29	\$252.51	\$216.71	See Web

**PE-P103 Coax, 50 Ohm**

Part No. <a href="#">PE3C6640</a>	Cable Dia.			Attn. @ 1 GHz	Power @ 1 GHz	55
1 piece price shown. See web or call for volume pricing.	0.103" dia.			29.48 dB/100ft		
12"	24"	36"	48"	60"	50CM	Custom Len.
\$292.03	\$320.14	\$331.72	\$359.84	\$406.68	\$293.53	See Web

**PE-VNA-R Coax, 50 Ohm**

Part No. <a href="#">PE3VNA4004</a>	Cable Dia.			Attn. @ 1 GHz	Power @ 1 GHz	56
1 piece price shown. See web or call for volume pricing.	0.43" dia.					
24"	48"	700CM	-	-	-	Custom Len.
\$2,138.38	\$2,358.66	Call	-	-	-	See Web

**2.4MM MALE TO 2.4MM MALE RIGHT ANGLE**



**Precision Flexible Cable Assemblies**

Continued on Next Page

Cable Assemblies

See Our Website For Current Pricing & Real-Time Stock Availability!

For Custom Lengths, Metric Lengths or Special Configurations, Please call (949) 261-1920



Technical Support  
+1 (949) 261-1920



Same-Day Shipping,  
Even Custom Cable Assemblies

For our complete selection of cable assemblies, please visit our website

Cable Assemblies

See Our Website For Current Pricing & Real-Time Stock Availability!

PE-VNA-HF Coax, 50 Ohm						
Part No. <a href="#">PE3TC0700</a>	Cable Dia.			Attn. @ 1 GHz	Power @ 1 GHz	
1 piece price shown. See web or call for volume pricing.						
24"	36"	48"	-	-	-	Custom Len.
\$3,537.13	Call	\$3,688.49	-	-	-	See Web

**2.4MM MALE TO 2.4MM FEMALE**



Flexible Cable Assemblies						
PE-P160 Coax, 50 Ohm						
Part No. <a href="#">PE364</a>	Cable Dia.			Attn. @ 1 GHz	Power @ 1 GHz	
1 piece price shown. See web or call for volume pricing.						
12"	24"	36"	48"	60"	50CM	Custom Len.
Call	Call	\$380.88	\$403.45	Call	Call	See Web

Precision Flexible Cable Assemblies						
PE-VNA-HF Coax, 50 Ohm						
Part No. <a href="#">PE3TC0600</a>	Cable Dia.			Attn. @ 1 GHz	Power @ 1 GHz	
1 piece price shown. See web or call for volume pricing.						
24"	36"	48"	120"	-	-	Custom Len.
\$3,024.23	Call	\$3,179.00	Call	-	-	See Web

Standard Flexible Cable Assemblies						
PE-VNA-R Coax, 50 Ohm						
Part No. <a href="#">PE3VNA4005</a>	Cable Dia.			Attn. @ 1 GHz	Power @ 1 GHz	
1 piece price shown. See web or call for volume pricing.						
24"	48"	-	-	-	-	Custom Len.
\$2,292.19	\$2,521.07	-	-	-	-	See Web

**2.4MM FEMALE TO 2.4MM FEMALE**



Precision Flexible Cable Assemblies						
PE-VNA-HF Coax, 50 Ohm						
Part No. <a href="#">PE3TC0650</a>	Cable Dia.			Attn. @ 1 GHz	Power @ 1 GHz	
1 piece price shown. See web or call for volume pricing.						
24"	48"	70CM	-	-	-	Custom Len.
\$3,193.51	\$3,345.30	Call	-	-	-	See Web

**2.4MM FEMALE BULKHEAD TO SMA MALE**



SEE MOUNTING HOLE SECTION ON PAGE 409

Standard Formable Cable Assemblies						
PE-SR405FL Coax, 50 Ohm						
Part No. <a href="#">PE3W03550</a>	Cable Dia.			Attn. @ 1 GHz	Power @ 1 GHz	
1 piece price shown. See web or call for volume pricing.						
12"	24"	36"	48"	60"	50CM	Custom Len.
\$189.20	\$201.87	\$214.53	\$227.19	\$239.84	\$197.31	See Web

**2.92MM MALE TO 1.85MM MALE**



Standard Flexible Cable Assemblies						
PE-P103 Coax, 50 Ohm						
Part No. <a href="#">PE3C6636</a>	Cable Dia.			Attn. @ 1 GHz	Power @ 1 GHz	
1 piece price shown. See web or call for volume pricing.						
12"	24"	36"	48"	60"	50CM	Custom Len.
\$253.53	\$280.82	\$308.12	\$335.41	\$362.71	\$270.99	See Web

**2.92MM MALE TO 2.4MM MALE**



Standard Flexible Cable Assemblies						
PE-P103 Coax, 50 Ohm						
Part No. <a href="#">PE3C6637</a>	Cable Dia.			Attn. @ 1 GHz	Power @ 1 GHz	
1 piece price shown. See web or call for volume pricing.						
12"	24"	36"	48"	60"	50CM	Custom Len.
\$231.05	\$258.33	\$285.64	\$312.92	\$340.22	\$248.51	See Web

**2.92MM MALE TO 2.92MM MALE**



Skew Matched Pair Flexible Cable Assemblies						
PE-125LLS Coax, 50 Ohm						
Part No. <a href="#">PE3C4680</a>	Cable Dia.			Attn. @ 1 GHz	Power @ 1 GHz	
1 piece price shown. See web or call for volume pricing.						
12"	24"	36"	48"	-	-	Custom Len.
\$1,173.34	\$1,300.04	Call	\$1,553.43	-	-	See Web

Flexible Cable Assemblies						
PE-P160 Coax, 50 Ohm						
Part No. <a href="#">PE360</a>	Cable Dia.			Attn. @ 1 GHz	Power @ 1 GHz	
1 piece price shown. See web or call for volume pricing.						
12"	24"	36"	48"	60"	72"	Custom Len.
\$248.20	\$271.61	\$295.04	\$318.47	\$341.89	\$362.97	See Web

Semi-Rigid Cable Assemblies						
RG405/U Coax, 50 Ohm						
Part No. <a href="#">PE3C0835</a>	Cable Dia.			Attn. @ 1 GHz	Power @ 1 GHz	
1 piece price shown. See web or call for volume pricing.						
6"	12"	18"	24"	36"	48"	Custom Len.
Call	Call	Call	Call	Call	Call	See Web

Low Loss Semi-Rigid Cable Assemblies						
PECX001 Coax, 50 Ohm						
Part No. <a href="#">PE3C6486</a>	Cable Dia.			Attn. @ 1 GHz	Power @ 1 GHz	
1 piece price shown. See web or call for volume pricing.						
6"	12"	18"	24"	36"	48"	Custom Len.
\$271.42	\$271.42	\$271.94	\$272.46	\$273.52	\$274.56	See Web

PECX002 Coax, 50 Ohm						
Part No. <a href="#">PE3C6489</a>	Cable Dia.			Attn. @ 1 GHz	Power @ 1 GHz	
1 piece price shown. See web or call for volume pricing.						
6"	12"	18"	24"	36"	48"	Custom Len.
\$275.63	\$275.63	\$276.34	\$277.03	\$278.44	\$279.83	See Web

PECX005 Coax, 50 Ohm						
Part No. <a href="#">PE3C6492</a>	Cable Dia.			Attn. @ 1 GHz	Power @ 1 GHz	
1 piece price shown. See web or call for volume pricing.						
6"	12"	18"	24"	36"	48"	Custom Len.
\$268.01	\$268.01	\$268.40	\$268.79	\$269.55	\$270.31	See Web

PECX006 Coax, 50 Ohm						
Part No. <a href="#">PE3C6493</a>	Cable Dia.			Attn. @ 1 GHz	Power @ 1 GHz	
1 piece price shown. See web or call for volume pricing.						
6"	12"	18"	24"	36"	48"	Custom Len.
\$270.54	\$270.54	\$271.02	\$271.51	\$272.47	\$273.45	See Web

Test Flexible Cable Assemblies						
PE-VNA Coax, 50 Ohm						
Part No. <a href="#">PE319</a>	Cable Dia.			Attn. @ 1 GHz	Power @ 1 GHz	
1 piece price shown. See web or call for volume pricing.						
8"	20"	24"	36"	40"	48"	Custom Len.
Call	Call	\$1,237.79	\$1,384.26	Call	\$1,425.42	See Web

Standard Formable Cable Assemblies						
PE-SR402FL Coax, 50 Ohm						
Part No. <a href="#">PE34733</a>	Cable Dia.			Attn. @ 1 GHz	Power @ 1 GHz	
1 piece price shown. See web or call for volume pricing.						
6"	12"	18"	24"	36"	48"	Custom Len.
\$142.09	\$146.34	\$150.72	\$146.23	\$163.87	\$162.58	See Web

PE-SR405FL Coax, 50 Ohm						
Part No. <a href="#">PE3C1377</a>	Cable Dia.			Attn. @ 1 GHz	Power @ 1 GHz	
1 piece price shown. See web or call for volume pricing.						
6"	12"	18"	24"	36"	48"	Custom Len.
\$181.97	\$181.97	\$187.75	\$193.55	\$205.13	\$216.73	See Web

Standard Flexible Cable Assemblies						
PE-P086 Coax, 50 Ohm						
Part No. <a href="#">PE3C0666</a>	Cable Dia.			Attn. @ 1 GHz	Power @ 1 GHz	
1 piece price shown. See web or call for volume pricing.						
6"	12"	18"	24"	36"	48"	Custom Len.
\$175.61	\$179.79	\$184.09	\$188.39	\$197.01	\$206.13	See Web

PE-P103 Coax, 50 Ohm						
Part No. <a href="#">PE3C6635</a>	Cable Dia.			Attn. @ 1 GHz	Power @ 1 GHz	
1 piece price shown. See web or call for volume pricing.						
12"	24"	36"	48"	60"	50CM	Custom Len.
\$272.67	\$300.78	\$318.39	\$346.50	\$387.31	\$280.19	See Web

PE-VNA-R Coax, 50 Ohm						
Part No. <a href="#">PE3VNA2605</a>	Cable Dia.			Attn. @ 1 GHz	Power @ 1 GHz	
1 piece price shown. See web or call for volume pricing.						
24"	48"	-	-	-	-	Custom Len.
\$1,616.99	\$1,826.81	-	-	-	-	See Web

Standard Semi-Rigid Cable Assemblies						
PE-118SR Coax, 50 Ohm						
Part No. <a href="#">PE3W07491</a>	Cable Dia.			Attn. @ 1 GHz	Power @ 1 GHz	
1 piece price shown. See web or call for volume pricing.						
6"	12"	18"	24"	36"	48"	Custom Len.
\$310.52	\$310.52	\$312.47	\$314.41	\$318.31	\$322.21	See Web

PE-SR402AL Coax, 50 Ohm						
Part No. <a href="#">PE34731</a>	Cable Dia.			Attn. @ 1 GHz	Power @ 1 GHz	
1 piece price shown. See web or call for volume pricing.						
6"	12"	18"	24"	36"	48"	Custom Len.
\$143.23	\$140.17	\$145.28	\$159.62	\$160.59	\$170.79	See Web

\*Coax Performance at 1 GHz Notes: Cable assembly max frequency may be lower than connector or coax max frequency



For our complete selection of cable assemblies, please visit our website

RG402/U Coax, 50 Ohm						
Part No. <a href="#">PE34729</a>	Cable Dia.			Attn. @ 1 GHz	Power @ 1 GHz	
1 piece price shown. See web or call for volume pricing.	0.16" dia.			12 dB/100ft	650 W	
6"	12"	18"	24"	36"	48"	Custom Len.
\$142.00	\$146.11	\$150.36	\$154.59	\$163.08	\$161.60	See Web

**2.92MM MALE TO 2.92MM FEMALE**



**Test Flexible Cable Assemblies**

PE-P160 Coax, 50 Ohm						
Part No. <a href="#">PE361</a>	Cable Dia.			Attn. @ 1 GHz	Power @ 1 GHz	
1 piece price shown. See web or call for volume pricing.	0.16" dia.			12.62 dB/100ft	650 W	
12"	24"	36"	48"	60"	50CM	Custom Len.
\$290.42	\$318.49	\$346.57	\$374.63	\$402.70	\$308.42	See Web

**Standard Flexible Cable Assemblies**

PE-VNA-R Coax, 50 Ohm						
Part No. <a href="#">PE3VNA2606</a>	Cable Dia.			Attn. @ 1 GHz	Power @ 1 GHz	
1 piece price shown. See web or call for volume pricing.	0.43" dia.			-	-	Custom Len.
24"	48"	-	-	-	-	See Web
\$1,649.29	\$1,745.63	-	-	-	-	See Web

Part No. <a href="#">PE3VNA4002</a>	Cable Dia.			Attn. @ 1 GHz	Power @ 1 GHz	
1 piece price shown. See web or call for volume pricing.	0.43" dia.			-	-	Custom Len.
24"	48"	85"	-	-	-	See Web
\$2,155.32	\$2,375.62	Call	-	-	-	See Web

**2.92MM MALE TO 2.92MM FEMALE BULKHEAD**



SEE MOUNTING HOLE SECTION ON PAGE 409

**Standard Formable Cable Assemblies**

PE-SR402FL Coax, 50 Ohm						
Part No. <a href="#">PE34745</a>	Cable Dia.			Attn. @ 1 GHz	Power @ 1 GHz	
1 piece price shown. See web or call for volume pricing.	0.141" dia.			11.88 dB/100ft	450 W	
6"	12"	18"	24"	36"	48"	Custom Len.
\$219.78	\$219.78	\$223.86	\$227.96	\$236.13	\$244.31	See Web

**Standard Semi-Rigid Cable Assemblies**

PE-SR402AL Coax, 50 Ohm						
Part No. <a href="#">PE34743</a>	Cable Dia.			Attn. @ 1 GHz	Power @ 1 GHz	
1 piece price shown. See web or call for volume pricing.	0.141" dia.			13 dB/100ft	450 W	
6"	12"	18"	24"	36"	48"	Custom Len.
\$238.67	\$221.84	\$249.55	\$255.06	\$242.26	\$252.46	See Web

**3.5MM MALE TO 1.85MM MALE**



**Standard Formable Cable Assemblies**

PE-SR405FL Coax, 50 Ohm						
Part No. <a href="#">PE36537</a>	Cable Dia.			Attn. @ 1 GHz	Power @ 1 GHz	
1 piece price shown. See web or call for volume pricing.	0.141" dia.			22.5 dB/100ft	130 W	
6"	12"	18"	24"	36"	48"	Custom Len.
\$285.69	\$291.28	\$296.94	\$302.53	\$313.78	\$325.05	See Web

**Standard Semi-Rigid Cable Assemblies**

RG405/U Coax, 50 Ohm						
Part No. <a href="#">PE36535</a>	Cable Dia.			Attn. @ 1 GHz	Power @ 1 GHz	
1 piece price shown. See web or call for volume pricing.	0.141" dia.			22 dB/100ft	130 W	
6"	12"	18"	24"	36"	48"	Custom Len.
\$283.66	\$287.24	\$290.89	\$294.45	\$301.68	\$308.90	See Web

**3.5MM MALE TO 3.5MM MALE**



**Test Flexible Cable Assemblies**

PE-P160 Coax, 50 Ohm						
Part No. <a href="#">PE369</a>	Cable Dia.			Attn. @ 1 GHz	Power @ 1 GHz	
1 piece price shown. See web or call for volume pricing.	0.16" dia.			12.62 dB/100ft	650 W	
12"	24"	36"	48"	60"	50CM	Custom Len.
Call	Call	\$333.95	\$362.03	\$390.10	Call	See Web

**Standard Flexible Cable Assemblies**

PE-VNA Coax, 50 Ohm						
Part No. <a href="#">PE315</a>	Cable Dia.			Attn. @ 1 GHz	Power @ 1 GHz	
1 piece price shown. See web or call for volume pricing.	0.43" dia.			-	-	Custom Len.
24"	36"	48"	60"	72"	-	See Web
\$1,095.24	\$1,311.93	\$1,306.77	\$1,519.88	\$1,654.94	-	See Web

**Standard Flexible Cable Assemblies**

PE-VNA-R Coax, 50 Ohm						
Part No. <a href="#">PE3VNA2603</a>	Cable Dia.			Attn. @ 1 GHz	Power @ 1 GHz	
1 piece price shown. See web or call for volume pricing.	0.43" dia.			-	-	Custom Len.
24"	36"	48"	60"	-	-	See Web
\$1,584.74	\$1,854.96	\$1,794.54	\$2,083.76	-	-	See Web

**Standard Semi-Rigid Cable Assemblies**

PE-SR402AL Coax, 50 Ohm						
Part No. <a href="#">PE34572</a>	Cable Dia.			Attn. @ 1 GHz	Power @ 1 GHz	
1 piece price shown. See web or call for volume pricing.	0.141" dia.			13 dB/100ft	450 W	
6"	12"	18"	24"	36"	48"	Custom Len.
\$242.53	\$247.88	\$253.39	\$258.91	\$269.96	\$264.48	See Web

**Standard Semi-Rigid Cable Assemblies**

PE-SR405AL Coax, 50 Ohm						
Part No. <a href="#">PE34576</a>	Cable Dia.			Attn. @ 1 GHz	Power @ 1 GHz	
1 piece price shown. See web or call for volume pricing.	0.141" dia.			23 dB/100ft	130 W	
6"	12"	18"	24"	36"	48"	Custom Len.
\$244.01	\$244.01	\$248.67	\$253.36	\$262.75	\$272.10	See Web

**Standard Semi-Rigid Cable Assemblies**

RG402/U Coax, 50 Ohm						
Part No. <a href="#">PE34570</a>	Cable Dia.			Attn. @ 1 GHz	Power @ 1 GHz	
1 piece price shown. See web or call for volume pricing.	0.141" dia.			12 dB/100ft	650 W	
6"	12"	18"	24"	36"	48"	Custom Len.
\$231.53	\$231.53	\$235.47	\$239.44	\$247.35	\$255.27	See Web

**Standard Semi-Rigid Cable Assemblies**

RG405/U Coax, 50 Ohm						
Part No. <a href="#">PE34574</a>	Cable Dia.			Attn. @ 1 GHz	Power @ 1 GHz	
1 piece price shown. See web or call for volume pricing.	0.141" dia.			22 dB/100ft	130 W	
6"	12"	18"	24"	36"	48"	Custom Len.
\$242.07	\$242.07	\$245.80	\$249.51	\$256.97	\$281.22	See Web

**3.5MM MALE TO 3.5MM FEMALE**



**Test Flexible Cable Assemblies**

PE-VNA Coax, 50 Ohm						
Part No. <a href="#">PE317</a>	Cable Dia.			Attn. @ 1 GHz	Power @ 1 GHz	
1 piece price shown. See web or call for volume pricing.	0.43" dia.			-	-	Custom Len.
24"	36"	48"	60"	72"	-	See Web
\$1,104.91	\$1,181.86	\$1,420.85	\$1,381.59	\$1,549.31	-	See Web

**Standard Formable Cable Assemblies**

PE-SR402FL Coax, 50 Ohm						
Part No. <a href="#">PE35121</a>	Cable Dia.			Attn. @ 1 GHz	Power @ 1 GHz	
1 piece price shown. See web or call for volume pricing.	0.141" dia.			11.88 dB/100ft	450 W	
12"	24"	36"	48"	60"	-	Custom Len.
\$251.54	\$245.47	\$253.63	\$261.80	\$269.98	-	See Web

PE-SR402FL Coax, 50 Ohm						
Part No. <a href="#">PE3W03922</a>	Cable Dia.			Attn. @ 1 GHz	Power @ 1 GHz	
1 piece price shown. See web or call for volume pricing.	0.141" dia.			12 dB/100ft	400 W	
12"	24"	36"	48"	60"	50CM	Custom Len.
\$207.13	\$215.65	\$224.14	\$232.64	\$241.15	\$212.58	See Web

**Standard Flexible Cable Assemblies**

PE-FF430 Coax, 50 Ohm						
Part No. <a href="#">PE3C4012</a>	Cable Dia.			Attn. @ 1 GHz	Power @ 1 GHz	
1 piece price shown. See web or call for volume pricing.	0.43" dia.			-	-	Custom Len.
100CM	-	-	-	-	-	See Web
\$945.57	-	-	-	-	-	See Web

PE-VNA-R Coax, 50 Ohm						
Part No. <a href="#">PE3VNA2604</a>	Cable Dia.			Attn. @ 1 GHz	Power @ 1 GHz	
1 piece price shown. See web or call for volume pricing.	0.43" dia.			-	-	Custom Len.
24"	36"	48"	60"	-	-	See Web
\$1,616.99	\$1,890.17	\$1,826.81	\$2,118.97	-	-	See Web

**Standard Semi-Rigid Cable Assemblies**

PE-SR402AL Coax, 50 Ohm						
Part No. <a href="#">PE34580</a>	Cable Dia.			Attn. @ 1 GHz	Power @ 1 GHz	
1 piece price shown. See web or call for volume pricing.	0.141" dia.			13 dB/100ft	450 W	
6"	12"	18"	24"	36"	48"	Custom Len.
\$239.39	\$239.39	\$244.47	\$249.59	\$259.78	\$287.49	See Web

PE-SR405AL Coax, 50 Ohm						
Part No. <a href="#">PE34584</a>	Cable Dia.			Attn. @ 1 GHz	Power @ 1 GHz	
1 piece price shown. See web or call for volume pricing.	0.141" dia.			23 dB/100ft	130 W	
6"	12"	18"	24"	36"	48"	Custom Len.
Call	\$298.94	Call	\$308.00	\$317.10	\$326.16	See Web

RG402/U Coax, 50 Ohm						
Part No. <a href="#">PE34578</a>	Cable Dia.			Attn. @ 1 GHz	Power @ 1 GHz	
1 piece price shown. See web or call for volume pricing.	0.141" dia.			12 dB/100ft	650 W	
6"	12"	18"	24"	36"	48"	Custom Len.
\$247.15	\$237.04	\$241.00	\$244.95	\$252.87	\$260.79	See Web

RG405/U Coax, 50 Ohm						
Part No. <a href="#">PE34582</a>	Cable Dia.			Attn. @ 1 GHz	Power @ 1 GHz	
1 piece price shown. See web or call for volume pricing.	0.141" dia.			22 dB/100ft	130 W	
6"	12"	18"	24"	36"	48"	Custom Len.
\$314.88	\$314.88	\$318.61	\$322.34	\$329.78	\$358.41	See Web

**3.5MM MALE TO 3.5MM FEMALE BULKHEAD**



SEE MOUNTING HOLE SECTION ON PAGE 409

**Standard Semi-Rigid Cable Assemblies**

PE-SR402AL Coax, 50 Ohm						
Part No. <a href="#">PE34588</a>	Cable Dia.			Attn. @ 1 GHz	Power @ 1 GHz	
1 piece price shown. See web or call for volume pricing.	0.141" dia.			13 dB/100ft	450 W	
6"	12"	18"	24"	36"	48"	Custom Len.
\$422.33	\$427.27	\$432.21	\$437.14	\$447.06	\$456.93	See Web

Cable Assemblies

See Our Website For Current Pricing & Real-Time Stock Availability!

For Custom Lengths, Metric Lengths or Special Configurations, Please call (949) 261-1920



Technical Support  
+1 (949) 261-1920



Same-Day Shipping,  
Even Custom Cable Assemblies



For our complete selection of cable assemblies, please visit our website

Cable Assemblies

See Our Website For Current Pricing & Real-Time Stock Availability!

PE-SR405AL Coax, 50 Ohm							
Part No. <a href="#">PE34592</a>			Cable Dia.	Attn. @ 1 GHz	Power @ 1 GHz	7	
1 piece price shown. See web or call for volume pricing.							
6"	12"	18"	24"	36"	48"		Custom Len.
\$253.21	\$257.70	\$262.26	\$266.81	\$275.86	\$284.98		See Web
RG402/U Coax, 50 Ohm							
Part No. <a href="#">PE34586</a>			Cable Dia.	Attn. @ 1 GHz	Power @ 1 GHz	8	
1 piece price shown. See web or call for volume pricing.							
6"	12"	18"	24"	36"	48"		Custom Len.
\$421.21	\$425.06	\$428.90	\$432.73	\$440.41	\$448.08		See Web
RG405/U Coax, 50 Ohm							
Part No. <a href="#">PE34590</a>			Cable Dia.	Attn. @ 1 GHz	Power @ 1 GHz	9	
1 piece price shown. See web or call for volume pricing.							
6"	12"	18"	24"	36"	48"		Custom Len.
\$252.23	\$255.88	\$259.45	\$263.10	\$270.27	\$277.49		See Web
3.5MM FEMALE TO 3.5MM FEMALE							
Standard Flexible Cable Assemblies							
PE-FF430 Coax, 50 Ohm							
Part No. <a href="#">PE3C4013</a>			Cable Dia.	Attn. @ 1 GHz	Power @ 1 GHz	10	
1 piece price shown. See web or call for volume pricing.							
100CM	-	-	-	0.43" dia.	-		Custom Len.
\$945.57	-	-	-	-	-		See Web
4.1/9.5 MINI DIN MALE TO 4.1/9.5 MINI DIN MALE							
Low PIM Formable Cable Assemblies							
PE-SR402FLJ Low PIM Coax, 50 Ohm							
Part No. <a href="#">PE3C2009</a>			Cable Dia.	Attn. @ 1 GHz	Power @ 1 GHz	11	
1 piece price shown. See web or call for volume pricing.							
50CM	100CM	200CM	-	0.161" dia.	-		Custom Len.
Call	\$112.41	\$134.57	-	-	-		See Web
Low PIM Corrugated Cable Assemblies							
PE-1/4SFHC Coax, 50 Ohm							
Part No. <a href="#">PE3C7819</a>			Cable Dia.	Attn. @ 1 GHz	Power @ 1 GHz	12	
1 piece price shown. See web or call for volume pricing.							
12"	24"	36"	48"	0.303" dia.	5.85 dB/100ft		Custom Len.
\$64.71	\$68.44	\$72.17	\$75.90	\$79.62	\$67.09		See Web
SPP-250-LLPL Coax, 50 Ohm							
Part No. <a href="#">PE3C4143</a>			Cable Dia.	Attn. @ 1 GHz	Power @ 1 GHz	13	
1 piece price shown. See web or call for volume pricing.							
"	12"	24"	36"	0.28" dia.	5.5 dB/100ft		650 W
Call	\$101.58	\$107.71	\$112.27	\$118.32	\$124.37		See Web
4.1/9.5 MINI DIN MALE TO 4.1/9.5 MINI DIN MALE RIGHT ANGLE							
Low PIM Corrugated Cable Assemblies							
PE-1/4SFHC Coax, 50 Ohm							
Part No. <a href="#">PE3C7820</a>			Cable Dia.	Attn. @ 1 GHz	Power @ 1 GHz	14	
1 piece price shown. See web or call for volume pricing.							
12"	24"	36"	48"	0.303" dia.	5.85 dB/100ft		Custom Len.
\$69.66	\$73.39	\$77.12	\$80.84	\$84.57	\$72.04		See Web
SPP-250-LLPL Coax, 50 Ohm							
Part No. <a href="#">PE3C5847</a>			Cable Dia.	Attn. @ 1 GHz	Power @ 1 GHz	15	
1 piece price shown. See web or call for volume pricing.							
12"	24"	36"	48"	0.28" dia.	-		50CM Custom Len.
\$106.74	\$111.31	\$117.36	\$123.41	\$129.46	\$109.15		See Web
4.1/9.5 MINI DIN MALE TO 4.1/9.5 MINI DIN FEMALE							
Low PIM Formable Cable Assemblies							
PE-SR402FLJ Low PIM Coax, 50 Ohm							
Part No. <a href="#">PE3C2010</a>			Cable Dia.	Attn. @ 1 GHz	Power @ 1 GHz	16	
1 piece price shown. See web or call for volume pricing.							
100CM	200CM	-	-	0.161" dia.	-		Custom Len.
\$137.98	Call	-	-	-	-		See Web
Low PIM Corrugated Cable Assemblies							
PE-1/4SFHC Coax, 50 Ohm							
Part No. <a href="#">PE3C7821</a>			Cable Dia.	Attn. @ 1 GHz	Power @ 1 GHz	17	
1 piece price shown. See web or call for volume pricing.							
12"	24"	36"	48"	0.303" dia.	5.85 dB/100ft		Custom Len.
\$68.56	\$72.29	\$76.02	\$79.74	\$83.47	\$70.95		See Web
SPP-250-LLPL Coax, 50 Ohm							
Part No. <a href="#">PE3C5841</a>			Cable Dia.	Attn. @ 1 GHz	Power @ 1 GHz	18	
1 piece price shown. See web or call for volume pricing.							
12"	24"	36"	48"	0.28" dia.	-		50CM Custom Len.
\$98.79	\$104.93	\$109.52	\$115.57	\$121.62	\$102.73		See Web

4.1/9.5 MINI DIN MALE TO 4.1/9.5 MINI DIN FEMALE BULKHEAD							
SEE MOUNTING HOLE SECTION ON PAGE 409							
Low PIM Corrugated Cable Assemblies							
PE-1/4SFHC Coax, 50 Ohm							
Part No. <a href="#">PE3C7822</a>			Cable Dia.	Attn. @ 1 GHz	Power @ 1 GHz	19	
1 piece price shown. See web or call for volume pricing.							
12"	24"	36"	48"	0.303" dia.	5.85 dB/100ft		Custom Len.
\$71.31	\$75.03	\$78.76	\$82.50	\$86.22	\$73.69		See Web
4.1/9.5 MINI DIN MALE TO 4.3-10 FEMALE							
Low PIM Corrugated Cable Assemblies							
SPP-250-LLPL Coax, 50 Ohm							
Part No. <a href="#">PE3C5834</a>			Cable Dia.	Attn. @ 1 GHz	Power @ 1 GHz	20	
1 piece price shown. See web or call for volume pricing.							
12"	24"	36"	48"	0.28" dia.	-		50CM Custom Len.
\$98.79	\$104.93	\$109.52	\$115.57	\$121.62	\$102.73		See Web
4.1/9.5 MINI DIN MALE TO 7/16 DIN MALE							
Low PIM Corrugated Cable Assemblies							
SPP-250-LLPL Coax, 50 Ohm							
Part No. <a href="#">PE3C4134</a>			Cable Dia.	Attn. @ 1 GHz	Power @ 1 GHz	21	
1 piece price shown. See web or call for volume pricing.							
12"	24"	36"	48"	0.28" dia.	-		50CM Custom Len.
\$112.97	\$108.74	\$114.79	\$120.84	\$126.89	\$106.57		See Web
4.1/9.5 MINI DIN MALE TO 7/16 DIN FEMALE							
Low PIM Corrugated Cable Assemblies							
SPP-250-LLPL Coax, 50 Ohm							
Part No. <a href="#">PE3C5854</a>			Cable Dia.	Attn. @ 1 GHz	Power @ 1 GHz	22	
1 piece price shown. See web or call for volume pricing.							
12"	24"	36"	48"	0.28" dia.	-		50CM Custom Len.
\$98.79	\$104.93	\$109.52	\$115.57	\$121.62	\$102.73		See Web
4.1/9.5 MINI DIN MALE TO N FEMALE							
Corrugated Cable Assemblies							
SPP-250-LLPL Coax, 50 Ohm							
Part No. <a href="#">PE3W07481</a>			Cable Dia.	Attn. @ 1 GHz	Power @ 1 GHz	23	
1 piece price shown. See web or call for volume pricing.							
12"	24"	36"	48"	0.28" dia.	-		50CM Custom Len.
Call	Call	Call	Call	Call	Call		See Web
4.1/9.5 MINI DIN MALE TO QMA MALE							
Low PIM Corrugated Cable Assemblies							
SPP-250-LLPL Coax, 50 Ohm							
Part No. <a href="#">PE3C5866</a>			Cable Dia.	Attn. @ 1 GHz	Power @ 1 GHz	24	
1 piece price shown. See web or call for volume pricing.							
12"	24"	36"	48"	0.28" dia.	-		50CM Custom Len.
\$86.90	\$93.04	\$99.17	\$105.29	\$109.88	\$90.82		See Web
4.1/9.5 MINI DIN MALE TO QMA MALE RIGHT ANGLE							
Low PIM Corrugated Cable Assemblies							
SPP-250-LLPL Coax, 50 Ohm							
Part No. <a href="#">PE3C5872</a>			Cable Dia.	Attn. @ 1 GHz	Power @ 1 GHz	25	
1 piece price shown. See web or call for volume pricing.							
12"	24"	36"	48"	0.28" dia.	-		50CM Custom Len.
\$89.29	\$95.42	\$101.56	\$107.69	\$112.25	\$93.21		See Web
4.1/9.5 MINI DIN MALE TO QMA FEMALE							
Low PIM Corrugated Cable Assemblies							
SPP-250-LLPL Coax, 50 Ohm							
Part No. <a href="#">PE3C5860</a>			Cable Dia.	Attn. @ 1 GHz	Power @ 1 GHz	26	
1 piece price shown. See web or call for volume pricing.							
12"	24"	36"	48"	0.28" dia.	-		50CM Custom Len.
\$82.94	\$89.07	\$95.21	\$101.34	\$107.48	\$86.88		See Web

\*Coax Performance at 1 GHz Notes: Cable assembly max frequency may be lower than connector or coax max frequency

For our complete selection of cable assemblies, please visit our website

4.1/9.5 MINI DIN MALE TO SMA MALE						
Low PIM Corrugated Cable Assemblies						
SPP-250-LLPL Coax, 50 Ohm						
Part No. <b>PE3C5885</b>	Cable Dia.	Attn. @ 1 GHz	Power @ 1 GHz			
1 piece price shown. See web or call for volume pricing.	0.28" dia.					
12" 24" 36" 48"	60"	50CM	Custom Len.	27		
\$78.96 \$85.09 \$91.22 \$97.36	\$103.49	\$82.88	See Web			
4.1/9.5 MINI DIN MALE TO SMA MALE RIGHT ANGLE						
Low PIM Corrugated Cable Assemblies						
SPP-250-LLPL Coax, 50 Ohm						
Part No. <b>PE3C5890</b>	Cable Dia.	Attn. @ 1 GHz	Power @ 1 GHz			
1 piece price shown. See web or call for volume pricing.	0.28" dia.					
12" 24" 36" 48"	60"	50CM	Custom Len.	28		
\$80.55 \$86.69 \$92.82 \$98.95	\$105.10	\$84.48	See Web			
4.1/9.5 MINI DIN MALE TO SMA FEMALE						
Low PIM Corrugated Cable Assemblies						
SPP-250-LLPL Coax, 50 Ohm						
Part No. <b>PE3C5879</b>	Cable Dia.	Attn. @ 1 GHz	Power @ 1 GHz			
1 piece price shown. See web or call for volume pricing.	0.28" dia.					
12" 24" 36" 48"	60"	50CM	Custom Len.	29		
\$79.75 \$85.89 \$92.02 \$98.16	\$104.29	\$83.68	See Web			
4.1/9.5 MINI DIN MALE RIGHT ANGLE TO 4.1/9.5 MINI DIN MALE RIGHT ANGLE						
Low PIM Corrugated Cable Assemblies						
PE-1/4SFHC Coax, 50 Ohm						
Part No. <b>PE3C7823</b>	Cable Dia.	Attn. @ 1 GHz	Power @ 1 GHz			
1 piece price shown. See web or call for volume pricing.	0.303" dia.	5.85 dB/100ft				
12" 24" 36" 48"	60"	50CM	Custom Len.	30		
\$74.61 \$78.34 \$82.06 \$85.79	\$89.52	\$77.00	See Web			
SPP-250-LLPL Coax, 50 Ohm						
Part No. <b>PE3C5852</b>	Cable Dia.	Attn. @ 1 GHz	Power @ 1 GHz			
1 piece price shown. See web or call for volume pricing.	0.28" dia.					
12" 24" 36" 48"	60"	50CM	Custom Len.	31		
\$117.01 \$123.06 \$129.10 \$135.15	\$141.20	\$120.87	See Web			
Part No. <b>PE3C6172</b>	Cable Dia.	Attn. @ 1 GHz	Power @ 1 GHz			
1 piece price shown. See web or call for volume pricing.	0.28" dia.	5.5 dB/100ft	650 W			
12" 24" 36" 48"	60"	50CM	Custom Len.	32		
\$73.37 \$79.50 \$85.64 \$91.77	\$97.91	\$77.29	See Web			
4.1/9.5 MINI DIN MALE RIGHT ANGLE TO 4.1/9.5 MINI DIN FEMALE						
Low PIM Corrugated Cable Assemblies						
PE-1/4SFHC Coax, 50 Ohm						
Part No. <b>PE3C7824</b>	Cable Dia.	Attn. @ 1 GHz	Power @ 1 GHz			
1 piece price shown. See web or call for volume pricing.	0.303" dia.	5.85 dB/100ft				
12" 24" 36" 48"	60"	50CM	Custom Len.	33		
\$73.51 \$77.24 \$80.96 \$84.69	\$88.41	\$75.90	See Web			
4.1/9.5 MINI DIN MALE RIGHT ANGLE TO 4.1/9.5 MINI DIN FEMALE BULKHEAD						
SEE MOUNTING HOLE SECTION ON PAGE 409						
Low PIM Corrugated Cable Assemblies						
PE-1/4SFHC Coax, 50 Ohm						
Part No. <b>PE3C7825</b>	Cable Dia.	Attn. @ 1 GHz	Power @ 1 GHz			
1 piece price shown. See web or call for volume pricing.	0.303" dia.	5.85 dB/100ft				
12" 24" 36" 48"	60"	50CM	Custom Len.	34		
\$76.25 \$79.98 \$83.72 \$87.44	\$91.17	\$78.64	See Web			
4.1/9.5 MINI DIN MALE RIGHT ANGLE TO 4.3-10 MALE						
Low PIM Corrugated Cable Assemblies						
SPP-250-LLPL Coax, 50 Ohm						
Part No. <b>PE3C5846</b>	Cable Dia.	Attn. @ 1 GHz	Power @ 1 GHz			
1 piece price shown. See web or call for volume pricing.	0.28" dia.					
12" 24" 36" 48"	60"	50CM	Custom Len.	35		
\$106.74 \$111.31 \$117.36 \$123.41	\$129.46	\$109.15	See Web			

4.1/9.5 MINI DIN MALE RIGHT ANGLE TO 4.3-10 FEMALE						
Corrugated Cable Assemblies						
SPP-250-LLPL Coax, 50 Ohm						
Part No. <b>PE3C6173</b>	Cable Dia.	Attn. @ 1 GHz	Power @ 1 GHz			
1 piece price shown. See web or call for volume pricing.	0.28" dia.					
12" 24" 36" 48"	60"	50CM	Custom Len.	36		
\$72.05 \$78.19 \$84.33 \$90.47	\$96.60	\$75.97	See Web			
4.1/9.5 MINI DIN MALE RIGHT ANGLE TO 7/16 DIN MALE						
Low PIM Corrugated Cable Assemblies						
SPP-250-LLPL Coax, 50 Ohm						
Part No. <b>PE3C5950</b>	Cable Dia.	Attn. @ 1 GHz	Power @ 1 GHz			
1 piece price shown. See web or call for volume pricing.	0.28" dia.					
12" 24" 36" 48"	60"	50CM	Custom Len.	37		
\$109.17 \$115.22 \$121.27 \$127.32	\$133.36	\$113.02	See Web			
4.1/9.5 MINI DIN MALE RIGHT ANGLE TO N MALE						
Low PIM Corrugated Cable Assemblies						
SPP-250-LLPL Coax, 50 Ohm						
Part No. <b>PE3C5848</b>	Cable Dia.	Attn. @ 1 GHz	Power @ 1 GHz			
1 piece price shown. See web or call for volume pricing.	0.28" dia.					
12" 24" 36" 48"	60"	50CM	Custom Len.	38		
\$109.17 \$115.22 \$121.27 \$127.32	\$133.36	\$113.03	See Web			
Part No. <b>PE3C6187</b>	Cable Dia.	Attn. @ 1 GHz	Power @ 1 GHz			
1 piece price shown. See web or call for volume pricing.	0.28" dia.	5.5 dB/100ft	650 W			
12" 24" 36" 48"	60"	50CM	Custom Len.	39		
\$68.12 \$74.24 \$80.38 \$86.51	\$92.65	\$72.03	See Web			
4.1/9.5 MINI DIN MALE RIGHT ANGLE TO N MALE RIGHT ANGLE						
Low PIM Corrugated Cable Assemblies						
SPP-250-LLPL Coax, 50 Ohm						
Part No. <b>PE3C5849</b>	Cable Dia.	Attn. @ 1 GHz	Power @ 1 GHz			
1 piece price shown. See web or call for volume pricing.	0.28" dia.					
12" 24" 36" 48"	60"	50CM	Custom Len.	40		
\$102.77 \$107.39 \$113.44 \$119.49	\$125.54	\$106.69	See Web			
Part No. <b>PE3C6218</b>	Cable Dia.	Attn. @ 1 GHz	Power @ 1 GHz			
1 piece price shown. See web or call for volume pricing.	0.28" dia.	5.5 dB/100ft	650 W			
12" 24" 36" 48"	60"	50CM	Custom Len.	41		
\$65.50 \$71.62 \$77.75 \$83.89	\$90.02	\$69.41	See Web			
4.1/9.5 MINI DIN MALE RIGHT ANGLE TO N MALE RIGHT ANGLE						
Low PIM Corrugated Cable Assemblies						
SPP-250-LLPL Coax, 50 Ohm						
Part No. <b>PE3C6234</b>	Cable Dia.	Attn. @ 1 GHz	Power @ 1 GHz			
1 piece price shown. See web or call for volume pricing.	0.28" dia.					
12" 24" 36" 48"	60"	50CM	Custom Len.	42		
\$68.12 \$74.24 \$80.38 \$86.51	\$92.65	\$72.03	See Web			
4.1/9.5 MINI DIN MALE RIGHT ANGLE TO QMA MALE						
Low PIM Corrugated Cable Assemblies						
SPP-250-LLPL Coax, 50 Ohm						
Part No. <b>PE3C5850</b>	Cable Dia.	Attn. @ 1 GHz	Power @ 1 GHz			
1 piece price shown. See web or call for volume pricing.	0.28" dia.					
12" 24" 36" 48"	60"	50CM	Custom Len.	43		
\$98.79 \$104.93 \$109.52 \$115.57	\$121.62	\$102.73	See Web			
4.1/9.5 MINI DIN MALE RIGHT ANGLE TO SMA MALE						
Low PIM Corrugated Cable Assemblies						
SPP-250-LLPL Coax, 50 Ohm						
Part No. <b>PE3C5851</b>	Cable Dia.	Attn. @ 1 GHz	Power @ 1 GHz			
1 piece price shown. See web or call for volume pricing.	0.28" dia.					
12" 24" 36" 48"	60"	50CM	Custom Len.	44		
\$90.85 \$96.99 \$103.12 \$107.74	\$113.79	\$94.80	See Web			
4.1/9.5 MINI DIN FEMALE TO 4.3-10 MALE						
Low PIM Corrugated Cable Assemblies						

Cable Assemblies

See Our Website For Current Pricing & Real-Time Stock Availability!

Continued on Next Page

For Custom Lengths, Metric Lengths or Special Configurations, Please call (949) 261-1920



Technical Support  
+1 (949) 261-1920











Same-Day Shipping,  
Even Custom Cable Assemblies

For our complete selection of cable assemblies, please visit our website

Cable Assemblies

See Our Website For Current Pricing & Real-Time Stock Availability!

SPP-250-LLPL Coax, 50 Ohm						
Part No. <a href="#">PE3C5840</a>	Cable Dia.			Attn. @ 1 GHz	Power @ 1 GHz	45
1 piece price shown. See web or call for volume pricing.	0.28" dia.					
12"	24"	36"	48"	60"	50CM	Custom Len.
\$98.79	\$104.93	\$109.52	\$115.57	\$121.62	\$102.73	See Web
<b>4.1/9.5 MINI DIN FEMALE TO 7/16 DIN MALE</b>						
						
<b>Low PIM Corrugated Cable Assemblies</b>						
SPP-250-LLPL Coax, 50 Ohm						
Part No. <a href="#">PE3C5842</a>	Cable Dia.			Attn. @ 1 GHz	Power @ 1 GHz	46
1 piece price shown. See web or call for volume pricing.	0.28" dia.					
12"	24"	36"	48"	60"	50CM	Custom Len.
\$102.76	\$107.38	\$113.43	\$119.48	\$125.53	\$106.68	See Web
<b>4.1/9.5 MINI DIN FEMALE TO N MALE</b>						
						
<b>Low PIM Corrugated Cable Assemblies</b>						
SPP-250-LLPL Coax, 50 Ohm						
Part No. <a href="#">PE3C5843</a>	Cable Dia.			Attn. @ 1 GHz	Power @ 1 GHz	47
1 piece price shown. See web or call for volume pricing.	0.28" dia.					
12"	24"	36"	48"	60"	50CM	Custom Len.
\$94.82	\$100.95	\$107.09	\$111.64	\$117.69	\$98.74	See Web
<b>4.1/9.5 MINI DIN FEMALE TO QMA MALE</b>						
						
<b>Low PIM Corrugated Cable Assemblies</b>						
SPP-250-LLPL Coax, 50 Ohm						
Part No. <a href="#">PE3C5844</a>	Cable Dia.			Attn. @ 1 GHz	Power @ 1 GHz	48
1 piece price shown. See web or call for volume pricing.	0.28" dia.					
12"	24"	36"	48"	60"	50CM	Custom Len.
\$90.84	\$96.98	\$103.11	\$107.73	\$113.78	\$94.79	See Web
<b>4.1/9.5 MINI DIN FEMALE TO SMA MALE</b>						
						
<b>Low PIM Corrugated Cable Assemblies</b>						
SPP-250-LLPL Coax, 50 Ohm						
Part No. <a href="#">PE3C5845</a>	Cable Dia.			Attn. @ 1 GHz	Power @ 1 GHz	49
1 piece price shown. See web or call for volume pricing.	0.28" dia.					
12"	24"	36"	48"	60"	50CM	Custom Len.
\$82.91	\$89.04	\$95.17	\$101.31	\$107.44	\$86.84	See Web
<b>4.3-10 MALE TO 4.3-10 MALE</b>						
						
<b>Low PIM Corrugated Cable Assemblies</b>						
PE-1/4SFHC Coax, 50 Ohm						
Part No. <a href="#">PE3C7826</a>	Cable Dia.			Attn. @ 1 GHz	Power @ 1 GHz	50
1 piece price shown. See web or call for volume pricing.	0.303" dia.			5.85 dB/100ft		
12"	24"	36"	48"	60"	50CM	Custom Len.
\$70.20	\$73.94	\$77.67	\$81.39	\$85.12	\$72.59	See Web
SPP-250-LLPL Coax, 50 Ohm						
Part No. <a href="#">PE3C4142</a>	Cable Dia.			Attn. @ 1 GHz	Power @ 1 GHz	51
1 piece price shown. See web or call for volume pricing.	0.28" dia.					
12"	24"	36"	48"	60"	50CM	Custom Len.
\$101.58	\$107.71	\$112.27	\$118.32	\$124.37	\$105.50	See Web
SPP-250-LLPL Coax, 50 Ohm						
Part No. <a href="#">PE3C6175</a>	Cable Dia.			Attn. @ 1 GHz	Power @ 1 GHz	52
1 piece price shown. See web or call for volume pricing.	0.28" dia.			5.5 dB/100ft	650 W	
12"	24"	36"	48"	60"	50CM	Custom Len.
\$70.73	\$76.87	\$83.00	\$89.14	\$95.27	\$74.67	See Web
SPP-250-LLPL Coax, 50 Ohm						
Part No. <a href="#">PE3C6178</a>	Cable Dia.			Attn. @ 1 GHz	Power @ 1 GHz	53
1 piece price shown. See web or call for volume pricing.	0.28" dia.			5.5 dB/100ft	650 W	
12"	24"	36"	48"	60"	50CM	Custom Len.
\$70.73	\$76.87	\$83.00	\$89.14	\$95.27	\$74.67	See Web
SPP-250-LLPL Coax, 50 Ohm						
Part No. <a href="#">PE3C6179</a>	Cable Dia.			Attn. @ 1 GHz	Power @ 1 GHz	54
1 piece price shown. See web or call for volume pricing.	0.28" dia.			5.5 dB/100ft	650 W	
12"	24"	36"	48"	60"	50CM	Custom Len.
\$70.73	\$76.87	\$83.00	\$89.14	\$95.27	\$74.67	See Web
SPP-500-LLPL Coax, 50 Ohm						
Part No. <a href="#">PE3C6363</a>	Cable Dia.			Attn. @ 1 GHz	Power @ 1 GHz	55
1 piece price shown. See web or call for volume pricing.	0.5" dia.					
12"	24"	36"	48"	60"	50CM	Custom Len.
\$64.82	\$75.09	\$85.37	\$95.66	\$105.94	\$71.39	See Web
SPP-375-LLPL Coax, 50 Ohm						
Part No. <a href="#">PE3C6380</a>	Cable Dia.			Attn. @ 1 GHz	Power @ 1 GHz	56
1 piece price shown. See web or call for volume pricing.	0.402" dia.					
12"	24"	36"	48"	60"	50CM	Custom Len.
\$65.15	\$73.14	\$81.13	\$89.13	\$97.14	\$70.28	See Web

SPO-250 Coax, 50 Ohm						
Part No. <a href="#">PE3C6437</a>	Cable Dia.			Attn. @ 1 GHz	Power @ 1 GHz	57
1 piece price shown. See web or call for volume pricing.	0.303" dia.					
12"	24"	36"	48"	60"	50CM	Custom Len.
\$70.73	\$73.02	\$75.31	\$77.60	\$79.88	\$72.20	See Web
SPF-375 Coax, 50 Ohm						
Part No. <a href="#">PE3C6445</a>	Cable Dia.			Attn. @ 1 GHz	Power @ 1 GHz	58
1 piece price shown. See web or call for volume pricing.	0.435" dia.					
12"	24"	36"	48"	60"	50CM	Custom Len.
\$76.86	\$81.10	\$85.34	\$89.58	\$93.81	\$79.59	See Web
SPO-375 Coax, 50 Ohm						
Part No. <a href="#">PE3C6498</a>	Cable Dia.			Attn. @ 1 GHz	Power @ 1 GHz	59
1 piece price shown. See web or call for volume pricing.	0.43" dia.					
12"	24"	36"	48"	60"	50CM	Custom Len.
\$76.86	\$80.01	\$83.18	\$86.33	\$89.47	\$78.89	See Web
SPO-500 Coax, 50 Ohm						
Part No. <a href="#">PE3C6513</a>	Cable Dia.			Attn. @ 1 GHz	Power @ 1 GHz	60
1 piece price shown. See web or call for volume pricing.	0.53" dia.					
12"	24"	36"	48"	60"	50CM	Custom Len.
\$57.62	\$60.70	\$63.79	\$66.87	\$69.96	\$59.59	See Web
SPF-500 Coax, 50 Ohm						
Part No. <a href="#">PE3C6516</a>	Cable Dia.			Attn. @ 1 GHz	Power @ 1 GHz	61
1 piece price shown. See web or call for volume pricing.	0.545" dia.					
12"	24"	36"	48"	60"	50CM	Custom Len.
\$58.92	\$63.30	\$67.69	\$72.07	\$76.47	\$61.74	See Web
SPF-250 Coax, 50 Ohm						
Part No. <a href="#">PE3C6605</a>	Cable Dia.			Attn. @ 1 GHz	Power @ 1 GHz	62
1 piece price shown. See web or call for volume pricing.	0.303" dia.					
12"	24"	36"	48"	60"	50CM	Custom Len.
\$70.73	\$73.02	\$75.31	\$77.60	\$79.88	\$72.20	See Web
<b>4.3-10 MALE TO 4.3-10 MALE RIGHT ANGLE</b>						
						
<b>Low PIM Corrugated Cable Assemblies</b>						
PE-1/4SFHC Coax, 50 Ohm						
Part No. <a href="#">PE3C7827</a>	Cable Dia.			Attn. @ 1 GHz	Power @ 1 GHz	63
1 piece price shown. See web or call for volume pricing.	0.303" dia.			5.85 dB/100ft		
12"	24"	36"	48"	60"	50CM	Custom Len.
\$72.41	\$76.13	\$79.86	\$83.59	\$87.31	\$74.79	See Web
SPP-250-LLPL Coax, 50 Ohm						
Part No. <a href="#">PE3C6176</a>	Cable Dia.			Attn. @ 1 GHz	Power @ 1 GHz	64
1 piece price shown. See web or call for volume pricing.	0.28" dia.			5.5 dB/100ft	650 W	
12"	24"	36"	48"	60"	50CM	Custom Len.
\$72.05	\$78.19	\$84.33	\$90.47	\$96.60	\$75.97	See Web
SPP-250-LLPL Coax, 50 Ohm						
Part No. <a href="#">PE3C6180</a>	Cable Dia.			Attn. @ 1 GHz	Power @ 1 GHz	65
1 piece price shown. See web or call for volume pricing.	0.28" dia.			5.5 dB/100ft	650 W	
12"	24"	36"	48"	60"	50CM	Custom Len.
\$72.05	\$78.19	\$84.33	\$90.47	\$96.60	\$75.97	See Web
<b>4.3-10 MALE TO 4.3-10 FEMALE</b>						
						
<b>Low PIM Corrugated Cable Assemblies</b>						
PE-1/4SFHC Coax, 50 Ohm						
Part No. <a href="#">PE3C7828</a>	Cable Dia.			Attn. @ 1 GHz	Power @ 1 GHz	66
1 piece price shown. See web or call for volume pricing.	0.303" dia.			5.85 dB/100ft		
12"	24"	36"	48"	60"	50CM	Custom Len.
\$71.31	\$75.03	\$78.76	\$82.50	\$86.22	\$73.69	See Web
SPP-250-LLPL Coax, 50 Ohm						
Part No. <a href="#">PE3C5833</a>	Cable Dia.			Attn. @ 1 GHz	Power @ 1 GHz	67
1 piece price shown. See web or call for volume pricing.	0.28" dia.					
12"	24"	36"	48"	60"	50CM	Custom Len.
\$98.79	\$104.93	\$109.52	\$115.57	\$121.62	\$102.73	See Web
SPP-250-LLPL Coax, 50 Ohm						
Part No. <a href="#">PE3C6174</a>	Cable Dia.			Attn. @ 1 GHz	Power @ 1 GHz	68
1 piece price shown. See web or call for volume pricing.	0.28" dia.			5.5 dB/100ft	650 W	
12"	24"	36"	48"	60"	50CM	Custom Len.
\$70.73	\$76.87	\$83.00	\$89.14	\$95.27	\$74.68	See Web
SPP-250-LLPL Coax, 50 Ohm						
Part No. <a href="#">PE3C6229</a>	Cable Dia.			Attn. @ 1 GHz	Power @ 1 GHz	69
1 piece price shown. See web or call for volume pricing.	0.28" dia.			5.5 dB/100ft	650 W	
12"	24"	36"	48"	60"	50CM	Custom Len.
\$70.73	\$76.87	\$83.00	\$89.14	\$95.27	\$74.67	See Web
<b>4.3-10 MALE TO 4.3-10 FEMALE BULKHEAD</b>						
						
SEE MOUNTING HOLE SECTION ON PAGE 409						
<b>Low PIM Corrugated Cable Assemblies</b>						
PE-1/4SFHC Coax, 50 Ohm						
Part No. <a href="#">PE3C7829</a>	Cable Dia.			Attn. @ 1 GHz	Power @ 1 GHz	70
1 piece price shown. See web or call for volume pricing.	0.303" dia.			5.85 dB/100ft		
12"	24"	36"	48"	60"	50CM	Custom Len.
\$72.41	\$76.13	\$79.86	\$83.59	\$87.31	\$74.79	See Web

\*Coax Performance at 1 GHz Notes: Cable assembly max frequency may be lower than connector or coax max frequency



For our complete selection of cable assemblies, please visit our website

4.3-10 MALE TO 4.3-10 FEMALE 4 HOLE FLANGE						
SEE MOUNTING HOLE SECTION ON PAGE 409						
Low PIM Corrugated Cable Assemblies						
PE-1/4SFHC Coax, 50 Ohm						
Part No.	Cable Dia.	Attn. @ 1 GHz	Power @ 1 GHz			
Part No. <b>PE3C7830</b>	Cable Dia.	Attn. @ 1 GHz	Power @ 1 GHz			
1 piece price shown. See web or call for volume pricing.	0.303" dia.	5.85 dB/100ft	650 W			
12"	18"	24"	36"	48"	60"	Custom Len.
\$69.11	Call	\$72.84	\$76.57	\$80.29	\$84.02	See Web
4.3-10 MALE TO 7/16 DIN MALE						
Corrugated Cable Assemblies						
SPP-250-LLPL Coax, 50 Ohm						
Part No.	Cable Dia.	Attn. @ 1 GHz	Power @ 1 GHz			
Part No. <b>PE3C4135</b>	Cable Dia.	Attn. @ 1 GHz	Power @ 1 GHz			
1 piece price shown. See web or call for volume pricing.	0.28" dia.	5.5 dB/100ft	650 W			
12"	24"	36"	48"	60"	50CM	Custom Len.
\$104.15	\$108.74	\$114.79	\$120.84	\$126.89	\$106.57	See Web
Low PIM Corrugated Cable Assemblies						
SPP-250-LLPL Coax, 50 Ohm						
Part No.	Cable Dia.	Attn. @ 1 GHz	Power @ 1 GHz			
Part No. <b>PE3C6184</b>	Cable Dia.	Attn. @ 1 GHz	Power @ 1 GHz			
1 piece price shown. See web or call for volume pricing.	0.28" dia.	5.5 dB/100ft	650 W			
12"	24"	36"	48"	60"	50CM	Custom Len.
\$66.80	\$72.94	\$79.07	\$85.21	\$91.34	\$70.71	See Web
Part No. <b>PE3C6186</b>	Cable Dia.	Attn. @ 1 GHz	Power @ 1 GHz			
1 piece price shown. See web or call for volume pricing.	0.28" dia.	5.5 dB/100ft	650 W			
12"	24"	36"	48"	60"	50CM	Custom Len.
\$66.80	\$72.94	\$79.07	\$85.21	\$91.34	\$70.71	See Web
SPP-500-LLPL Coax, 50 Ohm						
Part No.	Cable Dia.	Attn. @ 1 GHz	Power @ 1 GHz			
Part No. <b>PE3C6365</b>	Cable Dia.	Attn. @ 1 GHz	Power @ 1 GHz			
1 piece price shown. See web or call for volume pricing.	0.5" dia.					
12"	24"	36"	48"	60"	50CM	Custom Len.
\$60.87	\$71.16	\$81.44	\$91.72	\$101.99	\$67.45	See Web
SPO-375 Coax, 50 Ohm						
Part No.	Cable Dia.	Attn. @ 1 GHz	Power @ 1 GHz			
Part No. <b>PE3C6500</b>	Cable Dia.	Attn. @ 1 GHz	Power @ 1 GHz			
1 piece price shown. See web or call for volume pricing.	0.43" dia.					
12"	24"	36"	48"	60"	50CM	Custom Len.
\$76.86	\$80.01	\$83.18	\$86.33	\$89.47	\$78.89	See Web
SPF-375 Coax, 50 Ohm						
Part No.	Cable Dia.	Attn. @ 1 GHz	Power @ 1 GHz			
Part No. <b>PE3C6506</b>	Cable Dia.	Attn. @ 1 GHz	Power @ 1 GHz			
1 piece price shown. See web or call for volume pricing.	0.435" dia.					
12"	24"	36"	48"	60"	50CM	Custom Len.
\$76.86	\$81.10	\$85.34	\$89.58	\$93.81	\$79.59	See Web
SPO-500 Coax, 50 Ohm						
Part No.	Cable Dia.	Attn. @ 1 GHz	Power @ 1 GHz			
Part No. <b>PE3C6512</b>	Cable Dia.	Attn. @ 1 GHz	Power @ 1 GHz			
1 piece price shown. See web or call for volume pricing.	0.53" dia.					
12"	24"	36"	48"	60"	50CM	Custom Len.
\$54.17	\$56.76	\$60.18	\$62.94	\$66.01	\$55.66	See Web
SPF-500 Coax, 50 Ohm						
Part No.	Cable Dia.	Attn. @ 1 GHz	Power @ 1 GHz			
Part No. <b>PE3C6515</b>	Cable Dia.	Attn. @ 1 GHz	Power @ 1 GHz			
1 piece price shown. See web or call for volume pricing.	0.545" dia.					
12"	24"	36"	48"	60"	50CM	Custom Len.
\$54.98	\$59.37	\$63.76	\$68.14	\$72.53	\$57.78	See Web
4.3-10 MALE TO 7/16 DIN MALE RIGHT ANGLE						
Low PIM Corrugated Cable Assemblies						
SPP-250-LLPL Coax, 50 Ohm						
Part No.	Cable Dia.	Attn. @ 1 GHz	Power @ 1 GHz			
Part No. <b>PE3C6236</b>	Cable Dia.	Attn. @ 1 GHz	Power @ 1 GHz			
1 piece price shown. See web or call for volume pricing.	0.28" dia.	5.5 dB/100ft	650 W			
12"	24"	36"	48"	60"	50CM	Custom Len.
\$72.05	\$78.19	\$84.33	\$90.47	\$96.60	\$75.97	See Web
Part No. <b>PE3C6238</b>	Cable Dia.	Attn. @ 1 GHz	Power @ 1 GHz			
1 piece price shown. See web or call for volume pricing.	0.28" dia.	5.5 dB/100ft	650 W			
12"	24"	36"	48"	60"	50CM	Custom Len.
\$72.05	\$78.19	\$84.33	\$90.47	\$96.60	\$75.97	See Web
4.3-10 MALE TO 7/16 DIN FEMALE						
Low PIM Corrugated Cable Assemblies						
SPP-250-LLPL Coax, 50 Ohm						
Part No.	Cable Dia.	Attn. @ 1 GHz	Power @ 1 GHz			
Part No. <b>PE3C5853</b>	Cable Dia.	Attn. @ 1 GHz	Power @ 1 GHz			
1 piece price shown. See web or call for volume pricing.	0.28" dia.					
12"	24"	36"	48"	60"	50CM	Custom Len.
\$98.79	\$104.93	\$109.52	\$115.57	\$121.62	\$102.73	See Web
Part No. <b>PE3C6230</b>	Cable Dia.	Attn. @ 1 GHz	Power @ 1 GHz			
1 piece price shown. See web or call for volume pricing.	0.28" dia.	5.5 dB/100ft	650 W			
12"	24"	36"	48"	60"	50CM	Custom Len.
\$66.80	\$72.94	\$79.07	\$85.21	\$91.34	\$70.71	See Web

Part No. <b>PE3C6232</b>	Cable Dia.	Attn. @ 1 GHz	Power @ 1 GHz			
1 piece price shown. See web or call for volume pricing.	0.28" dia.	5.5 dB/100ft	650 W			
12"	24"	36"	48"	60"	50CM	Custom Len.
\$66.80	\$72.94	\$79.07	\$85.21	\$91.34	\$70.71	See Web
SPP-375-LLPL Coax, 50 Ohm						
Part No.	Cable Dia.	Attn. @ 1 GHz	Power @ 1 GHz			
Part No. <b>PE3C6381</b>	Cable Dia.	Attn. @ 1 GHz	Power @ 1 GHz			
1 piece price shown. See web or call for volume pricing.	0.402" dia.					
12"	24"	36"	48"	60"	50CM	Custom Len.
\$59.90	Call	\$75.89	\$83.88	\$91.88	\$65.02	See Web
SPO-375 Coax, 50 Ohm						
Part No.	Cable Dia.	Attn. @ 1 GHz	Power @ 1 GHz			
Part No. <b>PE3C6501</b>	Cable Dia.	Attn. @ 1 GHz	Power @ 1 GHz			
1 piece price shown. See web or call for volume pricing.	0.43" dia.					
12"	24"	36"	48"	60"	50CM	Custom Len.
\$71.61	\$74.76	\$77.92	\$81.07	\$84.22	\$73.63	See Web
SPF-375 Coax, 50 Ohm						
Part No.	Cable Dia.	Attn. @ 1 GHz	Power @ 1 GHz			
Part No. <b>PE3C6507</b>	Cable Dia.	Attn. @ 1 GHz	Power @ 1 GHz			
1 piece price shown. See web or call for volume pricing.	0.435" dia.					
12"	24"	36"	48"	60"	50CM	Custom Len.
\$71.61	\$75.85	\$80.09	\$84.33	\$88.55	\$74.33	See Web
4.3-10 MALE TO N MALE						
Low Loss Flexible Cable Assemblies						
LMR-240-UF Coax, 50 Ohm						
Part No.	Cable Dia.	Attn. @ 1 GHz	Power @ 1 GHz			
Part No. <b>PE3C7907</b>	Cable Dia.	Attn. @ 1 GHz	Power @ 1 GHz			
1 piece price shown. See web or call for volume pricing.	0.24" dia.	9.19 dB/100ft	650 W			
12"	24"	36"	48"	60"	50CM	Custom Len.
\$54.29	\$54.96	\$56.12	\$57.29	\$58.45	\$53.86	See Web
Low PIM Corrugated Cable Assemblies						
SPP-250-LLPL Coax, 50 Ohm						
Part No.	Cable Dia.	Attn. @ 1 GHz	Power @ 1 GHz			
Part No. <b>PE3C6221</b>	Cable Dia.	Attn. @ 1 GHz	Power @ 1 GHz			
1 piece price shown. See web or call for volume pricing.	0.28" dia.	5.5 dB/100ft	650 W			
12"	24"	36"	48"	60"	50CM	Custom Len.
\$64.18	\$70.31	\$76.45	\$82.58	\$88.72	\$68.09	See Web
Part No. <b>PE3C6223</b>	Cable Dia.	Attn. @ 1 GHz	Power @ 1 GHz			
1 piece price shown. See web or call for volume pricing.	0.28" dia.	5.5 dB/100ft	650 W			
12"	24"	36"	48"	60"	50CM	Custom Len.
\$64.18	\$70.31	\$76.45	\$82.58	\$88.72	\$68.09	See Web
SPP-375-LLPL Coax, 50 Ohm						
Part No.	Cable Dia.	Attn. @ 1 GHz	Power @ 1 GHz			
Part No. <b>PE3C6382</b>	Cable Dia.	Attn. @ 1 GHz	Power @ 1 GHz			
1 piece price shown. See web or call for volume pricing.	0.402" dia.					
12"	24"	36"	48"	60"	50CM	Custom Len.
\$63.84	\$71.82	\$79.82	\$87.82	\$95.81	\$68.95	See Web
4.3-10 MALE TO N MALE RIGHT ANGLE						
Low PIM Corrugated Cable Assemblies						
SPP-250-LLPL Coax, 50 Ohm						
Part No.	Cable Dia.	Attn. @ 1 GHz	Power @ 1 GHz			
Part No. <b>PE3C6228</b>	Cable Dia.	Attn. @ 1 GHz	Power @ 1 GHz			
1 piece price shown. See web or call for volume pricing.	0.28" dia.	5.5 dB/100ft	650 W			
12"	24"	36"	48"	60"	50CM	Custom Len.
\$66.80	\$72.94	\$79.07	\$85.21	\$91.34	\$70.71	See Web
Part No. <b>PE3C6243</b>	Cable Dia.	Attn. @ 1 GHz	Power @ 1 GHz			
1 piece price shown. See web or call for volume pricing.	0.28" dia.	5.5 dB/100ft	650 W			
12"	24"	36"	48"	60"	50CM	Custom Len.
\$66.80	\$72.94	\$79.07	\$85.21	\$91.34	\$70.71	See Web
4.3-10 MALE TO N FEMALE						
Low PIM Corrugated Cable Assemblies						
SPP-250-LLPL Coax, 50 Ohm						
Part No.	Cable Dia.	Attn. @ 1 GHz	Power @ 1 GHz			
Part No. <b>PE3C6220</b>	Cable Dia.	Attn. @ 1 GHz	Power @ 1 GHz			
1 piece price shown. See web or call for volume pricing.	0.28" dia.	5.5 dB/100ft	650 W			
12"	24"	36"	48"	60"	50CM	Custom Len.
\$64.18	\$70.31	\$76.45	\$82.58	\$88.72	\$68.09	See Web
Part No. <b>PE3C6225</b>	Cable Dia.	Attn. @ 1 GHz	Power @ 1 GHz			
1 piece price shown. See web or call for volume pricing.	0.28" dia.	5.5 dB/100ft	650 W			
12"	24"	36"	48"	60"	50CM	Custom Len.
\$64.18	\$70.31	\$76.45	\$82.58	\$88.72	\$68.09	See Web
SPO-375 Coax, 50 Ohm						
Part No.	Cable Dia.	Attn. @ 1 GHz	Power @ 1 GHz			
Part No. <b>PE3C6499</b>	Cable Dia.	Attn. @ 1 GHz	Power @ 1 GHz			
1 piece price shown. See web or call for volume pricing.	0.43" dia.					
12"	24"	36"	48"	60"	50CM	Custom Len.
\$71.61	\$74.76	\$77.92	\$81.07	\$84.22	\$73.63	See Web
SPF-375 Coax, 50 Ohm						
Part No.	Cable Dia.	Attn. @ 1 GHz	Power @ 1 GHz			
Part No. <b>PE3C6505</b>	Cable Dia.	Attn. @ 1 GHz	Power @ 1 GHz			
1 piece price shown. See web or call for volume pricing.	0.435" dia.					
12"	24"	36"	48"	60"	50CM	Custom Len.
\$71.61	\$75.85	\$80.09	\$84.33	\$88.55	\$74.33	See Web

Cable Assemblies

See Our Website For Current Pricing & Real-Time Stock Availability!

For Custom Lengths, Metric Lengths or Special Configurations, Please call (949) 261-1920



Technical Support  
+1 (949) 261-1920



Same-Day Shipping,  
Even Custom Cable Assemblies



For our complete selection of cable assemblies, please visit our website

**4.3-10 MALE TO N FEMALE BULKHEAD**

SEE MOUNTING HOLE SECTION ON PAGE 409

**Low PIM Corrugated Cable Assemblies**

SPP-250-LLPL Coax, 50 Ohm

Part No. <a href="#">PE3C6219</a>	Cable Dia.	Attn. @ 1 GHz	Power @ 1 GHz
1 piece price shown. See web or call for volume pricing.	0.28" dia.	5.5 dB/100ft	650 W
12" 24" 36" 48"	60"	50CM	Custom Len.
\$64.18 \$70.31 \$76.45 \$82.58	\$88.72	\$68.09	See Web

Part No. <a href="#">PE3C6226</a>	Cable Dia.	Attn. @ 1 GHz	Power @ 1 GHz
1 piece price shown. See web or call for volume pricing.	0.28" dia.	5.5 dB/100ft	650 W
12" 24" 36" 48"	60"	50CM	Custom Len.
\$64.18 \$70.31 \$76.45 \$82.58	\$88.72	\$68.09	See Web

**4.3-10 MALE TO QMA MALE**

**Corrugated Cable Assemblies**

SPP-250-LLPL Coax, 50 Ohm

Part No. <a href="#">PE3C5865</a>	Cable Dia.	Attn. @ 1 GHz	Power @ 1 GHz
1 piece price shown. See web or call for volume pricing.	0.28" dia.	5.5 dB/100ft	650 W
12" 24" 36" 48"	60"	50CM	Custom Len.
\$86.90 \$93.04 \$99.17 \$105.29	\$109.88	\$90.82	See Web

**4.3-10 MALE TO QMA MALE RIGHT ANGLE**

**Corrugated Cable Assemblies**

SPP-250-LLPL Coax, 50 Ohm

Part No. <a href="#">PE3C5871</a>	Cable Dia.	Attn. @ 1 GHz	Power @ 1 GHz
1 piece price shown. See web or call for volume pricing.	0.28" dia.	5.5 dB/100ft	650 W
12" 24" 36" 48"	60"	50CM	Custom Len.
\$89.29 \$95.42 \$101.56 \$107.69	\$112.25	\$93.21	See Web

**4.3-10 MALE TO QMA FEMALE**

**Low PIM Corrugated Cable Assemblies**

SPP-250-LLPL Coax, 50 Ohm

Part No. <a href="#">PE3C5859</a>	Cable Dia.	Attn. @ 1 GHz	Power @ 1 GHz
1 piece price shown. See web or call for volume pricing.	0.28" dia.	5.5 dB/100ft	650 W
12" 24" 36" 48"	60"	50CM	Custom Len.
\$82.94 \$89.07 \$95.21 \$101.34	\$107.48	\$86.88	See Web

**4.3-10 MALE TO SMA MALE**

**Low PIM Corrugated Cable Assemblies**

SPP-250-LLPL Coax, 50 Ohm

Part No. <a href="#">PE3C5884</a>	Cable Dia.	Attn. @ 1 GHz	Power @ 1 GHz
1 piece price shown. See web or call for volume pricing.	0.28" dia.	5.5 dB/100ft	650 W
12" 24" 36" 48"	60"	50CM	Custom Len.
\$78.96 \$85.09 \$91.22 \$97.36	\$103.49	\$82.88	See Web

Part No. <a href="#">PE3C6246</a>	Cable Dia.	Attn. @ 1 GHz	Power @ 1 GHz
1 piece price shown. See web or call for volume pricing.	0.28" dia.	5.5 dB/100ft	650 W
12" 24" 36" 48"	60"	50CM	Custom Len.
\$58.92 \$65.05 \$71.19 \$77.32	\$83.46	\$62.84	See Web

Part No. <a href="#">PE3C6247</a>	Cable Dia.	Attn. @ 1 GHz	Power @ 1 GHz
1 piece price shown. See web or call for volume pricing.	0.28" dia.	5.5 dB/100ft	650 W
12" 24" 36" 48"	60"	50CM	Custom Len.
\$58.92 \$65.05 \$71.19 \$77.32	\$83.46	\$62.84	See Web

**4.3-10 MALE TO SMA MALE RIGHT ANGLE**

**Corrugated Cable Assemblies**

SPP-250-LLPL Coax, 50 Ohm

Part No. <a href="#">PE3C5889</a>	Cable Dia.	Attn. @ 1 GHz	Power @ 1 GHz
1 piece price shown. See web or call for volume pricing.	0.28" dia.	5.5 dB/100ft	650 W
12" 24" 36" 48"	60"	50CM	Custom Len.
\$80.55 \$86.69 \$92.82 \$98.95	\$105.10	\$84.48	See Web

**Low PIM Corrugated Cable Assemblies**

SPP-250-LLPL Coax, 50 Ohm

Part No. <a href="#">PE3C6248</a>	Cable Dia.	Attn. @ 1 GHz	Power @ 1 GHz
1 piece price shown. See web or call for volume pricing.	0.28" dia.	5.5 dB/100ft	650 W
12" 24" 36" 48"	60"	50CM	Custom Len.
\$64.18 \$70.31 \$76.45 \$82.58	\$88.72	\$68.09	See Web

Part No. <a href="#">PE3C6250</a>	Cable Dia.	Attn. @ 1 GHz	Power @ 1 GHz
1 piece price shown. See web or call for volume pricing.	0.28" dia.	5.5 dB/100ft	650 W
12" 24" 36" 48"	60"	50CM	Custom Len.
\$64.18 \$70.31 \$76.45 \$82.58	\$88.72	\$68.09	See Web

**4.3-10 MALE TO SMA FEMALE**

**Corrugated Cable Assemblies**

SPP-250-LLPL Coax, 50 Ohm

Part No. <a href="#">PE3C5878</a>	Cable Dia.	Attn. @ 1 GHz	Power @ 1 GHz
1 piece price shown. See web or call for volume pricing.	0.28" dia.	5.5 dB/100ft	650 W
12" 24" 36" 48"	60"	50CM	Custom Len.
\$79.75 \$85.89 \$92.02 \$98.16	\$104.29	\$83.68	See Web

**4.3-10 MALE TO NEX10 MALE**

**Low PIM Corrugated Cable Assemblies**

SPP-250-LLPL Coax, 50 Ohm

Part No. <a href="#">PE3C6261</a>	Cable Dia.	Attn. @ 1 GHz	Power @ 1 GHz
1 piece price shown. See web or call for volume pricing.	0.28" dia.	5.5 dB/100ft	650 W
12" 24" 36" 48"	60"	50CM	Custom Len.
\$72.74 \$78.88 \$85.01 \$91.15	\$97.28	\$76.66	See Web

Part No. <a href="#">PE3C6263</a>	Cable Dia.	Attn. @ 1 GHz	Power @ 1 GHz
1 piece price shown. See web or call for volume pricing.	0.28" dia.	5.5 dB/100ft	650 W
12" 24" 36" 48"	60"	50CM	Custom Len.
\$72.74 \$78.88 \$85.01 \$91.15	\$97.28	\$76.66	See Web

**4.3-10 MALE RIGHT ANGLE TO 4.3-10 MALE**

**Low PIM Corrugated Cable Assemblies**

SPP-250-LLPL Coax, 50 Ohm

Part No. <a href="#">PE3C4147</a>	Cable Dia.	Attn. @ 1 GHz	Power @ 1 GHz
1 piece price shown. See web or call for volume pricing.	0.28" dia.	5.5 dB/100ft	650 W
12" 24" 36" 48"	60"	50CM	Custom Len.
\$107.77 \$113.82 \$119.88 \$125.93	\$131.98	\$111.66	See Web

**4.3-10 MALE RIGHT ANGLE TO 4.3-10 MALE RIGHT ANGLE**

**Low PIM Corrugated Cable Assemblies**

PE-1/4SFHC Coax, 50 Ohm

Part No. <a href="#">PE3C7831</a>	Cable Dia.	Attn. @ 1 GHz	Power @ 1 GHz
1 piece price shown. See web or call for volume pricing.	0.303" dia.	5.85 dB/100ft	650 W
12" 24" 36" 48"	60"	50CM	Custom Len.
\$74.61 \$78.34 \$82.06 \$85.79	\$89.52	\$77.00	See Web

Part No. <a href="#">PE3C4146</a>	Cable Dia.	Attn. @ 1 GHz	Power @ 1 GHz
1 piece price shown. See web or call for volume pricing.	0.28" dia.	5.5 dB/100ft	650 W
12" 24" 36" 48"	60"	50CM	Custom Len.
\$115.38 \$121.43 \$127.47 \$133.52	\$139.57	\$119.25	See Web

Part No. <a href="#">PE3C6177</a>	Cable Dia.	Attn. @ 1 GHz	Power @ 1 GHz
1 piece price shown. See web or call for volume pricing.	0.28" dia.	5.5 dB/100ft	650 W
12" 24" 36" 48"	60"	50CM	Custom Len.
\$73.37 \$79.50 \$85.64 \$91.77	\$97.91	\$77.29	See Web

Part No. <a href="#">PE3C6339</a>	Cable Dia.	Attn. @ 1 GHz	Power @ 1 GHz
1 piece price shown. See web or call for volume pricing.	0.303" dia.	5.85 dB/100ft	650 W
12" 24" 36" 48"	60"	50CM	Custom Len.
\$69.51 \$71.80 \$74.09 \$76.38	\$78.66	\$70.98	See Web

Part No. <a href="#">PE3C6354</a>	Cable Dia.	Attn. @ 1 GHz	Power @ 1 GHz
1 piece price shown. See web or call for volume pricing.	0.303" dia.	5.85 dB/100ft	650 W
12" 24" 36" 48"	60"	50CM	Custom Len.
\$70.26 \$73.26 \$76.27 \$79.30	\$82.31	\$72.18	See Web

**4.3-10 MALE RIGHT ANGLE TO 4.3-10 FEMALE**

**Low PIM Corrugated Cable Assemblies**

PE-1/4SFHC Coax, 50 Ohm

Part No. <a href="#">PE3C7832</a>	Cable Dia.	Attn. @ 1 GHz	Power @ 1 GHz
1 piece price shown. See web or call for volume pricing.	0.303" dia.	5.85 dB/100ft	650 W
12" 24" 36" 48"	60"	50CM	Custom Len.
\$73.51 \$77.24 \$80.96 \$84.69	\$88.41	\$75.90	See Web

Part No. <a href="#">PE3C6227</a>	Cable Dia.	Attn. @ 1 GHz	Power @ 1 GHz
1 piece price shown. See web or call for volume pricing.	0.28" dia.	5.5 dB/100ft	650 W
12" 24" 36" 48"	60"	50CM	Custom Len.
\$72.05 \$78.19 \$84.33 \$90.47	\$96.60	\$75.97	See Web

Cable Assemblies See Our Website For Current Pricing & Real-Time Stock Availability!

\*Coax Performance at 1 GHz Notes: Cable assembly max frequency may be lower than connector or coax max frequency

For our complete selection of cable assemblies, please visit our website

SPO-250 Coax, 50 Ohm						
Part No. <a href="#">PE3C6332</a>	Cable Dia.			Attn. @ 1 GHz	Power @ 1 GHz	
1 piece price shown. See web or call for volume pricing.	0.303" dia.					21
12"	24"	36"	48"	60"	50CM	Custom Len.
\$68.21	\$70.50	\$72.78	\$75.05	\$77.34	\$69.68	See Web

SPF-250 Coax, 50 Ohm						
Part No. <a href="#">PE3C6349</a>	Cable Dia.			Attn. @ 1 GHz	Power @ 1 GHz	
1 piece price shown. See web or call for volume pricing.	0.303" dia.					22
12"	24"	36"	48"	60"	50CM	Custom Len.
\$68.93	\$71.95	\$74.97	\$77.98	\$81.00	\$70.87	See Web

**4.3-10 MALE RIGHT ANGLE TO 4.3-10 FEMALE BULKHEAD**

SEE MOUNTING HOLE SECTION ON PAGE 409

**Low PIM Corrugated Cable Assemblies**

PE-1/4SFHC Coax, 50 Ohm						
Part No. <a href="#">PE3C7833</a>	Cable Dia.			Attn. @ 1 GHz	Power @ 1 GHz	
1 piece price shown. See web or call for volume pricing.	0.303" dia.			5.85 dB/100ft		23
12"	24"	36"	48"	60"	50CM	Custom Len.
\$74.61	\$78.34	\$82.06	\$85.79	\$89.52	\$77.00	See Web

**4.3-10 MALE RIGHT ANGLE TO 4.3-10 FEMALE 4 HOLE FLANGE**

SEE MOUNTING HOLE SECTION ON PAGE 409

**Low PIM Corrugated Cable Assemblies**

PE-1/4SFHC Coax, 50 Ohm						
Part No. <a href="#">PE3C7834</a>	Cable Dia.			Attn. @ 1 GHz	Power @ 1 GHz	
1 piece price shown. See web or call for volume pricing.	0.303" dia.			5.85 dB/100ft		24
12"	24"	36"	48"	60"	50CM	Custom Len.
\$71.31	\$75.03	\$78.76	\$82.50	\$86.22	\$73.69	See Web

**4.3-10 MALE RIGHT ANGLE TO 7/16 DIN MALE**

**Low PIM Corrugated Cable Assemblies**

SPP-250-LLPL Coax, 50 Ohm						
Part No. <a href="#">PE3C6185</a>	Cable Dia.			Attn. @ 1 GHz	Power @ 1 GHz	
1 piece price shown. See web or call for volume pricing.	0.28" dia.			5.5 dB/100ft	650 W	25
12"	24"	36"	48"	60"	50CM	Custom Len.
\$68.12	\$74.24	\$80.38	\$86.51	\$92.65	\$72.03	See Web

SPO-250 Coax, 50 Ohm						
Part No. <a href="#">PE3C6340</a>	Cable Dia.			Attn. @ 1 GHz	Power @ 1 GHz	
1 piece price shown. See web or call for volume pricing.	0.303" dia.					26
12"	24"	36"	48"	60"	50CM	Custom Len.
\$64.26	\$66.54	\$68.83	\$71.12	\$73.41	\$65.72	See Web

SPF-250 Coax, 50 Ohm						
Part No. <a href="#">PE3C6355</a>	Cable Dia.			Attn. @ 1 GHz	Power @ 1 GHz	
1 piece price shown. See web or call for volume pricing.	0.303" dia.					27
12"	24"	36"	48"	60"	50CM	Custom Len.
\$65.00	\$68.01	\$71.03	\$74.05	\$77.06	\$66.92	See Web

**4.3-10 MALE RIGHT ANGLE TO 7/16 DIN MALE RIGHT ANGLE**

**Low PIM Corrugated Cable Assemblies**

SPP-250-LLPL Coax, 50 Ohm						
Part No. <a href="#">PE3C6237</a>	Cable Dia.			Attn. @ 1 GHz	Power @ 1 GHz	
1 piece price shown. See web or call for volume pricing.	0.28" dia.			5.5 dB/100ft	650 W	28
12"	24"	36"	48"	60"	50CM	Custom Len.
\$73.37	\$79.50	\$85.64	\$91.77	\$97.91	\$77.29	See Web

**4.3-10 MALE RIGHT ANGLE TO 7/16 DIN FEMALE**

**Low PIM Corrugated Cable Assemblies**

SPP-250-LLPL Coax, 50 Ohm						
Part No. <a href="#">PE3C6231</a>	Cable Dia.			Attn. @ 1 GHz	Power @ 1 GHz	
1 piece price shown. See web or call for volume pricing.	0.28" dia.			5.5 dB/100ft	650 W	29
12"	24"	36"	48"	60"	50CM	Custom Len.
\$68.12	\$74.24	\$80.38	\$86.51	\$92.65	\$72.03	See Web

**4.3-10 MALE RIGHT ANGLE TO N MALE**

**Low PIM Corrugated Cable Assemblies**

SPP-250-LLPL Coax, 50 Ohm						
Part No. <a href="#">PE3C6222</a>	Cable Dia.			Attn. @ 1 GHz	Power @ 1 GHz	
1 piece price shown. See web or call for volume pricing.	0.28" dia.			5.5 dB/100ft	650 W	30
12"	24"	36"	48"	60"	50CM	Custom Len.
\$65.50	\$71.62	\$77.75	\$83.89	\$90.02	\$69.41	See Web

**4.3-10 MALE RIGHT ANGLE TO N MALE RIGHT ANGLE**

**Low PIM Corrugated Cable Assemblies**

SPP-250-LLPL Coax, 50 Ohm						
Part No. <a href="#">PE3C6242</a>	Cable Dia.			Attn. @ 1 GHz	Power @ 1 GHz	
1 piece price shown. See web or call for volume pricing.	0.28" dia.			5.5 dB/100ft	650 W	31
12"	24"	36"	48"	60"	50CM	Custom Len.
\$68.12	\$74.24	\$80.38	\$86.51	\$92.65	\$72.03	See Web

**4.3-10 MALE RIGHT ANGLE TO N FEMALE BULKHEAD**

SEE MOUNTING HOLE SECTION ON PAGE 409

**Low PIM Corrugated Cable Assemblies**

SPP-250-LLPL Coax, 50 Ohm						
Part No. <a href="#">PE3C6239</a>	Cable Dia.			Attn. @ 1 GHz	Power @ 1 GHz	
1 piece price shown. See web or call for volume pricing.	0.28" dia.			5.5 dB/100ft	650 W	32
12"	24"	36"	48"	60"	50CM	Custom Len.
\$65.50	\$71.62	\$77.75	\$83.89	\$90.02	\$69.41	See Web

**4.3-10 MALE RIGHT ANGLE TO SMA MALE**

**Low PIM Corrugated Cable Assemblies**

SPP-250-LLPL Coax, 50 Ohm						
Part No. <a href="#">PE3C6245</a>	Cable Dia.			Attn. @ 1 GHz	Power @ 1 GHz	
1 piece price shown. See web or call for volume pricing.	0.28" dia.			5.5 dB/100ft	650 W	33
12"	24"	36"	48"	60"	50CM	Custom Len.
\$60.24	\$66.37	\$72.49	\$78.63	\$84.76	\$64.16	See Web

**4.3-10 MALE RIGHT ANGLE TO SMA MALE RIGHT ANGLE**

**Low PIM Corrugated Cable Assemblies**

SPP-250-LLPL Coax, 50 Ohm						
Part No. <a href="#">PE3C6249</a>	Cable Dia.			Attn. @ 1 GHz	Power @ 1 GHz	
1 piece price shown. See web or call for volume pricing.	0.28" dia.			5.5 dB/100ft	650 W	34
12"	24"	36"	48"	60"	50CM	Custom Len.
\$65.50	\$71.62	\$77.75	\$83.89	\$90.02	\$69.41	See Web

**4.3-10 MALE RIGHT ANGLE TO NEX10 MALE**

**Low PIM Corrugated Cable Assemblies**

SPP-250-LLPL Coax, 50 Ohm						
Part No. <a href="#">PE3C6262</a>	Cable Dia.			Attn. @ 1 GHz	Power @ 1 GHz	
1 piece price shown. See web or call for volume pricing.	0.28" dia.			5.5 dB/100ft	650 W	35
12"	24"	36"	48"	60"	50CM	Custom Len.
\$74.06	\$80.19	\$86.33	\$92.46	\$98.60	\$77.97	See Web

**4.3-10 FEMALE TO 4.3-10 FEMALE**

**Corrugated Cable Assemblies**

SPO-250 Coax, 50 Ohm						
Part No. <a href="#">PE3C6331</a>	Cable Dia.			Attn. @ 1 GHz	Power @ 1 GHz	
1 piece price shown. See web or call for volume pricing.	0.303" dia.					36
12"	24"	36"	48"	60"	50CM	Custom Len.
\$66.89	\$69.18	\$71.46	\$73.75	\$76.04	\$68.35	See Web

**Low PIM Corrugated Cable Assemblies**

SPF-250 Coax, 50 Ohm						
Part No. <a href="#">PE3C6348</a>	Cable Dia.			Attn. @ 1 GHz	Power @ 1 GHz	
1 piece price shown. See web or call for volume pricing.	0.303" dia.					37
12"	24"	36"	48"	60"	50CM	Custom Len.
\$67.62	\$70.64	\$73.65	\$76.67	\$79.69	\$69.55	See Web

**4.3-10 FEMALE TO 7/16 DIN MALE**

**Low PIM Corrugated Cable Assemblies**

SPP-250-LLPL Coax, 50 Ohm						
Part No. <a href="#">PE3C6233</a>	Cable Dia.			Attn. @ 1 GHz	Power @ 1 GHz	
1 piece price shown. See web or call for volume pricing.	0.28" dia.			5.5 dB/100ft	650 W	38
12"	24"	36"	48"	60"	50CM	Custom Len.
\$66.80	\$72.94	\$79.07	\$85.21	\$91.34	\$70.71	See Web

SPO-250 Coax, 50 Ohm						
Part No. <a href="#">PE3C6333</a>	Cable Dia.			Attn. @ 1 GHz	Power @ 1 GHz	
1 piece price shown. See web or call for volume pricing.	0.303" dia.					39
12"	24"	36"	48"	60"	50CM	Custom Len.
\$62.96	\$65.24	\$67.52	\$69.81	\$72.09	\$64.42	See Web

Cable Assemblies

See Our Website For Current Pricing & Real-Time Stock Availability!

For Custom Lengths, Metric Lengths or Special Configurations, Please call (949) 261-1920

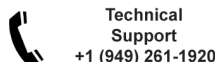

For our complete selection of cable assemblies, please visit our website

Cable Assemblies  
See Our Website For Current Pricing & Real-Time Stock Availability!

SPF-250 Coax, 50 Ohm						
Part No. <a href="#">PE3C6350</a>	Cable Dia.			Attn. @ 1 GHz	Power @ 1 GHz	
1 piece price shown. See web or call for volume pricing.						
12"	24"	36"	48"	60"	50CM	Custom Len.
\$63.68	\$66.71	\$69.72	\$72.73	\$75.76	\$65.61	See Web

**4.3-10 FEMALE TO 7/16 DIN MALE RIGHT ANGLE**



**Low PIM Corrugated Cable Assemblies**

SPP-250-LLPL Coax, 50 Ohm						
Part No. <a href="#">PE3C6235</a>	Cable Dia.			Attn. @ 1 GHz	Power @ 1 GHz	
1 piece price shown. See web or call for volume pricing.						
12"	24"	36"	48"	60"	50CM	Custom Len.
\$72.05	\$78.19	\$84.33	\$90.47	\$96.60	\$75.97	See Web

**4.3-10 FEMALE TO N MALE**



**Low PIM Corrugated Cable Assemblies**

SPP-250-LLPL Coax, 50 Ohm						
Part No. <a href="#">PE3C5837</a>	Cable Dia.			Attn. @ 1 GHz	Power @ 1 GHz	
1 piece price shown. See web or call for volume pricing.						
12"	24"	36"	48"	60"	50CM	Custom Len.
\$94.82	\$100.95	\$107.09	\$111.64	\$117.69	\$98.74	See Web

SPP-250-LLPL Coax, 50 Ohm						
Part No. <a href="#">PE3C6240</a>	Cable Dia.			Attn. @ 1 GHz	Power @ 1 GHz	
1 piece price shown. See web or call for volume pricing.						
12"	24"	36"	48"	60"	50CM	Custom Len.
\$64.18	\$70.31	\$76.45	\$82.58	\$88.72	\$68.09	See Web

SPO-250 Coax, 50 Ohm						
Part No. <a href="#">PE3C6336</a>	Cable Dia.			Attn. @ 1 GHz	Power @ 1 GHz	
1 piece price shown. See web or call for volume pricing.						
12"	24"	36"	48"	60"	50CM	Custom Len.
\$57.70	\$59.99	\$62.27	\$64.55	\$66.84	\$59.16	See Web

SPF-250 Coax, 50 Ohm						
Part No. <a href="#">PE3C6351</a>	Cable Dia.			Attn. @ 1 GHz	Power @ 1 GHz	
1 piece price shown. See web or call for volume pricing.						
12"	24"	36"	48"	60"	50CM	Custom Len.
\$58.42	\$61.45	\$64.46	\$67.47	\$70.50	\$60.36	See Web

**4.3-10 FEMALE TO N MALE RIGHT ANGLE**



**Low PIM Corrugated Cable Assemblies**

SPP-250-LLPL Coax, 50 Ohm						
Part No. <a href="#">PE3C6241</a>	Cable Dia.			Attn. @ 1 GHz	Power @ 1 GHz	
1 piece price shown. See web or call for volume pricing.						
12"	24"	36"	48"	60"	50CM	Custom Len.
\$66.80	\$72.94	\$79.07	\$85.21	\$91.34	\$70.71	See Web

SPO-250 Coax, 50 Ohm						
Part No. <a href="#">PE3C6337</a>	Cable Dia.			Attn. @ 1 GHz	Power @ 1 GHz	
1 piece price shown. See web or call for volume pricing.						
12"	24"	36"	48"	60"	50CM	Custom Len.
\$62.96	\$65.24	\$67.52	\$69.81	\$72.09	\$64.42	See Web

SPF-250 Coax, 50 Ohm						
Part No. <a href="#">PE3C6352</a>	Cable Dia.			Attn. @ 1 GHz	Power @ 1 GHz	
1 piece price shown. See web or call for volume pricing.						
12"	24"	36"	48"	60"	50CM	Custom Len.
\$63.68	\$66.71	\$69.72	\$72.73	\$75.76	\$65.61	See Web

**4.3-10 FEMALE TO QMA MALE**



**Corrugated Cable Assemblies**

SPP-250-LLPL Coax, 50 Ohm						
Part No. <a href="#">PE3C5838</a>	Cable Dia.			Attn. @ 1 GHz	Power @ 1 GHz	
1 piece price shown. See web or call for volume pricing.						
12"	24"	36"	48"	60"	50CM	Custom Len.
\$90.84	\$96.98	\$103.11	\$107.73	\$113.78	\$94.79	See Web

**4.3-10 FEMALE TO SMA MALE**



**Low PIM Corrugated Cable Assemblies**

SPP-250-LLPL Coax, 50 Ohm						
Part No. <a href="#">PE3C5839</a>	Cable Dia.			Attn. @ 1 GHz	Power @ 1 GHz	
1 piece price shown. See web or call for volume pricing.						
12"	24"	36"	48"	60"	50CM	Custom Len.
\$82.91	\$89.04	\$95.17	\$101.31	\$107.44	\$86.84	See Web

4.3-10 FEMALE TO NEX10 MALE						

Low PIM Corrugated Cable Assemblies						
SPP-250-LLPL Coax, 50 Ohm						
Part No. <a href="#">PE3C6264</a>	Cable Dia.			Attn. @ 1 GHz	Power @ 1 GHz	
1 piece price shown. See web or call for volume pricing.						
12"	24"	36"	48"	60"	50CM	Custom Len.
\$72.74	\$78.88	\$85.01	\$91.15	\$97.28	\$76.66	See Web

SPO-250 Coax, 50 Ohm						
Part No. <a href="#">PE3C6338</a>	Cable Dia.			Attn. @ 1 GHz	Power @ 1 GHz	
1 piece price shown. See web or call for volume pricing.						
12"	24"	36"	48"	60"	50CM	Custom Len.
\$68.89	\$71.18	\$73.47	\$75.76	\$78.02	\$70.36	See Web

SPF-250 Coax, 50 Ohm						
Part No. <a href="#">PE3C6353</a>	Cable Dia.			Attn. @ 1 GHz	Power @ 1 GHz	
1 piece price shown. See web or call for volume pricing.						
12"	24"	36"	48"	60"	50CM	Custom Len.
\$69.62	\$72.63	\$75.65	\$78.67	\$81.69	\$71.55	See Web

7/16 DIN MALE TO 4.3-10 FEMALE						

Corrugated Cable Assemblies						
SPP-250-LLPL Coax, 50 Ohm						
Part No. <a href="#">PE3C5836</a>	Cable Dia.			Attn. @ 1 GHz	Power @ 1 GHz	
1 piece price shown. See web or call for volume pricing.						
12"	24"	36"	48"	60"	50CM	Custom Len.
\$102.76	\$107.38	\$113.43	\$119.48	\$125.53	\$106.68	See Web

7/16 DIN MALE TO 7/16 DIN MALE						

Low Loss Flexible Cable Assemblies						
PE-C195 Coax, 50 Ohm						
Part No. <a href="#">PE37952</a>	Cable Dia.			Attn. @ 1 GHz	Power @ 1 GHz	
1 piece price shown. See web or call for volume pricing.						
36"	48"	60"	72"	120"	-	Custom Len.
\$93.20	\$94.00	\$94.73	\$95.46	\$98.49	-	See Web

PE-C240 Coax, 50 Ohm						
Part No. <a href="#">PE37953</a>	Cable Dia.			Attn. @ 1 GHz	Power @ 1 GHz	
1 piece price shown. See web or call for volume pricing.						
36"	48"	60"	72"	120"	-	Custom Len.
\$113.70	\$114.74	\$115.75	\$116.75	\$120.73	-	See Web

PE-C400 Coax, 50 Ohm						
Part No. <a href="#">PE37954</a>	Cable Dia.			Attn. @ 1 GHz	Power @ 1 GHz	
1 piece price shown. See web or call for volume pricing.						
36"	48"	60"	72"	120"	-	Custom Len.
\$153.66	\$155.03	\$156.39	\$157.75	\$163.21	-	See Web

PE-C600 Coax, 50 Ohm						
Part No. <a href="#">PE37955</a>	Cable Dia.			Attn. @ 1 GHz	Power @ 1 GHz	
1 piece price shown. See web or call for volume pricing.						
36"	48"	60"	72"	120"	-	Custom Len.
\$184.28	\$176.55	\$179.24	\$181.92	\$192.65	-	See Web

LMR-400 Coax, 50 Ohm						
Part No. <a href="#">PE3W03530</a>	Cable Dia.			Attn. @ 1 GHz	Power @ 1 GHz	
1 piece price shown. See web or call for volume pricing.						
12"	24"	36"	48"	60"	50CM	Custom Len.
\$96.36	\$97.74	\$99.11	\$100.48	\$101.85	\$97.25	See Web

Low PIM Formable Cable Assemblies						
PE-SR401FLJ Low PIM Coax, 50 Ohm						
Part No. <a href="#">PE3C2013</a>	Cable Dia.			Attn. @ 1 GHz	Power @ 1 GHz	
1 piece price shown. See web or call for volume pricing.						
100CM	200CM	-	-	-	-	Custom Len.
\$190.93	\$221.72	-	-	-	-	See Web

PE-SR402FLJ Low PIM Coax, 50 Ohm						
Part No. <a href="#">PE3C2003</a>	Cable Dia.			Attn. @ 1 GHz	Power @ 1 GHz	
1 piece price shown. See web or call for volume pricing.						
100CM	200CM	-	-	-	-	Custom Len.
\$139.09	\$161.25	-	-	-	-	See Web

Low PIM Corrugated Cable Assemblies						
PE-1/4SFHC Coax, 50 Ohm						
Part No. <a href="#">PE3C7835</a>	Cable Dia.			Attn. @ 1 GHz	Power @ 1 GHz	
1 piece price shown. See web or call for volume pricing.						
12"	24"	36"	48"	60"	50CM	Custom Len.
\$64.71	\$68.44	\$72.17	\$75.90	\$79.62	\$67.09	See Web

SPP-250-LLPL Coax, 50 Ohm						
Part No. <a href="#">PE3C4130</a>	Cable Dia.			Attn. @ 1 GHz	Power @ 1 GHz	
1 piece price shown. See web or call for volume pricing.						
12"	24"	36"	48"	60"	50CM	Custom Len.
\$106.71	\$111.28	\$117.33	\$123.37	\$129.42	\$108.81	See Web

\*Coax Performance at 1 GHz Notes: Cable assembly max frequency may be lower than connector or coax max frequency



# For our complete selection of cable assemblies, please visit our website

Part No.	Cable Dia.				Attn. @ 1 GHz	Power @ 1 GHz
<b>PE3C6181</b>	0.28" dia.				5.5 dB/100ft	650 W
1 piece price shown. See web or call for volume pricing.	12"	24"	36"	48"	60"	50CM
	\$62.86	\$69.00	\$75.12	\$81.26	\$87.40	\$66.78
<b>SPO-250 Coax, 50 Ohm</b>						
<b>PE3C6341</b>	0.303" dia.				50CM	Custom Len.
1 piece price shown. See web or call for volume pricing.	12"	24"	36"	48"	60"	50CM
	\$59.01	\$61.29	\$63.58	\$65.86	\$68.15	\$60.46
<b>SPF-250 Coax, 50 Ohm</b>						
<b>PE3C6356</b>	0.303" dia.				50CM	Custom Len.
1 piece price shown. See web or call for volume pricing.	12"	24"	36"	48"	60"	50CM
	\$59.74	\$62.75	\$65.78	\$68.79	\$71.80	\$61.67
<b>SPO-375 Coax, 50 Ohm</b>						
<b>PE3C6502</b>	0.43" dia.				50CM	Custom Len.
1 piece price shown. See web or call for volume pricing.	12"	24"	36"	48"	60"	50CM
	\$76.86	\$80.01	\$83.18	\$86.33	\$89.47	\$78.89
<b>SPF-375 Coax, 50 Ohm</b>						
<b>PE3C6508</b>	0.435" dia.				50CM	Custom Len.
1 piece price shown. See web or call for volume pricing.	12"	24"	36"	48"	60"	50CM
	\$76.86	\$81.10	\$85.34	\$89.58	\$93.81	\$79.59
<b>SPO-500 Coax, 50 Ohm</b>						
<b>PE3C6511</b>	0.53" dia.				50CM	Custom Len.
1 piece price shown. See web or call for volume pricing.	12"	24"	36"	48"	60"	50CM
	\$50.20	\$53.31	\$55.91	\$58.98	\$62.07	\$52.19
<b>SPF-500 Coax, 50 Ohm</b>						
<b>PE3C6514</b>	0.545" dia.				50CM	Custom Len.
1 piece price shown. See web or call for volume pricing.	12"	24"	36"	48"	60"	50CM
	\$51.51	\$55.61	\$59.80	\$64.20	\$68.58	\$54.35
<b>Standard Formable Cable Assemblies</b>						
<b>PE-SR401FL Coax, 50 Ohm</b>						
<b>PE36140</b>	7.6 dB/100ft				1,400 W	Custom Len.
1 piece price shown. See web or call for volume pricing.	12"	24"	36"	48"	60"	72"
	\$335.14	\$351.34	\$367.55	\$383.76	\$399.92	\$416.13
<b>PE-SR402FL Coax, 50 Ohm</b>						
<b>PE36144</b>	11.88 dB/100ft				450 W	Custom Len.
1 piece price shown. See web or call for volume pricing.	12"	24"	36"	48"	60"	72"
	\$320.30	\$328.23	\$336.17	\$344.06	\$351.99	\$359.86
<b>Standard Flexible Cable Assemblies</b>						
<b>RG8A/U Coax, 50 Ohm</b>						
<b>PE35283</b>	0.405" dia.				8 dB/100ft	190 W
1 piece price shown. See web or call for volume pricing.	12"	24"	36"	48"	60"	72"
	\$264.54	\$267.41	\$270.20	\$273.00	\$275.86	-
<b>RG58C/U Coax, 50 Ohm</b>						
<b>PE3183</b>	0.195" dia.				20 dB/100ft	44 W
1 piece price shown. See web or call for volume pricing.	12"	24"	36"	48"	60"	72"
	\$258.20	\$259.01	\$259.80	\$260.59	\$261.39	\$262.20
<b>RG142B/U Coax, 50 Ohm</b>						
<b>PE3189</b>	0.195" dia.				129 dB/100ft	Custom Len.
1 piece price shown. See web or call for volume pricing.	12"	24"	36"	48"	60"	72"
	\$114.41	\$120.64	\$126.84	\$133.06	\$139.28	\$145.48
<b>RG213/U Coax, 50 Ohm</b>						
<b>PE3199</b>	0.405" dia.				9 dB/100ft	190 W
1 piece price shown. See web or call for volume pricing.	12"	24"	36"	48"	60"	72"
	\$270.32	\$272.13	\$273.90	\$275.72	\$277.55	\$279.37
<b>RG214/U Coax, 50 Ohm</b>						
<b>PE3185</b>	0.425" dia.				7.32 dB/100ft	170 W
1 piece price shown. See web or call for volume pricing.	12"	24"	36"	48"	60"	72"
	\$286.00	\$293.93	\$301.89	\$308.96	\$317.76	\$325.71
<b>RG217/U Coax, 50 Ohm</b>						
<b>PE36134</b>	0.545" dia.				5.8 dB/100ft	260 W
1 piece price shown. See web or call for volume pricing.	12"	24"	36"	48"	60"	72"
	\$346.42	\$351.20	\$355.96	\$360.74	\$365.50	\$370.28
<b>RG218/U Coax, 50 Ohm</b>						
<b>PE35900</b>	0.87" dia.				3.8 dB/100ft	560 W
1 piece price shown. See web or call for volume pricing.	12"	24"	36"	48"	60"	72"
	\$377.59	\$390.05	\$402.53	\$414.98	\$427.46	\$439.92

Part No.	Cable Dia.				Attn. @ 1 GHz	Power @ 1 GHz
<b>PE3192</b>	0.209" dia.				13.41 dB/100ft	50 W
1 piece price shown. See web or call for volume pricing.	12"	24"	36"	48"	60"	72"
	\$106.53	\$108.25	\$111.37	\$114.56	\$117.75	\$120.85
<b>RG225/U Coax, 50 Ohm</b>						
<b>PE36136</b>	0.43" dia.				1,700 W	Custom Len.
1 piece price shown. See web or call for volume pricing.	12"	24"	36"	48"	60"	72"
	\$297.15	\$332.47	\$367.80	\$403.14	\$438.45	\$473.80
<b>RG393/U Coax, 50 Ohm</b>						
<b>PE3205</b>	0.39" dia.				7.5 dB/100ft	1,700 W
1 piece price shown. See web or call for volume pricing.	12"	24"	36"	48"	60"	72"
	\$295.46	\$177.26	\$195.04	\$213.87	\$232.00	\$250.14
<b>RG400/U Coax, 50 Ohm</b>						
<b>PE34360</b>	0.195" dia.				14.7 dB/100ft	650 W
1 piece price shown. See web or call for volume pricing.	12"	24"	36"	48"	60"	72"
	\$116.07	\$123.66	\$131.26	\$138.89	\$146.51	\$154.11
<b>Standard Semi-Rigid Cable Assemblies</b>						
<b>RG401/U Coax, 50 Ohm</b>						
<b>PE36138</b>	7.5 dB/100ft				870 W	Custom Len.
1 piece price shown. See web or call for volume pricing.	12"	24"	36"	48"	60"	72"
	\$342.02	\$365.07	\$388.15	\$411.25	\$434.37	Call
<b>RG402/U Coax, 50 Ohm</b>						
<b>PE36142</b>	12 dB/100ft				650 W	Custom Len.
1 piece price shown. See web or call for volume pricing.	12"	24"	36"	48"	60"	72"
	\$320.10	\$327.79	\$335.46	\$343.13	\$350.82	\$358.49
<b>7/16 DIN MALE TO 7/16 DIN MALE RIGHT ANGLE</b>						
<b>Low Loss Flexible Cable Assemblies</b>						
<b>PE-C195 Coax, 50 Ohm</b>						
<b>PE37956</b>	0.195" dia.				11.3 dB/100ft	150 W
1 piece price shown. See web or call for volume pricing.	36"	48"	60"	72"	120"	-
	\$87.99	\$88.72	\$89.52	\$90.24	\$93.27	-
<b>PE-C240 Coax, 50 Ohm</b>						
<b>PE37957</b>	0.24" dia.				9.2 dB/100ft	Custom Len.
1 piece price shown. See web or call for volume pricing.	36"	48"	60"	72"	120"	-
	\$136.55	\$137.58	\$138.57	\$139.54	\$143.58	-
<b>PE-C400 Coax, 50 Ohm</b>						
<b>PE37958</b>	0.4" dia.				4.1 dB/100ft	550 W
1 piece price shown. See web or call for volume pricing.	36"	48"	60"	72"	120"	-
	\$170.76	\$172.19	\$173.62	\$175.05	\$180.76	-
<b>Low PIM Corrugated Cable Assemblies</b>						
<b>PE-1/4SFHC Coax, 50 Ohm</b>						
<b>PE3C7836</b>	0.303" dia.				5.85 dB/100ft	Custom Len.
1 piece price shown. See web or call for volume pricing.	12"	24"	36"	48"	60"	50CM
	\$69.66	\$73.94	\$77.67	\$81.39	\$85.12	\$72.59
<b>SPP-250-LLPL Coax, 50 Ohm</b>						
<b>PE3C6188</b>	0.28" dia.				5.5 dB/100ft	650 W
1 piece price shown. See web or call for volume pricing.	12"	24"	36"	48"	60"	50CM
	\$68.12	\$74.24	\$80.38	\$86.51	\$92.65	\$72.03
<b>Standard Flexible Cable Assemblies</b>						
<b>RG214/U Coax, 50 Ohm</b>						
<b>PE38584</b>	0.425" dia.				7.32 dB/100ft	190 W
1 piece price shown. See web or call for volume pricing.	12"	24"	36"	48"	60"	-
	\$309.73	\$317.67	\$325.61	\$333.55	\$341.49	-
<b>RG217/U Coax, 50 Ohm</b>						
<b>PE37600</b>	0.545" dia.				5.8 dB/100ft	260 W
1 piece price shown. See web or call for volume pricing.	12"	24"	36"	48"	60"	-
	\$387.95	\$392.73	\$397.49	\$402.28	\$432.10	-
<b>RG393/U Coax, 50 Ohm</b>						
<b>PE36657</b>	0.39" dia.				8.8 dB/100ft	1,700 W
1 piece price shown. See web or call for volume pricing.	12"	24"	36"	48"	60"	-
	\$337.52	\$355.30	\$351.94	\$368.73	\$410.05	-
<b>PE-1/2 Helical Coax, 50 Ohm</b>						
<b>PE37973</b>	0.54" dia.				-	Custom Len.
1 piece price shown. See web or call for volume pricing.	36"	72"	-	-	-	-
	\$170.30	\$198.83	-	-	-	-



Cable Assemblies

See Our Website For Current Pricing & Real-Time Stock Availability!

For Custom Lengths, Metric Lengths or Special Configurations, Please call (949) 261-1920



Technical Support  
+1 (949) 261-1920



Same-Day Shipping,  
Even Custom Cable Assemblies



For our complete selection of cable assemblies, please visit our website

**7/16 DIN MALE TO 7/16 DIN FEMALE**



**Low Loss Flexible Cable Assemblies**

PE-C195 Coax, 50 Ohm				
Part No.	PE37960			
1 piece price shown.	See web or call for volume pricing.			
Cable Dia.	Attn. @ 1 GHz	Power @ 1 GHz		
0.195" dia.	11.3dB/100ft	150 W		
36"	48"	60"	72"	120"
\$87.99	\$88.72	\$89.52	\$90.24	\$93.27
				See Web

95

PE-C240 Coax, 50 Ohm				
Part No.	PE37961			
1 piece price shown.	See web or call for volume pricing.			
Cable Dia.	Attn. @ 1 GHz	Power @ 1 GHz		
0.24" dia.	9.2dB/100ft	250 W		
36"	48"	60"	72"	120"
\$130.03	\$131.10	\$132.06	\$133.02	\$137.07
				See Web

96

PE-C400 Coax, 50 Ohm				
Part No.	PE37962			
1 piece price shown.	See web or call for volume pricing.			
Cable Dia.	Attn. @ 1 GHz	Power @ 1 GHz		
0.4" dia.	4.1dB/100ft	550 W		
36"	48"	60"	72"	120"
\$165.20	\$166.54	\$167.89	\$169.29	\$174.74
				See Web

97

PE-C600 Coax, 50 Ohm				
Part No.	PE37963			
1 piece price shown.	See web or call for volume pricing.			
Cable Dia.	Attn. @ 1 GHz	Power @ 1 GHz		
0.59" dia.	2.7dB/100ft	900 W		
36"	48"	60"	72"	120"
\$180.41	\$183.10	\$185.62	\$188.14	\$198.54
				See Web

98

**Low PIM Formable Cable Assemblies**

PE-SR401FLJ Low PIM Coax, 50 Ohm				
Part No.	PE3C2015			
1 piece price shown.	See web or call for volume pricing.			
Cable Dia.	Attn. @ 1 GHz	Power @ 1 GHz		
0.276" dia.	-	-		
100CM	200CM	-	-	Custom Len.
\$190.93	\$221.72	-	-	See Web

99

PE-SR402FLJ Low PIM Coax, 50 Ohm				
Part No.	PE3C2004			
1 piece price shown.	See web or call for volume pricing.			
Cable Dia.	Attn. @ 1 GHz	Power @ 1 GHz		
0.161" dia.	-	-		
100CM	200CM	-	-	Custom Len.
\$115.49	\$123.91	-	-	See Web

1

**Low PIM Corrugated Cable Assemblies**

PE-1/4SFHC Coax, 50 Ohm				
Part No.	PE3C7837			
1 piece price shown.	See web or call for volume pricing.			
Cable Dia.	Attn. @ 1 GHz	Power @ 1 GHz		
0.303" dia.	5.85dB/100ft	-		
12"	24"	36"	48"	60"
\$64.71	\$68.44	\$72.17	\$75.90	\$79.62
				See Web

2

SPP-250-LLPL Coax, 50 Ohm				
Part No.	PE3C5855			
1 piece price shown.	See web or call for volume pricing.			
Cable Dia.	Attn. @ 1 GHz	Power @ 1 GHz		
0.28" dia.	-	-		
12"	24"	36"	48"	60"
\$102.76	\$107.38	\$113.43	\$119.48	\$125.53
				See Web

3

SPP-250-LLPL Coax, 50 Ohm				
Part No.	PE3C6182			
1 piece price shown.	See web or call for volume pricing.			
Cable Dia.	Attn. @ 1 GHz	Power @ 1 GHz		
0.28" dia.	5.5dB/100ft	650 W		
12"	24"	36"	48"	60"
\$62.86	\$69.00	\$75.12	\$81.26	\$87.40
				See Web

4

SPO-375 Coax, 50 Ohm				
Part No.	PE3C6503			
1 piece price shown.	See web or call for volume pricing.			
Cable Dia.	Attn. @ 1 GHz	Power @ 1 GHz		
0.43" dia.	-	-		
12"	24"	36"	48"	60"
\$71.61	\$74.76	\$77.92	\$81.07	\$84.22
				See Web

5

SPF-375 Coax, 50 Ohm				
Part No.	PE3C6509			
1 piece price shown.	See web or call for volume pricing.			
Cable Dia.	Attn. @ 1 GHz	Power @ 1 GHz		
0.435" dia.	-	-		
12"	24"	36"	48"	60"
\$71.61	\$75.85	\$80.09	\$84.33	\$88.55
				See Web

6

**Standard Flexible Cable Assemblies**

RG393/U Coax, 50 Ohm				
Part No.	PE37450			
1 piece price shown.	See web or call for volume pricing.			
Cable Dia.	Attn. @ 1 GHz	Power @ 1 GHz		
0.39" dia.	8.8dB/100ft	1,700 W		
12"	24"	36"	48"	60"
\$306.14	\$322.90	\$339.67	\$356.44	\$397.04
				See Web

7

PE-1/2 Helical Coax, 50 Ohm				
Part No.	PE37972			
1 piece price shown.	See web or call for volume pricing.			
Cable Dia.	Attn. @ 1 GHz	Power @ 1 GHz		
0.54" dia.	-	-		
36"	72"	-	-	Custom Len.
\$156.16	\$188.28	-	-	See Web

8

**7/16 DIN MALE TO 7/16 DIN FEMALE BULKHEAD**



SEE MOUNTING HOLE SECTION ON PAGE 409

**Low PIM Corrugated Cable Assemblies**

PE-1/4SFHC Coax, 50 Ohm				
Part No.	PE3C7838			
1 piece price shown.	See web or call for volume pricing.			
Cable Dia.	Attn. @ 1 GHz	Power @ 1 GHz		
0.303" dia.	5.85dB/100ft	-		
12"	50CM	24"	36"	48"
\$77.35	\$79.74	\$81.08	\$84.81	\$88.53
				See Web

9

**7/16 DIN MALE TO N MALE**



**Low Loss Flexible Cable Assemblies**

LMR-400-UF Coax, 50 Ohm						
Part No.	PE3W03271					
1 piece price shown.	See web or call for volume pricing.					
Cable Dia.	Attn. @ 1 GHz	Power @ 1 GHz				
0.405" dia.	5dB/100ft	650 W				
12"	24"	36"	48"	60"	50CM	Custom Len.
\$101.85	\$104.73	\$107.62	\$108.97	\$111.82	\$103.70	See Web

10

**Low PIM Corrugated Cable Assemblies**

SPP-250-LLPL Coax, 50 Ohm						
Part No.	PE3C6192					
1 piece price shown.	See web or call for volume pricing.					
Cable Dia.	Attn. @ 1 GHz	Power @ 1 GHz				
0.28" dia.	5.5dB/100ft	650 W				
12"	24"	36"	48"	60"	50CM	Custom Len.
\$60.24	\$66.37	\$72.49	\$78.63	\$84.76	\$64.16	See Web

11

SPO-250 Coax, 50 Ohm						
Part No.	PE3C6342					
1 piece price shown.	See web or call for volume pricing.					
Cable Dia.	Attn. @ 1 GHz	Power @ 1 GHz				
0.303" dia.	-	-				
12"	24"	36"	48"	60"	50CM	Custom Len.
\$54.24	\$56.04	\$58.32	\$60.61	\$62.89	\$55.21	See Web

12

SPF-250 Coax, 50 Ohm						
Part No.	PE3C6357					
1 piece price shown.	See web or call for volume pricing.					
Cable Dia.	Attn. @ 1 GHz	Power @ 1 GHz				
0.303" dia.	-	-				
12"	24"	36"	48"	60"	50CM	Custom Len.
\$54.49	\$57.50	\$60.53	\$63.54	\$66.54	\$66.42	See Web

13

SPP-500-LLPL Coax, 50 Ohm						
Part No.	PE3C6369					
1 piece price shown.	See web or call for volume pricing.					
Cable Dia.	Attn. @ 1 GHz	Power @ 1 GHz				
0.5" dia.	-	-				
12"	24"	36"	48"	60"	50CM	Custom Len.
\$54.30	\$64.58	\$74.87	\$85.15	\$95.43	\$60.88	See Web

14

**Standard Semi-Rigid Cable Assemblies**

RG401/U Coax, 50 Ohm						
Part No.	PE36174					
1 piece price shown.	See web or call for volume pricing.					
Cable Dia.	Attn. @ 1 GHz	Power @ 1 GHz				
0.303" dia.	-	-				
12"	24"	36"	48"	60"	72"	Custom Len.
\$239.16	\$262.26	\$285.36	\$308.41	\$331.51	Call	See Web

15

**7/16 DIN MALE TO N MALE RIGHT ANGLE**



**Low PIM Corrugated Cable Assemblies**

SPP-250-LLPL Coax, 50 Ohm						
Part No.	PE3C6193					
1 piece price shown.	See web or call for volume pricing.					
Cable Dia.	Attn. @ 1 GHz	Power @ 1 GHz				
0.28" dia.	5.5dB/100ft	650 W				
12"	24"	36"	48"	60"	50CM	Custom Len.
\$62.86	\$69.00	\$75.12	\$81.26	\$87.40	\$66.78	See Web

16

SPO-250 Coax, 50 Ohm						
Part No.	PE3C6343					
1 piece price shown.	See web or call for volume pricing.					
Cable Dia.	Attn. @ 1 GHz	Power @ 1 GHz				
0.303" dia.	-	-				
12"	24"	36"	48"	60"	50CM	Custom Len.
\$59.01	\$61.29	\$63.58	\$65.86	\$68.15	\$60.46	See Web

17

SPF-250 Coax, 50 Ohm						
Part No.	PE3C6358					
1 piece price shown.	See web or call for volume pricing.					
Cable Dia.	Attn. @ 1 GHz	Power @ 1 GHz				
0.303" dia.	-	-				
12"	24"	36"	48"	60"	50CM	Custom Len.
\$59.74	\$62.75	\$65.78	\$68.79	\$71.80	\$61.67	See Web

18

**7/16 DIN MALE TO N FEMALE**



**Low PIM Corrugated Cable Assemblies**

SPP-250-LLPL Coax, 50 Ohm						
Part No.	PE3C6190					
1 piece price shown.	See web or call for volume pricing.					
Cable Dia.	Attn. @ 1 GHz	Power @ 1 GHz				
0.28" dia.	5.5dB/100ft	650 W				
12"	24"	36"	48"	60"	50CM	Custom Len.
\$60.24	\$66.37	\$72.49	\$78.63	\$84.76	\$64.16	See Web

19

**7/16 DIN MALE TO N FEMALE BULKHEAD**



SEE MOUNTING HOLE SECTION ON PAGE 409

**Low PIM Corrugated Cable Assemblies**

SPP-250-LLPL Coax, 50 Ohm						
Part No.	PE3C6191					
1 piece price shown.	See web or call for volume pricing.					
Cable Dia.	Attn. @ 1 GHz	Power @ 1 GHz				
0.28" dia.	5.5dB/100ft	650 W				
12"	24"	36"	48"	60"	50CM	Custom Len.
\$60.24	\$66.37	\$72.49	\$78.63	\$84.76	\$64.16	See Web

20

**7/16 DIN MALE TO QMA MALE**



**Low PIM Corrugated Cable Assemblies**

Cable Assemblies

See Our Website For Current Pricing & Real-Time Stock Availability!

\*Coax Performance at 1 GHz Notes: Cable assembly max frequency may be lower than connector or coax max frequency

For our complete selection of cable assemblies, please visit our website

SPP-250-LLPL Coax, 50 Ohm						
Part No. <a href="#">PE3C5867</a>	Cable Dia.			Attn. @ 1 GHz	Power @ 1 GHz	
1 piece price shown. See web or call for volume pricing.	0.28" dia.					21
12"	24"	36"	48"	60"	50CM	Custom Len.
\$90.84	\$96.98	\$103.11	\$107.73	\$113.78	\$94.79	See Web

**7/16 DIN MALE TO QMA MALE RIGHT ANGLE**



**Low PIM Corrugated Cable Assemblies**

SPP-250-LLPL Coax, 50 Ohm						
Part No. <a href="#">PE3C5873</a>	Cable Dia.			Attn. @ 1 GHz	Power @ 1 GHz	
1 piece price shown. See web or call for volume pricing.	0.28" dia.					22
12"	24"	36"	48"	60"	50CM	Custom Len.
\$93.23	\$99.36	\$105.50	\$110.08	\$116.13	\$97.17	See Web

**7/16 DIN MALE TO QMA FEMALE**



**Low PIM Corrugated Cable Assemblies**

SPP-250-LLPL Coax, 50 Ohm						
Part No. <a href="#">PE3C5861</a>	Cable Dia.			Attn. @ 1 GHz	Power @ 1 GHz	
1 piece price shown. See web or call for volume pricing.	0.28" dia.					23
12"	24"	36"	48"	60"	50CM	Custom Len.
\$86.90	\$93.04	\$99.17	\$105.29	\$109.88	\$90.82	See Web

**7/16 DIN MALE TO SC MALE**



**Standard Flexible Cable Assemblies**

RG393/U Coax, 50 Ohm						
Part No. <a href="#">PE37497</a>	Cable Dia.			Attn. @ 1 GHz	Power @ 1 GHz	
1 piece price shown. See web or call for volume pricing.	0.39" dia.			8.8 dB/100ft	1,700 W	24
12"	24"	36"	48"	60"	50CM	Custom Len.
\$224.61	\$241.88	\$259.15	\$276.42	\$293.69	\$235.68	See Web

**7/16 DIN MALE TO SMA MALE**



**Corrugated Cable Assemblies**

SPP-250-LLPL Coax, 50 Ohm						
Part No. <a href="#">PE3C5886</a>	Cable Dia.			Attn. @ 1 GHz	Power @ 1 GHz	
1 piece price shown. See web or call for volume pricing.	0.28" dia.			5.5 dB/100ft	650 W	25
12"	24"	36"	48"	60"	50CM	Custom Len.
\$82.91	\$89.04	\$95.17	\$101.31	\$107.44	\$86.84	See Web

**Low PIM Corrugated Cable Assemblies**

SPP-250-LLPL Coax, 50 Ohm						
Part No. <a href="#">PE3C6194</a>	Cable Dia.			Attn. @ 1 GHz	Power @ 1 GHz	
1 piece price shown. See web or call for volume pricing.	0.28" dia.			5.5 dB/100ft	650 W	26
12"	24"	36"	48"	60"	50CM	Custom Len.
\$54.98	\$61.12	\$67.26	\$73.38	\$79.51	\$58.90	See Web

**7/16 DIN MALE TO SMA MALE RIGHT ANGLE**



**Low PIM Corrugated Cable Assemblies**

SPP-250-LLPL Coax, 50 Ohm						
Part No. <a href="#">PE3C5891</a>	Cable Dia.			Attn. @ 1 GHz	Power @ 1 GHz	
1 piece price shown. See web or call for volume pricing.	0.28" dia.					27
12"	24"	36"	48"	60"	50CM	Custom Len.
\$84.50	\$90.64	\$96.77	\$102.91	\$107.53	\$88.44	See Web

Part No. <a href="#">PE3C6195</a>	Cable Dia.			Attn. @ 1 GHz	Power @ 1 GHz	
1 piece price shown. See web or call for volume pricing.	0.28" dia.			5.5 dB/100ft	650 W	28
12"	24"	36"	48"	60"	50CM	Custom Len.
\$60.24	\$66.37	\$72.49	\$78.63	\$84.76	\$64.16	See Web

**7/16 DIN MALE TO SMA FEMALE**



**Low PIM Corrugated Cable Assemblies**

SPP-250-LLPL Coax, 50 Ohm						
Part No. <a href="#">PE3C5880</a>	Cable Dia.			Attn. @ 1 GHz	Power @ 1 GHz	
1 piece price shown. See web or call for volume pricing.	0.28" dia.					29
12"	24"	36"	48"	60"	50CM	Custom Len.
\$83.72	\$89.85	\$95.98	\$102.12	\$106.75	\$87.64	See Web

**7/16 DIN MALE TO NEX10 MALE**



**Low PIM Corrugated Cable Assemblies**

SPP-250-LLPL Coax, 50 Ohm						
Part No. <a href="#">PE3C6251</a>	Cable Dia.			Attn. @ 1 GHz	Power @ 1 GHz	
1 piece price shown. See web or call for volume pricing.	0.28" dia.			5.5 dB/100ft	650 W	30
12"	24"	36"	48"	60"	50CM	Custom Len.
\$68.80	\$74.94	\$81.07	\$87.20	\$93.34	\$72.72	See Web

**SPO-250 Coax, 50 Ohm**

Part No. <a href="#">PE3C6344</a>	Cable Dia.			Attn. @ 1 GHz	Power @ 1 GHz	
1 piece price shown. See web or call for volume pricing.	0.303" dia.					31
12"	24"	36"	48"	60"	50CM	Custom Len.
\$64.96	\$67.25	\$69.51	\$71.80	\$74.09	\$66.41	See Web

**SPF-250 Coax, 50 Ohm**

Part No. <a href="#">PE3C6359</a>	Cable Dia.			Attn. @ 1 GHz	Power @ 1 GHz	
1 piece price shown. See web or call for volume pricing.	0.303" dia.					32
12"	24"	36"	48"	60"	50CM	Custom Len.
\$65.68	\$68.70	\$71.72	\$74.73	\$77.74	\$67.61	See Web

**7/16 DIN MALE RIGHT ANGLE TO 7/16 DIN MALE**



**Low PIM Corrugated Cable Assemblies**

SPP-250-LLPL Coax, 50 Ohm						
Part No. <a href="#">PE3C4131</a>	Cable Dia.			Attn. @ 1 GHz	Power @ 1 GHz	
1 piece price shown. See web or call for volume pricing.	0.28" dia.					33
12"	24"	36"	48"	60"	50CM	Custom Len.
\$117.91	\$123.97	\$130.02	\$136.07	\$142.12	\$121.81	See Web

**7/16 DIN MALE RIGHT ANGLE TO 7/16 DIN MALE RIGHT ANGLE**



**Low PIM Corrugated Cable Assemblies**

PE-1/4SFHC Coax, 50 Ohm						
Part No. <a href="#">PE3C7839</a>	Cable Dia.			Attn. @ 1 GHz	Power @ 1 GHz	
1 piece price shown. See web or call for volume pricing.	0.303" dia.			5.85 dB/100ft	50CM	Custom Len.
12"	24"	36"	48"	60"	50CM	Custom Len.
\$74.61	\$78.34	\$82.06	\$85.79	\$89.52	\$77.00	See Web

**SPP-250-LLPL Coax, 50 Ohm**

Part No. <a href="#">PE3C4144</a>	Cable Dia.			Attn. @ 1 GHz	Power @ 1 GHz	
1 piece price shown. See web or call for volume pricing.	0.28" dia.					35
12"	24"	36"	48"	60"	50CM	Custom Len.
\$130.58	\$136.53	\$142.68	\$148.73	\$154.78	\$134.47	See Web

Part No. <a href="#">PE3C6189</a>	Cable Dia.			Attn. @ 1 GHz	Power @ 1 GHz	
1 piece price shown. See web or call for volume pricing.	0.28" dia.			5.5 dB/100ft	650 W	36
12"	24"	36"	48"	60"	50CM	Custom Len.
\$73.37	\$79.50	\$85.64	\$91.77	\$97.91	\$77.29	See Web

**7/16 DIN MALE RIGHT ANGLE TO 7/16 DIN FEMALE**



**Low PIM Corrugated Cable Assemblies**

PE-1/4SFHC Coax, 50 Ohm						
Part No. <a href="#">PE3C7840</a>	Cable Dia.			Attn. @ 1 GHz	Power @ 1 GHz	
1 piece price shown. See web or call for volume pricing.	0.303" dia.			5.85 dB/100ft		37
12"	50CM	24"	36"	48"	60"	Custom Len.
\$69.66	\$72.04	\$73.39	\$77.12	\$80.84	\$84.57	See Web

**SPP-250-LLPL Coax, 50 Ohm**

Part No. <a href="#">PE3C6183</a>	Cable Dia.			Attn. @ 1 GHz	Power @ 1 GHz	
1 piece price shown. See web or call for volume pricing.	0.28" dia.			5.5 dB/100ft	650 W	38
12"	24"	36"	48"	60"	50CM	Custom Len.
\$68.12	\$74.24	\$80.38	\$86.51	\$92.65	\$72.03	See Web

**7/16 DIN MALE RIGHT ANGLE TO 7/16 DIN FEMALE BULKHEAD**



SEE MOUNTING HOLE SECTION ON PAGE 409

**Low PIM Corrugated Cable Assemblies**

PE-1/4SFHC Coax, 50 Ohm						
Part No. <a href="#">PE3C7841</a>	Cable Dia.			Attn. @ 1 GHz	Power @ 1 GHz	
1 piece price shown. See web or call for volume pricing.	0.303" dia.			5.85 dB/100ft		39
12"	24"	36"	48"	60"	50CM	Custom Len.
\$82.30	\$86.03	\$89.75	\$93.49	\$97.22	\$84.69	See Web

**7/16 DIN MALE RIGHT ANGLE TO N MALE**



**Low PIM Corrugated Cable Assemblies**

SPP-250-LLPL Coax, 50 Ohm						
Part No. <a href="#">PE3C6198</a>	Cable Dia.			Attn. @ 1 GHz	Power @ 1 GHz	
1 piece price shown. See web or call for volume pricing.	0.28" dia.			5.5 dB/100ft	650 W	40
12"	24"	36"	48"	60"	50CM	Custom Len.
\$65.50	\$71.62	\$77.75	\$83.89	\$90.02	\$69.41	See Web

Cable Assemblies

See Our Website For Current Pricing & Real-Time Stock Availability!

For Custom Lengths, Metric Lengths or Special Configurations, Please call (949) 261-1920



Technical Support  
+1 (949) 261-1920



Same-Day Shipping,  
Even Custom Cable Assemblies

For our complete selection of cable assemblies, please visit our website

**7/16 DIN MALE RIGHT ANGLE TO N MALE RIGHT ANGLE**



**Low PIM Corrugated Cable Assemblies**

SPP-250-LLPL Coax, 50 Ohm

Part No. <a href="#">PE3C6199</a>	Cable Dia.	Attn. @ 1 GHz	Power @ 1 GHz
1 piece price shown. See web or call for volume pricing.			
12"	0.28" dia.	5.5 dB/100ft	650 W
24"	60"	50CM	Custom Len.
\$68.12	\$74.24	\$80.38	\$86.51
\$92.65	\$72.03	See Web	

41

**7/16 DIN MALE RIGHT ANGLE TO N FEMALE**



**Low PIM Corrugated Cable Assemblies**

SPP-250-LLPL Coax, 50 Ohm

Part No. <a href="#">PE3C6196</a>	Cable Dia.	Attn. @ 1 GHz	Power @ 1 GHz
1 piece price shown. See web or call for volume pricing.			
12"	0.28" dia.	5.5 dB/100ft	650 W
24"	60"	50CM	Custom Len.
\$65.50	\$71.62	\$77.75	\$83.89
\$90.02	\$69.41	See Web	

42

**7/16 DIN MALE RIGHT ANGLE TO N FEMALE BULKHEAD**



SEE MOUNTING HOLE SECTION ON PAGE 409

**Low PIM Corrugated Cable Assemblies**

SPP-250-LLPL Coax, 50 Ohm

Part No. <a href="#">PE3C6197</a>	Cable Dia.	Attn. @ 1 GHz	Power @ 1 GHz
1 piece price shown. See web or call for volume pricing.			
12"	0.28" dia.	5.5 dB/100ft	650 W
24"	60"	50CM	Custom Len.
\$65.50	\$71.62	\$77.75	\$83.89
\$90.02	\$69.41	See Web	

43

**7/16 DIN MALE RIGHT ANGLE TO NEX10 MALE**



**Low PIM Corrugated Cable Assemblies**

SPP-250-LLPL Coax, 50 Ohm

Part No. <a href="#">PE3C6252</a>	Cable Dia.	Attn. @ 1 GHz	Power @ 1 GHz
1 piece price shown. See web or call for volume pricing.			
12"	0.28" dia.	5.5 dB/100ft	650 W
24"	60"	50CM	Custom Len.
\$74.06	\$80.19	\$86.33	\$92.46
\$98.60	\$77.97	See Web	

44

**7/16 DIN FEMALE TO 7/16 DIN FEMALE**



**Corrugated Cable Assemblies**

SPO-375 Coax, 50 Ohm

Part No. <a href="#">PE3C6504</a>	Cable Dia.	Attn. @ 1 GHz	Power @ 1 GHz
1 piece price shown. See web or call for volume pricing.			
12"	0.43" dia.		
24"	60"	50CM	Custom Len.
\$66.36	\$69.50	\$72.66	\$75.82
\$78.97	\$68.37	See Web	

45

**Low PIM Corrugated Cable Assemblies**

SPP-375-LLPL Coax, 50 Ohm

Part No. <a href="#">PE3C6383</a>	Cable Dia.	Attn. @ 1 GHz	Power @ 1 GHz
1 piece price shown. See web or call for volume pricing.			
12"	0.402" dia.		
24"	60"	50CM	Custom Len.
\$54.65	\$62.63	\$70.63	\$78.62
\$86.62	\$59.76	See Web	

46

SPF-375 Coax, 50 Ohm

Part No. <a href="#">PE3C6510</a>	Cable Dia.	Attn. @ 1 GHz	Power @ 1 GHz
1 piece price shown. See web or call for volume pricing.			
12"	0.435" dia.		
24"	60"	50CM	Custom Len.
\$66.36	\$70.59	\$74.83	\$79.07
\$83.31	\$69.08	See Web	

47

**7/16 DIN FEMALE TO N MALE**



**Low PIM Corrugated Cable Assemblies**

SPP-250-LLPL Coax, 50 Ohm

Part No. <a href="#">PE3C5856</a>	Cable Dia.	Attn. @ 1 GHz	Power @ 1 GHz
1 piece price shown. See web or call for volume pricing.			
12"	0.28" dia.		
24"	60"	50CM	Custom Len.
\$94.82	\$100.95	\$107.09	\$111.64
\$117.69	\$98.74	See Web	

48

Part No. <a href="#">PE3C6224</a>	Cable Dia.	Attn. @ 1 GHz	Power @ 1 GHz
1 piece price shown. See web or call for volume pricing.			
12"	0.28" dia.	5.5 dB/100ft	650 W
24"	60"	50CM	Custom Len.
\$60.24	\$66.37	\$72.49	\$78.63
\$84.76	\$64.16	See Web	

49

SPP-375-LLPL Coax, 50 Ohm

Part No. <a href="#">PE3C6384</a>	Cable Dia.	Attn. @ 1 GHz	Power @ 1 GHz
1 piece price shown. See web or call for volume pricing.			
12"	0.402" dia.		
24"	60"	50CM	Custom Len.
\$58.58	\$66.57	\$74.58	\$82.57
\$90.56	\$63.70	See Web	

50

**7/16 DIN FEMALE TO N MALE RIGHT ANGLE**



**Low PIM Corrugated Cable Assemblies**

SPP-250-LLPL Coax, 50 Ohm

Part No. <a href="#">PE3C6244</a>	Cable Dia.	Attn. @ 1 GHz	Power @ 1 GHz
1 piece price shown. See web or call for volume pricing.			
12"	0.28" dia.	5.5 dB/100ft	650 W
24"	60"	50CM	Custom Len.
\$62.86	\$69.00	\$75.12	\$81.26
\$87.40	\$66.78	See Web	

51

**7/16 DIN FEMALE TO QMA MALE**



**Low PIM Corrugated Cable Assemblies**

SPP-250-LLPL Coax, 50 Ohm

Part No. <a href="#">PE3C5857</a>	Cable Dia.	Attn. @ 1 GHz	Power @ 1 GHz
1 piece price shown. See web or call for volume pricing.			
12"	0.28" dia.		
24"	60"	50CM	Custom Len.
\$90.84	\$96.98	\$103.11	\$107.73
\$113.78	\$94.79	See Web	

52

**7/16 DIN FEMALE TO SMA MALE**



**Low PIM Corrugated Cable Assemblies**

SPP-250-LLPL Coax, 50 Ohm

Part No. <a href="#">PE3C5858</a>	Cable Dia.	Attn. @ 1 GHz	Power @ 1 GHz
1 piece price shown. See web or call for volume pricing.			
12"	0.28" dia.		
24"	60"	50CM	Custom Len.
\$82.91	\$89.04	\$95.17	\$101.31
\$107.44	\$86.84	See Web	

53

**7/16 DIN FEMALE TO NEX10 MALE**



**Low PIM Corrugated Cable Assemblies**

SPP-250-LLPL Coax, 50 Ohm

Part No. <a href="#">PE3C6260</a>	Cable Dia.	Attn. @ 1 GHz	Power @ 1 GHz
1 piece price shown. See web or call for volume pricing.			
12"	0.28" dia.	5.5 dB/100ft	650 W
24"	60"	50CM	Custom Len.
\$68.80	\$74.94	\$81.07	\$87.20
\$93.34	\$72.72	See Web	

54

**10-32 MALE TO 10-32 MALE**



**Standard Flexible Cable Assemblies**

RG174A/U Coax, 50 Ohm

Part No. <a href="#">PE36520</a>	Cable Dia.	Attn. @ 1 GHz	Power @ 1 GHz
1 piece price shown. See web or call for volume pricing.			
12"	0.1" dia.	32 dB/100ft	16 W
24"	72"	50CM	Custom Len.
\$72.99	\$73.62	\$71.14	\$74.94
\$75.58	\$76.22	See Web	

55

RG178B/U Coax, 50 Ohm

Part No. <a href="#">PE36522</a>	Cable Dia.	Attn. @ 1 GHz	Power @ 1 GHz
1 piece price shown. See web or call for volume pricing.			
12"	0.072" dia.	44.4 dB/100ft	78 W
24"	60"	72"	Custom Len.
\$98.10	\$99.14	\$106.32	\$101.27
\$107.23	\$103.37	See Web	

56

RG316/U Coax, 50 Ohm

Part No. <a href="#">PE36524</a>	Cable Dia.	Attn. @ 1 GHz	Power @ 1 GHz
1 piece price shown. See web or call for volume pricing.			
12"	0.098" dia.	38 dB/100ft	160 W
24"	60"	72"	Custom Len.
\$74.59	\$77.75	\$80.93	\$89.57
\$93.07	\$96.58	See Web	

57

**10-32 MALE TO 10-32 MALE RIGHT ANGLE**



**Standard Flexible Cable Assemblies**

RG174A/U Coax, 50 Ohm

Part No. <a href="#">PE36526</a>	Cable Dia.	Attn. @ 1 GHz	Power @ 1 GHz
1 piece price shown. See web or call for volume pricing.			
12"	0.1" dia.	32 dB/100ft	16 W
24"	60"	72"	Custom Len.
\$77.84	\$73.89	\$74.37	\$74.86
\$75.32	\$75.81	See Web	

58

RG178B/U Coax, 50 Ohm

Part No. <a href="#">PE36528</a>	Cable Dia.	Attn. @ 1 GHz	Power @ 1 GHz
1 piece price shown. See web or call for volume pricing.			
12"	0.072" dia.	44.4 dB/100ft	78 W
24"	60"	72"	Custom Len.
\$95.53	\$96.58	\$97.62	\$98.68
\$99.73	\$100.78	See Web	

59

RG316/U Coax, 50 Ohm

Part No. <a href="#">PE36530</a>	Cable Dia.	Attn. @ 1 GHz	Power @ 1 GHz
1 piece price shown. See web or call for volume pricing.			
12"	0.098" dia.	38 dB/100ft	160 W
24"	60"	72"	Custom Len.
\$74.91	\$78.09	\$81.26	\$84.44
\$87.63	\$90.79	See Web	

60

Cable Assemblies

See Our Website For Current Pricing & Real-Time Stock Availability!

\*Coax Performance at 1 GHz Notes: Cable assembly max frequency may be lower than connector or coax max frequency



For our complete selection of cable assemblies, please visit our website

10-32 MALE TO BNC MALE						
Standard Flexible Cable Assemblies						
RG174A/U Coax, 50 Ohm						
Part No. <a href="#">PE3C3275</a>	Cable Dia.	Attn. @ 1 GHz	Power @ 1 GHz			
1 piece price shown. See web or call for volume pricing.	0.11" dia.	32 dB/100ft	17 W			
12" 24" 36" 48"	60"	72"	Custom Len.			
\$55.45 \$56.08 \$56.73 \$57.40	\$58.04	\$58.69	See Web			
RG178B/U Coax, 50 Ohm						
Part No. <a href="#">PE36540</a>	Cable Dia.	Attn. @ 1 GHz	Power @ 1 GHz			
1 piece price shown. See web or call for volume pricing.	0.072" dia.	44.4 dB/100ft	78 W			
12" 24" 36" 48"	60"	72"	Custom Len.			
\$90.49 \$91.65 \$92.81 \$93.97	\$88.52	\$89.59	\$90.63			
RG316/U Coax, 50 Ohm						
Part No. <a href="#">PE3C3424</a>	Cable Dia.	Attn. @ 1 GHz	Power @ 1 GHz			
1 piece price shown. See web or call for volume pricing.	0.102" dia.	38 dB/100ft	160 W			
12" 24" 36" 48"	60"	72"	Custom Len.			
\$53.81 \$56.75 \$59.72 \$62.89	\$67.33	\$70.82	See Web			
10-32 MALE RIGHT ANGLE TO 10-32 MALE RIGHT ANGLE						
Standard Flexible Cable Assemblies						
RG174A/U Coax, 50 Ohm						
Part No. <a href="#">PE36532</a>	Cable Dia.	Attn. @ 1 GHz	Power @ 1 GHz			
1 piece price shown. See web or call for volume pricing.	0.1" dia.	32 dB/100ft	16 W			
12" 24" 36" 48"	60"	72"	Custom Len.			
\$72.22 \$72.74 \$73.21 \$73.68	\$74.19	\$74.67	See Web			
RG178B/U Coax, 50 Ohm						
Part No. <a href="#">PE36534</a>	Cable Dia.	Attn. @ 1 GHz	Power @ 1 GHz			
1 piece price shown. See web or call for volume pricing.	0.072" dia.	44.4 dB/100ft	78 W			
12" 24" 36" 48"	60"	72"	Custom Len.			
\$104.40 \$105.46 \$106.51 \$107.57	\$107.11	\$114.98	See Web			
RG316/U Coax, 50 Ohm						
Part No. <a href="#">PE36536</a>	Cable Dia.	Attn. @ 1 GHz	Power @ 1 GHz			
1 piece price shown. See web or call for volume pricing.	0.098" dia.	38 dB/100ft	160 W			
12" 24" 36" 48"	60"	72"	Custom Len.			
\$75.04 \$78.37 \$81.66 \$84.96	\$88.25	\$97.05	See Web			
10-32 MALE RIGHT ANGLE TO BNC FEMALE						
Low Loss Flexible Cable Assemblies						
LMR-100A-PVC Coax, 50 Ohm						
Part No. <a href="#">PE3C2998</a>	Cable Dia.	Attn. @ 1 GHz	Power @ 1 GHz			
1 piece price shown. See web or call for volume pricing.	0.11" dia.	24 dB/100ft	303.4 W			
12" 24" 36" 48"	60"	50CM	Custom Len.			
\$53.97 \$54.24 \$54.63 \$55.40	\$56.16	\$54.07	See Web			
10-32 MALE RIGHT ANGLE TO SMP FEMALE						
Flexible Flexible Cable Assemblies						
RG178B/U Coax, 50 Ohm						
Part No. <a href="#">PE3C7720</a>	Cable Dia.	Attn. @ 1 GHz	Power @ 1 GHz			
1 piece price shown. See web or call for volume pricing.	0.072" dia.	44.41 dB/100ft	55 W			
12" 24" 36" 48"	60"	50CM	Custom Len.			
\$77.84 \$79.09 \$80.35 \$81.60	\$82.85	\$77.39	See Web			
10-32 FEMALE TO BNC MALE						
Standard Flexible Cable Assemblies						
RG178B/U Coax, 50 Ohm						
Part No. <a href="#">PE3W03496</a>	Cable Dia.	Attn. @ 1 GHz	Power @ 1 GHz			
1 piece price shown. See web or call for volume pricing.	0.072" dia.	44.41 dB/100ft	55 W			
12" 24" 36" 48"	60"	50CM	Custom Len.			
\$74.09 \$75.23 \$76.35 \$77.47	\$78.61	\$74.81	See Web			
BMA PLUG BULKHEAD TO BMA PLUG BULKHEAD						
SEE MOUNTING HOLE SECTION ON PAGE 409						
Formable Cable Assemblies						
PE-SR402FLJ Coax, 50 Ohm						
Part No. <a href="#">PE3C4899</a>	Cable Dia.	Attn. @ 1 GHz	Power @ 1 GHz			
1 piece price shown. See web or call for volume pricing.	0.161" dia.	11.89 dB/100ft	303.4 W			
6" 12" 24" 36"	60"	-	Custom Len.			
\$77.55 \$81.58 \$89.64 \$97.70	\$112.25	-	See Web			

PE-SR405FLJ Coax, 50 Ohm						
Part No. <a href="#">PE3C4844</a>	Cable Dia.	Attn. @ 1 GHz	Power @ 1 GHz			
1 piece price shown. See web or call for volume pricing.	0.105" dia.	19.5 dB/100ft	121.5 W			
6" 12" 24" 36" 60"	-	-	Custom Len.			
\$79.57 \$83.72 \$91.98 \$100.25 \$115.18	-	-	See Web			
Flexible Cable Assemblies						
RG316/U Coax, 50 Ohm						
Part No. <a href="#">PE3C4936</a>	Cable Dia.	Attn. @ 1 GHz	Power @ 1 GHz			
1 piece price shown. See web or call for volume pricing.	0.098" dia.	38 dB/100ft	160 W			
6" 12" 24" 36" 60"	-	-	Custom Len.			
\$118.42 \$119.96 \$122.98 \$126.02 \$132.10	-	-	See Web			
RG400/U Coax, 50 Ohm						
Part No. <a href="#">PE3C4950</a>	Cable Dia.	Attn. @ 1 GHz	Power @ 1 GHz			
1 piece price shown. See web or call for volume pricing.	0.195" dia.	14.7 dB/100ft	600 W			
6" 12" 24" 36" 60"	-	-	Custom Len.			
\$93.03 \$96.74 \$104.17 \$110.05 \$124.74	-	-	See Web			
LMR-100A-PVC Coax, 50 Ohm						
Part No. <a href="#">PE3C4921</a>	Cable Dia.	Attn. @ 1 GHz	Power @ 1 GHz			
1 piece price shown. See web or call for volume pricing.	0.11" dia.	24 dB/100ft	160 W			
6" 12" 24" 36" 60"	-	-	Custom Len.			
\$112.13 \$112.53 \$113.33 \$114.13 \$115.74	-	-	See Web			
Semi-Rigid Cable Assemblies						
RG405/U Coax, 50 Ohm						
Part No. <a href="#">PE3C4872</a>	Cable Dia.	Attn. @ 1 GHz	Power @ 1 GHz			
1 piece price shown. See web or call for volume pricing.	22 dB/100ft	-	130 W			
6" 12" 24" 36" 60"	-	-	Custom Len.			
\$79.10 \$82.77 \$90.09 \$98.84 \$110.53	-	-	See Web			
BMA PLUG BULKHEAD TO BMA JACK						
SEE MOUNTING HOLE SECTION ON PAGE 409						
Formable Cable Assemblies						
PE-SR402FLJ Coax, 50 Ohm						
Part No. <a href="#">PE3C4904</a>	Cable Dia.	Attn. @ 1 GHz	Power @ 1 GHz			
1 piece price shown. See web or call for volume pricing.	0.161" dia.	11.89 dB/100ft	303.4 W			
6" 12" 24" 36" 60"	-	-	Custom Len.			
\$136.24 \$140.20 \$148.16 \$156.10 \$171.99	-	-	See Web			
PE-SR405FLJ Coax, 50 Ohm						
Part No. <a href="#">PE3C4852</a>	Cable Dia.	Attn. @ 1 GHz	Power @ 1 GHz			
1 piece price shown. See web or call for volume pricing.	0.105" dia.	19.5 dB/100ft	121.5 W			
6" 12" 24" 36" 60"	-	-	Custom Len.			
\$125.41 \$129.49 \$137.66 \$145.81 \$162.13	-	-	See Web			
Flexible Cable Assemblies						
RG316/U Coax, 50 Ohm						
Part No. <a href="#">PE3C4940</a>	Cable Dia.	Attn. @ 1 GHz	Power @ 1 GHz			
1 piece price shown. See web or call for volume pricing.	0.098" dia.	38 dB/100ft	160 W			
6" 12" 24" 36" 60"	-	-	Custom Len.			
\$150.87 \$152.42 \$155.44 \$158.48 \$164.56	-	-	See Web			
RG400/U Coax, 50 Ohm						
Part No. <a href="#">PE3C4953</a>	Cable Dia.	Attn. @ 1 GHz	Power @ 1 GHz			
1 piece price shown. See web or call for volume pricing.	0.195" dia.	14.7 dB/100ft	600 W			
6" 12" 24" 36" 60"	-	-	Custom Len.			
\$165.93 \$169.61 \$176.94 \$184.27 \$198.95	-	-	See Web			
LMR-100A-PVC Coax, 50 Ohm						
Part No. <a href="#">PE3C4925</a>	Cable Dia.	Attn. @ 1 GHz	Power @ 1 GHz			
1 piece price shown. See web or call for volume pricing.	0.11" dia.	24 dB/100ft	160 W			
6" 12" 24" 36" 60"	-	-	Custom Len.			
\$144.59 \$144.98 \$145.79 \$146.58 \$148.19	-	-	See Web			
Semi-Rigid Cable Assemblies						
RG405/U Coax, 50 Ohm						
Part No. <a href="#">PE3C4879</a>	Cable Dia.	Attn. @ 1 GHz	Power @ 1 GHz			
1 piece price shown. See web or call for volume pricing.	22 dB/100ft	-	130 W			
6" 12" 24" 36" 60"	-	-	Custom Len.			
\$124.96 \$128.56 \$135.78 \$143.01 \$157.48	-	-	See Web			
BMA PLUG BULKHEAD TO BMA JACK BULKHEAD						
SEE MOUNTING HOLE SECTION ON PAGE 409						
Formable Cable Assemblies						
PE-SR405FLJ Coax, 50 Ohm						
Part No. <a href="#">PE3C4851</a>	Cable Dia.	Attn. @ 1 GHz	Power @ 1 GHz			
1 piece price shown. See web or call for volume pricing.	0.105" dia.	19.5 dB/100ft	121.5 W			
6" 12" 24" 36" 60"	-	-	Custom Len.			
\$100.44 \$104.58 \$111.29 \$119.46 \$135.76	-	-	See Web			
Semi-Rigid Cable Assemblies						
RG405/U Coax, 50 Ohm						
Part No. <a href="#">PE3C4878</a>	Cable Dia.	Attn. @ 1 GHz	Power @ 1 GHz			
1 piece price shown. See web or call for volume pricing.	22 dB/100ft	-	130 W			
6" 12" 24" 36" 60"	-	-	Custom Len.			
\$99.97 \$103.64 \$109.42 \$116.65 \$131.12	-	-	See Web			

Cable Assemblies

See Our Website For Current Pricing & Real-Time Stock Availability!

For Custom Lengths, Metric Lengths or Special Configurations, Please call (949) 261-1920



Technical Support  
+1 (949) 261-1920



Same-Day Shipping,  
Even Custom Cable Assemblies



For our complete selection of cable assemblies, please visit our website

**BMA PLUG BULKHEAD TO BMA JACK  
2 HOLE FLANGE**



SEE MOUNTING HOLE SECTION ON PAGE 409

**Formable Cable Assemblies**

**PE-SR402FLJ Coax, 50 Ohm**

Part No. <a href="#">PE3C4903</a>	Cable Dia.	Attn. @ 1 GHz	Power @ 1 GHz
1 piece price shown. See web or call for volume pricing.			
6"	12"	24"	36"
\$92.95	\$96.99	\$105.05	\$111.54
		\$127.42	-
			Custom Len.
			See Web

**PE-SR405FLJ Coax, 50 Ohm**

Part No. <a href="#">PE3C4850</a>	Cable Dia.	Attn. @ 1 GHz	Power @ 1 GHz
1 piece price shown. See web or call for volume pricing.			
6"	12"	24"	36"
\$106.75	\$109.37	\$117.53	\$125.67
		\$142.00	-
			Custom Len.
			See Web

**Flexible Cable Assemblies**

**RG316/U Coax, 50 Ohm**

Part No. <a href="#">PE3C4939</a>	Cable Dia.	Attn. @ 1 GHz	Power @ 1 GHz
1 piece price shown. See web or call for volume pricing.			
6"	12"	24"	36"
\$113.64	\$115.18	\$118.20	\$121.24
		\$127.33	-
			Custom Len.
			See Web

**LMR-100A-PVC Coax, 50 Ohm**

Part No. <a href="#">PE3C4924</a>	Cable Dia.	Attn. @ 1 GHz	Power @ 1 GHz
1 piece price shown. See web or call for volume pricing.			
6"	12"	24"	36"
\$107.36	\$107.75	\$108.56	\$109.36
		\$110.95	-
			Custom Len.
			See Web

**Semi-Rigid Cable Assemblies**

**RG405/U Coax, 50 Ohm**

Part No. <a href="#">PE3C4877</a>	Cable Dia.	Attn. @ 1 GHz	Power @ 1 GHz
1 piece price shown. See web or call for volume pricing.			
6"	12"	24"	36"
\$106.31	\$108.42	\$115.64	\$122.87
		\$137.35	-
			Custom Len.
			See Web

**BMA PLUG BULKHEAD TO BMA JACK  
RIGHT ANGLE 2 HOLE FLANGE**



SEE MOUNTING HOLE SECTION ON PAGE 409

**Formable Cable Assemblies**

**PE-SR402FLJ Coax, 50 Ohm**

Part No. <a href="#">PE3C4905</a>	Cable Dia.	Attn. @ 1 GHz	Power @ 1 GHz
1 piece price shown. See web or call for volume pricing.			
6"	12"	24"	36"
\$123.15	\$127.13	\$135.09	\$143.02
		\$158.91	-
			Custom Len.
			See Web

**PE-SR405FLJ Coax, 50 Ohm**

Part No. <a href="#">PE3C4853</a>	Cable Dia.	Attn. @ 1 GHz	Power @ 1 GHz
1 piece price shown. See web or call for volume pricing.			
6"	12"	24"	36"
\$118.17	\$122.25	\$130.40	\$138.57
		\$154.89	-
			Custom Len.
			See Web

**Flexible Cable Assemblies**

**RG400/U Coax, 50 Ohm**

Part No. <a href="#">PE3C4954</a>	Cable Dia.	Attn. @ 1 GHz	Power @ 1 GHz
1 piece price shown. See web or call for volume pricing.			
6"	12"	24"	36"
\$115.69	\$119.37	\$126.70	\$134.02
		\$148.70	-
			Custom Len.
			See Web

**Semi-Rigid Cable Assemblies**

**RG405/U Coax, 50 Ohm**

Part No. <a href="#">PE3C4880</a>	Cable Dia.	Attn. @ 1 GHz	Power @ 1 GHz
1 piece price shown. See web or call for volume pricing.			
6"	12"	24"	36"
\$117.72	\$121.33	\$128.54	\$135.77
		\$150.23	-
			Custom Len.
			See Web

**BMA PLUG BULKHEAD TO BNC MALE**



SEE MOUNTING HOLE SECTION ON PAGE 409

**Formable Cable Assemblies**

**PE-SR402FLJ Coax, 50 Ohm**

Part No. <a href="#">PE3C4918</a>	Cable Dia.	Attn. @ 1 GHz	Power @ 1 GHz
1 piece price shown. See web or call for volume pricing.			
6"	12"	24"	36"
\$76.77	\$80.82	\$88.87	\$96.92
		\$111.48	-
			Custom Len.
			See Web

**Flexible Cable Assemblies**

**RG316/U Coax, 50 Ohm**

Part No. <a href="#">PE3C4949</a>	Cable Dia.	Attn. @ 1 GHz	Power @ 1 GHz
1 piece price shown. See web or call for volume pricing.			
6"	12"	24"	36"
\$76.12	\$77.68	\$80.75	\$83.82
		\$89.99	-
			Custom Len.
			See Web

**RG400/U Coax, 50 Ohm**

Part No. <a href="#">PE3C4963</a>	Cable Dia.	Attn. @ 1 GHz	Power @ 1 GHz
1 piece price shown. See web or call for volume pricing.			
6"	12"	24"	36"
\$64.10	\$67.84	\$75.26	\$82.69
		\$97.57	-
			Custom Len.
			See Web

**LMR-100A-PVC Coax, 50 Ohm**

Part No. <a href="#">PE3C4935</a>	Cable Dia.	Attn. @ 1 GHz	Power @ 1 GHz
1 piece price shown. See web or call for volume pricing.			
6"	12"	24"	36"
\$69.73	\$70.14	\$70.96	\$71.77
		\$73.38	-
			Custom Len.
			See Web

**BMA PLUG BULKHEAD TO N MALE**



SEE MOUNTING HOLE SECTION ON PAGE 409

**Formable Cable Assemblies**

**PE-SR402FLJ Coax, 50 Ohm**

Part No. <a href="#">PE3C4912</a>	Cable Dia.	Attn. @ 1 GHz	Power @ 1 GHz
1 piece price shown. See web or call for volume pricing.			
6"	12"	24"	36"
\$68.63	\$72.66	\$80.72	\$88.78
		\$104.89	-
			Custom Len.
			See Web

**PE-SR405FLJ Coax, 50 Ohm**

Part No. <a href="#">PE3C4860</a>	Cable Dia.	Attn. @ 1 GHz	Power @ 1 GHz
1 piece price shown. See web or call for volume pricing.			
6"	12"	24"	36"
\$69.69	\$73.82	\$82.10	\$90.36
		\$106.92	-
			Custom Len.
			See Web

**Flexible Cable Assemblies**

**RG316/U Coax, 50 Ohm**

Part No. <a href="#">PE3C4945</a>	Cable Dia.	Attn. @ 1 GHz	Power @ 1 GHz
1 piece price shown. See web or call for volume pricing.			
6"	12"	24"	36"
\$98.76	\$87.93	\$87.93	\$91.01
		\$94.08	-
			Custom Len.
			See Web

**RG400/U Coax, 50 Ohm**

Part No. <a href="#">PE3C4959</a>	Cable Dia.	Attn. @ 1 GHz	Power @ 1 GHz
1 piece price shown. See web or call for volume pricing.			
6"	12"	24"	36"
\$74.99	\$78.72	\$86.15	\$93.59
		\$106.95	-
			Custom Len.
			See Web

**LMR-100A-PVC Coax, 50 Ohm**

Part No. <a href="#">PE3C4931</a>	Cable Dia.	Attn. @ 1 GHz	Power @ 1 GHz
1 piece price shown. See web or call for volume pricing.			
6"	12"	24"	36"
\$79.99	\$80.40	\$81.21	\$82.03
		\$83.65	-
			Custom Len.
			See Web

**Semi-Rigid Cable Assemblies**

**RG405/U Coax, 50 Ohm**

Part No. <a href="#">PE3C4887</a>	Cable Dia.	Attn. @ 1 GHz	Power @ 1 GHz
1 piece price shown. See web or call for volume pricing.			
6"	12"	24"	36"
\$69.22	\$72.89	\$80.21	\$87.54
		\$102.21	-
			Custom Len.
			See Web

**BMA PLUG BULKHEAD TO SMA MALE**



SEE MOUNTING HOLE SECTION ON PAGE 409

**Formable Cable Assemblies**

**PE-SR402FLJ Coax, 50 Ohm**

Part No. <a href="#">PE3C4906</a>	Cable Dia.	Attn. @ 1 GHz	Power @ 1 GHz
1 piece price shown. See web or call for volume pricing.			
6"	12"	24"	36"
\$60.17	\$64.21	\$72.27	\$80.32
		\$96.44	-
			Custom Len.
			See Web

**PE-SR405FLJ Coax, 50 Ohm**

Part No. <a href="#">PE3C4854</a>	Cable Dia.	Attn. @ 1 GHz	Power @ 1 GHz
1 piece price shown. See web or call for volume pricing.			
6"	12"	24"	36"
\$62.06	\$66.21	\$74.47	\$82.74
		\$99.30	-
			Custom Len.
			See Web

**Flexible Cable Assemblies**

**RG316/U Coax, 50 Ohm**

Part No. <a href="#">PE3C4942</a>	Cable Dia.	Attn. @ 1 GHz	Power @ 1 GHz
1 piece price shown. See web or call for volume pricing.			
6"	12"	24"	36"
\$79.75	\$81.31	\$84.37	\$87.46
		\$93.63	-
			Custom Len.
			See Web

**RG400/U Coax, 50 Ohm**

Part No. <a href="#">PE3C4955</a>	Cable Dia.	Attn. @ 1 GHz	Power @ 1 GHz
1 piece price shown. See web or call for volume pricing.			
6"	12"	24"	36"
\$69.06	\$72.78	\$80.21	\$87.65
		\$102.52	-
			Custom Len.
			See Web

**LMR-100A-PVC Coax, 50 Ohm**

Part No. <a href="#">PE3C4927</a>	Cable Dia.	Attn. @ 1 GHz	Power @ 1 GHz
1 piece price shown. See web or call for volume pricing.			
6"	12"	24"	36"
\$73.36	\$73.78	\$74.60	\$75.39
		\$77.02	-
			Custom Len.
			See Web

**Semi-Rigid Cable Assemblies**

**RG405/U Coax, 50 Ohm**

Part No. <a href="#">PE3C4881</a>	Cable Dia.	Attn. @ 1 GHz	Power @ 1 GHz
1 piece price shown. See web or call for volume pricing.			
6"	12"	24"	36"
\$61.60	\$65.27	\$72.59	\$79.91
		\$94.58	-
			Custom Len.
			See Web

Cable Assemblies

See Our Website For Current Pricing & Real-Time Stock Availability!

\*Coax Performance at 1 GHz Notes: Cable assembly max frequency may be lower than connector or coax max frequency

For our complete selection of cable assemblies, please visit our website

<b>BMA PLUG BULKHEAD TO SMA MALE RIGHT ANGLE</b>					
SEE MOUNTING HOLE SECTION ON PAGE 409					
Formable Cable Assemblies					
PE-SR402FLJ Coax, 50 Ohm					
Part No. <a href="#">PE3C4909</a>	Cable Dia.	Attn. @ 1 GHz	Power @ 1 GHz		
1 piece price shown. See web or call for volume pricing.					
6"	12"	24"	36"	60"	Custom Len.
\$63.09	\$67.12	\$75.19	\$83.24	\$99.35	See Web
PE-SR405FLJ Coax, 50 Ohm					
Part No. <a href="#">PE3C4857</a>	Cable Dia.	Attn. @ 1 GHz	Power @ 1 GHz		
1 piece price shown. See web or call for volume pricing.					
6"	12"	24"	36"	60"	Custom Len.
\$64.16	\$68.28	\$76.57	\$84.84	\$101.37	See Web
Flexible Cable Assemblies					
RG316/U Coax, 50 Ohm					
Part No. <a href="#">PE3C4386</a>	Cable Dia.	Attn. @ 1 GHz	Power @ 1 GHz		
1 piece price shown. See web or call for volume pricing.					
6"	12"	24"	36"	60"	Custom Len.
\$95.97	\$97.52	\$100.57	\$103.66	\$108.30	See Web
RG400/U Coax, 50 Ohm					
Part No. <a href="#">PE3C4957</a>	Cable Dia.	Attn. @ 1 GHz	Power @ 1 GHz		
1 piece price shown. See web or call for volume pricing.					
6"	12"	24"	36"	60"	Custom Len.
\$79.95	\$83.67	\$91.10	\$98.53	\$111.84	See Web
LMR-100A-PVC Coax, 50 Ohm					
Part No. <a href="#">PE3C4929</a>	Cable Dia.	Attn. @ 1 GHz	Power @ 1 GHz		
1 piece price shown. See web or call for volume pricing.					
6"	12"	24"	36"	60"	Custom Len.
\$84.37	\$86.06	\$86.88	\$86.37	\$87.96	See Web
Semi-Rigid Cable Assemblies					
RG405/U Coax, 50 Ohm					
Part No. <a href="#">PE3C4884</a>	Cable Dia.	Attn. @ 1 GHz	Power @ 1 GHz		
1 piece price shown. See web or call for volume pricing.					
6"	12"	24"	36"	60"	Custom Len.
\$63.68	\$67.35	\$74.68	\$82.01	\$96.68	See Web
<b>BMA PLUG BULKHEAD TO SMP FEMALE</b>					
SEE MOUNTING HOLE SECTION ON PAGE 409					
Formable Cable Assemblies					
PE-SR405FLJ Coax, 50 Ohm					
Part No. <a href="#">PE3C4866</a>	Cable Dia.	Attn. @ 1 GHz	Power @ 1 GHz		
1 piece price shown. See web or call for volume pricing.					
6"	12"	24"	36"	60"	Custom Len.
\$71.51	\$75.64	\$83.92	\$92.19	\$107.23	See Web
Semi-Rigid Cable Assemblies					
RG405/U Coax, 50 Ohm					
Part No. <a href="#">PE3C4893</a>	Cable Dia.	Attn. @ 1 GHz	Power @ 1 GHz		
1 piece price shown. See web or call for volume pricing.					
6"	12"	24"	36"	60"	Custom Len.
\$71.05	\$74.71	\$82.03	\$89.36	\$104.02	See Web
<b>BMA PLUG BULKHEAD TO SMP FEMALE RIGHT ANGLE</b>					
SEE MOUNTING HOLE SECTION ON PAGE 409					
Formable Cable Assemblies					
PE-SR405FLJ Coax, 50 Ohm					
Part No. <a href="#">PE3C4869</a>	Cable Dia.	Attn. @ 1 GHz	Power @ 1 GHz		
1 piece price shown. See web or call for volume pricing.					
6"	12"	24"	36"	60"	Custom Len.
\$84.43	\$88.56	\$96.85	\$105.12	\$119.98	See Web
Semi-Rigid Cable Assemblies					
RG405/U Coax, 50 Ohm					
Part No. <a href="#">PE3C4896</a>	Cable Dia.	Attn. @ 1 GHz	Power @ 1 GHz		
1 piece price shown. See web or call for volume pricing.					
6"	12"	24"	36"	60"	Custom Len.
\$83.97	\$87.64	\$94.95	\$102.28	\$115.32	See Web
<b>BMA PLUG BULKHEAD TO TNC MALE</b>					
SEE MOUNTING HOLE SECTION ON PAGE 409					
Formable Cable Assemblies					
PE-SR402FLJ Coax, 50 Ohm					
Part No. <a href="#">PE3C4915</a>	Cable Dia.	Attn. @ 1 GHz	Power @ 1 GHz		
1 piece price shown. See web or call for volume pricing.					
6"	12"	24"	36"	60"	Custom Len.
\$65.14	\$69.19	\$77.25	\$85.29	\$101.42	See Web

<b>PE-SR405FLJ Coax, 50 Ohm</b>					
Part No. <a href="#">PE3C4863</a>	Cable Dia.	Attn. @ 1 GHz	Power @ 1 GHz		
1 piece price shown. See web or call for volume pricing.					
6"	12"	24"	36"	60"	Custom Len.
\$66.21	\$70.36	\$78.62	\$86.90	\$103.44	See Web
Flexible Cable Assemblies					
RG400/U Coax, 50 Ohm					
Part No. <a href="#">PE3C4961</a>	Cable Dia.	Attn. @ 1 GHz	Power @ 1 GHz		
1 piece price shown. See web or call for volume pricing.					
6"	12"	24"	36"	60"	Custom Len.
\$69.01	\$72.73	\$80.16	\$87.60	\$102.48	See Web
Semi-Rigid Cable Assemblies					
RG405/U Coax, 50 Ohm					
Part No. <a href="#">PE3C4890</a>	Cable Dia.	Attn. @ 1 GHz	Power @ 1 GHz		
1 piece price shown. See web or call for volume pricing.					
6"	12"	24"	36"	60"	Custom Len.
\$65.73	\$69.41	\$76.73	\$84.06	\$98.73	See Web
<b>BMA JACK TO BMA JACK</b>					
Formable Cable Assemblies					
PE-SR402FLJ Coax, 50 Ohm					
Part No. <a href="#">PE3C4901</a>	Cable Dia.	Attn. @ 1 GHz	Power @ 1 GHz		
1 piece price shown. See web or call for volume pricing.					
6"	12"	24"	36"	60"	Custom Len.
\$196.00	\$199.96	\$207.91	\$215.86	\$231.75	See Web
PE-SR405FLJ Coax, 50 Ohm					
Part No. <a href="#">PE3C4848</a>	Cable Dia.	Attn. @ 1 GHz	Power @ 1 GHz		
1 piece price shown. See web or call for volume pricing.					
6"	12"	24"	36"	60"	Custom Len.
\$172.36	\$176.44	\$184.60	\$192.76	\$209.09	See Web
Flexible Cable Assemblies					
RG316/U Coax, 50 Ohm					
Part No. <a href="#">PE3C4938</a>	Cable Dia.	Attn. @ 1 GHz	Power @ 1 GHz		
1 piece price shown. See web or call for volume pricing.					
6"	12"	24"	36"	60"	Custom Len.
\$183.33	\$184.86	\$187.88	\$190.93	\$197.01	See Web
RG400/U Coax, 50 Ohm					
Part No. <a href="#">PE3C4951</a>	Cable Dia.	Attn. @ 1 GHz	Power @ 1 GHz		
1 piece price shown. See web or call for volume pricing.					
6"	12"	24"	36"	60"	Custom Len.
\$240.15	\$243.83	\$251.15	\$258.49	\$273.17	See Web
LMR-100A-PVC Coax, 50 Ohm					
Part No. <a href="#">PE3C4923</a>	Cable Dia.	Attn. @ 1 GHz	Power @ 1 GHz		
1 piece price shown. See web or call for volume pricing.					
6"	12"	24"	36"	60"	Custom Len.
\$177.03	\$177.43	\$178.23	\$179.04	\$180.63	See Web
Semi-Rigid Cable Assemblies					
RG405/U Coax, 50 Ohm					
Part No. <a href="#">PE3C4875</a>	Cable Dia.	Attn. @ 1 GHz	Power @ 1 GHz		
1 piece price shown. See web or call for volume pricing.					
6"	12"	24"	36"	60"	Custom Len.
\$171.91	\$175.52	\$182.74	\$189.97	\$204.43	See Web
<b>BMA JACK TO BNC MALE</b>					
Formable Cable Assemblies					
PE-SR402FLJ Coax, 50 Ohm					
Part No. <a href="#">PE3C4920</a>	Cable Dia.	Attn. @ 1 GHz	Power @ 1 GHz		
1 piece price shown. See web or call for volume pricing.					
6"	12"	24"	36"	60"	Custom Len.
\$135.46	\$139.45	\$147.39	\$155.34	\$171.24	See Web
Flexible Cable Assemblies					
RG316/U Coax, 50 Ohm					
Part No. <a href="#">PE3C4948</a>	Cable Dia.	Attn. @ 1 GHz	Power @ 1 GHz		
1 piece price shown. See web or call for volume pricing.					
6"	12"	24"	36"	60"	Custom Len.
\$107.52	\$109.06	\$112.07	\$115.12	\$121.20	See Web
RG400/U Coax, 50 Ohm					
Part No. <a href="#">PE3C4964</a>	Cable Dia.	Attn. @ 1 GHz	Power @ 1 GHz		
1 piece price shown. See web or call for volume pricing.					
6"	12"	24"	36"	60"	Custom Len.
\$137.43	\$141.10	\$148.43	\$155.76	\$170.43	See Web
LMR-100A-PVC Coax, 50 Ohm					
Part No. <a href="#">PE3C4934</a>	Cable Dia.	Attn. @ 1 GHz	Power @ 1 GHz		
1 piece price shown. See web or call for volume pricing.					
6"	12"	24"	36"	60"	Custom Len.
\$102.65	\$103.06	\$103.88	\$104.68	\$106.31	See Web

Cable Assemblies

See Our Website For Current Pricing & Real-Time Stock Availability!

For Custom Lengths, Metric Lengths or Special Configurations, Please call (949) 261-1920

Technical Support  
+1 (949) 261-1920

Same-Day Shipping,  
Even Custom Cable Assemblies

For our complete selection of cable assemblies, please visit our website

**BMA JACK TO N MALE**



**Formable Cable Assemblies**

PE-SR402FLJ Coax, 50 Ohm				
Part No. <a href="#">PE3C4914</a>	Cable Dia.	Attn. @ 1 GHz	Power @ 1 GHz	
1 piece price shown. See web or call for volume pricing.				
6"	12"	24"	36"	60"
\$127.42	\$131.42	\$139.35	\$147.31	\$163.18
-	-	-	-	See Web

34

PE-SR405FLJ Coax, 50 Ohm				
Part No. <a href="#">PE3C4862</a>	Cable Dia.	Attn. @ 1 GHz	Power @ 1 GHz	
1 piece price shown. See web or call for volume pricing.				
6"	12"	24"	36"	60"
\$115.66	\$119.75	\$127.91	\$136.06	\$152.39
-	-	-	-	See Web

35

**Flexible Cable Assemblies**

RG316/U Coax, 50 Ohm				
Part No. <a href="#">PE3C4944</a>	Cable Dia.	Attn. @ 1 GHz	Power @ 1 GHz	
1 piece price shown. See web or call for volume pricing.				
6"	12"	24"	36"	60"
\$117.63	\$119.17	\$122.19	\$125.24	\$131.31
-	-	-	-	See Web

36

RG400/U Coax, 50 Ohm				
Part No. <a href="#">PE3C4960</a>	Cable Dia.	Attn. @ 1 GHz	Power @ 1 GHz	
1 piece price shown. See web or call for volume pricing.				
6"	12"	24"	36"	60"
\$148.17	\$151.85	\$159.17	\$166.50	\$181.17
-	-	-	-	See Web

37

LMR-100A-PVC Coax, 50 Ohm				
Part No. <a href="#">PE3C4930</a>	Cable Dia.	Attn. @ 1 GHz	Power @ 1 GHz	
1 piece price shown. See web or call for volume pricing.				
6"	12"	24"	36"	60"
\$111.33	\$111.74	\$112.54	\$113.34	\$114.94
-	-	-	-	See Web

38

**Semi-Rigid Cable Assemblies**

RG405/U Coax, 50 Ohm				
Part No. <a href="#">PE3C4889</a>	Cable Dia.	Attn. @ 1 GHz	Power @ 1 GHz	
1 piece price shown. See web or call for volume pricing.				
6"	12"	24"	36"	60"
\$115.22	\$118.83	\$126.04	\$133.27	\$147.73
-	-	-	-	See Web

39

**BMA JACK TO SMA MALE**



**Formable Cable Assemblies**

PE-SR402FLJ Coax, 50 Ohm				
Part No. <a href="#">PE3C4908</a>	Cable Dia.	Attn. @ 1 GHz	Power @ 1 GHz	
1 piece price shown. See web or call for volume pricing.				
6"	12"	24"	36"	60"
\$119.09	\$123.08	\$131.02	\$138.97	\$154.87
-	-	-	-	See Web

40

PE-SR405FLJ Coax, 50 Ohm				
Part No. <a href="#">PE3C4856</a>	Cable Dia.	Attn. @ 1 GHz	Power @ 1 GHz	
1 piece price shown. See web or call for volume pricing.				
6"	12"	24"	36"	60"
\$108.15	\$112.25	\$120.39	\$136.71	\$144.88
-	-	-	-	See Web

41

**Flexible Cable Assemblies**

RG316/U Coax, 50 Ohm				
Part No. <a href="#">PE3C4941</a>	Cable Dia.	Attn. @ 1 GHz	Power @ 1 GHz	
1 piece price shown. See web or call for volume pricing.				
6"	12"	24"	36"	60"
\$111.11	\$112.62	\$115.64	\$118.70	\$124.78
-	-	-	-	See Web

42

RG400/U Coax, 50 Ohm				
Part No. <a href="#">PE3C4956</a>	Cable Dia.	Attn. @ 1 GHz	Power @ 1 GHz	
1 piece price shown. See web or call for volume pricing.				
6"	12"	24"	36"	60"
\$142.32	\$145.98	\$153.31	\$160.64	\$175.33
-	-	-	-	See Web

43

LMR-100A-PVC Coax, 50 Ohm				
Part No. <a href="#">PE3C4926</a>	Cable Dia.	Attn. @ 1 GHz	Power @ 1 GHz	
1 piece price shown. See web or call for volume pricing.				
6"	12"	24"	36"	60"
\$106.27	\$106.69	\$107.50	\$106.81	\$108.39
-	-	-	-	See Web

44

**Semi-Rigid Cable Assemblies**

RG405/U Coax, 50 Ohm				
Part No. <a href="#">PE3C4883</a>	Cable Dia.	Attn. @ 1 GHz	Power @ 1 GHz	
1 piece price shown. See web or call for volume pricing.				
6"	12"	24"	36"	60"
\$107.70	\$111.31	\$118.53	\$125.75	\$140.21
-	-	-	-	See Web

45

**BMA JACK TO SMA MALE RIGHT ANGLE**



**Formable Cable Assemblies**

PE-SR402FLJ Coax, 50 Ohm				
Part No. <a href="#">PE3C4917</a>	Cable Dia.	Attn. @ 1 GHz	Power @ 1 GHz	
1 piece price shown. See web or call for volume pricing.				
6"	12"	24"	36"	60"
\$123.99	\$127.98	\$135.93	\$143.87	\$159.77
-	-	-	-	See Web

56

**PE-SR402FLJ Coax, 50 Ohm**

Part No. <a href="#">PE3C4911</a>	Cable Dia.	Attn. @ 1 GHz	Power @ 1 GHz	
1 piece price shown. See web or call for volume pricing.				
6"	12"	24"	36"	60"
\$121.97	\$125.95	\$133.91	\$141.84	\$157.73
-	-	-	-	See Web

46

**PE-SR405FLJ Coax, 50 Ohm**

Part No. <a href="#">PE3C4859</a>	Cable Dia.	Attn. @ 1 GHz	Power @ 1 GHz	
1 piece price shown. See web or call for volume pricing.				
6"	12"	24"	36"	60"
\$110.21	\$114.29	\$122.46	\$130.61	\$146.92
-	-	-	-	See Web

47

**Flexible Cable Assemblies**

**RG316/U Coax, 50 Ohm**

Part No. <a href="#">PE3C4943</a>	Cable Dia.	Attn. @ 1 GHz	Power @ 1 GHz	
1 piece price shown. See web or call for volume pricing.				
6"	12"	24"	36"	60"
\$127.08	\$128.61	\$131.64	\$134.67	\$140.76
-	-	-	-	See Web

48

**RG400/U Coax, 50 Ohm**

Part No. <a href="#">PE3C4958</a>	Cable Dia.	Attn. @ 1 GHz	Power @ 1 GHz	
1 piece price shown. See web or call for volume pricing.				
6"	12"	24"	36"	60"
\$153.06	\$156.73	\$164.05	\$171.38	\$186.05
-	-	-	-	See Web

49

**LMR-100A-PVC Coax, 50 Ohm**

Part No. <a href="#">PE3C4928</a>	Cable Dia.	Attn. @ 1 GHz	Power @ 1 GHz	
1 piece price shown. See web or call for volume pricing.				
6"	12"	24"	36"	60"
\$115.60	\$116.03	\$116.80	\$117.61	\$119.21
-	-	-	-	See Web

50

**Semi-Rigid Cable Assemblies**

**RG405/U Coax, 50 Ohm**

Part No. <a href="#">PE3C4886</a>	Cable Dia.	Attn. @ 1 GHz	Power @ 1 GHz	
1 piece price shown. See web or call for volume pricing.				
6"	12"	24"	36"	60"
\$109.75	\$113.36	\$120.58	\$127.82	\$142.29
-	-	-	-	See Web

51

**BMA JACK TO SMP FEMALE**



**Formable Cable Assemblies**

**PE-SR405FLJ Coax, 50 Ohm**

Part No. <a href="#">PE3C4868</a>	Cable Dia.	Attn. @ 1 GHz	Power @ 1 GHz	
1 piece price shown. See web or call for volume pricing.				
6"	12"	24"	36"	60"
\$117.47	\$121.54	\$129.71	\$137.86	\$154.17
-	-	-	-	See Web

52

**Semi-Rigid Cable Assemblies**

**RG405/U Coax, 50 Ohm**

Part No. <a href="#">PE3C4895</a>	Cable Dia.	Attn. @ 1 GHz	Power @ 1 GHz	
1 piece price shown. See web or call for volume pricing.				
6"	12"	24"	36"	60"
\$117.01	\$120.63	\$127.85	\$135.08	\$149.53
-	-	-	-	See Web

53

**BMA JACK TO SMP FEMALE RIGHT ANGLE**



**Formable Cable Assemblies**

**PE-SR405FLJ Coax, 50 Ohm**

Part No. <a href="#">PE3C4871</a>	Cable Dia.	Attn. @ 1 GHz	Power @ 1 GHz	
1 piece price shown. See web or call for volume pricing.				
6"	12"	24"	36"	60"
\$130.21	\$134.29	\$142.45	\$150.61	\$166.93
-	-	-	-	See Web

54

**Semi-Rigid Cable Assemblies**

**RG405/U Coax, 50 Ohm**

Part No. <a href="#">PE3C4898</a>	Cable Dia.	Attn. @ 1 GHz	Power @ 1 GHz	
1 piece price shown. See web or call for volume pricing.				
6"	12"	24"	36"	60"
\$129.75	\$133.37	\$140.58	\$147.82	\$162.28
-	-	-	-	See Web

55

**BMA JACK TO TNC MALE**



**Formable Cable Assemblies**

**PE-SR402FLJ Coax, 50 Ohm**

Part No. <a href="#">PE3C4917</a>	Cable Dia.	Attn. @ 1 GHz	Power @ 1 GHz	
1 piece price shown. See web or call for volume pricing.				
6"	12"	24"	36"	60"
\$123.99	\$127.98	\$135.93	\$143.87	\$159.77
-	-	-	-	See Web

56

**PE-SR405FLJ Coax, 50 Ohm**

Part No. <a href="#">PE3C4865</a>	Cable Dia.	Attn. @ 1 GHz	Power @ 1 GHz	
1 piece price shown. See web or call for volume pricing.				
6"	12"	24"	36"	60"
\$112.25	\$116.33	\$124.48	\$132.64	\$148.96
-	-	-	-	See Web

57

Cable Assemblies

See Our Website For Current Pricing & Real-Time Stock Availability!

\*Coax Performance at 1 GHz Notes: Cable assembly max frequency may be lower than connector or coax max frequency



For our complete selection of cable assemblies, please visit our website

Flexible Cable Assemblies					
RG400/U Coax, 50 Ohm					
Part No.	PE3C4962	Cable Dia.	Attn. @ 1 GHz	Power @ 1 GHz	
1 piece price shown. See web or call for volume pricing.					
6"	12"	24"	36"	60"	Custom Len.
\$143.22	\$146.89	\$154.22	\$161.55	\$176.22	See Web
Semi-Rigid Cable Assemblies					
RG405/U Coax, 50 Ohm					
Part No.	PE3C4892	Cable Dia.	Attn. @ 1 GHz	Power @ 1 GHz	
1 piece price shown. See web or call for volume pricing.					
6"	12"	24"	36"	60"	Custom Len.
\$111.78	\$115.39	\$122.61	\$129.85	\$144.31	See Web
BMA JACK BULKHEAD TO BMA JACK BULKHEAD					
SEE MOUNTING HOLE SECTION ON PAGE 409					
Formable Cable Assemblies					
PE-SR405FLJ Coax, 50 Ohm					
Part No.	PE3C4846	Cable Dia.	Attn. @ 1 GHz	Power @ 1 GHz	
1 piece price shown. See web or call for volume pricing.					
6"	12"	24"	36"	60"	Custom Len.
\$119.64	\$123.72	\$131.87	\$140.04	\$156.35	See Web
Semi-Rigid Cable Assemblies					
RG405/U Coax, 50 Ohm					
Part No.	PE3C4874	Cable Dia.	Attn. @ 1 GHz	Power @ 1 GHz	
1 piece price shown. See web or call for volume pricing.					
6"	12"	24"	36"	60"	Custom Len.
\$119.18	\$122.79	\$130.01	\$137.24	\$151.69	See Web
BMA JACK 2 HOLE FLANGE TO BMA JACK 2 HOLE FLANGE					
SEE MOUNTING HOLE SECTION ON PAGE 409					
Formable Cable Assemblies					
PE-SR402FLJ Coax, 50 Ohm					
Part No.	PE3C4900	Cable Dia.	Attn. @ 1 GHz	Power @ 1 GHz	
1 piece price shown. See web or call for volume pricing.					
6"	12"	24"	36"	60"	Custom Len.
\$106.86	\$110.83	\$118.77	\$126.73	\$142.62	See Web
Semi-Rigid Cable Assemblies					
PE-SR405FLJ Coax, 50 Ohm					
Part No.	PE3C4845	Cable Dia.	Attn. @ 1 GHz	Power @ 1 GHz	
1 piece price shown. See web or call for volume pricing.					
6"	12"	24"	36"	60"	Custom Len.
\$132.10	\$136.19	\$144.34	\$152.50	\$168.82	See Web
Flexible Cable Assemblies					
RG316/U Coax, 50 Ohm					
Part No.	PE3C4937	Cable Dia.	Attn. @ 1 GHz	Power @ 1 GHz	
1 piece price shown. See web or call for volume pricing.					
6"	12"	24"	36"	60"	Custom Len.
\$108.87	\$110.39	\$113.43	\$116.46	\$122.54	See Web
LMR-100A-PVC Coax, 50 Ohm					
Part No.	PE3C4922	Cable Dia.	Attn. @ 1 GHz	Power @ 1 GHz	
1 piece price shown. See web or call for volume pricing.					
6"	12"	24"	36"	60"	Custom Len.
\$104.01	\$104.42	\$105.24	\$106.05	\$107.67	See Web
Semi-Rigid Cable Assemblies					
RG405/U Coax, 50 Ohm					
Part No.	PE3C4873	Cable Dia.	Attn. @ 1 GHz	Power @ 1 GHz	
1 piece price shown. See web or call for volume pricing.					
6"	12"	24"	36"	60"	Custom Len.
\$131.64	\$135.25	\$142.47	\$149.70	\$164.16	See Web
BMA JACK 2 HOLE FLANGE TO BNC MALE					
SEE MOUNTING HOLE SECTION ON PAGE 409					
Formable Cable Assemblies					
PE-SR402FLJ Coax, 50 Ohm					
Part No.	PE3C4919	Cable Dia.	Attn. @ 1 GHz	Power @ 1 GHz	
1 piece price shown. See web or call for volume pricing.					
6"	12"	24"	36"	60"	Custom Len.
\$92.18	\$96.21	\$104.27	\$110.76	\$126.68	See Web
BMA JACK 2 HOLE FLANGE TO N MALE					
SEE MOUNTING HOLE SECTION ON PAGE 409					
Formable Cable Assemblies					
PE-SR402FLJ Coax, 50 Ohm					
Part No.	PE3C4913	Cable Dia.	Attn. @ 1 GHz	Power @ 1 GHz	
1 piece price shown. See web or call for volume pricing.					
6"	12"	24"	36"	60"	Custom Len.
\$84.03	\$88.07	\$96.12	\$104.18	\$118.62	See Web

PE-SR405FLJ Coax, 50 Ohm						
Part No.	PE3C4861	Cable Dia.	Attn. @ 1 GHz	Power @ 1 GHz		
1 piece price shown. See web or call for volume pricing.						
6"	12"	24"	36"	60"	Custom Len.	
\$96.88	\$101.03	\$107.77	\$115.93	\$132.26	See Web	
Semi-Rigid Cable Assemblies						
RG405/U Coax, 50 Ohm						
Part No.	PE3C4888	Cable Dia.	Attn. @ 1 GHz	Power @ 1 GHz		
1 piece price shown. See web or call for volume pricing.						
6"	12"	24"	36"	60"	Custom Len.	
\$96.42	\$100.09	\$107.40	\$113.14	\$127.60	See Web	
BMA JACK 2 HOLE FLANGE TO SMA MALE						
SEE MOUNTING HOLE SECTION ON PAGE 409						
Formable Cable Assemblies						
PE-SR402FLJ Coax, 50 Ohm						
Part No.	PE3C4907	Cable Dia.	Attn. @ 1 GHz	Power @ 1 GHz		
1 piece price shown. See web or call for volume pricing.						
6"	12"	24"	36"	60"	Custom Len.	
\$75.57	\$79.61	\$87.67	\$95.73	\$110.30	See Web	
Semi-Rigid Cable Assemblies						
PE-SR405FLJ Coax, 50 Ohm						
Part No.	PE3C4855	Cable Dia.	Attn. @ 1 GHz	Power @ 1 GHz		
1 piece price shown. See web or call for volume pricing.						
6"	12"	24"	36"	60"	Custom Len.	
\$89.27	\$93.40	\$101.68	\$108.41	\$124.75	See Web	
Semi-Rigid Cable Assemblies						
RG402/U Coax, 50 Ohm						
Part No.	PE3W06981	Cable Dia.	Attn. @ 1 GHz	Power @ 1 GHz		
1 piece price shown. See web or call for volume pricing.						
6"	12"	24"	36"	48"	60"	Custom Len.
\$100.70	\$107.54	\$115.78	\$124.00	\$132.25	\$106.05	See Web
RG405/U Coax, 50 Ohm						
Part No.	PE3C4882	Cable Dia.	Attn. @ 1 GHz	Power @ 1 GHz		
1 piece price shown. See web or call for volume pricing.						
6"	12"	24"	36"	60"	Custom Len.	
\$88.80	\$92.47	\$99.83	\$107.12	\$120.09	See Web	
BMA JACK 2 HOLE FLANGE TO SMA MALE RIGHT ANGLE						
SEE MOUNTING HOLE SECTION ON PAGE 409						
Formable Cable Assemblies						
PE-SR402FLJ Coax, 50 Ohm						
Part No.	PE3C4910	Cable Dia.	Attn. @ 1 GHz	Power @ 1 GHz		
1 piece price shown. See web or call for volume pricing.						
6"	12"	24"	36"	60"	Custom Len.	
\$78.49	\$82.54	\$90.58	\$98.65	\$113.16	See Web	
Semi-Rigid Cable Assemblies						
PE-SR405FLJ Coax, 50 Ohm						
Part No.	PE3C4858	Cable Dia.	Attn. @ 1 GHz	Power @ 1 GHz		
1 piece price shown. See web or call for volume pricing.						
6"	12"	24"	36"	60"	Custom Len.	
\$91.35	\$95.49	\$103.76	\$110.48	\$126.79	See Web	
Semi-Rigid Cable Assemblies						
RG405/U Coax, 50 Ohm						
Part No.	PE3C4885	Cable Dia.	Attn. @ 1 GHz	Power @ 1 GHz		
1 piece price shown. See web or call for volume pricing.						
6"	12"	24"	36"	60"	Custom Len.	
\$90.88	\$94.55	\$101.87	\$107.69	\$122.15	See Web	
BMA JACK 2 HOLE FLANGE TO SMP FEMALE						
SEE MOUNTING HOLE SECTION ON PAGE 409						
Formable Cable Assemblies						
PE-SR405FLJ Coax, 50 Ohm						
Part No.	PE3C4867	Cable Dia.	Attn. @ 1 GHz	Power @ 1 GHz		
1 piece price shown. See web or call for volume pricing.						
6"	12"	24"	36"	60"	Custom Len.	
\$98.71	\$102.84	\$109.57	\$117.74	\$134.05	See Web	
Semi-Rigid Cable Assemblies						
RG405/U Coax, 50 Ohm						
Part No.	PE3C4894	Cable Dia.	Attn. @ 1 GHz	Power @ 1 GHz		
1 piece price shown. See web or call for volume pricing.						
6"	12"	24"	36"	60"	Custom Len.	
\$98.23	\$101.90	\$107.71	\$114.94	\$129.39	See Web	
BMA JACK 2 HOLE FLANGE TO SMP FEMALE RIGHT ANGLE						
SEE MOUNTING HOLE SECTION ON PAGE 409						
Formable Cable Assemblies						

Cable Assemblies

See Our Website For Current Pricing & Real-Time Stock Availability!

Continued on Next Page

For Custom Lengths, Metric Lengths or Special Configurations, Please call (949) 261-1920



Technical Support  
+1 (949) 261-1920



Same-Day Shipping,  
Even Custom Cable Assemblies



For our complete selection of cable assemblies, please visit our website

Cable Assemblies

See Our Website For Current Pricing & Real-Time Stock Availability!

PE-SR405FLJ Coax, 50 Ohm						
Part No.	PE3C4870			Cable Dia.	Attn. @ 1 GHz	Power @ 1 GHz
1 piece price shown. See web or call for volume pricing.						
6"	12"	24"	36"	0.105" dia.	19.5 dB/100ft	121.5 W
\$110.07	\$114.16	\$122.32	\$130.48	60"	-	Custom Len.
See Web						

Semi-Rigid Cable Assemblies						
RG405/U Coax, 50 Ohm						
Part No.	PE3C4897			Cable Dia.	Attn. @ 1 GHz	Power @ 1 GHz
1 piece price shown. See web or call for volume pricing.						
6"	12"	24"	36"	0.105" dia.	22 dB/100ft	130 W
\$109.63	\$113.24	\$120.45	\$127.68	60"	-	Custom Len.
See Web						

**BMA JACK 2 HOLE FLANGE TO TNC MALE**



SEE MOUNTING HOLE SECTION ON PAGE 409

**Formable Cable Assemblies**

PE-SR402FLJ Coax, 50 Ohm						
Part No.	PE3C4916			Cable Dia.	Attn. @ 1 GHz	Power @ 1 GHz
1 piece price shown. See web or call for volume pricing.						
6"	12"	24"	36"	0.161" dia.	11.89 dB/100ft	303.4 W
\$80.55	\$84.59	\$92.64	\$100.70	60"	-	Custom Len.
See Web						

PE-SR405FLJ Coax, 50 Ohm						
Part No.	PE3C4864			Cable Dia.	Attn. @ 1 GHz	Power @ 1 GHz
1 piece price shown. See web or call for volume pricing.						
6"	12"	24"	36"	0.105" dia.	19.5 dB/100ft	121.5 W
\$93.40	\$97.55	\$105.82	\$112.50	60"	-	Custom Len.
See Web						

**Semi-Rigid Cable Assemblies**

RG405/U Coax, 50 Ohm						
Part No.	PE3C4891			Cable Dia.	Attn. @ 1 GHz	Power @ 1 GHz
1 piece price shown. See web or call for volume pricing.						
6"	12"	24"	36"	0.105" dia.	22 dB/100ft	130 W
\$92.94	\$96.61	\$103.93	\$109.72	60"	-	Custom Len.
See Web						

**BMA JACK RIGHT ANGLE 2 HOLE FLANGE TO BMA JACK RIGHT ANGLE 2 HOLE FLANGE**



SEE MOUNTING HOLE SECTION ON PAGE 409

**Formable Cable Assemblies**

PE-SR402FLJ Coax, 50 Ohm						
Part No.	PE3C4902			Cable Dia.	Attn. @ 1 GHz	Power @ 1 GHz
1 piece price shown. See web or call for volume pricing.						
6"	12"	24"	36"	0.161" dia.	11.89 dB/100ft	303.4 W
\$169.83	\$173.81	\$146.55	\$189.70	60"	-	Custom Len.
See Web						

PE-SR405FLJ Coax, 50 Ohm						
Part No.	PE3C4849			Cable Dia.	Attn. @ 1 GHz	Power @ 1 GHz
1 piece price shown. See web or call for volume pricing.						
6"	12"	24"	36"	0.105" dia.	19.5 dB/100ft	121.5 W
\$157.88	\$161.96	\$170.12	\$178.26	60"	-	Custom Len.
See Web						

**Flexible Cable Assemblies**

RG400/U Coax, 50 Ohm						
Part No.	PE3C4952			Cable Dia.	Attn. @ 1 GHz	Power @ 1 GHz
1 piece price shown. See web or call for volume pricing.						
6"	12"	24"	36"	0.195" dia.	14.7 dB/100ft	600 W
\$139.65	\$143.32	\$150.67	\$158.00	60"	-	Custom Len.
See Web						

**Semi-Rigid Cable Assemblies**

RG405/U Coax, 50 Ohm						
Part No.	PE3C4876			Cable Dia.	Attn. @ 1 GHz	Power @ 1 GHz
1 piece price shown. See web or call for volume pricing.						
6"	12"	24"	36"	0.105" dia.	22 dB/100ft	130 W
\$157.42	\$161.04	\$168.24	\$175.49	60"	-	Custom Len.
See Web						

**BNC MALE TO BNC MALE**



**Standard Flexible Cable Assemblies**

M17/60-RG142-27478 Coax, 50 Ohm						
Part No.	PE3M0001			Cable Dia.	Attn. @ 1 GHz	Power @ 1 GHz
1 piece price shown. See web or call for volume pricing.						
12"	18"	24"	30"	0.195" dia.	-	Custom Len.
\$152.60	\$141.69	\$144.65	\$147.60	36"	\$150.55	\$156.47
See Web						

M17/84-RG223-0XDS2 Coax, 50 Ohm						
Part No.	PE3M0029			Cable Dia.	Attn. @ 1 GHz	Power @ 1 GHz
1 piece price shown. See web or call for volume pricing.						
12"	18"	24"	30"	0.212" dia.	-	Custom Len.
\$143.40	\$148.68	\$153.97	\$159.25	36"	\$164.56	\$175.12
See Web						

M17/128-RG400-27478 Coax, 50 Ohm						
Part No.	PE3M0057			Cable Dia.	Attn. @ 1 GHz	Power @ 1 GHz
1 piece price shown. See web or call for volume pricing.						
12"	18"	24"	30"	0.195" dia.	-	Custom Len.
\$140.34	\$144.11	\$147.87	\$151.63	36"	\$155.39	\$162.92
See Web						

M17/113-RG316-27478 Coax, 50 Ohm						
Part No.	PE3M0085			Cable Dia.	Attn. @ 1 GHz	Power @ 1 GHz
1 piece price shown. See web or call for volume pricing.						
6"	8"	12"	16"	0.098" dia.	-	Custom Len.
\$199.55	\$199.91	\$200.65	\$201.35	18"	\$201.72	\$202.81
See Web						

M17/119-RG174-0XDS2 Coax, 50 Ohm						
Part No.	PE3M0100			Cable Dia.	Attn. @ 1 GHz	Power @ 1 GHz
1 piece price shown. See web or call for volume pricing.						
6"	8"	12"	16"	0.11" dia.	-	Custom Len.
\$198.89	\$199.02	\$199.31	\$199.59	18"	\$199.72	\$200.16
See Web						

M17/28-RG058-0XDS2 Coax, 50 Ohm						
Part No.	PE3M0115			Cable Dia.	Attn. @ 1 GHz	Power @ 1 GHz
1 piece price shown. See web or call for volume pricing.						
12"	18"	24"	30"	0.195" dia.	-	Custom Len.
\$140.24	\$140.88	\$141.53	\$142.18	36"	\$142.83	\$144.13
See Web						

**BNC MALE TO N MALE**



**Standard Flexible Cable Assemblies**

M17/60-RG142-27478 Coax, 50 Ohm						
Part No.	PE3M0002			Cable Dia.	Attn. @ 1 GHz	Power @ 1 GHz
1 piece price shown. See web or call for volume pricing.						
12"	18"	24"	30"	0.195" dia.	-	Custom Len.
\$166.93	\$154.71	\$157.67	\$160.62	36"	\$163.95	\$169.50
See Web						

M17/84-RG223-0XDS2 Coax, 50 Ohm						
Part No.	PE3M0030			Cable Dia.	Attn. @ 1 GHz	Power @ 1 GHz
1 piece price shown. See web or call for volume pricing.						
12"	18"	24"	30"	0.212" dia.	-	Custom Len.
\$156.42	\$161.70	\$167.00	\$172.28	36"	\$177.57	\$188.15
See Web						

M17/128-RG400-27478 Coax, 50 Ohm						
Part No.	PE3M0058			Cable Dia.	Attn. @ 1 GHz	Power @ 1 GHz
1 piece price shown. See web or call for volume pricing.						
12"	18"	24"	30"	0.195" dia.	-	Custom Len.
\$153.36	\$157.12	\$160.89	\$164.65	36"	\$168.41	\$175.94
See Web						

**BNC MALE TO N FEMALE**



**Standard Flexible Cable Assemblies**

M17/60-RG142-27478 Coax, 50 Ohm						
Part No.	PE3M0003			Cable Dia.	Attn. @ 1 GHz	Power @ 1 GHz
1 piece price shown. See web or call for volume pricing.						
12"	18"	24"	30"	0.195" dia.	-	Custom Len.
\$162.14	\$165.10	\$168.05	\$171.00	36"	\$173.96	\$179.88
See Web						

M17/84-RG223-0XDS2 Coax, 50 Ohm						
Part No.	PE3M0031			Cable Dia.	Attn. @ 1 GHz	Power @ 1 GHz
1 piece price shown. See web or call for volume pricing.						
-	-	-	-	0.212" dia.	-	Custom Len.
-	-	-	-	-	100CM	\$190.93
See Web						

M17/128-RG400-27478 Coax, 50 Ohm						
Part No.	PE3M0059			Cable Dia.	Attn. @ 1 GHz	Power @ 1 GHz
1 piece price shown. See web or call for volume pricing.						
12"	18"	24"	30"	0.195" dia.	-	Custom Len.
\$163.75	\$167.52	\$171.28	\$175.04	36"	\$178.80	\$186.33
See Web						

**BNC MALE TO N FEMALE BULKHEAD**



SEE MOUNTING HOLE SECTION ON PAGE 409

**Standard Flexible Cable Assemblies**

M17/60-RG142-27478 Coax, 50 Ohm						
Part No.	PE3M0004			Cable Dia.	Attn. @ 1 GHz	Power @ 1 GHz
1 piece price shown. See web or call for volume pricing.						
12"	18"	24"	30"	0.195" dia.	-	Custom Len.
\$166.32	\$169.25	\$172.22	\$175.17	36"	\$178.14	\$184.05
See Web						

M17/84-RG223-0XDS2 Coax, 50 Ohm						
Part No.	PE3M0032			Cable Dia.	Attn. @ 1 GHz	Power @ 1 GHz
1 piece price shown. See web or call for volume pricing.						
12"	18"	24"	30"	0.212" dia.	-	Custom Len.
\$170.97	\$176.25	\$181.56	\$186.84	36"	\$192.12	\$202.71
See Web						

M17/128-RG400-27478 Coax, 50 Ohm						
Part No.	PE3M0060			Cable Dia.	Attn. @ 1 GHz	Power @ 1 GHz
1 piece price shown. See web or call for volume pricing.						
12"	18"	24"	30"	0.195" dia.	-	Custom Len.
\$167.91	\$171.68	\$175.44	\$179.20	36"	\$182.96	\$190.49
See Web						

**BNC MALE TO SMA MALE**



**Standard Flexible Cable Assemblies**

M17/128-RG400-27478 Coax, 50 Ohm						
----------------------------------	--	--	--	--	--	--

\*Coax Performance at 1 GHz Notes: Cable assembly max frequency may be lower than connector or coax max frequency

# For our complete selection of cable assemblies, please visit our website

Part No. <b>PE3M0061</b>	Cable Dia.	Attn. @ 1 GHz	Power @ 1 GHz
1 piece price shown. See web or call for volume pricing.	0.195" dia.		
12" 18" 24" 30"	36"	48"	Custom Len.
\$189.49 \$193.25 \$197.02 \$200.78	\$204.54	\$212.07	See Web
<b>M17/113-RG316-27478 Coax, 50 Ohm</b>			
Part No. <b>PE3M0086</b>	Cable Dia.	Attn. @ 1 GHz	Power @ 1 GHz
1 piece price shown. See web or call for volume pricing.	0.098" dia.		
6" 8" 12" 16"	18"	24"	Custom Len.
\$193.65 \$194.02 \$194.74 \$195.46	\$195.84	\$196.91	See Web
<b>M17/119-RG174-0XDS2 Coax, 50 Ohm</b>			
Part No. <b>PE3M0101</b>	Cable Dia.	Attn. @ 1 GHz	Power @ 1 GHz
1 piece price shown. See web or call for volume pricing.	0.11" dia.		
6" 8" 12" 16"	18"	24"	Custom Len.
\$192.99 \$193.13 \$193.42 \$193.69	\$193.83	\$194.26	See Web
<b>M17/28-RG058-0XDS2 Coax, 50 Ohm</b>			
Part No. <b>PE3M0116</b>	Cable Dia.	Attn. @ 1 GHz	Power @ 1 GHz
1 piece price shown. See web or call for volume pricing.	0.195" dia.		
12" 18" 24" 30"	36"	48"	Custom Len.
\$245.29 \$245.92 \$246.58 \$247.22	\$247.87	\$249.17	See Web
<b>M17/60-RG142-27478 Coax, 50 Ohm</b>			
Part No. <b>PE3M0005</b>	Cable Dia.	Attn. @ 1 GHz	Power @ 1 GHz
1 piece price shown. See web or call for volume pricing.	0.195" dia.		
12" 18" 24" 30"	36"	48"	Custom Len.
\$187.87 \$190.83 \$193.79 \$196.74	\$199.70	\$205.62	See Web
<b>M17/84-RG223-0XDS2 Coax, 50 Ohm</b>			
Part No. <b>PE3M0033</b>	Cable Dia.	Attn. @ 1 GHz	Power @ 1 GHz
1 piece price shown. See web or call for volume pricing.	0.212" dia.		
12" 18" 24" 30"	36"	48"	Custom Len.
\$192.55 \$197.83 \$203.12 \$208.40	\$213.70	\$224.27	See Web

## BNC MALE TO SMA MALE RIGHT ANGLE



### Standard Flexible Cable Assemblies

<b>M17/60-RG142-27478 Coax, 50 Ohm</b>			
Part No. <b>PE3M0006</b>	Cable Dia.	Attn. @ 1 GHz	Power @ 1 GHz
1 piece price shown. See web or call for volume pricing.	0.195" dia.		
12" 18" 24" 30"	36"	48"	Custom Len.
\$227.00 \$229.95 \$232.91 \$235.87	\$238.83	\$244.74	See Web
<b>M17/84-RG223-0XDS2 Coax, 50 Ohm</b>			
Part No. <b>PE3M0034</b>	Cable Dia.	Attn. @ 1 GHz	Power @ 1 GHz
1 piece price shown. See web or call for volume pricing.	0.212" dia.		
12" 18" 24" 30"	36"	48"	Custom Len.
\$231.66 \$236.95 \$242.25 \$247.52	\$252.81	\$263.40	See Web
<b>M17/128-RG400-27478 Coax, 50 Ohm</b>			
Part No. <b>PE3M0062</b>	Cable Dia.	Attn. @ 1 GHz	Power @ 1 GHz
1 piece price shown. See web or call for volume pricing.	0.195" dia.		
12" 18" 24" 30"	36"	48"	Custom Len.
\$251.48 \$232.36 \$236.15 \$239.90	\$243.67	\$251.20	See Web
<b>M17/113-RG316-27478 Coax, 50 Ohm</b>			
Part No. <b>PE3M0087</b>	Cable Dia.	Attn. @ 1 GHz	Power @ 1 GHz
1 piece price shown. See web or call for volume pricing.	0.098" dia.		
6" 8" 12" 16"	18"	24"	Custom Len.
\$210.85 \$211.21 \$211.94 \$212.65	\$213.02	\$214.11	See Web
<b>M17/119-RG174-0XDS2 Coax, 50 Ohm</b>			
Part No. <b>PE3M0102</b>	Cable Dia.	Attn. @ 1 GHz	Power @ 1 GHz
1 piece price shown. See web or call for volume pricing.	0.11" dia.		
6" 8" 12" 16"	18"	24"	Custom Len.
\$210.18 \$210.32 \$231.67 \$210.89	\$211.03	\$211.48	See Web
<b>M17/28-RG058-0XDS2 Coax, 50 Ohm</b>			
Part No. <b>PE3M0117</b>	Cable Dia.	Attn. @ 1 GHz	Power @ 1 GHz
1 piece price shown. See web or call for volume pricing.	0.195" dia.		
12" 18" 24" 30"	36"	48"	Custom Len.
\$179.51 \$180.16 \$180.81 \$181.45	\$182.10	\$183.40	See Web

## BNC MALE TO SMA FEMALE BULKHEAD

SEE MOUNTING HOLE SECTION ON PAGE 409



### Standard Flexible Cable Assemblies

<b>M17/113-RG316-27478 Coax, 50 Ohm</b>			
Part No. <b>PE3M0088</b>	Cable Dia.	Attn. @ 1 GHz	Power @ 1 GHz
1 piece price shown. See web or call for volume pricing.	0.098" dia.		
6" 8" 12" 16"	18"	24"	Custom Len.
\$200.83 \$201.19 \$201.92 \$202.64	\$203.02	\$204.09	See Web
<b>M17/119-RG174-0XDS2 Coax, 50 Ohm</b>			
Part No. <b>PE3M0103</b>	Cable Dia.	Attn. @ 1 GHz	Power @ 1 GHz
1 piece price shown. See web or call for volume pricing.	0.11" dia.		
-	-	-	Custom Len.
-	-	-	See Web

## BNC MALE TO TNC MALE



### Standard Flexible Cable Assemblies

<b>M17/113-RG316-27478 Coax, 50 Ohm</b>			
Part No. <b>PE3M0103</b>	Cable Dia.	Attn. @ 1 GHz	Power @ 1 GHz
1 piece price shown. See web or call for volume pricing.	0.11" dia.		
-	-	-	Custom Len.
-	-	-	See Web

<b>M17/60-RG142-27478 Coax, 50 Ohm</b>			
Part No. <b>PE3M0007</b>	Cable Dia.	Attn. @ 1 GHz	Power @ 1 GHz
1 piece price shown. See web or call for volume pricing.	0.195" dia.		
12" 18" 24" 30"	36"	48"	Custom Len.
\$170.04 \$157.53 \$160.67 \$163.45	\$166.41	\$172.33	See Web
<b>M17/84-RG223-0XDS2 Coax, 50 Ohm</b>			
Part No. <b>PE3M0035</b>	Cable Dia.	Attn. @ 1 GHz	Power @ 1 GHz
1 piece price shown. See web or call for volume pricing.	0.212" dia.		
12" 18" 24" 30"	36"	48"	Custom Len.
\$159.24 \$164.54 \$169.82 \$175.10	\$180.41	\$190.98	See Web
<b>M17/128-RG400-27478 Coax, 50 Ohm</b>			
Part No. <b>PE3M0063</b>	Cable Dia.	Attn. @ 1 GHz	Power @ 1 GHz
1 piece price shown. See web or call for volume pricing.	0.195" dia.		
12" 18" 24" 30"	36"	48"	Custom Len.
\$156.20 \$159.96 \$163.72 \$167.49	\$171.25	\$178.77	See Web
<b>M17/113-RG316-27478 Coax, 50 Ohm</b>			
Part No. <b>PE3M0089</b>	Cable Dia.	Attn. @ 1 GHz	Power @ 1 GHz
1 piece price shown. See web or call for volume pricing.	0.098" dia.		
6" 8" 12" 16"	18"	24"	Custom Len.
\$201.88 \$202.23 \$202.96 \$203.68	\$204.04	\$205.13	See Web
<b>M17/119-RG174-0XDS2 Coax, 50 Ohm</b>			
Part No. <b>PE3M0104</b>	Cable Dia.	Attn. @ 1 GHz	Power @ 1 GHz
1 piece price shown. See web or call for volume pricing.	0.11" dia.		
6" 8" 12" 16"	18"	24"	Custom Len.
\$201.22 \$201.39 \$201.63 \$201.91	\$202.06	\$202.48	See Web
<b>M17/28-RG058-0XDS2 Coax, 50 Ohm</b>			
Part No. <b>PE3M0118</b>	Cable Dia.	Attn. @ 1 GHz	Power @ 1 GHz
1 piece price shown. See web or call for volume pricing.	0.195" dia.		
12" 18" 24" 30"	36"	48"	Custom Len.
\$211.03 \$211.67 \$212.32 \$212.96	\$213.62	\$214.91	See Web

## BNC MALE TO BNC MALE



### Flexible Cable Assemblies

<b>PE-P195 Coax, 50 Ohm</b>			
Part No. <b>PE34035</b>	Cable Dia.	Attn. @ 1 GHz	Power @ 1 GHz
1 piece price shown. See web or call for volume pricing.	0.195" dia.	12.5 dB/100ft	650 W
12" 24" 36" 48"	60"	-	Custom Len.
\$27.85 \$37.74 \$48.37 \$59.06	\$69.79	-	See Web
<b>LMR-195 Coax, 50 Ohm</b>			
Part No. <b>PE3C0054</b>	Cable Dia.	Attn. @ 1 GHz	Power @ 1 GHz
1 piece price shown. See web or call for volume pricing.	0.195" dia.	11.8 dB/100ft	
12" 24" 36" 48"	60"	-	Custom Len.
\$27.38 \$27.44 \$28.25 \$29.10	\$29.90	-	See Web
<b>Low Loss Flexible Cable Assemblies</b>			
<b>PE-C195 Coax, 50 Ohm</b>			
Part No. <b>PE36066</b>	Cable Dia.	Attn. @ 1 GHz	Power @ 1 GHz
1 piece price shown. See web or call for volume pricing.	0.195" dia.	11.3 dB/100ft	150 W
12" 24" 36" 48"	60"	-	Custom Len.
\$31.33 \$32.20 \$33.08 \$33.99	\$34.87	-	See Web
<b>PE-C200 Coax, 50 Ohm</b>			
Part No. <b>PE35256</b>	Cable Dia.	Attn. @ 1 GHz	Power @ 1 GHz
1 piece price shown. See web or call for volume pricing.	0.195" dia.	10.8 dB/100ft	170 W
12" 24" 36" 48"	60"	-	Custom Len.
\$51.15 \$53.85 \$55.56 \$62.67	\$67.29	-	See Web
<b>PE-C240 Coax, 50 Ohm</b>			
Part No. <b>PE36219</b>	Cable Dia.	Attn. @ 1 GHz	Power @ 1 GHz
1 piece price shown. See web or call for volume pricing.	0.24" dia.	9.2 dB/100ft	250 W
12" 24" 36" 48"	60"	-	Custom Len.
\$58.71 \$65.83 \$67.07 \$63.58	\$69.68	-	See Web
<b>PE-C300 Coax, 50 Ohm</b>			
Part No. <b>PE35729</b>	Cable Dia.	Attn. @ 1 GHz	Power @ 1 GHz
1 piece price shown. See web or call for volume pricing.	0.3" dia.	6.3 dB/100ft	350 W
12" 24" 36" 48"	60"	-	Custom Len.
\$57.05 \$60.16 \$63.28 \$66.39	\$75.16	-	See Web
<b>PE-C400 Coax, 50 Ohm</b>			
Part No. <b>PE35874</b>	Cable Dia.	Attn. @ 1 GHz	Power @ 1 GHz
1 piece price shown. See web or call for volume pricing.	0.4" dia.	4.1 dB/100ft	550 W
12" 24" 36" 48"	60"	-	Custom Len.
\$92.01 \$93.46 \$97.36 \$102.65	\$107.92	-	See Web
<b>LMR-240 Coax, 50 Ohm</b>			
Part No. <b>PE3W01041</b>	Cable Dia.	Attn. @ 1 GHz	Power @ 1 GHz
1 piece price shown. See web or call for volume pricing.	0.24" dia.		
12" 24" 36" 48"	60"	50CM	Custom Len.
\$57.61 \$58.63 \$59.67 \$60.71	\$61.75	\$58.27	See Web
<b>LMR-400-DB Coax, 50 Ohm</b>			
Part No. <b>PE3C6663</b>	Cable Dia.	Attn. @ 1 GHz	Power @ 1 GHz
1 piece price shown. See web or call for volume pricing.	0.405" dia.		
12" 24" 36" 48"	60"	50CM	Custom Len.
\$57.99 \$59.40 \$60.11 \$61.51	\$62.91	\$58.20	See Web
<b>PE3W01357</b>			
Part No. <b>PE3W01357</b>	Cable Dia.	Attn. @ 1 GHz	Power @ 1 GHz
1 piece price shown. See web or call for volume pricing.	0.405" dia.	4.15 dB/100ft	
12" 24" 36" 48"	60"	50CM	Custom Len.
\$59.52 \$65.66 \$67.12 \$68.58	\$70.04	\$65.13	See Web

Cable Assemblies

See Our Website For Current Pricing & Real-Time Stock Availability!

For Custom Lengths, Metric Lengths or Special Configurations, Please call (949) 261-1920



Technical Support  
+1 (949) 261-1920



Same-Day Shipping,  
Even Custom Cable Assemblies

# For our complete selection of cable assemblies, please visit our website

Cable Assemblies  
See Our Website For Current Pricing & Real-Time Stock Availability!

PE-SF200LL Coax, 50 Ohm							
Part No. <a href="#">PE3TC1100</a>			Cable Dia.	Attn. @ 1 GHz	Power @ 1 GHz	35	
1 piece price shown. See web or call for volume pricing.							
24"	36"	48"	72"	100CM	200CM		Custom Len.
\$75.22	\$87.58	\$99.96	\$123.00	\$91.07	\$129.85	See Web	
LMR-200-UF Coax, 50 Ohm							
Part No. <a href="#">PE3C2220</a>			Cable Dia.	Attn. @ 1 GHz	Power @ 1 GHz	36	
1 piece price shown. See web or call for volume pricing.							
12"	24"	36"	48"	60"	50CM		Custom Len.
\$50.50	\$52.91	\$54.81	\$57.20	\$59.59	\$52.04	See Web	
Standard Formable Cable Assemblies							
PE-SR047FL Coax, 50 Ohm							
Part No. <a href="#">PE34173</a>			Cable Dia.	Attn. @ 1 GHz	Power @ 1 GHz	37	
1 piece price shown. See web or call for volume pricing.							
6"	12"	18"	24"	36"	48"		Custom Len.
\$95.84	\$99.81	\$103.68	\$107.65	\$113.91	\$121.64	See Web	
PE-SR401FL Coax, 50 Ohm							
Part No. <a href="#">PE34166</a>			Cable Dia.	Attn. @ 1 GHz	Power @ 1 GHz	38	
1 piece price shown. See web or call for volume pricing.							
6"	12"	18"	24"	36"	48"		Custom Len.
\$139.87	\$147.99	\$156.07	\$164.20	\$180.41	\$196.60	See Web	
PE-SR402FL Coax, 50 Ohm							
Part No. <a href="#">PE3462</a>			Cable Dia.	Attn. @ 1 GHz	Power @ 1 GHz	39	
1 piece price shown. See web or call for volume pricing.							
6"	12"	18"	24"	36"	48"		Custom Len.
\$95.34	\$99.65	\$104.08	\$107.03	\$107.33	\$125.05	See Web	
PE-SR405FL Coax, 50 Ohm							
Part No. <a href="#">PE3776</a>			Cable Dia.	Attn. @ 1 GHz	Power @ 1 GHz	40	
1 piece price shown. See web or call for volume pricing.							
6"	12"	18"	24"	36"	48"		Custom Len.
\$94.12	\$101.64	\$99.98	\$105.87	\$124.83	\$127.58	See Web	
Standard Flexible Cable Assemblies							
RG8A/U Coax, 50 Ohm							
Part No. <a href="#">PE3807</a>			Cable Dia.	Attn. @ 1 GHz	Power @ 1 GHz	41	
1 piece price shown. See web or call for volume pricing.							
12"	24"	36"	48"	60"	72"		Custom Len.
\$84.67	\$87.79	\$96.49	\$94.01	\$97.14	\$106.96	See Web	
RG8X Coax, 50 Ohm							
Part No. <a href="#">PE3264</a>			Cable Dia.	Attn. @ 1 GHz	Power @ 1 GHz	42	
1 piece price shown. See web or call for volume pricing.							
12"	24"	36"	48"	60"	-		Custom Len.
\$71.75	\$81.37	\$85.25	\$81.81	\$93.32	-	See Web	
RG58C/U Coax, 50 Ohm							
Part No. <a href="#">PE3067</a>			Cable Dia.	Attn. @ 1 GHz	Power @ 1 GHz	43	
1 piece price shown. See web or call for volume pricing.							
12"	18"	24"	30"	36"	48"		Custom Len.
\$34.63	\$35.03	\$35.44	\$37.37	\$36.25	\$37.06	See Web	
RG58-P Coax, 50 Ohm							
Part No. <a href="#">PE3999</a>			Cable Dia.	Attn. @ 1 GHz	Power @ 1 GHz	44	
1 piece price shown. See web or call for volume pricing.							
12"	24"	36"	48"	60"	-		Custom Len.
\$52.54	\$57.56	\$70.68	\$68.54	\$74.04	-	See Web	
RG141A/U Coax, 50 Ohm							
Part No. <a href="#">PE35148</a>			Cable Dia.	Attn. @ 1 GHz	Power @ 1 GHz	45	
1 piece price shown. See web or call for volume pricing.							
12"	24"	36"	48"	60"	-		Custom Len.
\$51.77	\$58.89	\$66.47	\$74.49	\$82.25	-	See Web	
RG142B/U Coax, 50 Ohm							
Part No. <a href="#">PE3495</a>			Cable Dia.	Attn. @ 1 GHz	Power @ 1 GHz	46	
1 piece price shown. See web or call for volume pricing.							
12"	24"	36"	48"	60"	72"		Custom Len.
\$34.99	\$41.74	\$48.50	\$55.13	\$61.93	\$68.75	See Web	
RG174A/U Coax, 50 Ohm							
Part No. <a href="#">PE3C2295</a>			Cable Dia.	Attn. @ 1 GHz	Power @ 1 GHz	47	
1 piece price shown. See web or call for volume pricing.							
12"	24"	36"	48"	60"	72"		Custom Len.
\$33.62	\$34.26	\$34.90	\$35.57	\$36.24	\$36.88	See Web	
RG178B/U Coax, 50 Ohm							
Part No. <a href="#">PE33130</a>			Cable Dia.	Attn. @ 1 GHz	Power @ 1 GHz	48	
1 piece price shown. See web or call for volume pricing.							
12"	24"	36"	48"	60"	-		Custom Len.
\$71.67	\$72.84	\$74.01	\$75.24	\$76.43	-	See Web	
RG188A/U Coax, 50 Ohm							
Part No. <a href="#">PE3C2034</a>			Cable Dia.	Attn. @ 1 GHz	Power @ 1 GHz	49	
1 piece price shown. See web or call for volume pricing.							
12"	24"	36"	48"	60"	72"		Custom Len.
\$39.89	\$42.66	\$45.43	\$48.36	\$51.16	\$53.99	See Web	
RG213/U Coax, 50 Ohm							
Part No. <a href="#">PE3749</a>			Cable Dia.	Attn. @ 1 GHz	Power @ 1 GHz	50	
1 piece price shown. See web or call for volume pricing.							
12"	24"	36"	48"	60"	72"		Custom Len.
\$84.99	\$86.83	\$92.32	\$90.49	\$92.30	\$94.14	See Web	

RG214/U Coax, 50 Ohm							
Part No. <a href="#">PE3906</a>			Cable Dia.	Attn. @ 1 GHz	Power @ 1 GHz	51	
1 piece price shown. See web or call for volume pricing.							
12"	24"	36"	48"	60"	72"		Custom Len.
\$84.19	\$99.48	\$106.54	\$115.47	\$114.79	\$122.74	See Web	
RG223/U Coax, 50 Ohm							
Part No. <a href="#">PE3087</a>			Cable Dia.	Attn. @ 1 GHz	Power @ 1 GHz	52	
1 piece price shown. See web or call for volume pricing.							
6"	8"	10"	12"	24"	36"		Custom Len.
Call	Call	Call	\$33.29	\$36.51	\$39.72	See Web	
RG303/U Coax, 50 Ohm							
Part No. <a href="#">PE3W00393</a>			Cable Dia.	Attn. @ 1 GHz	Power @ 1 GHz	53	
1 piece price shown. See web or call for volume pricing.							
12"	24"	36"	48"	60"	50CM		Custom Len.
\$38.71	\$46.35	\$53.98	\$61.04	\$68.61	\$43.59	See Web	
RG316/U Coax, 50 Ohm							
Part No. <a href="#">PE3C2416</a>			Cable Dia.	Attn. @ 1 GHz	Power @ 1 GHz	54	
1 piece price shown. See web or call for volume pricing.							
12"	24"	36"	48"	60"	72"		Custom Len.
\$38.24	\$41.70	\$45.17	\$48.84	\$52.37	\$55.40	See Web	
RG400/U Coax, 50 Ohm							
Part No. <a href="#">PE3582</a>			Cable Dia.	Attn. @ 1 GHz	Power @ 1 GHz	55	
1 piece price shown. See web or call for volume pricing.							
12"	24"	36"	48"	60"	72"		Custom Len.
\$46.59	\$54.29	\$62.43	\$71.03	\$79.32	\$87.60	See Web	
LMR-240 Coax, 50 Ohm							
Part No. <a href="#">PE3CA1097</a>			Cable Dia.	Attn. @ 1 GHz	Power @ 1 GHz	56	
1 piece price shown. See web or call for volume pricing.							
12"	24"	36"	48"	60"	-		Custom Len.
Call	Call	Call	Call	Call	-	See Web	
LMR-400-DB Coax, 50 Ohm							
Part No. <a href="#">PE3C6665</a>			Cable Dia.	Attn. @ 1 GHz	Power @ 1 GHz	57	
1 piece price shown. See web or call for volume pricing.							
12"	50CM	24"	36"	100CM	48"		Custom Len.
Call	Call	Call	Call	Call	Call	See Web	
Standard Semi-Rigid Cable Assemblies							
PE-047SR Coax, 50 Ohm							
Part No. <a href="#">PE34177</a>			Cable Dia.	Attn. @ 1 GHz	Power @ 1 GHz	58	
1 piece price shown. See web or call for volume pricing.							
6"	12"	18"	24"	36"	48"		Custom Len.
\$107.50	\$107.50	\$113.04	\$118.59	\$129.70	\$140.78	See Web	
PE-SR047AL Coax, 50 Ohm							
Part No. <a href="#">PE34168</a>			Cable Dia.	Attn. @ 1 GHz	Power @ 1 GHz	59	
1 piece price shown. See web or call for volume pricing.							
6"	12"	18"	24"	36"	48"		Custom Len.
\$96.77	\$101.59	\$106.46	\$109.74	\$119.31	\$128.80	See Web	
PE-SR402AL Coax, 50 Ohm							
Part No. <a href="#">PE34164</a>			Cable Dia.	Attn. @ 1 GHz	Power @ 1 GHz	60	
1 piece price shown. See web or call for volume pricing.							
6"	12"	18"	24"	36"	48"		Custom Len.
\$82.38	\$92.64	\$92.41	\$97.43	\$107.45	\$115.86	See Web	
PE-SR405AL Coax, 50 Ohm							
Part No. <a href="#">PE34162</a>			Cable Dia.	Attn. @ 1 GHz	Power @ 1 GHz	61	
1 piece price shown. See web or call for volume pricing.							
6"	12"	18"	24"	36"	48"		Custom Len.
\$82.00	\$86.53	\$91.16	\$95.76	\$104.95	\$112.60	See Web	
RG401/U Coax, 50 Ohm							
Part No. <a href="#">PE34170</a>			Cable Dia.	Attn. @ 1 GHz	Power @ 1 GHz	62	
1 piece price shown. See web or call for volume pricing.							
6"	12"	18"	24"	36"	48"		Custom Len.
\$143.31	\$154.90	\$166.42	\$177.92	\$201.02	\$245.54	See Web	
RG402/U Coax, 50 Ohm							
Part No. <a href="#">PE3445</a>			Cable Dia.	Attn. @ 1 GHz	Power @ 1 GHz	63	
1 piece price shown. See web or call for volume pricing.							
6"	12"	18"	24"	36"	48"		Custom Len.
\$90.26	\$95.68	\$94.28	\$98.28	\$111.31	\$112.77	See Web	
RG405/U Coax, 50 Ohm							
Part No. <a href="#">PE3678</a>			Cable Dia.	Attn. @ 1 GHz	Power @ 1 GHz	64	
1 piece price shown. See web or call for volume pricing.							
6"	12"	18"	24"	36"	48"		Custom Len.
\$80.98	\$84.68	\$93.84	\$92.01	\$99.29	\$106.61	See Web	
PE-SR401AL-STRAIGHT Coax, 50 Ohm							
Part No. <a href="#">PE34175</a>			Cable Dia.	Attn. @ 1 GHz	Power @ 1 GHz	65	
1 piece price shown. See web or call for volume pricing.							
6"	12"	18"	24"	36"	48"		Custom Len.
\$141.29	\$150.85	\$160.36	\$169.92	\$188.99	\$208.05	See Web	
Standard Flexible Cable Assemblies							
RG55B/U Coax, 53 Ohm							
Part No. <a href="#">PE3583</a>			Cable Dia.	Attn. @ 1 GHz	Power @ 1 GHz	66	
1 piece price shown. See web or call for volume pricing.							
12"	24"	36"	48"	60"	72"		Custom Len.
\$35.68	\$38.55	\$41.44	\$44.47	\$47.40	\$50.33	See Web	

\*Coax Performance at 1 GHz Notes: Cable assembly max frequency may be lower than connector or coax max frequency



# For our complete selection of cable assemblies, please visit our website

RG59B/U Coax, 75 Ohm						
Part No. <b>PE3075</b>		Cable Dia.	Attn. @ 1 GHz	Power @ 1 GHz		
1 piece price shown. See web or call for volume pricing.						
12"	18"	24"	30"	36"	48"	Custom Len.
\$29.61	\$31.07	\$30.67	\$31.21	\$31.72	\$32.80	See Web
RG179B/U Coax, 75 Ohm						
Part No. <b>PE3C3349</b>		Cable Dia.	Attn. @ 1 GHz	Power @ 1 GHz		
1 piece price shown. See web or call for volume pricing.						
12"	24"	36"	48"	60"	72"	Custom Len.
\$41.46	\$41.02	\$43.64	\$46.25	\$48.88	\$55.41	See Web
RG302/U Coax, 75 Ohm						
Part No. <b>PE33123</b>		Cable Dia.	Attn. @ 1 GHz	Power @ 1 GHz		
1 piece price shown. See web or call for volume pricing.						
12"	24"	36"	48"	60"	-	Custom Len.
\$34.13	\$40.64	\$47.14	\$53.65	\$59.62	-	See Web
RG62A/U Coax, 93 Ohm						
Part No. <b>PE3081</b>		Cable Dia.	Attn. @ 1 GHz	Power @ 1 GHz		
1 piece price shown. See web or call for volume pricing.						
12"	24"	36"	48"	60"	72"	Custom Len.
\$35.71	\$40.28	\$41.99	\$43.80	\$45.55	\$47.29	See Web
RG180B/U Coax, 95 Ohm						
Part No. <b>PE33574</b>		Cable Dia.	Attn. @ 1 GHz	Power @ 1 GHz		
1 piece price shown. See web or call for volume pricing.						
12"	24"	36"	48"	60"	-	Custom Len.
\$48.28	\$53.09	\$53.57	\$62.39	\$61.86	-	See Web



**BNC MALE TO BNC MALE RIGHT ANGLE**

Flexible Cable Assemblies						
RG55B/U Coax, 53 Ohm						
Part No. <b>PE3C6845</b>		Cable Dia.	Attn. @ 1 GHz	Power @ 1 GHz		
1 piece price shown. See web or call for volume pricing.						
12"	24"	36"	48"	60"	50CM	Custom Len.
\$34.55	\$37.60	\$39.14	\$42.20	\$45.26	\$34.96	See Web
Low Loss Flexible Cable Assemblies						
PE-C240 Coax, 50 Ohm						
Part No. <b>PE38997</b>		Cable Dia.	Attn. @ 1 GHz	Power @ 1 GHz		
1 piece price shown. See web or call for volume pricing.						
12"	24"	36"	48"	60"	-	Custom Len.
\$60.46	\$58.10	\$60.02	\$63.06	\$66.15	-	See Web
LMR-195 Coax, 50 Ohm						
Part No. <b>PE3W01992</b>		Cable Dia.	Attn. @ 1 GHz	Power @ 1 GHz		
1 piece price shown. See web or call for volume pricing.						
12"	24"	36"	48"	60"	50CM	Custom Len.
\$47.77	\$48.56	\$49.38	\$50.19	\$50.98	\$48.28	See Web
Standard Formable Cable Assemblies						
PE-SR402FL Coax, 50 Ohm						
Part No. <b>PE35580</b>		Cable Dia.	Attn. @ 1 GHz	Power @ 1 GHz		
1 piece price shown. See web or call for volume pricing.						
12"	24"	36"	48"	60"	-	Custom Len.
\$94.89	\$103.18	\$109.92	\$118.10	\$126.26	-	See Web
Standard Flexible Cable Assemblies						
RG8A/U Coax, 50 Ohm						
Part No. <b>PE3327</b>		Cable Dia.	Attn. @ 1 GHz	Power @ 1 GHz		
1 piece price shown. See web or call for volume pricing.						
12"	24"	36"	48"	60"	72"	Custom Len.
\$90.44	\$93.40	\$96.44	\$99.46	\$102.43	\$105.48	See Web
RG58C/U Coax, 50 Ohm						
Part No. <b>PE3020</b>		Cable Dia.	Attn. @ 1 GHz	Power @ 1 GHz		
1 piece price shown. See web or call for volume pricing.						
12"	24"	36"	48"	60"	72"	Custom Len.
\$56.46	\$57.34	\$58.25	\$59.18	\$60.10	\$61.00	See Web
RG142B/U Coax, 50 Ohm						
Part No. <b>PE3082</b>		Cable Dia.	Attn. @ 1 GHz	Power @ 1 GHz		
1 piece price shown. See web or call for volume pricing.						
12"	24"	36"	48"	60"	72"	Custom Len.
\$54.22	\$60.91	\$67.59	\$71.05	\$77.34	\$83.65	See Web
RG174A/U Coax, 50 Ohm						
Part No. <b>PE3C3404</b>		Cable Dia.	Attn. @ 1 GHz	Power @ 1 GHz		
1 piece price shown. See web or call for volume pricing.						
12"	24"	36"	48"	60"	72"	Custom Len.
\$59.75	\$60.39	\$58.41	\$61.69	\$62.35	\$59.85	See Web
RG188A/U Coax, 50 Ohm						
Part No. <b>PE3C3377</b>		Cable Dia.	Attn. @ 1 GHz	Power @ 1 GHz		
1 piece price shown. See web or call for volume pricing.						
12"	24"	36"	48"	60"	72"	Custom Len.
\$71.81	\$74.57	\$77.30	\$73.81	\$76.25	\$85.79	See Web
RG213/U Coax, 50 Ohm						
Part No. <b>PE3355</b>		Cable Dia.	Attn. @ 1 GHz	Power @ 1 GHz		
1 piece price shown. See web or call for volume pricing.						
12"	24"	36"	48"	60"	72"	Custom Len.
\$94.59	\$102.24	\$98.24	\$100.09	\$101.90	\$103.73	See Web

RG214/U Coax, 50 Ohm						
Part No. <b>PE3325</b>		Cable Dia.	Attn. @ 1 GHz	Power @ 1 GHz		
1 piece price shown. See web or call for volume pricing.						
12"	24"	36"	48"	60"	72"	Custom Len.
\$98.31	\$100.87	\$107.45	\$115.47	\$123.45	\$131.48	See Web
RG223/U Coax, 50 Ohm						
Part No. <b>PE3689</b>		Cable Dia.	Attn. @ 1 GHz	Power @ 1 GHz		
1 piece price shown. See web or call for volume pricing.						
12"	24"	36"	48"	60"	72"	Custom Len.
\$50.48	\$53.94	\$56.88	\$60.51	\$60.85	\$64.04	See Web
RG316/U Coax, 50 Ohm						
Part No. <b>PE3C3391</b>		Cable Dia.	Attn. @ 1 GHz	Power @ 1 GHz		
1 piece price shown. See web or call for volume pricing.						
12"	24"	36"	48"	60"	72"	Custom Len.
\$68.47	\$67.76	\$70.95	\$74.13	\$82.48	\$85.96	See Web
RG316-DS Coax, 50 Ohm						
Part No. <b>PE3358</b>		Cable Dia.	Attn. @ 1 GHz	Power @ 1 GHz		
1 piece price shown. See web or call for volume pricing.						
12"	24"	36"	48"	60"	72"	Custom Len.
\$60.02	\$63.02	\$65.95	\$68.93	\$71.93	\$74.93	See Web
RG400/U Coax, 50 Ohm						
Part No. <b>PE3116</b>		Cable Dia.	Attn. @ 1 GHz	Power @ 1 GHz		
1 piece price shown. See web or call for volume pricing.						
12"	24"	36"	48"	60"	72"	Custom Len.
\$72.27	\$80.39	\$86.51	\$97.14	\$98.81	\$112.13	See Web

Standard Semi-Rigid Cable Assemblies						
RG402/U Coax, 50 Ohm						
Part No. <b>PE39108</b>		Cable Dia.	Attn. @ 1 GHz	Power @ 1 GHz		
1 piece price shown. See web or call for volume pricing.						
12"	24"	36"	48"	60"	-	Custom Len.
\$89.10	\$96.49	\$103.90	\$109.81	\$117.08	-	See Web
Standard Flexible Cable Assemblies						
RG59B/U Coax, 75 Ohm						
Part No. <b>PE3508</b>		Cable Dia.	Attn. @ 1 GHz	Power @ 1 GHz		
1 piece price shown. See web or call for volume pricing.						
12"	24"	36"	48"	60"	72"	Custom Len.
\$53.87	\$49.99	\$55.67	\$51.99	\$52.98	\$59.19	See Web
RG179B/U Coax, 75 Ohm						
Part No. <b>PE3C3375</b>		Cable Dia.	Attn. @ 1 GHz	Power @ 1 GHz		
1 piece price shown. See web or call for volume pricing.						
12"	24"	36"	48"	60"	72"	Custom Len.
\$66.78	\$69.37	\$79.08	\$74.59	\$77.17	\$79.77	See Web



**BNC MALE TO 7/16 DIN FEMALE**

Standard Flexible Cable Assemblies						
LMR-400-UF Coax, 50 Ohm						
Part No. <b>PE3W10097</b>		Cable Dia.	Attn. @ 1 GHz	Power @ 1 GHz		
1 piece price shown. See web or call for volume pricing.						
12"	24"	36"	48"	60"	50CM	Custom Len.
\$130.20	\$132.14	\$134.08	\$136.02	\$137.95	\$129.50	See Web



**BNC MALE TO BNC FEMALE**

Flexible Cable Assemblies						
RG179B/U Coax, 75 Ohm						
Part No. <b>PE3C3741</b>		Cable Dia.	Attn. @ 1 GHz	Power @ 1 GHz		
1 piece price shown. See web or call for volume pricing.						
12"	24"	36"	48"	60"	50CM	Custom Len.
\$42.37	\$45.36	\$46.85	\$49.84	\$52.83	\$42.80	See Web
Low Loss Flexible Cable Assemblies						
PE-C195 Coax, 50 Ohm						
Part No. <b>PE38344</b>		Cable Dia.	Attn. @ 1 GHz	Power @ 1 GHz		
1 piece price shown. See web or call for volume pricing.						
12"	24"	36"	48"	60"	-	Custom Len.
\$31.39	\$32.19	\$32.99	\$33.77	\$34.57	-	See Web
PE-SF200LL Coax, 50 Ohm						
Part No. <b>PE3TC1101</b>		Cable Dia.	Attn. @ 1 GHz	Power @ 1 GHz		
1 piece price shown. See web or call for volume pricing.						
12"	24"	36"	48"	60"	200CM	Custom Len.
\$75.22	\$87.58	\$99.96	\$123.00	\$91.07	\$129.85	See Web
Standard Flexible Cable Assemblies						
RG8A/U Coax, 50 Ohm						
Part No. <b>PE3360</b>		Cable Dia.	Attn. @ 1 GHz	Power @ 1 GHz		
1 piece price shown. See web or call for volume pricing.						
12"	24"	36"	48"	60"	72"	Custom Len.
\$98.80	\$101.86	\$104.88	\$107.85	\$109.35	\$120.25	See Web

Cable Assemblies

See Our Website For Current Pricing & Real-Time Stock Availability!

For Custom Lengths, Metric Lengths or Special Configurations, Please call (949) 261-1920



Technical Support  
+1 (949) 261-1920



Same-Day Shipping,  
Even Custom Cable Assemblies



For our complete selection of cable assemblies, please visit our website

Cable Assemblies  
See Our Website For Current Pricing & Real-Time Stock Availability!

RG58C/U Coax, 50 Ohm						
Part No. <a href="#">PE3047</a>	Cable Dia.	Attn. @ 1 GHz	Power @ 1 GHz			
1 piece price shown. See web or call for volume pricing.						
12"	24"	36"	48"	60"	72"	Custom Len.
\$42.82	\$43.71	\$44.63	\$45.58	\$46.49	\$47.41	See Web
RG142B/U Coax, 50 Ohm						
Part No. <a href="#">PE3777</a>	Cable Dia.	Attn. @ 1 GHz	Power @ 1 GHz			
1 piece price shown. See web or call for volume pricing.						
12"	24"	36"	48"	60"	72"	Custom Len.
\$41.03	\$47.39	\$53.75	\$59.57	\$65.86	\$72.17	See Web
RG174A/U Coax, 50 Ohm						
Part No. <a href="#">PE3C3325</a>	Cable Dia.	Attn. @ 1 GHz	Power @ 1 GHz			
1 piece price shown. See web or call for volume pricing.						
12"	24"	36"	48"	60"	72"	Custom Len.
\$46.18	\$46.81	\$44.69	\$48.15	\$48.79	-	See Web
RG188A/U Coax, 50 Ohm						
Part No. <a href="#">PE3C3453</a>	Cable Dia.	Attn. @ 1 GHz	Power @ 1 GHz			
1 piece price shown. See web or call for volume pricing.						
12"	24"	36"	48"	60"	72"	Custom Len.
\$45.53	\$47.85	\$50.16	\$52.39	\$54.20	\$56.43	See Web
RG213/U Coax, 50 Ohm						
Part No. <a href="#">PE3949</a>	Cable Dia.	Attn. @ 1 GHz	Power @ 1 GHz			
1 piece price shown. See web or call for volume pricing.						
12"	24"	36"	48"	60"	72"	Custom Len.
\$96.39	\$98.13	\$99.80	\$101.54	\$103.24	\$104.97	See Web
RG214/U Coax, 50 Ohm						
Part No. <a href="#">PE3371</a>	Cable Dia.	Attn. @ 1 GHz	Power @ 1 GHz			
1 piece price shown. See web or call for volume pricing.						
12"	24"	36"	48"	60"	72"	Custom Len.
\$101.18	\$107.77	\$115.80	\$123.79	\$131.79	\$139.80	See Web
RG223/U Coax, 50 Ohm						
Part No. <a href="#">PE3606</a>	Cable Dia.	Attn. @ 1 GHz	Power @ 1 GHz			
1 piece price shown. See web or call for volume pricing.						
12"	24"	36"	48"	60"	72"	Custom Len.
\$38.93	\$38.58	\$45.83	\$49.48	\$48.25	\$51.46	See Web
RG316/U Coax, 50 Ohm						
Part No. <a href="#">PE3C3344</a>	Cable Dia.	Attn. @ 1 GHz	Power @ 1 GHz			
1 piece price shown. See web or call for volume pricing.						
12"	24"	36"	48"	60"	72"	Custom Len.
\$48.52	\$52.00	\$54.94	\$58.58	\$58.92	\$65.59	See Web
RG400/U Coax, 50 Ohm						
Part No. <a href="#">PE3627</a>	Cable Dia.	Attn. @ 1 GHz	Power @ 1 GHz			
1 piece price shown. See web or call for volume pricing.						
12"	24"	36"	48"	60"	72"	Custom Len.
\$55.44	\$58.08	\$65.73	\$73.41	\$81.06	\$96.89	See Web
RG55B/U Coax, 53 Ohm						
Part No. <a href="#">PE3375</a>	Cable Dia.	Attn. @ 1 GHz	Power @ 1 GHz			
1 piece price shown. See web or call for volume pricing.						
12"	24"	36"	48"	60"	72"	Custom Len.
\$36.93	\$39.41	\$41.90	\$44.39	\$46.89	\$49.37	See Web
RG59B/U Coax, 75 Ohm						
Part No. <a href="#">PE3792</a>	Cable Dia.	Attn. @ 1 GHz	Power @ 1 GHz			
1 piece price shown. See web or call for volume pricing.						
12"	24"	36"	48"	60"	72"	Custom Len.
\$31.97	\$33.04	\$34.11	\$38.06	\$36.24	\$37.29	See Web
RG62A/U Coax, 93 Ohm						
Part No. <a href="#">PE3368</a>	Cable Dia.	Attn. @ 1 GHz	Power @ 1 GHz			
1 piece price shown. See web or call for volume pricing.						
12"	24"	36"	48"	60"	72"	Custom Len.
\$30.07	\$31.54	\$33.01	\$34.46	\$35.94	\$37.39	See Web
BNC MALE TO BNC FEMALE BULKHEAD						
SEE MOUNTING HOLE SECTION ON PAGE 409						
Low Loss Flexible Cable Assemblies						
PE-C195 Coax, 50 Ohm						
Part No. <a href="#">PE38804</a>	Cable Dia.	Attn. @ 1 GHz	Power @ 1 GHz			
1 piece price shown. See web or call for volume pricing.						
12"	24"	36"	48"	60"	72"	Custom Len.
\$36.39	\$40.17	\$37.96	\$38.74	\$39.55	-	See Web
Standard Flexible Cable Assemblies						
RG8A/U Coax, 50 Ohm						
Part No. <a href="#">PE3440</a>	Cable Dia.	Attn. @ 1 GHz	Power @ 1 GHz			
1 piece price shown. See web or call for volume pricing.						
12"	24"	36"	48"	60"	72"	Custom Len.
\$103.22	\$106.27	\$107.77	\$110.70	\$113.70	\$116.63	See Web
RG58C/U Coax, 50 Ohm						
Part No. <a href="#">PE3649</a>	Cable Dia.	Attn. @ 1 GHz	Power @ 1 GHz			
1 piece price shown. See web or call for volume pricing.						
12"	24"	36"	48"	60"	72"	Custom Len.
\$49.37	\$50.26	\$51.17	\$52.13	\$53.04	\$53.97	See Web

RG142B/U Coax, 50 Ohm						
Part No. <a href="#">PE3436</a>	Cable Dia.	Attn. @ 1 GHz	Power @ 1 GHz			
1 piece price shown. See web or call for volume pricing.						
12"	24"	36"	48"	60"	72"	Custom Len.
\$55.00	\$56.29	\$62.59	\$68.90	\$75.21	\$81.50	See Web
RG174A/U Coax, 50 Ohm						
Part No. <a href="#">PE3C3397</a>	Cable Dia.	Attn. @ 1 GHz	Power @ 1 GHz			
1 piece price shown. See web or call for volume pricing.						
12"	24"	36"	48"	60"	72"	Custom Len.
\$52.36	\$53.00	\$53.65	\$49.94	\$50.43	\$50.90	See Web
RG188A/U Coax, 50 Ohm						
Part No. <a href="#">PE3C3399</a>	Cable Dia.	Attn. @ 1 GHz	Power @ 1 GHz			
1 piece price shown. See web or call for volume pricing.						
12"	24"	36"	48"	60"	72"	Custom Len.
\$46.69	\$49.00	\$51.31	\$53.55	\$55.34	\$57.58	See Web
RG213/U Coax, 50 Ohm						
Part No. <a href="#">PE3450</a>	Cable Dia.	Attn. @ 1 GHz	Power @ 1 GHz			
1 piece price shown. See web or call for volume pricing.						
12"	24"	36"	48"	60"	72"	Custom Len.
\$102.12	\$103.90	\$105.76	\$107.59	\$107.94	\$109.74	See Web
RG214/U Coax, 50 Ohm						
Part No. <a href="#">PE3427</a>	Cable Dia.	Attn. @ 1 GHz	Power @ 1 GHz			
1 piece price shown. See web or call for volume pricing.						
12"	24"	36"	48"	60"	72"	Custom Len.
\$105.59	\$112.15	\$120.16	\$128.15	\$136.17	\$144.15	See Web
RG223/U Coax, 50 Ohm						
Part No. <a href="#">PE3557</a>	Cable Dia.	Attn. @ 1 GHz	Power @ 1 GHz			
1 piece price shown. See web or call for volume pricing.						
12"	24"	36"	48"	60"	72"	Custom Len.
\$48.17	\$51.39	\$54.09	\$62.02	\$65.51	\$63.66	See Web
RG316/U Coax, 50 Ohm						
Part No. <a href="#">PE3C3446</a>	Cable Dia.	Attn. @ 1 GHz	Power @ 1 GHz			
1 piece price shown. See web or call for volume pricing.						
12"	24"	36"	48"	60"	72"	Custom Len.
\$48.01	\$51.47	\$54.45	\$56.75	\$59.93	\$63.09	See Web
RG400/U Coax, 50 Ohm						
Part No. <a href="#">PE3423</a>	Cable Dia.	Attn. @ 1 GHz	Power @ 1 GHz			
1 piece price shown. See web or call for volume pricing.						
12"	24"	36"	48"	60"	72"	Custom Len.
\$63.54	\$71.67	\$79.78	\$88.40	\$96.69	\$97.15	See Web
RG59B/U Coax, 75 Ohm						
Part No. <a href="#">PE3103</a>	Cable Dia.	Attn. @ 1 GHz	Power @ 1 GHz			
1 piece price shown. See web or call for volume pricing.						
12"	24"	36"	48"	60"	72"	Custom Len.
\$46.11	\$47.18	\$48.24	\$49.31	\$50.37	\$56.07	See Web
BNC MALE TO FAKRA PLUG						
Flexible Flexible Cable Assemblies						
RG174A/U Coax, 50 Ohm						
Part No. <a href="#">PE3C7715</a>	Cable Dia.	Attn. @ 1 GHz	Power @ 1 GHz			
1 piece price shown. See web or call for volume pricing.						
12"	24"	36"	48"	60"	50CM	Custom Len.
\$30.00	\$30.62	\$31.24	\$31.87	\$32.49	\$29.77	See Web
BNC MALE TO MCX JACK BULKHEAD						
SEE MOUNTING HOLE SECTION ON PAGE 409						
Low Loss Flexible Cable Assemblies						
LMR-100A-PVC Coax, 50 Ohm						
Part No. <a href="#">PE3C6788</a>	Cable Dia.	Attn. @ 1 GHz	Power @ 1 GHz			
1 piece price shown. See web or call for volume pricing.						
12"	24"	36"	48"	60"	50CM	Custom Len.
\$44.44	\$45.22	\$45.60	\$46.37	\$47.15	\$44.55	See Web
BNC MALE TO MHV MALE						
Standard Flexible Cable Assemblies						
RG58C/U Coax, 50 Ohm						
Part No. <a href="#">PE3W00032</a>	Cable Dia.	Attn. @ 1 GHz	Power @ 1 GHz			
1 piece price shown. See web or call for volume pricing.						
12"	24"	36"	48"	60"	50CM	Custom Len.
\$49.16	\$51.00	\$51.97	\$52.91	\$53.87	\$50.66	See Web
BNC MALE TO N MALE						
Flexible Cable Assemblies						

\*Coax Performance at 1 GHz Notes: Cable assembly max frequency may be lower than connector or coax max frequency

For our complete selection of cable assemblies, please visit our website

LMR-240 Coax, 50 Ohm						
Part No. <a href="#">PE3W05881</a>	Cable Dia.		Attn. @ 1 GHz	Power @ 1 GHz		
1 piece price shown. See web or call for volume pricing.						
12"	24"	36"	48"	60"	50CM	Custom Len.
\$42.19	\$43.15	\$44.13	\$45.12	\$46.09	\$42.81	See Web

**Standard Flexible Cable Assemblies**

RG142B/U Coax, 50 Ohm						
Part No. <a href="#">PE3061</a>	Cable Dia.		Attn. @ 1 GHz	Power @ 1 GHz		
1 piece price shown. See web or call for volume pricing.						
12"	24"	36"	48"	60"	72"	Custom Len.
\$49.44	\$55.67	\$62.35	\$69.42	\$70.56	\$76.86	See Web

Part No. <a href="#">PE3W06862</a>						
Cable Dia.		Attn. @ 1 GHz	Power @ 1 GHz			
1 piece price shown. See web or call for volume pricing.						
12"	24"	36"	48"	60"	50CM	Custom Len.
\$43.76	\$50.30	\$56.33	\$62.81	\$69.31	\$47.94	See Web

**BNC MALE TO N MALE RIGHT ANGLE**



**Flexible Cable Assemblies**

LMR-240 Coax, 50 Ohm						
Part No. <a href="#">PE3C2275</a>	Cable Dia.		Attn. @ 1 GHz	Power @ 1 GHz		
1 piece price shown. See web or call for volume pricing.						
12"	50CM	24"	36"	100CM	48"	Custom Len.
\$82.60	\$83.23	\$83.58	\$84.56	\$84.83	\$85.54	See Web

**BNC MALE TO N FEMALE BULKHEAD**



SEE MOUNTING HOLE SECTION ON PAGE 409

**Flexible Cable Assemblies**

LMR-200 Coax, 50 Ohm						
Part No. <a href="#">PE3W07094</a>	Cable Dia.		Attn. @ 1 GHz	Power @ 1 GHz		
1 piece price shown. See web or call for volume pricing.						
12"	18"	24"	36"	48"	60"	Custom Len.
\$52.87	\$51.27	\$51.65	\$52.42	\$53.19	\$53.95	See Web

**BNC MALE TO SHV PLUG**



**Standard Flexible Cable Assemblies**

RG58C/U Coax, 50 Ohm						
Part No. <a href="#">PE3W00148</a>	Cable Dia.		Attn. @ 1 GHz	Power @ 1 GHz		
1 piece price shown. See web or call for volume pricing.						
12"	24"	36"	48"	60"	50CM	Custom Len.
\$65.72	\$66.58	\$67.44	\$68.29	\$69.16	\$66.27	See Web

**BNC MALE TO SMA MALE**



**Low Loss Flexible Cable Assemblies**

PE-C240 Coax, 50 Ohm						
Part No. <a href="#">PE3W07719</a>	Cable Dia.		Attn. @ 1 GHz	Power @ 1 GHz		
1 piece price shown. See web or call for volume pricing.						
12"	24"	36"	48"	60"	50CM	Custom Len.
\$42.91	\$44.31	\$45.03	\$46.44	\$47.85	\$43.10	See Web

**Standard Flexible Cable Assemblies**

RG188A/U Coax, 50 Ohm						
Part No. <a href="#">PE3W03670</a>	Cable Dia.		Attn. @ 1 GHz	Power @ 1 GHz		
1 piece price shown. See web or call for volume pricing.						
12"	24"	36"	48"	60"	50CM	Custom Len.
\$49.57	\$52.53	\$54.98	\$57.91	\$60.85	\$51.45	See Web

**BNC MALE TO SSMC PLUG**



**Low Loss Flexible Cable Assemblies**

LMR-100A-PVC Coax, 50 Ohm						
Part No. <a href="#">PE3C4430</a>	Cable Dia.		Attn. @ 1 GHz	Power @ 1 GHz		
1 piece price shown. See web or call for volume pricing.						
6"	12"	18"	24"	36"	48"	Custom Len.
\$51.03	\$51.43	\$47.17	\$52.28	\$48.40	\$54.01	See Web

**Standard Formable Cable Assemblies**

PE-SR405FLJ Coax, 50 Ohm						
Part No. <a href="#">PE3C4450</a>	Cable Dia.		Attn. @ 1 GHz	Power @ 1 GHz		
1 piece price shown. See web or call for volume pricing.						
6"	12"	18"	24"	36"	48"	Custom Len.
\$77.44	\$89.74	\$85.74	\$89.87	\$98.13	\$106.41	See Web

Standard Flexible Cable Assemblies						
RG178B/U Coax, 50 Ohm						
Part No. <a href="#">PE3C4397</a>	Cable Dia.		Attn. @ 1 GHz	Power @ 1 GHz		
1 piece price shown. See web or call for volume pricing.						
6"	12"	18"	24"	36"	48"	Custom Len.
\$75.45	\$83.56	\$76.48	\$77.00	\$85.90	\$87.13	See Web

RG316/U Coax, 50 Ohm						
Part No. <a href="#">PE3C4413</a>	Cable Dia.		Attn. @ 1 GHz	Power @ 1 GHz		
1 piece price shown. See web or call for volume pricing.						
6"	12"	18"	24"	36"	48"	Custom Len.
\$57.56	\$62.66	\$60.65	\$62.17	\$69.51	\$68.34	See Web

RG316-DS Coax, 50 Ohm						
Part No. <a href="#">PE3C4475</a>	Cable Dia.		Attn. @ 1 GHz	Power @ 1 GHz		
1 piece price shown. See web or call for volume pricing.						
6"	12"	18"	24"	36"	48"	Custom Len.
\$60.86	\$62.41	\$58.18	\$59.62	\$62.49	\$72.14	See Web

Low Loss Flexible Cable Assemblies						
LMR-100A-PVC Coax, 50 Ohm						
Part No. <a href="#">PE3C4431</a>	Cable Dia.		Attn. @ 1 GHz	Power @ 1 GHz		
1 piece price shown. See web or call for volume pricing.						
6"	12"	18"	24"	36"	48"	Custom Len.
\$46.83	\$47.26	\$43.37	\$43.76	\$44.59	\$45.40	See Web

Standard Formable Cable Assemblies						
PE-SR405FLJ Coax, 50 Ohm						
Part No. <a href="#">PE3C4487</a>	Cable Dia.		Attn. @ 1 GHz	Power @ 1 GHz		
1 piece price shown. See web or call for volume pricing.						
6"	12"	18"	24"	36"	48"	Custom Len.
\$74.05	\$78.18	\$82.32	\$86.46	\$94.73	\$103.00	See Web

Standard Flexible Cable Assemblies						
RG178B/U Coax, 50 Ohm						
Part No. <a href="#">PE3C4466</a>	Cable Dia.		Attn. @ 1 GHz	Power @ 1 GHz		
1 piece price shown. See web or call for volume pricing.						
6"	12"	18"	24"	36"	48"	Custom Len.
\$66.20	\$70.72	\$67.25	\$67.73	\$68.77	\$69.79	See Web

RG316/U Coax, 50 Ohm						
Part No. <a href="#">PE3C4414</a>	Cable Dia.		Attn. @ 1 GHz	Power @ 1 GHz		
1 piece price shown. See web or call for volume pricing.						
6"	12"	18"	24"	36"	48"	Custom Len.
\$54.29	\$60.87	\$56.88	\$58.40	\$61.49	\$64.56	See Web

RG316-DS Coax, 50 Ohm						
Part No. <a href="#">PE3C4476</a>	Cable Dia.		Attn. @ 1 GHz	Power @ 1 GHz		
1 piece price shown. See web or call for volume pricing.						
6"	12"	18"	24"	36"	48"	Custom Len.
\$59.16	\$60.83	\$56.86	\$58.40	\$61.50	\$71.34	See Web

BNC MALE TO SSMC JACK BULKHEAD						
SEE MOUNTING HOLE SECTION ON PAGE 409						

Standard Formable Cable Assemblies						
PE-SR405FLJ Coax, 50 Ohm						
Part No. <a href="#">PE3C4488</a>	Cable Dia.		Attn. @ 1 GHz	Power @ 1 GHz		
1 piece price shown. See web or call for volume pricing.						
6"	12"	18"	24"	36"	48"	Custom Len.
\$69.95	\$74.09	\$78.23	\$82.35	\$90.63	\$98.90	See Web

Standard Flexible Cable Assemblies						
RG178B/U Coax, 50 Ohm						
Part No. <a href="#">PE3C4398</a>	Cable Dia.		Attn. @ 1 GHz	Power @ 1 GHz		
1 piece price shown. See web or call for volume pricing.						
6"	12"	18"	24"	36"	48"	Custom Len.
\$71.08	\$71.60	\$72.12	\$72.62	\$73.64	\$74.68	See Web

BNC MALE TO UHF FEMALE						
------------------------	--	--	--	--	--	--

Standard Flexible Cable Assemblies						
RG55B/U Coax, 53 Ohm						
Part No. <a href="#">PE3C8015</a>	Cable Dia.		Attn. @ 1 GHz	Power @ 1 GHz		
1 piece price shown. See web or call for volume pricing.						
12"	24"	36"	48"	60"	50CM	Custom Len.
\$38.31	\$41.42	\$44.54	\$47.66	\$50.78	\$37.18	See Web

BNC MALE RIGHT ANGLE TO BNC MALE RIGHT ANGLE						
--	--	--	--	--	--	--

Low Loss Flexible Cable Assemblies						
------------------------------------	--	--	--	--	--	--

Cable Assemblies

See Our Website For Current Pricing & Real-Time Stock Availability!

Continued on Next Page

For Custom Lengths, Metric Lengths or Special Configurations, Please call (949) 261-1920



Technical Support  
+1 (949) 261-1920



Same-Day Shipping,  
Even Custom Cable Assemblies

For our complete selection of cable assemblies, please visit our website

Cable Assemblies  
See Our Website For Current Pricing & Real-Time Stock Availability!

PE-C100-LSZH Coax, 50 Ohm						
Part No. <a href="#">PE39185</a>	Cable Dia.		Attn. @ 1 GHz	Power @ 1 GHz		
1 piece price shown. See web or call for volume pricing.	0.109" dia.		25 dB/100ft			
12"	24"	36"	48"	60"	-	Custom Len.
\$61.65	\$62.40	\$63.18	\$63.91	\$64.70	-	See Web
Standard Flexible Cable Assemblies						
PE-B100 Coax, 50 Ohm						
Part No. <a href="#">PE38249</a>	Cable Dia.		Attn. @ 1 GHz	Power @ 1 GHz		
1 piece price shown. See web or call for volume pricing.	0.101" dia.					
12"	24"	36"	48"	60"	-	Custom Len.
\$73.86	\$81.06	\$88.25	\$95.46	\$102.65	-	See Web
RG8A/U Coax, 50 Ohm						
Part No. <a href="#">PE3378</a>	Cable Dia.		Attn. @ 1 GHz	Power @ 1 GHz		
1 piece price shown. See web or call for volume pricing.	0.405" dia.		8 dB/100ft	190 W		
12"	24"	36"	48"	60"	72"	Custom Len.
\$107.59	\$109.09	\$112.02	\$115.00	\$117.93	\$120.94	See Web
RG58C/U Coax, 50 Ohm						
Part No. <a href="#">PE3025</a>	Cable Dia.		Attn. @ 1 GHz	Power @ 1 GHz		
1 piece price shown. See web or call for volume pricing.	0.195" dia.		20 dB/100ft	44 W		
12"	24"	36"	48"	60"	72"	Custom Len.
\$77.27	\$78.15	\$79.06	\$80.00	\$80.91	\$81.81	See Web
RG142B/U Coax, 50 Ohm						
Part No. <a href="#">PE3044</a>	Cable Dia.		Attn. @ 1 GHz	Power @ 1 GHz		
1 piece price shown. See web or call for volume pricing.	0.195" dia.		12.9 dB/100ft			
12"	24"	36"	48"	60"	72"	Custom Len.
\$79.13	\$85.81	\$87.25	\$93.55	\$99.86	\$106.15	See Web
RG174A/U Coax, 50 Ohm						
Part No. <a href="#">PE3373</a>	Cable Dia.		Attn. @ 1 GHz	Power @ 1 GHz		
1 piece price shown. See web or call for volume pricing.	0.1" dia.		32 dB/100ft	16 W		
12"	24"	36"	48"	60"	72"	Custom Len.
\$91.62	\$85.32	\$85.80	\$86.29	\$86.76	\$87.23	See Web
RG188A/U Coax, 50 Ohm						
Part No. <a href="#">PE3351</a>	Cable Dia.		Attn. @ 1 GHz	Power @ 1 GHz		
1 piece price shown. See web or call for volume pricing.	0.11" dia.		26 dB/100ft	160 W		
12"	24"	36"	48"	60"	72"	Custom Len.
\$86.85	\$89.29	\$91.73	\$94.17	\$96.61	\$107.77	See Web
RG188-DS Coax, 50 Ohm						
Part No. <a href="#">PE3381</a>	Cable Dia.		Attn. @ 1 GHz	Power @ 1 GHz		
1 piece price shown. See web or call for volume pricing.	0.122" dia.		30 dB/100ft	160 W		
12"	24"	36"	48"	60"	72"	Custom Len.
\$81.66	\$85.28	\$88.92	\$92.54	\$96.10	\$99.73	See Web
RG213/U Coax, 50 Ohm						
Part No. <a href="#">PE3384</a>	Cable Dia.		Attn. @ 1 GHz	Power @ 1 GHz		
1 piece price shown. See web or call for volume pricing.	0.405" dia.		8 dB/100ft	190 W		
12"	24"	36"	48"	60"	72"	Custom Len.
\$106.41	\$106.75	\$108.57	\$110.38	\$112.15	\$113.97	See Web
RG214/U Coax, 50 Ohm						
Part No. <a href="#">PE3370</a>	Cable Dia.		Attn. @ 1 GHz	Power @ 1 GHz		
1 piece price shown. See web or call for volume pricing.	0.425" dia.		7.32 dB/100ft	190 W		
12"	24"	36"	48"	60"	72"	Custom Len.
\$111.11	\$119.10	\$127.11	\$135.13	\$143.11	\$151.12	See Web
RG223/U Coax, 50 Ohm						
Part No. <a href="#">PE3816</a>	Cable Dia.		Attn. @ 1 GHz	Power @ 1 GHz		
1 piece price shown. See web or call for volume pricing.	0.21" dia.		13.4 dB/100ft	53 W		
12"	24"	36"	48"	60"	72"	Custom Len.
\$71.51	\$74.70	\$77.88	\$81.08	\$84.27	\$94.67	See Web
RG316/U Coax, 50 Ohm						
Part No. <a href="#">PE3842</a>	Cable Dia.		Attn. @ 1 GHz	Power @ 1 GHz		
1 piece price shown. See web or call for volume pricing.	0.098" dia.		38 dB/100ft	160 W		
12"	24"	36"	48"	60"	72"	Custom Len.
\$94.86	\$98.30	\$94.20	\$97.36	\$100.53	\$103.71	See Web
RG316-DS Coax, 50 Ohm						
Part No. <a href="#">PE3389</a>	Cable Dia.		Attn. @ 1 GHz	Power @ 1 GHz		
1 piece price shown. See web or call for volume pricing.	0.114" dia.		30 dB/100ft	160 W		
12"	24"	36"	48"	60"	72"	Custom Len.
\$83.73	\$87.16	\$90.58	\$87.12	\$97.72	\$93.51	See Web
RG400/U Coax, 50 Ohm						
Part No. <a href="#">PE3458</a>	Cable Dia.		Attn. @ 1 GHz	Power @ 1 GHz		
1 piece price shown. See web or call for volume pricing.	0.195" dia.		14.7 dB/100ft	650 W		
12"	24"	36"	48"	60"	72"	Custom Len.
\$83.48	\$91.15	\$98.79	\$106.46	\$112.54	\$120.11	See Web
PE-P195 Coax, 50 Ohm						
Part No. <a href="#">PE37640</a>	Cable Dia.		Attn. @ 1 GHz	Power @ 1 GHz		
1 piece price shown. See web or call for volume pricing.	0.195" dia.		12.5 dB/100ft	650 W		
12"	24"	36"	48"	60"	-	Custom Len.
\$74.06	\$83.78	\$93.51	\$103.25	\$111.41	-	See Web
RG55B/U Coax, 53 Ohm						
Part No. <a href="#">PE38506</a>	Cable Dia.		Attn. @ 1 GHz	Power @ 1 GHz		
1 piece price shown. See web or call for volume pricing.	0.202" dia.		16.5 dB/100ft	53 W		
12"	24"	36"	48"	60"	-	Custom Len.
\$62.27	\$64.49	\$66.81	\$69.06	\$71.28	-	See Web
RG59B/U Coax, 75 Ohm						
Part No. <a href="#">PE3935</a>	Cable Dia.		Attn. @ 1 GHz	Power @ 1 GHz		
1 piece price shown. See web or call for volume pricing.	0.242" dia.		11.5 dB/100ft	77 W		
12"	24"	36"	48"	60"	72"	Custom Len.
\$71.36	\$72.35	\$73.35	\$74.34	\$75.32	\$76.32	See Web

RG179B/U Coax, 75 Ohm						
Part No. <a href="#">PE3366</a>	Cable Dia.		Attn. @ 1 GHz	Power @ 1 GHz		
1 piece price shown. See web or call for volume pricing.	0.1" dia.		25 dB/100ft	200 W		
12"	24"	36"	48"	60"	72"	Custom Len.
\$80.67	\$83.29	\$85.86	\$88.52	\$91.10	\$93.73	See Web
BNC MALE RIGHT ANGLE TO BNC FEMALE BULKHEAD						
SEE MOUNTING HOLE SECTION ON PAGE 409						
Standard Flexible Cable Assemblies						
RG58C/U Coax, 50 Ohm						
Part No. <a href="#">PE33189</a>	Cable Dia.		Attn. @ 1 GHz	Power @ 1 GHz		
1 piece price shown. See web or call for volume pricing.	0.195" dia.		20 dB/100ft	44 W		
12"	24"	36"	48"	60"	-	Custom Len.
\$68.94	\$69.84	\$70.73	\$70.73	\$72.59	-	See Web
RG400/U Coax, 50 Ohm						
Part No. <a href="#">PE3C3314</a>	Cable Dia.		Attn. @ 1 GHz	Power @ 1 GHz		
1 piece price shown. See web or call for volume pricing.	0.195" dia.		14.7 dB/100ft	650 W		
12"	24"	36"	48"	60"	50CM	Custom Len.
\$78.21	\$83.09	\$90.97	\$98.87	\$106.75	\$80.25	See Web
BNC MALE RIGHT ANGLE TO SMA FEMALE						
Standard Flexible Cable Assemblies						
RG316/U Coax, 50 Ohm						
Part No. <a href="#">PE3W04854</a>	Cable Dia.		Attn. @ 1 GHz	Power @ 1 GHz		
1 piece price shown. See web or call for volume pricing.	0.098" dia.		38 dB/100ft	160 W		
12"	24"	36"	48"	60"	50CM	Custom Len.
\$59.96	\$63.55	\$67.15	\$70.77	\$74.37	\$62.26	See Web
BNC MALE RIGHT ANGLE TO TNC MALE RIGHT ANGLE						
Low Loss Flexible Cable Assemblies						
LMR-240-UF Coax, 50 Ohm						
Part No. <a href="#">PE3W07480</a>	Cable Dia.		Attn. @ 1 GHz	Power @ 1 GHz		
1 piece price shown. See web or call for volume pricing.	0.24" dia.		9.19 dB/100ft			
12"	18"	24"	36"	48"	60"	Custom Len.
\$75.11	\$73.01	\$73.73	\$75.16	\$76.59	\$78.01	See Web
BNC FEMALE TO BNC MALE RIGHT ANGLE						
Standard Flexible Cable Assemblies						
RG174A/U Coax, 50 Ohm						
Part No. <a href="#">PE3W06649</a>	Cable Dia.		Attn. @ 1 GHz	Power @ 1 GHz		
1 piece price shown. See web or call for volume pricing.	0.11" dia.		32 dB/100ft	17 W		
12"	24"	36"	48"	60"	50CM	Custom Len.
\$93.17	\$93.78	\$94.40	\$95.01	\$95.63	\$93.55	See Web
BNC FEMALE TO BNC FEMALE						
Standard Flexible Cable Assemblies						
RG8A/U Coax, 50 Ohm						
Part No. <a href="#">PE36345</a>	Cable Dia.		Attn. @ 1 GHz	Power @ 1 GHz		
1 piece price shown. See web or call for volume pricing.	0.405" dia.		8 dB/100ft	190 W		
12"	24"	36"	48"	60"	-	Custom Len.
\$114.63	\$117.41	\$120.28	\$123.08	\$125.94	-	See Web
RG58C/U Coax, 50 Ohm						
Part No. <a href="#">PE3052</a>	Cable Dia.		Attn. @ 1 GHz	Power @ 1 GHz		
1 piece price shown. See web or call for volume pricing.	0.195" dia.		20 dB/100ft	44 W		
12"	24"	36"	48"	60"	72"	Custom Len.
\$43.41	\$44.23	\$49.56	\$50.50	\$46.68	\$52.34	See Web
RG142B/U Coax, 50 Ohm						
Part No. <a href="#">PE3088</a>	Cable Dia.		Attn. @ 1 GHz	Power @ 1 GHz		
1 piece price shown. See web or call for volume pricing.	0.195" dia.		12.9 dB/100ft			
12"	24"	36"	48"	60"	72"	Custom Len.
\$41.60	\$47.71	\$53.91	\$64.12	\$65.61	\$71.71	See Web
RG174A/U Coax, 50 Ohm						
Part No. <a href="#">PE3604</a>	Cable Dia.		Attn. @ 1 GHz	Power @ 1 GHz		
1 piece price shown. See web or call for volume pricing.	0.1" dia.		32 dB/100ft	16 W		
12"	24"	36"	48"	60"	72"	Custom Len.
\$56.27	\$56.91	\$57.55	\$58.23	\$56.01	\$59.51	See Web
RG178B/U Coax, 50 Ohm						
Part No. <a href="#">PE36455</a>	Cable Dia.		Attn. @ 1 GHz	Power @ 1 GHz		
1 piece price shown. See web or call for volume pricing.	0.072" dia.		44.4 dB/100ft	78 W		
12"	24"	36"	48"	60"	-	Custom Len.
\$80.70	\$75.80	\$83.02	\$84.27	\$78.96	-	See Web

\*Coax Performance at 1 GHz Notes: Cable assembly max frequency may be lower than connector or coax max frequency



# For our complete selection of cable assemblies, please visit our website

RG188A/U Coax, 50 Ohm						
Part No. <a href="#">PE3094</a>	Cable Dia.	Attn. @ 1 GHz	Power @ 1 GHz			
1 piece price shown. See web or call for volume pricing.	0.11" dia.	26 dB/100ft	160 W			
12"	24"	36"	48"	60"	72"	Custom Len.
\$57.18	\$65.64	\$62.06	\$64.50	\$66.95	\$69.38	See Web
RG214/U Coax, 50 Ohm						
Part No. <a href="#">PE3953</a>	Cable Dia.	Attn. @ 1 GHz	Power @ 1 GHz			
1 piece price shown. See web or call for volume pricing.	0.425" dia.	7.32 dB/100ft	190 W			
12"	24"	36"	48"	60"	72"	Custom Len.
\$127.76	\$135.77	\$143.77	\$151.78	\$159.77	\$167.79	See Web
RG223/U Coax, 50 Ohm						
Part No. <a href="#">PE3364</a>	Cable Dia.	Attn. @ 1 GHz	Power @ 1 GHz			
1 piece price shown. See web or call for volume pricing.	0.21" dia.	13.4 dB/100ft	53 W			
12"	24"	36"	48"	60"	72"	Custom Len.
\$38.67	\$41.92	\$45.12	\$53.11	\$51.65	\$54.35	See Web
RG316/U Coax, 50 Ohm						
Part No. <a href="#">PE3505</a>	Cable Dia.	Attn. @ 1 GHz	Power @ 1 GHz			
1 piece price shown. See web or call for volume pricing.	0.098" dia.	38 dB/100ft	160 W			
12"	24"	36"	48"	60"	72"	Custom Len.
\$58.18	\$61.35	\$69.71	\$73.34	\$70.90	\$74.06	See Web
RG316-DS Coax, 50 Ohm						
Part No. <a href="#">PE3C6575</a>	Cable Dia.	Attn. @ 1 GHz	Power @ 1 GHz			
1 piece price shown. See web or call for volume pricing.	0.114" dia.	30 dB/100ft	130 W			
12"	24"	36"	48"	60"	50CM	Custom Len.
\$50.88	\$54.48	\$57.56	\$61.13	\$64.70	\$53.19	See Web
RG59B/U Coax, 75 Ohm						
Part No. <a href="#">PE3675</a>	Cable Dia.	Attn. @ 1 GHz	Power @ 1 GHz			
1 piece price shown. See web or call for volume pricing.	0.242" dia.	11.5 dB/100ft	77 W			
12"	24"	36"	48"	60"	72"	Custom Len.
\$26.31	\$27.31	\$27.53	\$28.50	\$29.45	\$30.42	See Web
BNC FEMALE TO SMA MALE						
Flexible Cable Assemblies						
RG316-DS Coax, 50 Ohm						
Part No. <a href="#">PE3C6914</a>	Cable Dia.	Attn. @ 1 GHz	Power @ 1 GHz			
1 piece price shown. See web or call for volume pricing.	0.114" dia.	30 dB/100ft	130 W			
12"	24"	36"	48"	60"	50CM	Custom Len.
\$42.00	\$45.60	\$47.41	\$51.02	\$54.12	\$42.50	See Web
Standard Flexible Cable Assemblies						
RG174A/U Coax, 50 Ohm						
Part No. <a href="#">PE3W06305</a>	Cable Dia.	Attn. @ 1 GHz	Power @ 1 GHz			
1 piece price shown. See web or call for volume pricing.	0.11" dia.	32 dB/100ft	17 W			
12"	18"	24"	36"	48"	60"	Custom Len.
\$51.08	\$49.47	\$49.76	\$50.36	\$50.96	\$51.56	See Web
BNC FEMALE BULKHEAD TO SMA MALE						
SEE MOUNTING HOLE SECTION ON PAGE 409						
Standard Formable Cable Assemblies						
PE-SR405FLJ Coax, 50 Ohm						
Part No. <a href="#">PE3W03377</a>	Cable Dia.	Attn. @ 1 GHz	Power @ 1 GHz			
1 piece price shown. See web or call for volume pricing.	0.098" dia.	-	121.5 W			
12"	24"	36"	48"	60"	50CM	Custom Len.
\$83.65	\$93.49	\$103.34	\$111.61	\$121.32	\$89.96	See Web
Standard Flexible Cable Assemblies						
RG58C/U Coax, 50 Ohm						
Part No. <a href="#">PE3W01634</a>	Cable Dia.	Attn. @ 1 GHz	Power @ 1 GHz			
1 piece price shown. See web or call for volume pricing.	0.195" dia.	20 dB/100ft	80 W			
12"	24"	36"	48"	60"	50CM	Custom Len.
\$37.32	\$38.27	\$39.23	\$40.19	\$41.14	\$37.93	See Web
C MALE TO C MALE						
Standard Flexible Cable Assemblies						
RG8A/U Coax, 50 Ohm						
Part No. <a href="#">PE33316</a>	Cable Dia.	Attn. @ 1 GHz	Power @ 1 GHz			
1 piece price shown. See web or call for volume pricing.	0.405" dia.	8 dB/100ft	190 W			
12"	24"	36"	48"	60"	72"	Custom Len.
\$106.59	\$116.32	\$112.75	\$115.81	\$118.89	\$121.96	See Web
RG58C/U Coax, 50 Ohm						
Part No. <a href="#">PE3457</a>	Cable Dia.	Attn. @ 1 GHz	Power @ 1 GHz			
1 piece price shown. See web or call for volume pricing.	0.195" dia.	20 dB/100ft	44 W			
12"	24"	36"	48"	60"	72"	Custom Len.
\$100.47	\$101.28	\$108.76	\$102.87	\$103.68	\$104.51	See Web
RG141A/U Coax, 50 Ohm						
Part No. <a href="#">PE34440</a>	Cable Dia.	Attn. @ 1 GHz	Power @ 1 GHz			
1 piece price shown. See web or call for volume pricing.	0.19" dia.	13 dB/100ft	650 W			
12"	24"	36"	48"	60"	72"	Custom Len.
\$89.85	\$96.77	\$103.62	\$108.94	\$115.75	\$122.49	See Web

RG142B/U Coax, 50 Ohm						
Part No. <a href="#">PE3518</a>	Cable Dia.	Attn. @ 1 GHz	Power @ 1 GHz			
1 piece price shown. See web or call for volume pricing.	0.195" dia.	13 dB/100ft	650 W			
12"	24"	36"	48"	60"	72"	Custom Len.
\$82.01	\$88.29	\$94.60	\$100.90	\$107.21	\$111.94	See Web
RG213/U Coax, 50 Ohm						
Part No. <a href="#">PE3522</a>	Cable Dia.	Attn. @ 1 GHz	Power @ 1 GHz			
1 piece price shown. See web or call for volume pricing.	0.405" dia.	8 dB/100ft	190 W			
12"	24"	36"	48"	60"	72"	Custom Len.
\$106.83	\$107.15	\$108.94	\$110.75	\$112.55	\$114.36	See Web
RG214/U Coax, 50 Ohm						
Part No. <a href="#">PE3605</a>	Cable Dia.	Attn. @ 1 GHz	Power @ 1 GHz			
1 piece price shown. See web or call for volume pricing.	0.425" dia.	7.32 dB/100ft	190 W			
12"	24"	36"	48"	60"	72"	Custom Len.
\$98.67	\$106.71	\$120.01	\$121.13	\$129.06	\$146.13	See Web
RG217/U Coax, 50 Ohm						
Part No. <a href="#">PE34437</a>	Cable Dia.	Attn. @ 1 GHz	Power @ 1 GHz			
1 piece price shown. See web or call for volume pricing.	0.545" dia.	5.8 dB/100ft	260 W			
12"	24"	36"	48"	60"	72"	Custom Len.
\$165.57	\$170.35	\$175.12	\$179.89	\$196.38	\$189.45	See Web
RG218/U Coax, 50 Ohm						
Part No. <a href="#">PE34442</a>	Cable Dia.	Attn. @ 1 GHz	Power @ 1 GHz			
1 piece price shown. See web or call for volume pricing.	0.87" dia.	3.8 dB/100ft	560 W			
12"	24"	36"	48"	60"	72"	Custom Len.
\$248.98	\$261.09	\$273.13	\$285.24	\$297.31	\$309.43	See Web
RG223/U Coax, 50 Ohm						
Part No. <a href="#">PE3343</a>	Cable Dia.	Attn. @ 1 GHz	Power @ 1 GHz			
1 piece price shown. See web or call for volume pricing.	0.21" dia.	13.4 dB/100ft	53 W			
12"	24"	36"	48"	60"	72"	Custom Len.
\$78.87	\$82.05	\$85.24	\$88.42	\$91.61	\$94.81	See Web
RG225/U Coax, 50 Ohm						
Part No. <a href="#">PE33098</a>	Cable Dia.	Attn. @ 1 GHz	Power @ 1 GHz			
1 piece price shown. See web or call for volume pricing.	0.43" dia.	7.5 dB/100ft	1,700 W			
12"	24"	36"	48"	60"	72"	Custom Len.
\$119.10	\$154.44	\$189.77	\$225.09	\$260.44	\$295.78	See Web
RG393/U Coax, 50 Ohm						
Part No. <a href="#">PE3120</a>	Cable Dia.	Attn. @ 1 GHz	Power @ 1 GHz			
1 piece price shown. See web or call for volume pricing.	0.39" dia.	7.5 dB/100ft	1,700 W			
12"	24"	36"	48"	60"	72"	Custom Len.
\$106.73	\$130.91	\$148.70	\$157.04	\$185.67	\$203.80	See Web
RG400/U Coax, 50 Ohm						
Part No. <a href="#">PE3545</a>	Cable Dia.	Attn. @ 1 GHz	Power @ 1 GHz			
1 piece price shown. See web or call for volume pricing.	0.195" dia.	14.7 dB/100ft	650 W			
12"	24"	36"	48"	60"	72"	Custom Len.
\$84.09	\$91.82	\$99.53	\$107.26	\$113.37	\$120.99	See Web
RG59B/U Coax, 75 Ohm						
Part No. <a href="#">PE33662</a>	Cable Dia.	Attn. @ 1 GHz	Power @ 1 GHz			
1 piece price shown. See web or call for volume pricing.	0.242" dia.	11.5 dB/100ft	77 W			
12"	24"	36"	48"	60"	72"	Custom Len.
\$107.00	\$107.98	\$107.45	\$108.42	\$109.41	\$110.38	See Web
RG62A/U Coax, 93 Ohm						
Part No. <a href="#">PE34435</a>	Cable Dia.	Attn. @ 1 GHz	Power @ 1 GHz			
1 piece price shown. See web or call for volume pricing.	0.242" dia.	13 dB/100ft	77 W			
12"	24"	36"	48"	60"	72"	Custom Len.
\$107.45	\$107.40	\$108.83	\$110.26	\$111.70	\$113.12	See Web
FAKRA PLUG TO FAKRA PLUG						
Low Loss Flexible Cable Assemblies						
PE-C100-LSZH Coax, 50 Ohm						
Part No. <a href="#">PE38747A</a>	Cable Dia.	Attn. @ 1 GHz	Power @ 1 GHz			
1 piece price shown. See web or call for volume pricing.	0.109" dia.	25 dB/100ft	-			
12"	24"	36"	48"	60"	-	Custom Len.
\$24.53	\$25.36	\$26.17	\$26.93	\$27.74	-	See Web
Part No. <a href="#">PE38747C</a>	Cable Dia.	Attn. @ 1 GHz	Power @ 1 GHz			
1 piece price shown. See web or call for volume pricing.	0.109" dia.	25 dB/100ft	-			
12"	24"	36"	48"	60"	-	Custom Len.
\$24.94	\$27.89	\$28.55	\$30.67	\$32.86	-	See Web
Part No. <a href="#">PE38747D</a>	Cable Dia.	Attn. @ 1 GHz	Power @ 1 GHz			
1 piece price shown. See web or call for volume pricing.	0.109" dia.	25 dB/100ft	-			
12"	24"	36"	48"	60"	-	Custom Len.
\$25.90	\$27.40	\$29.66	\$31.87	\$34.13	-	See Web
Part No. <a href="#">PE38747H</a>	Cable Dia.	Attn. @ 1 GHz	Power @ 1 GHz			
1 piece price shown. See web or call for volume pricing.	0.109" dia.	25 dB/100ft	-			
12"	24"	36"	48"	60"	-	Custom Len.
\$24.53	\$25.36	\$26.17	\$26.93	\$27.74	-	See Web
Part No. <a href="#">PE38747I</a>	Cable Dia.	Attn. @ 1 GHz	Power @ 1 GHz			
1 piece price shown. See web or call for volume pricing.	0.109" dia.	25 dB/100ft	-			
12"	24"	36"	48"	60"	-	Custom Len.
\$25.90	\$27.40	\$29.66	\$31.87	\$34.13	-	See Web
Part No. <a href="#">PE38747K</a>	Cable Dia.	Attn. @ 1 GHz	Power @ 1 GHz			
1 piece price shown. See web or call for volume pricing.	0.109" dia.	25 dB/100ft	-			
12"	24"	36"	48"	60"	-	Custom Len.
\$25.90	\$27.40	\$29.66	\$31.87	\$34.13	-	See Web

Cable Assemblies

See Our Website For Current Pricing & Real-Time Stock Availability!

For Custom Lengths, Metric Lengths or Special Configurations, Please call (949) 261-1920



Technical Support  
+1 (949) 261-1920



Same-Day Shipping,  
Even Custom Cable Assemblies



For our complete selection of cable assemblies, please visit our website

Cable Assemblies

See Our Website For Current Pricing & Real-Time Stock Availability!

Part No.	Cable Dia.	Attn. @ 1 GHz	Power @ 1 GHz
<b>Part No. PE38747Z</b>			
1 piece price shown. See web or call for volume pricing.			
12"	24"	36"	48"
\$29.94	\$29.06	\$30.42	\$34.44
		\$35.95	-
		-	Custom Len.
		-	See Web
<b>Standard Flexible Cable Assemblies</b>			
<b>RG174A/U Coax, 50 Ohm</b>			
<b>Part No. PE38751A</b>			
1 piece price shown. See web or call for volume pricing.			
12"	24"	36"	48"
\$29.54	\$30.14	\$30.72	\$31.28
			\$31.87
			Custom Len.
			See Web
<b>Part No. PE38751C</b>			
1 piece price shown. See web or call for volume pricing.			
12"	24"	36"	48"
\$32.50	\$30.14	\$30.72	\$31.28
			\$31.87
			Custom Len.
			See Web
<b>Part No. PE38751D</b>			
1 piece price shown. See web or call for volume pricing.			
12"	24"	36"	48"
\$29.54	\$30.14	\$30.72	\$31.28
			\$31.87
			Custom Len.
			See Web
<b>Part No. PE38751H</b>			
1 piece price shown. See web or call for volume pricing.			
12"	24"	36"	48"
\$29.54	\$30.14	\$30.72	\$31.28
			\$31.87
			Custom Len.
			See Web
<b>Part No. PE38751I</b>			
1 piece price shown. See web or call for volume pricing.			
12"	24"	36"	48"
\$29.54	\$30.14	\$30.72	\$31.28
			\$31.87
			Custom Len.
			See Web
<b>Part No. PE38751K</b>			
1 piece price shown. See web or call for volume pricing.			
12"	24"	36"	48"
\$29.54	\$30.14	\$30.72	\$31.28
			\$31.87
			Custom Len.
			See Web
<b>Part No. PE38751Z</b>			
1 piece price shown. See web or call for volume pricing.			
12"	24"	36"	48"
\$35.75	\$32.99	\$33.47	\$33.96
			\$38.37
			Custom Len.
			See Web
<b>RG316/U Coax, 50 Ohm</b>			
<b>Part No. PE38755A</b>			
1 piece price shown. See web or call for volume pricing.			
12"	24"	36"	48"
\$32.20	\$35.33	\$38.53	\$41.72
			\$44.91
			Custom Len.
			See Web
<b>Part No. PE38755C</b>			
1 piece price shown. See web or call for volume pricing.			
12"	24"	36"	48"
\$34.09	\$34.01	\$37.09	\$40.16
			\$43.23
			Custom Len.
			See Web
<b>Part No. PE38755D</b>			
1 piece price shown. See web or call for volume pricing.			
12"	24"	36"	48"
\$32.20	\$35.33	\$38.53	\$41.72
			\$44.91
			Custom Len.
			See Web
<b>Part No. PE38755H</b>			
1 piece price shown. See web or call for volume pricing.			
12"	24"	36"	48"
\$32.20	\$35.33	\$38.53	\$41.72
			\$44.91
			Custom Len.
			See Web
<b>Part No. PE38755I</b>			
1 piece price shown. See web or call for volume pricing.			
12"	24"	36"	48"
\$32.20	\$35.33	\$38.53	\$41.72
			\$44.91
			Custom Len.
			See Web
<b>Part No. PE38755K</b>			
1 piece price shown. See web or call for volume pricing.			
12"	24"	36"	48"
\$32.20	\$35.33	\$38.53	\$41.72
			\$44.91
			Custom Len.
			See Web
<b>Part No. PE38755Z</b>			
1 piece price shown. See web or call for volume pricing.			
12"	24"	36"	48"
\$32.20	\$35.33	\$38.53	\$46.02
			\$44.91
			Custom Len.
			See Web
<b>FAKRA PLUG TO FAKRA JACK</b>			
<b>Low Loss Flexible Cable Assemblies</b>			
<b>PE-C100-LSZH Coax, 50 Ohm</b>			
<b>Part No. PE38748A</b>			
1 piece price shown. See web or call for volume pricing.			
12"	24"	36"	48"
\$27.72	\$29.06	\$30.42	\$31.87
			\$36.50
			Custom Len.
			See Web
<b>Part No. PE38748C</b>			
1 piece price shown. See web or call for volume pricing.			
12"	24"	36"	48"
\$30.49	\$29.06	\$33.45	\$31.87
			\$36.50
			Custom Len.
			See Web
<b>Part No. PE38748D</b>			
1 piece price shown. See web or call for volume pricing.			
12"	24"	36"	48"
\$27.72	\$29.06	\$30.42	\$31.87
			\$36.50
			Custom Len.
			See Web
<b>Part No. PE38748H</b>			
1 piece price shown. See web or call for volume pricing.			
12"	24"	36"	48"
\$27.72	\$29.06	\$30.42	\$31.87
			\$34.13
			Custom Len.
			See Web

Part No.	Cable Dia.	Attn. @ 1 GHz	Power @ 1 GHz
<b>Part No. PE38748J</b>			
1 piece price shown. See web or call for volume pricing.			
12"	24"	36"	48"
\$25.90	\$27.40	\$29.66	\$31.87
			\$34.13
			Custom Len.
			See Web
<b>Standard Flexible Cable Assemblies</b>			
<b>RG174A/U Coax, 50 Ohm</b>			
<b>Part No. PE38748K</b>			
1 piece price shown. See web or call for volume pricing.			
12"	24"	36"	48"
\$27.72	\$29.06	\$32.89	\$31.87
			\$39.95
			Custom Len.
			See Web
<b>Part No. PE38748Z</b>			
1 piece price shown. See web or call for volume pricing.			
12"	24"	36"	48"
\$29.40	\$30.88	\$32.35	\$33.93
			\$35.42
			Custom Len.
			See Web
<b>LMR-100A-PVC Coax, 50 Ohm</b>			
<b>Part No. PE3C2779</b>			
1 piece price shown. See web or call for volume pricing.			
12"	24"	36"	48"
\$26.88	\$27.74	\$27.82	\$28.64
			\$29.46
			50CM
			\$27.43
			Custom Len.
			See Web
<b>Standard Flexible Cable Assemblies</b>			
<b>RG174A/U Coax, 50 Ohm</b>			
<b>Part No. PE38752A</b>			
1 piece price shown. See web or call for volume pricing.			
12"	24"	36"	48"
\$32.50	\$32.99	\$33.47	\$33.96
			\$34.43
			Custom Len.
			See Web
<b>Part No. PE38752C</b>			
1 piece price shown. See web or call for volume pricing.			
12"	24"	36"	48"
\$32.50	\$32.99	\$33.47	\$33.96
			\$38.37
			Custom Len.
			See Web
<b>Part No. PE38752D</b>			
1 piece price shown. See web or call for volume pricing.			
12"	24"	36"	48"
\$32.50	\$32.99	\$33.47	\$37.06
			\$34.43
			Custom Len.
			See Web
<b>Part No. PE38752H</b>			
1 piece price shown. See web or call for volume pricing.			
12"	24"	36"	48"
\$32.50	\$32.99	\$33.47	\$33.96
			\$37.72
			Custom Len.
			See Web
<b>Part No. PE38752I</b>			
1 piece price shown. See web or call for volume pricing.			
12"	24"	36"	48"
\$32.50	\$32.99	\$33.47	\$33.96
			\$38.37
			Custom Len.
			See Web
<b>Part No. PE38752K</b>			
1 piece price shown. See web or call for volume pricing.			
12"	24"	36"	48"
\$31.91	\$35.10	\$32.87	\$36.42
			\$33.84
			Custom Len.
			See Web
<b>Part No. PE38752Z</b>			
1 piece price shown. See web or call for volume pricing.			
12"	24"	36"	48"
\$34.46	\$35.10	\$35.75	\$36.42
			\$37.08
			Custom Len.
			See Web
<b>FAKRA PLUG TO FAKRA JACK RIGHT ANGLE</b>			
<b>Low Loss Flexible Cable Assemblies</b>			
<b>PE-C100-LSZH Coax, 50 Ohm</b>			
<b>Part No. PE38749A</b>			
1 piece price shown. See web or call for volume pricing.			
12"	24"	36"	48"
\$27.34	\$28.79	\$31.06	\$33.27
			\$35.53
			Custom Len.
			See Web
<b>Part No. PE38749B</b>			
1 piece price shown. See web or call for volume pricing.			
12"	24"	36"	48"
\$27.57	\$25.79	\$26.56	\$27.31
			\$27.34
			Custom Len.
			See Web
<b>Part No. PE38749C</b>			
1 piece price shown. See web or call for volume pricing.			
12"	24"	36"	48"
\$27.34	\$28.79	\$31.06	\$33.76
			\$35.53
			Custom Len.
			See Web
<b>Part No. PE38749D</b>			
1 piece price shown. See web or call for volume pricing.			
12"	24"	36"	48"
\$27.88	\$29.23	\$30.55	\$31.89
			\$33.22
			Custom Len.
			See Web
<b>Part No. PE38749H</b>			
1 piece price shown. See web or call for volume pricing.			
12"	24"	36"	48"
\$25.06	\$25.79	\$26.56	\$27.31
			\$27.34
			Custom Len.
			See Web
<b>Part No. PE38749I</b>			
1 piece price shown. See web or call for volume pricing.			
12"	24"	36"	48"
\$25.06	\$25.79	\$26.56	\$27.31
			\$27.34
			Custom Len.
			See Web
<b>Part No. PE38749K</b>			
1 piece price shown. See web or call for volume pricing.			
12"	24"	36"	48"
\$27.88	\$29.23	\$30.55	\$31.89
			\$33.22
			Custom Len.
			See Web
<b>Part No. PE38749Z</b>			
1 piece price shown. See web or call for volume pricing.			
12"	24"	36"	48"
\$29.28	\$30.61	\$31.94	\$33.29
			\$35.53
			Custom Len.
			See Web



\*Coax Performance at 1 GHz Notes: Cable assembly max frequency may be lower than connector or coax max frequency

# For our complete selection of cable assemblies, please visit our website

Standard Flexible Cable Assemblies				
RG174A/U Coax, 50 Ohm				
Part No.	Cable Dia.	Attn. @ 1 GHz	Power @ 1 GHz	
Part No. <a href="#">PE38753A</a>	0.1" dia.	32 dB/100ft	16 W	41
1 piece price shown. See web or call for volume pricing.				
12" 24" 36" 48"	60"	-	Custom Len.	
\$36.86 \$37.39 \$37.98 \$38.58	\$39.13	-	See Web	
Part No. <a href="#">PE38753C</a>	0.1" dia.	32 dB/100ft	16 W	42
1 piece price shown. See web or call for volume pricing.				
12" 24" 36" 48"	60"	-	Custom Len.	
\$39.82 \$40.29 \$40.78 \$41.26	\$45.61	-	See Web	
Part No. <a href="#">PE38753D</a>	0.1" dia.	32 dB/100ft	16 W	43
1 piece price shown. See web or call for volume pricing.				
12" 24" 36" 48"	60"	-	Custom Len.	
\$36.86 \$37.39 \$37.98 \$38.58	\$39.13	-	See Web	
Part No. <a href="#">PE38753H</a>	0.1" dia.	32 dB/100ft	16 W	44
1 piece price shown. See web or call for volume pricing.				
12" 24" 36" 48"	60"	-	Custom Len.	
\$40.54 \$41.03 \$41.52 \$42.00	\$42.48	-	See Web	
Part No. <a href="#">PE38753J</a>	0.1" dia.	32 dB/100ft	16 W	45
1 piece price shown. See web or call for volume pricing.				
12" 24" 36" 48"	60"	-	Custom Len.	
\$36.86 \$37.39 \$37.98 \$38.58	\$39.13	-	See Web	
Part No. <a href="#">PE38753K</a>	0.1" dia.	32 dB/100ft	16 W	46
1 piece price shown. See web or call for volume pricing.				
12" 24" 36" 48"	60"	-	Custom Len.	
\$36.86 \$37.39 \$37.98 \$38.58	\$39.13	-	See Web	
Part No. <a href="#">PE38753Z</a>	0.1" dia.	32 dB/100ft	16 W	47
1 piece price shown. See web or call for volume pricing.				
12" 24" 36" 48"	60"	-	Custom Len.	
\$43.79 \$44.43 \$41.52 \$42.00	\$42.48	-	See Web	
RG316/U Coax, 50 Ohm				
Part No. <a href="#">PE38757A</a>	0.098" dia.	38 dB/100ft	160 W	48
1 piece price shown. See web or call for volume pricing.				
12" 24" 36" 48"	60"	-	Custom Len.	
\$39.44 \$42.66 \$45.86 \$48.98	\$52.17	-	See Web	
Part No. <a href="#">PE38757C</a>	0.098" dia.	38 dB/100ft	160 W	49
1 piece price shown. See web or call for volume pricing.				
12" 24" 36" 48"	60"	-	Custom Len.	
\$39.44 \$42.66 \$45.86 \$48.98	\$52.17	-	See Web	
Part No. <a href="#">PE38757D</a>	0.098" dia.	38 dB/100ft	160 W	50
1 piece price shown. See web or call for volume pricing.				
12" 24" 36" 48"	60"	-	Custom Len.	
\$39.44 \$42.66 \$45.86 \$48.98	\$52.17	-	See Web	
Part No. <a href="#">PE38757H</a>	0.098" dia.	38 dB/100ft	160 W	51
1 piece price shown. See web or call for volume pricing.				
12" 24" 36" 48"	60"	-	Custom Len.	
\$39.44 \$42.66 \$45.86 \$48.98	\$52.17	-	See Web	
Part No. <a href="#">PE38757I</a>	0.098" dia.	38 dB/100ft	160 W	52
1 piece price shown. See web or call for volume pricing.				
12" 24" 36" 48"	60"	-	Custom Len.	
\$39.44 \$42.66 \$45.86 \$48.98	\$52.17	-	See Web	
Part No. <a href="#">PE38757K</a>	0.098" dia.	38 dB/100ft	160 W	53
1 piece price shown. See web or call for volume pricing.				
12" 24" 36" 48"	60"	-	Custom Len.	
\$39.44 \$42.66 \$45.86 \$48.98	\$52.17	-	See Web	

## FAKRA PLUG TO SMA MALE



## Standard Flexible Cable Assemblies

RG174A/U Coax, 50 Ohm				
Part No.	Cable Dia.	Attn. @ 1 GHz	Power @ 1 GHz	
Part No. <a href="#">PE3C6275</a>	0.11" dia.	32 dB/100ft	17 W	54
1 piece price shown. See web or call for volume pricing.				
12" - - -	-	-	Custom Len.	
Call - - -	-	-	See Web	

## FAKRA JACK TO FAKRA JACK



## Flexible Cable Assemblies

PE-C100-LSZH Coax, 50 Ohm				
Part No.	Cable Dia.	Attn. @ 1 GHz	Power @ 1 GHz	
Part No. <a href="#">PE38746A</a>	0.109" dia.	25 dB/100ft	40 W	55
1 piece price shown. See web or call for volume pricing.				
12" 24" 36" 48"	60"	-	Custom Len.	
\$30.49 \$31.96 \$30.42 \$31.87	\$34.13	-	See Web	
Part No. <a href="#">PE38746Z</a>	0.109" dia.	25 dB/100ft	40 W	56
1 piece price shown. See web or call for volume pricing.				
12" 24" 36" 48"	60"	-	Custom Len.	
\$26.96 \$27.70 \$29.18 \$30.73	\$32.25	-	See Web	

## Low Loss Flexible Cable Assemblies

PE-C100-LSZH Coax, 50 Ohm				
Part No.	Cable Dia.	Attn. @ 1 GHz	Power @ 1 GHz	
Part No. <a href="#">PE38746B</a>	0.109" dia.	25 dB/100ft	40 W	57
1 piece price shown. See web or call for volume pricing.				
12" 24" 36" 48"	60"	-	Custom Len.	
\$29.94 \$31.41 \$30.42 \$31.87	\$35.95	-	See Web	
Part No. <a href="#">PE38746C</a>	0.109" dia.	25 dB/100ft	40 W	58
1 piece price shown. See web or call for volume pricing.				
12" 24" 36" 48"	60"	-	Custom Len.	
\$30.49 \$31.96 \$30.42 \$34.99	\$36.50	-	See Web	
Part No. <a href="#">PE38746D</a>	0.109" dia.	25 dB/100ft	40 W	59
1 piece price shown. See web or call for volume pricing.				
12" 24" 36" 48"	60"	-	Custom Len.	
\$27.72 \$29.06 \$32.89 \$34.44	\$34.13	-	See Web	
Part No. <a href="#">PE38746H</a>	0.109" dia.	25 dB/100ft	40 W	60
1 piece price shown. See web or call for volume pricing.				
12" 24" 36" 48"	60"	-	Custom Len.	
\$24.53 \$25.36 \$26.17 \$26.93	\$27.74	-	See Web	
Part No. <a href="#">PE38746J</a>	0.109" dia.	25 dB/100ft	40 W	61
1 piece price shown. See web or call for volume pricing.				
12" 24" 36" 48"	60"	-	Custom Len.	
\$27.72 \$29.06 \$33.45 \$31.87	\$36.50	-	See Web	
Part No. <a href="#">PE38746K</a>	0.109" dia.	25 dB/100ft	40 W	62
1 piece price shown. See web or call for volume pricing.				
12" 24" 36" 48"	60"	-	Custom Len.	
\$27.72 \$29.06 \$30.42 \$34.99	\$34.13	-	See Web	

Standard Flexible Cable Assemblies				
RG174A/U Coax, 50 Ohm				
Part No.	Cable Dia.	Attn. @ 1 GHz	Power @ 1 GHz	
Part No. <a href="#">PE38750A</a>	0.1" dia.	32 dB/100ft	16 W	63
1 piece price shown. See web or call for volume pricing.				
12" 24" 36" 48"	60"	-	Custom Len.	
\$32.50 \$32.99 \$37.03 \$33.96	\$34.43	-	See Web	
Part No. <a href="#">PE38750B</a>	0.1" dia.	32 dB/100ft	16 W	64
1 piece price shown. See web or call for volume pricing.				
12" 24" 36" 48"	60"	-	Custom Len.	
\$29.54 \$30.14 \$33.18 \$31.28	\$31.87	-	See Web	
Part No. <a href="#">PE38750C</a>	0.1" dia.	32 dB/100ft	16 W	65
1 piece price shown. See web or call for volume pricing.				
12" 24" 36" 48"	60"	-	Custom Len.	
\$32.50 \$32.99 \$35.72 \$33.96	\$37.06	-	See Web	
Part No. <a href="#">PE38750D</a>	0.1" dia.	32 dB/100ft	16 W	66
1 piece price shown. See web or call for volume pricing.				
12" 24" 36" 48"	60"	-	Custom Len.	
\$32.50 \$32.99 \$36.39 \$33.96	\$37.72	-	See Web	
Part No. <a href="#">PE38750H</a>	0.1" dia.	32 dB/100ft	16 W	67
1 piece price shown. See web or call for volume pricing.				
12" 24" 36" 48"	60"	-	Custom Len.	
\$31.91 \$35.10 \$32.87 \$36.42	\$33.84	-	See Web	
Part No. <a href="#">PE38750I</a>	0.1" dia.	32 dB/100ft	16 W	68
1 piece price shown. See web or call for volume pricing.				
12" 24" 36" 48"	60"	-	Custom Len.	
\$29.54 \$30.14 \$30.72 \$31.28	\$31.87	-	See Web	
Part No. <a href="#">PE38750K</a>	0.1" dia.	32 dB/100ft	16 W	69
1 piece price shown. See web or call for volume pricing.				
12" 24" 36" 48"	60"	-	Custom Len.	
\$32.50 \$35.74 \$33.47 \$33.96	\$34.43	-	See Web	
Part No. <a href="#">PE38750Z</a>	0.1" dia.	32 dB/100ft	16 W	70
1 piece price shown. See web or call for volume pricing.				
12" 24" 36" 48"	60"	-	Custom Len.	
\$32.57 \$33.21 \$33.86 \$34.55	\$35.19	-	See Web	
RG188-DS Coax, 50 Ohm				
Part No. <a href="#">PE3W02209</a>	0.122" dia.	30 dB/100ft	160 W	71
1 piece price shown. See web or call for volume pricing.				
12" 24" 36" 48"	60"	-	Custom Len.	
\$33.82 \$37.62 \$41.41 \$45.21	\$49.00	-	See Web	
RG316/U Coax, 50 Ohm				
Part No. <a href="#">PE38754A</a>	0.098" dia.	38 dB/100ft	160 W	72
1 piece price shown. See web or call for volume pricing.				
12" 24" 36" 48"	60"	-	Custom Len.	
\$35.42 \$38.62 \$41.83 \$45.04	\$48.25	-	See Web	
Part No. <a href="#">PE38754B</a>	0.098" dia.	38 dB/100ft	160 W	73
1 piece price shown. See web or call for volume pricing.				
12" 24" 36" 48"	60"	-	Custom Len.	
\$32.20 \$35.33 \$38.53 \$41.72	\$44.91	-	See Web	
Part No. <a href="#">PE38754C</a>	0.098" dia.	38 dB/100ft	160 W	74
1 piece price shown. See web or call for volume pricing.				
12" 24" 36" 48"	60"	-	Custom Len.	
\$34.13 \$37.59 \$41.07 \$41.72	\$44.91	-	See Web	
Part No. <a href="#">PE38754D</a>	0.098" dia.	38 dB/100ft	160 W	75
1 piece price shown. See web or call for volume pricing.				
12" 24" 36" 48"	60"	-	Custom Len.	
\$35.42 \$38.90 \$38.53 \$41.72	\$44.91	-	See Web	
Part No. <a href="#">PE38754H</a>	0.098" dia.	38 dB/100ft	160 W	76
1 piece price shown. See web or call for volume pricing.				
12" 24" 36" 48"	60"	-	Custom Len.	
\$32.20 \$35.33 \$41.07 \$41.72	\$44.91	-	See Web	

Cable Assemblies

See Our Website For Current Pricing & Real-Time Stock Availability!

For Custom Lengths, Metric Lengths or Special Configurations, Please call (949) 261-1920



Technical Support  
+1 (949) 261-1920



Same-Day Shipping,  
Even Custom Cable Assemblies

For our complete selection of cable assemblies, please visit our website

Cable Assemblies

See Our Website For Current Pricing & Real-Time Stock Availability!

Part No. <a href="#">PE38754J</a>	Cable Dia.	Attn. @ 1 GHz	Power @ 1 GHz
1 piece price shown. See web or call for volume pricing.	0.098" dia.	38 dB/100ft	160 W
12" 24" 36" 48"	60"	-	Custom Len.
\$32.20 \$35.33 \$38.53 \$41.72	\$44.91	-	See Web

77

Part No. <a href="#">PE38754K</a>	Cable Dia.	Attn. @ 1 GHz	Power @ 1 GHz
1 piece price shown. See web or call for volume pricing.	0.098" dia.	38 dB/100ft	160 W
12" 24" 36" 48"	60"	-	Custom Len.
\$32.20 \$35.33 \$38.53 \$41.72	\$44.91	-	See Web

78

Part No. <a href="#">PE38754Z</a>	Cable Dia.	Attn. @ 1 GHz	Power @ 1 GHz
1 piece price shown. See web or call for volume pricing.	0.102" dia.	38 dB/100ft	160 W
12" 24" 36" 48"	60"	-	Custom Len.
\$35.82 \$39.29 \$42.77 \$46.43	\$49.97	-	See Web

79

**FAKRA JACK TO FAKRA JACK RIGHT ANGLE**



**Low Loss Flexible Cable Assemblies**

**LMR-100A-PVC Coax, 50 Ohm**

Part No. <a href="#">PE3W02943</a>	Cable Dia.	Attn. @ 1 GHz	Power @ 1 GHz
1 piece price shown. See web or call for volume pricing.	0.11" dia.	24 dB/100ft	150 W
12" 24" 36" 48"	60"	50CM	Custom Len.
\$27.11 \$27.96 \$28.02 \$28.84	\$29.65	\$27.66	See Web

80

**Standard Flexible Cable Assemblies**

**RG174A/U Coax, 50 Ohm**

Part No. <a href="#">PE3C7911</a>	Cable Dia.	Attn. @ 1 GHz	Power @ 1 GHz
1 piece price shown. See web or call for volume pricing.	0.11" dia.	32 dB/100ft	17 W
12" 24" 36" 48"	60"	50CM	Custom Len.
\$35.81 \$36.43 \$37.05 \$37.68	\$38.30	\$35.58	See Web

81

**FAKRA JACK TO MCX PLUG**



**Standard Flexible Cable Assemblies**

**RG316/U Coax, 50 Ohm**

Part No. <a href="#">PE3C7585</a>	Cable Dia.	Attn. @ 1 GHz	Power @ 1 GHz
1 piece price shown. See web or call for volume pricing.	0.102" dia.	38 dB/100ft	160 W
12" 24" 36" 48"	60"	50CM	Custom Len.
\$40.47 \$44.11 \$47.75 \$51.39	\$54.52	\$42.80	See Web

82

**FAKRA JACK TO SMA FEMALE**



**Standard Flexible Cable Assemblies**

**RG316/U Coax, 50 Ohm**

Part No. <a href="#">PE39351Z</a>	Cable Dia.	Attn. @ 1 GHz	Power @ 1 GHz
1 piece price shown. See web or call for volume pricing.	0.102" dia.	38 dB/100ft	160 W
12" 24" 36" 48"	60"	-	Custom Len.
\$62.23 \$59.75 \$62.95 \$66.12	\$69.30	-	See Web

83

**FAKRA JACK TO REVERSE POLARITY TNC MALE**



**Low Loss Flexible Cable Assemblies**

**LMR-100A-PVC Coax, 50 Ohm**

Part No. <a href="#">PE3W03361</a>	Cable Dia.	Attn. @ 1 GHz	Power @ 1 GHz
1 piece price shown. See web or call for volume pricing.	0.11" dia.	24 dB/100ft	150 W
12" 24" 36" 48"	60"	50CM	Custom Len.
\$44.78 \$45.58 \$46.40 \$47.20	\$48.00	\$45.29	See Web

84

**FAKRA JACK RIGHT ANGLE TO FAKRA PLUG**



**Standard Flexible Cable Assemblies**

**RG316/U Coax, 50 Ohm**

Part No. <a href="#">PE38757Z</a>	Cable Dia.	Attn. @ 1 GHz	Power @ 1 GHz
1 piece price shown. See web or call for volume pricing.	0.102" dia.	38 dB/100ft	160 W
12" 24" 36" 48"	60"	-	Custom Len.
\$47.74 \$46.61 \$49.81 \$53.01	\$55.71	-	See Web

85

**FME PLUG TO BNC MALE**



**Standard Flexible Cable Assemblies**

**RG58C/U Coax, 50 Ohm**

Part No. <a href="#">PE35959</a>	Cable Dia.	Attn. @ 1 GHz	Power @ 1 GHz
1 piece price shown. See web or call for volume pricing.	0.195" dia.	20 dB/100ft	44 W
12" 24" 36" 48"	60"	72"	Custom Len.
\$44.88 \$45.71 \$46.52 \$47.33	\$48.16	\$48.98	See Web

86

Part No. <a href="#">PE35962</a>	Cable Dia.	Attn. @ 1 GHz	Power @ 1 GHz
1 piece price shown. See web or call for volume pricing.	0.195" dia.	13 dB/100ft	650 W
12" 24" 36" 48"	60"	72"	Custom Len.
\$38.58 \$44.72 \$50.91 \$56.52	\$62.67	\$68.74	See Web

87

Part No. <a href="#">PE3C3420</a>	Cable Dia.	Attn. @ 1 GHz	Power @ 1 GHz
1 piece price shown. See web or call for volume pricing.	0.11" dia.	32 dB/100ft	17 W
12" 24" 36" 48"	60"	72"	Custom Len.
\$40.33 \$40.80 \$41.31 \$41.74	\$42.21	\$42.71	See Web

88

**FME PLUG TO FME PLUG**



**Low Loss Flexible Cable Assemblies**

**PE-C195 Coax, 50 Ohm**

Part No. <a href="#">PE38719</a>	Cable Dia.	Attn. @ 1 GHz	Power @ 1 GHz
1 piece price shown. See web or call for volume pricing.	0.195" dia.	11.3 dB/100ft	150 W
12" 24" 36" 48"	60"	-	Custom Len.
\$39.44 \$40.25 \$40.99 \$41.72	\$42.51	-	See Web

89

**Standard Flexible Cable Assemblies**

**RG58C/U Coax, 50 Ohm**

Part No. <a href="#">PE35953</a>	Cable Dia.	Attn. @ 1 GHz	Power @ 1 GHz
1 piece price shown. See web or call for volume pricing.	0.195" dia.	20 dB/100ft	44 W
12" 24" 36" 48"	60"	72"	Custom Len.
\$46.19 \$46.99 \$47.80 \$48.65	\$49.45	\$50.23	See Web

90

**RG142B/U Coax, 50 Ohm**

Part No. <a href="#">PE35955</a>	Cable Dia.	Attn. @ 1 GHz	Power @ 1 GHz
1 piece price shown. See web or call for volume pricing.	0.195" dia.	13 dB/100ft	650 W
12" 24" 36" 48"	60"	72"	Custom Len.
\$42.85 \$48.98 \$54.66 \$60.73	\$66.81	\$72.95	See Web

91

Part No. <a href="#">PE35957</a>	Cable Dia.	Attn. @ 1 GHz	Power @ 1 GHz
1 piece price shown. See web or call for volume pricing.	0.1" dia.	32 dB/100ft	16 W
12" 24" 36" 48"	60"	72"	Custom Len.
\$44.46 \$44.91 \$45.39 \$45.92	\$46.38	\$46.92	See Web

92

**FME PLUG BULKHEAD TO UMCX PLUG RIGHT ANGLE**

SEE MOUNTING HOLE SECTION ON PAGE 409



**Standard Flexible Cable Assemblies**

**PE-113mm Coax, 50 Ohm**

Part No. <a href="#">PE38858</a>	Cable Dia.	Attn. @ 1 GHz	Power @ 1 GHz
1 piece price shown. See web or call for volume pricing.	0.044" dia.	-	Custom Len.
6" 12"	18"	-	See Web
\$34.44	Call	Call	-

93

**FME JACK TO BNC MALE**



**Standard Flexible Cable Assemblies**

**RG58C/U Coax, 50 Ohm**

Part No. <a href="#">PE34862</a>	Cable Dia.	Attn. @ 1 GHz	Power @ 1 GHz
1 piece price shown. See web or call for volume pricing.	0.195" dia.	20 dB/100ft	44 W
12" 24" 36" 48"	60"	72"	Custom Len.
\$36.73 \$37.53 \$38.39 \$39.19	\$39.98	\$40.80	See Web

94

Part No. <a href="#">PE34864</a>	Cable Dia.	Attn. @ 1 GHz	Power @ 1 GHz
1 piece price shown. See web or call for volume pricing.	0.195" dia.	13 dB/100ft	650 W
12" 24" 36" 48"	60"	72"	Custom Len.
\$35.27 \$41.39 \$47.53 \$53.72	\$59.30	\$65.42	See Web

95

Part No. <a href="#">PE3C3409</a>	Cable Dia.	Attn. @ 1 GHz	Power @ 1 GHz
1 piece price shown. See web or call for volume pricing.	0.11" dia.	32 dB/100ft	17 W
12" 24" 36" 48"	60"	72"	Custom Len.
\$40.48 \$40.92 \$41.44 \$41.88	\$42.40	\$42.84	See Web

96

**FME JACK TO FME JACK**



**Standard Flexible Cable Assemblies**

**RG58C/U Coax, 50 Ohm**

Part No. <a href="#">PE34856</a>	Cable Dia.	Attn. @ 1 GHz	Power @ 1 GHz
1 piece price shown. See web or call for volume pricing.	0.195" dia.	20 dB/100ft	44 W
12" 24" 36" 48"	60"	72"	Custom Len.
\$41.96 \$42.78 \$43.58 \$44.41	\$45.23	\$46.04	See Web

97

Part No. <a href="#">PE34858</a>	Cable Dia.	Attn. @ 1 GHz	Power @ 1 GHz
1 piece price shown. See web or call for volume pricing.	0.195" dia.	13 dB/100ft	650 W
12" 24" 36" 48"	60"	72"	Custom Len.
\$36.12 \$42.24 \$48.46 \$54.08	\$60.21	\$66.27	See Web

98

\*Coax Performance at 1 GHz Notes: Cable assembly max frequency may be lower than connector or coax max frequency



For our complete selection of cable assemblies, please visit our website

RG174/U Coax, 50 Ohm						
Part No. <a href="#">PE34860</a>	Cable Dia.	Attn. @ 1 GHz	Power @ 1 GHz			
1 piece price shown. See web or call for volume pricing.	0.1" dia.	32 dB/100ft	16 W			
12"	24"	36"	48"	60"	72"	Custom Len.
\$49.19	\$45.19	\$45.73	\$46.19	\$46.71	\$47.18	See Web

**GR874 SEXLESS TO BNC MALE**



**Standard Flexible Cable Assemblies**

RG214/U Coax, 50 Ohm						
Part No. <a href="#">PE3145</a>	Cable Dia.	Attn. @ 1 GHz	Power @ 1 GHz			
1 piece price shown. See web or call for volume pricing.	0.425" dia.	7.32 dB/100ft	170 W			
12"	24"	36"	48"	60"	72"	Custom Len.
\$150.47	\$158.48	\$166.48	\$174.48	\$182.47	\$190.49	See Web

RG223/U Coax, 50 Ohm						
Part No. <a href="#">PE3182</a>	Cable Dia.	Attn. @ 1 GHz	Power @ 1 GHz			
1 piece price shown. See web or call for volume pricing.	0.209" dia.	13.41 dB/100ft	50 W			
12"	24"	36"	48"	60"	72"	Custom Len.
\$54.20	\$57.45	\$60.61	\$63.85	\$67.06	\$70.24	See Web

**GR874 SEXLESS TO GR874 SEXLESS**



**Standard Flexible Cable Assemblies**

RG58C/U Coax, 50 Ohm						
Part No. <a href="#">PE3211</a>	Cable Dia.	Attn. @ 1 GHz	Power @ 1 GHz			
1 piece price shown. See web or call for volume pricing.	0.195" dia.	20 dB/100ft	44 W			
12"	24"	36"	48"	60"	72"	Custom Len.
\$81.53	\$82.32	\$83.12	\$83.89	\$84.68	\$85.54	See Web

RG142B/U Coax, 50 Ohm						
Part No. <a href="#">PE3200</a>	Cable Dia.	Attn. @ 1 GHz	Power @ 1 GHz			
1 piece price shown. See web or call for volume pricing.	0.195" dia.	12.9 dB/100ft	50 W			
12"	24"	36"	48"	60"	72"	Custom Len.
\$80.19	\$86.26	\$92.41	\$98.49	\$104.56	\$109.17	See Web

RG214/U Coax, 50 Ohm						
Part No. <a href="#">PE3158</a>	Cable Dia.	Attn. @ 1 GHz	Power @ 1 GHz			
1 piece price shown. See web or call for volume pricing.	0.425" dia.	7.32 dB/100ft	170 W			
12"	24"	36"	48"	60"	72"	Custom Len.
\$222.62	\$230.63	\$238.64	\$246.65	\$254.65	\$262.64	See Web

RG223/U Coax, 50 Ohm						
Part No. <a href="#">PE3190</a>	Cable Dia.	Attn. @ 1 GHz	Power @ 1 GHz			
1 piece price shown. See web or call for volume pricing.	0.209" dia.	13.41 dB/100ft	50 W			
12"	24"	36"	48"	60"	72"	Custom Len.
\$81.94	\$85.13	\$88.31	\$91.48	\$94.68	\$97.87	See Web

**HN MALE TO 7/16 DIN MALE RIGHT ANGLE**



**Standard Flexible Cable Assemblies**

RG217/U Coax, 50 Ohm						
Part No. <a href="#">PE3W03391</a>	Cable Dia.	Attn. @ 1 GHz	Power @ 1 GHz			
1 piece price shown. See web or call for volume pricing.	0.545" dia.	5.8 dB/100ft	260 W			
12"	24"	36"	48"	60"	50CM	Custom Len.
\$281.60	\$286.91	\$292.23	\$297.53	\$302.86	\$285.01	See Web

**HN MALE TO HN MALE**



**Standard Flexible Cable Assemblies**

RG8A/U Coax, 50 Ohm						
Part No. <a href="#">PE33304</a>	Cable Dia.	Attn. @ 1 GHz	Power @ 1 GHz			
1 piece price shown. See web or call for volume pricing.	0.405" dia.	8 dB/100ft	190 W			
12"	24"	36"	48"	60"	72"	Custom Len.
\$121.10	\$124.17	\$135.02	\$138.55	\$133.39	\$136.44	See Web

RG58C/U Coax, 50 Ohm						
Part No. <a href="#">PE3852</a>	Cable Dia.	Attn. @ 1 GHz	Power @ 1 GHz			
1 piece price shown. See web or call for volume pricing.	0.195" dia.	20 dB/100ft	44 W			
12"	24"	36"	48"	60"	72"	Custom Len.
\$95.78	\$96.60	\$97.41	\$98.21	\$99.03	\$99.84	See Web

RG141A/U Coax, 50 Ohm						
Part No. <a href="#">PE34434</a>	Cable Dia.	Attn. @ 1 GHz	Power @ 1 GHz			
1 piece price shown. See web or call for volume pricing.	0.19" dia.	13 dB/100ft	650 W			
12"	24"	36"	48"	60"	72"	Custom Len.
\$103.04	\$108.42	\$115.21	\$121.96	\$128.74	\$135.50	See Web

RG142B/U Coax, 50 Ohm						
Part No. <a href="#">PE3083</a>	Cable Dia.	Attn. @ 1 GHz	Power @ 1 GHz			
1 piece price shown. See web or call for volume pricing.	0.195" dia.	12.9 dB/100ft	50 W			
12"	24"	36"	48"	60"	72"	Custom Len.
\$99.65	\$105.95	\$117.33	\$124.31	\$123.12	\$137.74	See Web

RG213/U Coax, 50 Ohm						
Part No. <a href="#">PE3038</a>	Cable Dia.	Attn. @ 1 GHz	Power @ 1 GHz			
1 piece price shown. See web or call for volume pricing.	0.405" dia.	9 dB/100ft	190 W			
12"	24"	36"	48"	60"	72"	Custom Len.
\$127.02	\$128.96	\$130.89	\$132.94	\$134.92	\$136.90	See Web

RG214/U Coax, 50 Ohm						
Part No. <a href="#">PE3095</a>	Cable Dia.	Attn. @ 1 GHz	Power @ 1 GHz			
1 piece price shown. See web or call for volume pricing.	0.425" dia.	7.32 dB/100ft	170 W			
12"	24"	36"	48"	60"	72"	Custom Len.
\$136.54	\$136.75	\$144.70	\$162.33	\$170.93	\$179.54	See Web

RG217/U Coax, 50 Ohm						
Part No. <a href="#">PE33370</a>	Cable Dia.	Attn. @ 1 GHz	Power @ 1 GHz			
1 piece price shown. See web or call for volume pricing.	0.545" dia.	5.8 dB/100ft	260 W			
12"	24"	36"	48"	60"	72"	Custom Len.
\$136.64	\$141.77	\$146.87	\$152.29	\$157.51	\$162.73	See Web

RG218/U Coax, 50 Ohm						
Part No. <a href="#">PE33583</a>	Cable Dia.	Attn. @ 1 GHz	Power @ 1 GHz			
1 piece price shown. See web or call for volume pricing.	0.87" dia.	3.8 dB/100ft	560 W			
12"	24"	36"	48"	60"	72"	Custom Len.
\$303.06	\$315.15	\$327.26	\$339.30	\$351.40	\$363.50	See Web

RG223/U Coax, 50 Ohm						
Part No. <a href="#">PE3357</a>	Cable Dia.	Attn. @ 1 GHz	Power @ 1 GHz			
1 piece price shown. See web or call for volume pricing.	0.21" dia.	13.4 dB/100ft	53 W			
12"	24"	36"	48"	60"	72"	Custom Len.
\$96.58	\$105.79	\$107.70	\$106.13	\$114.71	\$110.95	See Web

RG225/U Coax, 50 Ohm						
Part No. <a href="#">PE33778</a>	Cable Dia.	Attn. @ 1 GHz	Power @ 1 GHz			
1 piece price shown. See web or call for volume pricing.	0.43" dia.	60"	72"			
12"	24"	36"	48"	60"	72"	Custom Len.
\$157.76	\$194.20	\$230.62	\$267.05	\$303.48	\$339.91	See Web

RG393/U Coax, 50 Ohm						
Part No. <a href="#">PE3340</a>	Cable Dia.	Attn. @ 1 GHz	Power @ 1 GHz			
1 piece price shown. See web or call for volume pricing.	0.39" dia.	7.5 dB/100ft	1,700 W			
12"	24"	36"	48"	60"	72"	Custom Len.
\$141.27	\$150.04	\$176.84	\$195.66	\$213.78	\$231.93	See Web

RG400/U Coax, 50 Ohm						
Part No. <a href="#">PE33938</a>	Cable Dia.	Attn. @ 1 GHz	Power @ 1 GHz			
1 piece price shown. See web or call for volume pricing.	0.195" dia.	14.7 dB/100ft	650 W			
12"	24"	36"	48"	60"	72"	Custom Len.
\$113.21	\$114.36	\$121.93	\$129.48	\$137.04	\$144.60	See Web

RG59B/U Coax, 75 Ohm						
Part No. <a href="#">PE34436</a>	Cable Dia.	Attn. @ 1 GHz	Power @ 1 GHz			
1 piece price shown. See web or call for volume pricing.	0.242" dia.	11.5 dB/100ft	77 W			
12"	24"	36"	48"	60"	72"	Custom Len.
\$120.22	\$121.19	\$122.17	\$123.14	\$124.12	\$125.09	See Web

RG62A/U Coax, 93 Ohm						
Part No. <a href="#">PE34438</a>	Cable Dia.	Attn. @ 1 GHz	Power @ 1 GHz			
1 piece price shown. See web or call for volume pricing.	0.242" dia.	13 dB/100ft	77 W			
12"	24"	36"	48"	60"	72"	Custom Len.
\$120.67	\$122.10	\$123.53	\$124.97	\$126.40	\$127.84	See Web

**HN MALE RIGHT ANGLE TO HN FEMALE**



**Standard Flexible Cable Assemblies**

RG213/U Coax, 50 Ohm						
Part No. <a href="#">PE3W05081</a>	Cable Dia.	Attn. @ 1 GHz	Power @ 1 GHz			
1 piece price shown. See web or call for volume pricing.	0.405" dia.	190 W				
12"	24"	36"	48"	60"	50CM	Custom Len.
\$147.09	\$149.10	\$151.12	\$153.14	\$155.15	\$148.38	See Web

**LC MALE TO LC MALE**



**Standard Flexible Cable Assemblies**

RG142B/U Coax, 50 Ohm						
Part No. <a href="#">PE33541</a>	Cable Dia.	Attn. @ 1 GHz	Power @ 1 GHz			
1 piece price shown. See web or call for volume pricing.	0.195" dia.	13 dB/100ft	650 W			
60"	72"	84"	96"	108"	120"	Custom Len.
\$424.34	\$430.40	\$436.38	\$442.35	\$448.40	\$454.41	See Web

RG214/U Coax, 50 Ohm						
Part No. <a href="#">PE33491</a>	Cable Dia.	Attn. @ 1 GHz	Power @ 1 GHz			
1 piece price shown. See web or call for volume pricing.	0.425" dia.	7.32 dB/100ft	190 W			
12"	24"	36"	48"	60"	72"	Custom Len.
\$385.63	\$393.63	\$401.65	\$409.63	\$417.64	\$425.65	See Web

RG217/U Coax, 50 Ohm						
Part No. <a href="#">PE33537</a>	Cable Dia.	Attn. @ 1 GHz	Power @ 1 GHz			
1 piece price shown. See web or call for volume pricing.	0.545" dia.	5.8 dB/100ft	260 W			
60"	72"	84"	96"	108"	120"	Custom Len.
\$433.82	\$438.59	\$443.36	\$448.13	\$452.91	\$457.69	See Web

RG218/U Coax, 50 Ohm						
Part No. <a href="#">PE3960</a>	Cable Dia.	Attn. @ 1 GHz	Power @ 1 GHz			
1 piece price shown. See web or call for volume pricing.	0.87" dia.	3.8 dB/100ft	560 W			
60"	72"	84"	96"	108"	120"	Custom Len.
\$573.42	\$552.46	\$564.92	\$577.38	\$589.84	\$602.31	See Web

Cable Assemblies

See Our Website For Current Pricing & Real-Time Stock Availability!

For Custom Lengths, Metric Lengths or Special Configurations, Please call (949) 261-1920



Technical Support  
+1 (949) 261-1920



Same-Day Shipping,  
Even Custom Cable Assemblies



For our complete selection of cable assemblies, please visit our website

Cable Assemblies  
See Our Website For Current Pricing & Real-Time Stock Availability!

RG225/U Coax, 50 Ohm						
Part No. <a href="#">PE34538</a>	Cable Dia.		Attn. @ 1 GHz	Power @ 1 GHz		
1 piece price shown. See web or call for volume pricing.	0.43" dia.		32 dB/100ft	1,700 W		
60"	72"	84"	96"	108"	120"	Custom Len.
\$522.27	\$557.61	\$592.93	\$628.27	\$663.60	\$698.93	See Web

27

RG393/U Coax, 50 Ohm						
Part No. <a href="#">PE33539</a>	Cable Dia.		Attn. @ 1 GHz	Power @ 1 GHz		
1 piece price shown. See web or call for volume pricing.	0.39" dia.		7.5 dB/100ft	1,700 W		
60"	72"	84"	96"	108"	120"	Custom Len.
\$479.83	\$497.97	\$484.87	\$534.23	\$518.40	\$535.18	See Web

28

RG393/U Coax, 50 Ohm						
Part No. <a href="#">PE3W00314</a>	Cable Dia.		Attn. @ 1 GHz	Power @ 1 GHz		
1 piece price shown. See web or call for volume pricing.	0.39" dia.		7.5 dB/100ft	1,700 W		
12"	24"	36"	48"	60"	50CM	Custom Len.
\$328.05	\$345.32	\$362.57	\$379.85	\$397.12	\$339.10	See Web

29

RG174A/U Coax, 50 Ohm						
Part No. <a href="#">PE36114</a>	Cable Dia.		Attn. @ 1 GHz	Power @ 1 GHz		
1 piece price shown. See web or call for volume pricing.	0.1" dia.		32 dB/100ft	16 W		
12"	24"	36"	48"	60"	72"	Custom Len.
\$45.86	\$46.38	\$46.84	\$47.31	\$47.86	\$48.30	See Web

30

RG178B/U Coax, 50 Ohm						
Part No. <a href="#">PE36116</a>	Cable Dia.		Attn. @ 1 GHz	Power @ 1 GHz		
1 piece price shown. See web or call for volume pricing.	0.072" dia.		44.4 dB/100ft	78 W		
12"	24"	36"	48"	60"	72"	Custom Len.
\$46.45	\$47.53	\$48.56	\$49.65	\$50.73	\$51.76	See Web

31

RG316/U Coax, 50 Ohm						
Part No. <a href="#">PE36118</a>	Cable Dia.		Attn. @ 1 GHz	Power @ 1 GHz		
1 piece price shown. See web or call for volume pricing.	0.098" dia.		38 dB/100ft	160 W		
12"	24"	36"	48"	60"	72"	Custom Len.
\$48.73	\$52.04	\$54.86	\$58.18	\$61.46	\$64.77	See Web

32

RG174A/U Coax, 50 Ohm						
Part No. <a href="#">PE36120</a>	Cable Dia.		Attn. @ 1 GHz	Power @ 1 GHz		
1 piece price shown. See web or call for volume pricing.	0.1" dia.		32 dB/100ft	16 W		
12"	24"	36"	48"	60"	72"	Custom Len.
\$46.78	\$47.26	\$47.80	\$48.25	\$48.79	\$49.25	See Web

33

RG178B/U Coax, 50 Ohm						
Part No. <a href="#">PE36122</a>	Cable Dia.		Attn. @ 1 GHz	Power @ 1 GHz		
1 piece price shown. See web or call for volume pricing.	0.072" dia.		44.4 dB/100ft	78 W		
12"	24"	36"	48"	60"	72"	Custom Len.
\$54.35	\$55.39	\$56.46	\$57.50	\$58.56	\$59.62	See Web

34

RG316/U Coax, 50 Ohm						
Part No. <a href="#">PE36124</a>	Cable Dia.		Attn. @ 1 GHz	Power @ 1 GHz		
1 piece price shown. See web or call for volume pricing.	0.098" dia.		38 dB/100ft	160 W		
12"	24"	36"	48"	60"	72"	Custom Len.
\$49.65	\$52.98	\$55.78	\$59.09	\$62.40	\$65.69	See Web

35

RG174A/U Coax, 50 Ohm						
Part No. <a href="#">PE36126</a>	Cable Dia.		Attn. @ 1 GHz	Power @ 1 GHz		
1 piece price shown. See web or call for volume pricing.	0.1" dia.		32 dB/100ft	16 W		
12"	24"	36"	48"	60"	-	Custom Len.
\$47.71	\$48.19	\$48.73	\$49.17	\$49.65	-	See Web

36

RG178B/U Coax, 50 Ohm						
Part No. <a href="#">PE36128</a>	Cable Dia.		Attn. @ 1 GHz	Power @ 1 GHz		
1 piece price shown. See web or call for volume pricing.	0.072" dia.		44.4 dB/100ft	78 W		
12"	24"	36"	48"	60"	72"	Custom Len.
\$56.11	\$57.17	\$58.24	\$59.30	\$60.33	\$61.40	See Web

37

RG316/U Coax, 50 Ohm						
Part No. <a href="#">PE36130</a>	Cable Dia.		Attn. @ 1 GHz	Power @ 1 GHz		
1 piece price shown. See web or call for volume pricing.	0.098" dia.		38 dB/100ft	160 W		
12"	24"	36"	48"	60"	72"	Custom Len.
\$50.50	\$53.85	\$56.64	\$59.94	\$63.25	\$66.53	See Web

38

Standard Flexible Cable Assemblies						
RG174A/U Coax, 50 Ohm						
Part No. <a href="#">PE3C3387</a>	Cable Dia.		Attn. @ 1 GHz	Power @ 1 GHz		
1 piece price shown. See web or call for volume pricing.	0.11" dia.		32 dB/100ft	17 W		
12"	24"	36"	48"	60"	72"	Custom Len.
\$42.94	\$40.16	\$40.39	\$41.01	\$41.17	\$41.63	See Web

39

Standard Flexible Cable Assemblies						
RG174A/U Coax, 50 Ohm						
Part No. <a href="#">PE3295</a>	Cable Dia.		Attn. @ 1 GHz	Power @ 1 GHz		
1 piece price shown. See web or call for volume pricing.	0.11" dia.		32 dB/100ft	17 W		
12"	24"	36"	48"	60"	72"	Custom Len.
\$51.54	\$52.02	\$52.52	\$52.99	\$53.47	\$53.95	See Web

40

Standard Flexible Cable Assemblies						
RG188A/U Coax, 50 Ohm						
Part No. <a href="#">PE3290</a>	Cable Dia.		Attn. @ 1 GHz	Power @ 1 GHz		
1 piece price shown. See web or call for volume pricing.	0.11" dia.		26 dB/100ft	160 W		
12"	24"	36"	48"	60"	72"	Custom Len.
\$53.56	\$55.50	\$57.95	\$60.39	\$68.50	\$65.26	See Web

41

Standard Flexible Cable Assemblies						
RG196A/U Coax, 50 Ohm						
Part No. <a href="#">PE3293</a>	Cable Dia.		Attn. @ 1 GHz	Power @ 1 GHz		
1 piece price shown. See web or call for volume pricing.	0.08" dia.		49 dB/100ft	78 W		
12"	24"	36"	48"	60"	72"	Custom Len.
\$61.04	\$62.56	\$64.07	\$65.57	\$67.07	\$68.58	See Web

42

Standard Flexible Cable Assemblies						
RG316/U Coax, 50 Ohm						
Part No. <a href="#">PE3297</a>	Cable Dia.		Attn. @ 1 GHz	Power @ 1 GHz		
1 piece price shown. See web or call for volume pricing.	0.102" dia.		38 dB/100ft	160 W		
12"	24"	36"	48"	60"	72"	Custom Len.
\$56.25	\$56.23	\$59.40	\$62.58	\$70.26	\$68.93	See Web

43

Standard Flexible Cable Assemblies						
RG316-DS Coax, 50 Ohm						
Part No. <a href="#">PE36799</a>	Cable Dia.		Attn. @ 1 GHz	Power @ 1 GHz		
1 piece price shown. See web or call for volume pricing.	0.114" dia.		30 dB/100ft	160 W		
12"	24"	36"	48"	60"	72"	Custom Len.
Call	Call	Call	Call	\$53.55	\$60.72	See Web

44

Standard Flexible Cable Assemblies						
RG174A/U Coax, 50 Ohm						
Part No. <a href="#">PE3314</a>	Cable Dia.		Attn. @ 1 GHz	Power @ 1 GHz		
1 piece price shown. See web or call for volume pricing.	0.11" dia.		32 dB/100ft	17 W		
12"	24"	36"	48"	60"	72"	Custom Len.
\$54.19	\$54.18	\$54.65	\$55.13	\$55.61	\$56.08	See Web

45

Standard Flexible Cable Assemblies						
RG188A/U Coax, 50 Ohm						
Part No. <a href="#">PE3309</a>	Cable Dia.		Attn. @ 1 GHz	Power @ 1 GHz		
1 piece price shown. See web or call for volume pricing.	0.11" dia.		26 dB/100ft	160 W		
12"	24"	36"	48"	60"	72"	Custom Len.
\$52.98	\$54.86	\$57.17	\$59.55	\$61.86	\$64.24	See Web

46

Standard Flexible Cable Assemblies						
RG196A/U Coax, 50 Ohm						
Part No. <a href="#">PE3311</a>	Cable Dia.		Attn. @ 1 GHz	Power @ 1 GHz		
1 piece price shown. See web or call for volume pricing.	0.08" dia.		49 dB/100ft	78 W		
12"	24"	36"	48"	60"	72"	Custom Len.
\$55.78	\$57.23	\$58.70	\$60.15	\$61.60	\$63.06	See Web

47

Standard Flexible Cable Assemblies						
RG316/U Coax, 50 Ohm						
Part No. <a href="#">PE3316</a>	Cable Dia.		Attn. @ 1 GHz	Power @ 1 GHz		
1 piece price shown. See web or call for volume pricing.	0.102" dia.		38 dB/100ft	160 W		
12"	24"	36"	48"	60"	72"	Custom Len.
\$57.69	\$60.86	\$64.04	\$67.22	\$70.39	\$73.56	See Web

48

Standard Flexible Cable Assemblies						
LMR-100A-PVC Coax, 50 Ohm						
Part No. <a href="#">PE3W06468</a>	Cable Dia.		Attn. @ 1 GHz	Power @ 1 GHz		
1 piece price shown. See web or call for volume pricing.	0.11" dia.		24 dB/100ft	160 W		
12"	24"	36"	48"	60"	50CM	Custom Len.
\$41.22	\$42.02	\$42.83	\$43.64	\$44.44	\$41.73	See Web

49

Standard Flexible Cable Assemblies						
MCX PLUG TO TNC FEMALE BULKHEAD						
SEE MOUNTING HOLE SECTION ON PAGE 409						

\*Coax Performance at 1 GHz Notes: Cable assembly max frequency may be lower than connector or coax max frequency

For our complete selection of cable assemblies, please visit our website

RG174A/U Coax, 50 Ohm						
Part No. <a href="#">PE3W03310</a>	Cable Dia.			Attn. @ 1 GHz	Power @ 1 GHz	
1 piece price shown. See web or call for volume pricing.	0.11" dia.			32 dB/100ft	160 W	
12"	24"	36"	48"	60"	50CM	Custom Len.
\$90.50	\$91.11	\$91.73	\$92.34	\$92.96	\$90.88	See Web

50

RG316/U Coax, 50 Ohm						
Part No. <a href="#">PE3W05645</a>	Cable Dia.			Attn. @ 1 GHz	Power @ 1 GHz	
1 piece price shown. See web or call for volume pricing.	0.102" dia.			38 dB/100ft	160 W	
12"	24"	36"	48"	60"	50CM	Custom Len.
\$100.71	\$104.31	\$107.92	\$109.99	\$113.54	\$103.03	See Web

51

**MCX PLUG RIGHT ANGLE TO BNC FEMALE 4 HOLE FLANGE**

SEE MOUNTING HOLE SECTION ON PAGE 409



**Standard Flexible Cable Assemblies**

RG316-DS Coax, 50 Ohm						
Part No. <a href="#">PE3W01570</a>	Cable Dia.			Attn. @ 1 GHz	Power @ 1 GHz	
1 piece price shown. See web or call for volume pricing.	0.114" dia.			30 dB/100ft	160 W	
12"	24"	36"	48"	60"	50CM	Custom Len.
\$81.45	\$84.77	\$88.11	\$91.44	\$94.79	\$83.56	See Web

52

**MCX PLUG RIGHT ANGLE TO MCX PLUG RIGHT ANGLE**



**Standard Flexible Cable Assemblies**

RG174A/U Coax, 50 Ohm						
Part No. <a href="#">PE3304</a>	Cable Dia.			Attn. @ 1 GHz	Power @ 1 GHz	
1 piece price shown. See web or call for volume pricing.	0.11" dia.			32 dB/100ft	17 W	
12"	24"	36"	48"	60"	72"	Custom Len.
\$54.02	\$54.48	\$55.00	\$55.44	\$55.93	\$56.46	See Web

53

RG188A/U Coax, 50 Ohm						
Part No. <a href="#">PE3299</a>	Cable Dia.			Attn. @ 1 GHz	Power @ 1 GHz	
1 piece price shown. See web or call for volume pricing.	0.11" dia.			26 dB/100ft	160 W	
12"	24"	36"	48"	60"	72"	Custom Len.
\$60.33	\$62.77	\$65.23	\$67.66	\$70.10	\$72.54	See Web

54

RG196A/U Coax, 50 Ohm						
Part No. <a href="#">PE3301</a>	Cable Dia.			Attn. @ 1 GHz	Power @ 1 GHz	
1 piece price shown. See web or call for volume pricing.	0.08" dia.			49 dB/100ft	78 W	
12"	24"	36"	48"	60"	72"	Custom Len.
\$55.06	\$56.52	\$57.96	\$59.43	\$60.86	\$62.33	See Web

55

RG316/U Coax, 50 Ohm						
Part No. <a href="#">PE3306</a>	Cable Dia.			Attn. @ 1 GHz	Power @ 1 GHz	
1 piece price shown. See web or call for volume pricing.	0.102" dia.			38 dB/100ft	160 W	
12"	24"	36"	48"	60"	72"	Custom Len.
\$62.45	\$65.63	\$68.80	\$71.98	\$75.16	\$78.33	See Web

56

RG316-DS Coax, 50 Ohm						
Part No. <a href="#">PE37099</a>	Cable Dia.			Attn. @ 1 GHz	Power @ 1 GHz	
1 piece price shown. See web or call for volume pricing.	0.114" dia.			30 dB/100ft	160 W	
12"	24"	36"	48"	60"	-	Custom Len.
\$62.29	\$65.49	\$74.15	\$71.88	\$75.08	-	See Web

57

RG400/U Coax, 50 Ohm						
Part No. <a href="#">PE35463</a>	Cable Dia.			Attn. @ 1 GHz	Power @ 1 GHz	
1 piece price shown. See web or call for volume pricing.	0.195" dia.			14.7 dB/100ft	650 W	
12"	24"	36"	48"	60"	-	Custom Len.
\$71.59	\$79.26	\$86.91	\$94.57	\$102.24	-	See Web

58

**MCX PLUG RIGHT ANGLE TO MCX JACK BULKHEAD**

SEE MOUNTING HOLE SECTION ON PAGE 409



**Standard Flexible Cable Assemblies**

RG174A/U Coax, 50 Ohm						
Part No. <a href="#">PE3W01300</a>	Cable Dia.			Attn. @ 1 GHz	Power @ 1 GHz	
1 piece price shown. See web or call for volume pricing.	0.11" dia.			32 dB/100ft	17 W	
12"	24"	36"	48"	60"	50CM	Custom Len.
\$58.88	\$67.11	\$67.72	\$68.34	\$68.95	\$66.88	See Web

59

**MCX PLUG RIGHT ANGLE TO SMA MALE**



**Standard Formable Cable Assemblies**

PE-SR405FLJ Coax, 50 Ohm						
Part No. <a href="#">PE3W07396</a>	Cable Dia.			Attn. @ 1 GHz	Power @ 1 GHz	
1 piece price shown. See web or call for volume pricing.	0.105" dia.			19.5 dB/100ft	121.5 W	
12"	24"	36"	48"	60"	50CM	Custom Len.
\$104.65	\$112.89	\$122.60	\$132.31	\$141.94	\$109.41	See Web

60

RG316/U Coax, 50 Ohm						
Part No. <a href="#">PE3W07964</a>	Cable Dia.			Attn. @ 1 GHz	Power @ 1 GHz	
1 piece price shown. See web or call for volume pricing.	0.105" dia.			19.5 dB/100ft	121.5 W	
12"	24"	36"	48"	60"	50CM	Custom Len.
\$50.61	\$60.00	\$69.85	\$79.70	\$89.55	\$56.46	See Web

61

**MCX JACK TO MCX JACK**



**Standard Flexible Cable Assemblies**

RG178B/U Coax, 50 Ohm						
Part No. <a href="#">PE3W00099</a>	Cable Dia.			Attn. @ 1 GHz	Power @ 1 GHz	
1 piece price shown. See web or call for volume pricing.	0.072" dia.			44.4 dB/100ft	78 W	
12"	24"	36"	48"	60"	50CM	Custom Len.
\$75.24	\$76.47	\$77.71	\$78.96	\$80.21	\$76.03	See Web

62

**MHV MALE TO MHV MALE**



**Standard Flexible Cable Assemblies**

RG8A/U Coax, 50 Ohm						
Part No. <a href="#">PE3098</a>	Cable Dia.			Attn. @ 1 GHz	Power @ 1 GHz	
1 piece price shown. See web or call for volume pricing.	0.405" dia.			8 dB/100ft	190 W	
12"	24"	36"	48"	60"	72"	Custom Len.
\$103.60	\$111.62	\$108.29	\$111.37	\$121.86	\$125.26	See Web

63

RG58C/U Coax, 50 Ohm						
Part No. <a href="#">PE3516</a>	Cable Dia.			Attn. @ 1 GHz	Power @ 1 GHz	
1 piece price shown. See web or call for volume pricing.	0.195" dia.			20 dB/100ft	44 W	
12"	24"	36"	48"	60"	72"	Custom Len.
\$85.51	\$86.40	\$87.29	\$88.24	\$89.15	\$90.07	See Web

64

RG141A/U Coax, 50 Ohm						
Part No. <a href="#">PE34429</a>	Cable Dia.			Attn. @ 1 GHz	Power @ 1 GHz	
1 piece price shown. See web or call for volume pricing.	0.19" dia.			13 dB/100ft	650 W	
12"	24"	36"	48"	60"	72"	Custom Len.
\$94.12	\$101.21	\$113.34	\$121.27	\$128.88	\$127.80	See Web

65

RG142B/U Coax, 50 Ohm						
Part No. <a href="#">PE3914</a>	Cable Dia.			Attn. @ 1 GHz	Power @ 1 GHz	
1 piece price shown. See web or call for volume pricing.	0.195" dia.			12.9 dB/100ft	160 W	
12"	24"	36"	48"	60"	72"	Custom Len.
\$64.98	\$71.26	\$77.57	\$82.52	\$90.17	\$96.12	See Web

66

RG174A/U Coax, 50 Ohm						
Part No. <a href="#">PE34427</a>	Cable Dia.			Attn. @ 1 GHz	Power @ 1 GHz	
1 piece price shown. See web or call for volume pricing.	0.1" dia.			32 dB/100ft	16 W	
12"	24"	36"	48"	60"	72"	Custom Len.
\$107.82	\$106.80	\$111.83	\$107.74	\$113.13	\$113.77	See Web

67

RG188A/U Coax, 50 Ohm						
Part No. <a href="#">PE34431</a>	Cable Dia.			Attn. @ 1 GHz	Power @ 1 GHz	
1 piece price shown. See web or call for volume pricing.	0.11" dia.			26 dB/100ft	160 W	
12"	24"	36"	48"	60"	72"	Custom Len.
\$110.30	\$112.70	\$115.10	\$117.52	\$119.92	\$122.32	See Web

68

RG214/U Coax, 50 Ohm						
Part No. <a href="#">PE3735</a>	Cable Dia.			Attn. @ 1 GHz	Power @ 1 GHz	
1 piece price shown. See web or call for volume pricing.	0.425" dia.			7.32 dB/100ft	190 W	
12"	24"	36"	48"	60"	72"	Custom Len.
\$115.80	\$117.19	\$132.66	\$133.08	\$141.02	\$148.96	See Web

69

RG223/U Coax, 50 Ohm						
Part No. <a href="#">PE3694</a>	Cable Dia.			Attn. @ 1 GHz	Power @ 1 GHz	
1 piece price shown. See web or call for volume pricing.	0.21" dia.			13.4 dB/100ft	53 W	
12"	24"	36"	48"	60"	72"	Custom Len.
\$65.55	\$65.02	\$68.21	\$76.00	\$74.59	\$82.98	See Web

70

RG225/U Coax, 50 Ohm						
Part No. <a href="#">PE34423</a>	Cable Dia.			Attn. @ 1 GHz	Power @ 1 GHz	
1 piece price shown. See web or call for volume pricing.	0.43" dia.			-	1,700 W	
12"	24"	36"	48"	60"	72"	Custom Len.
\$128.48	\$163.80	\$199.13	\$234.48	\$269.80	\$305.13	See Web

71

RG316/U Coax, 50 Ohm						
Part No. <a href="#">PE34433</a>	Cable Dia.			Attn. @ 1 GHz	Power @ 1 GHz	
1 piece price shown. See web or call for volume pricing.	0.098" dia.			38 dB/100ft	160 W	
12"	24"	36"	48"	60"	72"	Custom Len.
\$104.56	\$107.85	\$109.60	\$112.86	\$116.12	\$119.37	See Web

72

RG393/U Coax, 50 Ohm						
Part No. <a href="#">PE3577</a>	Cable Dia.			Attn. @ 1 GHz	Power @ 1 GHz	
1 piece price shown. See web or call for volume pricing.	0.39" dia.			8.8 dB/100ft	1,700 W	
12"	24"	36"	48"	60"	72"	Custom Len.
\$116.67	\$141.45	\$150.20	\$166.98	\$183.74	\$200.50	See Web

73

RG400/U Coax, 50 Ohm						
Part No. <a href="#">PE34425</a>	Cable Dia.			Attn. @ 1 GHz	Power @ 1 GHz	
1 piece price shown. See web or call for volume pricing.	0.195" dia.			14.7 dB/100ft	650 W	
12"	24"	36"	48"	60"	72"	Custom Len.
\$73.87	\$81.53	\$89.21	\$96.86	\$104.53	\$118.09	See Web

74

RG59B/U Coax, 75 Ohm						
Part No. <a href="#">PE3542</a>	Cable Dia.			Attn. @ 1 GHz	Power @ 1 GHz	
1 piece price shown. See web or call for volume pricing.	0.242" dia.			11.5 dB/100ft	77 W	
12"	24"	36"	48"	60"	72"	Custom Len.
\$50.38	\$55.07	\$56.20	\$53.58	\$58.57	\$59.74	See Web

75

Cable Assemblies

See Our Website For Current Pricing & Real-Time Stock Availability!

For Custom Lengths, Metric Lengths or Special Configurations, Please call (949) 261-1920



Technical Support  
+1 (949) 261-1920



Same-Day Shipping,  
Even Custom Cable Assemblies

For our complete selection of cable assemblies, please visit our website

Cable Assemblies  
See Our Website For Current Pricing & Real-Time Stock Availability!

RG62A/U Coax, 93 Ohm						
Part No. <a href="#">PE3517</a>	Cable Dia.	Attn. @ 1 GHz	Power @ 1 GHz			
1 piece price shown. See web or call for volume pricing.						
12"	24"	36"	48"	60"	72"	Custom Len.
\$53.94	\$55.14	\$56.83	\$54.94	\$56.47	\$62.08	See Web
<b>MHV MALE TO MHV MALE RIGHT ANGLE</b>						
Standard Flexible Cable Assemblies						
RG174A/U Coax, 50 Ohm						
Part No. <a href="#">PE35799</a>	Cable Dia.	Attn. @ 1 GHz	Power @ 1 GHz			
1 piece price shown. See web or call for volume pricing.						
12"	24"	36"	48"	60"	72"	Custom Len.
\$111.46	\$112.09	\$112.70	\$106.55	\$107.03	-	See Web
<b>MHV MALE TO SHV PLUG</b>						
Standard Flexible Cable Assemblies						
RG8A/U Coax, 50 Ohm						
Part No. <a href="#">PE3365</a>	Cable Dia.	Attn. @ 1 GHz	Power @ 1 GHz			
1 piece price shown. See web or call for volume pricing.						
12"	24"	36"	48"	60"	72"	Custom Len.
\$105.25	\$106.87	\$109.93	\$113.00	\$116.07	\$119.14	See Web
RG58C/U Coax, 50 Ohm						
Part No. <a href="#">PE3950</a>	Cable Dia.	Attn. @ 1 GHz	Power @ 1 GHz			
1 piece price shown. See web or call for volume pricing.						
12"	24"	36"	48"	60"	72"	Custom Len.
\$97.83	\$106.55	\$107.44	\$100.25	\$107.77	\$108.68	See Web
RG141A/U Coax, 50 Ohm						
Part No. <a href="#">PE34413</a>	Cable Dia.	Attn. @ 1 GHz	Power @ 1 GHz			
1 piece price shown. See web or call for volume pricing.						
12"	24"	36"	48"	60"	72"	Custom Len.
\$103.54	\$109.11	\$127.29	\$135.21	\$130.09	\$137.11	See Web
RG142B/U Coax, 50 Ohm						
Part No. <a href="#">PE3085</a>	Cable Dia.	Attn. @ 1 GHz	Power @ 1 GHz			
1 piece price shown. See web or call for volume pricing.						
12"	24"	36"	48"	60"	72"	Custom Len.
\$96.38	\$102.70	\$107.47	\$113.68	\$119.90	\$134.34	See Web
RG174A/U Coax, 50 Ohm						
Part No. <a href="#">PE34419</a>	Cable Dia.	Attn. @ 1 GHz	Power @ 1 GHz			
1 piece price shown. See web or call for volume pricing.						
12"	24"	36"	48"	60"	72"	Custom Len.
\$111.33	\$107.00	\$112.60	\$107.98	\$106.93	\$107.45	See Web
RG188A/U Coax, 50 Ohm						
Part No. <a href="#">PE34415</a>	Cable Dia.	Attn. @ 1 GHz	Power @ 1 GHz			
1 piece price shown. See web or call for volume pricing.						
12"	24"	36"	48"	60"	72"	Custom Len.
\$106.88	\$109.22	\$111.49	\$113.83	\$116.12	\$118.44	See Web
RG214/U Coax, 50 Ohm						
Part No. <a href="#">PE33516</a>	Cable Dia.	Attn. @ 1 GHz	Power @ 1 GHz			
1 piece price shown. See web or call for volume pricing.						
12"	24"	36"	48"	60"	72"	Custom Len.
\$117.54	\$118.83	\$126.77	\$134.70	\$151.93	\$150.60	See Web
RG223/U Coax, 50 Ohm						
Part No. <a href="#">PE34411</a>	Cable Dia.	Attn. @ 1 GHz	Power @ 1 GHz			
1 piece price shown. See web or call for volume pricing.						
12"	24"	36"	48"	60"	72"	Custom Len.
\$79.34	\$82.55	\$90.94	\$88.92	\$92.09	\$101.56	See Web
RG225/U Coax, 50 Ohm						
Part No. <a href="#">PE34407</a>	Cable Dia.	Attn. @ 1 GHz	Power @ 1 GHz			
1 piece price shown. See web or call for volume pricing.						
12"	24"	36"	48"	60"	72"	Custom Len.
\$131.93	\$167.25	\$202.58	\$237.92	\$273.24	\$308.58	See Web
RG316/U Coax, 50 Ohm						
Part No. <a href="#">PE34417</a>	Cable Dia.	Attn. @ 1 GHz	Power @ 1 GHz			
1 piece price shown. See web or call for volume pricing.						
12"	24"	36"	48"	60"	72"	Custom Len.
\$107.77	\$111.04	\$114.29	\$117.55	\$120.80	\$124.03	See Web
RG393/U Coax, 50 Ohm						
Part No. <a href="#">PE33984</a>	Cable Dia.	Attn. @ 1 GHz	Power @ 1 GHz			
1 piece price shown. See web or call for volume pricing.						
12"	24"	36"	48"	60"	72"	Custom Len.
\$119.51	\$136.27	\$153.05	\$169.81	\$186.57	\$203.35	See Web
RG400/U Coax, 50 Ohm						
Part No. <a href="#">PE34409</a>	Cable Dia.	Attn. @ 1 GHz	Power @ 1 GHz			
1 piece price shown. See web or call for volume pricing.						
12"	24"	36"	48"	60"	72"	Custom Len.
\$84.57	\$92.28	\$100.00	\$107.72	\$113.83	\$129.25	See Web
RG59B/U Coax, 75 Ohm						
Part No. <a href="#">PE3108</a>	Cable Dia.	Attn. @ 1 GHz	Power @ 1 GHz			
1 piece price shown. See web or call for volume pricing.						
12"	24"	36"	48"	60"	72"	Custom Len.
\$81.32	\$82.44	\$77.40	\$84.80	\$79.50	\$87.12	See Web

RG62A/U Coax, 93 Ohm						
Part No. <a href="#">PE3451</a>	Cable Dia.	Attn. @ 1 GHz	Power @ 1 GHz			
1 piece price shown. See web or call for volume pricing.						
12"	24"	36"	48"	60"	72"	Custom Len.
\$74.40	\$75.91	\$77.42	\$78.92	\$80.43	\$81.96	See Web
<b>MINI SMP FEMALE TO MINI SMP FEMALE RIGHT ANGLE</b>						
Standard Formable Cable Assemblies						
PE-SR405FLJ Coax, 50 Ohm						
Part No. <a href="#">PE3C6069</a>	Cable Dia.	Attn. @ 1 GHz	Power @ 1 GHz			
1 piece price shown. See web or call for volume pricing.						
12"	24"	36"	48"	60"	50CM	Custom Len.
\$119.19	\$128.91	\$138.63	\$148.34	\$158.05	\$125.42	See Web
<b>MINI SMP FEMALE TO SMA MALE RIGHT ANGLE</b>						
Standard Formable Cable Assemblies						
PE-SR405FL Coax, 50 Ohm						
Part No. <a href="#">PE3C7629</a>	Cable Dia.	Attn. @ 1 GHz	Power @ 1 GHz			
1 piece price shown. See web or call for volume pricing.						
12"	24"	36"	48"	60"	50CM	Custom Len.
\$104.70	\$115.91	\$128.57	\$141.23	\$153.90	\$111.35	See Web
<b>MINI UHF MALE TO MINI UHF MALE</b>						
Standard Flexible Cable Assemblies						
RG58C/U Coax, 50 Ohm						
Part No. <a href="#">PE3258</a>	Cable Dia.	Attn. @ 1 GHz	Power @ 1 GHz			
1 piece price shown. See web or call for volume pricing.						
12"	24"	36"	48"	60"	72"	Custom Len.
\$35.65	\$36.47	\$37.28	\$38.10	\$42.89	\$39.72	See Web
RG142B/U Coax, 50 Ohm						
Part No. <a href="#">PE3263</a>	Cable Dia.	Attn. @ 1 GHz	Power @ 1 GHz			
1 piece price shown. See web or call for volume pricing.						
12"	24"	36"	48"	60"	72"	Custom Len.
\$35.56	\$39.06	\$45.25	\$51.38	\$57.05	\$63.11	See Web
RG223/U Coax, 50 Ohm						
Part No. <a href="#">PE3265</a>	Cable Dia.	Attn. @ 1 GHz	Power @ 1 GHz			
1 piece price shown. See web or call for volume pricing.						
12"	24"	36"	48"	60"	72"	Custom Len.
\$29.99	\$33.27	\$39.91	\$39.72	\$42.98	\$46.19	See Web
RG400/U Coax, 50 Ohm						
Part No. <a href="#">PE3269</a>	Cable Dia.	Attn. @ 1 GHz	Power @ 1 GHz			
1 piece price shown. See web or call for volume pricing.						
12"	24"	36"	48"	60"	72"	Custom Len.
\$41.26	\$49.05	\$56.32	\$64.03	\$71.77	\$79.48	See Web
<b>MMBX PLUG TO MMBX PLUG</b>						
Standard Formable Cable Assemblies						
PE-SR405FLJ Coax, 50 Ohm						
Part No. <a href="#">PE3C4064</a>	Cable Dia.	Attn. @ 1 GHz	Power @ 1 GHz			
1 piece price shown. See web or call for volume pricing.						
4"	6"	8"	12"	18"	24"	Custom Len.
\$55.10	\$56.48	\$57.85	\$66.68	\$64.74	\$68.89	See Web
Standard Flexible Cable Assemblies						
RG174A/U Coax, 50 Ohm						
Part No. <a href="#">PE3C4031</a>	Cable Dia.	Attn. @ 1 GHz	Power @ 1 GHz			
1 piece price shown. See web or call for volume pricing.						
4"	6"	8"	12"	18"	24"	Custom Len.
\$49.53	\$49.60	\$49.68	\$49.84	\$50.06	\$50.30	See Web
RG178B/U Coax, 50 Ohm						
Part No. <a href="#">PE3C3985</a>	Cable Dia.	Attn. @ 1 GHz	Power @ 1 GHz			
1 piece price shown. See web or call for volume pricing.						
4"	6"	8"	12"	18"	24"	Custom Len.
\$49.70	\$49.87	\$50.05	\$50.40	\$50.91	\$51.43	See Web
RG316/U Coax, 50 Ohm						
Part No. <a href="#">PE3C4014</a>	Cable Dia.	Attn. @ 1 GHz	Power @ 1 GHz			
1 piece price shown. See web or call for volume pricing.						
4"	6"	8"	12"	18"	24"	Custom Len.
\$50.40	\$50.91	\$51.43	\$52.48	\$54.03	\$55.07	See Web
RG316-DS Coax, 50 Ohm						
Part No. <a href="#">PE3C4048</a>	Cable Dia.	Attn. @ 1 GHz	Power @ 1 GHz			
1 piece price shown. See web or call for volume pricing.						
4"	6"	8"	12"	18"	24"	Custom Len.
\$50.42	\$50.92	\$51.45	\$52.51	\$54.06	\$55.13	See Web

\*Coax Performance at 1 GHz Notes: Cable assembly max frequency may be lower than connector or coax max frequency

For our complete selection of cable assemblies, please visit our website

**MMBX PLUG TO MMBX PLUG  
RIGHT ANGLE**



**Standard Flexible Cable Assemblies**

**RG174A/U Coax, 50 Ohm**

Part No. <a href="#">PE3C4032</a>	Cable Dia.	Attn. @ 1 GHz	Power @ 1 GHz
1 piece price shown. See web or call for volume pricing.	0.11" dia.	32 dB/100ft	17 W
4" 6" 8" 12"	18" 24"	Custom Len.	
\$53.73 \$53.81 \$53.88 \$54.04	\$54.28	\$54.50	See Web

4

**RG178B/U Coax, 50 Ohm**

Part No. <a href="#">PE3C3986</a>	Cable Dia.	Attn. @ 1 GHz	Power @ 1 GHz
1 piece price shown. See web or call for volume pricing.	0.072" dia.	44.41 dB/100ft	55 W
4" 6" 8" 12"	18" 24"	Custom Len.	
\$53.91 \$54.07 \$54.24 \$54.10	\$54.61	\$55.13	See Web

5

**RG316/U Coax, 50 Ohm**

Part No. <a href="#">PE3C4015</a>	Cable Dia.	Attn. @ 1 GHz	Power @ 1 GHz
1 piece price shown. See web or call for volume pricing.	0.098" dia.	58 dB/100ft	160 W
4" 6" 8" 12"	18" 24"	Custom Len.	
\$54.10 \$54.61 \$55.13 \$56.16	\$57.70	\$59.22	See Web

6

**RG316-DS Coax, 50 Ohm**

Part No. <a href="#">PE3C4049</a>	Cable Dia.	Attn. @ 1 GHz	Power @ 1 GHz
1 piece price shown. See web or call for volume pricing.	0.114" dia.	9.15 dB/100ft	85 W
4" 6" 8" 12"	18" 24"	Custom Len.	
\$54.11 \$54.62 \$55.15 \$56.19	\$57.73	\$59.30	See Web

7

**MMBX PLUG TO N FEMALE BULKHEAD**



SEE MOUNTING HOLE SECTION ON PAGE 409

**Standard Flexible Cable Assemblies**

**RG174A/U Coax, 50 Ohm**

Part No. <a href="#">PE3C4040</a>	Cable Dia.	Attn. @ 1 GHz	Power @ 1 GHz
1 piece price shown. See web or call for volume pricing.	0.11" dia.	32 dB/100ft	17 W
4" 6" 8" 12"	18" 24"	Custom Len.	
\$64.52 \$64.60 \$64.69 \$64.84	\$65.06	\$65.30	See Web

8

**RG178B/U Coax, 50 Ohm**

Part No. <a href="#">PE3C3993</a>	Cable Dia.	Attn. @ 1 GHz	Power @ 1 GHz
1 piece price shown. See web or call for volume pricing.	0.072" dia.	44.41 dB/100ft	55 W
4" 6" 8" 12"	18" 24"	Custom Len.	
\$58.36 \$58.53 \$58.71 \$59.06	\$59.57	\$60.07	See Web

9

**RG316/U Coax, 50 Ohm**

Part No. <a href="#">PE3C4023</a>	Cable Dia.	Attn. @ 1 GHz	Power @ 1 GHz
1 piece price shown. See web or call for volume pricing.	0.098" dia.	58 dB/100ft	160 W
4" 6" 8" 12"	18" 24"	Custom Len.	
\$65.40 \$65.91 \$66.42 \$67.45	\$69.00	\$70.53	See Web

10

**RG316-DS Coax, 50 Ohm**

Part No. <a href="#">PE3C4056</a>	Cable Dia.	Attn. @ 1 GHz	Power @ 1 GHz
1 piece price shown. See web or call for volume pricing.	0.114" dia.	9.15 dB/100ft	85 W
4" 6" 8" 12"	18" 24"	Custom Len.	
\$66.18 \$66.69 \$67.21 \$68.24	\$69.79	\$71.35	See Web

11

**MMBX PLUG TO SMA MALE**



**Standard Formable Cable Assemblies**

**PE-SR405FLJ Coax, 50 Ohm**

Part No. <a href="#">PE3C4068</a>	Cable Dia.	Attn. @ 1 GHz	Power @ 1 GHz
1 piece price shown. See web or call for volume pricing.	0.098" dia.	19.5 dB/100ft	121.5 W
4" 6" 8" 12"	18" 24"	Custom Len.	
\$54.04 \$50.98 \$52.38 \$60.12	\$58.80	\$62.95	See Web

12

**Standard Flexible Cable Assemblies**

**RG174A/U Coax, 50 Ohm**

Part No. <a href="#">PE3C4036</a>	Cable Dia.	Attn. @ 1 GHz	Power @ 1 GHz
1 piece price shown. See web or call for volume pricing.	0.11" dia.	32 dB/100ft	17 W
4" 6" 8" 12"	18" 24"	Custom Len.	
\$46.60 \$46.68 \$46.76 \$51.61	\$47.14	\$52.24	See Web

13

**RG178B/U Coax, 50 Ohm**

Part No. <a href="#">PE3C3989</a>	Cable Dia.	Attn. @ 1 GHz	Power @ 1 GHz
1 piece price shown. See web or call for volume pricing.	0.072" dia.	44.41 dB/100ft	55 W
4" 6" 8" 12"	18" 24"	Custom Len.	
\$54.69 \$54.85 \$55.04 \$55.38	\$55.89	\$56.40	See Web

14

**RG316/U Coax, 50 Ohm**

Part No. <a href="#">PE3C4019</a>	Cable Dia.	Attn. @ 1 GHz	Power @ 1 GHz
1 piece price shown. See web or call for volume pricing.	0.098" dia.	38 dB/100ft	160 W
4" 6" 8" 12"	18" 24"	Custom Len.	
\$47.49 \$47.99 \$48.51 \$54.50	\$51.10	\$57.46	See Web

15

**RG316-DS Coax, 50 Ohm**

Part No. <a href="#">PE3C3854</a>	Cable Dia.	Attn. @ 1 GHz	Power @ 1 GHz
1 piece price shown. See web or call for volume pricing.	0.114" dia.	30 dB/100ft	85 W
4" 6" 8" 12"	18" 24"	Custom Len.	
\$42.23 \$42.75 \$43.28 \$44.31	\$45.88	\$47.44	See Web

16

**MMBX PLUG TO SMA MALE  
RIGHT ANGLE**



**Standard Flexible Cable Assemblies**

**RG174A/U Coax, 50 Ohm**

Part No. <a href="#">PE3C4044</a>	Cable Dia.	Attn. @ 1 GHz	Power @ 1 GHz
1 piece price shown. See web or call for volume pricing.	0.11" dia.	32 dB/100ft	17 W
4" 6" 8" 12"	18" 24"	Custom Len.	
\$57.14 \$57.20 \$57.30 \$57.45	\$57.68	\$57.91	See Web

17

**RG178B/U Coax, 50 Ohm**

Part No. <a href="#">PE3C3997</a>	Cable Dia.	Attn. @ 1 GHz	Power @ 1 GHz
1 piece price shown. See web or call for volume pricing.	0.072" dia.	44.41 dB/100ft	55 W
4" 6" 8" 12"	18" 24"	Custom Len.	
\$64.16 \$64.32 \$64.49 \$64.84	\$65.34	\$65.86	See Web

18

**RG316/U Coax, 50 Ohm**

Part No. <a href="#">PE3C4027</a>	Cable Dia.	Attn. @ 1 GHz	Power @ 1 GHz
1 piece price shown. See web or call for volume pricing.	0.098" dia.	58 dB/100ft	160 W
4" 6" 8" 12"	18" 24"	Custom Len.	
\$58.00 \$58.52 \$59.04 \$60.06	\$61.60	\$63.14	See Web

19

**RG316-DS Coax, 50 Ohm**

Part No. <a href="#">PE3C4060</a>	Cable Dia.	Attn. @ 1 GHz	Power @ 1 GHz
1 piece price shown. See web or call for volume pricing.	0.114" dia.	30 dB/100ft	85 W
4" 6" 8" 12"	18" 24"	Custom Len.	
\$56.46 \$56.95 \$57.48 \$58.52	\$60.06	\$61.62	See Web

20

**MMBX PLUG TO SMA FEMALE**



**Standard Flexible Cable Assemblies**

**RG174A/U Coax, 50 Ohm**

Part No. <a href="#">PE3C4046</a>	Cable Dia.	Attn. @ 1 GHz	Power @ 1 GHz
1 piece price shown. See web or call for volume pricing.	0.11" dia.	32 dB/100ft	17 W
4" 6" 8" 12"	18" 24"	Custom Len.	
\$56.31 \$56.37 \$56.47 \$56.61	\$56.85	\$57.08	See Web

21

**RG178B/U Coax, 50 Ohm**

Part No. <a href="#">PE3C3999</a>	Cable Dia.	Attn. @ 1 GHz	Power @ 1 GHz
1 piece price shown. See web or call for volume pricing.	0.072" dia.	44.41 dB/100ft	55 W
4" 6" 8" 12"	18" 24"	Custom Len.	
\$63.93 \$64.10 \$64.28 \$64.62	\$65.13	\$65.65	See Web

22

**RG316/U Coax, 50 Ohm**

Part No. <a href="#">PE3C4029</a>	Cable Dia.	Attn. @ 1 GHz	Power @ 1 GHz
1 piece price shown. See web or call for volume pricing.	0.098" dia.	38 dB/100ft	160 W
4" 6" 8" 12"	18" 24"	Custom Len.	
\$57.17 \$57.69 \$58.21 \$65.15	\$60.77	\$62.30	See Web

23

**RG316-DS Coax, 50 Ohm**

Part No. <a href="#">PE3C4062</a>	Cable Dia.	Attn. @ 1 GHz	Power @ 1 GHz
1 piece price shown. See web or call for volume pricing.	0.114" dia.	30 dB/100ft	85 W
4" 6" 8" 12"	18" 24"	Custom Len.	
\$56.45 \$56.94 \$57.47 \$58.51	\$60.05	\$61.61	See Web

24

**MMBX PLUG TO SMA FEMALE  
BULKHEAD**



SEE MOUNTING HOLE SECTION ON PAGE 409

**Standard Formable Cable Assemblies**

**PE-SR405FLJ Coax, 50 Ohm**

Part No. <a href="#">PE3C4066</a>	Cable Dia.	Attn. @ 1 GHz	Power @ 1 GHz
1 piece price shown. See web or call for volume pricing.	0.098" dia.	19.5 dB/100ft	121.5 W
4" 6" 8" 12"	18" 24"	Custom Len.	
\$57.20 \$53.88 \$54.77 \$63.28	\$61.65	\$65.81	See Web

25

**Standard Flexible Cable Assemblies**

**RG174A/U Coax, 50 Ohm**

Part No. <a href="#">PE3C4034</a>	Cable Dia.	Attn. @ 1 GHz	Power @ 1 GHz
1 piece price shown. See web or call for volume pricing.	0.11" dia.	32 dB/100ft	17 W
4" 6" 8" 12"	18" 24"	Custom Len.	
\$52.55 \$52.62 \$52.71 \$57.61	\$57.93	\$53.33	See Web

26

**RG178B/U Coax, 50 Ohm**

Part No. <a href="#">PE3C3922</a>	Cable Dia.	Attn. @ 1 GHz	Power @ 1 GHz
1 piece price shown. See web or call for volume pricing.	0.072" dia.	44.41 dB/100ft	55 W
4" 6" 8" 12"	18" 24"	Custom Len.	
\$57.85 \$58.01 \$58.21 \$58.54	\$59.15	\$59.57	See Web

27

**RG316/U Coax, 50 Ohm**

Part No. <a href="#">PE3C4017</a>	Cable Dia.	Attn. @ 1 GHz	Power @ 1 GHz
1 piece price shown. See web or call for volume pricing.	0.098" dia.	38 dB/100ft	160 W
4" 6" 8" 12"	18" 24"	Custom Len.	
\$53.43 \$53.94 \$54.46 \$55.00	\$56.53	\$58.07	See Web

28

**RG316-DS Coax, 50 Ohm**

Part No. <a href="#">PE3C4051</a>	Cable Dia.	Attn. @ 1 GHz	Power @ 1 GHz
1 piece price shown. See web or call for volume pricing.	0.114" dia.	9.15 dB/100ft	85 W
4" 6" 8" 12"	18" 24"	Custom Len.	
\$59.63 \$60.14 \$60.66 \$61.69	\$63.25	\$64.80	See Web

29

For Custom Lengths, Metric Lengths or Special Configurations, Please call (949) 261-1920



Technical Support  
+1 (949) 261-1920



Same-Day Shipping,  
Even Custom Cable Assemblies



For our complete selection of cable assemblies, please visit our website

**MMBX PLUG TO REVERSE POLARITY SMA FEMALE BULKHEAD**

SEE MOUNTING HOLE SECTION ON PAGE 409



**Standard Flexible Cable Assemblies**

RG174A/U Coax, 50 Ohm						
Part No.	Cable Dia.	Attn. @ 1 GHz	Power @ 1 GHz			
Part No. <a href="#">PE3C4038</a>	0.11" dia.	32 dB/100ft	17 W			
1 piece price shown. See web or call for volume pricing.						
4"	6"	8"	12"	18"	24"	Custom Len.
\$62.68	\$62.74	\$62.82	\$62.99	\$63.21	\$63.44	See Web

30

RG178B/U Coax, 50 Ohm						
Part No.	Cable Dia.	Attn. @ 1 GHz	Power @ 1 GHz			
Part No. <a href="#">PE3C3991</a>	0.072" dia.	44.41 dB/100ft	55 W			
1 piece price shown. See web or call for volume pricing.						
4"	6"	8"	12"	18"	24"	Custom Len.
\$45.99	\$46.16	\$46.34	\$46.69	\$47.20	\$47.71	See Web

31

RG316/U Coax, 50 Ohm						
Part No.	Cable Dia.	Attn. @ 1 GHz	Power @ 1 GHz			
Part No. <a href="#">PE3C4021</a>	0.098" dia.	58 dB/100ft	160 W			
1 piece price shown. See web or call for volume pricing.						
4"	6"	8"	12"	18"	24"	Custom Len.
\$63.55	\$64.05	\$64.56	\$65.60	\$67.13	\$68.67	See Web

32

RG316-DS Coax, 50 Ohm						
Part No.	Cable Dia.	Attn. @ 1 GHz	Power @ 1 GHz			
Part No. <a href="#">PE3C4054</a>	0.114" dia.	9.15 dB/100ft	85 W			
1 piece price shown. See web or call for volume pricing.						
4"	6"	8"	12"	18"	24"	Custom Len.
\$64.17	\$64.68	\$65.19	\$66.23	\$67.77	\$69.34	See Web

33

**MMBX PLUG TO SSMB JACK BULKHEAD**

SEE MOUNTING HOLE SECTION ON PAGE 409



**Standard Flexible Cable Assemblies**

RG316/U Coax, 50 Ohm						
Part No.	Cable Dia.	Attn. @ 1 GHz	Power @ 1 GHz			
Part No. <a href="#">PE3W07532</a>	0.102" dia.	38 dB/100ft	160 W			
1 piece price shown. See web or call for volume pricing.						
12"	24"	36"	48"	60"	50CM	Custom Len.
\$76.04	\$79.63	\$83.24	\$86.85	\$90.47	\$78.34	See Web

34

**MMBX PLUG TO TNC FEMALE BULKHEAD**

SEE MOUNTING HOLE SECTION ON PAGE 409



**Standard Flexible Cable Assemblies**

RG174A/U Coax, 50 Ohm						
Part No.	Cable Dia.	Attn. @ 1 GHz	Power @ 1 GHz			
Part No. <a href="#">PE3C4042</a>	0.11" dia.	32 dB/100ft	17 W			
1 piece price shown. See web or call for volume pricing.						
4"	6"	8"	12"	18"	24"	Custom Len.
\$60.98	\$61.05	\$61.14	\$61.29	\$61.52	\$61.76	See Web

35

RG178B/U Coax, 50 Ohm						
Part No.	Cable Dia.	Attn. @ 1 GHz	Power @ 1 GHz			
Part No. <a href="#">PE3C3995</a>	0.072" dia.	44.41 dB/100ft	55 W			
1 piece price shown. See web or call for volume pricing.						
4"	6"	8"	12"	18"	24"	Custom Len.
\$62.00	\$58.67	\$58.85	\$62.74	\$59.71	\$60.23	See Web

36

RG316/U Coax, 50 Ohm						
Part No.	Cable Dia.	Attn. @ 1 GHz	Power @ 1 GHz			
Part No. <a href="#">PE3C4025</a>	0.098" dia.	38 dB/100ft	160 W			
1 piece price shown. See web or call for volume pricing.						
4"	6"	8"	12"	18"	24"	Custom Len.
\$61.86	\$62.36	\$62.87	\$70.30	\$65.44	\$66.99	See Web

37

RG316-DS Coax, 50 Ohm						
Part No.	Cable Dia.	Attn. @ 1 GHz	Power @ 1 GHz			
Part No. <a href="#">PE3C4058</a>	0.114" dia.	9.15 dB/100ft	85 W			
1 piece price shown. See web or call for volume pricing.						
4"	6"	8"	12"	18"	24"	Custom Len.
\$61.45	\$61.95	\$62.48	\$63.52	\$65.06	\$66.63	See Web

38

**MMBX PLUG RIGHT ANGLE TO MMBX PLUG RIGHT ANGLE**



**Standard Formable Cable Assemblies**

PE-SR405FLJ Coax, 50 Ohm						
Part No.	Cable Dia.	Attn. @ 1 GHz	Power @ 1 GHz			
Part No. <a href="#">PE3C4065</a>	0.098" dia.	19.5 dB/100ft	121.5 W			
1 piece price shown. See web or call for volume pricing.						
4"	6"	8"	12"	18"	24"	Custom Len.
\$65.25	\$66.63	\$68.00	\$70.77	\$74.90	\$79.04	See Web

39

**Standard Flexible Cable Assemblies**

RG174A/U Coax, 50 Ohm						
Part No.	Cable Dia.	Attn. @ 1 GHz	Power @ 1 GHz			
Part No. <a href="#">PE3C4033</a>	0.11" dia.	32 dB/100ft	17 W			
1 piece price shown. See web or call for volume pricing.						
4"	6"	8"	12"	18"	24"	Custom Len.
\$57.40	\$57.47	\$57.56	\$57.71	\$57.94	\$58.18	See Web

40

RG178B/U Coax, 50 Ohm						
Part No.	Cable Dia.	Attn. @ 1 GHz	Power @ 1 GHz			
Part No. <a href="#">PE3C3987</a>	0.072" dia.	44.41 dB/100ft	55 W			
1 piece price shown. See web or call for volume pricing.						
4"	6"	8"	12"	18"	24"	Custom Len.
\$57.59	\$57.74	\$57.93	\$58.27	\$58.79	\$59.30	See Web

41

**RG316/U Coax, 50 Ohm**

Part No.	Cable Dia.	Attn. @ 1 GHz	Power @ 1 GHz			
Part No. <a href="#">PE3C4016</a>	0.098" dia.	38 dB/100ft	160 W			
1 piece price shown. See web or call for volume pricing.						
4"	6"	8"	12"	18"	24"	Custom Len.
\$58.27	\$58.79	\$59.30	\$66.36	\$61.87	\$63.39	See Web

42

**RG316-DS Coax, 50 Ohm**

Part No.	Cable Dia.	Attn. @ 1 GHz	Power @ 1 GHz			
Part No. <a href="#">PE3C4050</a>	0.114" dia.	9.15 dB/100ft	85 W			
1 piece price shown. See web or call for volume pricing.						
4"	6"	8"	12"	18"	24"	Custom Len.
\$58.28	\$58.80	\$59.32	\$60.34	\$61.90	\$63.45	See Web

43

**MMBX PLUG RIGHT ANGLE TO N FEMALE BULKHEAD**

SEE MOUNTING HOLE SECTION ON PAGE 409



**Standard Flexible Cable Assemblies**

RG174A/U Coax, 50 Ohm						
Part No.	Cable Dia.	Attn. @ 1 GHz	Power @ 1 GHz			
Part No. <a href="#">PE3C4041</a>	0.11" dia.	32 dB/100ft	17 W			
1 piece price shown. See web or call for volume pricing.						
4"	6"	8"	12"	18"	24"	Custom Len.
\$68.70	\$68.77	\$68.84	\$69.01	\$69.23	\$69.47	See Web

44

RG178B/U Coax, 50 Ohm						
Part No.	Cable Dia.	Attn. @ 1 GHz	Power @ 1 GHz			
Part No. <a href="#">PE3C3994</a>	0.072" dia.	44.41 dB/100ft	55 W			
1 piece price shown. See web or call for volume pricing.						
4"	6"	8"	12"	18"	24"	Custom Len.
\$62.53	\$62.70	\$62.87	\$63.23	\$63.74	\$64.24	See Web

45

RG316/U Coax, 50 Ohm						
Part No.	Cable Dia.	Attn. @ 1 GHz	Power @ 1 GHz			
Part No. <a href="#">PE3C4024</a>	0.098" dia.	58 dB/100ft	160 W			
1 piece price shown. See web or call for volume pricing.						
4"	6"	8"	12"	18"	24"	Custom Len.
\$69.56	\$70.08	\$70.59	\$71.62	\$73.16	\$74.70	See Web

46

RG316-DS Coax, 50 Ohm						
Part No.	Cable Dia.	Attn. @ 1 GHz	Power @ 1 GHz			
Part No. <a href="#">PE3C4057</a>	0.114" dia.	9.15 dB/100ft	85 W			
1 piece price shown. See web or call for volume pricing.						
4"	6"	8"	12"	18"	24"	Custom Len.
\$70.35	\$70.84	\$71.37	\$72.41	\$73.95	\$75.52	See Web

47

**MMBX PLUG RIGHT ANGLE TO SMA MALE**



**Standard Formable Cable Assemblies**

PE-SR405FLJ Coax, 50 Ohm						
Part No.	Cable Dia.	Attn. @ 1 GHz	Power @ 1 GHz			
Part No. <a href="#">PE3C4069</a>	0.098" dia.	19.5 dB/100ft	121.5 W			
1 piece price shown. See web or call for volume pricing.						
4"	6"	8"	12"	18"	24"	Custom Len.
\$56.75	\$53.46	\$54.35	\$62.82	\$61.25	\$65.39	See Web

48

**Standard Flexible Cable Assemblies**

RG174A/U Coax, 50 Ohm						
Part No.	Cable Dia.	Attn. @ 1 GHz	Power @ 1 GHz			
Part No. <a href="#">PE3C4037</a>	0.11" dia.	32 dB/100ft	17 W			
1 piece price shown. See web or call for volume pricing.						
4"	6"	8"	12"	18"	24"	Custom Len.
\$50.81	\$50.88	\$50.96	\$54.18	\$51.35	\$51.58	See Web

49

RG178B/U Coax, 50 Ohm						
Part No.	Cable Dia.	Attn. @ 1 GHz	Power @ 1 GHz			
Part No. <a href="#">PE3C3990</a>	0.072" dia.	44.41 dB/100ft	55 W			
1 piece price shown. See web or call for volume pricing.						
4"	6"	8"	12"	18"	24"	Custom Len.
\$58.85	\$59.02	\$59.19	\$59.55	\$60.05	\$60.57	See Web

50

RG316/U Coax, 50 Ohm						
Part No.	Cable Dia.	Attn. @ 1 GHz	Power @ 1 GHz			
Part No. <a href="#">PE3C4020</a>	0.098" dia.	38 dB/100ft	160 W			
1 piece price shown. See web or call for volume pricing.						
4"	6"	8"	12"	18"	24"	Custom Len.
\$92.77	\$92.90	\$93.05	\$98.92	\$93.72	\$102.35	See Web

51

RG316-DS Coax, 50 Ohm						
Part No.	Cable Dia.	Attn. @ 1 GHz	Power @ 1 GHz			
Part No. <a href="#">PE3C4053</a>	0.114" dia.	30 dB/100ft	85 W			
1 piece price shown. See web or call for volume pricing.						
4"	6"	8"	12"	18"	24"	Custom Len.
\$46.44	\$46.96	\$47.49	\$53.38	\$54.60	\$51.66	See Web

52

**MMBX PLUG RIGHT ANGLE TO SMA MALE RIGHT ANGLE**



**Standard Flexible Cable Assemblies**

RG174A/U Coax, 50 Ohm						
Part No.	Cable Dia.	Attn. @ 1 GHz	Power @ 1 GHz			
Part No. <a href="#">PE3C4045</a>	0.11" dia.	32 dB/100ft	17 W			
1 piece price shown. See web or call for volume pricing.						
4"	6"	8"	12"	18"	24"	Custom Len.
\$61.31	\$61.38	\$61.46	\$61.61	\$61.85	\$62.07	See Web

53

RG178B/U Coax, 50 Ohm						
Part No.	Cable Dia.	Attn. @ 1 GHz	Power @ 1 GHz			
Part No. <a href="#">PE3C3998</a>	0.072" dia.	44.41 dB/100ft	55 W			
1 piece price shown. See web or call for volume pricing.						
4"	6"	8"	12"	18"	24"	Custom Len.
\$68.30	\$68.49	\$68.66	\$69.01	\$69.51	\$70.03	See Web

54

Cable Assemblies See Our Website For Current Pricing & Real-Time Stock Availability!

\*Coax Performance at 1 GHz Notes: Cable assembly max frequency may be lower than connector or coax max frequency

For our complete selection of cable assemblies, please visit our website

RG316/U Coax, 50 Ohm						
Part No. <a href="#">PE3C4028</a>	Cable Dia.		Attn. @ 1 GHz	Power @ 1 GHz		
1 piece price shown. See web or call for volume pricing.	0.098" dia.		38 dB/100ft	160 W		
4"	6"	8"	12"	18"	24"	Custom Len.
\$62.17	\$62.69	\$63.20	\$64.23	\$65.78	\$67.31	See Web

55

RG316-DS Coax, 50 Ohm						
Part No. <a href="#">PE3C4061</a>	Cable Dia.		Attn. @ 1 GHz	Power @ 1 GHz		
1 piece price shown. See web or call for volume pricing.	0.114" dia.		9.15 dB/100ft	85 W		
4"	6"	8"	12"	18"	24"	Custom Len.
\$60.61	\$61.13	\$61.64	\$62.69	\$64.23	\$65.80	See Web

56

**MMBX PLUG RIGHT ANGLE TO SMA FEMALE**



**Standard Flexible Cable Assemblies**

RG174A/U Coax, 50 Ohm						
Part No. <a href="#">PE3C4047</a>	Cable Dia.		Attn. @ 1 GHz	Power @ 1 GHz		
1 piece price shown. See web or call for volume pricing.	0.11" dia.		32 dB/100ft	17 W		
4"	6"	8"	12"	18"	24"	Custom Len.
\$60.46	\$60.55	\$60.63	\$60.78	\$61.00	\$61.25	See Web

57

RG178B/U Coax, 50 Ohm						
Part No. <a href="#">PE3W03154</a>	Cable Dia.		Attn. @ 1 GHz	Power @ 1 GHz		
1 piece price shown. See web or call for volume pricing.	0.072" dia.		44.41 dB/100ft	55 W		
4"	6"	8"	12"	18"	24"	Custom Len.
\$68.10	\$68.26	\$68.46	\$68.79	\$69.31	\$69.82	See Web

58

RG316/U Coax, 50 Ohm						
Part No. <a href="#">PE3C4030</a>	Cable Dia.		Attn. @ 1 GHz	Power @ 1 GHz		
1 piece price shown. See web or call for volume pricing.	0.098" dia.		38 dB/100ft	160 W		
4"	6"	8"	12"	18"	24"	Custom Len.
\$67.50	\$68.07	\$62.36	\$69.73	\$64.95	\$66.47	See Web

59

RG316-DS Coax, 50 Ohm						
Part No. <a href="#">PE3C4063</a>	Cable Dia.		Attn. @ 1 GHz	Power @ 1 GHz		
1 piece price shown. See web or call for volume pricing.	0.114" dia.		30 dB/100ft	85 W		
4"	6"	8"	12"	18"	24"	Custom Len.
\$66.73	\$61.12	\$61.63	\$68.94	\$64.22	\$65.79	See Web

60

**MMBX PLUG RIGHT ANGLE TO SMA FEMALE BULKHEAD**



SEE MOUNTING HOLE SECTION ON PAGE 409

**Standard Formable Cable Assemblies**

PE-SR405FLJ Coax, 50 Ohm						
Part No. <a href="#">PE3C4067</a>	Cable Dia.		Attn. @ 1 GHz	Power @ 1 GHz		
1 piece price shown. See web or call for volume pricing.	0.098" dia.		19.5 dB/100ft	121.5 W		
4"	6"	8"	12"	18"	24"	Custom Len.
\$59.90	\$55.84	\$57.21	\$65.97	\$64.11	\$68.25	See Web

61

**Standard Flexible Cable Assemblies**

RG174A/U Coax, 50 Ohm						
Part No. <a href="#">PE3C4035</a>	Cable Dia.		Attn. @ 1 GHz	Power @ 1 GHz		
1 piece price shown. See web or call for volume pricing.	0.11" dia.		32 dB/100ft	17 W		
4"	6"	8"	12"	18"	24"	Custom Len.
\$56.24	\$56.31	\$56.38	\$62.19	\$62.52	\$57.02	See Web

62

RG178B/U Coax, 50 Ohm						
Part No. <a href="#">PE3C4807</a>	Cable Dia.		Attn. @ 1 GHz	Power @ 1 GHz		
1 piece price shown. See web or call for volume pricing.	0.072" dia.		44.41 dB/100ft	55 W		
12"	24"	36"	48"	60"	50CM	Custom Len.
\$78.47	\$76.58	\$77.71	\$78.84	\$79.97	\$76.17	See Web

63

RG316/U Coax, 50 Ohm						
Part No. <a href="#">PE3C4018</a>	Cable Dia.		Attn. @ 1 GHz	Power @ 1 GHz		
1 piece price shown. See web or call for volume pricing.	0.098" dia.		38 dB/100ft	160 W		
4"	6"	8"	12"	18"	24"	Custom Len.
\$62.72	\$62.72	\$62.72	\$62.72	\$64.30	\$65.88	See Web

64

RG316-DS Coax, 50 Ohm						
Part No. <a href="#">PE3C4052</a>	Cable Dia.		Attn. @ 1 GHz	Power @ 1 GHz		
1 piece price shown. See web or call for volume pricing.	0.114" dia.		30 dB/100ft	85 W		
4"	6"	8"	12"	18"	24"	Custom Len.
\$63.80	\$64.30	\$64.83	\$65.86	\$67.41	\$68.96	See Web

65

**MMBX PLUG RIGHT ANGLE TO REVERSE POLARITY SMA FEMALE BULKHEAD**



SEE MOUNTING HOLE SECTION ON PAGE 409

**Standard Flexible Cable Assemblies**

RG174A/U Coax, 50 Ohm						
Part No. <a href="#">PE3C4039</a>	Cable Dia.		Attn. @ 1 GHz	Power @ 1 GHz		
1 piece price shown. See web or call for volume pricing.	0.11" dia.		32 dB/100ft	17 W		
4"	6"	8"	12"	18"	24"	Custom Len.
\$66.84	\$66.91	\$67.00	\$67.14	\$67.38	\$67.61	See Web

66

RG178B/U Coax, 50 Ohm						
Part No. <a href="#">PE3C3992</a>	Cable Dia.		Attn. @ 1 GHz	Power @ 1 GHz		
1 piece price shown. See web or call for volume pricing.	0.072" dia.		44.41 dB/100ft	55 W		
4"	6"	8"	12"	18"	24"	Custom Len.
\$54.71	\$50.36	\$50.54	\$55.46	\$51.41	\$51.93	See Web

67

RG316/U Coax, 50 Ohm						
Part No. <a href="#">PE3C4022</a>	Cable Dia.		Attn. @ 1 GHz	Power @ 1 GHz		
1 piece price shown. See web or call for volume pricing.	0.098" dia.		38 dB/100ft	160 W		
4"	6"	8"	12"	18"	24"	Custom Len.
\$67.70	\$68.22	\$68.74	\$69.77	\$71.30	\$72.84	See Web

68

RG316-DS Coax, 50 Ohm						
Part No. <a href="#">PE3C4055</a>	Cable Dia.		Attn. @ 1 GHz	Power @ 1 GHz		
1 piece price shown. See web or call for volume pricing.	0.114" dia.		30 dB/100ft	85 W		
4"	6"	8"	12"	18"	24"	Custom Len.
\$68.33	\$68.83	\$69.36	\$70.40	\$71.94	\$73.51	See Web

69

**MMBX PLUG RIGHT ANGLE TO TNC FEMALE BULKHEAD**



SEE MOUNTING HOLE SECTION ON PAGE 409

**Standard Flexible Cable Assemblies**

RG174A/U Coax, 50 Ohm						
Part No. <a href="#">PE3C4043</a>	Cable Dia.		Attn. @ 1 GHz	Power @ 1 GHz		
1 piece price shown. See web or call for volume pricing.	0.11" dia.		32 dB/100ft	17 W		
4"	6"	8"	12"	18"	24"	Custom Len.
\$65.14	\$65.23	\$65.30	\$72.00	\$72.32	\$65.92	See Web

70

RG178B/U Coax, 50 Ohm						
Part No. <a href="#">PE3C3996</a>	Cable Dia.		Attn. @ 1 GHz	Power @ 1 GHz		
1 piece price shown. See web or call for volume pricing.	0.072" dia.		44.41 dB/100ft	55 W		
4"	6"	8"	12"	18"	24"	Custom Len.
\$68.94	\$62.84	\$63.02	\$69.70	\$63.88	\$64.39	See Web

71

RG316/U Coax, 50 Ohm						
Part No. <a href="#">PE3C4026</a>	Cable Dia.		Attn. @ 1 GHz	Power @ 1 GHz		
1 piece price shown. See web or call for volume pricing.	0.098" dia.		38 dB/100ft	160 W		
4"	6"	8"	12"	18"	24"	Custom Len.
\$66.01	\$66.52	\$67.04	\$72.16	\$73.88	\$71.14	See Web

72

RG316-DS Coax, 50 Ohm						
Part No. <a href="#">PE3C4059</a>	Cable Dia.		Attn. @ 1 GHz	Power @ 1 GHz		
1 piece price shown. See web or call for volume pricing.	0.114" dia.		30 dB/100ft	85 W		
4"	6"	8"	12"	18"	24"	Custom Len.
\$65.61	\$66.13	\$66.66	\$74.45	\$76.17	\$70.79	See Web

73

**MMCX PLUG TO MMCX PLUG**



**Standard Flexible Cable Assemblies**

RG174A/U Coax, 50 Ohm						
Part No. <a href="#">PE34879</a>	Cable Dia.		Attn. @ 1 GHz	Power @ 1 GHz		
1 piece price shown. See web or call for volume pricing.	0.11" dia.		32 dB/100ft	16 W		
12"	24"	36"	48"	60"	72"	Custom Len.
\$64.18	\$59.90	\$65.44	\$60.86	\$61.34	\$61.82	See Web

74

RG178B/U Coax, 50 Ohm						
Part No. <a href="#">PE34598</a>	Cable Dia.		Attn. @ 1 GHz	Power @ 1 GHz		
1 piece price shown. See web or call for volume pricing.	0.072" dia.		44.4 dB/100ft	78 W		
12"	24"	36"	48"	60"	72"	Custom Len.
\$65.04	\$66.20	\$61.24	\$62.29	\$63.34	\$64.41	See Web

75

RG178B/U Coax, 50 Ohm						
Part No. <a href="#">PE34599</a>	Cable Dia.		Attn. @ 1 GHz	Power @ 1 GHz		
1 piece price shown. See web or call for volume pricing.	0.072" dia.		44.4 dB/100ft	78 W		
4"	-	-	-	-	-	Custom Len.
\$97.39	-	-	-	-	-	See Web

76

RG188A/U Coax, 50 Ohm						
Part No. <a href="#">PE34885</a>	Cable Dia.		Attn. @ 1 GHz	Power @ 1 GHz		
1 piece price shown. See web or call for volume pricing.	0.11" dia.		26 dB/100ft	160 W		
12"	24"	36"	48"	60"	72"	Custom Len.
\$55.87	\$58.24	\$60.55	\$62.90	\$65.23	\$67.61	See Web

77

RG196A/U Coax, 50 Ohm						
Part No. <a href="#">PE34891</a>	Cable Dia.		Attn. @ 1 GHz	Power @ 1 GHz		
1 piece price shown. See web or call for volume pricing.	0.08" dia.		49 dB/100ft	78 W		
12"	24"	36"	48"	60"	72"	Custom Len.
\$54.13	\$55.61	\$57.05	\$58.51	\$59.94	\$61.40	See Web

78

RG316/U Coax, 50 Ohm						
Part No. <a href="#">PE34240</a>	Cable Dia.		Attn. @ 1 GHz	Power @ 1 GHz		
1 piece price shown. See web or call for volume pricing.	0.102" dia.		38 dB/100ft	160 W		
12"	24"	36"	48"	60"	72"	Custom Len.
\$61.81	\$65.25	\$68.80	\$71.98	\$75.16	\$78.33	See Web

79

RG316-DS Coax, 50 Ohm						
Part No. <a href="#">PE38679</a>	Cable Dia.		Attn. @ 1 GHz	Power @ 1 GHz		
1 piece price shown. See web or call for volume pricing.	0.114" dia.		30 dB/100ft	160 W		
12"	24"	36"	48"	60"	-	Custom Len.
\$56.77	\$59.97	\$63.16	\$66.37	\$69.56	-	See Web

80

**MMCX PLUG TO MMCX PLUG RIGHT ANGLE**



**Low Loss Flexible Cable Assemblies**

PE-C100-LSZH Coax, 50 Ohm						
Part No. <a href="#">PE38231</a>	Cable Dia.		Attn. @ 1 GHz	Power @ 1 GHz		
1 piece price shown. See web or call for volume pricing.	0.109" dia.		25 dB/100ft	160 W		
12"	24"	36"	48"	60"	-	Custom Len.
\$53.87	\$54.70	\$56.01	\$57.35	\$58.67	-	See Web

81

Cable Assemblies

See Our Website For Current Pricing & Real-Time Stock Availability!

For Custom Lengths, Metric Lengths or Special Configurations, Please call (949) 261-1920

For our complete selection of cable assemblies, please visit our website

Cable Assemblies

See Our Website For Current Pricing & Real-Time Stock Availability!

Standard Formable Cable Assemblies							
PE-SR047FL Coax, 50 Ohm							
Part No.	PE38322				Cable Dia.	Attn. @ 1 GHz	Power @ 1 GHz
1 piece price shown. See web or call for volume pricing.							
12"	24"	36"	48"	60"	-	Custom Len.	
\$90.57	\$93.55	\$101.64	\$108.23	\$116.21	-	See Web	

Standard Flexible Cable Assemblies							
RG174A/U Coax, 50 Ohm							
Part No.	PE34881				Cable Dia.	Attn. @ 1 GHz	Power @ 1 GHz
1 piece price shown. See web or call for volume pricing.							
12"	24"	36"	48"	60"	72"	Custom Len.	
\$67.86	\$68.50	\$63.80	\$64.26	\$64.74	\$65.23	See Web	

Standard Flexible Cable Assemblies							
RG178B/U Coax, 50 Ohm							
Part No.	PE34883				Cable Dia.	Attn. @ 1 GHz	Power @ 1 GHz
1 piece price shown. See web or call for volume pricing.							
12"	24"	36"	48"	60"	72"	Custom Len.	
\$68.43	\$69.47	\$70.53	\$71.59	\$72.63	\$73.69	See Web	

Standard Flexible Cable Assemblies							
RG188A/U Coax, 50 Ohm							
Part No.	PE34889				Cable Dia.	Attn. @ 1 GHz	Power @ 1 GHz
1 piece price shown. See web or call for volume pricing.							
12"	24"	36"	48"	60"	72"	Custom Len.	
\$64.86	\$74.09	\$69.75	\$72.18	\$74.63	\$77.06	See Web	

Standard Flexible Cable Assemblies							
RG196A/U Coax, 50 Ohm							
Part No.	PE34893				Cable Dia.	Attn. @ 1 GHz	Power @ 1 GHz
1 piece price shown. See web or call for volume pricing.							
12"	24"	36"	48"	60"	72"	Custom Len.	
\$62.59	\$64.03	\$65.51	\$66.95	\$68.39	\$69.85	See Web	

Standard Flexible Cable Assemblies							
RG316/U Coax, 50 Ohm							
Part No.	PE34895				Cable Dia.	Attn. @ 1 GHz	Power @ 1 GHz
1 piece price shown. See web or call for volume pricing.							
12"	24"	36"	48"	60"	72"	Custom Len.	
\$72.45	\$75.89	\$72.22	\$75.39	\$78.57	\$81.74	See Web	

MMCX PLUG TO N FEMALE BULKHEAD						
SEE MOUNTING HOLE SECTION ON PAGE 409						

Formable Cable Assemblies							
PE-SR047FL Coax, 50 Ohm							
Part No.	PE3W07591				Cable Dia.	Attn. @ 1 GHz	Power @ 1 GHz
1 piece price shown. See web or call for volume pricing.							
12"	24"	36"	48"	60"	50CM	Custom Len.	
\$96.19	\$105.73	\$113.65	\$123.07	\$132.47	\$102.30	See Web	

MMCX PLUG TO SMC PLUG						
SEE MOUNTING HOLE SECTION ON PAGE 409						

Standard Flexible Cable Assemblies							
RG178B/U Coax, 50 Ohm							
Part No.	PE3W07653				Cable Dia.	Attn. @ 1 GHz	Power @ 1 GHz
1 piece price shown. See web or call for volume pricing.							
12"	24"	36"	48"	60"	50CM	Custom Len.	
\$53.85	\$54.59	\$55.84	\$57.08	\$58.32	\$54.15	See Web	

MMCX PLUG RIGHT ANGLE TO BNC FEMALE BULKHEAD						
SEE MOUNTING HOLE SECTION ON PAGE 409						

Standard Flexible Cable Assemblies							
RG174A/U Coax, 50 Ohm							
Part No.	PE36738				Cable Dia.	Attn. @ 1 GHz	Power @ 1 GHz
1 piece price shown. See web or call for volume pricing.							
12"	24"	36"	48"	60"	-	Custom Len.	
\$63.89	\$64.51	\$65.15	\$61.72	\$66.47	-	See Web	

MMCX PLUG RIGHT ANGLE TO MMCX PLUG						
SEE MOUNTING HOLE SECTION ON PAGE 409						

Standard Formable Cable Assemblies							
PE-SR405FLJ Coax, 50 Ohm							
Part No.	PE3W05483				Cable Dia.	Attn. @ 1 GHz	Power @ 1 GHz
1 piece price shown. See web or call for volume pricing.							
12"	24"	36"	48"	60"	50CM	Custom Len.	
\$58.10	\$80.67	\$90.52	\$100.37	\$108.68	\$77.14	See Web	

MMCX PLUG RIGHT ANGLE TO SMA MALE RIGHT ANGLE						
SEE MOUNTING HOLE SECTION ON PAGE 409						

Standard Flexible Cable Assemblies							
RG316/U Coax, 50 Ohm							
Part No.	PE3W07894				Cable Dia.	Attn. @ 1 GHz	Power @ 1 GHz
1 piece price shown. See web or call for volume pricing.							
12"	18"	24"	36"	48"	60"	Custom Len.	
\$80.19	\$78.93	\$80.67	\$84.14	\$87.61	\$91.09	See Web	

MMCX PLUG RIGHT ANGLE TO SMA FEMALE						
SEE MOUNTING HOLE SECTION ON PAGE 409						

Standard Flexible Cable Assemblies							
RG188-DS Coax, 50 Ohm							
Part No.	PE3W07068				Cable Dia.	Attn. @ 1 GHz	Power @ 1 GHz
1 piece price shown. See web or call for volume pricing.							
12"	24"	36"	48"	60"	50CM	Custom Len.	
\$65.65	Call	Call	Call	Call	Call	See Web	

Flexible Cable Assemblies							
PE-C500 Coax, 50 Ohm							
Part No.	PE35522				Cable Dia.	Attn. @ 1 GHz	Power @ 1 GHz
1 piece price shown. See web or call for volume pricing.							
12"	24"	36"	48"	60"	-	Custom Len.	
\$98.75	\$103.16	\$107.59	\$110.46	\$114.80	-	See Web	

Flexible Cable Assemblies							
LMR-195 Coax, 50 Ohm							
Part No.	PE3C0118				Cable Dia.	Attn. @ 1 GHz	Power @ 1 GHz
1 piece price shown. See web or call for volume pricing.							
12"	24"	36"	48"	60"	-	Custom Len.	
\$52.58	\$53.40	\$51.26	\$54.61	\$55.44	-	See Web	

Corrugated Cable Assemblies							
PE-1/4SFHC Coax, 50 Ohm							
Part No.	PE3C0124				Cable Dia.	Attn. @ 1 GHz	Power @ 1 GHz
1 piece price shown. See web or call for volume pricing.							
12"	24"	36"	48"	60"	-	Custom Len.	
\$159.39	\$146.94	\$150.32	\$153.90	\$157.34	-	See Web	

Corrugated Cable Assemblies							
SPP-250-LLPL Coax, 50 Ohm							
Part No.	PE3C4137				Cable Dia.	Attn. @ 1 GHz	Power @ 1 GHz
1 piece price shown. See web or call for volume pricing.							
12"	24"	36"	48"	60"	50CM	Custom Len.	
\$96.43	\$102.56	\$107.19	\$113.24	\$119.30	\$100.37	See Web	

Low Loss Flexible Cable Assemblies							
PE-C195 Coax, 50 Ohm							
Part No.	PE37940				Cable Dia.	Attn. @ 1 GHz	Power @ 1 GHz
1 piece price shown. See web or call for volume pricing.							
36"	48"	60"	72"	120"	-	Custom Len.	
\$35.82	\$36.74	\$37.63	\$38.50	\$42.05	-	See Web	

Low Loss Flexible Cable Assemblies							
PE-C200 Coax, 50 Ohm							
Part No.	PE34693				Cable Dia.	Attn. @ 1 GHz	Power @ 1 GHz
1 piece price shown. See web or call for volume pricing.							
12"	24"	36"	48"	60"	-	Custom Len.	
\$50.67	\$52.44	\$56.58	\$61.20	\$65.82	-	See Web	

Low Loss Flexible Cable Assemblies							
PE-C240 Coax, 50 Ohm							
Part No.	PE37941				Cable Dia.	Attn. @ 1 GHz	Power @ 1 GHz
1 piece price shown. See web or call for volume pricing.							
36"	48"	60"	72"	120"	-	Custom Len.	
\$54.53	\$55.86	\$54.13	\$58.39	\$68.33	-	See Web	

Low Loss Flexible Cable Assemblies							
PE-C300 Coax, 50 Ohm							
Part No.	PE36634				Cable Dia.	Attn. @ 1 GHz	Power @ 1 GHz
1 piece price shown. See web or call for volume pricing.							
12"	24"	36"	48"	60"	-	Custom Len.	
\$75.29	\$74.15	\$82.50	\$80.37	\$83.49	-	See Web	

Low Loss Flexible Cable Assemblies							
PE-C400 Coax, 50 Ohm							
Part No.	PE34666				Cable Dia.	Attn. @ 1 GHz	Power @ 1 GHz
1 piece price shown. See web or call for volume pricing.							
12"	24"	36"	48"	60"	-	Custom Len.	
\$64.48	\$68.70	\$70.33	\$72.06	\$75.79	-	See Web	

Low Loss Flexible Cable Assemblies							
PE-C600 Coax, 50 Ohm							
Part No.	PE37943				Cable Dia.	Attn. @ 1 GHz	Power @ 1 GHz
1 piece price shown. See web or call for volume pricing.							
36"	48"	60"	72"	120"	100CM	Custom Len.	
\$113.37	\$116.06	\$118.74	\$121.43	\$140.57	\$120.88	See Web	

Low Loss Flexible Cable Assemblies							
LMR-240 Coax, 50 Ohm							
Part No.	PE3C0039				Cable Dia.	Attn. @ 1 GHz	Power @ 1 GHz
1 piece price shown. See web or call for volume pricing.							
12"	24"	36"	48"	60"	-	Custom Len.	
\$45.81	\$46.89	\$47.95	\$49.10	\$50.21	-	See Web	

Low Loss Flexible Cable Assemblies							
LMR-240 Coax, 50 Ohm							
Part No.	PE3C0053				Cable Dia.	Attn. @ 1 GHz	Power @ 1 GHz
1 piece price shown. See web or call for volume pricing.							
12"	24"	36"	48"	60"	-	Custom Len.	
\$59.85	\$60.79	\$61.73	\$62.66	\$63.60	-	See Web	

\*Coax Performance at 1 GHz Notes: Cable assembly max frequency may be lower than connector or coax max frequency



For our complete selection of cable assemblies, please visit our website

Part No.	Cable Dia.	Attn. @ 1 GHz	Power @ 1 GHz
<b>Part No. PE3C0101</b>			
1 piece price shown. See web or call for volume pricing.	0.24" dia.	8 dB/100ft	
12" 24" 36" 48"	60"	-	Custom Len.
\$50.73 \$51.81 \$52.89 \$54.04	\$54.62	-	See Web
<b>LMR-400 Coax, 50 Ohm</b>			
<b>Part No. PE3C0033</b>			
1 piece price shown. See web or call for volume pricing.	0.405" dia.	4.25 dB/100ft	
12" 24" 36" 48"	60"	-	Custom Len.
\$53.75 \$54.77 \$56.29 \$57.90	\$59.45	-	See Web
<b>Part No. PE3C0046</b>			
1 piece price shown. See web or call for volume pricing.	0.405" dia.	4.25 dB/100ft	
12" 24" 36" 48"	60"	-	Custom Len.
\$54.61 \$56.13 \$57.66 \$59.24	\$60.81	-	See Web
<b>Part No. PE3C0105</b>			
1 piece price shown. See web or call for volume pricing.	0.405" dia.	4.25 dB/100ft	
12" 24" 36" 48"	60"	-	Custom Len.
\$88.69 \$90.20 \$91.72 \$93.33	\$94.87	-	See Web
<b>LMR-600 Coax, 50 Ohm</b>			
<b>Part No. PE3C0048</b>			
1 piece price shown. See web or call for volume pricing.	0.59" dia.	2.62 dB/100ft	
12" 24" 36" 48"	60"	-	Custom Len.
\$154.63 \$157.71 \$152.02 \$164.05	\$158.17	-	See Web
<b>Part No. PE3C0062</b>			
1 piece price shown. See web or call for volume pricing.	0.59" dia.	2.62 dB/100ft	
12" 24" 36" 48"	60"	-	Custom Len.
\$150.64 \$153.72 \$156.79 \$160.04	\$163.17	-	See Web
<b>Part No. PE3C0110</b>			
1 piece price shown. See web or call for volume pricing.	0.59" dia.	2.62 dB/100ft	
12" 24" 36" 48"	60"	-	Custom Len.
\$122.85 \$125.93 \$122.05 \$125.11	\$135.39	-	See Web
<b>Part No. PE3C0112</b>			
1 piece price shown. See web or call for volume pricing.	0.59" dia.	2.62 dB/100ft	
12" 24" 36" 48"	60"	-	Custom Len.
\$86.05 \$84.29 \$87.41 \$90.52	\$93.64	-	See Web
<b>LMR-195 Coax, 50 Ohm</b>			
<b>Part No. PE3C0060</b>			
1 piece price shown. See web or call for volume pricing.	0.195" dia.	11.8 dB/100ft	
12" 24" 36" 48"	60"	-	Custom Len.
\$48.64 \$49.47 \$47.55 \$48.38	\$52.03	-	See Web
<b>Part No. PE3C0061</b>			
1 piece price shown. See web or call for volume pricing.	0.195" dia.	11.8 dB/100ft	
12" 24" 36" 48"	60"	-	Custom Len.
\$47.26 \$48.08 \$48.91 \$47.07	\$50.65	-	See Web
<b>PE-P142LL Coax, 50 Ohm</b>			
<b>Part No. PE343</b>			
1 piece price shown. See web or call for volume pricing.	0.195" dia.	7.2 dB/100ft	
12" 24" 36" 48"	60"	50CM	Custom Len.
\$130.34 \$147.93 \$165.54 \$183.15	\$200.75	\$141.62	See Web
<b>Part No. PE3C0231</b>			
1 piece price shown. See web or call for volume pricing.	0.32" dia.	7.2 dB/100ft	
24" 36" 48" 60"	72" 120"		Custom Len.
\$360.33 \$443.81 \$456.25 \$491.23	\$512.12	\$779.19	See Web
<b>PE-SF20LL Coax, 50 Ohm</b>			
<b>Part No. PE3TC1102</b>			
1 piece price shown. See web or call for volume pricing.	0.185" dia.		
24" 36" 48" 72"	100CM 200CM		Custom Len.
\$85.32 \$97.70 \$108.56 \$124.84	\$101.17	\$139.83	See Web
<b>PE-P160LL Coax, 50 Ohm</b>			
<b>Part No. PE3C5255</b>			
1 piece price shown. See web or call for volume pricing.	0.16" dia.		
12" 24" 36" 48"	60"	50CM	Custom Len.
\$222.74 \$245.21 \$267.66 \$290.11	\$312.56	\$237.13	See Web
<b>LMR-600-UF Coax, 50 Ohm</b>			
<b>Part No. PE3C7615</b>			
1 piece price shown. See web or call for volume pricing.	0.59" dia.		
12" 24" 36" 48"	60"	50CM	Custom Len.
\$73.81 \$77.64 \$81.46 \$85.28	\$89.10	\$72.43	See Web
<b>PE-P142LL-27478 Coax, 50 Ohm</b>			
<b>Part No. PE3M0174</b>			
1 piece price shown. See web or call for volume pricing.	0.195" dia.		
12" 18" 24" 36"	48" 60"		Custom Len.
\$401.21 \$410.40 \$419.59 \$437.98	\$456.36	\$474.75	See Web
<b>PE-P160LL-27478 Coax, 50 Ohm</b>			
<b>Part No. PE3M0219</b>			
1 piece price shown. See web or call for volume pricing.	0.16" dia.		
8" 12" 18" 24"	30" 36"		Custom Len.
\$369.32 \$374.62 \$382.61 \$390.56	\$398.54	\$406.49	See Web
<b>PE-P300LL-27478 Coax, 50 Ohm</b>			
<b>Part No. PE3M0247</b>			
1 piece price shown. See web or call for volume pricing.	0.3" dia.		
12" 18" 24" 36"	48" 60"		Custom Len.
\$453.26 \$468.59 \$483.94 \$514.63	\$545.32	\$576.00	See Web

Precision Formable Cable Assemblies				
<b>PE-SR402FLJ Coax, 50 Ohm</b>				
<b>Part No. PE39465</b>				
1 piece price shown. See web or call for volume pricing.	Cable Dia.	Attn. @ 1 GHz	Power @ 1 GHz	
6" 9" 12" 18" 24"	0.161" dia.	11.89 dB/100ft	450 W	Custom Len.
\$58.24 \$60.68 \$62.40 \$62.40	\$72.03	-	-	See Web
<b>PE-SR405FLJ Coax, 50 Ohm</b>				
<b>Part No. PE39457</b>				
1 piece price shown. See web or call for volume pricing.	Cable Dia.	Attn. @ 1 GHz	Power @ 1 GHz	
6" 9" 12" 18" 24"	0.098" dia.	19.5 dB/100ft	130 W	Custom Len.
\$49.60 Call \$40.60 Call	Call	-	-	See Web
<b>PE-80TEST Coax, 50 Ohm</b>				
<b>Part No. PE3TC0103</b>				
1 piece price shown. See web or call for volume pricing.	Cable Dia.	Attn. @ 1 GHz	Power @ 1 GHz	
24" 48" 72" 200CM	0.195" dia.	-	400CM	Custom Len.
\$369.28 \$462.24 \$555.20	Call	-	Call	See Web
<b>PE-90TEST Coax, 50 Ohm</b>				
<b>Part No. PE3TC0302</b>				
1 piece price shown. See web or call for volume pricing.	Cable Dia.	Attn. @ 1 GHz	Power @ 1 GHz	
24" 48" 72" 144" 180"	0.151" dia.	-	300"	Custom Len.
\$301.67 \$386.18 \$470.70	Call	Call	Call	See Web
<b>Low PIM Formable Cable Assemblies</b>				
<b>PE-SR401FLJ Low PIM Coax, 50 Ohm</b>				
<b>Part No. PE3C2011</b>				
1 piece price shown. See web or call for volume pricing.	Cable Dia.	Attn. @ 1 GHz	Power @ 1 GHz	
100CM 200CM	0.276" dia.	-	-	Custom Len.
\$119.19 \$153.65	-	-	-	See Web
<b>PE-SR402FLJ Low PIM Coax, 50 Ohm</b>				
<b>Part No. PE3C2000</b>				
1 piece price shown. See web or call for volume pricing.	Cable Dia.	Attn. @ 1 GHz	Power @ 1 GHz	
76CM 100CM 150CM 200CM	0.161" dia.	-	-	Custom Len.
Call \$87.88	Call \$100.95	-	-	See Web
<b>Low PIM Corrugated Cable Assemblies</b>				
<b>PE-1/4SFHC Coax, 50 Ohm</b>				
<b>Part No. PE3C7842</b>				
1 piece price shown. See web or call for volume pricing.	Cable Dia.	Attn. @ 1 GHz	Power @ 1 GHz	
12" 24" 36" 48" 60"	0.303" dia.	5.85 dB/100ft	50CM	Custom Len.
\$59.21 \$62.95 \$66.67 \$70.40	\$74.13	\$61.60	See Web	
<b>SPP-250-LLPL Coax, 50 Ohm</b>				
<b>Part No. PE3C6202</b>				
1 piece price shown. See web or call for volume pricing.	Cable Dia.	Attn. @ 1 GHz	Power @ 1 GHz	
12" 24" 36" 48" 60"	0.28" dia.	5.5 dB/100ft	650 W	Custom Len.
\$57.61 \$63.75 \$69.88 \$76.00	\$82.14	\$61.52	See Web	
<b>SPO-250 Coax, 50 Ohm</b>				
<b>Part No. PE3C6345</b>				
1 piece price shown. See web or call for volume pricing.	Cable Dia.	Attn. @ 1 GHz	Power @ 1 GHz	
12" 24" 36" 48" 60"	0.303" dia.	50CM	Custom Len.	
\$48.96 \$51.26 \$53.56 \$55.35	\$57.64	\$50.43	See Web	
<b>SPF-250 Coax, 50 Ohm</b>				
<b>Part No. PE3C6360</b>				
1 piece price shown. See web or call for volume pricing.	Cable Dia.	Attn. @ 1 GHz	Power @ 1 GHz	
12" 24" 36" 48" 60"	0.303" dia.	50CM	Custom Len.	
\$49.69 \$52.73 \$55.27 \$58.28	\$61.29	\$51.64	See Web	
<b>SPP-500-LLPL Coax, 50 Ohm</b>				
<b>Part No. PE3C6370</b>				
1 piece price shown. See web or call for volume pricing.	Cable Dia.	Attn. @ 1 GHz	Power @ 1 GHz	
12" 24" 36" 48" 60"	0.5" dia.	50CM	Custom Len.	
\$52.15 \$61.95 \$72.25 \$82.53	\$92.80	\$58.26	See Web	
<b>SPO-500 Coax, 50 Ohm</b>				
<b>Part No. PE3C6371</b>				
1 piece price shown. See web or call for volume pricing.	Cable Dia.	Attn. @ 1 GHz	Power @ 1 GHz	
12" 24" 36" 48" 60"	0.53" dia.	50CM	Custom Len.	
\$39.59 \$42.70 \$45.82 \$48.92	\$52.04	\$41.59	See Web	
<b>SPF-500 Coax, 50 Ohm</b>				
<b>Part No. PE3C6374</b>				
1 piece price shown. See web or call for volume pricing.	Cable Dia.	Attn. @ 1 GHz	Power @ 1 GHz	
12" 24" 36" 48" 60"	0.545" dia.	50CM	Custom Len.	
\$40.90 \$44.02 \$47.13 \$50.24	\$53.35	\$42.90	See Web	
<b>SPP-375-LLPL Coax, 50 Ohm</b>				
<b>Part No. PE3C6385</b>				
1 piece price shown. See web or call for volume pricing.	Cable Dia.	Attn. @ 1 GHz	Power @ 1 GHz	
12" 24" 36" 48" 60"	0.402" dia.	50CM	Custom Len.	
\$62.53 \$70.52 \$78.51	\$86.50	\$94.50	\$67.65	See Web
<b>Low Loss Test Flexible Cable Assemblies</b>				
<b>PE-P300LL Coax, 50 Ohm</b>				
<b>Part No. PE330</b>				
1 piece price shown. See web or call for volume pricing.	Cable Dia.	Attn. @ 1 GHz	Power @ 1 GHz	
12" 24" 36" 48" 60"	0.3" dia.	4.6 dB/100ft	50CM	Custom Len.
\$292.87 \$320.99 \$349.12	\$377.23	\$405.34	\$310.89	See Web

Cable Assemblies

See Our Website For Current Pricing & Real-Time Stock Availability!

For Custom Lengths, Metric Lengths or Special Configurations, Please call (949) 261-1920



Technical Support  
+1 (949) 261-1920



Same-Day Shipping,  
Even Custom Cable Assemblies



# For our complete selection of cable assemblies, please visit our website

Cable Assemblies

See Our Website For Current Pricing & Real-Time Stock Availability!

Standard Formable Cable Assemblies						
<b>PE-SR047FL Coax, 50 Ohm</b>						
Part No. <b>PE34146</b>	Cable Dia.	Attn. @ 1 GHz	Power @ 1 GHz			
1 piece price shown. See web or call for volume pricing.	0.047" dia.	36 dB/100ft	32 W			
6" 12" 18" 24"	36"	48"	Custom Len.			
\$98.80 \$102.78 \$106.67 \$109.09	\$116.81	\$124.57	See Web			
<b>PE-SR401FL Coax, 50 Ohm</b>						
Part No. <b>PE34149</b>	Cable Dia.	Attn. @ 1 GHz	Power @ 1 GHz			
1 piece price shown. See web or call for volume pricing.	7.6 dB/100ft	1,400 W				
6" 12" 18" 24"	36"	48"	Custom Len.			
\$144.12 \$152.77 \$152.48 \$170.46	\$188.17	\$206.90	See Web			
<b>PE-SR402FL Coax, 50 Ohm</b>						
Part No. <b>PE3472</b>	Cable Dia.	Attn. @ 1 GHz	Power @ 1 GHz			
1 piece price shown. See web or call for volume pricing.	11.88 dB/100ft	450 W				
6" 12" 18" 24"	36"	48"	Custom Len.			
\$91.68 \$96.00 \$100.42 \$104.86	\$107.13	\$113.81	See Web			
<b>PE-SR405FL Coax, 50 Ohm</b>						
Part No. <b>PE39443</b>	Cable Dia.	Attn. @ 1 GHz	Power @ 1 GHz			
1 piece price shown. See web or call for volume pricing.	22.5 dB/100ft	105 W				
6" 9" 12" 18"	24"	-	Custom Len.			
\$61.82 Call Call Call \$78.09	\$70.35	-	See Web			
<b>PE-SR451FL Coax, 50 Ohm</b>						
Part No. <b>PE39451</b>	Cable Dia.	Attn. @ 1 GHz	Power @ 1 GHz			
1 piece price shown. See web or call for volume pricing.	12 dB/100ft	400 W				
6" 9" 12" 18"	24"	-	Custom Len.			
\$68.84 Call \$58.47 \$62.61 \$66.76	-	-	See Web			
<b>PE-SR455FL Coax, 50 Ohm</b>						
Part No. <b>PE39443</b>	Cable Dia.	Attn. @ 1 GHz	Power @ 1 GHz			
1 piece price shown. See web or call for volume pricing.	22.5 dB/100ft	105 W				
6" 9" 12" 18"	24"	-	Custom Len.			
\$61.82 Call Call Call \$78.09	\$70.35	-	See Web			
<b>PE-SR456FL Coax, 50 Ohm</b>						
Part No. <b>PE3963</b>	Cable Dia.	Attn. @ 1 GHz	Power @ 1 GHz			
1 piece price shown. See web or call for volume pricing.	22.5 dB/100ft	130 W				
6" 12" 18" 24"	36"	48"	Custom Len.			
\$121.22 \$121.22 \$127.02 \$132.82	\$144.41	\$156.00	See Web			
Standard Flexible Cable Assemblies						
<b>RG8A/U Coax, 50 Ohm</b>						
Part No. <b>PE3570</b>	Cable Dia.	Attn. @ 1 GHz	Power @ 1 GHz			
1 piece price shown. See web or call for volume pricing.	0.405" dia.	8 dB/100ft	190 W			
12" 24" 36" 48"	60"	72"	Custom Len.			
\$67.88 \$75.32 \$78.70 \$82.28	\$85.72	\$89.15	See Web			
<b>RG8X Coax, 50 Ohm</b>						
Part No. <b>PE33720</b>	Cable Dia.	Attn. @ 1 GHz	Power @ 1 GHz			
1 piece price shown. See web or call for volume pricing.	0.242" dia.	13.5 dB/100ft	60 W			
12" 24" 36" 48"	60"	-	Custom Len.			
\$80.28 \$79.09 \$82.43 \$92.15	\$89.16	-	See Web			
<b>RG58C/U Coax, 50 Ohm</b>						
Part No. <b>PE3441</b>	Cable Dia.	Attn. @ 1 GHz	Power @ 1 GHz			
1 piece price shown. See web or call for volume pricing.	0.195" dia.	20 dB/100ft	44 W			
12" 24" 36" 48"	60"	72"	Custom Len.			
\$52.73 \$53.62 \$54.03 \$54.98	\$55.89	\$56.80	See Web			
<b>RG141A/U Coax, 50 Ohm</b>						
Part No. <b>PE36589</b>	Cable Dia.	Attn. @ 1 GHz	Power @ 1 GHz			
1 piece price shown. See web or call for volume pricing.	0.19" dia.	13 dB/100ft	650 W			
12" 24" 36" 48"	60"	-	Custom Len.			
\$66.99 \$78.59 \$86.18 \$94.22	\$101.95	-	See Web			
<b>RG142B/U Coax, 50 Ohm</b>						
Part No. <b>PE3455</b>	Cable Dia.	Attn. @ 1 GHz	Power @ 1 GHz			
1 piece price shown. See web or call for volume pricing.	0.195" dia.	13 dB/100ft	650 W			
6" 12" 18" 24"	30"	36"	Custom Len.			
\$52.50 \$55.26 \$58.58 \$61.93	\$63.09	\$68.62	See Web			
<b>RG174A/U Coax, 50 Ohm</b>						
Part No. <b>PE36273</b>	Cable Dia.	Attn. @ 1 GHz	Power @ 1 GHz			
1 piece price shown. See web or call for volume pricing.	0.1" dia.	32 dB/100ft	16 W			
12" 24" 36" 48"	60"	-	Custom Len.			
\$55.92 \$61.01 \$56.88 \$62.34	\$62.98	-	See Web			
<b>RG178B/U Coax, 50 Ohm</b>						
Part No. <b>PE33527</b>	Cable Dia.	Attn. @ 1 GHz	Power @ 1 GHz			
1 piece price shown. See web or call for volume pricing.	0.072" dia.	44.4 dB/100ft	78 W			
12" 24" 36" 48"	60"	72"	Custom Len.			
\$84.18 \$85.35 \$81.53 \$82.58	\$83.64	\$84.68	See Web			
<b>RG188A/U Coax, 50 Ohm</b>						
Part No. <b>PE33525</b>	Cable Dia.	Attn. @ 1 GHz	Power @ 1 GHz			
1 piece price shown. See web or call for volume pricing.	0.11" dia.	26 dB/100ft	160 W			
12" 24" 36" 48"	60"	72"	Custom Len.			
\$62.17 \$64.61 \$67.05 \$69.49	\$71.93	\$74.37	See Web			
<b>RG213/U Coax, 50 Ohm</b>						
Part No. <b>PE3496</b>	Cable Dia.	Attn. @ 1 GHz	Power @ 1 GHz			
1 piece price shown. See web or call for volume pricing.	0.405" dia.	8 dB/100ft	190 W			
12" 24" 36" 48"	60"	72"	Custom Len.			
\$69.37 \$71.34 \$73.29 \$75.38	\$77.38	\$79.37	See Web			
<b>RG214/U Coax, 50 Ohm</b>						
Part No. <b>PE3062</b>	Cable Dia.	Attn. @ 1 GHz	Power @ 1 GHz			
1 piece price shown. See web or call for volume pricing.	0.425" dia.	7.32 dB/100ft	170 W			
12" 24" 36" 48"	60"	72"	Custom Len.			
\$72.32 \$80.88 \$89.43 \$98.48	\$107.21	\$114.31	See Web			

<b>RG217/U Coax, 50 Ohm</b>						
Part No. <b>PE3997</b>	Cable Dia.	Attn. @ 1 GHz	Power @ 1 GHz			
1 piece price shown. See web or call for volume pricing.	0.545" dia.	5.8 dB/100ft	260 W			
12" 24" 36" 48"	60"	72"	Custom Len.			
\$107.34 \$112.45 \$117.57 \$122.98	\$128.98	\$128.19	\$125.23			
<b>RG218/U Coax, 50 Ohm</b>						
Part No. <b>PE33236</b>	Cable Dia.	Attn. @ 1 GHz	Power @ 1 GHz			
1 piece price shown. See web or call for volume pricing.	0.87" dia.	5 dB/100ft	600 W			
12" 24" 36" 48"	60"	72"	Custom Len.			
\$251.92 \$280.25 \$276.84 \$307.45	\$301.78	\$334.40	See Web			
<b>RG223/U Coax, 50 Ohm</b>						
Part No. <b>PE3447</b>	Cable Dia.	Attn. @ 1 GHz	Power @ 1 GHz			
1 piece price shown. See web or call for volume pricing.	0.21" dia.	13.4 dB/100ft	53 W			
6" 12" 18" 24"	30"	36"	Custom Len.			
\$51.08 \$53.13 \$54.35 \$56.06	\$55.40	\$59.49	See Web			
<b>RG225/U Coax, 50 Ohm</b>						
Part No. <b>PE3W00417</b>	Cable Dia.	Attn. @ 1 GHz	Power @ 1 GHz			
1 piece price shown. See web or call for volume pricing.	0.209" dia.	13.41 dB/100ft	50 W			
12" 24" 36" 48"	60"	50CM	Custom Len.			
\$52.55 \$66.47 \$70.03 \$73.60	\$77.16	\$65.17	See Web			
<b>RG316/U Coax, 50 Ohm</b>						
Part No. <b>PE33269</b>	Cable Dia.	Attn. @ 1 GHz	Power @ 1 GHz			
1 piece price shown. See web or call for volume pricing.	0.43" dia.	-	1,700 W			
12" 24" 36" 48"	60"	-	Custom Len.			
\$96.43 \$131.51 \$178.04 \$204.38	\$240.80	-	See Web			
<b>RG316-DS Coax, 50 Ohm</b>						
Part No. <b>PE3487</b>	Cable Dia.	Attn. @ 1 GHz	Power @ 1 GHz			
1 piece price shown. See web or call for volume pricing.	0.098" dia.	38 dB/100ft	160 W			
12" 24" 36" 48"	60"	72"	Custom Len.			
\$68.24 \$71.68 \$69.54 \$72.72	\$82.26	\$79.07	See Web			
<b>RG316-DS Coax, 50 Ohm</b>						
Part No. <b>PE33288</b>	Cable Dia.	Attn. @ 1 GHz	Power @ 1 GHz			
1 piece price shown. See web or call for volume pricing.	0.114" dia.	30 dB/100ft	160 W			
12" 24" 36" 48"	60"	-	Custom Len.			
\$58.54 \$61.74 \$64.95 \$68.14	\$71.34	-	See Web			
<b>RG393/U Coax, 50 Ohm</b>						
Part No. <b>PE3607</b>	Cable Dia.	Attn. @ 1 GHz	Power @ 1 GHz			
1 piece price shown. See web or call for volume pricing.	0.39" dia.	7.5 dB/100ft	1,700 W			
12" 24" 36" 48"	60"	72"	Custom Len.			
\$87.75 \$105.79 \$122.11 \$140.93	\$159.07	\$177.20	See Web			
<b>RG400/U Coax, 50 Ohm</b>						
Part No. <b>PE3653</b>	Cable Dia.	Attn. @ 1 GHz	Power @ 1 GHz			
1 piece price shown. See web or call for volume pricing.	0.195" dia.	14.7 dB/100ft	650 W			
12" 24" 36" 48"	60"	72"	Custom Len.			
\$65.94 \$74.08 \$82.20 \$90.81	\$99.09	\$107.39	See Web			
<b>PE-B400 Coax, 50 Ohm</b>						
Part No. <b>PE3629</b>	Cable Dia.	Attn. @ 1 GHz	Power @ 1 GHz			
1 piece price shown. See web or call for volume pricing.	0.403" dia.	6 dB/100ft	190 W			
12" 24" 36" 48"	60"	-	Custom Len.			
\$58.64 \$60.52 \$62.35 \$64.21	\$66.06	-	See Web			
<b>PE-P141 Coax, 50 Ohm</b>						
Part No. <b>PE302</b>	Cable Dia.	Attn. @ 1 GHz	Power @ 1 GHz			
1 piece price shown. See web or call for volume pricing.	0.163" dia.	-	72"			
12" 24" 36" 48"	60"	72"	Custom Len.			
\$184.39 \$196.69 \$209.00 \$222.04	\$234.58	\$257.56	See Web			
<b>PE-P141 Coax, 50 Ohm</b>						
Part No. <b>PE352</b>	Cable Dia.	Attn. @ 1 GHz	Power @ 1 GHz			
1 piece price shown. See web or call for volume pricing.	0.163" dia.	11.2 dB/100ft	600 W			
12" 24" 36" 48"	60"	72"	Custom Len.			
\$134.39 \$146.70 \$158.99 \$172.03	\$184.58	\$185.55	See Web			
<b>PE-P141EAM Coax, 50 Ohm</b>						
Part No. <b>PE3CA1047</b>	Cable Dia.	Attn. @ 1 GHz	Power @ 1 GHz			
1 piece price shown. See web or call for volume pricing.	0.163" dia.	-	100CM			
12" 24" 36" 48"	60"	-	Custom Len.			
\$98.74 \$116.33 \$135.28 \$109.51	\$140.58	-	See Web			
<b>PE-P195 Coax, 50 Ohm</b>						
Part No. <b>PE33377</b>	Cable Dia.	Attn. @ 1 GHz	Power @ 1 GHz			
1 piece price shown. See web or call for volume pricing.	0.195" dia.	12.5 dB/100ft	650 W			
12" 24" 36" 48"	60"	-	Custom Len.			
\$60.51 \$71.01 \$81.54 \$92.69	\$103.44	-	See Web			
<b>LMR-400-UF Coax, 50 Ohm</b>						
Part No. <b>PE3C0218</b>	Cable Dia.	Attn. @ 1 GHz	Power @ 1 GHz			
1 piece price shown. See web or call for volume pricing.	0.405" dia.	5 dB/100ft	300"			
12" 24" 36" 48"	60"	300"	Custom Len.			
\$56.29 \$56.94 \$59.75 \$62.57	\$65.38	Call	See Web			
<b>PE-FF430 Coax, 50 Ohm</b>						
Part No. <b>PE3C4002</b>	Cable Dia.	Attn. @ 1 GHz	Power @ 1 GHz			
1 piece price shown. See web or call for volume pricing.	0.43" dia.	-	-			
60" 144"	-	-	Custom Len.			
\$536.42 \$791.30	-	-	See Web			
<b>PE-FF430 Coax, 50 Ohm</b>						
Part No. <b>PE3C4005</b>	Cable Dia.	Attn. @ 1 GHz	Power @ 1 GHz			
1 piece price shown. See web or call for volume pricing.	0.43" dia.	-	-			
60" 100CM	-	-	Custom Len.			
Call \$648.53	-	-	See Web			

\*Coax Performance at 1 GHz Notes: Cable assembly max frequency may be lower than connector or coax max frequency

# For our complete selection of cable assemblies, please visit our website

PE-VNA-R Coax, 50 Ohm							
Part No.	PE3VNA1803				Cable Dia.	Attn. @ 1 GHz	Power @ 1 GHz
1 piece price shown. See web or call for volume pricing.							
24"	36"	48"	60"	-	-	Custom Len.	
\$858.46	\$996.04	\$954.71	\$1,101.64	-	-	See Web	
RG55B/U Coax, 53 Ohm							
Part No.	PE3499				Cable Dia.	Attn. @ 1 GHz	Power @ 1 GHz
1 piece price shown. See web or call for volume pricing.							
12"	24"	36"	48"	60"	72"	Custom Len.	
\$52.17	\$54.17	\$56.62	\$59.09	\$61.55	\$64.02	See Web	
RG11A/U Coax, 75 Ohm							
Part No.	PE33479				Cable Dia.	Attn. @ 1 GHz	Power @ 1 GHz
1 piece price shown. See web or call for volume pricing.							
12"	24"	36"	48"	60"	-	Custom Len.	
\$72.03	\$74.31	\$71.74	\$73.61	\$75.51	-	See Web	
RG62A/U Coax, 93 Ohm							
Part No.	PE36181				Cable Dia.	Attn. @ 1 GHz	Power @ 1 GHz
1 piece price shown. See web or call for volume pricing.							
12"	24"	36"	48"	60"	-	Custom Len.	
\$42.46	\$43.86	\$45.19	\$46.59	\$47.96	-	See Web	
M17/60-RG142-27478 Coax, 50 Ohm							
Part No.	PE3M008				Cable Dia.	Attn. @ 1 GHz	Power @ 1 GHz
1 piece price shown. See web or call for volume pricing.							
12"	18"	24"	30"	36"	48"	Custom Len.	
\$181.26	\$167.73	\$170.69	\$173.64	\$176.60	\$182.52	See Web	
M17/84-RG223-0XDS2 Coax, 50 Ohm							
Part No.	PE3M0036				Cable Dia.	Attn. @ 1 GHz	Power @ 1 GHz
1 piece price shown. See web or call for volume pricing.							
12"	18"	24"	30"	36"	48"	Custom Len.	
\$186.38	\$174.73	\$180.01	\$185.30	\$191.23	\$201.16	See Web	
M17/128-RG400-27478 Coax, 50 Ohm							
Part No.	PE3M0064				Cable Dia.	Attn. @ 1 GHz	Power @ 1 GHz
1 piece price shown. See web or call for volume pricing.							
12"	18"	24"	30"	36"	48"	Custom Len.	
\$166.39	\$170.15	\$173.91	\$177.67	\$181.44	\$188.96	See Web	

## Standard Semi-Rigid Cable Assemblies

PE-047SR Coax, 50 Ohm							
Part No.	PE34142				Cable Dia.	Attn. @ 1 GHz	Power @ 1 GHz
1 piece price shown. See web or call for volume pricing.							
6"	12"	18"	24"	36"	48"	Custom Len.	
\$100.32	\$110.61	\$109.74	\$122.60	\$125.88	\$136.60	See Web	
PE-SR047AL Coax, 50 Ohm							
Part No.	PE34144				Cable Dia.	Attn. @ 1 GHz	Power @ 1 GHz
1 piece price shown. See web or call for volume pricing.							
6"	12"	18"	24"	36"	48"	Custom Len.	
\$99.73	\$104.56	\$107.94	\$112.67	\$122.17	\$131.73	See Web	
PE-SR402AL Coax, 50 Ohm							
Part No.	PE34138				Cable Dia.	Attn. @ 1 GHz	Power @ 1 GHz
1 piece price shown. See web or call for volume pricing.							
6"	12"	18"	24"	36"	48"	Custom Len.	
\$87.21	\$92.64	\$98.23	\$97.43	\$107.45	\$115.86	See Web	
PE-SR405AL Coax, 50 Ohm							
Part No.	PE34140				Cable Dia.	Attn. @ 1 GHz	Power @ 1 GHz
1 piece price shown. See web or call for volume pricing.							
6"	12"	18"	24"	36"	48"	Custom Len.	
\$107.67	\$112.20	\$116.75	\$121.26	\$130.36	\$139.40	See Web	
RG401/U Coax, 50 Ohm							
Part No.	PE3782				Cable Dia.	Attn. @ 1 GHz	Power @ 1 GHz
1 piece price shown. See web or call for volume pricing.							
6"	12"	18"	24"	36"	48"	Custom Len.	
\$151.35	\$151.35	\$163.26	\$175.13	\$198.94	\$235.59	See Web	
RG402/U Coax, 50 Ohm							
Part No.	PE3827				Cable Dia.	Attn. @ 1 GHz	Power @ 1 GHz
1 piece price shown. See web or call for volume pricing.							
6"	12"	18"	24"	36"	48"	Custom Len.	
\$90.26	\$90.26	\$99.98	\$104.28	\$106.33	\$112.77	See Web	
RG405/U Coax, 50 Ohm							
Part No.	PE3920				Cable Dia.	Attn. @ 1 GHz	Power @ 1 GHz
1 piece price shown. See web or call for volume pricing.							
6"	12"	18"	24"	36"	48"	Custom Len.	
\$106.75	\$110.32	\$113.97	\$117.55	\$133.03	\$132.00	See Web	
PE-SR401AL-STRAIGHT Coax, 50 Ohm							
Part No.	PE3995				Cable Dia.	Attn. @ 1 GHz	Power @ 1 GHz
1 piece price shown. See web or call for volume pricing.							
6"	12"	18"	24"	36"	48"	Custom Len.	
\$147.16	\$155.98	\$157.00	\$166.83	\$186.51	\$206.18	See Web	

## N MALE TO N MALE RIGHT ANGLE



## Flexible Cable Assemblies

PE-P142LL Coax, 50 Ohm							
Part No.	PE345				Cable Dia.	Attn. @ 1 GHz	Power @ 1 GHz
1 piece price shown. See web or call for volume pricing.							
12"	24"	36"	48"	60"	50CM	Custom Len.	
\$241.42	\$259.02	\$276.63	\$294.23	\$311.83	\$252.71	See Web	
Low Loss Flexible Cable Assemblies							
PE-C100-LSZH Coax, 50 Ohm							
Part No.	PE38934				Cable Dia.	Attn. @ 1 GHz	Power @ 1 GHz
1 piece price shown. See web or call for volume pricing.							
12"	24"	36"	48"	60"	-	Custom Len.	
\$59.57	\$60.88	\$62.20	\$63.54	\$64.86	-	See Web	
PE-C195 Coax, 50 Ohm							
Part No.	PE37944				Cable Dia.	Attn. @ 1 GHz	Power @ 1 GHz
1 piece price shown. See web or call for volume pricing.							
36"	48"	60"	72"	120"	-	Custom Len.	
\$55.70	\$56.49	\$57.24	\$58.04	\$61.19	-	See Web	
PE-C240 Coax, 50 Ohm							
Part No.	PE37945				Cable Dia.	Attn. @ 1 GHz	Power @ 1 GHz
1 piece price shown. See web or call for volume pricing.							
36"	48"	60"	72"	120"	-	Custom Len.	
\$67.14	\$68.21	\$69.28	\$72.15	\$83.87	-	See Web	
PE-C400 Coax, 50 Ohm							
Part No.	PE37946				Cable Dia.	Attn. @ 1 GHz	Power @ 1 GHz
1 piece price shown. See web or call for volume pricing.							
36"	48"	60"	72"	120"	-	Custom Len.	
\$95.42	\$97.15	\$98.80	\$102.21	\$107.15	-	See Web	
PE-C600 Coax, 50 Ohm							
Part No.	PE37947				Cable Dia.	Attn. @ 1 GHz	Power @ 1 GHz
1 piece price shown. See web or call for volume pricing.							
36"	48"	60"	72"	120"	-	Custom Len.	
\$134.77	\$137.44	\$148.73	\$142.81	\$153.55	-	See Web	
LMR-400 Coax, 50 Ohm							
Part No.	PE3C0041				Cable Dia.	Attn. @ 1 GHz	Power @ 1 GHz
1 piece price shown. See web or call for volume pricing.							
12"	24"	36"	48"	60"	-	Custom Len.	
\$85.83	\$82.51	\$84.00	\$90.49	\$92.02	-	See Web	
LMR-400 Coax, 50 Ohm							
Part No.	PE3C0106				Cable Dia.	Attn. @ 1 GHz	Power @ 1 GHz
1 piece price shown. See web or call for volume pricing.							
12"	24"	36"	48"	60"	-	Custom Len.	
\$88.53	\$90.06	\$88.98	\$90.49	\$94.73	-	See Web	
LMR-400-DB Coax, 50 Ohm							
Part No.	PE3W00430				Cable Dia.	Attn. @ 1 GHz	Power @ 1 GHz
1 piece price shown. See web or call for volume pricing.							
12"	24"	36"	48"	60"	50CM	Custom Len.	
\$82.96	\$84.34	\$85.71	\$87.07	\$88.45	\$83.85	See Web	
LMR-400-DB Coax, 50 Ohm							
Part No.	PE3W01127				Cable Dia.	Attn. @ 1 GHz	Power @ 1 GHz
1 piece price shown. See web or call for volume pricing.							
12"	24"	36"	48"	60"	50CM	Custom Len.	
\$78.40	\$79.98	\$81.57	\$83.16	\$84.74	\$79.41	See Web	
LMR-600 Coax, 50 Ohm							
Part No.	PE3C0050				Cable Dia.	Attn. @ 1 GHz	Power @ 1 GHz
1 piece price shown. See web or call for volume pricing.							
12"	24"	36"	48"	60"	-	Custom Len.	
\$122.42	\$125.48	\$121.63	\$124.71	\$127.77	-	See Web	
LMR-600 Coax, 50 Ohm							
Part No.	PE3C0111				Cable Dia.	Attn. @ 1 GHz	Power @ 1 GHz
1 piece price shown. See web or call for volume pricing.							
12"	24"	36"	48"	60"	-	Custom Len.	
\$115.56	\$112.10	\$121.71	\$118.22	\$128.09	-	See Web	
PE-P160LL Coax, 50 Ohm							
Part No.	PE3C5285				Cable Dia.	Attn. @ 1 GHz	Power @ 1 GHz
1 piece price shown. See web or call for volume pricing.							
12"	24"	36"	48"	60"	50CM	Custom Len.	
\$286.46	\$308.91	\$331.37	\$353.83	\$376.28	\$300.85	See Web	
PE-P142LL-27478 Coax, 50 Ohm							
Part No.	PE3M0176				Cable Dia.	Attn. @ 1 GHz	Power @ 1 GHz
1 piece price shown. See web or call for volume pricing.							
12"	18"	24"	36"	48"	60"	Custom Len.	
\$525.93	\$535.12	\$544.31	\$562.70	\$581.08	\$599.46	See Web	
PE-P160LL-27478 Coax, 50 Ohm							
Part No.	PE3M0221				Cable Dia.	Attn. @ 1 GHz	Power @ 1 GHz
1 piece price shown. See web or call for volume pricing.							
8"	12"	18"	24"	30"	36"	Custom Len.	
\$475.62	\$480.94	\$488.90	\$496.87	\$504.85	\$512.81	See Web	
PE-P300LL-27478 Coax, 50 Ohm							
Part No.	PE3M0249				Cable Dia.	Attn. @ 1 GHz	Power @ 1 GHz
1 piece price shown. See web or call for volume pricing.							
12"	18"	24"	36"	48"	60"	Custom Len.	
\$610.40	\$625.74	\$641.09	\$671.78	\$702.46	\$733.14	See Web	
Precision Formable Cable Assemblies							
PE-SR402FL Coax, 50 Ohm							
Part No.	PE39453				Cable Dia.	Attn. @ 1 GHz	Power @ 1 GHz
1 piece price shown. See web or call for volume pricing.							
6"	9"	12"	18"	24"	-	Custom Len.	
\$64.38	\$66.53	\$63.61	\$91.70	\$97.54	-	See Web	

Cable Assemblies

See Our Website For Current Pricing & Real-Time Stock Availability!

For Custom Lengths, Metric Lengths or Special Configurations, Please call (949) 261-1920



Technical Support  
+1 (949) 261-1920



Same-Day Shipping,  
Even Custom Cable Assemblies

# For our complete selection of cable assemblies, please visit our website

Cable Assemblies

See Our Website For Current Pricing & Real-Time Stock Availability!

PE-SR405FL Coax, 50 Ohm						
Part No. <a href="#">PE39445</a>	Cable Dia.			Attn. @ 1 GHz	Power @ 1 GHz	
1 piece price shown. See web or call for volume pricing.	22.5 dB/100ft			0.405" dia.	8 dB/100ft	130 W
6"	9"	12"	18"	24"	-	Custom Len.
\$57.76	\$60.80	Call	Call	Call	-	See Web
PE-SR405FLJ Coax, 50 Ohm						
Part No. <a href="#">PE39459</a>	Cable Dia.			Attn. @ 1 GHz	Power @ 1 GHz	
1 piece price shown. See web or call for volume pricing.	0.098" dia.			19.5 dB/100ft	0.405" dia.	130 W
6"	9"	12"	18"	24"	-	Custom Len.
Call	Call	Call	Call	Call	-	See Web
Low PIM Corrugated Cable Assemblies						
PE-1/4SFC Coax, 50 Ohm						
Part No. <a href="#">PE3C7843</a>	Cable Dia.			Attn. @ 1 GHz	Power @ 1 GHz	
1 piece price shown. See web or call for volume pricing.	0.303" dia.			5.85 dB/100ft	0.209" dia.	50 W
12"	50CM	24"	36"	48"	60"	Custom Len.
\$61.96	\$64.35	\$65.69	\$69.42	\$73.14	\$76.87	See Web
SPP-250-LLPL Coax, 50 Ohm						
Part No. <a href="#">PE3C6205</a>	Cable Dia.			Attn. @ 1 GHz	Power @ 1 GHz	
1 piece price shown. See web or call for volume pricing.	0.28" dia.			5.5 dB/100ft	0.43" dia.	650 W
12"	24"	36"	48"	60"	50CM	Custom Len.
\$60.24	\$66.37	\$72.49	\$78.63	\$84.76	\$64.16	See Web
SPO-250 Coax, 50 Ohm						
Part No. <a href="#">PE3C6346</a>	Cable Dia.			Attn. @ 1 GHz	Power @ 1 GHz	
1 piece price shown. See web or call for volume pricing.	0.303" dia.			0.28" dia.	5.5 dB/100ft	650 W
12"	24"	36"	48"	60"	50CM	Custom Len.
\$54.24	\$56.04	\$58.32	\$60.61	\$62.89	\$55.21	See Web
SPF-250 Coax, 50 Ohm						
Part No. <a href="#">PE3C6361</a>	Cable Dia.			Attn. @ 1 GHz	Power @ 1 GHz	
1 piece price shown. See web or call for volume pricing.	0.303" dia.			0.28" dia.	5.5 dB/100ft	650 W
12"	24"	36"	48"	60"	50CM	Custom Len.
\$54.49	\$57.50	\$60.53	\$63.54	\$66.54	\$56.42	See Web
SPO-500 Coax, 50 Ohm						
Part No. <a href="#">PE3C6372</a>	Cable Dia.			Attn. @ 1 GHz	Power @ 1 GHz	
1 piece price shown. See web or call for volume pricing.	0.53" dia.			0.303" dia.	5.5 dB/100ft	650 W
12"	24"	36"	48"	60"	50CM	Custom Len.
\$44.89	\$48.00	\$51.12	\$54.22	\$56.82	\$46.90	See Web
SPF-500 Coax, 50 Ohm						
Part No. <a href="#">PE3C6375</a>	Cable Dia.			Attn. @ 1 GHz	Power @ 1 GHz	
1 piece price shown. See web or call for volume pricing.	0.545" dia.			0.303" dia.	5.5 dB/100ft	650 W
12"	24"	36"	48"	60"	50CM	Custom Len.
\$46.20	\$50.64	\$54.56	\$58.94	\$63.33	\$49.04	See Web
Low Loss Test Flexible Cable Assemblies						
PE-P300LL Coax, 50 Ohm						
Part No. <a href="#">PE3C3240</a>	Cable Dia.			Attn. @ 1 GHz	Power @ 1 GHz	
1 piece price shown. See web or call for volume pricing.	0.3" dia.			5.5 dB/100ft	0.114" dia.	160 W
12"	24"	36"	48"	60"	50CM	Custom Len.
\$271.97	\$300.09	\$328.20	\$356.32	\$384.45	\$289.98	See Web
Standard Formable Cable Assemblies						
PE-SR402FLJ Coax, 50 Ohm						
Part No. <a href="#">PE39467</a>	Cable Dia.			Attn. @ 1 GHz	Power @ 1 GHz	
1 piece price shown. See web or call for volume pricing.	0.161" dia.			11.89 dB/100ft	0.163" dia.	450 W
6"	9"	12"	18"	24"	-	Custom Len.
\$90.58	\$93.79	\$90.58	\$100.59	Call	-	See Web
Standard Flexible Cable Assemblies						
RG8A/U Coax, 50 Ohm						
Part No. <a href="#">PE3699</a>	Cable Dia.			Attn. @ 1 GHz	Power @ 1 GHz	
1 piece price shown. See web or call for volume pricing.	0.405" dia.			8 dB/100ft	0.405" dia.	190 W
12"	24"	36"	48"	60"	72"	Custom Len.
\$90.13	\$97.11	\$100.49	\$104.06	\$102.58	\$105.70	See Web
RG58C/U Coax, 50 Ohm						
Part No. <a href="#">PE3143</a>	Cable Dia.			Attn. @ 1 GHz	Power @ 1 GHz	
1 piece price shown. See web or call for volume pricing.	0.195" dia.			20 dB/100ft	0.43" dia.	44 W
12"	24"	36"	48"	60"	72"	Custom Len.
\$73.17	\$74.08	\$69.37	\$70.18	\$70.98	\$71.79	See Web
RG142B/U Coax, 50 Ohm						
Part No. <a href="#">PE3726</a>	Cable Dia.			Attn. @ 1 GHz	Power @ 1 GHz	
1 piece price shown. See web or call for volume pricing.	0.195" dia.			13 dB/100ft	0.43" dia.	650 W
12"	24"	36"	48"	60"	72"	Custom Len.
\$69.42	\$78.88	\$85.56	\$92.63	\$99.44	\$100.94	See Web
PE3W06863						
Part No. <a href="#">PE3W06863</a>	Cable Dia.			Attn. @ 1 GHz	Power @ 1 GHz	
1 piece price shown. See web or call for volume pricing.	0.195" dia.			13 dB/100ft	0.43" dia.	650 W
12"	24"	36"	48"	60"	50CM	Custom Len.
\$63.97	\$70.46	\$76.94	\$83.43	\$89.93	\$68.13	See Web
RG174A/U Coax, 50 Ohm						
Part No. <a href="#">PE34205</a>	Cable Dia.			Attn. @ 1 GHz	Power @ 1 GHz	
1 piece price shown. See web or call for volume pricing.	0.1" dia.			32 dB/100ft	0.43" dia.	16 W
12"	24"	36"	48"	60"	72"	Custom Len.
\$70.69	\$71.18	\$71.65	\$72.13	\$72.60	\$73.07	See Web
RG188A/U Coax, 50 Ohm						
Part No. <a href="#">PE34212</a>	Cable Dia.			Attn. @ 1 GHz	Power @ 1 GHz	
1 piece price shown. See web or call for volume pricing.	0.11" dia.			26 dB/100ft	0.43" dia.	160 W
12"	24"	36"	48"	60"	72"	Custom Len.
\$68.58	\$70.91	\$73.28	\$75.58	\$77.96	\$80.34	See Web

RG213/U Coax, 50 Ohm						
Part No. <a href="#">PE3797</a>	Cable Dia.			Attn. @ 1 GHz	Power @ 1 GHz	
1 piece price shown. See web or call for volume pricing.	0.405" dia.			8 dB/100ft	0.405" dia.	190 W
12"	24"	36"	48"	60"	72"	Custom Len.
\$90.55	\$97.95	\$99.92	\$101.99	\$97.86	\$106.00	See Web
RG214/U Coax, 50 Ohm						
Part No. <a href="#">PE3071</a>	Cable Dia.			Attn. @ 1 GHz	Power @ 1 GHz	
1 piece price shown. See web or call for volume pricing.	0.425" dia.			7.32 dB/100ft	0.425" dia.	170 W
12"	24"	36"	48"	60"	72"	Custom Len.
\$107.77	\$114.71	\$123.13	\$126.01	\$140.66	\$149.26	See Web
RG223/U Coax, 50 Ohm						
Part No. <a href="#">PE3168</a>	Cable Dia.			Attn. @ 1 GHz	Power @ 1 GHz	
1 piece price shown. See web or call for volume pricing.	0.209" dia.			13.41 dB/100ft	0.209" dia.	50 W
12"	24"	36"	48"	60"	72"	Custom Len.
\$74.48	\$72.15	\$81.34	\$84.97	\$81.72	\$91.95	See Web
RG225/U Coax, 50 Ohm						
Part No. <a href="#">PE34203</a>	Cable Dia.			Attn. @ 1 GHz	Power @ 1 GHz	
1 piece price shown. See web or call for volume pricing.	0.43" dia.			0.43" dia.	1.700 W	1.700 W
12"	24"	36"	48"	60"	72"	Custom Len.
\$126.53	\$161.86	\$197.20	\$232.53	\$267.85	\$303.19	See Web
RG316/U Coax, 50 Ohm						
Part No. <a href="#">PE34210</a>	Cable Dia.			Attn. @ 1 GHz	Power @ 1 GHz	
1 piece price shown. See web or call for volume pricing.	0.098" dia.			38 dB/100ft	0.098" dia.	160 W
12"	24"	36"	48"	60"	72"	Custom Len.
\$73.69	\$76.87	\$84.99	\$83.22	\$86.39	\$95.62	See Web
RG316-DS Coax, 50 Ohm						
Part No. <a href="#">PE34207</a>	Cable Dia.			Attn. @ 1 GHz	Power @ 1 GHz	
1 piece price shown. See web or call for volume pricing.	0.114" dia.			30 dB/100ft	0.114" dia.	160 W
12"	24"	36"	48"	60"	72"	Custom Len.
\$69.44	\$72.68	\$75.86	\$79.09	\$82.32	\$85.54	See Web
RG393/U Coax, 50 Ohm						
Part No. <a href="#">PE3255</a>	Cable Dia.			Attn. @ 1 GHz	Power @ 1 GHz	
1 piece price shown. See web or call for volume pricing.	0.39" dia.			7.5 dB/100ft	0.39" dia.	1,700 W
12"	24"	36"	48"	60"	72"	Custom Len.
\$106.63	\$129.24	\$147.04	\$165.86	\$183.99	\$202.12	See Web
RG400/U Coax, 50 Ohm						
Part No. <a href="#">PE33321</a>	Cable Dia.			Attn. @ 1 GHz	Power @ 1 GHz	
1 piece price shown. See web or call for volume pricing.	0.195" dia.			14.7 dB/100ft	0.195" dia.	650 W
12"	24"	36"	48"	60"	72"	Custom Len.
\$79.49	\$92.39	\$100.52	\$107.61	\$108.61	\$123.95	See Web
PE-P141EAM Coax, 50 Ohm						
Part No. <a href="#">PE3CA1048</a>	Cable Dia.			Attn. @ 1 GHz	Power @ 1 GHz	
1 piece price shown. See web or call for volume pricing.	0.163" dia.			50CM	100CM	Custom Len.
12"	24"	36"	75"	50CM	100CM	Custom Len.
\$95.75	\$108.57	\$126.26	Call	\$103.64	\$131.22	See Web
PE-1/2 Helical Coax, 50 Ohm						
Part No. <a href="#">PE37970</a>	Cable Dia.			Attn. @ 1 GHz	Power @ 1 GHz	
1 piece price shown. See web or call for volume pricing.	0.54" dia.			-	-	Custom Len.
36"	72"	-	-	-	-	Custom Len.
\$128.51	\$170.30	-	-	-	-	See Web
LMR-400 Coax, 50 Ohm						
Part No. <a href="#">PE3C7931</a>	Cable Dia.			Attn. @ 1 GHz	Power @ 1 GHz	
1 piece price shown. See web or call for volume pricing.	0.405" dia.			4.25 dB/100ft	0.405" dia.	50CM
12"	24"	36"	48"	60"	50CM	Custom Len.
\$60.09	\$61.45	\$62.81	\$64.17	\$65.53	\$59.59	See Web
LMR-400-UF Coax, 50 Ohm						
Part No. <a href="#">PE3C3643</a>	Cable Dia.			Attn. @ 1 GHz	Power @ 1 GHz	
1 piece price shown. See web or call for volume pricing.	0.405" dia.			5 dB/100ft	0.405" dia.	50CM
12"	24"	36"	48"	60"	50CM	Custom Len.
\$61.87	\$61.19	\$63.98	\$66.80	\$69.61	\$60.17	See Web
PE-FF430 Coax, 50 Ohm						
Part No. <a href="#">PE3C4003</a>	Cable Dia.			Attn. @ 1 GHz	Power @ 1 GHz	
1 piece price shown. See web or call for volume pricing.	0.43" dia.			-	-	Custom Len.
60"	144"	-	-	-	-	Custom Len.
\$824.84	\$1,136.07	-	-	-	-	See Web
PE3C4006						
Part No. <a href="#">PE3C4006</a>	Cable Dia.			Attn. @ 1 GHz	Power @ 1 GHz	
1 piece price shown. See web or call for volume pricing.	0.43" dia.			-	-	Custom Len.
60"	100CM	-	-	-	-	Custom Len.
Call	\$871.78	-	-	-	-	See Web
N MALE TO N FEMALE						
Corrugated Cable Assemblies						
SPP-250-LLPL Coax, 50 Ohm						
Part No. <a href="#">PE3C4138</a>	Cable Dia.			Attn. @ 1 GHz	Power @ 1 GHz	
1 piece price shown. See web or call for volume pricing.	0.28" dia.			5.5 dB/100ft	0.28" dia.	650 W
12"	24"	36"	48"	60"	50CM	Custom Len.
\$96.43	\$102.56	\$107.19	\$113.24	\$119.30	\$100.37	See Web
Low Loss Flexible Cable Assemblies						
PE-C195 Coax, 50 Ohm						
Part No. <a href="#">PE37948</a>	Cable Dia.			Attn. @ 1 GHz	Power @ 1 GHz	
1 piece price shown. See web or call for volume pricing.	0.195" dia.			11.3 dB/100ft	0.195" dia.	150 W
36"	48"	60"	72"	120"	-	Custom Len.
\$36.51	\$35.19	\$35.99	\$36.77	\$39.93	-	See Web



\*Coax Performance at 1 GHz Notes: Cable assembly max frequency may be lower than connector or coax max frequency



# For our complete selection of cable assemblies, please visit our website

PE-C240 Coax, 50 Ohm						
Part No. <a href="#">PE37949</a>	Cable Dia.	Attn. @ 1 GHz	Power @ 1 GHz			
1 piece price shown. See web or call for volume pricing.	0.24" dia.	9.2 dB/100ft	250 W			
36"	48"	60"	72"	120"	-	Custom Len.
\$52.54	\$53.61	\$54.19	\$55.26	\$59.51	-	See Web
PE-C400 Coax, 50 Ohm						
Part No. <a href="#">PE34716</a>	Cable Dia.	Attn. @ 1 GHz	Power @ 1 GHz			
1 piece price shown. See web or call for volume pricing.	0.4" dia.	4.1 dB/100ft	550 W			
12"	24"	36"	48"	60"	-	Custom Len.
\$73.21	\$74.61	\$75.98	\$77.37	\$84.27	-	See Web
Part No. <a href="#">PE37950</a>	Cable Dia.	Attn. @ 1 GHz	Power @ 1 GHz			
1 piece price shown. See web or call for volume pricing.	0.4" dia.	4.1 dB/100ft	550 W			
36"	48"	60"	72"	120"	-	Custom Len.
\$76.44	\$77.88	\$79.32	\$80.78	\$86.57	-	See Web
PE-C600 Coax, 50 Ohm						
Part No. <a href="#">PE37951</a>	Cable Dia.	Attn. @ 1 GHz	Power @ 1 GHz			
1 piece price shown. See web or call for volume pricing.	0.59" dia.	2.7 dB/100ft	900 W			
36"	48"	72"	120"	300CM	-	Custom Len.
\$119.31	\$121.90	\$135.45	\$137.45	\$141.22	-	See Web
LMR-400 Coax, 50 Ohm						
Part No. <a href="#">PE3W00676</a>	Cable Dia.	Attn. @ 1 GHz	Power @ 1 GHz			
1 piece price shown. See web or call for volume pricing.	0.405" dia.	-	-	50CM	-	Custom Len.
12"	24"	36"	48"	60"	-	Custom Len.
\$63.02	\$64.49	\$65.96	\$67.44	\$68.91	\$63.96	See Web
PE-SF200LL Coax, 50 Ohm						
Part No. <a href="#">PE3TC1103</a>	Cable Dia.	Attn. @ 1 GHz	Power @ 1 GHz			
1 piece price shown. See web or call for volume pricing.	0.185" dia.	-	-	200CM	-	Custom Len.
24"	36"	48"	72"	100CM	-	Custom Len.
\$83.29	\$95.68	\$106.56	\$130.97	\$99.15	\$137.83	See Web
Precision Formable Cable Assemblies						
PE-SR402FL Coax, 50 Ohm						
Part No. <a href="#">PE39454</a>	Cable Dia.	Attn. @ 1 GHz	Power @ 1 GHz			
1 piece price shown. See web or call for volume pricing.	-	11.88 dB/100ft	450 W			
6"	9"	12"	18"	24"	-	Custom Len.
\$88.29	Call	Call	Call	Call	-	See Web
PE-SR405FL Coax, 50 Ohm						
Part No. <a href="#">PE39446</a>	Cable Dia.	Attn. @ 1 GHz	Power @ 1 GHz			
1 piece price shown. See web or call for volume pricing.	-	22.5 dB/100ft	130 W			
6"	9"	12"	18"	24"	-	Custom Len.
Call	Call	Call	Call	Call	-	See Web
PE-80TEST Coax, 50 Ohm						
Part No. <a href="#">PE3TC0104</a>	Cable Dia.	Attn. @ 1 GHz	Power @ 1 GHz			
1 piece price shown. See web or call for volume pricing.	0.195" dia.	-	-	-	-	Custom Len.
24"	48"	72"	-	-	-	Custom Len.
\$416.24	\$509.19	\$602.16	-	-	-	See Web
Low PIM Formable Cable Assemblies						
PE-SR402FLJ Low PIM Coax, 50 Ohm						
Part No. <a href="#">PE3C2001</a>	Cable Dia.	Attn. @ 1 GHz	Power @ 1 GHz			
1 piece price shown. See web or call for volume pricing.	0.161" dia.	-	-	-	-	Custom Len.
100CM	200CM	-	-	-	-	Custom Len.
\$80.05	\$102.52	-	-	-	-	See Web
Low PIM Corrugated Cable Assemblies						
PE-1/4SFHC Coax, 50 Ohm						
Part No. <a href="#">PE3C7844</a>	Cable Dia.	Attn. @ 1 GHz	Power @ 1 GHz			
1 piece price shown. See web or call for volume pricing.	0.303" dia.	5.85 dB/100ft	-			
12"	24"	36"	48"	60"	50CM	Custom Len.
\$59.21	\$62.95	\$66.67	\$70.40	\$74.13	\$61.60	See Web
SPP-250-LLPL Coax, 50 Ohm						
Part No. <a href="#">PE3C6200</a>	Cable Dia.	Attn. @ 1 GHz	Power @ 1 GHz			
1 piece price shown. See web or call for volume pricing.	0.28" dia.	5.5 dB/100ft	650 W			
12"	24"	36"	48"	60"	50CM	Custom Len.
\$57.61	\$63.75	\$69.88	\$76.00	\$82.14	\$61.52	See Web
Low Loss Test Flexible Cable Assemblies						
PE-P300LL Coax, 50 Ohm						
Part No. <a href="#">PE331</a>	Cable Dia.	Attn. @ 1 GHz	Power @ 1 GHz			
1 piece price shown. See web or call for volume pricing.	0.3" dia.	4.6 dB/100ft	-			
12"	24"	36"	48"	60"	50CM	Custom Len.
\$426.07	\$454.22	\$458.19	\$486.33	\$514.44	\$419.98	See Web
Part No. <a href="#">PE3C3241</a>	Cable Dia.	Attn. @ 1 GHz	Power @ 1 GHz			
1 piece price shown. See web or call for volume pricing.	0.3" dia.	5.5 dB/100ft	-			
12"	24"	36"	48"	60"	50CM	Custom Len.
\$251.68	\$279.01	\$306.34	\$333.65	\$360.99	\$269.18	See Web
Standard Formable Cable Assemblies						
PE-SR407FL Coax, 50 Ohm						
Part No. <a href="#">PE34291</a>	Cable Dia.	Attn. @ 1 GHz	Power @ 1 GHz			
1 piece price shown. See web or call for volume pricing.	0.047" dia.	36 dB/100ft	32 W			
6"	12"	18"	24"	36"	48"	Custom Len.
\$106.85	\$109.22	\$113.12	\$116.96	\$124.72	\$132.45	See Web
PE-SR401FL Coax, 50 Ohm						
Part No. <a href="#">PE34293</a>	Cable Dia.	Attn. @ 1 GHz	Power @ 1 GHz			
1 piece price shown. See web or call for volume pricing.	-	7.6 dB/100ft	1,400 W			
6"	12"	18"	24"	36"	48"	Custom Len.
\$108.77	\$116.81	\$124.97	\$133.02	\$149.23	\$165.42	See Web

PE-SR402FL Coax, 50 Ohm						
Part No. <a href="#">PE3485</a>	Cable Dia.	Attn. @ 1 GHz	Power @ 1 GHz			
1 piece price shown. See web or call for volume pricing.	-	11.88 dB/100ft	450 W			
6"	12"	18"	24"	36"	48"	Custom Len.
\$92.34	\$96.36	\$100.41	\$109.49	\$110.86	\$118.77	See Web
PE-SR405FL Coax, 50 Ohm						
Part No. <a href="#">PE3965</a>	Cable Dia.	Attn. @ 1 GHz	Power @ 1 GHz			
1 piece price shown. See web or call for volume pricing.	-	22.5 dB/100ft	130 W			
6"	12"	18"	24"	36"	48"	Custom Len.
\$102.12	\$107.85	\$111.94	\$117.61	\$128.80	\$140.06	See Web
Standard Flexible Cable Assemblies						
RG58C/U Coax, 50 Ohm						
Part No. <a href="#">PE3714</a>	Cable Dia.	Attn. @ 1 GHz	Power @ 1 GHz			
1 piece price shown. See web or call for volume pricing.	0.195" dia.	20 dB/100ft	44 W			
12"	24"	36"	48"	72"	-	Custom Len.
\$56.19	\$61.58	\$62.47	\$58.61	\$59.43	\$60.24	See Web
RG142B/U Coax, 50 Ohm						
Part No. <a href="#">PE3996</a>	Cable Dia.	Attn. @ 1 GHz	Power @ 1 GHz			
1 piece price shown. See web or call for volume pricing.	0.195" dia.	13 dB/100ft	650 W			
12"	24"	36"	48"	60"	72"	Custom Len.
\$60.11	\$66.79	\$73.48	\$80.54	\$87.34	\$94.17	See Web
RG188A/U Coax, 50 Ohm						
Part No. <a href="#">PE34283</a>	Cable Dia.	Attn. @ 1 GHz	Power @ 1 GHz			
1 piece price shown. See web or call for volume pricing.	0.11" dia.	26 dB/100ft	160 W			
12"	24"	36"	48"	60"	72"	Custom Len.
\$66.96	\$69.39	\$71.84	\$74.29	\$76.72	\$79.16	See Web
RG213/U Coax, 50 Ohm						
Part No. <a href="#">PE3232</a>	Cable Dia.	Attn. @ 1 GHz	Power @ 1 GHz			
1 piece price shown. See web or call for volume pricing.	0.405" dia.	9 dB/100ft	190 W			
12"	24"	36"	48"	60"	72"	Custom Len.
\$72.38	\$74.34	\$76.30	\$78.39	\$80.39	\$82.39	See Web
RG214/U Coax, 50 Ohm						
Part No. <a href="#">PE3650</a>	Cable Dia.	Attn. @ 1 GHz	Power @ 1 GHz			
1 piece price shown. See web or call for volume pricing.	0.425" dia.	7.32 dB/100ft	190 W			
12"	24"	36"	48"	60"	72"	Custom Len.
\$79.13	\$87.68	\$96.24	\$105.28	\$106.87	\$121.02	See Web
RG217/U Coax, 50 Ohm						
Part No. <a href="#">PE34274</a>	Cable Dia.	Attn. @ 1 GHz	Power @ 1 GHz			
1 piece price shown. See web or call for volume pricing.	0.545" dia.	5.8 dB/100ft	260 W			
12"	24"	36"	48"	72"	-	Custom Len.
\$139.43	\$144.21	\$149.00	\$153.76	\$158.54	\$163.31	See Web
RG218/U Coax, 50 Ohm						
Part No. <a href="#">PE34276</a>	Cable Dia.	Attn. @ 1 GHz	Power @ 1 GHz			
1 piece price shown. See web or call for volume pricing.	0.87" dia.	3.8 dB/100ft	560 W			
12"	24"	36"	48"	60"	72"	Custom Len.
\$208.45	\$220.57	\$232.59	\$244.69	\$256.80	\$288.30	See Web
RG223/U Coax, 50 Ohm						
Part No. <a href="#">PE3667</a>	Cable Dia.	Attn. @ 1 GHz	Power @ 1 GHz			
1 piece price shown. See web or call for volume pricing.	0.21" dia.	13.4 dB/100ft	53 W			
12"	24"	36"	48"	60"	72"	Custom Len.
\$54.67	\$54.77	\$57.96	\$65.13	\$68.63	\$72.13	See Web
RG225/U Coax, 50 Ohm						
Part No. <a href="#">PE33728</a>	Cable Dia.	Attn. @ 1 GHz	Power @ 1 GHz			
1 piece price shown. See web or call for volume pricing.	0.43" dia.	-	-			
12"	24"	36"	48"	60"	72"	Custom Len.
\$96.84	\$130.83	\$166.14	\$201.48	\$236.82	\$272.13	See Web
RG316/U Coax, 50 Ohm						
Part No. <a href="#">PE3986</a>	Cable Dia.	Attn. @ 1 GHz	Power @ 1 GHz			
1 piece price shown. See web or call for volume pricing.	0.098" dia.	38 dB/100ft	160 W			
12"	24"	36"	48"	60"	72"	Custom Len.
\$67.95	\$75.46	\$74.31	\$77.47	\$80.65	\$83.82	See Web
RG316-DS Coax, 50 Ohm						
Part No. <a href="#">PE34281</a>	Cable Dia.	Attn. @ 1 GHz	Power @ 1 GHz			
1 piece price shown. See web or call for volume pricing.	0.114" dia.	26.1 dB/100ft	160 W			
12"	24"	36"	48"	60"	72"	Custom Len.
\$62.85	\$66.10	\$69.25	\$72.48	\$75.71	\$78.94	See Web
RG393/U Coax, 50 Ohm						
Part No. <a href="#">PE3977</a>	Cable Dia.	Attn. @ 1 GHz	Power @ 1 GHz			
1 piece price shown. See web or call for volume pricing.	0.39" dia.	8.8 dB/100ft	1,700 W			
12"	24"	36"	48"	60"	72"	Custom Len.
\$87.82	\$105.86	\$122.17	\$141.00	\$148.77	\$165.54	See Web
RG400/U Coax, 50 Ohm						
Part No. <a href="#">PE3617</a>	Cable Dia.	Attn. @ 1 GHz	Power @ 1 GHz			
1 piece price shown. See web or call for volume pricing.	0.195" dia.	14.7 dB/100ft	650 W			
12"	24"	36"	48"	60"	72"	Custom Len.
\$69.54	\$77.67	\$85.80	\$94.40	\$102.70	\$103.91	See Web
Part No. <a href="#">PE3W07899</a>	Cable Dia.	Attn. @ 1 GHz	Power @ 1 GHz			
1 piece price shown. See web or call for volume pricing.	0.195" dia.	14.7 dB/100ft	600 W			
12"	18"	24"	36"	48"	60"	Custom Len.
\$67.01	\$68.52	\$72.55	\$80.61	\$88.67	\$96.73	See Web
PE-1/2 Helical Coax, 50 Ohm						
Part No. <a href="#">PE37969</a>	Cable Dia.	Attn. @ 1 GHz	Power @ 1 GHz			
1 piece price shown. See web or call for volume pricing.	0.54" dia.	-	-			
36"	72"	-	-	-	-	Custom Len.
\$127.71	\$156.16	-	-	-	-	See Web

Cable Assemblies

See Our Website For Current Pricing & Real-Time Stock Availability!

For Custom Lengths, Metric Lengths or Special Configurations, Please call (949) 261-1920



Technical Support  
+1 (949) 261-1920



Same-Day Shipping,  
Even Custom Cable Assemblies



For our complete selection of cable assemblies, please visit our website

Cable Assemblies  
See Our Website For Current Pricing & Real-Time Stock Availability!

PE-FF430 Coax, 50 Ohm						
Part No.	PE3C4004			Cable Dia.	Attn. @ 1 GHz	Power @ 1 GHz
1 piece price shown. See web or call for volume pricing.						
60"	144"	-	-	0.43" dia.	-	Custom Len.
\$536.42	\$791.30	-	-	-	-	See Web
PE3C4007						
1 piece price shown. See web or call for volume pricing.						
60"	100CM	-	-	0.43" dia.	-	Custom Len.
Call	\$690.69	-	-	-	-	See Web
PE-VNA-R Coax, 50 Ohm						
Part No.	PE3VNA1804			Cable Dia.	Attn. @ 1 GHz	Power @ 1 GHz
1 piece price shown. See web or call for volume pricing.						
24"	48"	-	-	0.43" dia.	-	Custom Len.
\$874.60	\$971.42	-	-	-	-	See Web
M17/60-RG142-27478 Coax, 50 Ohm						
Part No.	PE3M0009			Cable Dia.	Attn. @ 1 GHz	Power @ 1 GHz
1 piece price shown. See web or call for volume pricing.						
12"	18"	24"	30"	0.195" dia.	48"	Custom Len.
\$175.15	\$178.12	\$181.08	\$184.03	\$186.99	\$192.91	See Web
M17/84-RG223-0XDS2 Coax, 50 Ohm						
Part No.	PE3M0037			Cable Dia.	Attn. @ 1 GHz	Power @ 1 GHz
1 piece price shown. See web or call for volume pricing.						
12"	18"	24"	30"	0.212" dia.	48"	Custom Len.
\$179.83	\$185.11	\$190.41	\$195.68	\$200.98	\$211.56	See Web
M17/128-RG400-27478 Coax, 50 Ohm						
Part No.	PE3M0065			Cable Dia.	Attn. @ 1 GHz	Power @ 1 GHz
1 piece price shown. See web or call for volume pricing.						
12"	18"	24"	30"	0.195" dia.	48"	Custom Len.
\$176.77	\$180.53	\$184.29	\$188.06	\$191.82	\$199.34	See Web
Standard Semi-Rigid Cable Assemblies						
PE-047SR Coax, 50 Ohm						
Part No.	PE34287			Cable Dia.	Attn. @ 1 GHz	Power @ 1 GHz
1 piece price shown. See web or call for volume pricing.						
6"	12"	18"	24"	36"	48"	Custom Len.
\$106.88	\$112.20	\$117.61	\$123.02	\$133.75	\$144.55	See Web
PE-SR047AL Coax, 50 Ohm						
Part No.	PE34296			Cable Dia.	Attn. @ 1 GHz	Power @ 1 GHz
1 piece price shown. See web or call for volume pricing.						
6"	12"	18"	24"	36"	48"	Custom Len.
\$107.72	\$111.04	\$115.80	\$120.55	\$130.08	\$139.61	See Web
PE-SR402AL Coax, 50 Ohm						
Part No.	PE34289			Cable Dia.	Attn. @ 1 GHz	Power @ 1 GHz
1 piece price shown. See web or call for volume pricing.						
6"	12"	18"	24"	36"	48"	Custom Len.
\$93.40	\$98.43	\$103.44	\$106.93	\$116.81	\$126.73	See Web
PE-SR405AL Coax, 50 Ohm						
Part No.	PE34285			Cable Dia.	Attn. @ 1 GHz	Power @ 1 GHz
1 piece price shown. See web or call for volume pricing.						
6"	12"	18"	24"	36"	48"	Custom Len.
\$101.05	\$105.59	\$108.69	\$113.27	\$122.30	\$131.42	See Web
RG401/U Coax, 50 Ohm						
Part No.	PE3979			Cable Dia.	Attn. @ 1 GHz	Power @ 1 GHz
1 piece price shown. See web or call for volume pricing.						
6"	12"	18"	24"	36"	48"	Custom Len.
\$112.20	\$123.72	\$135.30	\$146.82	\$185.23	\$193.03	See Web
RG402/U Coax, 50 Ohm						
Part No.	PE3829			Cable Dia.	Attn. @ 1 GHz	Power @ 1 GHz
1 piece price shown. See web or call for volume pricing.						
6"	12"	18"	24"	36"	48"	Custom Len.
\$101.94	\$101.94	\$105.96	\$108.44	\$116.37	\$124.28	See Web
RG405/U Coax, 50 Ohm						
Part No.	PE3921			Cable Dia.	Attn. @ 1 GHz	Power @ 1 GHz
1 piece price shown. See web or call for volume pricing.						
6"	12"	18"	24"	36"	48"	Custom Len.
\$97.36	\$101.00	\$104.69	\$106.82	\$114.03	\$121.26	See Web
PE-SR401AL-STRAIGHT Coax, 50 Ohm						
Part No.	PE3988			Cable Dia.	Attn. @ 1 GHz	Power @ 1 GHz
1 piece price shown. See web or call for volume pricing.						
6"	12"	18"	24"	36"	48"	Custom Len.
\$110.19	\$119.69	\$129.25	\$138.76	\$157.83	\$176.88	See Web

**N MALE TO N FEMALE BULKHEAD**

SEE MOUNTING HOLE SECTION ON PAGE 409



**Flexible Cable Assemblies**

LMR-400-UF Coax, 50 Ohm						
Part No.	PE3W02547			Cable Dia.	Attn. @ 1 GHz	Power @ 1 GHz
1 piece price shown. See web or call for volume pricing.						
12"	24"	36"	48"	0.405" dia.	92 dB/100ft	Custom Len.
\$59.12	\$71.58	\$74.46	\$77.35	\$80.25	\$70.55	See Web
Low Loss Flexible Cable Assemblies						
PE-C240 Coax, 50 Ohm						
Part No.	PE38672			Cable Dia.	Attn. @ 1 GHz	Power @ 1 GHz
1 piece price shown. See web or call for volume pricing.						
36"	48"	60"	72"	0.24" dia.	250 W	Custom Len.
\$58.23	\$55.78	\$57.77	\$62.09	\$73.21	-	See Web
PE-P142LL Coax, 50 Ohm						
Part No.	PE344			Cable Dia.	Attn. @ 1 GHz	Power @ 1 GHz
1 piece price shown. See web or call for volume pricing.						
12"	24"	36"	48"	0.195" dia.	10 dB/100ft	Custom Len.
\$198.22	\$215.83	\$233.43	\$251.03	\$268.63	\$209.49	See Web
PE-P160LL Coax, 50 Ohm						
Part No.	PE3C5257			Cable Dia.	Attn. @ 1 GHz	Power @ 1 GHz
1 piece price shown. See web or call for volume pricing.						
12"	24"	36"	48"	0.16" dia.	50CM	Custom Len.
\$251.25	\$273.71	\$296.15	\$318.61	\$341.07	\$265.63	See Web
PE-P142LL-27478 Coax, 50 Ohm						
Part No.	PE3M0175			Cable Dia.	Attn. @ 1 GHz	Power @ 1 GHz
1 piece price shown. See web or call for volume pricing.						
12"	18"	24"	36"	0.195" dia.	60"	Custom Len.
\$495.75	\$504.94	\$514.13	\$532.53	\$550.90	\$569.29	See Web
PE-P160LL-27478 Coax, 50 Ohm						
Part No.	PE3M0220			Cable Dia.	Attn. @ 1 GHz	Power @ 1 GHz
1 piece price shown. See web or call for volume pricing.						
8"	12"	18"	24"	0.16" dia.	36"	Custom Len.
\$479.88	\$485.20	\$493.16	\$501.13	\$508.70	\$517.07	See Web
PE-P300LL-27478 Coax, 50 Ohm						
Part No.	PE3M0248			Cable Dia.	Attn. @ 1 GHz	Power @ 1 GHz
1 piece price shown. See web or call for volume pricing.						
12"	18"	24"	36"	0.3" dia.	60"	Custom Len.
\$535.30	\$550.64	\$565.99	\$596.67	\$627.35	\$658.04	See Web
Low PIM Corrugated Cable Assemblies						
PE-1/4SFHC Coax, 50 Ohm						
Part No.	PE3C7845			Cable Dia.	Attn. @ 1 GHz	Power @ 1 GHz
1 piece price shown. See web or call for volume pricing.						
12"	24"	36"	48"	0.303" dia.	5.85 dB/100ft	Custom Len.
\$59.21	\$62.95	\$66.67	\$70.40	\$74.13	\$61.60	See Web
SPP-250-LLPL Coax, 50 Ohm						
Part No.	PE3C6201			Cable Dia.	Attn. @ 1 GHz	Power @ 1 GHz
1 piece price shown. See web or call for volume pricing.						
12"	24"	36"	48"	0.28" dia.	5.5 dB/100ft	650 W
\$57.61	\$63.75	\$69.88	\$76.00	\$82.14	\$61.52	See Web
Standard Formable Cable Assemblies						
PE-SR047FL Coax, 50 Ohm						
Part No.	PE34156			Cable Dia.	Attn. @ 1 GHz	Power @ 1 GHz
1 piece price shown. See web or call for volume pricing.						
6"	12"	18"	24"	0.047" dia.	36 dB/100ft	32 W
\$107.35	\$111.23	\$115.07	\$118.98	\$126.73	\$134.47	See Web
PE-SR401FL Coax, 50 Ohm						
Part No.	PE34150			Cable Dia.	Attn. @ 1 GHz	Power @ 1 GHz
1 piece price shown. See web or call for volume pricing.						
6"	12"	18"	24"	7.6 dB/100ft	1,400 W	Custom Len.
\$110.32	\$118.44	\$126.53	\$134.65	\$150.85	\$167.06	See Web
PE-SR402FL Coax, 50 Ohm						
Part No.	PE3488			Cable Dia.	Attn. @ 1 GHz	Power @ 1 GHz
1 piece price shown. See web or call for volume pricing.						
6"	12"	18"	24"	11.88 dB/100ft	450 W	Custom Len.
\$100.83	\$100.83	\$104.97	\$107.59	\$115.78	\$123.95	See Web
PE-SR405FL Coax, 50 Ohm						
Part No.	PE3971			Cable Dia.	Attn. @ 1 GHz	Power @ 1 GHz
1 piece price shown. See web or call for volume pricing.						
6"	12"	18"	24"	22.5 dB/100ft	130 W	Custom Len.
\$106.75	\$112.34	\$118.01	\$123.61	\$134.86	\$146.11	See Web
Standard Flexible Cable Assemblies						
RG8A/U Coax, 50 Ohm						
Part No.	PE3966			Cable Dia.	Attn. @ 1 GHz	Power @ 1 GHz
1 piece price shown. See web or call for volume pricing.						
12"	24"	36"	48"	0.405" dia.	8 dB/100ft	190 W
\$87.91	\$86.04	\$89.15	\$92.28	\$95.39	\$98.50	See Web
RG58C/U Coax, 50 Ohm						
Part No.	PE3320			Cable Dia.	Attn. @ 1 GHz	Power @ 1 GHz
1 piece price shown. See web or call for volume pricing.						
12"	24"	36"	48"	0.195" dia.	20 dB/100ft	44 W
\$61.60	\$62.50	\$59.73	\$64.35	\$61.35	\$62.16	See Web
RG142B/U Coax, 50 Ohm						
Part No.	PE3034			Cable Dia.	Attn. @ 1 GHz	Power @ 1 GHz
1 piece price shown. See web or call for volume pricing.						
12"	24"	36"	48"	0.195" dia.	12.9 dB/100ft	Custom Len.
\$63.04	\$69.73	\$76.41	\$83.49	\$90.29	\$97.11	See Web

\*Coax Performance at 1 GHz Notes: Cable assembly max frequency may be lower than connector or coax max frequency

# For our complete selection of cable assemblies, please visit our website

RG178B/U Coax, 50 Ohm						
Part No. <a href="#">PE34201</a>	Cable Dia.		Attn. @ 1 GHz	Power @ 1 GHz		
1 piece price shown. See web or call for volume pricing.	0.072" dia.		44.4 dB/100ft	78 W		
12"	24"	36"	48"	60"	72"	Custom Len.
\$77.37	\$78.42	\$79.48	\$80.53	\$81.60	\$82.65	See Web
RG188A/U Coax, 50 Ohm						
Part No. <a href="#">PE34181</a>	Cable Dia.		Attn. @ 1 GHz	Power @ 1 GHz		
1 piece price shown. See web or call for volume pricing.	0.11" dia.		26 dB/100ft	160 W		
12"	24"	36"	48"	60"	72"	Custom Len.
\$69.25	\$71.62	\$73.93	\$76.32	\$78.69	\$80.98	See Web
RG213/U Coax, 50 Ohm						
Part No. <a href="#">PE33543</a>	Cable Dia.		Attn. @ 1 GHz	Power @ 1 GHz		
1 piece price shown. See web or call for volume pricing.	0.405" dia.		8 dB/100ft	190 W		
12"	24"	36"	48"	60"	72"	Custom Len.
\$81.67	\$83.49	\$85.32	\$87.14	\$88.98	\$90.80	See Web
RG214/U Coax, 50 Ohm						
Part No. <a href="#">PE3217</a>	Cable Dia.		Attn. @ 1 GHz	Power @ 1 GHz		
1 piece price shown. See web or call for volume pricing.	0.425" dia.		7.32 dB/100ft	170 W		
12"	24"	36"	48"	60"	72"	Custom Len.
\$76.56	\$85.36	\$94.17	\$102.97	\$110.22	\$118.91	See Web
RG223/U Coax, 50 Ohm						
Part No. <a href="#">PE3686</a>	Cable Dia.		Attn. @ 1 GHz	Power @ 1 GHz		
1 piece price shown. See web or call for volume pricing.	0.21" dia.		13.4 dB/100ft	53 W		
12"	24"	36"	48"	60"	72"	Custom Len.
\$57.48	\$60.68	\$63.87	\$72.55	\$70.23	\$79.53	See Web
RG225/U Coax, 50 Ohm						
Part No. <a href="#">PE34194</a>	Cable Dia.		Attn. @ 1 GHz	Power @ 1 GHz		
1 piece price shown. See web or call for volume pricing.	0.43" dia.		1,700 W			
12"	24"	36"	48"	60"	72"	Custom Len.
\$95.84	\$129.86	\$165.20	\$200.51	\$235.85	\$271.19	See Web
RG316/U Coax, 50 Ohm						
Part No. <a href="#">PE33534</a>	Cable Dia.		Attn. @ 1 GHz	Power @ 1 GHz		
1 piece price shown. See web or call for volume pricing.	0.098" dia.		38 dB/100ft	160 W		
12"	24"	36"	48"	60"	72"	Custom Len.
\$74.46	\$77.64	\$80.82	\$84.00	\$92.95	\$90.33	See Web
RG316-DS Coax, 50 Ohm						
Part No. <a href="#">PE34198</a>	Cable Dia.		Attn. @ 1 GHz	Power @ 1 GHz		
1 piece price shown. See web or call for volume pricing.	0.114" dia.		26.1 dB/100ft	160 W		
12"	24"	36"	48"	60"	72"	Custom Len.
\$70.11	\$73.35	\$76.58	\$79.80	\$83.02	\$86.21	See Web
RG393/U Coax, 50 Ohm						
Part No. <a href="#">PE33530</a>	Cable Dia.		Attn. @ 1 GHz	Power @ 1 GHz		
1 piece price shown. See web or call for volume pricing.	0.39" dia.		7.5 dB/100ft	1,700 W		
12"	24"	36"	48"	60"	72"	Custom Len.
\$80.19	\$97.19	\$112.61	\$129.38	\$146.14	\$162.92	See Web
RG400/U Coax, 50 Ohm						
Part No. <a href="#">PE3227</a>	Cable Dia.		Attn. @ 1 GHz	Power @ 1 GHz		
1 piece price shown. See web or call for volume pricing.	0.195" dia.		14.7 dB/100ft	600 W		
12"	24"	36"	48"	60"	72"	Custom Len.
\$75.01	\$83.15	\$84.77	\$99.88	\$100.11	\$114.84	See Web
PE-P141 Coax, 50 Ohm						
Part No. <a href="#">PE3C3255</a>	Cable Dia.		Attn. @ 1 GHz	Power @ 1 GHz		
1 piece price shown. See web or call for volume pricing.	0.163" dia.		11.2 dB/100ft	550 W		
12"	24"	36"	48"	60"	50CM	Custom Len.
\$91.65	\$103.76	\$114.28	\$126.23	\$138.18	\$99.41	See Web
M17/60-RG142-27478 Coax, 50 Ohm						
Part No. <a href="#">PE3M0010</a>	Cable Dia.		Attn. @ 1 GHz	Power @ 1 GHz		
1 piece price shown. See web or call for volume pricing.	0.195" dia.		36"	48"	Custom Len.	
12"	18"	24"	30"			
\$179.33	\$182.28	\$185.24	\$188.20	\$191.16	\$197.07	See Web
M17/84-RG223-0XDS2 Coax, 50 Ohm						
Part No. <a href="#">PE3M0038</a>	Cable Dia.		Attn. @ 1 GHz	Power @ 1 GHz		
1 piece price shown. See web or call for volume pricing.	0.212" dia.		36"	48"	Custom Len.	
12"	18"	24"	30"			
\$183.99	\$189.28	\$194.58	\$199.85	\$205.15	\$215.73	See Web
M17/128-RG400-27478 Coax, 50 Ohm						
Part No. <a href="#">PE3M0066</a>	Cable Dia.		Attn. @ 1 GHz	Power @ 1 GHz		
1 piece price shown. See web or call for volume pricing.	0.195" dia.		36"	48"	Custom Len.	
12"	18"	24"	30"			
\$180.94	\$184.67	\$188.46	\$192.23	\$196.00	\$203.52	See Web
Standard Semi-Rigid Cable Assemblies						
PE-047SR Coax, 50 Ohm						
Part No. <a href="#">PE34152</a>	Cable Dia.		Attn. @ 1 GHz	Power @ 1 GHz		
1 piece price shown. See web or call for volume pricing.	40 dB/100ft		32 W			
6"	12"	18"	24"	36"	48"	Custom Len.
\$108.83	\$114.23	\$119.62	\$124.97	\$135.77	\$146.51	See Web
PE-SR047AL Coax, 50 Ohm						
Part No. <a href="#">PE34154</a>	Cable Dia.		Attn. @ 1 GHz	Power @ 1 GHz		
1 piece price shown. See web or call for volume pricing.	0.047" dia.		41 dB/100ft	32 W		
6"	12"	18"	24"	36"	48"	Custom Len.
\$108.25	\$112.99	\$117.80	\$122.55	\$132.06	\$141.62	See Web
PE-SR042AL Coax, 50 Ohm						
Part No. <a href="#">PE34158</a>	Cable Dia.		Attn. @ 1 GHz	Power @ 1 GHz		
1 piece price shown. See web or call for volume pricing.	0.141" dia.		13 dB/100ft	450 W		
6"	12"	18"	24"	36"	48"	Custom Len.
\$103.00	\$103.00	\$106.68	\$111.78	\$121.98	\$132.18	See Web

PE-SR405AL Coax, 50 Ohm						
Part No. <a href="#">PE34161</a>	Cable Dia.		Attn. @ 1 GHz	Power @ 1 GHz		
1 piece price shown. See web or call for volume pricing.	23 dB/100ft		130 W			
6"	12"	18"	24"	36"	48"	Custom Len.
\$107.13	\$110.19	\$114.74	\$119.23	\$128.36	\$137.40	See Web
RG401/U Coax, 50 Ohm						
Part No. <a href="#">PE3983</a>	Cable Dia.		Attn. @ 1 GHz	Power @ 1 GHz		
1 piece price shown. See web or call for volume pricing.	7.5 dB/100ft		870 W			
6"	12"	18"	24"	36"	48"	Custom Len.
\$132.81	\$132.81	\$144.70	\$156.59	\$180.39	\$204.18	See Web
RG402/U Coax, 50 Ohm						
Part No. <a href="#">PE3830</a>	Cable Dia.		Attn. @ 1 GHz	Power @ 1 GHz		
1 piece price shown. See web or call for volume pricing.	12 dB/100ft		650 W			
6"	12"	18"	24"	36"	48"	Custom Len.
\$93.12	\$93.12	\$97.15	\$107.30	\$107.68	\$115.58	See Web
PE-SR401AL-STRAIGHT Coax, 50 Ohm						
Part No. <a href="#">PE3C3286</a>	Cable Dia.		Attn. @ 1 GHz	Power @ 1 GHz		
1 piece price shown. See web or call for volume pricing.	12 dB/100ft		650 W			
12"	50CM	24"	36"	100CM	48"	Custom Len.
\$81.90	\$82.61	\$85.62	\$93.96	\$96.31	\$102.31	See Web
RG405/U Coax, 50 Ohm						
Part No. <a href="#">PE3922</a>	Cable Dia.		Attn. @ 1 GHz	Power @ 1 GHz		
1 piece price shown. See web or call for volume pricing.	22 dB/100ft		130 W			
6"	12"	18"	24"	36"	48"	Custom Len.
\$117.78	\$114.80	\$125.72	\$122.26	\$129.71	\$137.16	See Web
PE-SR401AL-STRAIGHT Coax, 50 Ohm						
Part No. <a href="#">PE3993</a>	Cable Dia.		Attn. @ 1 GHz	Power @ 1 GHz		
1 piece price shown. See web or call for volume pricing.	0.25" dia.		8 dB/100ft	1,400 W		
6"	12"	18"	24"	36"	48"	Custom Len.
\$111.76	\$121.33	\$130.83	\$140.39	\$159.45	\$178.52	See Web
N MALE TO N FEMALE 4 HOLE FLANGE						
SEE MOUNTING HOLE SECTION ON PAGE 409						
Low Loss Flexible Cable Assemblies						
LMR-195 Coax, 50 Ohm						
Part No. <a href="#">PE3W02012</a>	Cable Dia.		Attn. @ 1 GHz	Power @ 1 GHz		
1 piece price shown. See web or call for volume pricing.	0.195" dia.		11.8 dB/100ft	650 W		
12"	24"	36"	48"	60"	50CM	Custom Len.
\$52.04	\$52.85	\$53.65	\$54.46	\$54.76	\$52.56	See Web
N MALE TO 4.1/9.5 MINI DIN MALE						
Low PIM Corrugated Cable Assemblies						
SPP-250-LLPL Coax, 50 Ohm						
Part No. <a href="#">PE3C4140</a>	Cable Dia.		Attn. @ 1 GHz	Power @ 1 GHz		
1 piece price shown. See web or call for volume pricing.	0.28" dia.		5.5 dB/100ft	650 W		
12"	24"	36"	48"	60"	50CM	Custom Len.
\$99.02	\$105.15	\$109.74	\$115.79	\$121.84	\$102.94	See Web
N MALE TO 4.3-10 MALE						
Low PIM Corrugated Cable Assemblies						
SPP-250-LLPL Coax, 50 Ohm						
Part No. <a href="#">PE3C4141</a>	Cable Dia.		Attn. @ 1 GHz	Power @ 1 GHz		
1 piece price shown. See web or call for volume pricing.	0.28" dia.		5.5 dB/100ft	650 W		
"	12"	24"	36"	48"	60"	Custom Len.
Call	\$99.02	\$105.15	\$109.74	\$115.79	\$121.84	See Web
N MALE TO 7/16 DIN MALE						
Low Loss Flexible Cable Assemblies						
PE-C195 Coax, 50 Ohm						
Part No. <a href="#">PE39143</a>	Cable Dia.		Attn. @ 1 GHz	Power @ 1 GHz		
1 piece price shown. See web or call for volume pricing.	0.195" dia.		11.3 dB/100ft	150 W		
12"	24"	36"	48"	60"	-	Custom Len.
\$136.66	\$137.40	\$138.11	\$138.83	\$139.54	-	See Web
PE-C600 Coax, 50 Ohm						
Part No. <a href="#">PE38436</a>	Cable Dia.		Attn. @ 1 GHz	Power @ 1 GHz		
1 piece price shown. See web or call for volume pricing.	0.59" dia.		2.7 dB/100ft	900 W		
36"	48"	60"	72"	120"	-	Custom Len.
\$132.25	\$138.63	\$144.99	\$149.18	\$176.88	-	See Web
LMR-400 Coax, 50 Ohm						
Part No. <a href="#">PE3W03803</a>	Cable Dia.		Attn. @ 1 GHz	Power @ 1 GHz		
1 piece price shown. See web or call for volume pricing.	0.405" dia.		4.25 dB/100ft	650 W		
12"	24"	36"	48"	60"	50CM	Custom Len.
\$93.76	\$95.23	\$96.71	\$98.18	\$99.66	\$94.71	See Web

Cable Assemblies

See Our Website For Current Pricing & Real-Time Stock Availability!

For Custom Lengths, Metric Lengths or Special Configurations, Please call (949) 261-1920



Technical Support  
+1 (949) 261-1920



Same-Day Shipping,  
Even Custom Cable Assemblies

For our complete selection of cable assemblies, please visit our website

Cable Assemblies

See Our Website For Current Pricing & Real-Time Stock Availability!

Low PIM Formable Cable Assemblies						
PE-SR401FLJ Low PIM Coax, 50 Ohm						
Part No.	PE3C2012			Cable Dia.	Attn. @ 1 GHz	Power @ 1 GHz
1 piece price shown. See web or call for volume pricing.						
100CM	200CM	800CM	-	-	-	Custom Len.
\$166.50	\$200.98	Call	-	-	-	See Web
PE-SR402FLJ Low PIM Coax, 50 Ohm						
Part No.	PE3C2002			Cable Dia.	Attn. @ 1 GHz	Power @ 1 GHz
1 piece price shown. See web or call for volume pricing.						
100CM	200CM	300CM	-	-	-	Custom Len.
\$121.23	\$146.05	Call	-	-	-	See Web
Low PIM Corrugated Cable Assemblies						
SPP-250-LLPL Coax, 50 Ohm						
Part No.	PE3C4132			Cable Dia.	Attn. @ 1 GHz	Power @ 1 GHz
1 piece price shown. See web or call for volume pricing.						
12"	24"	36"	48"	60"	50CM	Custom Len.
\$101.58	\$107.71	\$112.27	\$118.32	\$124.37	\$105.50	See Web
Standard Formable Cable Assemblies						
PE-SR401FL Coax, 50 Ohm						
Part No.	PE36178			Cable Dia.	Attn. @ 1 GHz	Power @ 1 GHz
1 piece price shown. See web or call for volume pricing.						
12"	24"	36"	48"	60"	72"	Custom Len.
\$232.26	\$248.47	\$264.66	\$280.87	\$297.05	\$313.27	See Web
PE-SR402FL Coax, 50 Ohm						
Part No.	PE35965			Cable Dia.	Attn. @ 1 GHz	Power @ 1 GHz
1 piece price shown. See web or call for volume pricing.						
12"	24"	36"	48"	60"	72"	Custom Len.
\$205.53	\$213.45	\$221.32	\$229.28	\$237.14	\$245.07	See Web
Standard Flexible Cable Assemblies						
RG8A/U Coax, 50 Ohm						
Part No.	PE35284			Cable Dia.	Attn. @ 1 GHz	Power @ 1 GHz
1 piece price shown. See web or call for volume pricing.						
12"	24"	36"	48"	60"	72"	Custom Len.
\$177.37	\$180.44	\$194.68	\$186.58	\$189.65	\$192.72	See Web
RG58C/U Coax, 50 Ohm						
Part No.	PE3207			Cable Dia.	Attn. @ 1 GHz	Power @ 1 GHz
1 piece price shown. See web or call for volume pricing.						
12"	24"	36"	48"	60"	72"	Custom Len.
\$155.51	\$156.30	\$157.10	\$157.90	\$158.69	\$159.49	See Web
RG142B/U Coax, 50 Ohm						
Part No.	PE3216			Cable Dia.	Attn. @ 1 GHz	Power @ 1 GHz
1 piece price shown. See web or call for volume pricing.						
12"	24"	36"	48"	60"	72"	Custom Len.
\$85.36	\$91.68	\$103.86	\$104.27	\$109.04	\$115.25	See Web
RG213/U Coax, 50 Ohm						
Part No.	PE34098			Cable Dia.	Attn. @ 1 GHz	Power @ 1 GHz
1 piece price shown. See web or call for volume pricing.						
12"	24"	36"	48"	60"	72"	Custom Len.
\$176.13	\$177.92	\$179.73	\$181.52	\$183.33	\$196.58	See Web
RG214/U Coax, 50 Ohm						
Part No.	PE3218			Cable Dia.	Attn. @ 1 GHz	Power @ 1 GHz
1 piece price shown. See web or call for volume pricing.						
12"	24"	36"	48"	60"	72"	Custom Len.
\$180.69	\$188.63	\$204.78	\$213.72	\$222.32	\$220.40	See Web
RG217/U Coax, 50 Ohm						
Part No.	PE36170			Cable Dia.	Attn. @ 1 GHz	Power @ 1 GHz
1 piece price shown. See web or call for volume pricing.						
12"	24"	36"	48"	60"	72"	Custom Len.
\$213.98	\$218.79	\$223.62	\$228.44	\$233.23	\$238.05	See Web
RG218/U Coax, 50 Ohm						
Part No.	PE36172			Cable Dia.	Attn. @ 1 GHz	Power @ 1 GHz
1 piece price shown. See web or call for volume pricing.						
12"	24"	36"	48"	60"	72"	Custom Len.
\$296.94	\$309.05	\$321.08	\$355.17	\$345.29	\$357.39	See Web
RG223/U Coax, 50 Ohm						
Part No.	PE33144			Cable Dia.	Attn. @ 1 GHz	Power @ 1 GHz
1 piece price shown. See web or call for volume pricing.						
12"	24"	36"	48"	60"	72"	Custom Len.
\$82.29	\$85.48	\$88.66	\$91.86	\$95.03	\$98.22	See Web
RG393/U Coax, 50 Ohm						
Part No.	PE34357			Cable Dia.	Attn. @ 1 GHz	Power @ 1 GHz
1 piece price shown. See web or call for volume pricing.						
12"	24"	36"	48"	60"	72"	Custom Len.
\$190.13	\$206.90	\$223.68	\$240.44	\$274.07	\$273.98	See Web
RG400/U Coax, 50 Ohm						
Part No.	PE34359			Cable Dia.	Attn. @ 1 GHz	Power @ 1 GHz
1 piece price shown. See web or call for volume pricing.						
12"	24"	36"	48"	60"	72"	Custom Len.
\$94.04	\$101.70	\$107.85	\$115.41	\$122.97	\$130.51	See Web
PE-FF430 Coax, 50 Ohm						
Part No.	PE3C4000			Cable Dia.	Attn. @ 1 GHz	Power @ 1 GHz
1 piece price shown. See web or call for volume pricing.						
60"	144"	-	-	-	-	Custom Len.
\$657.16	\$861.72	-	-	-	-	See Web

Standard Semi-Rigid Cable Assemblies						
RG402/U Coax, 50 Ohm						
Part No.	PE35963			Cable Dia.	Attn. @ 1 GHz	Power @ 1 GHz
1 piece price shown. See web or call for volume pricing.						
12"	24"	36"	48"	60"	72"	Custom Len.
\$205.25	\$212.92	\$220.62	\$228.27	\$235.97	\$243.66	See Web
N MALE TO 7/16 DIN MALE RIGHT ANGLE						
Low PIM Corrugated Cable Assemblies						
SPP-250-LLPL Coax, 50 Ohm						
Part No.	PE3C4136			Cable Dia.	Attn. @ 1 GHz	Power @ 1 GHz
1 piece price shown. See web or call for volume pricing.						
12"	24"	36"	48"	60"	50CM	Custom Len.
\$124.12	\$118.89	\$124.94	\$130.98	\$137.03	\$116.71	See Web
N MALE TO 7/16 DIN FEMALE						
Low PIM Formable Cable Assemblies						
PE-SR401FLJ Low PIM Coax, 50 Ohm						
Part No.	PE3C2014			Cable Dia.	Attn. @ 1 GHz	Power @ 1 GHz
1 piece price shown. See web or call for volume pricing.						
100CM	200CM	-	-	-	-	Custom Len.
\$159.38	\$190.16	-	-	-	-	See Web
PE-SR402FLJ Low PIM Coax, 50 Ohm						
Part No.	PE3C2005			Cable Dia.	Attn. @ 1 GHz	Power @ 1 GHz
1 piece price shown. See web or call for volume pricing.						
100CM	200CM	-	-	-	-	Custom Len.
\$130.00	\$154.79	-	-	-	-	See Web
Standard Flexible Cable Assemblies						
PE-FF430 Coax, 50 Ohm						
Part No.	PE3C4001			Cable Dia.	Attn. @ 1 GHz	Power @ 1 GHz
1 piece price shown. See web or call for volume pricing.						
60"	144"	-	-	-	-	Custom Len.
\$928.81	\$1,157.97	-	-	-	-	See Web
N MALE TO BNC MALE						
Low Loss Flexible Cable Assemblies						
PE-C195 Coax, 50 Ohm						
Part No.	PE36065			Cable Dia.	Attn. @ 1 GHz	Power @ 1 GHz
1 piece price shown. See web or call for volume pricing.						
12"	24"	36"	48"	60"	-	Custom Len.
\$40.28	\$38.09	\$42.01	\$39.67	\$43.81	-	See Web
PE-C240 Coax, 50 Ohm						
Part No.	PE35269			Cable Dia.	Attn. @ 1 GHz	Power @ 1 GHz
1 piece price shown. See web or call for volume pricing.						
12"	24"	36"	48"	60"	-	Custom Len.
\$56.54	\$57.78	\$56.52	\$60.36	\$62.67	-	See Web
LMR-240-UF Coax, 50 Ohm						
Part No.	PE3C2404			Cable Dia.	Attn. @ 1 GHz	Power @ 1 GHz
1 piece price shown. See web or call for volume pricing.						
12"	24"	36"	48"	60"	50CM	Custom Len.
\$42.53	\$42.35	\$43.82	\$45.28	\$46.74	\$41.82	See Web
Standard Flexible Cable Assemblies						
RG8A/U Coax, 50 Ohm						
Part No.	PE3252			Cable Dia.	Attn. @ 1 GHz	Power @ 1 GHz
1 piece price shown. See web or call for volume pricing.						
12"	24"	36"	48"	60"	72"	Custom Len.
\$71.94	\$74.99	\$83.00	\$80.98	\$90.02	\$87.00	See Web
RG58C/U Coax, 50 Ohm						
Part No.	PE3042			Cable Dia.	Attn. @ 1 GHz	Power @ 1 GHz
1 piece price shown. See web or call for volume pricing.						
12"	24"	36"	48"	60"	72"	Custom Len.
\$44.90	\$45.73	\$46.54	\$47.35	\$48.18	\$49.00	See Web
RG142B/U Coax, 50 Ohm						
Part No.	PE3W00140			Cable Dia.	Attn. @ 1 GHz	Power @ 1 GHz
1 piece price shown. See web or call for volume pricing.						
12"	24"	36"	48"	60"	50CM	Custom Len.
\$45.67	\$52.22	\$58.23	\$64.71	\$71.20	\$49.86	See Web
RG174A/U Coax, 50 Ohm						
Part No.	PE3C3378			Cable Dia.	Attn. @ 1 GHz	Power @ 1 GHz
1 piece price shown. See web or call for volume pricing.						
6"	12"	18"	24"	36"	48"	Custom Len.
\$45.73	\$45.99	\$46.23	\$51.22	\$46.96	\$52.55	See Web
RG188A/U Coax, 50 Ohm						
Part No.	PE3C3379			Cable Dia.	Attn. @ 1 GHz	Power @ 1 GHz
1 piece price shown. See web or call for volume pricing.						
12"	24"	36"	48"	60"	72"	Custom Len.
\$47.78	\$50.09	\$52.39	\$54.13	\$56.43	\$58.64	See Web

\*Coax Performance at 1 GHz Notes: Cable assembly max frequency may be lower than connector or coax max frequency



For our complete selection of cable assemblies, please visit our website

RG213/U Coax, 50 Ohm						
Part No. <a href="#">PE3750</a>	Cable Dia.			Attn. @ 1 GHz	Power @ 1 GHz	
1 piece price shown. See web or call for volume pricing.	0.405" dia.			8 dB/100ft	190 W	
12"	24"	36"	48"	60"	72"	Custom Len.
\$81.02	\$82.97	\$84.95	\$81.91	\$83.75	\$91.04	See Web

63

RG214/U Coax, 50 Ohm						
Part No. <a href="#">PE3097</a>	Cable Dia.			Attn. @ 1 GHz	Power @ 1 GHz	
1 piece price shown. See web or call for volume pricing.	0.425" dia.			7.32 dB/100ft	170 W	
12"	24"	36"	48"	60"	72"	Custom Len.
\$86.76	\$95.31	\$103.87	\$111.34	\$112.48	\$128.55	See Web

64

RG223/U Coax, 50 Ohm						
Part No. <a href="#">PE3476</a>	Cable Dia.			Attn. @ 1 GHz	Power @ 1 GHz	
1 piece price shown. See web or call for volume pricing.	0.21" dia.			13.4 dB/100ft	53 W	
12"	24"	36"	48"	60"	72"	Custom Len.
\$44.37	\$47.83	\$51.28	\$54.44	\$57.93	\$61.42	See Web

65

RG316/U Coax, 50 Ohm						
Part No. <a href="#">PE3C3380</a>	Cable Dia.			Attn. @ 1 GHz	Power @ 1 GHz	
1 piece price shown. See web or call for volume pricing.	0.102" dia.			38 dB/100ft	160 W	
12"	24"	36"	48"	60"	72"	Custom Len.
\$55.28	\$58.71	\$62.14	\$61.67	\$64.85	\$72.79	See Web

66

RG393/U Coax, 50 Ohm						
Part No. <a href="#">PE3254</a>	Cable Dia.			Attn. @ 1 GHz	Power @ 1 GHz	
1 piece price shown. See web or call for volume pricing.	0.39" dia.			7.5 dB/100ft	1,700 W	
12"	24"	36"	48"	60"	72"	Custom Len.
\$89.84	\$101.91	\$117.41	\$134.34	\$151.26	\$179.24	See Web

67

RG400/U Coax, 50 Ohm						
Part No. <a href="#">PE3874</a>	Cable Dia.			Attn. @ 1 GHz	Power @ 1 GHz	
1 piece price shown. See web or call for volume pricing.	0.195" dia.			14.7 dB/100ft	650 W	
12"	24"	36"	48"	60"	72"	Custom Len.
\$59.53	\$67.67	\$75.80	\$84.41	\$92.68	\$100.98	See Web

68

LMR-240 Coax, 50 Ohm						
Part No. <a href="#">PE3CA1074</a>	Cable Dia.			Attn. @ 1 GHz	Power @ 1 GHz	
1 piece price shown. See web or call for volume pricing.	0.24" dia.					
12"	24"	36"	48"	60"	72"	Custom Len.
Call	Call	Call	Call	Call	Call	See Web

69

LMR-400-UF Coax, 50 Ohm						
Part No. <a href="#">PE3CA1075</a>	Cable Dia.			Attn. @ 1 GHz	Power @ 1 GHz	
1 piece price shown. See web or call for volume pricing.	0.405" dia.					
12"	24"	36"	48"	60"	72"	Custom Len.
Call	Call	Call	Call	Call	Call	See Web

70

RG55B/U Coax, 53 Ohm						
Part No. <a href="#">PE3477</a>	Cable Dia.			Attn. @ 1 GHz	Power @ 1 GHz	
1 piece price shown. See web or call for volume pricing.	0.202" dia.			16.5 dB/100ft	53 W	
12"	24"	36"	48"	60"	72"	Custom Len.
\$42.61	\$45.11	\$47.59	\$53.95	\$52.56	\$54.54	See Web

71

**N MALE TO BNC MALE RIGHT ANGLE**



**Low Loss Flexible Cable Assemblies**

LMR-240-UF Coax, 50 Ohm						
Part No. <a href="#">PE3W04585</a>	Cable Dia.			Attn. @ 1 GHz	Power @ 1 GHz	
1 piece price shown. See web or call for volume pricing.	0.24" dia.			9.19 dB/100ft		
12"	24"	36"	48"	60"	50CM	Custom Len.
\$54.54	\$55.97	\$56.68	\$58.12	\$59.55	\$54.74	See Web

72

**N MALE TO BNC FEMALE BULKHEAD**



SEE MOUNTING HOLE SECTION ON PAGE 409

**Standard Flexible Cable Assemblies**

RG400/U Coax, 50 Ohm						
Part No. <a href="#">PE34882</a>	Cable Dia.			Attn. @ 1 GHz	Power @ 1 GHz	
1 piece price shown. See web or call for volume pricing.	0.195" dia.			14.7 dB/100ft	650 W	
12"	24"	36"	48"	60"		Custom Len.
\$72.40	\$80.52	\$88.66	\$97.26	\$105.54		See Web

73

**N MALE TO C FEMALE**



**Standard Flexible Cable Assemblies**

RG142B/U Coax, 50 Ohm						
Part No. <a href="#">PE3W06365</a>	Cable Dia.			Attn. @ 1 GHz	Power @ 1 GHz	
1 piece price shown. See web or call for volume pricing.	0.195" dia.			12.9 dB/100ft		
12"	24"	36"	48"	60"	50CM	Custom Len.
\$122.79	\$129.18	\$135.58	\$141.98	\$148.38	\$126.88	See Web

74

**N MALE TO GR874 SEXLESS**



**Standard Flexible Cable Assemblies**

RG214/U Coax, 50 Ohm						
Part No. <a href="#">PE3133</a>	Cable Dia.			Attn. @ 1 GHz	Power @ 1 GHz	
1 piece price shown. See web or call for volume pricing.	0.425" dia.			7.32 dB/100ft	170 W	
12"	24"	36"	48"	60"	72"	Custom Len.
\$146.82	\$154.83	\$162.83	\$170.84	\$178.82	\$186.85	See Web

75

RG223/U Coax, 50 Ohm						
Part No. <a href="#">PE3170</a>	Cable Dia.			Attn. @ 1 GHz	Power @ 1 GHz	
1 piece price shown. See web or call for volume pricing.	0.209" dia.			13.41 dB/100ft	50 W	
12"	24"	36"	48"	60"	72"	Custom Len.
\$62.99	\$66.21	\$69.37	\$72.61	\$75.86	\$79.03	See Web

76

**N MALE TO MCX PLUG RIGHT ANGLE**



**Standard Flexible Cable Assemblies**

RG316-DS Coax, 50 Ohm						
Part No. <a href="#">PE35276</a>	Cable Dia.			Attn. @ 1 GHz	Power @ 1 GHz	
1 piece price shown. See web or call for volume pricing.	0.114" dia.			26.1 dB/100ft	160 W	
12"	24"	36"	48"	60"	50CM	Custom Len.
\$75.29	\$78.80	\$82.31	\$85.82	\$89.33	\$74.03	See Web

77

**N MALE TO MINI UHF MALE**



**Standard Flexible Cable Assemblies**

RG58C/U Coax, 50 Ohm						
Part No. <a href="#">PE3282</a>	Cable Dia.			Attn. @ 1 GHz	Power @ 1 GHz	
1 piece price shown. See web or call for volume pricing.	0.195" dia.			20 dB/100ft	44 W	
12"	24"	36"	48"	60"	72"	Custom Len.
\$45.36	\$49.89	\$50.80	\$47.82	\$52.67	\$49.45	See Web

78

RG142B/U Coax, 50 Ohm						
Part No. <a href="#">PE3285</a>	Cable Dia.			Attn. @ 1 GHz	Power @ 1 GHz	
1 piece price shown. See web or call for volume pricing.	0.195" dia.			12.9 dB/100ft		
12"	24"	36"	48"	60"	72"	Custom Len.
\$47.79	\$54.03	\$60.71	\$67.77	\$74.60	\$81.42	See Web

79

RG223/U Coax, 50 Ohm						
Part No. <a href="#">PE3280</a>	Cable Dia.			Attn. @ 1 GHz	Power @ 1 GHz	
1 piece price shown. See web or call for volume pricing.	0.209" dia.			13.41 dB/100ft	50 W	
12"	24"	36"	48"	60"	72"	Custom Len.
\$39.59	\$42.80	\$46.04	\$49.32	\$55.54	\$55.27	See Web

80

RG303/U Coax, 50 Ohm						
Part No. <a href="#">PE3W04230</a>	Cable Dia.			Attn. @ 1 GHz	Power @ 1 GHz	
1 piece price shown. See web or call for volume pricing.	0.17" dia.			14 dB/100ft	650 W	
12"	24"	36"	48"	60"	50CM	Custom Len.
\$39.01	\$46.62	\$54.24	\$61.32	\$68.88	\$43.89	See Web

81

RG400/U Coax, 50 Ohm						
Part No. <a href="#">PE3288</a>	Cable Dia.			Attn. @ 1 GHz	Power @ 1 GHz	
1 piece price shown. See web or call for volume pricing.	0.195" dia.			14.7 dB/100ft	600 W	
12"	24"	36"	48"	60"	72"	Custom Len.
\$56.54	\$61.00	\$68.67	\$76.33	\$84.00	\$91.66	See Web

82

**N MALE TO QMA MALE**



**Corrugated Cable Assemblies**

SPP-250-LLPL Coax, 50 Ohm						
Part No. <a href="#">PE3C5868</a>	Cable Dia.			Attn. @ 1 GHz	Power @ 1 GHz	
1 piece price shown. See web or call for volume pricing.	0.28" dia.			5.5 dB/100ft	650 W	
12"	24"	36"	48"	60"	50CM	Custom Len.
\$82.91	\$89.04	\$95.17	\$101.31	\$107.44	\$86.84	See Web

83

**N MALE TO QMA MALE RIGHT ANGLE**



**Low Loss Flexible Cable Assemblies**

LMR-195 Coax, 50 Ohm						
Part No. <a href="#">PE3C0049</a>	Cable Dia.			Attn. @ 1 GHz	Power @ 1 GHz	
1 piece price shown. See web or call for volume pricing.	0.195" dia.			11.8 dB/100ft		
12"	24"	36"	48"	60"	-	Custom Len.
\$55.37	\$56.18	\$57.02	\$57.88	\$58.71	-	See Web

84

**Low PIM Corrugated Cable Assemblies**

SPP-250-LLPL Coax, 50 Ohm						
Part No. <a href="#">PE3C5874</a>	Cable Dia.			Attn. @ 1 GHz	Power @ 1 GHz	
1 piece price shown. See web or call for volume pricing.	0.28" dia.					
12"	24"	36"	48"	60"	50CM	Custom Len.
\$85.29	\$91.43	\$97.56	\$103.70	\$108.30	\$89.23	See Web

85

**N MALE TO QMA FEMALE**



**Low PIM Corrugated Cable Assemblies**

Continued on Next Page

For Custom Lengths, Metric Lengths or Special Configurations, Please call (949) 261-1920



Technical Support  
+1 (949) 261-1920



Same-Day Shipping,  
Even Custom Cable Assemblies

Cable Assemblies





See Our Website For Current Pricing & Real-Time Stock Availability!



For our complete selection of cable assemblies, please visit our website

Cable Assemblies

See Our Website For Current Pricing & Real-Time Stock Availability!

SPP-250-LLPL Coax, 50 Ohm						
Part No. <a href="#">PE3C5862</a>	Cable Dia.			Attn. @ 1 GHz	Power @ 1 GHz	86
1 piece price shown. See web or call for volume pricing.	0.28" dia.					
12"	24"	36"	48"	60"	50CM	Custom Len.
\$78.96	\$85.09	\$91.22	\$97.36	\$103.49	\$82.88	See Web
<b>N MALE TO QN MALE</b>						
						
Low Loss Flexible Cable Assemblies						
PE-C195 Coax, 50 Ohm						
Part No. <a href="#">PE38453</a>	Cable Dia.			Attn. @ 1 GHz	Power @ 1 GHz	87
1 piece price shown. See web or call for volume pricing.	0.195" dia.			11.3 dB/100ft	150 W	
12"	24"	36"	48"	60"	72"	Custom Len.
\$70.35	\$71.12	\$71.90	\$77.18	\$73.49	\$78.94	See Web
Standard Flexible Cable Assemblies						
RG58C/U Coax, 50 Ohm						
Part No. <a href="#">PE38452</a>	Cable Dia.			Attn. @ 1 GHz	Power @ 1 GHz	88
1 piece price shown. See web or call for volume pricing.	0.195" dia.			20 dB/100ft	44 W	
12"	24"	36"	48"	60"	72"	Custom Len.
\$69.06	\$64.25	\$65.14	\$71.50	\$72.28	\$73.07	See Web
RG213/U Coax, 50 Ohm						
Part No. <a href="#">PE38450</a>	Cable Dia.			Attn. @ 1 GHz	Power @ 1 GHz	89
1 piece price shown. See web or call for volume pricing.	0.405" dia.			8 dB/100ft	190 W	
12"	24"	36"	48"	60"	72"	Custom Len.
\$113.32	\$115.14	\$116.96	\$118.77	\$120.55	\$122.36	See Web
RG223/U Coax, 50 Ohm						
Part No. <a href="#">PE38451</a>	Cable Dia.			Attn. @ 1 GHz	Power @ 1 GHz	90
1 piece price shown. See web or call for volume pricing.	0.21" dia.			13.4 dB/100ft	53 W	
12"	24"	36"	48"	60"	72"	Custom Len.
\$73.00	\$76.18	\$79.37	\$82.57	\$85.76	\$88.94	See Web
<b>N MALE TO QN MALE RIGHT ANGLE</b>						
						
Low Loss Flexible Cable Assemblies						
PE-C195 Coax, 50 Ohm						
Part No. <a href="#">PE38490</a>	Cable Dia.			Attn. @ 1 GHz	Power @ 1 GHz	91
1 piece price shown. See web or call for volume pricing.	0.195" dia.			11.3 dB/100ft	150 W	
12"	24"	36"	48"	60"	72"	Custom Len.
\$74.40	\$75.19	\$75.97	\$76.75	\$77.54	\$78.33	See Web
LMR-195 Coax, 50 Ohm						
Part No. <a href="#">PE3C0059</a>	Cable Dia.			Attn. @ 1 GHz	Power @ 1 GHz	92
1 piece price shown. See web or call for volume pricing.	0.195" dia.			11.8 dB/100ft		
12"	24"	36"	48"	60"		Custom Len.
\$65.95	\$66.74	\$67.49	\$68.25	\$69.02	-	See Web
Standard Flexible Cable Assemblies						
RG58C/U Coax, 50 Ohm						
Part No. <a href="#">PE38489</a>	Cable Dia.			Attn. @ 1 GHz	Power @ 1 GHz	93
1 piece price shown. See web or call for volume pricing.	0.195" dia.			20 dB/100ft	44 W	
12"	24"	36"	48"	60"	72"	Custom Len.
\$88.46	\$89.27	\$90.07	\$90.88	\$91.70	\$92.51	See Web
RG213/U Coax, 50 Ohm						
Part No. <a href="#">PE38491</a>	Cable Dia.			Attn. @ 1 GHz	Power @ 1 GHz	94
1 piece price shown. See web or call for volume pricing.	0.405" dia.			8 dB/100ft	190 W	
12"	24"	36"	48"	60"	72"	Custom Len.
\$100.00	\$101.86	\$103.68	\$105.53	\$107.31	\$107.67	See Web
RG223/U Coax, 50 Ohm						
Part No. <a href="#">PE38492</a>	Cable Dia.			Attn. @ 1 GHz	Power @ 1 GHz	95
1 piece price shown. See web or call for volume pricing.	0.21" dia.			13.4 dB/100ft	53 W	
12"	24"	36"	48"	60"	72"	Custom Len.
\$73.80	\$81.65	\$85.08	\$83.45	\$86.61	\$89.85	See Web
<b>N MALE TO SHV PLUG</b>						
						
Standard Flexible Cable Assemblies						
RG223/U Coax, 50 Ohm						
Part No. <a href="#">PE3W04051</a>	Cable Dia.			Attn. @ 1 GHz	Power @ 1 GHz	96
1 piece price shown. See web or call for volume pricing.	0.209" dia.			13.41 dB/100ft	50 W	
12"	24"	36"	48"	60"	50CM	Custom Len.
\$67.73	\$71.30	\$74.87	\$78.43	\$82.00	\$70.01	See Web
<b>N MALE TO SMA MALE</b>						
						
Low Loss Flexible Cable Assemblies						
PE-P142LL Coax, 50 Ohm						
Part No. <a href="#">PE3C0253</a>	Cable Dia.			Attn. @ 1 GHz	Power @ 1 GHz	97
1 piece price shown. See web or call for volume pricing.	0.32" dia.			7.2 dB/100ft		
60"	72"	120"	-	-	-	Custom Len.
\$395.79	\$435.11	\$675.13	-	-	-	See Web

PE-P160LL Coax, 50 Ohm						
Part No. <a href="#">PE3C5273</a>	Cable Dia.			Attn. @ 1 GHz	Power @ 1 GHz	98
1 piece price shown. See web or call for volume pricing.	0.16" dia.					
12"	24"	36"	48"	60"	50CM	Custom Len.
\$222.74	\$245.21	\$267.66	\$290.11	\$312.56	\$237.13	See Web
Low PIM Formable Cable Assemblies						
PE-SR402FLJ Low PIM Coax, 50 Ohm						
Part No. <a href="#">PE3C2006</a>	Cable Dia.			Attn. @ 1 GHz	Power @ 1 GHz	99
1 piece price shown. See web or call for volume pricing.	0.161" dia.					
30CM	45CM	50CM	-	100CM	150CM	Custom Len.
Call	Call	Call	-	\$84.33	Call	See Web
Low PIM Corrugated Cable Assemblies						
SPP-250-LLPL Coax, 50 Ohm						
Part No. <a href="#">PE3C5887</a>	Cable Dia.			Attn. @ 1 GHz	Power @ 1 GHz	1
1 piece price shown. See web or call for volume pricing.	0.28" dia.					
12"	24"	36"	48"	60"	50CM	Custom Len.
\$74.97	\$81.10	\$87.24	\$93.37	\$99.51	\$78.90	See Web
Part No. <a href="#">PE3C6213</a>	Cable Dia.			Attn. @ 1 GHz	Power @ 1 GHz	2
1 piece price shown. See web or call for volume pricing.	0.28" dia.			5.5 dB/100ft	650 W	
12"	24"	36"	48"	60"	50CM	Custom Len.
\$52.84	\$58.49	\$64.62	\$70.76	\$76.88	\$56.27	See Web
Low Loss Test Flexible Cable Assemblies						
PE-P300LL Coax, 50 Ohm						
Part No. <a href="#">PE332</a>	Cable Dia.			Attn. @ 1 GHz	Power @ 1 GHz	3
1 piece price shown. See web or call for volume pricing.	0.3" dia.			4.6 dB/100ft		
12"	24"	36"	48"	60"	600"	Custom Len.
\$285.63	\$313.74	\$397.52	\$369.99	\$400.71	Call	See Web
Part No. <a href="#">PE337</a>	Cable Dia.			Attn. @ 1 GHz	Power @ 1 GHz	4
1 piece price shown. See web or call for volume pricing.	0.3" dia.					
12"	24"	36"	48"	60"	72"	Custom Len.
\$275.96	\$304.08	\$332.20	\$360.33	\$388.43	\$423.28	See Web
Standard Flexible Cable Assemblies						
RG58C/U Coax, 50 Ohm						
Part No. <a href="#">PE3662</a>	Cable Dia.			Attn. @ 1 GHz	Power @ 1 GHz	5
1 piece price shown. See web or call for volume pricing.	0.195" dia.			20 dB/100ft	44 W	
12"	24"	36"	48"	60"	72"	Custom Len.
\$47.04	\$47.93	\$49.65	\$49.79	\$51.26	\$51.64	See Web
RG316/U Coax, 50 Ohm						
Part No. <a href="#">PE3234</a>	Cable Dia.			Attn. @ 1 GHz	Power @ 1 GHz	6
1 piece price shown. See web or call for volume pricing.	0.102" dia.			38 dB/100ft		
12"	24"	36"	48"	60"	72"	Custom Len.
\$54.04	\$57.48	\$62.13	\$64.55	\$68.49	\$71.55	See Web
PE-P141 Coax, 50 Ohm						
Part No. <a href="#">PE354</a>	Cable Dia.			Attn. @ 1 GHz	Power @ 1 GHz	7
1 piece price shown. See web or call for volume pricing.	0.163" dia.			11.2 dB/100ft	600 W	
12"	24"	36"	48"	60"	72"	Custom Len.
\$181.19	\$193.50	\$205.82	\$218.85	\$231.40	\$243.94	See Web
PE-FF430 Coax, 50 Ohm						
Part No. <a href="#">PE3C4008</a>	Cable Dia.			Attn. @ 1 GHz	Power @ 1 GHz	8
1 piece price shown. See web or call for volume pricing.	0.43" dia.					
60"	-	-	-	-	-	Custom Len.
\$747.71	-	-	-	-	-	See Web
PE-VNA-R Coax, 50 Ohm						
Part No. <a href="#">PE3VNA1805</a>	Cable Dia.			Attn. @ 1 GHz	Power @ 1 GHz	9
1 piece price shown. See web or call for volume pricing.	0.43" dia.					
24"	36"	48"	-	-	-	Custom Len.
\$943.23	\$996.04	\$1,048.84	-	-	-	See Web
M17/60-RG142-27478 Coax, 50 Ohm						
Part No. <a href="#">PE3M0014</a>	Cable Dia.			Attn. @ 1 GHz	Power @ 1 GHz	10
1 piece price shown. See web or call for volume pricing.	0.195" dia.					
12"	18"	24"	30"	36"	48"	Custom Len.
\$200.91	\$203.86	\$206.82	\$209.77	\$212.73	\$218.64	See Web
M17/84-RG223-0XDS2 Coax, 50 Ohm						
Part No. <a href="#">PE3M0042</a>	Cable Dia.			Attn. @ 1 GHz	Power @ 1 GHz	11
1 piece price shown. See web or call for volume pricing.	0.212" dia.					
12"	18"	24"	30"	36"	48"	Custom Len.
\$205.57	\$210.85	\$216.14	\$221.43	\$226.72	\$237.30	See Web
M17/128-RG400-27478 Coax, 50 Ohm						
Part No. <a href="#">PE3M0070</a>	Cable Dia.			Attn. @ 1 GHz	Power @ 1 GHz	12
1 piece price shown. See web or call for volume pricing.	0.195" dia.					
12"	18"	24"	30"	36"	48"	Custom Len.
\$202.51	\$206.27	\$210.03	\$213.79	\$217.56	\$225.08	See Web
Standard Semi-Rigid Cable Assemblies						
RG401/U Coax, 50 Ohm						
Part No. <a href="#">PE3W04229</a>	Cable Dia.			Attn. @ 1 GHz	Power @ 1 GHz	13
1 piece price shown. See web or call for volume pricing.	7.5 dB/100ft			1,400 W		
12"	24"	36"	48"	60"	50CM	Custom Len.
\$112.05	\$137.04	\$161.99	\$187.04	\$212.04	\$128.06	See Web
RG402/U Coax, 50 Ohm						
Part No. <a href="#">PE3887</a>	Cable Dia.			Attn. @ 1 GHz	Power @ 1 GHz	14
1 piece price shown. See web or call for volume pricing.	11.1 dB/100ft			450 W		
6"	12"	18"	24"	36"	48"	Custom Len.
\$75.94	\$74.18	\$84.42	\$88.72	\$90.24	\$98.26	See Web

\*Coax Performance at 1 GHz Notes: Cable assembly max frequency may be lower than connector or coax max frequency



For our complete selection of cable assemblies, please visit our website

**N MALE TO TNC MALE**



**Low Loss Flexible Cable Assemblies**

PE-C195 Coax, 50 Ohm						
Part No.	Cable Dia.		Attn. @ 1 GHz	Power @ 1 GHz		
Part No. <a href="#">PE35785</a>	0.195" dia.		11.3 dB/100ft	150 W		
1 piece price shown. See web or call for volume pricing.	12"	24"	36"	48"	60"	Custom Len.
\$41.98	\$42.78	\$46.22	\$47.14	\$48.02	-	See Web

PE-C200 Coax, 50 Ohm						
Part No.	Cable Dia.		Attn. @ 1 GHz	Power @ 1 GHz		
Part No. <a href="#">PE36067</a>	0.195" dia.		10.8 dB/100ft	170 W		
1 piece price shown. See web or call for volume pricing.	12"	24"	36"	48"	60"	Custom Len.
\$59.63	\$60.86	\$65.56	\$70.18	\$63.37	-	See Web

PE-C240 Coax, 50 Ohm						
Part No.	Cable Dia.		Attn. @ 1 GHz	Power @ 1 GHz		
Part No. <a href="#">PE36958</a>	0.24" dia.		9.2 dB/100ft	250 W		
1 piece price shown. See web or call for volume pricing.	12"	24"	36"	48"	60"	Custom Len.
\$54.35	\$59.96	\$61.20	\$62.50	\$63.79	-	See Web

PE-C400 Coax, 50 Ohm						
Part No.	Cable Dia.		Attn. @ 1 GHz	Power @ 1 GHz		
Part No. <a href="#">PE34801</a>	0.4" dia.		4.1 dB/100ft	550 W		
1 piece price shown. See web or call for volume pricing.	12"	24"	36"	48"	60"	Custom Len.
\$78.16	\$79.62	\$84.29	\$87.85	\$94.86	-	See Web

LMR-400 Coax, 50 Ohm						
Part No.	Cable Dia.		Attn. @ 1 GHz	Power @ 1 GHz		
Part No. <a href="#">PE3C0031</a>	0.405" dia.		4.25 dB/100ft	160 W		
1 piece price shown. See web or call for volume pricing.	12"	24"	36"	48"	60"	Custom Len.
\$69.97	\$71.47	\$72.99	\$74.61	\$76.14	-	See Web

PE-C300 Coax, 50 Ohm						
Part No.	Cable Dia.		Attn. @ 1 GHz	Power @ 1 GHz		
Part No. <a href="#">PE3C0109</a>	0.405" dia.		4.25 dB/100ft	190 W		
1 piece price shown. See web or call for volume pricing.	12"	24"	36"	48"	60"	Custom Len.
\$79.17	\$80.68	\$82.20	\$79.20	\$80.70	-	See Web

PE-C300 Coax, 50 Ohm						
Part No.	Cable Dia.		Attn. @ 1 GHz	Power @ 1 GHz		
Part No. <a href="#">PE3W00013</a>	0.405" dia.		50CM	190 W		
1 piece price shown. See web or call for volume pricing.	12"	24"	36"	48"	60"	Custom Len.
\$54.10	\$55.57	\$57.05	\$58.52	\$60.00	\$55.05	See Web

PE-P142LL Coax, 50 Ohm						
Part No.	Cable Dia.		Attn. @ 1 GHz	Power @ 1 GHz		
Part No. <a href="#">PE349</a>	0.195" dia.		7.2 dB/100ft	820 W		
1 piece price shown. See web or call for volume pricing.	12"	24"	36"	48"	60"	Custom Len.
\$162.10	\$180.01	\$197.92	\$215.86	\$233.77	\$251.68	See Web

PE-P160LL Coax, 50 Ohm						
Part No.	Cable Dia.		Attn. @ 1 GHz	Power @ 1 GHz		
Part No. <a href="#">PE3C5267</a>	0.16" dia.		50CM	190 W		
1 piece price shown. See web or call for volume pricing.	12"	24"	36"	48"	60"	Custom Len.
\$222.74	\$245.21	\$267.66	\$290.11	\$312.56	\$237.13	See Web

**Low Loss Test Flexible Cable Assemblies**

PE-P300LL Coax, 50 Ohm						
Part No.	Cable Dia.		Attn. @ 1 GHz	Power @ 1 GHz		
Part No. <a href="#">PE335</a>	0.3" dia.		4.6 dB/100ft	50CM		
1 piece price shown. See web or call for volume pricing.	12"	24"	36"	48"	60"	Custom Len.
\$244.05	\$272.16	\$300.29	\$328.42	\$356.51	\$262.07	See Web

**Standard Formable Cable Assemblies**

PE-SR402FL Coax, 50 Ohm						
Part No.	Cable Dia.		Attn. @ 1 GHz	Power @ 1 GHz		
Part No. <a href="#">PE33927</a>	0.212" dia.		11.88 dB/100ft	450 W		
1 piece price shown. See web or call for volume pricing.	12"	24"	36"	48"	60"	Custom Len.
\$89.85	\$98.13	\$106.42	\$113.12	\$121.29	-	See Web

**Standard Flexible Cable Assemblies**

M17/60-RG142-27478 Coax, 50 Ohm						
Part No.	Cable Dia.		Attn. @ 1 GHz	Power @ 1 GHz		
Part No. <a href="#">PE3M0016</a>	0.195" dia.		48"	170 W		
1 piece price shown. See web or call for volume pricing.	12"	18"	24"	30"	36"	Custom Len.
\$167.60	\$170.55	\$173.53	\$176.46	\$179.43	\$185.35	See Web

M17/84-RG223-0XDS2 Coax, 50 Ohm						
Part No.	Cable Dia.		Attn. @ 1 GHz	Power @ 1 GHz		
Part No. <a href="#">PE3M0044</a>	0.212" dia.		48"	170 W		
1 piece price shown. See web or call for volume pricing.	12"	18"	24"	30"	36"	Custom Len.
\$172.26	\$177.55	\$182.84	\$188.13	\$193.43	\$204.00	See Web

M17/128-RG400-27478 Coax, 50 Ohm						
Part No.	Cable Dia.		Attn. @ 1 GHz	Power @ 1 GHz		
Part No. <a href="#">PE3M0072</a>	0.195" dia.		48"	170 W		
1 piece price shown. See web or call for volume pricing.	12"	18"	24"	30"	36"	Custom Len.
\$169.21	\$172.98	\$176.74	\$180.50	\$184.26	\$191.79	See Web

RG8A/U Coax, 50 Ohm						
Part No.	Cable Dia.		Attn. @ 1 GHz	Power @ 1 GHz		
Part No. <a href="#">PE33615</a>	0.405" dia.		8 dB/100ft	190 W		
1 piece price shown. See web or call for volume pricing.	12"	24"	36"	48"	60"	Custom Len.
\$76.24	\$79.62	\$78.15	\$81.27	\$84.40	\$93.46	See Web

RG8X Coax, 50 Ohm						
Part No.	Cable Dia.		Attn. @ 1 GHz	Power @ 1 GHz		
Part No. <a href="#">PE37357</a>	0.242" dia.		13.5 dB/100ft	60 W		
1 piece price shown. See web or call for volume pricing.	12"	24"	36"	48"	60"	Custom Len.
\$65.94	\$73.78	\$72.16	\$75.26	\$78.37	-	See Web

RG58C/U Coax, 50 Ohm						
Part No.	Cable Dia.		Attn. @ 1 GHz	Power @ 1 GHz		
Part No. <a href="#">PE3661</a>	0.195" dia.		20 dB/100ft	44 W		
1 piece price shown. See web or call for volume pricing.	12"	24"	36"	48"	60"	Custom Len.
\$49.20	\$50.10	\$51.00	\$51.97	\$49.68	\$53.81	See Web

RG142B/U Coax, 50 Ohm						
Part No.	Cable Dia.		Attn. @ 1 GHz	Power @ 1 GHz		
Part No. <a href="#">PE3652</a>	0.195" dia.		13 dB/100ft	650 W		
1 piece price shown. See web or call for volume pricing.	12"	24"	36"	48"	60"	Custom Len.
\$53.63	\$59.83	\$66.51	\$73.59	\$80.40	\$87.21	See Web

RG174A/U Coax, 50 Ohm						
Part No.	Cable Dia.		Attn. @ 1 GHz	Power @ 1 GHz		
Part No. <a href="#">PE34272</a>	0.1" dia.		32 dB/100ft	16 W		
1 piece price shown. See web or call for volume pricing.	12"	24"	36"	48"	60"	Custom Len.
\$63.76	\$64.23	\$64.71	\$65.19	\$65.67	\$66.15	See Web

RG178B/U Coax, 50 Ohm						
Part No.	Cable Dia.		Attn. @ 1 GHz	Power @ 1 GHz		
Part No. <a href="#">PE33455</a>	0.072" dia.		44.4 dB/100ft	78 W		
1 piece price shown. See web or call for volume pricing.	12"	24"	36"	48"	60"	Custom Len.
\$76.58	\$77.62	\$78.69	\$79.74	\$80.81	\$87.11	See Web

RG188A/U Coax, 50 Ohm						
Part No.	Cable Dia.		Attn. @ 1 GHz	Power @ 1 GHz		
Part No. <a href="#">PE33457</a>	0.11" dia.		26 dB/100ft	160 W		
1 piece price shown. See web or call for volume pricing.	12"	24"	36"	48"	60"	Custom Len.
\$65.83	\$68.26	\$70.70	\$73.15	\$75.58	\$78.02	See Web

RG213/U Coax, 50 Ohm						
Part No.	Cable Dia.		Attn. @ 1 GHz	Power @ 1 GHz		
Part No. <a href="#">PE3644</a>	0.405" dia.		9 dB/100ft	190 W		
1 piece price shown. See web or call for volume pricing.	12"	24"	36"	48"	60"	Custom Len.
\$64.16	\$72.48	\$74.32	\$76.14	\$77.97	\$79.78	See Web

RG214/U Coax, 50 Ohm						
Part No.	Cable Dia.		Attn. @ 1 GHz	Power @ 1 GHz		
Part No. <a href="#">PE3991</a>	0.425" dia.		7.32 dB/100ft	190 W		
1 piece price shown. See web or call for volume pricing.	12"	24"	36"	48"	60"	Custom Len.
\$88.39	\$102.25	\$104.52	\$111.01	\$118.94	\$135.39	See Web

RG223/U Coax, 50 Ohm						
Part No.	Cable Dia.		Attn. @ 1 GHz	Power @ 1 GHz		
Part No. <a href="#">PE3665</a>	0.21" dia.		13.4 dB/100ft	53 W		
1 piece price shown. See web or call for volume pricing.	12"	24"	36"	48"	60"	Custom Len.
\$52.51	\$55.43	\$58.86	\$62.48	\$61.82	\$69.46	See Web

RG316/U Coax, 50 Ohm						
Part No.	Cable Dia.		Attn. @ 1 GHz	Power @ 1 GHz		
Part No. <a href="#">PE3989</a>	0.098" dia.		38 dB/100ft	160 W		
1 piece price shown. See web or call for volume pricing.	12"	24"	36"	48"	60"	Custom Len.
\$72.15	\$75.58	\$79.02	\$76.33	\$79.50	\$82.68	See Web

RG316-DS Coax, 50 Ohm						
Part No.	Cable Dia.		Attn. @ 1 GHz	Power @ 1 GHz		
Part No. <a href="#">PE34266</a>	0.114" dia.		30 dB/100ft	160 W		
1 piece price shown. See web or call for volume pricing.	12"	24"	36"	48"	60"	Custom Len.
\$66.75	\$69.95	\$73.14	\$76.34	\$79.55	\$82.73	See Web

RG393/U Coax, 50 Ohm						
Part No.	Cable Dia.		Attn. @ 1 GHz	Power @ 1 GHz		
Part No. <a href="#">PE3982</a>	0.39" dia.		8.8 dB/100ft	1,700 W		
1 piece price shown. See web or call for volume pricing.	12"	24"	36"	48"	60"	Custom Len.
\$96.34	\$111.77	\$128.54	\$145.30	\$162.08	\$178.84	See Web

RG400/U Coax, 50 Ohm						
Part No.	Cable Dia.		Attn. @ 1 GHz	Power @ 1 GHz		
Part No. <a href="#">PE3666</a>	0.195" dia.		14.7 dB/100ft	650 W		
1 piece price shown. See web or call for volume pricing.	12"	24"	36"	48"	60"	Custom Len.
\$64.45	\$72.58	\$80.70	\$89.32	\$97.59	\$105.89	See Web

PE-FF430 Coax, 50 Ohm						
Part No.	Cable Dia.		Attn. @ 1 GHz	Power @ 1 GHz		
Part No. <a href="#">PE3C4010</a>	0.43" dia.		-	-	Custom Len.	
1 piece price shown. See web or call for volume pricing.	60"	360"	-	-	-	See Web
\$1,046.18	Call	-	-	-	-	See Web

LMR-600-DB Coax, 50 Ohm						
Part No.	Cable Dia.		Attn. @ 1 GHz	Power @ 1 GHz		
Part No. <a href="#">PE3W02356</a>	0.59" dia.		2.62 dB/100ft	450 W		
1 piece price shown. See web or call for volume pricing.	12"	24"	36"	48"	60"	Custom Len.
\$82.60	\$85.85	\$89.10	\$92.37	\$95.62	\$84.69	See Web

**Standard Semi-Rigid Cable Assemblies**

PE-SR402AL Coax, 50 Ohm						
Part No.	Cable Dia.		Attn. @ 1 GHz	Power @ 1 GHz		
Part No. <a href="#">PE3W05401</a>	0.195" dia.		13 dB/100ft	450 W		
1 piece price shown. See web or call for volume pricing.	12"	24"	36"	48"	60"	Custom Len.
\$86.91	\$97.78	\$107.12	\$117.84	\$128.55	\$93.86	See Web

RG401/U Coax, 50 Ohm						
Part No.	Cable Dia.		Attn. @ 1 GHz	Power @ 1 GHz		
Part No. <a href="#">PE3W05651</a>	0.59" dia.		7.5 dB/100ft	1,400 W		
1 piece price shown. See web or call for volume pricing.	12"	24"	36"	48"	60"	Custom Len.
\$138.05	\$163.04	\$188.04	\$213.04	\$238.03	\$154.06	See Web

Cable Assemblies See Our Website For Current Pricing &



For our complete selection of cable assemblies, please visit our website

RG402/U Coax, 50 Ohm						
Part No. <a href="#">PE3080</a>	Cable Dia.	Attn. @ 1 GHz	Power @ 1 GHz			
1 piece price shown. See web or call for volume pricing.		11.1 dB/100ft	450 W			
12"	24"	36"	48"	60"	-	Custom Len.
\$94.81	\$103.40	\$105.49	\$111.95	\$119.85	-	See Web
<b>N MALE TO TNC MALE RIGHT ANGLE</b>						
Low Loss Flexible Cable Assemblies						
LMR-200 Coax, 50 Ohm						
Part No. <a href="#">PE3W02215</a>	Cable Dia.	Attn. @ 1 GHz	Power @ 1 GHz			
1 piece price shown. See web or call for volume pricing.	0.195" dia.	10.5 dB/100ft	450 W			
12"	24"	36"	48"	60"	50CM	Custom Len.
\$57.62	\$58.49	\$59.36	\$60.23	\$61.10	\$58.18	See Web
PE-P160LL Coax, 50 Ohm						
Part No. <a href="#">PE3C5268</a>	Cable Dia.	Attn. @ 1 GHz	Power @ 1 GHz			
1 piece price shown. See web or call for volume pricing.	0.16" dia.	-	650 W			
12"	24"	36"	48"	60"	50CM	Custom Len.
\$286.46	\$308.91	\$331.37	\$353.83	\$376.28	\$300.85	See Web
<b>N MALE TO TNC FEMALE</b>						
Standard Flexible Cable Assemblies						
PE-FF430 Coax, 50 Ohm						
Part No. <a href="#">PE3C4011</a>	Cable Dia.	Attn. @ 1 GHz	Power @ 1 GHz			
1 piece price shown. See web or call for volume pricing.	0.43" dia.	-	650 W			
60"	-	-	-	-	-	Custom Len.
\$1,046.18	-	-	-	-	-	See Web
<b>N MALE TO TNC FEMALE BULKHEAD</b>						
SEE MOUNTING HOLE SECTION ON PAGE 409						
Low Loss Flexible Cable Assemblies						
PE-P142LL Coax, 50 Ohm						
Part No. <a href="#">PE3C2276</a>	Cable Dia.	Attn. @ 1 GHz	Power @ 1 GHz			
1 piece price shown. See web or call for volume pricing.	0.195" dia.	10 dB/100ft	450 W			
12"	24"	36"	48"	60"	50CM	Custom Len.
\$199.27	\$216.88	\$234.49	\$252.08	\$269.68	\$210.56	See Web
PE-P160LL Coax, 50 Ohm						
Part No. <a href="#">PE3C5269</a>	Cable Dia.	Attn. @ 1 GHz	Power @ 1 GHz			
1 piece price shown. See web or call for volume pricing.	0.16" dia.	-	650 W			
12"	24"	36"	48"	60"	50CM	Custom Len.
\$251.25	\$273.71	\$296.15	\$318.61	\$341.07	\$265.63	See Web
Standard Flexible Cable Assemblies						
RG400/U Coax, 50 Ohm						
Part No. <a href="#">PE3W07264</a>	Cable Dia.	Attn. @ 1 GHz	Power @ 1 GHz			
1 piece price shown. See web or call for volume pricing.	0.195" dia.	14.7 dB/100ft	600 W			
12"	24"	36"	48"	60"	50CM	Custom Len.
\$69.92	\$78.30	\$86.67	\$95.06	\$103.44	\$75.29	See Web
<b>N MALE TO REVERSE POLARITY TNC MALE</b>						
Low Loss Flexible Cable Assemblies						
PE-C195 Coax, 50 Ohm						
Part No. <a href="#">PE36362</a>	Cable Dia.	Attn. @ 1 GHz	Power @ 1 GHz			
1 piece price shown. See web or call for volume pricing.	0.195" dia.	11.3 dB/100ft	150 W			
12"	24"	36"	48"	60"	-	Custom Len.
\$43.84	\$44.63	\$45.43	\$46.20	\$47.01	-	See Web
PE-C400 Coax, 50 Ohm						
Part No. <a href="#">PE34966</a>	Cable Dia.	Attn. @ 1 GHz	Power @ 1 GHz			
1 piece price shown. See web or call for volume pricing.	0.4" dia.	4.1 dB/100ft	550 W			
12"	24"	36"	48"	60"	-	Custom Len.
\$67.96	\$69.39	\$75.30	\$72.30	\$73.75	-	See Web
Standard Flexible Cable Assemblies						
RG58C/U Coax, 50 Ohm						
Part No. <a href="#">PE34554</a>	Cable Dia.	Attn. @ 1 GHz	Power @ 1 GHz			
1 piece price shown. See web or call for volume pricing.	0.195" dia.	20 dB/100ft	44 W			
12"	24"	36"	48"	60"	72"	Custom Len.
\$53.27	\$57.90	\$54.40	\$55.20	\$56.01	\$56.83	See Web
RG142B/U Coax, 50 Ohm						
Part No. <a href="#">PE34573</a>	Cable Dia.	Attn. @ 1 GHz	Power @ 1 GHz			
1 piece price shown. See web or call for volume pricing.	0.195" dia.	13 dB/100ft	650 W			
12"	24"	36"	48"	60"	72"	Custom Len.
\$54.18	\$60.00	\$66.28	\$72.60	\$78.90	\$85.21	See Web
RG178B/U Coax, 50 Ohm						
Part No. <a href="#">PE35241</a>	Cable Dia.	Attn. @ 1 GHz	Power @ 1 GHz			
1 piece price shown. See web or call for volume pricing.	0.072" dia.	44.4 dB/100ft	78 W			
12"	24"	36"	48"	60"	72"	Custom Len.
\$79.95	\$80.98	\$82.05	\$83.12	\$84.16	\$85.22	See Web

RG188A/U Coax, 50 Ohm						
Part No. <a href="#">PE35243</a>	Cable Dia.	Attn. @ 1 GHz	Power @ 1 GHz			
1 piece price shown. See web or call for volume pricing.	0.11" dia.	26 dB/100ft	160 W			
12"	24"	36"	48"	60"	72"	Custom Len.
\$63.64	\$66.01	\$68.34	\$70.69	\$73.07	\$75.38	See Web
RG223/U Coax, 50 Ohm						
Part No. <a href="#">PE35245</a>	Cable Dia.	Attn. @ 1 GHz	Power @ 1 GHz			
1 piece price shown. See web or call for volume pricing.	0.21" dia.	13.4 dB/100ft	53 W			
12"	24"	36"	48"	60"	72"	Custom Len.
\$47.26	\$50.45	\$56.48	\$56.46	\$59.62	\$62.85	See Web
RG316/U Coax, 50 Ohm						
Part No. <a href="#">PE35247</a>	Cable Dia.	Attn. @ 1 GHz	Power @ 1 GHz			
1 piece price shown. See web or call for volume pricing.	0.098" dia.	38 dB/100ft	160 W			
12"	24"	36"	48"	60"	72"	Custom Len.
\$68.52	\$71.70	\$74.88	\$78.05	\$81.21	\$84.40	See Web
RG400/U Coax, 50 Ohm						
Part No. <a href="#">PE34626</a>	Cable Dia.	Attn. @ 1 GHz	Power @ 1 GHz			
1 piece price shown. See web or call for volume pricing.	0.195" dia.	14.7 dB/100ft	650 W			
12"	24"	36"	48"	60"	-	Custom Len.
\$61.38	\$75.64	\$83.78	\$92.38	\$100.66	-	See Web
<b>N MALE TO REVERSE POLARITY TNC MALE RIGHT ANGLE</b>						
Standard Flexible Cable Assemblies						
RG400/U Coax, 50 Ohm						
Part No. <a href="#">PE36283</a>	Cable Dia.	Attn. @ 1 GHz	Power @ 1 GHz			
1 piece price shown. See web or call for volume pricing.	0.195" dia.	14.7 dB/100ft	650 W			
12"	24"	36"	48"	60"	-	Custom Len.
\$74.33	\$82.00	\$89.64	\$103.65	\$104.97	-	See Web
<b>N MALE TO UMCX PLUG RIGHT ANGLE</b>						
Standard Flexible Cable Assemblies						
RG178B/U Coax, 50 Ohm						
Part No. <a href="#">PE38813</a>	Cable Dia.	Attn. @ 1 GHz	Power @ 1 GHz			
1 piece price shown. See web or call for volume pricing.	0.072" dia.	44.4 dB/100ft	78 W			
3"	6"	9"	12"	18"	24"	Custom Len.
\$78.59	\$78.59	\$78.59	\$83.31	\$83.89	\$79.64	See Web
<b>N MALE TO NEX10 MALE</b>						
Low PIM Corrugated Cable Assemblies						
SPP-250-LLPL Coax, 50 Ohm						
Part No. <a href="#">PE3C6256</a>	Cable Dia.	Attn. @ 1 GHz	Power @ 1 GHz			
1 piece price shown. See web or call for volume pricing.	0.28" dia.	5.5 dB/100ft	650 W			
12"	24"	36"	48"	60"	50CM	Custom Len.
\$66.18	\$72.31	\$78.45	\$84.58	\$90.71	\$70.09	See Web
SPO-250 Coax, 50 Ohm						
Part No. <a href="#">PE3C6347</a>	Cable Dia.	Attn. @ 1 GHz	Power @ 1 GHz			
1 piece price shown. See web or call for volume pricing.	0.303" dia.	60"	50CM	Custom Len.		
12"	24"	36"	48"	60"	50CM	Custom Len.
\$59.70	\$61.99	\$64.26	\$66.54	\$68.83	\$61.17	See Web
SPF-250 Coax, 50 Ohm						
Part No. <a href="#">PE3C6362</a>	Cable Dia.	Attn. @ 1 GHz	Power @ 1 GHz			
1 piece price shown. See web or call for volume pricing.	0.303" dia.	60"	50CM	Custom Len.		
12"	24"	36"	48"	60"	50CM	Custom Len.
\$60.42	\$63.44	\$66.46	\$69.47	\$72.48	\$62.36	See Web
<b>N MALE RIGHT ANGLE TO BNC MALE</b>						
Standard Flexible Cable Assemblies						
RG400/U Coax, 50 Ohm						
Part No. <a href="#">PE3W06095</a>	Cable Dia.	Attn. @ 1 GHz	Power @ 1 GHz			
1 piece price shown. See web or call for volume pricing.	0.195" dia.	14.7 dB/100ft	600 W			
12"	24"	36"	48"	60"	50CM	Custom Len.
\$68.70	\$77.06	\$85.43	\$93.80	\$102.18	\$74.06	See Web
<b>N MALE RIGHT ANGLE TO BNC MALE RIGHT ANGLE</b>						
Low Loss Flexible Cable Assemblies						
LMR-240-UF Coax, 50 Ohm						
Part No. <a href="#">PE3C1316</a>	Cable Dia.	Attn. @ 1 GHz	Power @ 1 GHz			
1 piece price shown. See web or call for volume pricing.	0.24" dia.	9.19 dB/100ft	650 W			
12"	24"	36"	48"	60"	50CM	Custom Len.
\$106.14	\$107.57	\$106.78	\$108.18	\$109.58	\$106.35	See Web

Cable Assemblies

See Our Website For Current Pricing & Real-Time Stock Availability!

For Custom Lengths, Metric Lengths or Special Configurations, Please call (949) 261-1920



Technical Support  
+1 (949) 261-1920



Same-Day Shipping,  
Even Custom Cable Assemblies



For our complete selection of cable assemblies, please visit our website

Cable Assemblies  
See Our Website For Current Pricing & Real-Time Stock Availability!

Standard Flexible Cable Assemblies						
RG400/U Coax, 50 Ohm						
Part No.	PE3W00447	Cable Dia.	0.195" dia.	Attn. @ 1 GHz	14.7 dB/100ft	Power @ 1 GHz
1 piece price shown. See web or call for volume pricing.						
12"	24"	36"	48"	60"	50CM	Custom Len.
\$88.14	\$96.50	\$104.88	\$111.69	\$119.95	\$93.51	See Web
<b>N MALE RIGHT ANGLE TO N MALE</b>						
Flexible Cable Assemblies						
LMR-195 Coax, 50 Ohm						
Part No.	PE3C0120	Cable Dia.	0.195" dia.	Attn. @ 1 GHz	11.8 dB/100ft	Power @ 1 GHz
1 piece price shown. See web or call for volume pricing.						
12"	24"	36"	48"	60"	-	Custom Len.
\$55.03	\$53.21	\$56.66	\$45.36	\$55.18	-	See Web
Low PIM Corrugated Cable Assemblies						
SPP-250-LLPL Coax, 50 Ohm						
Part No.	PE3C4139	Cable Dia.	0.28" dia.	Attn. @ 1 GHz	5.5 dB/100ft	Power @ 1 GHz
1 piece price shown. See web or call for volume pricing.						
12"	24"	36"	48"	60"	50CM	Custom Len.
\$99.52	\$105.65	\$110.24	\$116.29	\$122.34	\$103.45	See Web
<b>N MALE RIGHT ANGLE TO N MALE RIGHT ANGLE</b>						
Low Loss Flexible Cable Assemblies						
PE-C195 Coax, 50 Ohm						
Part No.	PE36910	Cable Dia.	0.195" dia.	Attn. @ 1 GHz	11.3 dB/100ft	Power @ 1 GHz
1 piece price shown. See web or call for volume pricing.						
12"	24"	36"	48"	60"	-	Custom Len.
\$72.22	\$78.86	\$79.71	\$74.59	\$75.36	-	See Web
PE-C240 Coax, 50 Ohm						
Part No.	PE38699	Cable Dia.	0.24" dia.	Attn. @ 1 GHz	9.2 dB/100ft	Power @ 1 GHz
1 piece price shown. See web or call for volume pricing.						
36"	48"	60"	72"	120"	-	Custom Len.
\$94.08	\$95.14	\$96.21	\$98.03	\$108.83	-	See Web
PE-C400 Coax, 50 Ohm						
Part No.	PE38194	Cable Dia.	0.4" dia.	Attn. @ 1 GHz	4.1 dB/100ft	Power @ 1 GHz
1 piece price shown. See web or call for volume pricing.						
36"	48"	60"	72"	120"	-	Custom Len.
\$124.72	\$126.41	\$128.05	\$126.46	\$147.28	-	See Web
LMR-400 Coax, 50 Ohm						
Part No.	PE3C0107	Cable Dia.	0.405" dia.	Attn. @ 1 GHz	4.25 dB/100ft	Power @ 1 GHz
1 piece price shown. See web or call for volume pricing.						
12"	24"	36"	48"	60"	-	Custom Len.
\$90.94	\$89.82	\$93.99	\$95.58	\$94.33	-	See Web
LMR-195 Coax, 50 Ohm						
Part No.	PE3C0119	Cable Dia.	0.195" dia.	Attn. @ 1 GHz	11.8 dB/100ft	Power @ 1 GHz
1 piece price shown. See web or call for volume pricing.						
12"	24"	36"	48"	60"	-	Custom Len.
\$56.27	\$57.10	\$57.93	\$57.10	\$57.93	-	See Web
PE-P142LL Coax, 50 Ohm						
Part No.	PE3C0967	Cable Dia.	0.195" dia.	Attn. @ 1 GHz	10 dB/100ft	Power @ 1 GHz
1 piece price shown. See web or call for volume pricing.						
12"	24"	36"	48"	60"	50CM	Custom Len.
\$353.28	\$370.88	\$388.46	\$406.08	\$423.68	\$364.55	See Web
PE-P160LL Coax, 50 Ohm						
Part No.	PE3C5287	Cable Dia.	0.16" dia.	Attn. @ 1 GHz	8 dB/100ft	Power @ 1 GHz
1 piece price shown. See web or call for volume pricing.						
12"	24"	36"	48"	60"	50CM	Custom Len.
\$350.17	\$372.63	\$395.08	\$417.54	\$439.99	\$364.55	See Web
PE-P142LL-27478 Coax, 50 Ohm						
Part No.	PE3M0179	Cable Dia.	0.195" dia.	Attn. @ 1 GHz	11.8 dB/100ft	Power @ 1 GHz
1 piece price shown. See web or call for volume pricing.						
12"	18"	24"	36"	48"	60"	Custom Len.
\$650.65	\$659.83	\$669.02	\$687.41	\$705.79	\$724.17	See Web
PE-P160LL-27478 Coax, 50 Ohm						
Part No.	PE3M0224	Cable Dia.	0.16" dia.	Attn. @ 1 GHz	8 dB/100ft	Power @ 1 GHz
1 piece price shown. See web or call for volume pricing.						
8"	12"	18"	24"	30"	36"	Custom Len.
\$581.93	\$587.24	\$595.22	\$603.18	\$611.16	\$619.11	See Web
PE-P300LL-27478 Coax, 50 Ohm						
Part No.	PE3M0252	Cable Dia.	0.3" dia.	Attn. @ 1 GHz	22.5 dB/100ft	Power @ 1 GHz
1 piece price shown. See web or call for volume pricing.						
12"	18"	24"	36"	48"	60"	Custom Len.
\$767.54	\$782.88	\$798.23	\$828.92	\$859.60	\$890.28	See Web
Precision Formable Cable Assemblies						
PE-SR405FL Coax, 50 Ohm						
Part No.	PE39444	Cable Dia.	0.405" dia.	Attn. @ 1 GHz	9 dB/100ft	Power @ 1 GHz
1 piece price shown. See web or call for volume pricing.						
6"	9"	12"	18"	24"	-	Custom Len.
Call	Call	Call	Call	Call	-	See Web

PE-SR405FLJ Coax, 50 Ohm						
Part No.	PE39458	Cable Dia.	0.098" dia.	Attn. @ 1 GHz	19.5 dB/100ft	Power @ 1 GHz
1 piece price shown. See web or call for volume pricing.						
6"	9"	12"	18"	24"	-	Custom Len.
Call	Call	Call	Call	Call	-	See Web
Low PIM Corrugated Cable Assemblies						
PE-1/4SFHC Coax, 50 Ohm						
Part No.	PE3C7846	Cable Dia.	0.303" dia.	Attn. @ 1 GHz	5.85 dB/100ft	Power @ 1 GHz
1 piece price shown. See web or call for volume pricing.						
12"	50CM	24"	36"	48"	60"	Custom Len.
\$64.71	\$67.09	\$68.44	\$72.17	\$75.90	\$79.62	See Web
SPP-250-LLPL Coax, 50 Ohm						
Part No.	PE3C4145	Cable Dia.	0.28" dia.	Attn. @ 1 GHz	5.5 dB/100ft	Power @ 1 GHz
1 piece price shown. See web or call for volume pricing.						
12"	24"	36"	48"	60"	50CM	Custom Len.
\$102.60	\$107.24	\$113.29	\$119.34	\$125.39	\$106.55	See Web
SPO-500 Coax, 50 Ohm						
Part No.	PE3C6373	Cable Dia.	0.53" dia.	Attn. @ 1 GHz	5.5 dB/100ft	Power @ 1 GHz
1 piece price shown. See web or call for volume pricing.						
12"	24"	36"	48"	60"	50CM	Custom Len.
\$50.20	\$53.31	\$55.91	\$58.98	\$62.07	\$52.19	See Web
SPF-500 Coax, 50 Ohm						
Part No.	PE3C6376	Cable Dia.	0.545" dia.	Attn. @ 1 GHz	5.5 dB/100ft	Power @ 1 GHz
1 piece price shown. See web or call for volume pricing.						
12"	24"	36"	48"	60"	50CM	Custom Len.
\$51.51	\$55.42	\$59.80	\$64.20	\$68.58	\$54.35	See Web
Low Loss Test Flexible Cable Assemblies						
PE-P300LL Coax, 50 Ohm						
Part No.	PE3C3233	Cable Dia.	0.3" dia.	Attn. @ 1 GHz	5.5 dB/100ft	Power @ 1 GHz
1 piece price shown. See web or call for volume pricing.						
12"	24"	36"	48"	60"	50CM	Custom Len.
\$366.99	\$395.10	\$423.23	\$451.35	\$479.47	\$385.00	See Web
Standard Formable Cable Assemblies						
PE-SR401FL Coax, 50 Ohm						
Part No.	PE34680	Cable Dia.	0.405" dia.	Attn. @ 1 GHz	7.6 dB/100ft	Power @ 1 GHz
1 piece price shown. See web or call for volume pricing.						
12"	24"	36"	48"	60"	-	Custom Len.
\$124.78	\$134.40	\$151.10	\$167.80	\$184.51	-	See Web
PE-SR402FL Coax, 50 Ohm						
Part No.	PE33977	Cable Dia.	0.405" dia.	Attn. @ 1 GHz	11.88 dB/100ft	Power @ 1 GHz
1 piece price shown. See web or call for volume pricing.						
12"	24"	36"	48"	60"	-	Custom Len.
\$83.89	\$92.19	\$100.48	\$107.25	\$115.43	-	See Web
PE-SR402FLJ Coax, 50 Ohm						
Part No.	PE39452	Cable Dia.	0.405" dia.	Attn. @ 1 GHz	12 dB/100ft	Power @ 1 GHz
1 piece price shown. See web or call for volume pricing.						
6"	9"	12"	18"	24"	-	Custom Len.
\$84.37	\$86.52	\$88.68	Call	Call	-	See Web
PE-SR402FLJ Coax, 50 Ohm						
Part No.	PE39466	Cable Dia.	0.161" dia.	Attn. @ 1 GHz	11.89 dB/100ft	Power @ 1 GHz
1 piece price shown. See web or call for volume pricing.						
6"	9"	12"	18"	24"	-	Custom Len.
\$84.45	Call	\$84.45	\$88.61	\$92.76	-	See Web
Standard Flexible Cable Assemblies						
RG8A/U Coax, 50 Ohm						
Part No.	PE33974	Cable Dia.	0.405" dia.	Attn. @ 1 GHz	8 dB/100ft	Power @ 1 GHz
1 piece price shown. See web or call for volume pricing.						
12"	24"	36"	48"	60"	72"	Custom Len.
\$117.41	\$120.74	\$124.08	\$122.12	\$125.17	\$134.40	See Web
RG58C/U Coax, 50 Ohm						
Part No.	PE3698	Cable Dia.	0.195" dia.	Attn. @ 1 GHz	20 dB/100ft	Power @ 1 GHz
1 piece price shown. See web or call for volume pricing.						
12"	24"	36"	48"	60"	72"	Custom Len.
\$86.78	\$82.68	\$88.56	\$84.31	\$85.12	\$91.34	See Web
RG174A/U Coax, 50 Ohm						
Part No.	PE34231	Cable Dia.	0.1" dia.	Attn. @ 1 GHz	32 dB/100ft	Power @ 1 GHz
1 piece price shown. See web or call for volume pricing.						
12"	24"	36"	48"	60"	72"	Custom Len.
\$77.69	\$78.23	\$78.69	\$79.20	\$79.69	\$80.14	See Web
RG188A/U Coax, 50 Ohm						
Part No.	PE34238	Cable Dia.	0.11" dia.	Attn. @ 1 GHz	26 dB/100ft	Power @ 1 GHz
1 piece price shown. See web or call for volume pricing.						
12"	24"	36"	48"	60"	72"	Custom Len.
\$92.84	\$86.85	\$98.33	\$91.73	\$94.17	\$96.61	See Web
RG213/U Coax, 50 Ohm						
Part No.	PE3272	Cable Dia.	0.405" dia.	Attn. @ 1 GHz	9 dB/100ft	Power @ 1 GHz
1 piece price shown. See web or call for volume pricing.						
12"	24"	36"	48"	60"	72"	Custom Len.
\$116.13	\$111.36	\$113.16	\$122.06	\$116.76	\$118.56	See Web

\*Coax Performance at 1 GHz Notes: Cable assembly max frequency may be lower than connector or coax max frequency

# For our complete selection of cable assemblies, please visit our website

RG214/U Coax, 50 Ohm						
Part No. <a href="#">PE3781</a>		Cable Dia.	Attn. @ 1 GHz	Power @ 1 GHz		
1 piece price shown. See web or call for volume pricing.						
12"	24"	36"	48"	60"	72"	Custom Len.
\$131.14	\$147.43	\$147.03	\$154.96	\$173.40	\$182.00	See Web
RG223/U Coax, 50 Ohm						
Part No. <a href="#">PE3882</a>		Cable Dia.	Attn. @ 1 GHz	Power @ 1 GHz		
1 piece price shown. See web or call for volume pricing.						
12"	24"	36"	48"	60"	72"	Custom Len.
\$92.19	\$88.53	\$91.73	\$94.92	\$98.11	\$101.30	See Web
RG225/U Coax, 50 Ohm						
Part No. <a href="#">PE34222</a>		Cable Dia.	Attn. @ 1 GHz	Power @ 1 GHz		
1 piece price shown. See web or call for volume pricing.						
12"	24"	36"	48"	60"	72"	Custom Len.
\$154.63	\$189.97	\$225.31	\$288.23	\$295.96	\$331.29	See Web
RG316/U Coax, 50 Ohm						
Part No. <a href="#">PE34236</a>		Cable Dia.	Attn. @ 1 GHz	Power @ 1 GHz		
1 piece price shown. See web or call for volume pricing.						
12"	24"	36"	48"	60"	72"	Custom Len.
\$85.36	\$88.53	\$91.72	\$94.89	\$98.06	\$107.99	See Web
RG393/U Coax, 50 Ohm						
Part No. <a href="#">PE3268</a>		Cable Dia.	Attn. @ 1 GHz	Power @ 1 GHz		
1 piece price shown. See web or call for volume pricing.						
12"	24"	36"	48"	60"	72"	Custom Len.
\$125.57	\$150.88	\$168.68	\$187.50	\$205.62	\$223.76	See Web
RG400/U Coax, 50 Ohm						
Part No. <a href="#">PE3412</a>		Cable Dia.	Attn. @ 1 GHz	Power @ 1 GHz		
1 piece price shown. See web or call for volume pricing.						
12"	24"	36"	48"	60"	72"	Custom Len.
\$101.33	\$107.95	\$115.96	\$124.45	\$124.49	\$140.79	See Web
PE-P141EAM Coax, 50 Ohm						
Part No. <a href="#">PE3CA1049</a>		Cable Dia.	Attn. @ 1 GHz	Power @ 1 GHz		
1 piece price shown. See web or call for volume pricing.						
12"	24"	36"	50CM	100CM	-	Custom Len.
\$116.21	\$129.56	\$147.24	\$123.18	\$152.20	-	See Web

N MALE RIGHT ANGLE TO N FEMALE						
Low PIM Corrugated Cable Assemblies						
PE-1/4SFHC Coax, 50 Ohm						
Part No. <a href="#">PE3C7847</a>		Cable Dia.	Attn. @ 1 GHz	Power @ 1 GHz		
1 piece price shown. See web or call for volume pricing.						
12"	24"	36"	48"	60"	50CM	Custom Len.
\$61.96	\$65.69	\$69.42	\$73.14	\$76.87	\$64.35	See Web
SPP-250-LLPL Coax, 50 Ohm						
Part No. <a href="#">PE3C6203</a>		Cable Dia.	Attn. @ 1 GHz	Power @ 1 GHz		
1 piece price shown. See web or call for volume pricing.						
12"	24"	36"	48"	60"	50CM	Custom Len.
\$60.24	\$66.37	\$72.49	\$78.63	\$84.76	\$64.16	See Web
Low Loss Test Flexible Cable Assemblies						
PE-P300LL Coax, 50 Ohm						
Part No. <a href="#">PE3C3115</a>		Cable Dia.	Attn. @ 1 GHz	Power @ 1 GHz		
1 piece price shown. See web or call for volume pricing.						
12"	24"	36"	48"	60"	50CM	Custom Len.
\$354.16	\$382.29	\$410.41	\$438.53	\$466.65	\$372.18	See Web
Standard Flexible Cable Assemblies						
RG400/U Coax, 50 Ohm						
Part No. <a href="#">PE3W06096</a>		Cable Dia.	Attn. @ 1 GHz	Power @ 1 GHz		
1 piece price shown. See web or call for volume pricing.						
12"	24"	36"	48"	60"	50CM	Custom Len.
\$77.08	\$85.44	\$93.81	\$102.19	\$109.02	\$82.43	See Web

N MALE RIGHT ANGLE TO N FEMALE BULKHEAD						
SEE MOUNTING HOLE SECTION ON PAGE 409						
Flexible Cable Assemblies						
LMR-400 Coax, 50 Ohm						
Part No. <a href="#">PE3W03991</a>		Cable Dia.	Attn. @ 1 GHz	Power @ 1 GHz		
1 piece price shown. See web or call for volume pricing.						
12"	24"	36"	48"	60"	50CM	Custom Len.
\$80.55	\$81.93	\$83.29	\$84.67	\$86.04	\$81.44	See Web
Low Loss Flexible Cable Assemblies						
PE-P142LL Coax, 50 Ohm						
Part No. <a href="#">PE3C0673</a>		Cable Dia.	Attn. @ 1 GHz	Power @ 1 GHz		
1 piece price shown. See web or call for volume pricing.						
12"	24"	36"	48"	60"	50CM	Custom Len.
\$285.96	\$303.05	\$320.12	\$337.21	\$354.30	\$296.91	See Web
PE-P160LL Coax, 50 Ohm						
Part No. <a href="#">PE3C5286</a>		Cable Dia.	Attn. @ 1 GHz	Power @ 1 GHz		
1 piece price shown. See web or call for volume pricing.						
12"	24"	36"	48"	60"	50CM	Custom Len.
\$314.95	\$337.42	\$359.87	\$382.32	\$404.78	\$329.33	See Web

LMR-240-UF Coax, 50 Ohm						
Part No. <a href="#">PE3W06441</a>		Cable Dia.	Attn. @ 1 GHz	Power @ 1 GHz		
1 piece price shown. See web or call for volume pricing.						
12"	24"	36"	48"	60"	50CM	Custom Len.
\$85.85	\$87.32	\$88.81	\$90.29	\$91.78	\$86.80	See Web
Low PIM Corrugated Cable Assemblies						
PE-1/4SFHC Coax, 50 Ohm						
Part No. <a href="#">PE3C7848</a>		Cable Dia.	Attn. @ 1 GHz	Power @ 1 GHz		
1 piece price shown. See web or call for volume pricing.						
12"	24"	36"	48"	60"	50CM	Custom Len.
\$61.96	\$65.69	\$69.42	\$73.14	\$76.87	\$64.35	See Web
SPP-250-LLPL Coax, 50 Ohm						
Part No. <a href="#">PE3C6204</a>		Cable Dia.	Attn. @ 1 GHz	Power @ 1 GHz		
1 piece price shown. See web or call for volume pricing.						
12"	24"	36"	48"	60"	50CM	Custom Len.
\$60.24	\$66.37	\$72.49	\$78.63	\$84.76	\$64.16	See Web
Low Loss Test Flexible Cable Assemblies						
PE-P300LL Coax, 50 Ohm						
Part No. <a href="#">PE3C2953</a>		Cable Dia.	Attn. @ 1 GHz	Power @ 1 GHz		
1 piece price shown. See web or call for volume pricing.						
12"	24"	36"	48"	60"	50CM	Custom Len.
\$379.75	\$407.05	\$434.37	\$461.65	\$489.27	\$397.25	See Web
Standard Formable Cable Assemblies						
PE-SR401FL Coax, 50 Ohm						
Part No. <a href="#">PE39082</a>		Cable Dia.	Attn. @ 1 GHz	Power @ 1 GHz		
1 piece price shown. See web or call for volume pricing.						
12"	24"	36"	48"	60"	-	Custom Len.
\$107.65	\$121.56	\$137.01	\$152.43	\$167.89	-	See Web
PE-SR402FL Coax, 50 Ohm						
Part No. <a href="#">PE38670</a>		Cable Dia.	Attn. @ 1 GHz	Power @ 1 GHz		
1 piece price shown. See web or call for volume pricing.						
12"	24"	36"	48"	60"	-	Custom Len.
\$94.03	\$96.63	\$104.49	\$110.79	\$118.52	-	See Web
Standard Flexible Cable Assemblies						
RG8A/U Coax, 50 Ohm						
Part No. <a href="#">PE34216</a>		Cable Dia.	Attn. @ 1 GHz	Power @ 1 GHz		
1 piece price shown. See web or call for volume pricing.						
12"	24"	36"	48"	60"	72"	Custom Len.
\$99.22	\$102.18	\$105.21	\$106.75	\$109.68	\$112.67	See Web
RG58C/U Coax, 50 Ohm						
Part No. <a href="#">PE3407</a>		Cable Dia.	Attn. @ 1 GHz	Power @ 1 GHz		
1 piece price shown. See web or call for volume pricing.						
12"	24"	36"	48"	60"	72"	Custom Len.
\$78.32	\$79.20	\$74.14	\$74.95	\$75.77	\$76.57	See Web
RG142B/U Coax, 50 Ohm						
Part No. <a href="#">PE33021</a>		Cable Dia.	Attn. @ 1 GHz	Power @ 1 GHz		
1 piece price shown. See web or call for volume pricing.						
12"	24"	36"	48"	60"	72"	Custom Len.
\$80.11	\$81.87	\$88.19	\$94.48	\$107.37	\$107.09	See Web
RG174A/U Coax, 50 Ohm						
Part No. <a href="#">PE34229</a>		Cable Dia.	Attn. @ 1 GHz	Power @ 1 GHz		
1 piece price shown. See web or call for volume pricing.						
12"	24"	36"	48"	60"	72"	Custom Len.
\$78.42	\$78.89	\$79.43	\$79.87	\$80.40	\$80.86	See Web
RG188A/U Coax, 50 Ohm						
Part No. <a href="#">PE34218</a>		Cable Dia.	Attn. @ 1 GHz	Power @ 1 GHz		
1 piece price shown. See web or call for volume pricing.						
12"	24"	36"	48"	60"	72"	Custom Len.
\$80.28	\$82.65	\$84.96	\$87.33	\$89.70	\$92.01	See Web
RG213/U Coax, 50 Ohm						
Part No. <a href="#">PE33545</a>		Cable Dia.	Attn. @ 1 GHz	Power @ 1 GHz		
1 piece price shown. See web or call for volume pricing.						
12"	24"	36"	48"	60"	72"	Custom Len.
\$103.92	\$105.75	\$107.56	\$107.87	\$109.68	\$111.48	See Web
RG214/U Coax, 50 Ohm						
Part No. <a href="#">PE33178</a>		Cable Dia.	Attn. @ 1 GHz	Power @ 1 GHz		
1 piece price shown. See web or call for volume pricing.						
12"	24"	36"	48"	60"	72"	Custom Len.
\$96.63	\$104.75	\$111.30	\$119.31	\$127.32	\$135.30	See Web
RG223/U Coax, 50 Ohm						
Part No. <a href="#">PE33536</a>		Cable Dia.	Attn. @ 1 GHz	Power @ 1 GHz		
1 piece price shown. See web or call for volume pricing.						
12"	24"	36"	48"	60"	72"	Custom Len.
\$68.39	\$75.93	\$74.78	\$78.01	\$81.19	\$89.96	See Web
RG225/U Coax, 50 Ohm						
Part No. <a href="#">PE34221</a>		Cable Dia.	Attn. @ 1 GHz	Power @ 1 GHz		
1 piece price shown. See web or call for volume pricing.						
12"	24"	36"	48"	60"	72"	Custom Len.
\$122.63	\$157.97	\$193.28	\$228.61	\$263.94	\$299.26	See Web
RG316/U Coax, 50 Ohm						
Part No. <a href="#">PE34214</a>		Cable Dia.	Attn. @ 1 GHz	Power @ 1 GHz		
1 piece price shown. See web or call for volume pricing.						
12"	24"	36"	48"	60"	72"	Custom Len.
\$81.26	\$84.57	\$87.84	\$91.16	\$94.45	\$97.77	See Web

Cable Assemblies

See Our Website For Current Pricing & Real-Time Stock Availability!

For Custom Lengths, Metric Lengths or Special Configurations, Please call (949) 261-1920



Technical Support  
+1 (949) 261-1920



Same-Day Shipping,  
Even Custom Cable Assemblies

For our complete selection of cable assemblies, please visit our website

Cable Assemblies

See Our Website For Current Pricing & Real-Time Stock Availability!

RG316-DS Coax, 50 Ohm						
Part No. <a href="#">PE34227</a>	Cable Dia.	Attn. @ 1 GHz	Power @ 1 GHz			
1 piece price shown. See web or call for volume pricing.						
12"	24"	36"	48"	60"	72"	Custom Len.
\$86.29	\$89.46	\$92.66	\$95.87	\$99.07	\$102.27	See Web
RG393/U Coax, 50 Ohm						
Part No. <a href="#">PE33532</a>	Cable Dia.	Attn. @ 1 GHz	Power @ 1 GHz			
1 piece price shown. See web or call for volume pricing.						
12"	24"	36"	48"	60"	72"	Custom Len.
\$102.44	\$117.78	\$134.56	\$151.32	\$168.09	\$184.86	See Web
RG400/U Coax, 50 Ohm						
Part No. <a href="#">PE33528</a>	Cable Dia.	Attn. @ 1 GHz	Power @ 1 GHz			
1 piece price shown. See web or call for volume pricing.						
12"	24"	36"	48"	60"	72"	Custom Len.
\$84.26	\$91.92	\$103.89	\$110.94	\$113.31	\$120.86	See Web
N MALE RIGHT ANGLE TO SMA MALE						
Low Loss Flexible Cable Assemblies						
PE-P160LL Coax, 50 Ohm						
Part No. <a href="#">PE3C5279</a>	Cable Dia.	Attn. @ 1 GHz	Power @ 1 GHz			
1 piece price shown. See web or call for volume pricing.						
12"	24"	36"	48"	60"	50CM	Custom Len.
\$286.46	\$308.91	\$331.37	\$353.83	\$376.28	\$300.85	See Web
Low PIM Corrugated Cable Assemblies						
SPP-250-LLPL Coax, 50 Ohm						
Part No. <a href="#">PE3C6209</a>	Cable Dia.	Attn. @ 1 GHz	Power @ 1 GHz			
1 piece price shown. See web or call for volume pricing.						
12"	24"	36"	48"	60"	50CM	Custom Len.
\$54.98	\$61.12	\$67.26	\$73.38	\$79.51	\$58.90	See Web
N MALE RIGHT ANGLE TO SMA MALE RIGHT ANGLE						
Low Loss Flexible Cable Assemblies						
PE-P160LL Coax, 50 Ohm						
Part No. <a href="#">PE3C5281</a>	Cable Dia.	Attn. @ 1 GHz	Power @ 1 GHz			
1 piece price shown. See web or call for volume pricing.						
12"	24"	36"	48"	60"	50CM	Custom Len.
\$326.69	\$349.15	\$371.60	\$394.05	\$416.52	\$341.08	See Web
Low PIM Corrugated Cable Assemblies						
SPP-250-LLPL Coax, 50 Ohm						
Part No. <a href="#">PE3C6211</a>	Cable Dia.	Attn. @ 1 GHz	Power @ 1 GHz			
1 piece price shown. See web or call for volume pricing.						
12"	24"	36"	48"	60"	50CM	Custom Len.
\$60.24	\$66.37	\$72.49	\$78.63	\$84.76	\$64.16	See Web
N MALE RIGHT ANGLE TO SMA FEMALE BULKHEAD						
SEE MOUNTING HOLE SECTION ON PAGE 409						
Low Loss Flexible Cable Assemblies						
PE-P160LL Coax, 50 Ohm						
Part No. <a href="#">PE3C5280</a>	Cable Dia.	Attn. @ 1 GHz	Power @ 1 GHz			
1 piece price shown. See web or call for volume pricing.						
12"	24"	36"	48"	60"	50CM	Custom Len.
\$304.90	\$327.35	\$349.80	\$372.27	\$394.73	\$319.28	See Web
N MALE RIGHT ANGLE TO TNC MALE						
Flexible Cable Assemblies						
LMR-600-DB Coax, 50 Ohm						
Part No. <a href="#">PE3C4750</a>	Cable Dia.	Attn. @ 1 GHz	Power @ 1 GHz			
1 piece price shown. See web or call for volume pricing.						
12"	24"	36"	48"	60"	50CM	Custom Len.
\$93.49	\$91.45	\$94.71	\$97.96	\$101.22	\$90.28	See Web
Low Loss Flexible Cable Assemblies						
PE-P160LL Coax, 50 Ohm						
Part No. <a href="#">PE3C5282</a>	Cable Dia.	Attn. @ 1 GHz	Power @ 1 GHz			
1 piece price shown. See web or call for volume pricing.						
12"	24"	36"	48"	60"	50CM	Custom Len.
\$286.46	\$308.91	\$331.37	\$353.83	\$376.28	\$300.85	See Web
Low Loss Test Flexible Cable Assemblies						
PE-P300LL Coax, 50 Ohm						
Part No. <a href="#">PE3C3243</a>	Cable Dia.	Attn. @ 1 GHz	Power @ 1 GHz			
1 piece price shown. See web or call for volume pricing.						
12"	24"	36"	48"	60"	50CM	Custom Len.
\$410.04	\$437.36	\$464.69	\$492.00	\$519.34	\$427.53	See Web

N MALE RIGHT ANGLE TO TNC MALE RIGHT ANGLE						
Low Loss Flexible Cable Assemblies						
LMR-195 Coax, 50 Ohm						
Part No. <a href="#">PE3W00020</a>	Cable Dia.	Attn. @ 1 GHz	Power @ 1 GHz			
1 piece price shown. See web or call for volume pricing.						
12"	24"	36"	48"	60"	50CM	Custom Len.
\$63.74	\$64.52	\$65.32	\$66.13	\$66.92	\$64.24	See Web
PE-P142LL Coax, 50 Ohm						
Part No. <a href="#">PE3C1271</a>	Cable Dia.	Attn. @ 1 GHz	Power @ 1 GHz			
1 piece price shown. See web or call for volume pricing.						
12"	24"	36"	48"	60"	50CM	Custom Len.
\$374.47	\$370.88	\$388.46	\$406.08	\$423.68	\$364.55	See Web
PE-P160LL Coax, 50 Ohm						
Part No. <a href="#">PE3C5284</a>	Cable Dia.	Attn. @ 1 GHz	Power @ 1 GHz			
1 piece price shown. See web or call for volume pricing.						
12"	24"	36"	48"	60"	50CM	Custom Len.
\$350.17	\$372.63	\$395.08	\$417.54	\$439.99	\$364.55	See Web
N MALE RIGHT ANGLE TO TNC FEMALE BULKHEAD						
SEE MOUNTING HOLE SECTION ON PAGE 409						
Low Loss Flexible Cable Assemblies						
PE-P160LL Coax, 50 Ohm						
Part No. <a href="#">PE3C5283</a>	Cable Dia.	Attn. @ 1 GHz	Power @ 1 GHz			
1 piece price shown. See web or call for volume pricing.						
12"	24"	36"	48"	60"	50CM	Custom Len.
\$314.95	\$337.42	\$359.87	\$382.32	\$404.78	\$329.33	See Web
N MALE RIGHT ANGLE TO UHF MALE						
Standard Flexible Cable Assemblies						
RG214/U Coax, 50 Ohm						
Part No. <a href="#">PE38204</a>	Cable Dia.	Attn. @ 1 GHz	Power @ 1 GHz			
1 piece price shown. See web or call for volume pricing.						
12"	24"	36"	48"	60"	-	Custom Len.
\$106.88	\$113.82	\$122.26	\$131.19	\$131.20	-	See Web
N MALE RIGHT ANGLE TO NEX10 MALE						
Low PIM Corrugated Cable Assemblies						
SPP-250-LLPL Coax, 50 Ohm						
Part No. <a href="#">PE3C6257</a>	Cable Dia.	Attn. @ 1 GHz	Power @ 1 GHz			
1 piece price shown. See web or call for volume pricing.						
12"	24"	36"	48"	60"	50CM	Custom Len.
\$68.80	\$74.94	\$81.07	\$87.20	\$93.34	\$72.72	See Web
N FEMALE TO N FEMALE						
Standard Flexible Cable Assemblies						
M17/60-RG142-27478 Coax, 50 Ohm						
Part No. <a href="#">PE3M0011</a>	Cable Dia.	Attn. @ 1 GHz	Power @ 1 GHz			
1 piece price shown. See web or call for volume pricing.						
12"	18"	24"	30"	36"	48"	Custom Len.
\$185.55	\$188.50	\$191.46	\$194.41	\$197.37	\$203.29	See Web
M17/84-RG223-0XDS2 Coax, 50 Ohm						
Part No. <a href="#">PE3M0039</a>	Cable Dia.	Attn. @ 1 GHz	Power @ 1 GHz			
1 piece price shown. See web or call for volume pricing.						
12"	18"	24"	30"	36"	48"	Custom Len.
\$190.21	\$195.50	\$200.79	\$206.07	\$211.36	\$221.94	See Web
M17/128-RG400-27478 Coax, 50 Ohm						
Part No. <a href="#">PE3M0067</a>	Cable Dia.	Attn. @ 1 GHz	Power @ 1 GHz			
1 piece price shown. See web or call for volume pricing.						
12"	18"	24"	30"	36"	48"	Custom Len.
\$187.16	\$190.92	\$194.69	\$198.45	\$202.21	\$209.74	See Web
N FEMALE TO N FEMALE BULKHEAD						
SEE MOUNTING HOLE SECTION ON PAGE 409						
Standard Flexible Cable Assemblies						
M17/60-RG142-27478 Coax, 50 Ohm						
Part No. <a href="#">PE3M0012</a>	Cable Dia.	Attn. @ 1 GHz	Power @ 1 GHz			
1 piece price shown. See web or call for volume pricing.						
12"	18"	24"	30"	36"	48"	Custom Len.
\$189.71	\$192.66	\$195.62	\$198.57	\$201.55	\$207.46	See Web

\*Coax Performance at 1 GHz Notes: Cable assembly max frequency may be lower than connector or coax max frequency



For our complete selection of cable assemblies, please visit our website

M17/84-RG223-0XDS2 Coax, 50 Ohm						
Part No. <a href="#">PE3M0040</a>	Cable Dia.		Attn. @ 1 GHz	Power @ 1 GHz		
1 piece price shown. See web or call for volume pricing.	0.212" dia.					
12"	18"	24"	30"	36"	48"	Custom Len.
\$194.38	\$199.66	\$204.96	\$210.25	\$215.53	\$226.12	See Web

M17/128-RG400-27478 Coax, 50 Ohm						
Part No. <a href="#">PE3M0068</a>	Cable Dia.		Attn. @ 1 GHz	Power @ 1 GHz		
1 piece price shown. See web or call for volume pricing.	0.195" dia.					
12"	18"	24"	30"	36"	48"	Custom Len.
\$191.32	\$195.08	\$198.85	\$202.61	\$206.37	\$213.91	See Web

M17/60-RG142-27478 Coax, 50 Ohm						
Part No. <a href="#">PE3M0017</a>	Cable Dia.		Attn. @ 1 GHz	Power @ 1 GHz		
1 piece price shown. See web or call for volume pricing.	0.195" dia.					
12"	18"	24"	30"	36"	48"	Custom Len.
\$211.28	\$214.24	\$217.20	\$220.15	\$223.11	\$229.03	See Web

M17/84-RG223-0XDS2 Coax, 50 Ohm						
Part No. <a href="#">PE3M0045</a>	Cable Dia.		Attn. @ 1 GHz	Power @ 1 GHz		
1 piece price shown. See web or call for volume pricing.	0.212" dia.					
12"	18"	24"	30"	36"	48"	Custom Len.
\$215.96	\$221.24	\$226.53	\$231.81	\$237.11	\$247.68	See Web

M17/128-RG400-27478 Coax, 50 Ohm						
Part No. <a href="#">PE3M0073</a>	Cable Dia.		Attn. @ 1 GHz	Power @ 1 GHz		
1 piece price shown. See web or call for volume pricing.	0.195" dia.					
12"	18"	24"	30"	36"	48"	Custom Len.
\$212.90	\$216.66	\$220.42	\$224.19	\$227.95	\$235.47	See Web

M17/60-RG142-27478 Coax, 50 Ohm						
Part No. <a href="#">PE3M0018</a>	Cable Dia.		Attn. @ 1 GHz	Power @ 1 GHz		
1 piece price shown. See web or call for volume pricing.	0.195" dia.					
12"	18"	24"	30"	36"	48"	Custom Len.
\$250.41	\$253.36	\$256.32	\$259.28	\$262.24	\$268.15	See Web

M17/84-RG223-0XDS2 Coax, 50 Ohm						
Part No. <a href="#">PE3M0046</a>	Cable Dia.		Attn. @ 1 GHz	Power @ 1 GHz		
1 piece price shown. See web or call for volume pricing.	0.212" dia.					
12"	18"	24"	30"	36"	48"	Custom Len.
\$255.07	\$260.35	\$265.66	\$270.93	\$276.22	\$286.81	See Web

M17/128-RG400-27478 Coax, 50 Ohm						
Part No. <a href="#">PE3M0074</a>	Cable Dia.		Attn. @ 1 GHz	Power @ 1 GHz		
1 piece price shown. See web or call for volume pricing.	0.195" dia.					
12"	18"	24"	30"	36"	48"	Custom Len.
\$252.03	\$255.76	\$259.55	\$263.30	\$267.08	\$274.59	See Web

M17/60-RG142-27478 Coax, 50 Ohm						
Part No. <a href="#">PE3M0019</a>	Cable Dia.		Attn. @ 1 GHz	Power @ 1 GHz		
1 piece price shown. See web or call for volume pricing.	0.195" dia.					
12"	18"	24"	30"	36"	48"	Custom Len.
\$177.99	\$180.94	\$183.91	\$186.86	\$189.82	\$195.73	See Web

M17/84-RG223-0XDS2 Coax, 50 Ohm						
Part No. <a href="#">PE3M0047</a>	Cable Dia.		Attn. @ 1 GHz	Power @ 1 GHz		
1 piece price shown. See web or call for volume pricing.	0.212" dia.					
12"	18"	24"	30"	36"	48"	Custom Len.
\$182.65	\$187.95	\$193.23	\$198.51	\$203.81	\$214.38	See Web

M17/128-RG400-27478 Coax, 50 Ohm						
Part No. <a href="#">PE3M0075</a>	Cable Dia.		Attn. @ 1 GHz	Power @ 1 GHz		
1 piece price shown. See web or call for volume pricing.	0.195" dia.					
12"	18"	24"	30"	36"	48"	Custom Len.
\$179.61	\$183.37	\$187.13	\$190.88	\$194.66	\$202.17	See Web

SPP-250-LLPL Coax, 50 Ohm						
Part No. <a href="#">PE3C4133</a>	Cable Dia.		Attn. @ 1 GHz	Power @ 1 GHz		
1 piece price shown. See web or call for volume pricing.	0.28" dia.					
12"	24"	36"	48"	60"	50CM	Custom Len.
\$101.58	\$107.71	\$112.27	\$118.32	\$124.37	\$105.50	See Web

PE-SR405FLJ Coax, 50 Ohm						
Part No. <a href="#">PE39460</a>	Cable Dia.		Attn. @ 1 GHz	Power @ 1 GHz		
1 piece price shown. See web or call for volume pricing.	0.105" dia.		19.5 dB/100ft	121.5 W		
6"	9"	12"	18"	24"	-	Custom Len.
Call	Call	Call	Call	Call	-	See Web

PE-SR402FLJ Coax, 50 Ohm						
Part No. <a href="#">PE39468</a>	Cable Dia.		Attn. @ 1 GHz	Power @ 1 GHz		
1 piece price shown. See web or call for volume pricing.	0.161" dia.		11.89 dB/100ft	303.4 W		
6"	9"	12"	18"	24"	-	Custom Len.
Call	\$93.79	\$96.03	\$98.03	Call	\$98.88	See Web

SPP-250-LLPL Coax, 50 Ohm						
Part No. <a href="#">PE3C3247</a>	Cable Dia.		Attn. @ 1 GHz	Power @ 1 GHz		
1 piece price shown. See web or call for volume pricing.	0.3" dia.		5.5 dB/100ft	650 W		
12"	24"	36"	48"	60"	50CM	Custom Len.
\$347.77	\$375.10	\$402.42	\$429.74	\$457.06	\$365.27	See Web

PE-P195 Coax, 50 Ohm						
Part No. <a href="#">PE3W02976</a>	Cable Dia.		Attn. @ 1 GHz	Power @ 1 GHz		
1 piece price shown. See web or call for volume pricing.	0.195" dia.		12.5 dB/100ft	650 W		
12"	24"	36"	48"	60"	50CM	Custom Len.
\$58.37	\$69.82	\$81.27	\$92.73	\$104.19	\$65.70	See Web

Formable Cable Assemblies						
PE-SR405FLJ Coax, 50 Ohm						
Part No. <a href="#">PE39460</a>	Cable Dia.		Attn. @ 1 GHz	Power @ 1 GHz		
1 piece price shown. See web or call for volume pricing.	0.105" dia.		19.5 dB/100ft	121.5 W		
6"	9"	12"	18"	24"	-	Custom Len.
Call	Call	Call	Call	Call	-	See Web

Standard Formable Cable Assemblies						
PE-SR402FLJ Coax, 50 Ohm						
Part No. <a href="#">PE39468</a>	Cable Dia.		Attn. @ 1 GHz	Power @ 1 GHz		
1 piece price shown. See web or call for volume pricing.	0.161" dia.		11.89 dB/100ft	303.4 W		
6"	9"	12"	18"	24"	-	Custom Len.
Call	\$93.79	\$96.03	\$98.03	Call	\$98.88	See Web

Corrugated Cable Assemblies						
SPP-250-LLPL Coax, 50 Ohm						
Part No. <a href="#">PE3W07489</a>	Cable Dia.		Attn. @ 1 GHz	Power @ 1 GHz		
1 piece price shown. See web or call for volume pricing.	0.28" dia.					
12"	24"	36"	48"	60"	50CM	Custom Len.
Call	Call	Call	Call	Call	Call	See Web

Low Loss Flexible Cable Assemblies						
LMR-600-DB Coax, 50 Ohm						
Part No. <a href="#">PE3W05453</a>	Cable Dia.		Attn. @ 1 GHz	Power @ 1 GHz		
1 piece price shown. See web or call for volume pricing.	0.59" dia.		2.62 dB/100ft			
12"	18"	24"	36"	48"	60"	Custom Len.
\$80.69	\$79.09	\$80.52	\$83.37	\$86.22	\$89.06	See Web

Low PIM Corrugated Cable Assemblies						
SPO-375 Coax, 50 Ohm						
Part No. <a href="#">PE3C6378</a>	Cable Dia.		Attn. @ 1 GHz	Power @ 1 GHz		
1 piece price shown. See web or call for volume pricing.	0.43" dia.					
12"	24"	36"	48"	60"	50CM	Custom Len.
\$66.36	\$86.06	\$105.77	\$123.73	\$143.16	\$78.99	See Web

Low Loss Test Flexible Cable Assemblies						
PE-P300LL Coax, 50 Ohm						
Part No. <a href="#">PE3C3234</a>	Cable Dia.		Attn. @ 1 GHz	Power @ 1 GHz		
1 piece price shown. See web or call for volume pricing.	0.3" dia.		5.5 dB/100ft			
12"	24"	36"	48"	60"	50CM	Custom Len.
\$291.93	\$319.23	\$346.53	\$373.83	\$401.14	\$309.43	See Web

Standard Corrugated Cable Assemblies						
PE-1/4SFHC Coax, 50 Ohm						
Part No. <a href="#">PE3C0126</a>	Cable Dia.		Attn. @ 1 GHz	Power @ 1 GHz		
1 piece price shown. See web or call for volume pricing.	0.303" dia.		5.85 dB/100ft			
12"	24"	36"	48"	60"	-	Custom Len.
\$153.33	\$142.41	\$160.07	\$148.46	\$151.47	-	See Web

Low Loss Test Flexible Cable Assemblies						
PE-P300LL Coax, 50 Ohm						
Part No. <a href="#">PE3C3247</a>	Cable Dia.		Attn. @ 1 GHz	Power @ 1 GHz		
1 piece price shown. See web or call for volume pricing.	0.3" dia.		5.5 dB/100ft			
12"	24"	36"	48"	60"	50CM	Custom Len.
\$347.77	\$375.10	\$402.42	\$429.74	\$457.06	\$365.27	See Web

Standard Flexible Cable Assemblies						
PE-P195 Coax, 50 Ohm						
Part No. <a href="#">PE3W02976</a>	Cable Dia.		Attn. @ 1 GHz	Power @ 1 GHz		
1 piece price shown. See web or call for volume pricing.	0.195" dia.		12.5 dB/100ft	650 W		
12"	24"	36"	48"	60"	50CM	Custom Len.
\$58.37	\$69.82	\$81.27	\$92.73	\$104.19	\$65.70	See Web

N FEMALE TO N FEMALE BULKHEAD						
SEE MOUNTING HOLE SECTION ON PAGE 409						
Low Loss Test Flexible Cable Assemblies						
PE-P300LL Coax, 50 Ohm						
Part No. <a href="#">PE3C3247</a>	Cable Dia.		Attn. @ 1 GHz	Power @ 1 GHz		
1 piece price shown. See web or call for volume pricing.	0.3" dia.		5.5 dB/100ft			
12"	24"	36"	48"	60"	50CM	Custom Len.
\$347.77	\$375.10	\$402.42	\$429.74	\$457.06	\$365.27	See Web

Standard Flexible Cable Assemblies						
PE-P195 Coax, 50 Ohm						
Part No. <a href="#">PE3W02976</a>	Cable Dia.		Attn. @ 1 GHz	Power @ 1 GHz		
1 piece price shown. See web or call for volume pricing.	0.195" dia.		12.5 dB/100ft	650 W		
12"	24"	36"	48"	60"	50CM	Custom Len.
\$58.37	\$69.82	\$81.27	\$92.73	\$104.19	\$65.70	See Web

N FEMALE TO QN MALE						
Low Loss Flexible Cable Assemblies						

N FEMALE TO SMA MALE						
Standard Flexible Cable Assemblies						
M17/60-RG142-27478 Coax, 50 Ohm						
Part No. <a href="#">PE3M0018</a>	Cable Dia.		Attn. @ 1 GHz	Power @ 1 GHz		
1 piece price shown. See web or call for volume pricing.	0.195" dia.					
12"	18"	24"	30"	36"	48"	Custom Len.
\$250.41	\$253.36	\$256.32	\$259.28	\$262.24	\$268.15	See Web

Standard Flexible Cable Assemblies						
M17/84-RG223-0XDS2 Coax, 50 Ohm						
Part No. <a href="#">PE3M0045</a>	Cable Dia.		Attn. @ 1 GHz	Power @ 1 GHz		
1 piece price shown. See web or call for volume pricing.	0.212" dia.					
12"	18"	24"	30"	36"	48"	Custom Len.
\$215.96	\$221.24	\$226.53	\$231.81	\$237.11	\$247.68	See Web

Standard Flexible Cable Assemblies						
M17/128-RG400-27478 Coax, 50 Ohm						
Part No. <a href="#">PE3M0073</a>	Cable Dia.		Attn. @ 1 GHz	Power @ 1 GHz		
1 piece price shown. See web or call for volume pricing.	0.195" dia.					
12"	18"	24"	30"	36"	48"	Custom Len.
\$212.90	\$216.66	\$220.42	\$224.19	\$227.95	\$235.47	See Web

Standard Flexible Cable Assemblies						
M17/60-RG142-27478 Coax, 50 Ohm						
Part No. <a href="#">PE3M0018</a>	Cable Dia.		Attn. @ 1 GHz	Power @ 1 GHz		
1 piece price shown. See web or call for volume pricing.	0.195" dia.					
12"	18"	24"	30"	36"	48"	Custom Len.
\$250.41	\$253.36	\$256.32	\$259.28	\$262.24	\$268.15	See Web

Standard Flexible Cable Assemblies						
M17/84-RG223-0XDS2 Coax, 50 Ohm						
Part No. <a href="#">PE3M0045</a>	Cable Dia.		Attn. @ 1 GHz	Power @ 1 GHz		
1 piece price shown. See web or call for volume pricing.	0.212" dia.					
12"	18"	24"	30"			



For our complete selection of cable assemblies, please visit our website

Cable Assemblies

See Our Website For Current Pricing & Real-Time Stock Availability!

PE-C195 Coax, 50 Ohm							
Part No. <a href="#">PE38457</a>	Cable Dia.			Attn. @ 1 GHz	Power @ 1 GHz		
1 piece price shown. See web or call for volume pricing.	0.195" dia.			11.3dB/100ft	150 W		
12"	24"	36"	48"	60"	72"	Custom Len.	
\$71.32	\$72.11	\$72.89	\$73.66	\$74.45	\$75.25	See Web	

**Standard Flexible Cable Assemblies**

RG58C/U Coax, 50 Ohm							
Part No. <a href="#">PE38456</a>	Cable Dia.			Attn. @ 1 GHz	Power @ 1 GHz		
1 piece price shown. See web or call for volume pricing.	0.195" dia.			20 dB/100ft	44 W		
12"	24"	36"	48"	60"	72"	Custom Len.	
\$70.57	\$71.43	\$72.22	\$73.01	\$73.80	\$74.61	See Web	

RG213/U Coax, 50 Ohm							
Part No. <a href="#">PE38454</a>	Cable Dia.			Attn. @ 1 GHz	Power @ 1 GHz		
1 piece price shown. See web or call for volume pricing.	0.405" dia.			8 dB/100ft	190 W		
12"	24"	36"	48"	60"	72"	Custom Len.	
\$112.47	\$114.29	\$116.12	\$117.93	\$119.75	\$121.51	See Web	

RG223/U Coax, 50 Ohm							
Part No. <a href="#">PE38455</a>	Cable Dia.			Attn. @ 1 GHz	Power @ 1 GHz		
1 piece price shown. See web or call for volume pricing.	0.21" dia.			13.4dB/100ft	53 W		
12"	24"	36"	48"	60"	72"	Custom Len.	
\$69.77	\$72.95	\$76.18	\$79.34	\$82.58	\$85.81	See Web	

**N FEMALE TO QN MALE RIGHT ANGLE**



**Low Loss Flexible Cable Assemblies**

PE-C195 Coax, 50 Ohm							
Part No. <a href="#">PE38494</a>	Cable Dia.			Attn. @ 1 GHz	Power @ 1 GHz		
1 piece price shown. See web or call for volume pricing.	0.195" dia.			11.3dB/100ft	150 W		
12"	24"	36"	48"	60"	72"	Custom Len.	
\$71.71	\$72.41	\$73.21	\$73.93	\$74.73	\$83.25	See Web	

**Standard Flexible Cable Assemblies**

RG58C/U Coax, 50 Ohm							
Part No. <a href="#">PE38493</a>	Cable Dia.			Attn. @ 1 GHz	Power @ 1 GHz		
1 piece price shown. See web or call for volume pricing.	0.195" dia.			20 dB/100ft	44 W		
12"	24"	36"	48"	60"	72"	Custom Len.	
\$84.96	\$85.76	\$86.53	\$87.33	\$88.20	\$88.98	See Web	

RG213/U Coax, 50 Ohm							
Part No. <a href="#">PE38495</a>	Cable Dia.			Attn. @ 1 GHz	Power @ 1 GHz		
1 piece price shown. See web or call for volume pricing.	0.405" dia.			8 dB/100ft	190 W		
12"	24"	36"	48"	60"	72"	Custom Len.	
\$99.13	\$101.00	\$102.83	\$104.69	\$106.53	\$106.82	See Web	

RG223/U Coax, 50 Ohm							
Part No. <a href="#">PE38496</a>	Cable Dia.			Attn. @ 1 GHz	Power @ 1 GHz		
1 piece price shown. See web or call for volume pricing.	0.21" dia.			13.4dB/100ft	53 W		
12"	24"	36"	48"	60"	72"	Custom Len.	
\$74.73	\$77.96	\$81.13	\$84.36	\$87.53	\$90.77	See Web	

**N FEMALE TO SMA MALE**



**Low PIM Corrugated Cable Assemblies**

SPP-250-LLPL Coax, 50 Ohm							
Part No. <a href="#">PE3C6215</a>	Cable Dia.			Attn. @ 1 GHz	Power @ 1 GHz		
1 piece price shown. See web or call for volume pricing.	0.28" dia.			5.5 dB/100ft	650 W		
12"	24"	36"	48"	60"	50CM	Custom Len.	
\$52.84	\$58.49	\$64.62	\$70.76	\$76.88	\$56.27	See Web	

**N FEMALE TO SMA MALE RIGHT ANGLE**

**Low Loss Flexible Cable Assemblies**

LMR-240-UF Coax, 50 Ohm							
Part No. <a href="#">PE3W04423</a>	Cable Dia.			Attn. @ 1 GHz	Power @ 1 GHz		
1 piece price shown. See web or call for volume pricing.	0.24" dia.			9.19 dB/100ft			
12"	24"	36"	48"	60"	50CM	Custom Len.	
\$57.80	\$59.28	\$60.75	\$62.23	\$63.74	\$58.76	See Web	

**Low PIM Corrugated Cable Assemblies**

SPP-250-LLPL Coax, 50 Ohm							
Part No. <a href="#">PE3C6217</a>	Cable Dia.			Attn. @ 1 GHz	Power @ 1 GHz		
1 piece price shown. See web or call for volume pricing.	0.28" dia.			5.5 dB/100ft	650 W		
12"	24"	36"	48"	60"	50CM	Custom Len.	
\$57.61	\$63.75	\$69.88	\$76.00	\$82.14	\$61.52	See Web	

**N FEMALE TO TNC MALE**



**Low Loss Test Flexible Cable Assemblies**

PE-P300LL Coax, 50 Ohm							
Part No. <a href="#">PE3C3244</a>	Cable Dia.			Attn. @ 1 GHz	Power @ 1 GHz		
1 piece price shown. See web or call for volume pricing.	0.3" dia.			5.5 dB/100ft			
12"	24"	36"	48"	60"	50CM	Custom Len.	
\$265.55	\$292.88	\$320.21	\$347.53	\$374.86	\$283.05	See Web	

**N FEMALE TO NEX10 MALE**

**Low PIM Corrugated Cable Assemblies**

SPP-250-LLPL Coax, 50 Ohm							
Part No. <a href="#">PE3C6254</a>	Cable Dia.			Attn. @ 1 GHz	Power @ 1 GHz		
1 piece price shown. See web or call for volume pricing.	0.28" dia.			5.5 dB/100ft	650 W		
12"	24"	36"	48"	60"	50CM	Custom Len.	
\$66.18	\$72.31	\$78.45	\$84.58	\$90.71	\$70.09	See Web	

**N FEMALE BULKHEAD TO N FEMALE BULKHEAD**



SEE MOUNTING HOLE SECTION ON PAGE 409

**Standard Flexible Cable Assemblies**

M17/60-RG142-27478 Coax, 50 Ohm							
Part No. <a href="#">PE3M0013</a>	Cable Dia.			Attn. @ 1 GHz	Power @ 1 GHz		
1 piece price shown. See web or call for volume pricing.	0.195" dia.						
12"	18"	24"	30"	36"	48"	Custom Len.	
\$193.88	\$196.83	\$199.80	\$202.75	\$205.71	\$211.63	See Web	

M17/84-RG223-0XDS2 Coax, 50 Ohm							
Part No. <a href="#">PE3M0041</a>	Cable Dia.			Attn. @ 1 GHz	Power @ 1 GHz		
1 piece price shown. See web or call for volume pricing.	0.212" dia.						
12"	18"	24"	30"	36"	48"	Custom Len.	
\$198.54	\$203.84	\$209.13	\$214.40	\$219.70	\$230.28	See Web	

M17/128-RG400-27478 Coax, 50 Ohm							
Part No. <a href="#">PE3M0069</a>	Cable Dia.			Attn. @ 1 GHz	Power @ 1 GHz		
1 piece price shown. See web or call for volume pricing.	0.195" dia.						
12"	18"	24"	30"	36"	48"	Custom Len.	
\$195.50	\$199.26	\$203.03	\$206.79	\$210.54	\$218.07	See Web	

**N FEMALE BULKHEAD TO SMA MALE**



SEE MOUNTING HOLE SECTION ON PAGE 409

**Standard Flexible Cable Assemblies**

M17/60-RG142-27478 Coax, 50 Ohm							
Part No. <a href="#">PE3M0020</a>	Cable Dia.			Attn. @ 1 GHz	Power @ 1 GHz		
1 piece price shown. See web or call for volume pricing.	0.195" dia.						
12"	18"	24"	30"	36"	48"	Custom Len.	
\$215.45	\$218.40	\$221.37	\$224.33	\$227.29	\$233.20	See Web	

M17/84-RG223-0XDS2 Coax, 50 Ohm							
Part No. <a href="#">PE3M0048</a>	Cable Dia.			Attn. @ 1 GHz	Power @ 1 GHz		
1 piece price shown. See web or call for volume pricing.	0.212" dia.						
12"	18"	24"	30"	36"	48"	Custom Len.	
\$220.12	\$225.40	\$230.71	\$235.98	\$241.27	\$251.86	See Web	

M17/128-RG400-27478 Coax, 50 Ohm							
Part No. <a href="#">PE3M0076</a>	Cable Dia.			Attn. @ 1 GHz	Power @ 1 GHz		
1 piece price shown. See web or call for volume pricing.	0.195" dia.						
12"	18"	24"	30"	36"	48"	Custom Len.	
\$217.06	\$220.83	\$224.59	\$228.36	\$232.12	\$239.64	See Web	

**N FEMALE BULKHEAD TO SMA MALE RIGHT ANGLE**



SEE MOUNTING HOLE SECTION ON PAGE 409

**Standard Flexible Cable Assemblies**

M17/60-RG142-27478 Coax, 50 Ohm							
Part No. <a href="#">PE3M0021</a>	Cable Dia.			Attn. @ 1 GHz	Power @ 1 GHz		
1 piece price shown. See web or call for volume pricing.	0.195" dia.						
12"	18"	24"	30"	36"	48"	Custom Len.	
\$254.57	\$257.53	\$260.49	\$263.44	\$266.40	\$272.33	See Web	

M17/84-RG223-0XDS2 Coax, 50 Ohm							
Part No. <a href="#">PE3M0049</a>	Cable Dia.			Attn. @ 1 GHz	Power @ 1 GHz		
1 piece price shown. See web or call for volume pricing.	0.212" dia.						
12"	18"	24"	30"	36"	48"	Custom Len.	
\$259.25	\$264.53	\$269.81	\$275.09	\$280.40	\$290.97	See Web	

M17/128-RG400-27478 Coax, 50 Ohm							
Part No. <a href="#">PE3M0077</a>	Cable Dia.			Attn. @ 1 GHz	Power @ 1 GHz		
1 piece price shown. See web or call for volume pricing.	0.195" dia.						
12"	18"	24"	30"	36"	48"	Custom Len.	
\$256.19	\$259.94	\$263.71	\$267.47	\$271.24	\$278.76	See Web	

**N FEMALE BULKHEAD TO TNC MALE**



SEE MOUNTING HOLE SECTION ON PAGE 409

**Standard Flexible Cable Assemblies**

\*Coax Performance at 1 GHz Notes: Cable assembly max frequency may be lower than connector or coax max frequency

For our complete selection of cable assemblies, please visit our website

M17/60-RG142-27478 Coax, 50 Ohm						
Part No. <a href="#">PE3M0022</a>	1 piece price shown. See web or call for volume pricing.			Cable Dia.	Attn. @ 1 GHz	Power @ 1 GHz
12"	18"	24"	30"	0.195" dia.		
\$200.37	\$185.11	\$188.07	\$191.02	\$193.99	\$199.89	Custom Len. See Web
M17/84-RG223-0XDS2 Coax, 50 Ohm						
Part No. <a href="#">PE3M0050</a>	1 piece price shown. See web or call for volume pricing.			Cable Dia.	Attn. @ 1 GHz	Power @ 1 GHz
12"	18"	24"	30"	0.212" dia.		
\$186.83	\$192.10	\$197.39	\$202.69	\$207.98	\$218.55	Custom Len. See Web
M17/128-RG400-27478 Coax, 50 Ohm						
Part No. <a href="#">PE3M0078</a>	1 piece price shown. See web or call for volume pricing.			Cable Dia.	Attn. @ 1 GHz	Power @ 1 GHz
12"	18"	24"	30"	0.195" dia.		
\$183.77	\$187.53	\$191.29	\$195.05	\$198.82	\$206.34	Custom Len. See Web

**N FEMALE BULKHEAD TO MCX PLUG RIGHT ANGLE**

SEE MOUNTING HOLE SECTION ON PAGE 409



**Precision Formable Cable Assemblies**

PE-SR405FL Coax, 50 Ohm						
Part No. <a href="#">PE39449</a>	1 piece price shown. See web or call for volume pricing.			Cable Dia.	Attn. @ 1 GHz	Power @ 1 GHz
6"	9"	12"	18"	24"	22.5 dB/100ft	130 W
\$56.16	Call	Call	\$68.47	Call	-	Custom Len. See Web
PE-SR405FLJ Coax, 50 Ohm						
Part No. <a href="#">PE39463</a>	1 piece price shown. See web or call for volume pricing.			Cable Dia.	Attn. @ 1 GHz	Power @ 1 GHz
6"	9"	12"	18"	24"	0.098" dia.	19.5 dB/100ft
\$54.17	\$54.17	Call	\$58.42	\$62.69	Call	Custom Len. See Web

**N FEMALE BULKHEAD TO MMCX PLUG RIGHT ANGLE**

SEE MOUNTING HOLE SECTION ON PAGE 409



**Precision Formable Cable Assemblies**

PE-SR405FL Coax, 50 Ohm						
Part No. <a href="#">PE39450</a>	1 piece price shown. See web or call for volume pricing.			Cable Dia.	Attn. @ 1 GHz	Power @ 1 GHz
6"	9"	12"	18"	24"	22.5 dB/100ft	130 W
\$57.12	Call	\$61.68	\$63.00	\$68.87	-	Custom Len. See Web
PE-SR405FLJ Coax, 50 Ohm						
Part No. <a href="#">PE39464</a>	1 piece price shown. See web or call for volume pricing.			Cable Dia.	Attn. @ 1 GHz	Power @ 1 GHz
6"	9"	12"	18"	24"	0.098" dia.	19.5 dB/100ft
\$54.60	\$56.88	\$54.77	\$59.04	\$63.29	Call	Custom Len. See Web

**N FEMALE BULKHEAD TO N MALE**

SEE MOUNTING HOLE SECTION ON PAGE 409



**Standard Flexible Cable Assemblies**

PE-P141EAM Coax, 50 Ohm						
Part No. <a href="#">PE3CA1050</a>	1 piece price shown. See web or call for volume pricing.			Cable Dia.	Attn. @ 1 GHz	Power @ 1 GHz
12"	24"	36"	50CM	0.163" dia.	-	Custom Len.
\$101.54	\$119.07	\$138.03	\$112.27	\$143.32	-	See Web

**N FEMALE BULKHEAD TO N MALE RIGHT ANGLE**

SEE MOUNTING HOLE SECTION ON PAGE 409



**Low Loss Flexible Cable Assemblies**

PE-P142LL-27478 Coax, 50 Ohm						
Part No. <a href="#">PE3M0178</a>	1 piece price shown. See web or call for volume pricing.			Cable Dia.	Attn. @ 1 GHz	Power @ 1 GHz
12"	18"	24"	36"	0.195" dia.		
\$620.47	\$629.66	\$638.86	\$657.24	\$675.62	\$694.01	Custom Len. See Web
PE-P160LL-27478 Coax, 50 Ohm						
Part No. <a href="#">PE3M0223</a>	1 piece price shown. See web or call for volume pricing.			Cable Dia.	Attn. @ 1 GHz	Power @ 1 GHz
8"	12"	24"	30"	0.16" dia.		
\$586.19	\$591.52	\$599.47	\$607.45	\$615.42	\$623.38	Custom Len. See Web
PE-P300LL-27478 Coax, 50 Ohm						
Part No. <a href="#">PE3M0251</a>	1 piece price shown. See web or call for volume pricing.			Cable Dia.	Attn. @ 1 GHz	Power @ 1 GHz
12"	18"	24"	36"	0.3" dia.		
\$692.44	\$707.78	\$723.13	\$753.81	\$784.49	\$815.18	Custom Len. See Web
Standard Formable Cable Assemblies						
PE-SR402FLJ Coax, 50 Ohm						
Part No. <a href="#">PE3W03365</a>	1 piece price shown. See web or call for volume pricing.			Cable Dia.	Attn. @ 1 GHz	Power @ 1 GHz
12"	24"	36"	48"	0.161" dia.	11.89 dB/100ft	303.4 W
\$82.80	\$92.56	\$102.32	\$110.54	\$120.17	\$89.04	Custom Len. See Web

N FEMALE BULKHEAD TO N FEMALE BULKHEAD						
SEE MOUNTING HOLE SECTION ON PAGE 409						
Low Loss Flexible Cable Assemblies						
PE-P142LL Coax, 50 Ohm						
Part No. <a href="#">PE3C1000</a>	1 piece price shown. See web or call for volume pricing.			Cable Dia.	Attn. @ 1 GHz	Power @ 1 GHz
12"	24"	36"	48"	0.195" dia.	7.2 dB/100ft	50CM
\$240.61	\$257.70	\$274.79	\$291.87	\$308.95	\$251.57	Custom Len. See Web
PE-P160LL Coax, 50 Ohm						
Part No. <a href="#">PE3C5256</a>	1 piece price shown. See web or call for volume pricing.			Cable Dia.	Attn. @ 1 GHz	Power @ 1 GHz
12"	24"	36"	48"	0.16" dia.		
\$279.74	\$302.20	\$324.65	\$347.11	\$369.56	\$294.13	Custom Len. See Web
PE-P142LL-27478 Coax, 50 Ohm						
Part No. <a href="#">PE3M0177</a>	1 piece price shown. See web or call for volume pricing.			Cable Dia.	Attn. @ 1 GHz	Power @ 1 GHz
12"	18"	24"	36"	0.195" dia.		
\$590.30	\$599.49	\$608.67	\$627.07	\$645.45	\$663.83	Custom Len. See Web
PE-P160LL-27478 Coax, 50 Ohm						
Part No. <a href="#">PE3M0222</a>	1 piece price shown. See web or call for volume pricing.			Cable Dia.	Attn. @ 1 GHz	Power @ 1 GHz
8"	12"	18"	24"	0.16" dia.		
\$590.46	\$595.79	\$603.74	\$611.72	\$619.68	\$627.66	Custom Len. See Web
PE-P300LL-27478 Coax, 50 Ohm						
Part No. <a href="#">PE3M0250</a>	1 piece price shown. See web or call for volume pricing.			Cable Dia.	Attn. @ 1 GHz	Power @ 1 GHz
12"	18"	24"	36"	0.3" dia.		
\$617.34	\$632.69	\$648.04	\$678.72	\$709.40	\$740.08	Custom Len. See Web
Low Loss Test Flexible Cable Assemblies						
PE-P300LL Coax, 50 Ohm						
Part No. <a href="#">PE3C3232</a>	1 piece price shown. See web or call for volume pricing.			Cable Dia.	Attn. @ 1 GHz	Power @ 1 GHz
12"	24"	36"	48"	0.3" dia.	5.5 dB/100ft	50CM
\$283.23	\$310.53	\$337.82	\$365.13	\$392.44	\$300.72	Custom Len. See Web
N FEMALE BULKHEAD TO QMA MALE RIGHT ANGLE						
SEE MOUNTING HOLE SECTION ON PAGE 409						
Standard Flexible Cable Assemblies						
RG316/U Coax, 50 Ohm						
Part No. <a href="#">PE3C4238</a>	1 piece price shown. See web or call for volume pricing.			Cable Dia.	Attn. @ 1 GHz	Power @ 1 GHz
12"	24"	36"	48"	0.098" dia.	38 dB/100ft	160 W
\$71.57	\$74.90	\$78.24	\$81.57	\$84.90	\$73.70	Custom Len. See Web
N FEMALE BULKHEAD TO SMA MALE						
SEE MOUNTING HOLE SECTION ON PAGE 409						
Low Loss Flexible Cable Assemblies						
PE-P160LL Coax, 50 Ohm						
Part No. <a href="#">PE3C5274</a>	1 piece price shown. See web or call for volume pricing.			Cable Dia.	Attn. @ 1 GHz	Power @ 1 GHz
12"	24"	36"	48"	0.16" dia.		
\$251.25	\$273.71	\$296.15	\$318.61	\$341.07	\$265.63	Custom Len. See Web
Low PIM Corrugated Cable Assemblies						
SPP-250-LLPL Coax, 50 Ohm						
Part No. <a href="#">PE3C6214</a>	1 piece price shown. See web or call for volume pricing.			Cable Dia.	Attn. @ 1 GHz	Power @ 1 GHz
12"	24"	36"	48"	0.28" dia.	5.5 dB/100ft	650 W
\$52.84	\$58.49	\$64.62	\$70.76	\$76.88	\$56.27	Custom Len. See Web
N FEMALE BULKHEAD TO SMA MALE RIGHT ANGLE						
SEE MOUNTING HOLE SECTION ON PAGE 409						
Flexible Cable Assemblies						
PE-P195 Coax, 50 Ohm						
Part No. <a href="#">PE3W06405</a>	1 piece price shown. See web or call for volume pricing.			Cable Dia.	Attn. @ 1 GHz	Power @ 1 GHz
12"	24"	36"	48"	0.195" dia.	12.5 dB/100ft	650 W
\$56.38	\$67.84	\$79.29	\$90.75	\$102.21	\$63.72	Custom Len. See Web
Low Loss Flexible Cable Assemblies						
PE-P160LL Coax, 50 Ohm						
Part No. <a href="#">PE3C5276</a>	1 piece price shown. See web or call for volume pricing.			Cable Dia.	Attn. @ 1 GHz	Power @ 1 GHz
12"	24"	36"	48"	0.16" dia.		
\$291.47	\$313.95	\$336.40	\$358.84	\$381.31	\$305.86	Custom Len. See Web

Cable Assemblies

See Our Website For Current Pricing & Real-Time Stock Availability!

For Custom Lengths, Metric Lengths or Special Configurations, Please call (949) 261-1920



Technical Support  
+1 (949) 261-1920



Same-Day Shipping,  
Even Custom Cable Assemblies

For our complete selection of cable assemblies, please visit our website

Cable Assemblies

See Our Website For Current Pricing & Real-Time Stock Availability!

Low PIM Corrugated Cable Assemblies						
SPP-250-LLPL Coax, 50 Ohm						
Part No. <a href="#">PE3C6216</a>	Cable Dia.	Attn. @ 1 GHz	Power @ 1 GHz			
1 piece price shown. See web or call for volume pricing.						
12"	24"	36"	48"	60"	50CM	Custom Len.
\$57.61	\$63.75	\$69.88	\$76.00	\$82.14	\$61.52	See Web

**N FEMALE BULKHEAD TO SMA FEMALE**  
SEE MOUNTING HOLE SECTION ON PAGE 409

Flexible Cable Assemblies						
LMR-400-UF Coax, 50 Ohm						
Part No. <a href="#">PE3W05630</a>	Cable Dia.	Attn. @ 1 GHz	Power @ 1 GHz			
1 piece price shown. See web or call for volume pricing.						
12"	24"	36"	48"	60"	50CM	Custom Len.
\$93.69	\$96.58	\$99.46	\$102.35	\$105.24	\$95.54	See Web

**N FEMALE BULKHEAD TO SMA FEMALE BULKHEAD**  
SEE MOUNTING HOLE SECTION ON PAGE 409

Standard Flexible Cable Assemblies						
PE-P160LL Coax, 50 Ohm						
Part No. <a href="#">PE3C5278</a>	Cable Dia.	Attn. @ 1 GHz	Power @ 1 GHz			
1 piece price shown. See web or call for volume pricing.						
12"	24"	36"	48"	60"	50CM	Custom Len.
\$269.68	\$269.68	\$269.68	\$269.68	\$269.68	\$269.68	See Web

**N FEMALE BULKHEAD TO REVERSE POLARITY SMA MALE RIGHT ANGLE**  
SEE MOUNTING HOLE SECTION ON PAGE 409

Standard Flexible Cable Assemblies						
RG400/U Coax, 50 Ohm						
Part No. <a href="#">PE3C5030</a>	Cable Dia.	Attn. @ 1 GHz	Power @ 1 GHz			
1 piece price shown. See web or call for volume pricing.						
12"	24"	36"	48"	60"	50CM	Custom Len.
\$91.96	\$94.63	\$102.53	\$108.89	\$116.68	\$91.80	See Web

**N FEMALE BULKHEAD TO SMP FEMALE RIGHT ANGLE**  
SEE MOUNTING HOLE SECTION ON PAGE 409

Standard Flexible Cable Assemblies						
RG178B/U Coax, 50 Ohm						
Part No. <a href="#">PE3W04763</a>	Cable Dia.	Attn. @ 1 GHz	Power @ 1 GHz			
1 piece price shown. See web or call for volume pricing.						
12"	24"	36"	48"	60"	50CM	Custom Len.
\$80.72	\$81.84	\$82.97	\$84.10	\$85.24	\$81.45	See Web

**N FEMALE BULKHEAD TO TNC MALE**  
SEE MOUNTING HOLE SECTION ON PAGE 409

Low Loss Flexible Cable Assemblies						
PE-P142LL Coax, 50 Ohm						
Part No. <a href="#">PE3C1110</a>	Cable Dia.	Attn. @ 1 GHz	Power @ 1 GHz			
1 piece price shown. See web or call for volume pricing.						
12"	24"	36"	48"	60"	50CM	Custom Len.
\$203.47	\$220.58	\$238.85	\$254.73	\$271.82	\$214.42	See Web

Low Loss Test Flexible Cable Assemblies						
PE-P160LL Coax, 50 Ohm						
Part No. <a href="#">PE3C5270</a>	Cable Dia.	Attn. @ 1 GHz	Power @ 1 GHz			
1 piece price shown. See web or call for volume pricing.						
12"	24"	36"	48"	60"	50CM	Custom Len.
\$251.25	\$273.71	\$296.15	\$318.61	\$341.07	\$265.63	See Web

Low Loss Test Flexible Cable Assemblies						
PE-P300LL Coax, 50 Ohm						
Part No. <a href="#">PE3C1084</a>	Cable Dia.	Attn. @ 1 GHz	Power @ 1 GHz			
1 piece price shown. See web or call for volume pricing.						
12"	24"	36"	48"	60"	50CM	Custom Len.
\$275.03	\$302.33	\$329.63	\$356.94	\$384.23	\$292.53	See Web

**N FEMALE BULKHEAD TO TNC MALE RIGHT ANGLE**  
SEE MOUNTING HOLE SECTION ON PAGE 409

Low Loss Flexible Cable Assemblies						
LMR-240 Coax, 50 Ohm						
Part No. <a href="#">PE3W00415</a>	Cable Dia.	Attn. @ 1 GHz	Power @ 1 GHz			
1 piece price shown. See web or call for volume pricing.						
12"	24"	36"	48"	60"	50CM	Custom Len.
\$59.02	\$60.05	\$61.10	\$62.13	\$63.16	\$59.69	See Web

PE-P160LL Coax, 50 Ohm						
Part No. <a href="#">PE3C5271</a>	Cable Dia.	Attn. @ 1 GHz	Power @ 1 GHz			
1 piece price shown. See web or call for volume pricing.						
12"	24"	36"	48"	60"	50CM	Custom Len.
\$314.95	\$337.42	\$359.87	\$382.32	\$404.78	\$329.33	See Web

**N FEMALE BULKHEAD TO TNC FEMALE BULKHEAD**  
SEE MOUNTING HOLE SECTION ON PAGE 409

Low Loss Flexible Cable Assemblies						
PE-P160LL Coax, 50 Ohm						
Part No. <a href="#">PE3C5272</a>	Cable Dia.	Attn. @ 1 GHz	Power @ 1 GHz			
1 piece price shown. See web or call for volume pricing.						
12"	24"	36"	48"	60"	50CM	Custom Len.
\$279.74	\$302.20	\$324.65	\$347.11	\$369.56	\$294.13	See Web

**N FEMALE BULKHEAD TO HMCX32 1.2 PLUG**  
SEE MOUNTING HOLE SECTION ON PAGE 409

Standard Flexible Cable Assemblies						
PE-81mm Coax, 50 Ohm						
Part No. <a href="#">PE3CA1015</a>	Cable Dia.	Attn. @ 1 GHz	Power @ 1 GHz			
1 piece price shown. See web or call for volume pricing.						
3"	6"	12"	-	-	-	Custom Len.
Call	\$23.27	Call	-	-	-	See Web

**N FEMALE BULKHEAD TO UMCX 2.1 PLUG**  
SEE MOUNTING HOLE SECTION ON PAGE 409

Standard Flexible Cable Assemblies						
PE-81mm Coax, 50 Ohm						
Part No. <a href="#">PE3CA1013</a>	Cable Dia.	Attn. @ 1 GHz	Power @ 1 GHz			
1 piece price shown. See web or call for volume pricing.						
3"	6"	12"	-	-	-	Custom Len.
Call	\$23.27	\$23.27	-	-	-	See Web

**N FEMALE BULKHEAD TO UMCX 2.5 PLUG**  
SEE MOUNTING HOLE SECTION ON PAGE 409

Standard Flexible Cable Assemblies						
RG178B/U Coax, 50 Ohm						
Part No. <a href="#">PE3CA1011</a>	Cable Dia.	Attn. @ 1 GHz	Power @ 1 GHz			
1 piece price shown. See web or call for volume pricing.						
3"	6"	9"	12"	-	-	Custom Len.
Call	\$21.64	\$20.19	\$21.63	-	-	See Web

Standard Flexible Cable Assemblies						
RG178-DS Coax, 50 Ohm						
Part No. <a href="#">PE3CA1012</a>	Cable Dia.	Attn. @ 1 GHz	Power @ 1 GHz			
1 piece price shown. See web or call for volume pricing.						
3"	6"	9"	12"	-	-	Custom Len.
Call	\$20.19	\$24.56	\$21.63	-	-	See Web

Standard Flexible Cable Assemblies						
PE-81mm Coax, 50 Ohm						
Part No. <a href="#">PE3CA1008</a>	Cable Dia.	Attn. @ 1 GHz	Power @ 1 GHz			
1 piece price shown. See web or call for volume pricing.						
3"	6"	12"	-	-	-	Custom Len.
Call	\$20.19	Call	-	-	-	See Web

Standard Flexible Cable Assemblies						
PE-113mm Coax, 50 Ohm						
Part No. <a href="#">PE3CA1009</a>	Cable Dia.	Attn. @ 1 GHz	Power @ 1 GHz			
1 piece price shown. See web or call for volume pricing.						
3"	6"	12"	-	-	-	Custom Len.
Call	\$20.19	\$23.27	-	-	-	See Web

Standard Flexible Cable Assemblies						
PE-137mm Coax, 50 Ohm						
Part No. <a href="#">PE3CA1010</a>	Cable Dia.	Attn. @ 1 GHz	Power @ 1 GHz			
1 piece price shown. See web or call for volume pricing.						
3"	6"	12"	20CM	-	-	Custom Len.
Call	\$20.19	\$23.42	Call	-	-	See Web

**N FEMALE BULKHEAD TO WMCX 1.6 PLUG**  
SEE MOUNTING HOLE SECTION ON PAGE 409

Standard Flexible Cable Assemblies						
PE-81mm Coax, 50 Ohm						
Part No. <a href="#">PE3CA1014</a>	Cable Dia.	Attn. @ 1 GHz	Power @ 1 GHz			
1 piece price shown. See web or call for volume pricing.						
3"	6"	12"	-	-	-	Custom Len.
Call	Call	\$22.47	-	-	-	See Web

**N FEMALE BULKHEAD TO NEX10 MALE**  
SEE MOUNTING HOLE SECTION ON PAGE 409

Low PIM Corrugated Cable Assemblies

\*Coax Performance at 1 GHz Notes: Cable assembly max frequency may be lower than connector or coax max frequency



For our complete selection of cable assemblies, please visit our website

SPP-250-LLPL Coax, 50 Ohm						
Part No. <a href="#">PE3C6255</a>	Cable Dia.			Attn. @ 1 GHz	Power @ 1 GHz	
1 piece price shown. See web or call for volume pricing.	0.28" dia.			5.5 dB/100ft	650 W	
12"	24"	36"	48"	60"	50CM	Custom Len.
\$66.18	\$72.31	\$78.45	\$84.58	\$90.71	\$70.09	See Web

62

**N FEMALE 4 HOLE FLANGE TO MMCX PLUG RIGHT ANGLE**

SEE MOUNTING HOLE SECTION ON PAGE 409



**Low Loss Flexible Cable Assemblies**

LMR-100A-PVC Coax, 50 Ohm						
Part No. <a href="#">PE3C0063</a>	Cable Dia.			Attn. @ 1 GHz	Power @ 1 GHz	
1 piece price shown. See web or call for volume pricing.	0.11" dia.			24 dB/100ft	450 W	
12"	24"	36"	48"	60"	-	Custom Len.
\$61.83	\$58.00	\$58.79	\$59.55	\$60.31	-	See Web

63

**N FEMALE 4 HOLE FLANGE TO N MALE RIGHT ANGLE**

SEE MOUNTING HOLE SECTION ON PAGE 409



**Standard Semi-Rigid Cable Assemblies**

RG402/U Coax, 50 Ohm						
Part No. <a href="#">PE3W07619</a>	Cable Dia.			Attn. @ 1 GHz	Power @ 1 GHz	
1 piece price shown. See web or call for volume pricing.	0.11" dia.			11.1 dB/100ft	450 W	
12"	24"	36"	48"	60"	50CM	Custom Len.
\$94.42	\$102.78	\$109.58	\$117.83	\$126.07	\$99.78	See Web

64

**NMO MOUNT SEXLESS TO TNC MALE**



**Standard Flexible Cable Assemblies**

RG58C/U Coax, 50 Ohm						
Part No. <a href="#">PE37848</a>	Cable Dia.			Attn. @ 1 GHz	Power @ 1 GHz	
1 piece price shown. See web or call for volume pricing.	0.195" dia.			20 dB/100ft	44 W	
60"	120"	180"	-	-	-	Custom Len.
\$51.81	\$51.93	\$55.48	-	-	-	See Web

65

**QMA MALE TO QMA MALE**



**Low Loss Flexible Cable Assemblies**

PE-C195 Coax, 50 Ohm						
Part No. <a href="#">PE38272</a>	Cable Dia.			Attn. @ 1 GHz	Power @ 1 GHz	
1 piece price shown. See web or call for volume pricing.	0.195" dia.			11.3 dB/100ft	150 W	
12"	24"	36"	48"	60"	72"	Custom Len.
\$54.54	\$55.33	\$59.53	\$56.90	\$57.69	\$62.19	See Web

66

**Low PIM Corrugated Cable Assemblies**

PE-1/4SFHC Coax, 50 Ohm						
Part No. <a href="#">PE3C7870</a>	Cable Dia.			Attn. @ 1 GHz	Power @ 1 GHz	
1 piece price shown. See web or call for volume pricing.	0.303" dia.			5.85 dB/100ft	50CM	Custom Len.
12"	24"	36"	48"	60"	50CM	Custom Len.
\$54.07	\$57.80	\$61.52	\$65.25	\$68.97	\$56.46	See Web

67

SPP-250-LLPL Coax, 50 Ohm						
Part No. <a href="#">PE3C5869</a>	Cable Dia.			Attn. @ 1 GHz	Power @ 1 GHz	
1 piece price shown. See web or call for volume pricing.	0.28" dia.			5.85 dB/100ft	50CM	Custom Len.
12"	24"	36"	48"	60"	50CM	Custom Len.
\$78.94	\$85.08	\$91.21	\$97.35	\$103.48	\$82.87	See Web

68

**Standard Flexible Cable Assemblies**

RG58C/U Coax, 50 Ohm						
Part No. <a href="#">PE38271</a>	Cable Dia.			Attn. @ 1 GHz	Power @ 1 GHz	
1 piece price shown. See web or call for volume pricing.	0.195" dia.			20 dB/100ft	44 W	
12"	24"	36"	48"	60"	72"	Custom Len.
\$63.20	\$63.99	\$64.82	\$65.63	\$66.44	\$67.26	See Web

69

RG316/U Coax, 50 Ohm						
Part No. <a href="#">PE38270</a>	Cable Dia.			Attn. @ 1 GHz	Power @ 1 GHz	
1 piece price shown. See web or call for volume pricing.	0.098" dia.			38 dB/100ft	160 W	
12"	24"	36"	48"	60"	72"	Custom Len.
\$67.30	\$70.47	\$78.21	\$76.80	\$85.34	\$83.18	See Web

70

RG316-DS Coax, 50 Ohm						
Part No. <a href="#">PE38161</a>	Cable Dia.			Attn. @ 1 GHz	Power @ 1 GHz	
1 piece price shown. See web or call for volume pricing.	0.114" dia.			30 dB/100ft	160 W	
12"	24"	36"	48"	60"	72"	Custom Len.
\$106.07	\$107.77	\$110.91	\$114.10	\$117.29	\$120.47	See Web

71

**QMA MALE TO QMA MALE RIGHT ANGLE**



**Low PIM Corrugated Cable Assemblies**

PE-1/4SFHC Coax, 50 Ohm						
Part No. <a href="#">PE3C7871</a>	Cable Dia.			Attn. @ 1 GHz	Power @ 1 GHz	
1 piece price shown. See web or call for volume pricing.	0.303" dia.			5.85 dB/100ft	50CM	Custom Len.
12"	24"	36"	48"	60"	50CM	Custom Len.
\$58.29	\$62.02	\$65.74	\$69.47	\$73.20	\$60.68	See Web

72

SPP-250-LLPL Coax, 50 Ohm						
Part No. <a href="#">PE3C5875</a>	Cable Dia.			Attn. @ 1 GHz	Power @ 1 GHz	
1 piece price shown. See web or call for volume pricing.	0.28" dia.			5.85 dB/100ft	50CM	Custom Len.
12"	24"	36"	48"	60"	50CM	Custom Len.
\$81.34	\$87.47	\$93.61	\$99.73	\$105.87	\$85.26	See Web

73

**QMA MALE TO QMA FEMALE**



**Low PIM Corrugated Cable Assemblies**

PE-1/4SFHC Coax, 50 Ohm						
Part No. <a href="#">PE3C7872</a>	Cable Dia.			Attn. @ 1 GHz	Power @ 1 GHz	
1 piece price shown. See web or call for volume pricing.	0.303" dia.			5.85 dB/100ft	50CM	Custom Len.
12"	24"	36"	48"	60"	50CM	Custom Len.
\$54.40	\$57.62	\$61.35	\$65.07	\$68.80	\$56.28	See Web

74

SPP-250-LLPL Coax, 50 Ohm						
Part No. <a href="#">PE3C5863</a>	Cable Dia.			Attn. @ 1 GHz	Power @ 1 GHz	
1 piece price shown. See web or call for volume pricing.	0.28" dia.			5.85 dB/100ft	50CM	Custom Len.
12"	24"	36"	48"	60"	50CM	Custom Len.
\$74.99	\$81.12	\$87.26	\$93.39	\$99.53	\$78.92	See Web

75

**QMA MALE TO QMA FEMALE BULKHEAD**

SEE MOUNTING HOLE SECTION ON PAGE 409



**Low PIM Corrugated Cable Assemblies**

PE-1/4SFHC Coax, 50 Ohm						
Part No. <a href="#">PE3C7873</a>	Cable Dia.			Attn. @ 1 GHz	Power @ 1 GHz	
1 piece price shown. See web or call for volume pricing.	0.303" dia.			5.85 dB/100ft	50CM	Custom Len.
12"	24"	36"	48"	60"	50CM	Custom Len.
\$43.86	\$47.62	\$51.38	\$54.63	\$58.36	\$46.26	See Web

76

**QMA MALE TO SMA MALE**



**Low PIM Corrugated Cable Assemblies**

SPP-250-LLPL Coax, 50 Ohm						
Part No. <a href="#">PE3C5870</a>	Cable Dia.			Attn. @ 1 GHz	Power @ 1 GHz	
1 piece price shown. See web or call for volume pricing.	0.28" dia.			5.85 dB/100ft	50CM	Custom Len.
12"	24"	36"	48"	60"	50CM	Custom Len.
\$71.00	\$77.14	\$83.27	\$89.41	\$95.54	\$74.94	See Web

77

**QMA MALE TO SMA MALE RIGHT ANGLE**



**Low PIM Corrugated Cable Assemblies**

SPP-250-LLPL Coax, 50 Ohm						
Part No. <a href="#">PE3C5893</a>	Cable Dia.			Attn. @ 1 GHz	Power @ 1 GHz	
1 piece price shown. See web or call for volume pricing.	0.28" dia.			5.85 dB/100ft	50CM	Custom Len.
12"	24"	36"	48"	60"	50CM	Custom Len.
\$72.60	\$78.74	\$84.87	\$91.01	\$97.15	\$76.53	See Web

78

**QMA MALE TO SMA FEMALE**



**Low PIM Corrugated Cable Assemblies**

SPP-250-LLPL Coax, 50 Ohm						
Part No. <a href="#">PE3C5882</a>	Cable Dia.			Attn. @ 1 GHz	Power @ 1 GHz	
1 piece price shown. See web or call for volume pricing.	0.28" dia.			5.85 dB/100ft	50CM	Custom Len.
12"	24"	36"	48"	60"	50CM	Custom Len.
\$71.80	\$77.94	\$84.07	\$90.21	\$96.34	\$75.73	See Web

79

**QMA MALE RIGHT ANGLE TO QMA MALE RIGHT ANGLE**



**Low PIM Corrugated Cable Assemblies**

PE-1/4SFHC Coax, 50 Ohm						
Part No. <a href="#">PE3C7874</a>	Cable Dia.			Attn. @ 1 GHz	Power @ 1 GHz	
1 piece price shown. See web or call for volume pricing.	0.303" dia.			5.85 dB/100ft	50CM	Custom Len.
12"	24"	36"	48"	60"	50CM	Custom Len.
\$62.52	\$66.24	\$69.97	\$73.69	\$77.42	\$64.90	See Web

80

SPP-250-LLPL Coax, 50 Ohm						
Part No. <a href="#">PE3C5877</a>	Cable Dia.			Attn. @ 1 GHz	Power @ 1 GHz	
1 piece price shown. See web or call for volume pricing.	0.28" dia.			5.85 dB/100ft	50CM	Custom Len.
12"	24"	36"	48"	60"	50CM	Custom Len.
\$83.73	\$89.86	\$96.00	\$102.13	\$106.76	\$87.65	See Web

81

**Standard Flexible Cable Assemblies**

RG316/U Coax, 50 Ohm						
Part No. <a href="#">PE3C7587</a>	Cable Dia.			Attn. @ 1 GHz	Power @ 1 GHz	
1 piece price shown. See web or call for volume pricing.	0.102" dia.			38 dB/100ft	50CM	Custom Len.
12"	24"	36"	48"	60"	50CM	Custom Len.
Call	Call	Call	Call	Call	Call	See Web

82

For Custom Lengths, Metric Lengths or Special Configurations, Please call (949) 261-1920



Technical Support  
+1 (949) 261-1920



Same-Day Shipping,  
Even Custom Cable Assemblies

Cable Assemblies

See Our Website For Current Pricing & Real-Time Stock Availability!



For our complete selection of cable assemblies, please visit our website

**QMA MALE RIGHT ANGLE TO QMA FEMALE**



**Low PIM Corrugated Cable Assemblies**

**PE-1/4SFHC Coax, 50 Ohm**

Part No. <a href="#">PE3C7875</a>	Cable Dia.	Attn. @ 1 GHz	Power @ 1 GHz
1 piece price shown. See web or call for volume pricing.	0.303" dia.	5.85 dB/100ft	
12" 24" 36" 48"	60"	50CM	Custom Len.
\$58.12 \$61.85 \$65.57 \$69.30	\$73.02	\$60.51	See Web

83

**QMA MALE RIGHT ANGLE TO QMA FEMALE BULKHEAD**



SEE MOUNTING HOLE SECTION ON PAGE 409

**Low PIM Corrugated Cable Assemblies**

**PE-1/4SFHC Coax, 50 Ohm**

Part No. <a href="#">PE3C7876</a>	Cable Dia.	Attn. @ 1 GHz	Power @ 1 GHz
1 piece price shown. See web or call for volume pricing.	0.303" dia.	5.85 dB/100ft	
12" 24" 36" 48"	60"	50CM	Custom Len.
\$48.12 \$51.88 \$55.13 \$58.85	\$62.58	\$50.52	See Web

84

**QMA MALE RIGHT ANGLE TO SMA MALE**



**Flexible Cable Assemblies**

**LMR-195 Coax, 50 Ohm**

Part No. <a href="#">PE3W06662</a>	Cable Dia.	Attn. @ 1 GHz	Power @ 1 GHz
1 piece price shown. See web or call for volume pricing.	0.195" dia.	11.8 dB/100ft	
12" 24" 36" 48"	60"	50CM	Custom Len.
\$61.76 \$62.46 \$63.17 \$63.88	\$64.58	\$62.19	See Web

85

**Low PIM Corrugated Cable Assemblies**

**SPP-250-LLPL Coax, 50 Ohm**

Part No. <a href="#">PE3C5876</a>	Cable Dia.	Attn. @ 1 GHz	Power @ 1 GHz
1 piece price shown. See web or call for volume pricing.	0.28" dia.		
12" 24" 36" 48"	60"	50CM	Custom Len.
\$73.40 \$79.53 \$85.66 \$91.76	\$97.93	\$77.32	See Web

86

**QMA FEMALE TO SMA MALE**



**Low PIM Corrugated Cable Assemblies**

**SPP-250-LLPL Coax, 50 Ohm**

Part No. <a href="#">PE3C5864</a>	Cable Dia.	Attn. @ 1 GHz	Power @ 1 GHz
1 piece price shown. See web or call for volume pricing.	0.28" dia.		
12" 24" 36" 48"	60"	50CM	Custom Len.
\$67.05 \$73.19 \$79.32 \$85.45	\$91.59	\$70.98	See Web

87

**QN MALE TO QN MALE**



**Low Loss Flexible Cable Assemblies**

**PE-C195 Coax, 50 Ohm**

Part No. <a href="#">PE38449</a>	Cable Dia.	Attn. @ 1 GHz	Power @ 1 GHz
1 piece price shown. See web or call for volume pricing.	0.195" dia.	11.3 dB/100ft	150 W
12" 24" 36" 48"	60"	72"	Custom Len.
\$86.53 \$87.27 \$87.99 \$88.78	\$89.52	\$90.29	See Web

88

**Standard Flexible Cable Assemblies**

**RG58C/U Coax, 50 Ohm**

Part No. <a href="#">PE38448</a>	Cable Dia.	Attn. @ 1 GHz	Power @ 1 GHz
1 piece price shown. See web or call for volume pricing.	0.195" dia.	20 dB/100ft	44 W
12" 24" 36" 48"	60"	72"	Custom Len.
\$87.60 \$88.45 \$89.25 \$90.02	\$90.82	\$91.61	See Web

89

**RG213/U Coax, 50 Ohm**

Part No. <a href="#">PE38446</a>	Cable Dia.	Attn. @ 1 GHz	Power @ 1 GHz
1 piece price shown. See web or call for volume pricing.	0.405" dia.	8 dB/100ft	190 W
12" 24" 36" 48"	60"	72"	Custom Len.
\$164.65 \$166.48 \$168.22 \$170.06	\$171.87	\$173.71	See Web

90

**RG223/U Coax, 50 Ohm**

Part No. <a href="#">PE38447</a>	Cable Dia.	Attn. @ 1 GHz	Power @ 1 GHz
1 piece price shown. See web or call for volume pricing.	0.21" dia.	13.4 dB/100ft	53 W
12" 24" 36" 48"	60"	72"	Custom Len.
\$88.98 \$92.15 \$95.38 \$98.61	\$101.77	\$105.02	See Web

91

**QN MALE TO QN MALE RIGHT ANGLE**



**Low Loss Flexible Cable Assemblies**

**PE-C195 Coax, 50 Ohm**

Part No. <a href="#">PE38486</a>	Cable Dia.	Attn. @ 1 GHz	Power @ 1 GHz
1 piece price shown. See web or call for volume pricing.	0.195" dia.	11.3 dB/100ft	150 W
12" 24" 36" 48"	60"	72"	Custom Len.
\$88.72 \$89.45 \$90.24 \$90.96	\$91.76	\$92.49	See Web

92

**Standard Flexible Cable Assemblies**

**RG58C/U Coax, 50 Ohm**

Part No. <a href="#">PE38485</a>	Cable Dia.	Attn. @ 1 GHz	Power @ 1 GHz
1 piece price shown. See web or call for volume pricing.	0.195" dia.	20 dB/100ft	44 W
12" 24" 36" 48"	60"	72"	Custom Len.
\$106.59 \$107.40 \$108.20 \$108.98	\$109.79	\$110.58	See Web

93

**RG213/U Coax, 50 Ohm**

Part No. <a href="#">PE38487</a>	Cable Dia.	Attn. @ 1 GHz	Power @ 1 GHz
1 piece price shown. See web or call for volume pricing.	0.405" dia.	8 dB/100ft	190 W
12" 24" 36" 48"	60"	72"	Custom Len.
\$149.95 \$151.78 \$153.51 \$155.34	\$157.17	\$158.98	See Web

94

**RG223/U Coax, 50 Ohm**

Part No. <a href="#">PE38488</a>	Cable Dia.	Attn. @ 1 GHz	Power @ 1 GHz
1 piece price shown. See web or call for volume pricing.	0.21" dia.	13.4 dB/100ft	53 W
12" 24" 36" 48"	60"	72"	Custom Len.
\$93.94 \$97.17 \$100.32 \$103.57	\$106.80	\$108.42	See Web

95

**QN MALE RIGHT ANGLE TO N FEMALE**



**Flexible Cable Assemblies**

**LMR-400 Coax, 50 Ohm**

Part No. <a href="#">PE3W04619</a>	Cable Dia.	Attn. @ 1 GHz	Power @ 1 GHz
1 piece price shown. See web or call for volume pricing.	0.405" dia.	4.25 dB/100ft	
12" 24" 36" 48"	60"	50CM	Custom Len.
\$96.31 \$97.67 \$99.05 \$100.42	\$101.78	\$97.19	See Web

96

**SC MALE TO SC MALE**



**Standard Flexible Cable Assemblies**

**RG8A/U Coax, 50 Ohm**

Part No. <a href="#">PE34443</a>	Cable Dia.	Attn. @ 1 GHz	Power @ 1 GHz
1 piece price shown. See web or call for volume pricing.	0.405" dia.	8 dB/100ft	190 W
12" 24" 36" 48"	60"	72"	Custom Len.
\$166.26 \$179.56 \$172.40 \$186.41	\$178.54	\$181.61	See Web

97

**RG58C/U Coax, 50 Ohm**

Part No. <a href="#">PE3104</a>	Cable Dia.	Attn. @ 1 GHz	Power @ 1 GHz
1 piece price shown. See web or call for volume pricing.	0.195" dia.	20 dB/100ft	44 W
12" 24" 36" 48"	60"	72"	Custom Len.
\$258.68 \$259.50 \$260.30 \$261.09	\$261.87	\$262.64	See Web

98

**RG141A/U Coax, 50 Ohm**

Part No. <a href="#">PE34439</a>	Cable Dia.	Attn. @ 1 GHz	Power @ 1 GHz
1 piece price shown. See web or call for volume pricing.	0.19" dia.	13 dB/100ft	650 W
12" 24" 36" 48"	60"	72"	Custom Len.
\$271.19 \$277.99 \$284.76 \$291.54	\$298.31	\$305.07	See Web

99

**RG142B/U Coax, 50 Ohm**

Part No. <a href="#">PE3334</a>	Cable Dia.	Attn. @ 1 GHz	Power @ 1 GHz
1 piece price shown. See web or call for volume pricing.	0.195" dia.	13 dB/100ft	650 W
12" 24" 36" 48"	60"	72"	Custom Len.
\$257.45 \$263.43 \$269.42 \$275.47	\$281.43	\$287.50	See Web

1

**RG213/U Coax, 50 Ohm**

Part No. <a href="#">PE3395</a>	Cable Dia.	Attn. @ 1 GHz	Power @ 1 GHz
1 piece price shown. See web or call for volume pricing.	0.405" dia.	8 dB/100ft	190 W
12" 24" 36" 48"	60"	72"	Custom Len.
\$155.67 \$157.50 \$159.33 \$161.15	\$162.90	\$164.72	See Web

2

**RG214/U Coax, 50 Ohm**

Part No. <a href="#">PE3409</a>	Cable Dia.	Attn. @ 1 GHz	Power @ 1 GHz
1 piece price shown. See web or call for volume pricing.	0.425" dia.	7.32 dB/100ft	190 W
12" 24" 36" 48"	60"	72"	Custom Len.
\$171.58 \$179.54 \$187.47 \$195.42	\$203.36	\$211.28	See Web

3

**RG223/U Coax, 50 Ohm**

Part No. <a href="#">PE3348</a>	Cable Dia.	Attn. @ 1 GHz	Power @ 1 GHz
1 piece price shown. See web or call for volume pricing.	0.21" dia.	13.4 dB/100ft	53 W
12" 24" 36" 48"	60"	72"	Custom Len.
\$254.57 \$257.70 \$260.90 \$264.08	\$267.20	\$270.39	See Web

4

**RG225/U Coax, 50 Ohm**

Part No. <a href="#">PE34447</a>	Cable Dia.	Attn. @ 1 GHz	Power @ 1 GHz
1 piece price shown. See web or call for volume pricing.	0.43" dia.		1,700 W
12" 24" 36" 48"	60"	72"	Custom Len.
\$212.56 \$236.96 \$273.38 \$309.82	\$346.24	\$382.67	See Web

5

**RG393/U Coax, 50 Ohm**

Part No. <a href="#">PE3416</a>	Cable Dia.	Attn. @ 1 GHz	Power @ 1 GHz
1 piece price shown. See web or call for volume pricing.	0.39" dia.	8.8 dB/100ft	1,700 W
12" 24" 36" 48"	60"	72"	Custom Len.
\$181.02 \$209.67 \$227.45 \$231.33	\$248.10	\$264.86	See Web

6

Cable Assemblies

See Our Website For Current Pricing & Real-Time Stock Availability!

\*Coax Performance at 1 GHz Notes: Cable assembly max frequency may be lower than connector or coax max frequency

For our complete selection of cable assemblies, please visit our website

RG400/U Coax, 50 Ohm						
Part No. <a href="#">PE34453</a>		Cable Dia.	Attn. @ 1 GHz	Power @ 1 GHz		
1 piece price shown. See web or call for volume pricing.						
12"	24"	36"	48"	60"	72"	Custom Len.
\$265.49	\$273.13	\$280.74	\$288.34	\$295.96	\$303.57	See Web
RG59B/U Coax, 75 Ohm						
Part No. <a href="#">PE34441</a>		Cable Dia.	Attn. @ 1 GHz	Power @ 1 GHz		
1 piece price shown. See web or call for volume pricing.						
12"	24"	36"	48"	60"	72"	Custom Len.
\$258.87	\$259.84	\$260.84	\$261.80	\$262.78	\$263.75	See Web
RG62A/U Coax, 93 Ohm						
Part No. <a href="#">PE34449</a>		Cable Dia.	Attn. @ 1 GHz	Power @ 1 GHz		
1 piece price shown. See web or call for volume pricing.						
12"	24"	36"	48"	60"	72"	Custom Len.
\$259.33	\$260.75	\$262.21	\$263.61	\$265.06	\$266.49	See Web
SHV PLUG TO SHV PLUG						
Standard Flexible Cable Assemblies						
RG8A/U Coax, 50 Ohm						
Part No. <a href="#">PE33068</a>		Cable Dia.	Attn. @ 1 GHz	Power @ 1 GHz		
1 piece price shown. See web or call for volume pricing.						
12"	24"	36"	48"	60"	72"	Custom Len.
\$113.80	\$110.43	\$113.50	\$116.58	\$119.65	\$130.79	See Web
RG58C/U Coax, 50 Ohm						
Part No. <a href="#">PE3815</a>		Cable Dia.	Attn. @ 1 GHz	Power @ 1 GHz		
1 piece price shown. See web or call for volume pricing.						
12"	24"	36"	48"	60"	72"	Custom Len.
\$111.95	\$112.83	\$113.72	\$114.65	\$115.54	\$116.44	See Web
RG141A/U Coax, 50 Ohm						
Part No. <a href="#">PE34428</a>		Cable Dia.	Attn. @ 1 GHz	Power @ 1 GHz		
1 piece price shown. See web or call for volume pricing.						
12"	24"	36"	48"	60"	72"	Custom Len.
\$132.78	\$132.26	\$147.74	\$146.25	\$163.29	\$170.92	See Web
RG142B/U Coax, 50 Ohm						
Part No. <a href="#">PE3843</a>		Cable Dia.	Attn. @ 1 GHz	Power @ 1 GHz		
1 piece price shown. See web or call for volume pricing.						
12"	24"	36"	48"	60"	72"	Custom Len.
\$105.94	\$106.24	\$117.64	\$117.21	\$131.35	\$138.06	See Web
Part No. <a href="#">PE3W03503</a>		Cable Dia.	Attn. @ 1 GHz	Power @ 1 GHz		
1 piece price shown. See web or call for volume pricing.						
12"	24"	36"	48"	60"	50CM	Custom Len.
\$77.25	\$83.73	\$90.21	\$96.70	\$103.18	\$81.39	See Web
RG174A/U Coax, 50 Ohm						
Part No. <a href="#">PE33706</a>		Cable Dia.	Attn. @ 1 GHz	Power @ 1 GHz		
1 piece price shown. See web or call for volume pricing.						
12"	24"	36"	48"	60"	72"	Custom Len.
\$125.72	\$119.07	\$126.97	\$127.63	\$128.26	\$120.96	See Web
RG188A/U Coax, 50 Ohm						
Part No. <a href="#">PE34430</a>		Cable Dia.	Attn. @ 1 GHz	Power @ 1 GHz		
1 piece price shown. See web or call for volume pricing.						
12"	24"	36"	48"	60"	72"	Custom Len.
\$127.79	\$130.50	\$125.38	\$127.78	\$130.19	\$141.58	See Web
RG213/U Coax, 50 Ohm						
Part No. <a href="#">PE35384</a>		Cable Dia.	Attn. @ 1 GHz	Power @ 1 GHz		
1 piece price shown. See web or call for volume pricing.						
12"	24"	36"	48"	60"	-	Custom Len.
\$107.47	\$109.41	\$111.34	\$113.41	\$115.37	-	See Web
RG214/U Coax, 50 Ohm						
Part No. <a href="#">PE3117</a>		Cable Dia.	Attn. @ 1 GHz	Power @ 1 GHz		
1 piece price shown. See web or call for volume pricing.						
12"	24"	36"	48"	60"	72"	Custom Len.
\$121.48	\$129.91	\$138.35	\$138.42	\$155.88	\$164.47	See Web
RG223/U Coax, 50 Ohm						
Part No. <a href="#">PE3992</a>		Cable Dia.	Attn. @ 1 GHz	Power @ 1 GHz		
1 piece price shown. See web or call for volume pricing.						
12"	24"	36"	48"	60"	72"	Custom Len.
\$100.75	\$104.18	\$107.61	\$109.69	\$108.11	\$116.57	See Web
RG225/U Coax, 50 Ohm						
Part No. <a href="#">PE34421</a>		Cable Dia.	Attn. @ 1 GHz	Power @ 1 GHz		
1 piece price shown. See web or call for volume pricing.						
12"	24"	36"	48"	60"	72"	Custom Len.
\$143.57	\$182.19	\$220.81	\$241.44	\$301.06	\$312.11	See Web
RG303/U Coax, 50 Ohm						
Part No. <a href="#">PE3W00305</a>		Cable Dia.	Attn. @ 1 GHz	Power @ 1 GHz		
1 piece price shown. See web or call for volume pricing.						
12"	24"	36"	48"	60"	50CM	Custom Len.
\$101.36	\$106.73	\$113.50	\$120.26	\$127.04	\$105.77	See Web
RG316/U Coax, 50 Ohm						
Part No. <a href="#">PE34432</a>		Cable Dia.	Attn. @ 1 GHz	Power @ 1 GHz		
1 piece price shown. See web or call for volume pricing.						
12"	24"	36"	48"	60"	72"	Custom Len.
\$119.30	\$122.42	\$125.56	\$128.68	\$131.81	\$143.72	See Web



RG393/U Coax, 50 Ohm						
Part No. <a href="#">PE3338</a>		Cable Dia.	Attn. @ 1 GHz	Power @ 1 GHz		
1 piece price shown. See web or call for volume pricing.						
12"	24"	36"	48"	60"	72"	Custom Len.
\$119.24	\$144.18	\$161.97	\$180.80	\$186.33	\$203.10	See Web
RG400/U Coax, 50 Ohm						
Part No. <a href="#">PE34424</a>		Cable Dia.	Attn. @ 1 GHz	Power @ 1 GHz		
1 piece price shown. See web or call for volume pricing.						
12"	24"	36"	48"	60"	72"	Custom Len.
\$107.36	\$114.91	\$122.46	\$138.31	\$137.57	\$145.12	See Web
PE-P195 Coax, 50 Ohm						
Part No. <a href="#">PE39229</a>		Cable Dia.	Attn. @ 1 GHz	Power @ 1 GHz		
1 piece price shown. See web or call for volume pricing.						
12"	24"	36"	48"	60"	-	Custom Len.
\$79.13	\$84.39	\$94.13	\$103.86	\$112.00	-	See Web
RG59B/U Coax, 75 Ohm						
Part No. <a href="#">PE3895</a>		Cable Dia.	Attn. @ 1 GHz	Power @ 1 GHz		
1 piece price shown. See web or call for volume pricing.						
12"	24"	36"	48"	60"	72"	Custom Len.
\$100.69	\$101.84	\$102.98	\$104.18	\$105.35	\$106.51	See Web
RG62A/U Coax, 93 Ohm						
Part No. <a href="#">PE3857</a>		Cable Dia.	Attn. @ 1 GHz	Power @ 1 GHz		
1 piece price shown. See web or call for volume pricing.						
12"	24"	36"	48"	60"	72"	Custom Len.
\$105.21	\$106.91	\$107.09	\$108.86	\$107.21	\$112.27	See Web
SHV PLUG TO SHV JACK BULKHEAD						
SEE MOUNTING HOLE SECTION ON PAGE 409						
Standard Flexible Cable Assemblies						
RG142B/U Coax, 50 Ohm						
Part No. <a href="#">PE3W03078</a>		Cable Dia.	Attn. @ 1 GHz	Power @ 1 GHz		
1 piece price shown. See web or call for volume pricing.						
12"	24"	36"	48"	60"	50CM	Custom Len.
\$100.65	\$101.42	\$107.90	\$112.81	\$119.20	\$99.08	See Web
SHV JACK BULKHEAD TO SHV PLUG						
SEE MOUNTING HOLE SECTION ON PAGE 409						
Standard Flexible Cable Assemblies						
RG59B/U Coax, 75 Ohm						
Part No. <a href="#">PE33018</a>		Cable Dia.	Attn. @ 1 GHz	Power @ 1 GHz		
1 piece price shown. See web or call for volume pricing.						
12"	24"	36"	48"	60"	-	Custom Len.
\$115.04	\$116.16	\$117.29	\$118.48	\$119.63	-	See Web
SMA MALE TO 1.85MM MALE						
Standard Formable Cable Assemblies						
PE-SR405FL Coax, 50 Ohm						
Part No. <a href="#">PE36541</a>		Cable Dia.	Attn. @ 1 GHz	Power @ 1 GHz		
1 piece price shown. See web or call for volume pricing.						
6"	12"	18"	24"	36"	48"	Custom Len.
\$210.81	\$210.81	\$229.62	\$222.41	\$234.01	\$245.58	See Web
Standard Flexible Cable Assemblies						
PE-P103 Coax, 50 Ohm						
Part No. <a href="#">PE3C6633</a>		Cable Dia.	Attn. @ 1 GHz	Power @ 1 GHz		
1 piece price shown. See web or call for volume pricing.						
12"	24"	36"	48"	60"	50CM	Custom Len.
\$250.88	\$278.16	\$305.47	\$332.75	\$360.05	\$268.34	See Web
Standard Semi-Rigid Cable Assemblies						
RG405/U Coax, 50 Ohm						
Part No. <a href="#">PE36539</a>		Cable Dia.	Attn. @ 1 GHz	Power @ 1 GHz		
1 piece price shown. See web or call for volume pricing.						
6"	12"	18"	24"	36"	48"	Custom Len.
\$215.01	\$206.53	\$210.28	\$214.00	\$221.44	\$228.87	See Web
SMA MALE TO 2.4MM MALE						
Standard Flexible Cable Assemblies						
PE-P103 Coax, 50 Ohm						
Part No. <a href="#">PE3C6634</a>		Cable Dia.	Attn. @ 1 GHz	Power @ 1 GHz		
1 piece price shown. See web or call for volume pricing.						
12"	24"	36"	48"	60"	50CM	Custom Len.
\$229.12	\$256.41	\$283.71	\$311.01	\$338.29	\$246.60	See Web

Cable Assemblies

See Our Website For Current Pricing & Real-Time Stock Availability!

For Custom Lengths, Metric Lengths or Special Configurations, Please call (949) 261-1920



Technical Support  
+1 (949) 261-1920



Same-Day Shipping,  
Even Custom Cable Assemblies

For our complete selection of cable assemblies, please visit our website

**SMA MALE TO 2.92MM MALE**



**Standard Flexible Cable Assemblies**

**PE-P103 Coax, 50 Ohm**

Part No. <a href="#">PE3C6632</a>	Cable Dia.	Attn. @ 1 GHz	Power @ 1 GHz
1 piece price shown. See web or call for volume pricing.			
12"	24"	36"	48"
\$222.82	\$250.13	\$277.42	\$304.71
60"	50CM	\$332.01	\$240.30
			See Web

34

**SMA MALE TO 7/16 DIN MALE**



**Low PIM Formable Cable Assemblies**

**PE-SR402FLJ Low PIM Coax, 50 Ohm**

Part No. <a href="#">PE3C2007</a>	Cable Dia.	Attn. @ 1 GHz	Power @ 1 GHz
1 piece price shown. See web or call for volume pricing.			
100CM	200CM	-	-
\$117.74	\$127.27	-	-
			See Web

35

**Standard Formable Cable Assemblies**

**PE-SR401FL Coax, 50 Ohm**

Part No. <a href="#">PE36169</a>	Cable Dia.	Attn. @ 1 GHz	Power @ 1 GHz
1 piece price shown. See web or call for volume pricing.			
12"	24"	36"	48"
\$241.06	\$257.26	\$273.45	\$289.65
60"	72"	\$305.86	\$322.05
			See Web

36

**PE-SR402FL Coax, 50 Ohm**

Part No. <a href="#">PE36173</a>	Cable Dia.	Attn. @ 1 GHz	Power @ 1 GHz
1 piece price shown. See web or call for volume pricing.			
12"	24"	36"	48"
\$190.55	\$198.49	\$206.35	\$214.30
60"	72"	\$222.16	\$230.12
			See Web

37

**Standard Flexible Cable Assemblies**

**RG8A/U Coax, 50 Ohm**

Part No. <a href="#">PE36157</a>	Cable Dia.	Attn. @ 1 GHz	Power @ 1 GHz
1 piece price shown. See web or call for volume pricing.			
12"	24"	36"	48"
\$231.02	\$234.02	\$236.95	\$239.95
60"	72"	\$242.93	\$245.87
			See Web

38

**RG58C/U Coax, 50 Ohm**

Part No. <a href="#">PE3221</a>	Cable Dia.	Attn. @ 1 GHz	Power @ 1 GHz
1 piece price shown. See web or call for volume pricing.			
12"	24"	36"	48"
\$143.77	\$144.55	\$145.39	\$146.19
60"	72"	\$146.95	\$147.74
			See Web

39

**RG142B/U Coax, 50 Ohm**

Part No. <a href="#">PE3224</a>	Cable Dia.	Attn. @ 1 GHz	Power @ 1 GHz
1 piece price shown. See web or call for volume pricing.			
12"	24"	36"	48"
\$77.69	\$83.78	\$89.85	\$95.98
60"	72"	\$102.05	\$106.68
			See Web

40

**RG213/U Coax, 50 Ohm**

Part No. <a href="#">PE36159</a>	Cable Dia.	Attn. @ 1 GHz	Power @ 1 GHz
1 piece price shown. See web or call for volume pricing.			
12"	24"	36"	48"
\$229.85	\$231.66	\$233.48	\$235.32
60"	72"	\$237.14	\$238.88
			See Web

41

**RG214/U Coax, 50 Ohm**

Part No. <a href="#">PE3233</a>	Cable Dia.	Attn. @ 1 GHz	Power @ 1 GHz
1 piece price shown. See web or call for volume pricing.			
12"	24"	36"	48"
\$232.72	\$240.72	\$248.71	\$256.72
60"	72"	\$264.73	\$272.73
			See Web

42

**RG223/U Coax, 50 Ohm**

Part No. <a href="#">PE36161</a>	Cable Dia.	Attn. @ 1 GHz	Power @ 1 GHz
1 piece price shown. See web or call for volume pricing.			
12"	24"	36"	48"
\$74.78	\$82.69	\$81.19	\$84.43
60"	72"	\$87.60	\$90.82
			See Web

43

**RG393/U Coax, 50 Ohm**

Part No. <a href="#">PE36163</a>	Cable Dia.	Attn. @ 1 GHz	Power @ 1 GHz
1 piece price shown. See web or call for volume pricing.			
12"	24"	36"	48"
\$241.63	\$258.56	\$275.39	\$292.32
60"	72"	\$309.24	\$326.16
			See Web

44

**RG400/U Coax, 50 Ohm**

Part No. <a href="#">PE36165</a>	Cable Dia.	Attn. @ 1 GHz	Power @ 1 GHz
1 piece price shown. See web or call for volume pricing.			
12"	24"	36"	48"
\$182.92	\$190.55	\$198.16	\$205.78
60"	72"	\$213.40	\$220.99
			See Web

45

**Standard Semi-Rigid Cable Assemblies**

**RG401/U Coax, 50 Ohm**

Part No. <a href="#">PE36167</a>	Cable Dia.	Attn. @ 1 GHz	Power @ 1 GHz
1 piece price shown. See web or call for volume pricing.			
12"	24"	36"	48"
\$247.94	\$271.03	\$294.14	\$317.25
60"	72"	\$340.27	Call
			See Web

46

**RG402/U Coax, 50 Ohm**

Part No. <a href="#">PE36171</a>	Cable Dia.	Attn. @ 1 GHz	Power @ 1 GHz
1 piece price shown. See web or call for volume pricing.			
12"	24"	36"	48"
\$190.29	\$197.98	\$205.64	\$213.34
60"	72"	\$220.99	\$228.68
			See Web

47

**SMA MALE TO BNC MALE**



**Flexible Cable Assemblies**

**LMR-240 Coax, 50 Ohm**

Part No. <a href="#">PE3C1830</a>	Cable Dia.	Attn. @ 1 GHz	Power @ 1 GHz
1 piece price shown. See web or call for volume pricing.			
12"	24"	36"	48"
\$44.39	\$43.72	\$44.77	\$45.83
60"	50CM	\$46.89	\$43.35
			See Web

48

**Low Loss Flexible Cable Assemblies**

**LMR-195 Coax, 50 Ohm**

Part No. <a href="#">PE3C0051</a>	Cable Dia.	Attn. @ 1 GHz	Power @ 1 GHz
1 piece price shown. See web or call for volume pricing.			
12"	24"	36"	48"
\$36.76	\$37.58	\$38.42	\$39.30
60"	-	\$40.15	-
			See Web

49

**Standard Formable Cable Assemblies**

**PE-SR402FL Coax, 50 Ohm**

Part No. <a href="#">PE34008</a>	Cable Dia.	Attn. @ 1 GHz	Power @ 1 GHz
1 piece price shown. See web or call for volume pricing.			
12"	24"	36"	48"
\$76.24	\$85.14	\$87.17	\$95.47
60"	-	\$110.91	-
			See Web

50

**PE-SR405FL Coax, 50 Ohm**

Part No. <a href="#">PE35109</a>	Cable Dia.	Attn. @ 1 GHz	Power @ 1 GHz
1 piece price shown. See web or call for volume pricing.			
12"	24"	36"	48"
\$77.04	\$89.79	\$102.53	\$113.68
60"	-	\$126.25	-
			See Web

51

**Standard Flexible Cable Assemblies**

**RG58C/U Coax, 50 Ohm**

Part No. <a href="#">PE3615</a>	Cable Dia.	Attn. @ 1 GHz	Power @ 1 GHz
1 piece price shown. See web or call for volume pricing.			
12"	24"	36"	48"
\$44.30	\$45.21	\$46.10	\$47.06
60"	72"	\$47.98	\$48.90
			See Web

52

**RG142B/U Coax, 50 Ohm**

Part No. <a href="#">PE3696</a>	Cable Dia.	Attn. @ 1 GHz	Power @ 1 GHz
1 piece price shown. See web or call for volume pricing.			
12"	24"	36"	48"
\$43.55	\$53.79	\$59.98	\$67.04
60"	72"	\$73.86	\$80.67
			See Web

53

**RG174A/U Coax, 50 Ohm**

Part No. <a href="#">PE3C3328</a>	Cable Dia.	Attn. @ 1 GHz	Power @ 1 GHz
1 piece price shown. See web or call for volume pricing.			
12"	24"	36"	48"
\$44.88	\$45.52	\$46.17	\$46.83
60"	72"	\$47.51	\$48.16
			See Web

54

**RG178B/U Coax, 50 Ohm**

Part No. <a href="#">PE33258</a>	Cable Dia.	Attn. @ 1 GHz	Power @ 1 GHz
1 piece price shown. See web or call for volume pricing.			
12"	24"	36"	48"
\$72.85	\$74.02	\$75.18	\$76.41
60"	72"	\$72.95	\$78.78
			See Web

55

**RG188A/U Coax, 50 Ohm**

Part No. <a href="#">PE3C2035</a>	Cable Dia.	Attn. @ 1 GHz	Power @ 1 GHz
1 piece price shown. See web or call for volume pricing.			
12"	24"	36"	48"
\$45.96	\$48.74	\$51.50	\$54.43
60"	72"	\$53.21	\$59.51
			See Web

56

**RG196A/U Coax, 50 Ohm**

Part No. <a href="#">PE33523</a>	Cable Dia.	Attn. @ 1 GHz	Power @ 1 GHz
1 piece price shown. See web or call for volume pricing.			
12"	24"	36"	48"
\$76.08	\$77.64	\$73.47	\$74.97
60"	72"	\$76.47	\$77.98
			See Web

57

**RG213/U Coax, 50 Ohm**

Part No. <a href="#">PE36661</a>	Cable Dia.	Attn. @ 1 GHz	Power @ 1 GHz
1 piece price shown. See web or call for volume pricing.			
12"	24"	36"	48"
\$126.07	\$127.69	\$129.32	\$130.88
60"	-	\$132.51	-
			See Web

58

**RG214/U Coax, 50 Ohm**

Part No. <a href="#">PE33519</a>	Cable Dia.	Attn. @ 1 GHz	Power @ 1 GHz
1 piece price shown. See web or call for volume pricing.			
12"	24"	36"	48"
\$137.01	\$144.99	\$153.02	\$161.00
60"	72"	\$169.01	\$177.02
			See Web

59

**RG223/U Coax, 50 Ohm**

Part No. <a href="#">PE3562</a>	Cable Dia.	Attn. @ 1 GHz	Power @ 1 GHz
1 piece price shown. See web or call for volume pricing.			
12"	24"	36"	48"
\$42.21	\$45.43	\$48.65	\$51.87
60"	72"	\$54.57	\$57.75
			See Web

60

**RG316/U Coax, 50 Ohm**

Part No. <a href="#">PE3C2360</a>	Cable Dia.	Attn. @ 1 GHz	Power @ 1 GHz
1 piece price shown. See web or call for volume pricing.			
12"	24"	36"	48"
\$41.69	\$45.15	\$48.61	\$52.28
60"	72"	\$55.31	\$58.82
			See Web

61

**RG393/U Coax, 50 Ohm**

Part No. <a href="#">PE33521</a>	Cable Dia.	Attn. @ 1 GHz	Power @ 1 GHz
1 piece price shown. See web or call for volume pricing.			
12"	24"	36"	48"
\$145.92	\$162.78	\$179.68	\$196.60
60"	72"	\$213.52</	



For our complete selection of cable assemblies, please visit our website

RG400/U Coax, 50 Ohm							
Part No. <b>PE3613</b>	Cable Dia.				Attn. @ 1 GHz	Power @ 1 GHz	
1 piece price shown. See web or call for volume pricing.							
12"	24"	36"	48"	60"	72"	Custom Len.	
\$55.17	\$63.30	\$71.44	\$80.04	\$88.34	\$90.36	See Web	
PE-P195 Coax, 50 Ohm							
Part No. <b>PE33989</b>	Cable Dia.				Attn. @ 1 GHz	Power @ 1 GHz	
1 piece price shown. See web or call for volume pricing.							
12"	24"	36"	48"	60"	-	Custom Len.	
\$53.89	\$63.93	\$74.45	\$85.61	\$96.34	-	See Web	
RG55B/U Coax, 53 Ohm							
Part No. <b>PE3479</b>	Cable Dia.				Attn. @ 1 GHz	Power @ 1 GHz	
1 piece price shown. See web or call for volume pricing.							
12"	24"	36"	48"	60"	72"	Custom Len.	
\$40.27	\$45.56	\$48.43	\$51.47	\$54.41	\$56.80	See Web	
RG59B/U Coax, 75 Ohm							
Part No. <b>PE3539</b>	Cable Dia.				Attn. @ 1 GHz	Power @ 1 GHz	
1 piece price shown. See web or call for volume pricing.							
12"	24"	36"	48"	60"	72"	Custom Len.	
\$57.35	\$55.16	\$56.23	\$57.28	\$58.32	\$63.17	See Web	
RG179B/U Coax, 75 Ohm							
Part No. <b>PE3C3321</b>	Cable Dia.				Attn. @ 1 GHz	Power @ 1 GHz	
1 piece price shown. See web or call for volume pricing.							
12"	24"	36"	48"	60"	72"	Custom Len.	
\$47.04	\$46.17	\$48.80	\$51.42	\$54.04	\$56.15	See Web	
SMA MALE TO BNC MALE RIGHT ANGLE							
Low Loss Flexible Cable Assemblies							
LMR-195 Coax, 50 Ohm							
Part No. <b>PE3C0040</b>	Cable Dia.				Attn. @ 1 GHz	Power @ 1 GHz	
1 piece price shown. See web or call for volume pricing.							
12"	24"	36"	48"	60"	-	Custom Len.	
\$51.98	\$52.80	\$53.63	\$54.02	\$54.85	-	See Web	
SMA MALE TO FAKRA PLUG							
Low Loss Flexible Cable Assemblies							
PE-C100-LSZH Coax, 50 Ohm							
Part No. <b>PE39342A</b>	Cable Dia.				Attn. @ 1 GHz	Power @ 1 GHz	
1 piece price shown. See web or call for volume pricing.							
12"	24"	36"	48"	60"	-	Custom Len.	
\$34.53	\$39.44	\$36.12	\$36.86	\$37.65	-	See Web	
Part No. <b>PE39342B</b>	Cable Dia.				Attn. @ 1 GHz	Power @ 1 GHz	
1 piece price shown. See web or call for volume pricing.							
12"	24"	36"	48"	60"	-	Custom Len.	
\$34.53	\$35.33	\$36.12	\$36.86	\$37.65	-	See Web	
Part No. <b>PE39342C</b>	Cable Dia.				Attn. @ 1 GHz	Power @ 1 GHz	
1 piece price shown. See web or call for volume pricing.							
12"	24"	36"	48"	60"	-	Custom Len.	
\$37.98	\$39.32	\$40.66	\$42.00	\$43.34	-	See Web	
Part No. <b>PE39342D</b>	Cable Dia.				Attn. @ 1 GHz	Power @ 1 GHz	
1 piece price shown. See web or call for volume pricing.							
12"	24"	36"	48"	60"	-	Custom Len.	
\$35.71	\$37.93	\$40.19	\$42.40	\$44.66	-	See Web	
Part No. <b>PE39342H</b>	Cable Dia.				Attn. @ 1 GHz	Power @ 1 GHz	
1 piece price shown. See web or call for volume pricing.							
12"	24"	36"	48"	60"	-	Custom Len.	
\$34.53	\$35.33	\$36.12	\$36.86	\$37.65	-	See Web	
Part No. <b>PE39342I</b>	Cable Dia.				Attn. @ 1 GHz	Power @ 1 GHz	
1 piece price shown. See web or call for volume pricing.							
12"	24"	36"	48"	60"	-	Custom Len.	
\$35.71	\$37.93	\$40.19	\$42.40	\$44.66	-	See Web	
Part No. <b>PE39342K</b>	Cable Dia.				Attn. @ 1 GHz	Power @ 1 GHz	
1 piece price shown. See web or call for volume pricing.							
12"	24"	36"	48"	60"	-	Custom Len.	
\$34.53	\$35.33	\$36.12	\$36.86	\$37.65	-	See Web	
Part No. <b>PE39342Z</b>	Cable Dia.				Attn. @ 1 GHz	Power @ 1 GHz	
1 piece price shown. See web or call for volume pricing.							
12"	24"	36"	48"	60"	-	Custom Len.	
\$41.03	\$39.32	\$40.66	\$42.00	\$47.03	-	See Web	
Standard Flexible Cable Assemblies							
RG174A/U Coax, 50 Ohm							
Part No. <b>PE39197A</b>	Cable Dia.				Attn. @ 1 GHz	Power @ 1 GHz	
1 piece price shown. See web or call for volume pricing.							
12"	24"	36"	48"	60"	-	Custom Len.	
\$48.62	\$44.69	\$45.17	\$45.65	\$46.14	-	See Web	
Part No. <b>PE39197C</b>	Cable Dia.				Attn. @ 1 GHz	Power @ 1 GHz	
1 piece price shown. See web or call for volume pricing.							
12"	24"	36"	48"	60"	-	Custom Len.	
\$47.75	\$44.69	\$45.17	\$45.65	\$46.14	-	See Web	

RG316/U Coax, 50 Ohm							
Part No. <b>PE39197D</b>	Cable Dia.				Attn. @ 1 GHz	Power @ 1 GHz	
1 piece price shown. See web or call for volume pricing.							
12"	24"	36"	48"	60"	-	Custom Len.	
\$47.75	\$44.69	\$45.17	\$45.65	\$46.14	-	See Web	
Part No. <b>PE39197H</b>	Cable Dia.				Attn. @ 1 GHz	Power @ 1 GHz	
1 piece price shown. See web or call for volume pricing.							
12"	24"	36"	48"	60"	-	Custom Len.	
\$40.19	\$40.80	\$41.39	\$41.92	\$42.51	-	See Web	
Part No. <b>PE39197I</b>	Cable Dia.				Attn. @ 1 GHz	Power @ 1 GHz	
1 piece price shown. See web or call for volume pricing.							
12"	24"	36"	48"	60"	-	Custom Len.	
\$40.19	\$40.80	\$41.39	\$41.92	\$42.51	-	See Web	
Part No. <b>PE39197K</b>	Cable Dia.				Attn. @ 1 GHz	Power @ 1 GHz	
1 piece price shown. See web or call for volume pricing.							
12"	24"	36"	48"	60"	-	Custom Len.	
\$44.22	\$44.69	\$45.17	\$45.65	\$46.14	-	See Web	
Part No. <b>PE39197Z</b>	Cable Dia.				Attn. @ 1 GHz	Power @ 1 GHz	
1 piece price shown. See web or call for volume pricing.							
12"	24"	36"	48"	60"	-	Custom Len.	
\$48.62	\$49.27	\$45.17	\$45.65	\$46.14	-	See Web	
RG316/U Coax, 50 Ohm							
Part No. <b>PE39343A</b>	Cable Dia.				Attn. @ 1 GHz	Power @ 1 GHz	
1 piece price shown. See web or call for volume pricing.							
12"	24"	36"	48"	60"	-	Custom Len.	
\$47.14	\$50.34	\$53.56	\$56.24	\$59.42	-	See Web	
Part No. <b>PE39343C</b>	Cable Dia.				Attn. @ 1 GHz	Power @ 1 GHz	
1 piece price shown. See web or call for volume pricing.							
12"	24"	36"	48"	60"	-	Custom Len.	
\$51.86	\$50.34	\$53.56	\$56.24	\$59.42	-	See Web	
Part No. <b>PE39343D</b>	Cable Dia.				Attn. @ 1 GHz	Power @ 1 GHz	
1 piece price shown. See web or call for volume pricing.							
12"	24"	36"	48"	60"	-	Custom Len.	
\$51.32	\$49.85	\$53.06	\$55.74	\$58.91	-	See Web	
Part No. <b>PE39343H</b>	Cable Dia.				Attn. @ 1 GHz	Power @ 1 GHz	
1 piece price shown. See web or call for volume pricing.							
12"	24"	36"	48"	60"	-	Custom Len.	
\$42.85	\$45.97	\$49.17	\$52.38	\$55.06	-	See Web	
Part No. <b>PE39343I</b>	Cable Dia.				Attn. @ 1 GHz	Power @ 1 GHz	
1 piece price shown. See web or call for volume pricing.							
12"	24"	36"	48"	60"	-	Custom Len.	
\$42.85	\$45.97	\$49.17	\$52.38	\$55.06	-	See Web	
Part No. <b>PE39343K</b>	Cable Dia.				Attn. @ 1 GHz	Power @ 1 GHz	
1 piece price shown. See web or call for volume pricing.							
12"	24"	36"	48"	60"	-	Custom Len.	
\$42.85	\$45.97	\$49.17	\$52.38	\$55.06	-	See Web	
Part No. <b>PE39343Z</b>	Cable Dia.				Attn. @ 1 GHz	Power @ 1 GHz	
1 piece price shown. See web or call for volume pricing.							
12"	24"	36"	48"	60"	-	Custom Len.	
\$51.86	\$50.34	\$53.56	\$56.24	\$59.42	-	See Web	
SMA MALE TO FAKRA JACK							
Low Loss Flexible Cable Assemblies							
PE-C100-LSZH Coax, 50 Ohm							
Part No. <b>PE39347A</b>	Cable Dia.				Attn. @ 1 GHz	Power @ 1 GHz	
1 piece price shown. See web or call for volume pricing.							
12"	24"	36"	48"	60"	-	Custom Len.	
\$39.30	\$40.63	\$46.17	\$43.30	\$44.66	-	See Web	
Part No. <b>PE39347B</b>	Cable Dia.				Attn. @ 1 GHz	Power @ 1 GHz	
1 piece price shown. See web or call for volume pricing.							
12"	24"	36"	48"	60"	-	Custom Len.	
\$37.98	\$39.32	\$40.66	\$42.00	\$43.34	-	See Web	
Part No. <b>PE39347C</b>	Cable Dia.				Attn. @ 1 GHz	Power @ 1 GHz	
1 piece price shown. See web or call for volume pricing.							
12"	24"	36"	48"	60"	-	Custom Len.	
\$39.30	\$40.63	\$46.17	\$43.30	\$44.66	-	See Web	
Part No. <b>PE39347D</b>	Cable Dia.				Attn. @ 1 GHz	Power @ 1 GHz	
1 piece price shown. See web or call for volume pricing.							
12"	24"	36"	48"	60"	-	Custom Len.	
\$35.71	\$37.93	\$40.19	\$42.40	\$44.66	-	See Web	
Part No. <b>PE39347H</b>	Cable Dia.				Attn. @ 1 GHz	Power @ 1 GHz	
1 piece price shown. See web or call for volume pricing.							
12"	24"	36"	48"	60"	-	Custom Len.	
\$34.53	\$35.33	\$36.12	\$36.86	\$37.65	-	See Web	
Part No. <b>PE39347I</b>	Cable Dia.				Attn. @ 1 GHz	Power @ 1 GHz	
1 piece price shown. See web or call for volume pricing.							
12"	24"	36"	48"	60"	-	Custom Len.	
\$34.53	\$35.33	\$36.12	\$36.86	\$37.65	-	See Web	
Part No. <b>PE39347K</b>	Cable Dia.				Attn. @ 1 GHz	Power @ 1 GHz	
1 piece price shown. See web or call for volume pricing.							
12"	24"	36"	48"	60"	-	Custom Len.	
\$35.71	\$37.93	\$40.19	\$42.40	\$44.66	-	See Web	

Cable Assemblies

See Our Website For Current Pricing & Real-Time Stock Availability!

For Custom Lengths, Metric Lengths or Special Configurations, Please call (949) 261-1920



Technical Support  
+1 (949) 261-1920



Same-Day Shipping,  
Even Custom Cable Assemblies



For our complete selection of cable assemblies, please visit our website

Cable Assemblies  
See Our Website For Current Pricing & Real-Time Stock Availability!

Part No. <a href="#">PE39347Z</a>	Cable Dia.	Attn. @ 1 GHz	Power @ 1 GHz
1 piece price shown. See web or call for volume pricing.	0.109" dia.	25 dB/100ft	
12" 24" 36" 48"	60"	-	Custom Len.
\$40.28 \$41.74 \$43.22 \$41.31	\$42.65	-	See Web

**Standard Flexible Cable Assemblies**

**RG174A/U Coax, 50 Ohm**

Part No. <a href="#">PE39199A</a>	Cable Dia.	Attn. @ 1 GHz	Power @ 1 GHz
1 piece price shown. See web or call for volume pricing.	0.1" dia.	32 dB/100ft	16 W
12" 24" 36" 48"	60"	-	Custom Len.
\$47.75 \$44.69 \$45.17 \$45.65	\$46.14	-	See Web

Part No. <a href="#">PE39199B</a>	Cable Dia.	Attn. @ 1 GHz	Power @ 1 GHz
1 piece price shown. See web or call for volume pricing.	0.1" dia.	32 dB/100ft	16 W
12" 24" 36" 48"	60"	-	Custom Len.
\$44.22 \$44.69 \$45.17 \$45.65	\$46.14	-	See Web

Part No. <a href="#">PE39199C</a>	Cable Dia.	Attn. @ 1 GHz	Power @ 1 GHz
1 piece price shown. See web or call for volume pricing.	0.1" dia.	32 dB/100ft	16 W
12" 24" 36" 48"	60"	-	Custom Len.
\$48.62 \$44.69 \$45.17 \$50.60	\$46.14	-	See Web

Part No. <a href="#">PE39199D</a>	Cable Dia.	Attn. @ 1 GHz	Power @ 1 GHz
1 piece price shown. See web or call for volume pricing.	0.1" dia.	32 dB/100ft	16 W
12" 24" 36" 48"	60"	-	Custom Len.
\$44.22 \$48.39 \$45.17 \$49.71	\$46.14	-	See Web

Part No. <a href="#">PE39199H</a>	Cable Dia.	Attn. @ 1 GHz	Power @ 1 GHz
1 piece price shown. See web or call for volume pricing.	0.1" dia.	32 dB/100ft	16 W
12" 24" 36" 48"	60"	-	Custom Len.
\$44.22 \$49.27 \$45.17 \$45.65	\$46.14	-	See Web

Part No. <a href="#">PE39199I</a>	Cable Dia.	Attn. @ 1 GHz	Power @ 1 GHz
1 piece price shown. See web or call for volume pricing.	0.1" dia.	32 dB/100ft	16 W
12" 24" 36" 48"	60"	-	Custom Len.
\$40.19 \$40.80 \$41.39 \$41.92	\$42.51	-	See Web

Part No. <a href="#">PE39199K</a>	Cable Dia.	Attn. @ 1 GHz	Power @ 1 GHz
1 piece price shown. See web or call for volume pricing.	0.1" dia.	32 dB/100ft	16 W
12" 24" 36" 48"	60"	-	Custom Len.
\$44.22 \$44.69 \$45.17 \$45.65	\$46.14	-	See Web

Part No. <a href="#">PE39199Z</a>	Cable Dia.	Attn. @ 1 GHz	Power @ 1 GHz
1 piece price shown. See web or call for volume pricing.	0.1" dia.	32 dB/100ft	16 W
12" 24" 36" 48"	60"	-	Custom Len.
\$47.75 \$48.39 \$49.03 \$49.71	\$50.36	-	See Web

**RG316/U Coax, 50 Ohm**

Part No. <a href="#">PE39348A</a>	Cable Dia.	Attn. @ 1 GHz	Power @ 1 GHz
1 piece price shown. See web or call for volume pricing.	0.098" dia.	38 dB/100ft	160 W
12" 24" 36" 48"	60"	-	Custom Len.
\$47.14 \$50.34 \$53.56 \$56.24	\$59.42	-	See Web

Part No. <a href="#">PE39348B</a>	Cable Dia.	Attn. @ 1 GHz	Power @ 1 GHz
1 piece price shown. See web or call for volume pricing.	0.098" dia.	38 dB/100ft	160 W
12" 24" 36" 48"	60"	-	Custom Len.
\$47.14 \$50.34 \$53.56 \$56.24	\$59.42	-	See Web

Part No. <a href="#">PE39348C</a>	Cable Dia.	Attn. @ 1 GHz	Power @ 1 GHz
1 piece price shown. See web or call for volume pricing.	0.098" dia.	38 dB/100ft	160 W
12" 24" 36" 48"	60"	-	Custom Len.
\$50.91 \$54.39 \$53.56 \$56.24	\$64.45	-	See Web

Part No. <a href="#">PE39348D</a>	Cable Dia.	Attn. @ 1 GHz	Power @ 1 GHz
1 piece price shown. See web or call for volume pricing.	0.098" dia.	38 dB/100ft	160 W
12" 24" 36" 48"	60"	-	Custom Len.
\$42.85 \$45.97 \$49.17 \$52.38	\$55.06	-	See Web

Part No. <a href="#">PE39348H</a>	Cable Dia.	Attn. @ 1 GHz	Power @ 1 GHz
1 piece price shown. See web or call for volume pricing.	0.098" dia.	38 dB/100ft	160 W
12" 24" 36" 48"	60"	-	Custom Len.
\$47.14 \$50.34 \$53.56 \$56.24	\$65.39	-	See Web

Part No. <a href="#">PE39348I</a>	Cable Dia.	Attn. @ 1 GHz	Power @ 1 GHz
1 piece price shown. See web or call for volume pricing.	0.098" dia.	38 dB/100ft	160 W
12" 24" 36" 48"	60"	-	Custom Len.
\$42.85 \$45.97 \$49.17 \$52.38	\$55.06	-	See Web

Part No. <a href="#">PE39348K</a>	Cable Dia.	Attn. @ 1 GHz	Power @ 1 GHz
1 piece price shown. See web or call for volume pricing.	0.098" dia.	38 dB/100ft	160 W
12" 24" 36" 48"	60"	-	Custom Len.
\$47.14 \$54.81 \$58.25 \$56.24	\$59.42	-	See Web

Part No. <a href="#">PE39348Z</a>	Cable Dia.	Attn. @ 1 GHz	Power @ 1 GHz
1 piece price shown. See web or call for volume pricing.	0.098" dia.	38 dB/100ft	160 W
12" 24" 36" 48"	60"	-	Custom Len.
\$50.91 \$50.34 \$53.56 \$60.95	\$64.45	-	See Web

**SMA MALE TO MC-CARD PLUG**



**Standard Flexible Cable Assemblies**

**RG174A/U Coax, 50 Ohm**

Part No. <a href="#">PE36112</a>	Cable Dia.	Attn. @ 1 GHz	Power @ 1 GHz
1 piece price shown. See web or call for volume pricing.	0.1" dia.	32 dB/100ft	16 W
12" 24" 36" 48"	60"	72"	Custom Len.
\$45.12 \$45.64 \$46.13 \$46.59	\$47.11	\$47.58	See Web

**RG178B/U Coax, 50 Ohm**

Part No. <a href="#">PE36110</a>	Cable Dia.	Attn. @ 1 GHz	Power @ 1 GHz
1 piece price shown. See web or call for volume pricing.	0.072" dia.	44.4 dB/100ft	78 W
12" 24" 36" 48"	60"	72"	Custom Len.
\$54.12 \$54.66 \$55.72 \$56.77	\$57.84	\$58.90	See Web

**RG316/U Coax, 50 Ohm**

Part No. <a href="#">PE36108</a>	Cable Dia.	Attn. @ 1 GHz	Power @ 1 GHz
1 piece price shown. See web or call for volume pricing.	0.098" dia.	38 dB/100ft	160 W
12" 24" 36" 48"	60"	72"	Custom Len.
\$52.76 \$51.32 \$54.13 \$57.45	\$60.73	\$64.03	See Web

**SMA MALE TO MCX PLUG**



**Standard Flexible Cable Assemblies**

**RG174A/U Coax, 50 Ohm**

Part No. <a href="#">PE3W07452</a>	Cable Dia.	Attn. @ 1 GHz	Power @ 1 GHz
1 piece price shown. See web or call for volume pricing.	0.11" dia.	32 dB/100ft	17 W
12" 24" 36" 48"	60"	50CM	Custom Len.
\$50.28 \$50.90 \$51.52 \$52.14	\$52.76	\$50.67	See Web

**RG316-DS Coax, 50 Ohm**

Part No. <a href="#">PE33876</a>	Cable Dia.	Attn. @ 1 GHz	Power @ 1 GHz
1 piece price shown. See web or call for volume pricing.	0.114" dia.	26.1 dB/100ft	160 W
12" 41CM 48CM 56CM	135CM	145CM	Custom Len.
Call Call Call Call	Call	Call	See Web

**SMA MALE TO MINI UHF MALE**



**Standard Flexible Cable Assemblies**

**RG58C/U Coax, 50 Ohm**

Part No. <a href="#">PE3273</a>	Cable Dia.	Attn. @ 1 GHz	Power @ 1 GHz
1 piece price shown. See web or call for volume pricing.	0.195" dia.	20 dB/100ft	44 W
12" 24" 36" 48"	60"	72"	Custom Len.
\$42.89 \$43.70 \$44.53 \$45.34	\$46.16	\$46.98	See Web

**RG142B/U Coax, 50 Ohm**

Part No. <a href="#">PE3275</a>	Cable Dia.	Attn. @ 1 GHz	Power @ 1 GHz
1 piece price shown. See web or call for volume pricing.	0.195" dia.	12.9 dB/100ft	
12" 24" 36" 48"	60"	72"	Custom Len.
\$42.83 \$49.19 \$55.05 \$61.35	\$67.65	\$73.95	See Web

**RG223/U Coax, 50 Ohm**

Part No. <a href="#">PE3271</a>	Cable Dia.	Attn. @ 1 GHz	Power @ 1 GHz
1 piece price shown. See web or call for volume pricing.	0.209" dia.	13.41 dB/100ft	50 W
12" 24" 36" 48"	60"	72"	Custom Len.
\$44.44 \$43.63 \$46.83 \$50.06	\$53.27	\$55.97	See Web

**RG400/U Coax, 50 Ohm**

Part No. <a href="#">PE3278</a>	Cable Dia.	Attn. @ 1 GHz	Power @ 1 GHz
1 piece price shown. See web or call for volume pricing.	0.195" dia.	14.7 dB/100ft	600 W
12" 24" 36" 48"	60"	72"	Custom Len.
\$47.91 \$55.20 \$62.90 \$70.64	\$78.37	\$86.08	See Web

**SMA MALE TO MMCX PLUG**



**Standard Flexible Cable Assemblies**

**RG174A/U Coax, 50 Ohm**

Part No. <a href="#">PE34069</a>	Cable Dia.	Attn. @ 1 GHz	Power @ 1 GHz
1 piece price shown. See web or call for volume pricing.	0.1" dia.	32 dB/100ft	16 W
12" 24" 36" 48"	60"	72"	Custom Len.
\$58.22 \$58.85 \$59.49 \$60.16	\$55.82	\$56.29	See Web

**RG178B/U Coax, 50 Ohm**

Part No. <a href="#">PE34374</a>	Cable Dia.	Attn. @ 1 GHz	Power @ 1 GHz
1 piece price shown. See web or call for volume pricing.	0.072" dia.	44.4 dB/100ft	78 W
12" 24" 36" 48"	60"	72"	Custom Len.
\$67.01 \$68.17 \$64.17 \$65.22	\$66.26	\$72.95	See Web

**RG188A/U Coax, 50 Ohm**

Part No. <a href="#">PE34887</a>	Cable Dia.	Attn. @ 1 GHz	Power @ 1 GHz
1 piece price shown. See web or call for volume pricing.	0.11" dia.	26 dB/100ft	160 W
12" 24" 36" 48"	60"	72"	Custom Len.
\$61.53 \$64.28 \$67.02 \$69.92	\$65.68	\$68.13	See Web

**RG316/U Coax, 50 Ohm**

Part No. <a href="#">PE34122</a>	Cable Dia.	Attn. @ 1 GHz	Power @ 1 GHz
1 piece price shown. See web or call for volume pricing.	0.098" dia.	38 dB/100ft	160 W
12" 24" 36" 48"	60"	72"	Custom Len.
\$60.45 \$63.90 \$67.34 \$70.97	\$68.68	\$77.97	See Web

**SMA MALE TO MMCX PLUG RIGHT ANGLE**



**Standard Formable Cable Assemblies**

\*Coax Performance at 1 GHz Notes: Cable assembly max frequency may be lower than connector or coax max frequency

# For our complete selection of cable assemblies, please visit our website

PE-SR405FLJ Coax, 50 Ohm						
Part No. <b>PE39564</b>	Cable Dia.			Attn. @ 1 GHz	Power @ 1 GHz	
1 piece price shown. See web or call for volume pricing.	0.098" dia.			19.5 dB/100ft	130 W	
6"	9"	12"	18"	24"	-	Custom Len.
\$46.10	\$43.80	\$46.10	Call	\$55.55	-	See Web

## Standard Flexible Cable Assemblies

RG178B/U Coax, 50 Ohm						
Part No. <b>PE34777</b>	Cable Dia.			Attn. @ 1 GHz	Power @ 1 GHz	
1 piece price shown. See web or call for volume pricing.	0.072" dia.			44.4 dB/100ft	78 W	
12"	24"	36"	48"	60"	-	Custom Len.
\$72.71	\$73.87	\$75.03	\$76.26	\$77.45	-	See Web

## SMA MALE TO N MALE



## Flexible Cable Assemblies

LMR-240 Coax, 50 Ohm						
Part No. <b>PE3C0102</b>	Cable Dia.			Attn. @ 1 GHz	Power @ 1 GHz	
1 piece price shown. See web or call for volume pricing.	0.24" dia.			8 dB/100ft	-	Custom Len.
12"	24"	36"	48"	60"	-	Custom Len.
\$46.08	\$47.17	\$48.25	\$49.39	\$50.49	-	See Web

LMR-195 Coax, 50 Ohm						
Part No. <b>PE3C0121</b>	Cable Dia.			Attn. @ 1 GHz	Power @ 1 GHz	
1 piece price shown. See web or call for volume pricing.	0.195" dia.			11.8 dB/100ft	-	Custom Len.
12"	24"	36"	48"	60"	-	Custom Len.
\$52.00	\$52.84	\$53.68	\$54.04	\$54.87	-	See Web

LMR-240-UF Coax, 50 Ohm						
Part No. <b>PE3CA1067</b>	Cable Dia.			Attn. @ 1 GHz	Power @ 1 GHz	
1 piece price shown. See web or call for volume pricing.	0.24" dia.			9.19 dB/100ft	-	Custom Len.
12"	24"	36"	48"	60"	72"	Custom Len.
Call	Call	Call	Call	Call	Call	See Web

## Low Loss Flexible Cable Assemblies

PE-C100-LSZH Coax, 50 Ohm						
Part No. <b>PE38433</b>	Cable Dia.			Attn. @ 1 GHz	Power @ 1 GHz	
1 piece price shown. See web or call for volume pricing.	0.109" dia.			25 dB/100ft	-	Custom Len.
12"	24"	36"	48"	60"	-	Custom Len.
\$46.92	\$49.11	\$51.38	\$55.58	\$55.33	-	See Web

PE-C195 Coax, 50 Ohm						
Part No. <b>PE35981</b>	Cable Dia.			Attn. @ 1 GHz	Power @ 1 GHz	
1 piece price shown. See web or call for volume pricing.	0.195" dia.			11.3 dB/100ft	150 W	
12"	24"	36"	48"	60"	-	Custom Len.
\$45.95	\$46.81	\$47.69	\$48.60	\$49.49	-	See Web

PE-C200 Coax, 50 Ohm						
Part No. <b>PE36200</b>	Cable Dia.			Attn. @ 1 GHz	Power @ 1 GHz	
1 piece price shown. See web or call for volume pricing.	0.195" dia.			10.8 dB/100ft	170 W	
12"	24"	36"	48"	60"	-	Custom Len.
\$46.62	\$50.34	\$51.27	\$57.50	\$62.12	-	See Web

PE-C240 Coax, 50 Ohm						
Part No. <b>PE38645</b>	Cable Dia.			Attn. @ 1 GHz	Power @ 1 GHz	
1 piece price shown. See web or call for volume pricing.	0.24" dia.			9.2 dB/100ft	250 W	
12"	24"	36"	48"	60"	-	Custom Len.
\$58.17	\$62.90	\$64.16	\$65.15	\$66.75	-	See Web

LMR-240 Coax, 50 Ohm						
Part No. <b>PE3C0044</b>	Cable Dia.			Attn. @ 1 GHz	Power @ 1 GHz	
1 piece price shown. See web or call for volume pricing.	0.24" dia.			8 dB/100ft	-	Custom Len.
12"	24"	36"	48"	60"	-	Custom Len.
\$58.84	\$59.92	\$60.98	\$59.77	\$60.85	-	See Web

LMR-400 Coax, 50 Ohm						
Part No. <b>PE3W00832</b>	Cable Dia.			Attn. @ 1 GHz	Power @ 1 GHz	
1 piece price shown. See web or call for volume pricing.	0.405" dia.			4.25 dB/100ft	-	Custom Len.
12"	24"	36"	48"	60"	50CM	Custom Len.
\$66.76	\$68.22	\$69.69	\$71.14	\$72.61	\$67.69	See Web

PE-P142LL Coax, 50 Ohm						
Part No. <b>PE3C0689</b>	Cable Dia.			Attn. @ 1 GHz	Power @ 1 GHz	
1 piece price shown. See web or call for volume pricing.	0.195" dia.			7.2 dB/100ft	-	Custom Len.
12"	24"	36"	48"	60"	50CM	Custom Len.
\$139.06	\$156.68	\$174.27	\$191.88	\$209.48	\$150.34	See Web

PE-P142LL-27478 Coax, 50 Ohm						
Part No. <b>PE3M0132</b>	Cable Dia.			Attn. @ 1 GHz	Power @ 1 GHz	
1 piece price shown. See web or call for volume pricing.	0.195" dia.			-	-	Custom Len.
12"	18"	24"	36"	48"	60"	Custom Len.
\$389.15	\$398.34	\$407.53	\$425.92	\$444.29	\$462.68	See Web

PE-P160LL-27478 Coax, 50 Ohm						
Part No. <b>PE3M0186</b>	Cable Dia.			Attn. @ 1 GHz	Power @ 1 GHz	
1 piece price shown. See web or call for volume pricing.	0.16" dia.			-	-	Custom Len.
8"	12"	18"	24"	30"	36"	Custom Len.
\$369.32	\$374.62	\$382.61	\$390.56	\$398.54	\$406.49	See Web

PE-P300LL-27478 Coax, 50 Ohm						
Part No. <b>PE3M0229</b>	Cable Dia.			Attn. @ 1 GHz	Power @ 1 GHz	
1 piece price shown. See web or call for volume pricing.	0.3" dia.			-	-	Custom Len.
12"	18"	24"	36"	48"	60"	Custom Len.
\$439.55	\$454.90	\$470.23	\$500.92	\$531.60	\$562.29	See Web

## LMR-240-UF Coax, 50 Ohm

Part No. <b>PE3W01626</b>						
Cable Dia.			Attn. @ 1 GHz	Power @ 1 GHz		
1 piece price shown. See web or call for volume pricing.			0.195" dia.	-	-	Custom Len.
12"	24"	36"	48"	60"	50CM	Custom Len.
\$49.84	\$51.31	\$52.76	\$54.22	\$55.18	\$50.78	See Web

## Precision Formable Cable Assemblies

PE-80TEST Coax, 50 Ohm						
Part No. <b>PE3TC0105</b>	Cable Dia.			Attn. @ 1 GHz	Power @ 1 GHz	
1 piece price shown. See web or call for volume pricing.	0.195" dia.			-	-	Custom Len.
24"	48"	72"	-	-	-	Custom Len.
\$357.55	\$450.50	\$543.47	-	-	-	See Web

PE-90TEST Coax, 50 Ohm						
Part No. <b>PE3TC0303</b>	Cable Dia.			Attn. @ 1 GHz	Power @ 1 GHz	
1 piece price shown. See web or call for volume pricing.	0.151" dia.			-	-	Custom Len.
24"	48"	72"	-	-	-	Custom Len.
\$292.28	\$373.27	\$457.78	-	-	-	See Web

## Standard Formable Cable Assemblies

PE-SR047FL Coax, 50 Ohm						
Part No. <b>PE34268</b>	Cable Dia.			Attn. @ 1 GHz	Power @ 1 GHz	
1 piece price shown. See web or call for volume pricing.	0.047" dia.			36 dB/100ft	32 W	
6"	12"	18"	24"	36"	48"	Custom Len.
\$92.54	\$96.44	\$100.41	\$104.28	\$110.58	\$118.34	See Web

PE-SR401FL Coax, 50 Ohm						
Part No. <b>PE34263</b>	Cable Dia.			Attn. @ 1 GHz	Power @ 1 GHz	
1 piece price shown. See web or call for volume pricing.	7.6 dB/100ft			1,400 W	-	Custom Len.
6"	12"	18"	24"	36"	48"	Custom Len.
\$142.48	\$151.08	\$150.87	\$159.22	\$186.50	\$192.62	See Web

PE-SR402FL Coax, 50 Ohm						
Part No. <b>PE3448</b>	Cable Dia.			Attn. @ 1 GHz	Power @ 1 GHz	
1 piece price shown. See web or call for volume pricing.	11.88 dB/100ft			450 W	-	Custom Len.
6"	12"	18"	24"	36"	48"	Custom Len.
\$76.11	\$80.42	\$84.86	\$89.31	\$92.45	\$100.73	See Web

PE-SR405FL Coax, 50 Ohm						
Part No. <b>PE3657</b>	Cable Dia.			Attn. @ 1 GHz	Power @ 1 GHz	
1 piece price shown. See web or call for volume pricing.	22.5 dB/100ft			130 W	-	Custom Len.
6"	12"	18"	24"	36"	48"	Custom Len.
\$89.87	\$90.50	\$96.36	\$102.24	\$112.42	\$124.00	See Web

## Standard Flexible Cable Assemblies

RG8A/U Coax, 50 Ohm						
Part No. <b>PE3323</b>	Cable Dia.			Attn. @ 1 GHz	Power @ 1 GHz	
1 piece price shown. See web or call for volume pricing.	0.405" dia.			8 dB/100ft	190 W	
12"	24"	36"	48"	60"	72"	Custom Len.
\$142.61	\$137.60	\$149.26	\$143.75	\$146.82	\$149.88	See Web

RG142B/U Coax, 50 Ohm						
Part No. <b>PE3568</b>	Cable Dia.			Attn. @ 1 GHz	Power @ 1 GHz	
1 piece price shown. See web or call for volume pricing.	0.195" dia.			13 dB/100ft	650 W	
12"	24"	36"	48"	60"	72"	Custom Len.
\$54.22	\$60.41	\$67.09	\$74.17	\$80.98	\$87.80	See Web

RG174A/U Coax, 50 Ohm						
Part No. <b>PE3291</b>	Cable Dia.			Attn. @ 1 GHz	Power @ 1 GHz	
1 piece price shown. See web or call for volume pricing.	0.11" dia.			32 dB/100ft	17 W	
12"	24"	36"	48"	60"	72"	Custom Len.
\$54.98	\$55.62	\$54.32	\$56.92	\$57.58	\$58.23	See Web

RG178B/U Coax, 50 Ohm						
Part No. <b>PE3321</b>	Cable Dia.			Attn. @ 1 GHz	Power @ 1 GHz	
1 piece price shown. See web or call for volume pricing.	0.072" dia.			44.4 dB/100ft	55 W	
12"	24"	36"	48"	60"	72"	Custom Len.
\$79.00	\$80.16	\$81.33	\$77.70	\$78.74	\$84.94	See Web

RG188A/U Coax, 50 Ohm						
Part No. <b>PE3911</b>	Cable Dia.			Attn. @ 1 GHz	Power @ 1 GHz	
1 piece price shown. See web or call for volume pricing.	0.11" dia.			26 dB/100ft	160 W	
12"	24"	36"	48"	60"	72"	Custom Len.
\$55.84	\$63.04	\$60.72	\$63.16	\$65.60	\$68.04	See Web

RG214/U Coax, 50 Ohm						
Part No. <b>PE3422</b>	Cable Dia.			Attn. @ 1 GHz	Power @ 1 GHz	
1 piece price shown. See web or call for volume pricing.	0.425" dia.			7.32 dB/100ft	190 W	
12"	24"	36"	48"	60"	72"	Custom Len.
\$141.35	\$149.31	\$157.25	\$165.20	\$173.13	\$192.84	See Web

RG223/U Coax, 50 Ohm						
Part No. <b>PE3519</b>	Cable Dia.			Attn. @ 1 GHz	Power @ 1 GHz	
1 piece price shown. See web or call for volume pricing.	0.21" dia.			13.4 dB/100ft	53 W	
12"	24"	36"	48"	60"	72"	Custom Len.
\$49.56	\$53.00	\$55.95	\$59.57	\$63.06	\$66.54	See Web

RG316-DS Coax, 50 Ohm						
Part No. <b>PE3957</b>	Cable Dia.			Attn. @ 1 GHz	Power @ 1 GHz	
1 piece price shown. See web or call for volume pricing.	0.114" dia.			30 dB/100ft	85 W	
12"	24"	36"	48"	60"	72"	Custom Len.
\$47.39	\$50.50	\$53.74	\$56.46	\$60.97	\$64.48	See Web

Cable Assemblies

See Our Website For Current Pricing & Real-Time Stock Availability!

For Custom Lengths, Metric Lengths or Special Configurations, Please call (949) 261-1920



Technical Support  
+1 (949) 261-1920



Same-Day Shipping,  
Even Custom  
Cable Assemblies

For our complete selection of cable assemblies, please visit our website

Cable Assemblies  
See Our Website For Current Pricing & Real-Time Stock Availability!

RG393/U Coax, 50 Ohm						
Part No. <a href="#">PE3302</a>	Cable Dia.	Attn. @ 1 GHz	Power @ 1 GHz			
1 piece price shown. See web or call for volume pricing.	0.39" dia.	7.5 dB/100ft	1,700 W			
12" 24" 36" 48"	60"	72"	Custom Len.			
\$150.81 \$167.57 \$184.35 \$214.25	\$232.39	\$250.50	See Web			
RG400/U Coax, 50 Ohm						
Part No. <a href="#">PE3314</a>	Cable Dia.	Attn. @ 1 GHz	Power @ 1 GHz			
1 piece price shown. See web or call for volume pricing.	0.195" dia.	14.7 dB/100ft	650 W			
12" 24" 36" 48"	60"	72"	Custom Len.			
\$64.04 \$72.17 \$80.30 \$88.90	\$97.20	\$105.48	See Web			
PE-P141 Coax, 50 Ohm						
Part No. <a href="#">PE304</a>	Cable Dia.	Attn. @ 1 GHz	Power @ 1 GHz			
1 piece price shown. See web or call for volume pricing.	0.163" dia.					
12" 24" 36" 48"	60"	72"	Custom Len.			
\$167.94 \$185.30 \$197.62 \$214.95	\$223.19	\$235.74	See Web			
PE-P195 Coax, 50 Ohm						
Part No. <a href="#">PE3318</a>	Cable Dia.	Attn. @ 1 GHz	Power @ 1 GHz			
1 piece price shown. See web or call for volume pricing.	0.195" dia.	12.5 dB/100ft	650 W			
12" 24" 36" 48"	60"	72"	Custom Len.			
\$61.81 \$74.81 \$85.34 \$96.48	\$107.22	\$108.93	See Web			
PE-P142FLX Coax, 50 Ohm						
Part No. <a href="#">PE3C0252</a>	Cable Dia.	Attn. @ 1 GHz	Power @ 1 GHz			
1 piece price shown. See web or call for volume pricing.	0.195" dia.	11.6 dB/100ft				
12" 24" 36" 48"	60"	300"	Custom Len.			
Call Call Call Call	Call	Call	See Web			
LMR-240-DB Coax, 50 Ohm						
Part No. <a href="#">PE3C3354</a>	Cable Dia.	Attn. @ 1 GHz	Power @ 1 GHz			
1 piece price shown. See web or call for volume pricing.	0.24" dia.	7.66 dB/100ft				
12" 50CM 24" 36"	100CM	48"	Custom Len.			
\$45.17 \$43.41 \$43.86 \$45.09	\$45.44	\$46.33	See Web			
Standard Semi-Rigid Cable Assemblies						
PE-047SR Coax, 50 Ohm						
Part No. <a href="#">PE34257</a>	Cable Dia.	Attn. @ 1 GHz	Power @ 1 GHz			
1 piece price shown. See web or call for volume pricing.		40 dB/100ft	32 W			
6" 12" 18" 24"	36"	48"	Custom Len.			
\$94.05 \$99.53 \$105.02 \$108.89	\$128.03	\$130.44	See Web			
PE-SR047AL Coax, 50 Ohm						
Part No. <a href="#">PE34261</a>	Cable Dia.	Attn. @ 1 GHz	Power @ 1 GHz			
1 piece price shown. See web or call for volume pricing.	0.047" dia.	41 dB/100ft	32 W			
6" 12" 18" 24"	36"	48"	Custom Len.			
\$93.46 \$98.26 \$103.10 \$107.98	\$115.96	\$125.56	See Web			
PE-SR402AL Coax, 50 Ohm						
Part No. <a href="#">PE34265</a>	Cable Dia.	Attn. @ 1 GHz	Power @ 1 GHz			
1 piece price shown. See web or call for volume pricing.	0.141" dia.	13 dB/100ft	450 W			
6" 12" 18" 24"	36"	48"	Custom Len.			
\$76.56 \$81.15 \$86.75 \$86.91	\$97.26	\$107.59	See Web			
PE-SR405AL Coax, 50 Ohm						
Part No. <a href="#">PE34270</a>	Cable Dia.	Attn. @ 1 GHz	Power @ 1 GHz			
1 piece price shown. See web or call for volume pricing.		23 dB/100ft	130 W			
6" 12" 18" 24"	36"	48"	Custom Len.			
\$88.19 \$88.19 \$92.93 \$97.67	\$107.18	\$115.05	See Web			
RG401/U Coax, 50 Ohm						
Part No. <a href="#">PE33001</a>	Cable Dia.	Attn. @ 1 GHz	Power @ 1 GHz			
1 piece price shown. See web or call for volume pricing.		7.5 dB/100ft	1,400 W			
6" 12" 18" 24"	36"	48"	Custom Len.			
\$146.83 \$149.78 \$161.67 \$173.58	\$197.36	\$221.16	See Web			
RG405/U Coax, 50 Ohm						
Part No. <a href="#">PE3828</a>	Cable Dia.	Attn. @ 1 GHz	Power @ 1 GHz			
1 piece price shown. See web or call for volume pricing.		22 dB/100ft	130 W			
6" 12" 18" 24"	36"	48"	Custom Len.			
\$87.33 \$91.31 \$99.93 \$93.71	\$107.64	\$107.29	See Web			
PE-SR401AL-STRAIGHT Coax, 50 Ohm						
Part No. <a href="#">PE34259</a>	Cable Dia.	Attn. @ 1 GHz	Power @ 1 GHz			
1 piece price shown. See web or call for volume pricing.	0.25" dia.	8 dB/100ft	1,400 W			
6" 12" 18" 24"	36"	48"	Custom Len.			
\$127.76 \$145.57 \$158.36 \$171.17	\$175.45	\$194.53	See Web			
Standard Flexible Cable Assemblies						
RG55B/U Coax, 53 Ohm						
Part No. <a href="#">PE3654</a>	Cable Dia.	Attn. @ 1 GHz	Power @ 1 GHz			
1 piece price shown. See web or call for volume pricing.	0.202" dia.	16.5 dB/100ft	53 W			
12" 24" 36" 48"	60"	72"	Custom Len.			
\$49.09 \$51.57 \$57.24 \$56.02	\$58.50	\$60.96	See Web			
SMA MALE TO N MALE RIGHT ANGLE						
Low Loss Flexible Cable Assemblies						
PE-P142LL Coax, 50 Ohm						
Part No. <a href="#">PE3C1037</a>	Cable Dia.	Attn. @ 1 GHz	Power @ 1 GHz			
1 piece price shown. See web or call for volume pricing.	0.195" dia.	7.2 dB/100ft				
12" 24" 36" 48"	60"	50CM	Custom Len.			
\$243.96 \$261.57 \$279.15 \$296.76	\$314.36	\$255.24	See Web			



PE-P142LL-27478 Coax, 50 Ohm						
Part No. <a href="#">PE3M0134</a>	Cable Dia.	Attn. @ 1 GHz	Power @ 1 GHz			
1 piece price shown. See web or call for volume pricing.	0.195" dia.					
12" 18" 24" 36"	60"	60"	Custom Len.			
\$513.86 \$523.05 \$532.24 \$550.62	\$569.00	\$587.40	See Web			
PE-P160LL-27478 Coax, 50 Ohm						
Part No. <a href="#">PE3M0188</a>	Cable Dia.	Attn. @ 1 GHz	Power @ 1 GHz			
1 piece price shown. See web or call for volume pricing.	0.16" dia.					
8" 12" 18" 24"	30"	36"	Custom Len.			
\$475.62 \$480.94 \$488.90 \$496.87	\$504.85	\$512.81	See Web			
PE-P300LL-27478 Coax, 50 Ohm						
Part No. <a href="#">PE3M0231</a>	Cable Dia.	Attn. @ 1 GHz	Power @ 1 GHz			
1 piece price shown. See web or call for volume pricing.	0.3" dia.					
12" 18" 24" 36"	48"	60"	Custom Len.			
\$596.69 \$612.04 \$627.38 \$658.06	\$688.75	\$719.43	See Web			
Low Loss Test Flexible Cable Assemblies						
PE-P300LL Coax, 50 Ohm						
Part No. <a href="#">PE3C3236</a>	Cable Dia.	Attn. @ 1 GHz	Power @ 1 GHz			
1 piece price shown. See web or call for volume pricing.	0.3" dia.	5.5 dB/100ft				
12" 24" 36" 48"	60"	50CM	Custom Len.			
\$252.78 \$280.10 \$307.39 \$334.69	\$361.99	\$270.29	See Web			
PE-P300LL Coax, 50 Ohm						
Part No. <a href="#">PE3C3251</a>	Cable Dia.	Attn. @ 1 GHz	Power @ 1 GHz			
1 piece price shown. See web or call for volume pricing.	0.3" dia.	5.5 dB/100ft				
12" 24" 36" 48"	60"	50CM	Custom Len.			
\$400.69 \$428.02 \$455.34 \$482.67	\$509.99	\$418.20	See Web			
Standard Formable Cable Assemblies						
PE-SR402FL Coax, 50 Ohm						
Part No. <a href="#">PE3W00507</a>	Cable Dia.	Attn. @ 1 GHz	Power @ 1 GHz			
1 piece price shown. See web or call for volume pricing.		11.88 dB/100ft	450 W			
12" 24" 36" 48"	60"	50CM	Custom Len.			
\$67.01 \$75.63 \$84.26 \$92.88	\$101.51	\$72.54	See Web			
PE-SR402FLJ Coax, 50 Ohm						
Part No. <a href="#">PE3W00504</a>	Cable Dia.	Attn. @ 1 GHz	Power @ 1 GHz			
1 piece price shown. See web or call for volume pricing.	0.161" dia.		450 W			
12" 24" 36" 48"	60"	50CM	Custom Len.			
\$66.15 \$75.02 \$83.90 \$92.78	\$101.65	\$71.84	See Web			
Standard Flexible Cable Assemblies						
RG58C/U Coax, 50 Ohm						
Part No. <a href="#">PE3076</a>	Cable Dia.	Attn. @ 1 GHz	Power @ 1 GHz			
1 piece price shown. See web or call for volume pricing.	0.195" dia.	20 dB/100ft	44 W			
12" 24" 36" 48"	60"	-	Custom Len.			
\$68.49 \$69.38 \$70.28 \$71.22	\$72.14	-	See Web			
SMA MALE TO N FEMALE						
Low Loss Flexible Cable Assemblies						
LMR-195 Coax, 50 Ohm						
Part No. <a href="#">PE3W00177</a>	Cable Dia.	Attn. @ 1 GHz	Power @ 1 GHz			
1 piece price shown. See web or call for volume pricing.	0.195" dia.	11.8 dB/100ft				
12" 24" 36" 48"	60"	50CM	Custom Len.			
\$38.66 \$54.26 \$54.98 \$55.69	\$56.40	\$54.50	See Web			
Low Loss Test Flexible Cable Assemblies						
PE-P300LL Coax, 50 Ohm						
Part No. <a href="#">PE3C3237</a>	Cable Dia.	Attn. @ 1 GHz	Power @ 1 GHz			
1 piece price shown. See web or call for volume pricing.	0.3" dia.	5.5 dB/100ft				
12" 24" 36" 48"	60"	50CM	Custom Len.			
\$236.22 \$263.51 \$290.81 \$318.12	\$345.42	\$253.71	See Web			
PE-P300LL Coax, 50 Ohm						
Part No. <a href="#">PE3C3252</a>	Cable Dia.	Attn. @ 1 GHz	Power @ 1 GHz			
1 piece price shown. See web or call for volume pricing.	0.3" dia.	5.5 dB/100ft				
12" 24" 36" 48"	60"	50CM	Custom Len.			
\$256.21 \$283.54 \$310.87 \$338.20	\$365.50	\$273.72	See Web			
Standard Flexible Cable Assemblies						
PE-P195 Coax, 50 Ohm						
Part No. <a href="#">PE3W00250</a>	Cable Dia.	Attn. @ 1 GHz	Power @ 1 GHz			
1 piece price shown. See web or call for volume pricing.	0.195" dia.	12.5 dB/100ft	650 W			
12" 24" 36" 48"	60"	50CM	Custom Len.			
\$66.17 \$76.39 \$86.61 \$96.84	\$107.05	\$62.49	See Web			
SMA MALE TO N FEMALE BULKHEAD						
SEE MOUNTING HOLE SECTION ON PAGE 409						
Low Loss Flexible Cable Assemblies						
PE-P142LL Coax, 50 Ohm						
Part No. <a href="#">PE3C2162</a>	Cable Dia.	Attn. @ 1 GHz	Power @ 1 GHz			
1 piece price shown. See web or call for volume pricing.	0.195" dia.	10 dB/100ft				
12" 24" 36" 48"	60"	50CM	Custom Len.			
\$194.86 \$212.46 \$230.04 \$247.66	\$265.26	\$206.14	See Web			



\*Coax Performance at 1 GHz Notes: Cable assembly max frequency may be lower than connector or coax max frequency



# For our complete selection of cable assemblies, please visit our website

PE-P142LL-27478 Coax, 50 Ohm						
Part No. <a href="#">PE3M0133</a>	Cable Dia.			Attn. @ 1 GHz	Power @ 1 GHz	
1 piece price shown. See web or call for volume pricing.	0.195" dia.					
12"	18"	24"	36"	100CM	48"	Custom Len.
\$483.70	\$492.88	\$502.07	\$520.46	\$525.61	\$538.84	See Web
PE-P160LL-27478 Coax, 50 Ohm						
Part No. <a href="#">PE3M0187</a>	Cable Dia.			Attn. @ 1 GHz	Power @ 1 GHz	
1 piece price shown. See web or call for volume pricing.	0.16" dia.					
8"	12"	18"	24"	30"	36"	Custom Len.
\$479.88	\$485.20	\$493.16	\$501.13	\$509.12	\$517.07	See Web
PE-P300LL-27478 Coax, 50 Ohm						
Part No. <a href="#">PE3M0230</a>	Cable Dia.			Attn. @ 1 GHz	Power @ 1 GHz	
1 piece price shown. See web or call for volume pricing.	0.3" dia.					
12"	18"	24"	36"	48"	60"	Custom Len.
\$521.60	\$536.95	\$552.28	\$582.96	\$613.66	\$644.34	See Web
Precision Formable Cable Assemblies						
PE-SR402FL Coax, 50 Ohm						
Part No. <a href="#">PE39455</a>	Cable Dia.			Attn. @ 1 GHz	Power @ 1 GHz	
1 piece price shown. See web or call for volume pricing.	11.88 dB/100ft			450 W		
3"	6"	9"	12"	18"	24"	Custom Len.
Call	\$72.09	\$65.54	\$72.09	\$76.68	\$81.27	See Web
PE-SR402FLJ Coax, 50 Ohm						
Part No. <a href="#">PE39469</a>	Cable Dia.			Attn. @ 1 GHz	Power @ 1 GHz	
1 piece price shown. See web or call for volume pricing.	0.161" dia.			11.89 dB/100ft	450 W	
6"	9"	12"	18"	24"	-	Custom Len.
\$59.16	Call	\$59.16	\$64.09	\$69.04	-	See Web
PE-SR405FL Coax, 50 Ohm						
Part No. <a href="#">PE39447</a>	Cable Dia.			Attn. @ 1 GHz	Power @ 1 GHz	
1 piece price shown. See web or call for volume pricing.	22.5 dB/100ft			130 W		
6"	9"	12"	18"	24"	-	Custom Len.
\$29.48	\$51.13	\$29.48	Call	Call	-	See Web
PE-SR405FLJ Coax, 50 Ohm						
Part No. <a href="#">PE39461</a>	Cable Dia.			Attn. @ 1 GHz	Power @ 1 GHz	
1 piece price shown. See web or call for volume pricing.	0.098" dia.			19.5 dB/100ft	130 W	
6"	9"	12"	18"	24"	-	Custom Len.
\$56.56	\$56.56	Call	\$61.17	\$65.74	-	See Web
Low Loss Test Flexible Cable Assemblies						
PE-P300LL Coax, 50 Ohm						
Part No. <a href="#">PE3C3246</a>	Cable Dia.			Attn. @ 1 GHz	Power @ 1 GHz	
1 piece price shown. See web or call for volume pricing.	0.3" dia.			5.5 dB/100ft		
12"	24"	36"	48"	60"	50CM	Custom Len.
\$318.86	\$346.18	\$373.51	\$400.84	\$428.15	\$336.36	See Web
Standard Formable Cable Assemblies						
PE-SR407FL Coax, 50 Ohm						
Part No. <a href="#">PE34153</a>	Cable Dia.			Attn. @ 1 GHz	Power @ 1 GHz	
1 piece price shown. See web or call for volume pricing.	0.047" dia.			36 dB/100ft	32 W	
6"	12"	18"	24"	36"	48"	Custom Len.
\$102.56	\$106.46	\$108.89	\$112.74	\$120.47	\$128.21	See Web
PE-SR401FL Coax, 50 Ohm						
Part No. <a href="#">PE34163</a>	Cable Dia.			Attn. @ 1 GHz	Power @ 1 GHz	
1 piece price shown. See web or call for volume pricing.	7.6 dB/100ft			1,400 W		
6"	12"	18"	24"	36"	48"	Custom Len.
\$123.97	\$123.97	\$132.32	\$140.68	\$157.38	\$174.07	See Web
PE-SR402FL Coax, 50 Ohm						
Part No. <a href="#">PE33996</a>	Cable Dia.			Attn. @ 1 GHz	Power @ 1 GHz	
1 piece price shown. See web or call for volume pricing.	11.88 dB/100ft			450 W		
6"	12"	18"	24"	36"	48"	Custom Len.
\$88.13	\$88.13	\$92.72	\$97.31	\$106.50	\$114.08	See Web
PE-SR405FL Coax, 50 Ohm						
Part No. <a href="#">PE33844</a>	Cable Dia.			Attn. @ 1 GHz	Power @ 1 GHz	
1 piece price shown. See web or call for volume pricing.	22.5 dB/100ft			130 W		
6"	12"	18"	24"	36"	48"	Custom Len.
\$89.40	\$90.04	\$95.93	\$101.82	\$111.98	\$123.59	See Web
Standard Flexible Cable Assemblies						
RG58C/U Coax, 50 Ohm						
Part No. <a href="#">PE3013</a>	Cable Dia.			Attn. @ 1 GHz	Power @ 1 GHz	
1 piece price shown. See web or call for volume pricing.	0.195" dia.			20 dB/100ft	44 W	
6"	12"	18"	24"	36"	48"	Custom Len.
\$63.28	\$65.82	\$63.68	\$66.72	\$67.60	\$68.55	See Web
RG142B/U Coax, 50 Ohm						
Part No. <a href="#">PE3345</a>	Cable Dia.			Attn. @ 1 GHz	Power @ 1 GHz	
1 piece price shown. See web or call for volume pricing.	0.195" dia.			13 dB/100ft	650 W	
6"	12"	18"	24"	36"	48"	Custom Len.
\$56.63	\$56.49	\$63.22	\$66.55	\$73.24	\$80.31	See Web
RG174A/U Coax, 50 Ohm						
Part No. <a href="#">PE34171</a>	Cable Dia.			Attn. @ 1 GHz	Power @ 1 GHz	
1 piece price shown. See web or call for volume pricing.	0.1" dia.			32 dB/100ft	16 W	
6"	12"	18"	24"	36"	48"	Custom Len.
\$71.46	\$71.77	\$66.71	\$66.94	\$67.41	\$67.89	See Web
RG178B/U Coax, 50 Ohm						
Part No. <a href="#">PE34174</a>	Cable Dia.			Attn. @ 1 GHz	Power @ 1 GHz	
1 piece price shown. See web or call for volume pricing.	0.072" dia.			44.4 dB/100ft	78 W	
6"	12"	18"	24"	36"	48"	Custom Len.
\$70.18	\$70.69	\$71.23	\$71.77	\$72.82	\$73.86	See Web

RG188A/U Coax, 50 Ohm						
Part No. <a href="#">PE34176</a>	Cable Dia.			Attn. @ 1 GHz	Power @ 1 GHz	
1 piece price shown. See web or call for volume pricing.	0.11" dia.			26 dB/100ft	160 W	
6"	12"	18"	24"	36"	48"	Custom Len.
\$62.27	\$63.45	\$64.56	\$65.74	\$68.13	\$70.44	See Web
RG213/U Coax, 50 Ohm						
Part No. <a href="#">PE34185</a>	Cable Dia.			Attn. @ 1 GHz	Power @ 1 GHz	
1 piece price shown. See web or call for volume pricing.	0.405" dia.			8 dB/100ft	190 W	
6"	12"	18"	24"	36"	48"	Custom Len.
\$138.83	\$139.72	\$140.57	\$141.49	\$143.31	\$145.13	See Web
RG214/U Coax, 50 Ohm						
Part No. <a href="#">PE33481</a>	Cable Dia.			Attn. @ 1 GHz	Power @ 1 GHz	
1 piece price shown. See web or call for volume pricing.	0.425" dia.			7.32 dB/100ft	190 W	
6"	12"	18"	24"	36"	48"	Custom Len.
\$137.22	\$137.22	\$149.67	\$145.19	\$153.12	\$161.06	See Web
RG223/U Coax, 50 Ohm						
Part No. <a href="#">PE3193</a>	Cable Dia.			Attn. @ 1 GHz	Power @ 1 GHz	
1 piece price shown. See web or call for volume pricing.	0.209" dia.			13.41 dB/100ft	50 W	
6"	12"	18"	24"	36"	48"	Custom Len.
\$57.09	\$58.77	\$56.00	\$57.61	\$60.80	\$63.96	See Web
RG316/U Coax, 50 Ohm						
Part No. <a href="#">PE33555</a>	Cable Dia.			Attn. @ 1 GHz	Power @ 1 GHz	
1 piece price shown. See web or call for volume pricing.	0.098" dia.			38 dB/100ft	160 W	
5"	6"	12"	18"	24"	36"	Custom Len.
\$73.69	\$72.02	\$73.69	\$69.82	\$71.40	\$80.55	See Web
RG316-DS Coax, 50 Ohm						
Part No. <a href="#">PE33929</a>	Cable Dia.			Attn. @ 1 GHz	Power @ 1 GHz	
1 piece price shown. See web or call for volume pricing.	0.114" dia.			30 dB/100ft	160 W	
6"	12"	18"	24"	36"	48"	Custom Len.
\$65.83	\$71.10	\$67.43	\$74.54	\$77.96	\$75.44	See Web
RG393/U Coax, 50 Ohm						
Part No. <a href="#">PE34183</a>	Cable Dia.			Attn. @ 1 GHz	Power @ 1 GHz	
1 piece price shown. See web or call for volume pricing.	0.39" dia.			8.8 dB/100ft	1,700 W	
6"	12"	18"	24"	36"	48"	Custom Len.
\$129.91	\$138.38	\$146.76	\$155.22	\$172.13	\$189.06	See Web
RG400/U Coax, 50 Ohm						
Part No. <a href="#">PE33117</a>	Cable Dia.			Attn. @ 1 GHz	Power @ 1 GHz	
1 piece price shown. See web or call for volume pricing.	0.195" dia.			14.7 dB/100ft	600 W	
6"	12"	18"	24"	36"	48"	Custom Len.
\$65.14	\$69.06	\$68.97	\$77.18	\$85.31	\$93.92	See Web
PE-P195 Coax, 50 Ohm						
Part No. <a href="#">PE34178</a>	Cable Dia.			Attn. @ 1 GHz	Power @ 1 GHz	
1 piece price shown. See web or call for volume pricing.	0.195" dia.			12.5 dB/100ft	650 W	
6"	12"	18"	24"	36"	48"	Custom Len.
\$69.43	\$74.54	\$73.87	\$78.74	\$88.48	\$98.21	See Web
Standard Semi-Rigid Cable Assemblies						
PE-047SR Coax, 50 Ohm						
Part No. <a href="#">PE34148</a>	Cable Dia.			Attn. @ 1 GHz	Power @ 1 GHz	
1 piece price shown. See web or call for volume pricing.	0.047" dia.			40 dB/100ft	32 W	
6"	12"	18"	24"	36"	48"	Custom Len.
\$104.08	\$108.05	\$113.45	\$118.77	\$129.59	\$140.32	See Web
PE-SR047AL Coax, 50 Ohm						
Part No. <a href="#">PE34151</a>	Cable Dia.			Attn. @ 1 GHz	Power @ 1 GHz	
1 piece price shown. See web or call for volume pricing.	0.047" dia.			41 dB/100ft	32 W	
6"	12"	18"	24"	36"	48"	Custom Len.
\$103.50	\$106.82	\$111.55	\$116.38	\$125.88	\$135.44	See Web
PE-SR402AL Coax, 50 Ohm						
Part No. <a href="#">PE34143</a>	Cable Dia.			Attn. @ 1 GHz	Power @ 1 GHz	
1 piece price shown. See web or call for volume pricing.	0.141" dia.			13 dB/100ft	450 W	
6"	12"	18"	24"	36"	48"	Custom Len.
\$86.70	\$92.12	\$97.72	\$103.33	\$107.61	\$124.59	See Web
PE-SR405AL Coax, 50 Ohm						
Part No. <a href="#">PE34155</a>	Cable Dia.			Attn. @ 1 GHz	Power @ 1 GHz	
1 piece price shown. See web or call for volume pricing.	23 dB/100ft			130 W		
6"	12"	18"	24"	36"	48"	Custom Len.
\$86.01	\$86.01	\$90.77	\$95.51	\$113.92	\$112.92	See Web
RG401/U Coax, 50 Ohm						
Part No. <a href="#">PE34157</a>	Cable Dia.			Attn. @ 1 GHz	Power @ 1 GHz	
1 piece price shown. See web or call for volume pricing.	7.5 dB/100ft			870 W		
6"	12"	18"	24"	36"	48"	Custom Len.
\$131.21	\$131.21	\$143.12	\$155.02	\$178.80	\$202.59	See Web
RG402/U Coax, 50 Ohm						
Part No. <a href="#">PE3769</a>	Cable Dia.			Attn. @ 1 GHz	Power @ 1 GHz	
1 piece price shown. See web or call for volume pricing.	12 dB/100ft			650 W		
6"	12"	18"	24"	36"	48"	Custom Len.
\$84.54	\$89.60	\$88.54	\$92.56	\$100.59	\$107.11	See Web
RG405/U Coax, 50 Ohm						
Part No. <a href="#">PE3367</a>	Cable Dia.			Attn. @ 1 GHz	Power @ 1 GHz	
1 piece price shown. See web or call for volume pricing.	22 dB/100ft			130 W		
6"	12"	18"	24"	36"	48"	Custom Len.
\$75.58	\$79.28	\$82.91	\$86.53	\$93.86	\$101.18	See Web

Cable Assemblies

See Our Website For Current Pricing & Real-Time Stock Availability!

For Custom Lengths, Metric Lengths or Special Configurations, Please call (949) 261-1920



Technical Support  
+1 (949) 261-1920



Same-Day Shipping,  
Even Custom Cable Assemblies



# For our complete selection of cable assemblies, please visit our website

Cable Assemblies

See Our Website For Current Pricing & Real-Time Stock Availability!

PE-SR401AL-STRAIGHT Coax, 50 Ohm						
Part No. <a href="#">PE34159</a>	Cable Dia.			Attn. @ 1 GHz	Power @ 1 GHz	
1 piece price shown. See web or call for volume pricing.	0.25" dia.			8 dB/100ft	1,400 W	21
6"	12"	18"	24"	36"	48"	Custom Len.
\$110.26	\$119.83	\$129.32	\$138.89	\$157.97	\$177.02	See Web

Standard Flexible Cable Assemblies						
RG55B/U Coax, 53 Ohm						
Part No. <a href="#">PE34169</a>	Cable Dia.			Attn. @ 1 GHz	Power @ 1 GHz	
1 piece price shown. See web or call for volume pricing.	0.202" dia.			16.5 dB/100ft	53 W	22
6"	12"	18"	24"	36"	48"	Custom Len.
\$53.99	\$53.99	\$54.74	\$55.96	\$58.42	\$60.88	See Web

## SMA MALE TO QMA MALE



Low Loss Flexible Cable Assemblies						
PE-C195 Coax, 50 Ohm						
Part No. <a href="#">PE38116</a>	Cable Dia.			Attn. @ 1 GHz	Power @ 1 GHz	
1 piece price shown. See web or call for volume pricing.	0.195" dia.			11.3 dB/100ft	150 W	23
12"	24"	36"	48"	60"	72"	Custom Len.
\$49.60	\$54.43	\$51.17	\$51.98	\$52.76	\$53.56	See Web

Standard Flexible Cable Assemblies						
RG58C/U Coax, 50 Ohm						
Part No. <a href="#">PE38275</a>	Cable Dia.			Attn. @ 1 GHz	Power @ 1 GHz	
1 piece price shown. See web or call for volume pricing.	0.195" dia.			20 dB/100ft	44 W	24
12"	24"	36"	48"	60"	72"	Custom Len.
\$59.65	\$56.04	\$56.86	\$57.67	\$58.48	\$59.29	See Web

Standard Flexible Cable Assemblies						
RG316/U Coax, 50 Ohm						
Part No. <a href="#">PE38273</a>	Cable Dia.			Attn. @ 1 GHz	Power @ 1 GHz	
1 piece price shown. See web or call for volume pricing.	0.098" dia.			38 dB/100ft	160 W	25
12"	24"	36"	48"	60"	72"	Custom Len.
\$59.07	\$62.23	\$65.42	\$73.12	\$71.77	\$74.95	See Web

Standard Flexible Cable Assemblies						
RG316-DS Coax, 50 Ohm						
Part No. <a href="#">PE38274</a>	Cable Dia.			Attn. @ 1 GHz	Power @ 1 GHz	
1 piece price shown. See web or call for volume pricing.	0.114" dia.			30 dB/100ft	160 W	26
12"	24"	36"	48"	60"	72"	Custom Len.
\$79.36	\$78.08	\$81.27	\$84.48	\$87.68	\$90.88	See Web

## SMA MALE TO SMA MALE



Flexible Cable Assemblies						
LMR-100A-PVC Coax, 50 Ohm						
Part No. <a href="#">PE3C0113</a>	Cable Dia.			Attn. @ 1 GHz	Power @ 1 GHz	
1 piece price shown. See web or call for volume pricing.	0.11" dia.			24 dB/100ft	-	27
12"	24"	36"	48"	60"	-	Custom Len.
\$48.75	\$49.59	\$50.43	\$51.32	\$52.17	-	See Web

Flexible Cable Assemblies						
LMR-195 Coax, 50 Ohm						
Part No. <a href="#">PE3C0038</a>	Cable Dia.			Attn. @ 1 GHz	Power @ 1 GHz	
1 piece price shown. See web or call for volume pricing.	0.195" dia.			11.8 dB/100ft	-	28
12"	24"	36"	48"	60"	-	Custom Len.
\$40.01	\$40.85	\$41.68	\$42.56	\$43.40	-	See Web

Flexible Cable Assemblies						
LMR-240-DB Coax, 50 Ohm						
Part No. <a href="#">PE3C3055</a>	Cable Dia.			Attn. @ 1 GHz	Power @ 1 GHz	
1 piece price shown. See web or call for volume pricing.	0.195" dia.			11.8 dB/100ft	-	29
12"	24"	36"	48"	60"	-	Custom Len.
Call	Call	Call	Call	Call	-	See Web

Flexible Cable Assemblies						
PE-P160LL Coax, 50 Ohm						
Part No. <a href="#">PE3C5241</a>	Cable Dia.			Attn. @ 1 GHz	Power @ 1 GHz	
1 piece price shown. See web or call for volume pricing.	0.16" dia.			11 dB/100ft	560 W	30
12"	24"	36"	48"	60"	50CM	Custom Len.
\$222.74	\$245.21	\$267.66	\$290.11	\$312.56	\$237.13	See Web

Semi-Rigid Cable Assemblies						
PE-SR402AL Coax, 50 Ohm						
Part No. <a href="#">PE3C1398</a>	Cable Dia.			Attn. @ 1 GHz	Power @ 1 GHz	
1 piece price shown. See web or call for volume pricing.	0.141" dia.			13 dB/100ft	450 W	31
12"	24"	36"	48"	60"	50CM	Custom Len.
\$54.13	\$64.66	\$70.18	\$81.21	\$92.25	\$55.19	See Web

Corrugated Cable Assemblies						
SPP-250-LLPL Coax, 50 Ohm						
Part No. <a href="#">PE3C5888</a>	Cable Dia.			Attn. @ 1 GHz	Power @ 1 GHz	
1 piece price shown. See web or call for volume pricing.	0.28" dia.			5.5 dB/100ft	650 W	32
12"	24"	36"	48"	60"	50CM	Custom Len.
\$63.07	\$69.20	\$75.33	\$81.47	\$87.60	\$67.00	See Web

Low Loss Flexible Cable Assemblies						
PE-C100-LSZH Coax, 50 Ohm						
Part No. <a href="#">PE37908</a>	Cable Dia.			Attn. @ 1 GHz	Power @ 1 GHz	
1 piece price shown. See web or call for volume pricing.	0.109" dia.			25 dB/100ft	-	33
12"	24"	36"	48"	60"	-	Custom Len.
\$53.95	\$54.90	\$56.37	\$57.91	\$59.40	-	See Web

PE-C195 Coax, 50 Ohm						
Part No. <a href="#">PE35784</a>	Cable Dia.			Attn. @ 1 GHz	Power @ 1 GHz	
1 piece price shown. See web or call for volume pricing.	0.195" dia.			11.3 dB/100ft	150 W	34
12"	24"	36"	48"	60"	-	Custom Len.
\$43.88	\$44.75	\$45.61	\$46.53	\$47.41	-	See Web

PE-C240 Coax, 50 Ohm						
Part No. <a href="#">PE38628</a>	Cable Dia.			Attn. @ 1 GHz	Power @ 1 GHz	
1 piece price shown. See web or call for volume pricing.	0.24" dia.			9.2 dB/100ft	250 W	35
12"	24"	36"	48"	60"	-	Custom Len.
\$56.11	\$60.72	\$60.15	\$63.18	\$66.27	-	See Web

LMR-100A-PVC Coax, 50 Ohm						
Part No. <a href="#">PE3C0057</a>	Cable Dia.			Attn. @ 1 GHz	Power @ 1 GHz	
1 piece price shown. See web or call for volume pricing.	0.11" dia.			24 dB/100ft	-	36
12"	24"	36"	48"	60"	-	Custom Len.
\$52.72	\$53.56	\$54.41	\$54.78	\$55.65	-	See Web

LMR-240 Coax, 50 Ohm						
Part No. <a href="#">PE3C0052</a>	Cable Dia.			Attn. @ 1 GHz	Power @ 1 GHz	
1 piece price shown. See web or call for volume pricing.	0.24" dia.			8 dB/100ft	-	37
12"	24"	36"	48"	60"	-	Custom Len.
\$55.58	\$56.64	\$57.72	\$58.85	\$59.96	-	See Web

LMR-400-DB Coax, 50 Ohm						
Part No. <a href="#">PE3C0103</a>	Cable Dia.			Attn. @ 1 GHz	Power @ 1 GHz	
1 piece price shown. See web or call for volume pricing.	0.24" dia.			8 dB/100ft	-	38
12"	24"	36"	48"	60"	-	Custom Len.
\$42.40	\$43.47	\$44.56	\$45.71	\$46.79	-	See Web

LMR-400-DB Coax, 50 Ohm						
Part No. <a href="#">PE3W01582</a>	Cable Dia.			Attn. @ 1 GHz	Power @ 1 GHz	
1 piece price shown. See web or call for volume pricing.	0.405" dia.			4.15 dB/100ft	-	39
12"	24"	36"	48"	60"	50CM	Custom Len.
\$77.93	\$79.50	\$81.09	\$82.67	\$84.26	\$78.94	See Web

PE-P142LL Coax, 50 Ohm						
Part No. <a href="#">PE3C0230</a>	Cable Dia.			Attn. @ 1 GHz	Power @ 1 GHz	
1 piece price shown. See web or call for volume pricing.	0.32" dia.			7.2 dB/100ft	-	40
12"	24"	36"	48"	60"	72"	Custom Len.
\$286.87	\$306.78	\$352.75	\$387.74	\$481.38	\$493.83	See Web

PE-P142LL-27478 Coax, 50 Ohm						
Part No. <a href="#">PE3M0125</a>	Cable Dia.			Attn. @ 1 GHz	Power @ 1 GHz	
1 piece price shown. See web or call for volume pricing.	0.195" dia.			-	-	41
12"	18"	24"	36"	48"	60"	Custom Len.
\$377.08	\$386.27	\$395.46	\$413.85	\$432.22	\$450.62	See Web

PE-P160LL-27478 Coax, 50 Ohm						
Part No. <a href="#">PE3M0180</a>	Cable Dia.			Attn. @ 1 GHz	Power @ 1 GHz	
1 piece price shown. See web or call for volume pricing.	0.16" dia.			-	-	42
8"	12"	18"	24"	30"	36"	Custom Len.
\$369.32	\$374.62	\$382.61	\$390.56	\$398.54	\$406.49	See Web

PE-P300LL-27478 Coax, 50 Ohm						
Part No. <a href="#">PE3M0225</a>	Cable Dia.			Attn. @ 1 GHz	Power @ 1 GHz	
1 piece price shown. See web or call for volume pricing.	0.3" dia.			-	-	43
12"	18"	24"	36"	48"	60"	Custom Len.
\$425.86	\$441.19	\$456.54	\$487.22	\$517.90	\$548.59	See Web

LMR-240-DB Coax, 50 Ohm						
Part No. <a href="#">PE3W03353</a>	Cable Dia.			Attn. @ 1 GHz	Power @ 1 GHz	
1 piece price shown. See web or call for volume pricing.	0.24" dia.			7.66 dB/100ft	-	44
12"	24"	36"	48"	60"	50CM	Custom Len.
\$56.66	\$57.89	\$59.10	\$60.31	\$61.53	\$57.45	See Web

## Precision Formable Cable Assemblies

PE-80TEST Coax, 50 Ohm						
Part No. <a href="#">PE3TC0101</a>	Cable Dia.			Attn. @ 1 GHz	Power @ 1 GHz	
1 piece price shown. See web or call for volume pricing.	0.195" dia.			-	-	45
24"	48"	60"	72"	30CM	-	Custom Len.
\$339.94	\$432.90	Call	\$525.87	Call	-	See Web

PE-80TEST Coax, 50 Ohm						
Part No. <a href="#">PE3TC0201</a>	Cable Dia.			Attn. @ 1 GHz	Power @ 1 GHz	
1 piece price shown. See web or call for volume pricing.	0.195" dia.			-	-	46
24"	48"	72"	120"	-	-	Custom Len.
\$492.52	\$585.49	\$678.45	Call	-	-	See Web

PE-90TEST Coax, 50 Ohm						
Part No. <a href="#">PE3TC0301</a>	Cable Dia.			Attn. @ 1 GHz	Power @ 1 GHz	
1 piece price shown. See web or call for volume pricing.	0.151" dia.			-	-	47
24"	48"	72"	-	-	-	Custom Len.
\$250.04	\$355.66	\$440.17	-	-	-	See Web

PE-90TEST Coax, 50 Ohm						
Part No. <a href="#">PE3TC0401</a>	Cable Dia.			Attn. @ 1 GHz	Power @ 1 GHz	
1 piece price shown. See web or call for volume pricing.	0.151" dia.			-	-	48
24"	30"	48"	72"	250CM	393.701//	Custom Len.
\$423.75	Call	\$508.25	\$592.76	Call	Call	See Web

## Precision Flexible Cable Assemblies

PE-P141 Coax, 50 Ohm						
Part No. <a href="#">PE312</a>	Cable Dia.			Attn. @ 1 GHz	Power @ 1 GHz	
1 piece price shown. See web or call for volume pricing.	0.163" dia.			-	-	49
30CM	24"	36"	48"	72"	-	Custom Len.
Call	\$177.58	\$176.25	\$160.15	\$178.95	\$177.67	See Web

PE-P141 Coax, 50 Ohm						
Part No. <a href="#">PE3CA1130</a>	Cable Dia.			Attn. @ 1 GHz	Power @ 1 GHz	
1 piece price shown. See web or call for volume pricing.	0.163" dia.			-	-	50
12"	18"	24"	36"	48"	60"	Custom Len.
\$138.43	Call	\$144.50	\$155.77	\$154.06	\$178.31	See Web

\*Coax Performance at 1 GHz Notes: Cable assembly max frequency may be lower than connector or coax max frequency

For our complete selection of cable assemblies, please visit our website

Low PIM Formable Cable Assemblies						
PE-SR402FLJ Low PIM Coax, 50 Ohm						
Part No.	PE3C2008			Cable Dia.	Attn. @ 1 GHz	Power @ 1 GHz
1 piece price shown. See web or call for volume pricing.						
12"	30"	40"	60"	70"	75"	Custom Len.
Call	Call	Call	Call	Call	Call	See Web
Low PIM Corrugated Cable Assemblies						
PE-1/4SFHC Coax, 50 Ohm						
Part No.	PE3C7863			Cable Dia.	Attn. @ 1 GHz	Power @ 1 GHz
1 piece price shown. See web or call for volume pricing.						
12"	24"	36"	48"	60"	50CM	Custom Len.
\$48.66	\$52.43	\$55.68	\$59.40	\$63.13	\$51.07	See Web
SPP-250-LLPL Coax, 50 Ohm						
Part No.	PE3C6207			Cable Dia.	Attn. @ 1 GHz	Power @ 1 GHz
1 piece price shown. See web or call for volume pricing.						
12"	24"	36"	48"	60"	50CM	Custom Len.
\$47.54	\$53.73	\$59.37	\$65.51	\$71.64	\$51.49	See Web
Test Flexible Cable Assemblies						
PE-P160 Coax, 50 Ohm						
Part No.	PE366			Cable Dia.	Attn. @ 1 GHz	Power @ 1 GHz
1 piece price shown. See web or call for volume pricing.						
12"	24"	36"	48"	60"	50CM	Custom Len.
Call	Call	\$353.33	\$380.59	Call	Call	See Web
Low Loss Test Flexible Cable Assemblies						
PE-P300LL Coax, 50 Ohm						
Part No.	PE333			Cable Dia.	Attn. @ 1 GHz	Power @ 1 GHz
1 piece price shown. See web or call for volume pricing.						
12"	24"	36"	48"	60"	50CM	Custom Len.
\$264.57	\$292.69	\$320.81	\$348.94	\$377.07	\$282.60	See Web
Part No.	PE336			Cable Dia.	Attn. @ 1 GHz	Power @ 1 GHz
1 piece price shown. See web or call for volume pricing.						
12"	24"	36"	48"	60"	72"	Custom Len.
\$255.60	\$283.73	\$311.85	\$345.81	\$368.09	\$408.73	See Web
Part No.	PE3C3235			Cable Dia.	Attn. @ 1 GHz	Power @ 1 GHz
1 piece price shown. See web or call for volume pricing.						
12"	24"	36"	48"	60"	50CM	Custom Len.
\$166.70	\$194.02	\$221.30	\$248.61	\$275.91	\$184.21	See Web
PE-P142LL Coax, 50 Ohm						
Part No.	PE341			Cable Dia.	Attn. @ 1 GHz	Power @ 1 GHz
1 piece price shown. See web or call for volume pricing.						
12"	24"	36"	48"	60"	46CM	Custom Len.
\$121.36	\$138.97	\$156.56	\$174.18	\$191.78	Call	See Web
Standard Formable Cable Assemblies						
PE-SR407FL Coax, 50 Ohm						
Part No.	PE34186			Cable Dia.	Attn. @ 1 GHz	Power @ 1 GHz
1 piece price shown. See web or call for volume pricing.						
6"	12"	18"	24"	36"	48"	Custom Len.
\$97.00	\$101.33	\$105.80	\$103.70	\$110.26	\$118.25	See Web
PE-SR401FL Coax, 50 Ohm						
Part No.	PE34188			Cable Dia.	Attn. @ 1 GHz	Power @ 1 GHz
1 piece price shown. See web or call for volume pricing.						
6"	12"	18"	24"	36"	48"	Custom Len.
\$131.51	\$140.11	\$148.97	\$157.81	\$192.43	\$209.14	See Web
PE-SR402FL Coax, 50 Ohm						
Part No.	PE3481			Cable Dia.	Attn. @ 1 GHz	Power @ 1 GHz
1 piece price shown. See web or call for volume pricing.						
6"	12"	18"	24"	36"	48"	Custom Len.
\$48.32	\$52.68	\$56.64	\$61.07	\$69.97	\$79.36	See Web
Part No.	PE39423			Cable Dia.	Attn. @ 1 GHz	Power @ 1 GHz
1 piece price shown. See web or call for volume pricing.						
3"	6"	9"	12"	18"	24"	Custom Len.
\$51.57	\$50.60	\$48.42	\$50.60	\$56.51	\$62.88	See Web
PE-SR402FLJ Coax, 50 Ohm						
Part No.	PE39437			Cable Dia.	Attn. @ 1 GHz	Power @ 1 GHz
1 piece price shown. See web or call for volume pricing.						
6"	9"	12"	18"	24"	-	Custom Len.
\$63.50	\$61.28	\$63.50	\$68.44	\$73.37	-	See Web
PE-SR405FL Coax, 50 Ohm						
Part No.	PE3867			Cable Dia.	Attn. @ 1 GHz	Power @ 1 GHz
1 piece price shown. See web or call for volume pricing.						
6"	12"	18"	24"	36"	48"	Custom Len.
\$55.53	\$61.58	\$67.83	\$74.06	\$81.61	\$93.37	See Web
Part No.	PE39415			Cable Dia.	Attn. @ 1 GHz	Power @ 1 GHz
1 piece price shown. See web or call for volume pricing.						
6"	9"	12"	18"	24"	-	Custom Len.
\$55.02	\$53.44	\$55.02	\$61.15	\$67.29	-	See Web
PE-SR405FLJ Coax, 50 Ohm						
Part No.	PE39429			Cable Dia.	Attn. @ 1 GHz	Power @ 1 GHz
1 piece price shown. See web or call for volume pricing.						
6"	9"	12"	18"	24"	-	Custom Len.
\$54.97	\$54.97	\$54.97	\$59.90	\$64.84	-	See Web

Standard Flexible Cable Assemblies						
RG8X Coax, 50 Ohm						
Part No.	PE39087			Cable Dia.	Attn. @ 1 GHz	Power @ 1 GHz
1 piece price shown. See web or call for volume pricing.						
12"	24"	36"	48"	60"	-	Custom Len.
\$70.06	\$73.43	\$82.04	\$86.15	\$90.11	-	See Web
RG58C/U Coax, 50 Ohm						
Part No.	PE3369			Cable Dia.	Attn. @ 1 GHz	Power @ 1 GHz
1 piece price shown. See web or call for volume pricing.						
6"	12"	18"	24"	36"	48"	Custom Len.
\$47.75	\$50.62	\$48.17	\$48.56	\$49.39	\$50.21	See Web
Part No.	PE36689			Cable Dia.	Attn. @ 1 GHz	Power @ 1 GHz
1 piece price shown. See web or call for volume pricing.						
24"	36"	48"	72"	-	-	Custom Len.
\$122.16	\$115.96	\$123.97	-	-	-	See Web
Part No.	PE36690			Cable Dia.	Attn. @ 1 GHz	Power @ 1 GHz
1 piece price shown. See web or call for volume pricing.						
24"	36"	48"	72"	-	-	Custom Len.
\$146.02	\$146.94	\$147.88	\$149.74	-	-	See Web
RG142B/U Coax, 50 Ohm						
Part No.	PE3385			Cable Dia.	Attn. @ 1 GHz	Power @ 1 GHz
1 piece price shown. See web or call for volume pricing.						
6"	12"	24"	36"	48"	60 W	Custom Len.
\$54.63	\$57.88	\$61.22	\$64.56	\$71.24	\$78.32	See Web
RG174A/U Coax, 50 Ohm						
Part No.	PE3353			Cable Dia.	Attn. @ 1 GHz	Power @ 1 GHz
1 piece price shown. See web or call for volume pricing.						
6"	12"	18"	24"	36"	48"	Custom Len.
\$54.06	\$54.37	\$54.19	\$54.51	\$55.14	\$55.82	See Web
Part No.	PE3W00365			Cable Dia.	Attn. @ 1 GHz	Power @ 1 GHz
1 piece price shown. See web or call for volume pricing.						
12"	24"	36"	48"	60"	50CM	Custom Len.
\$69.16	\$69.77	\$70.39	\$71.00	\$67.69	\$65.61	See Web
RG178B/U Coax, 50 Ohm						
Part No.	PE3574			Cable Dia.	Attn. @ 1 GHz	Power @ 1 GHz
1 piece price shown. See web or call for volume pricing.						
6"	12"	24"	36"	48"	78 W	Custom Len.
\$71.99	\$72.55	\$73.13	\$73.71	\$74.88	\$76.11	See Web
RG188A/U Coax, 50 Ohm						
Part No.	PE3361			Cable Dia.	Attn. @ 1 GHz	Power @ 1 GHz
1 piece price shown. See web or call for volume pricing.						
6"	12"	18"	24"	36"	48"	Custom Len.
\$54.32	\$55.66	\$57.03	\$58.39	\$61.14	\$64.04	See Web
RG188-DS Coax, 50 Ohm						
Part No.	PE3778			Cable Dia.	Attn. @ 1 GHz	Power @ 1 GHz
1 piece price shown. See web or call for volume pricing.						
12"	24"	36"	48"	60"	-	Custom Len.
\$59.80	\$60.16	\$67.56	\$67.65	\$75.59	-	See Web
RG213/U Coax, 50 Ohm						
Part No.	PE35571			Cable Dia.	Attn. @ 1 GHz	Power @ 1 GHz
1 piece price shown. See web or call for volume pricing.						
12"	24"	36"	48"	60"	-	Custom Len.
\$184.37	\$186.00	\$187.56	\$189.18	\$190.82	-	See Web
RG214/U Coax, 50 Ohm						
Part No.	PE3121			Cable Dia.	Attn. @ 1 GHz	Power @ 1 GHz
1 piece price shown. See web or call for volume pricing.						
6"	12"	24"	36"	48"	170 W	Custom Len.
\$214.27	\$214.27	\$218.24	\$222.21	\$230.16	\$238.10	See Web
RG223/U Coax, 50 Ohm						
Part No.	PE3377			Cable Dia.	Attn. @ 1 GHz	Power @ 1 GHz
1 piece price shown. See web or call for volume pricing.						
6"	12"	18"	24"	36"	48"	Custom Len.
\$42.77	\$42.77	\$44.37	\$45.97	\$49.19	\$52.40	See Web
Part No.	PE3W02458			Cable Dia.	Attn. @ 1 GHz	Power @ 1 GHz
1 piece price shown. See web or call for volume pricing.						
12"	24"	36"	48"	60"	50CM	Custom Len.
\$65.25	\$80.72	\$84.28	\$87.84	\$91.41	\$79.43	See Web
RG316/U Coax, 50 Ohm						
Part No.	PE3573			Cable Dia.	Attn. @ 1 GHz	Power @ 1 GHz
1 piece price shown. See web or call for volume pricing.						
6"	12"	18"	24"	36"	48"	Custom Len.
\$54.43	\$55.60	\$57.32	\$59.04	\$62.47	\$66.11	See Web
RG316-DS Coax, 50 Ohm						
Part No.	PE3704			Cable Dia.	Attn. @ 1 GHz	Power @ 1 GHz
1 piece price shown. See web or call for volume pricing.						
12"	48CM	53CM	24"	36"	104CM	Custom Len.
\$54.35	Call	Call	\$57.77	\$61.22	Call	See Web
RG400/U Coax, 50 Ohm						
Part No.	PE3500			Cable Dia.	Attn. @ 1 GHz	Power @ 1 GHz
1 piece price shown. See web or call for volume pricing.						
6"	12"	18"	24"	36"	48"	Custom Len.
\$56.89	\$60.83	\$64.90	\$68.95	\$77.10	\$85.70	See Web

Cable Assemblies

See Our Website For Current Pricing & Real-Time Stock Availability!

For Custom Lengths, Metric Lengths or Special Configurations, Please call (949) 261-1920



Technical Support  
+1 (949) 261-1920



Same-Day Shipping,  
Even Custom Cable Assemblies

# For our complete selection of cable assemblies, please visit our website

Cable Assemblies  
See Our Website For Current Pricing & Real-Time Stock Availability!

PE-P086EAM Coax, 50 Ohm						
Part No. <a href="#">PE3CA1039</a>	Cable Dia.	Attn. @ 1 GHz	Power @ 1 GHz			
1 piece price shown. See web or call for volume pricing.						
7"	8"	9"	12"	14"	16"	Custom Len.
\$62.61	Call	Call	\$63.75	Call	Call	See Web
PE-P141 Coax, 50 Ohm						
Part No. <a href="#">PE300</a>	Cable Dia.	Attn. @ 1 GHz	Power @ 1 GHz			
1 piece price shown. See web or call for volume pricing.						
12"	24"	36"	48"	60"	72"	Custom Len.
\$124.57	\$138.94	\$153.32	\$167.70	\$182.08	\$196.45	See Web
Part No. <a href="#">PE350</a>	Cable Dia.	Attn. @ 1 GHz	Power @ 1 GHz			
1 piece price shown. See web or call for volume pricing.						
12"	24"	36"	48"	60"	72"	Custom Len.
\$99.66	\$109.53	\$125.83	\$138.87	\$143.33	\$163.97	See Web
PE-P195 Coax, 50 Ohm						
Part No. <a href="#">PE3138</a>	Cable Dia.	Attn. @ 1 GHz	Power @ 1 GHz			
1 piece price shown. See web or call for volume pricing.						
6"	12"	18"	24"	36"	48"	Custom Len.
\$64.58	\$64.58	\$70.32	\$76.05	\$87.51	\$98.95	See Web
LMR-195 Coax, 50 Ohm						
Part No. <a href="#">PE3C0116</a>	Cable Dia.	Attn. @ 1 GHz	Power @ 1 GHz			
1 piece price shown. See web or call for volume pricing.						
12"	24"	36"	48"	60"	-	Custom Len.
Call	Call	Call	Call	Call	-	See Web
PE-P141FLX Coax, 50 Ohm						
Part No. <a href="#">PE3CA1035</a>	Cable Dia.	Attn. @ 1 GHz	Power @ 1 GHz			
1 piece price shown. See web or call for volume pricing.						
13CM	12"	24"	36"	48"	72"	Custom Len.
Call	\$77.56	\$98.57	\$110.41	Call	Call	See Web
PE-P103 Coax, 50 Ohm						
Part No. <a href="#">PE3C6631</a>	Cable Dia.	Attn. @ 1 GHz	Power @ 1 GHz			
1 piece price shown. See web or call for volume pricing.						
12"	24"	36"	48"	60"	50CM	Custom Len.
\$215.20	\$243.30	\$266.88	\$295.10	\$323.32	\$228.51	See Web
PE-VNA-R Coax, 50 Ohm						
Part No. <a href="#">PE3VNA1801</a>	Cable Dia.	Attn. @ 1 GHz	Power @ 1 GHz			
1 piece price shown. See web or call for volume pricing.						
24"	48"	96"	240"	400"	-	Custom Len.
\$842.31	\$939.16	Call	\$1,771.71	Call	-	See Web
M17/60-RG142-27478 Coax, 50 Ohm						
Part No. <a href="#">PE3M0023</a>	Cable Dia.	Attn. @ 1 GHz	Power @ 1 GHz			
1 piece price shown. See web or call for volume pricing.						
12"	18"	24"	30"	36"	48"	Custom Len.
\$237.03	\$239.98	\$242.94	\$245.89	\$248.86	\$254.76	See Web
M17/84-RG223-0XDS2 Coax, 50 Ohm						
Part No. <a href="#">PE3M0051</a>	Cable Dia.	Attn. @ 1 GHz	Power @ 1 GHz			
1 piece price shown. See web or call for volume pricing.						
12"	18"	24"	30"	36"	48"	Custom Len.
\$241.70	\$246.98	\$252.26	\$257.55	\$262.85	\$273.42	See Web
M17/128-RG400-27478 Coax, 50 Ohm						
Part No. <a href="#">PE3M0079</a>	Cable Dia.	Attn. @ 1 GHz	Power @ 1 GHz			
1 piece price shown. See web or call for volume pricing.						
12"	18"	24"	30"	36"	48"	Custom Len.
\$238.64	\$242.40	\$246.16	\$249.92	\$253.69	\$261.21	See Web
M17/113-RG316-27478 Coax, 50 Ohm						
Part No. <a href="#">PE3M0090</a>	Cable Dia.	Attn. @ 1 GHz	Power @ 1 GHz			
1 piece price shown. See web or call for volume pricing.						
6"	8"	12"	16"	18"	24"	Custom Len.
\$187.75	\$188.11	\$188.84	\$189.55	\$189.94	\$191.01	See Web
M17/119-RG174-0XDS2 Coax, 50 Ohm						
Part No. <a href="#">PE3M0105</a>	Cable Dia.	Attn. @ 1 GHz	Power @ 1 GHz			
1 piece price shown. See web or call for volume pricing.						
6"	8"	12"	16"	18"	24"	Custom Len.
\$187.09	\$187.22	\$187.51	\$187.79	\$187.95	\$188.35	See Web
M17/28-RG058-0XDS2 Coax, 50 Ohm						
Part No. <a href="#">PE3M0119</a>	Cable Dia.	Attn. @ 1 GHz	Power @ 1 GHz			
1 piece price shown. See web or call for volume pricing.						
12"	18"	24"	30"	36"	48"	Custom Len.
\$350.33	\$350.97	\$351.61	\$352.26	\$352.91	\$354.21	See Web
RG55B/U Coax, 53 Ohm						
Part No. <a href="#">PE3572</a>	Cable Dia.	Attn. @ 1 GHz	Power @ 1 GHz			
1 piece price shown. See web or call for volume pricing.						
6"	12"	18"	24"	36"	48"	Custom Len.
\$46.83	\$49.65	\$48.08	\$52.53	\$51.82	\$54.31	See Web
RG59B/U Coax, 75 Ohm						
Part No. <a href="#">PE3814</a>	Cable Dia.	Attn. @ 1 GHz	Power @ 1 GHz			
1 piece price shown. See web or call for volume pricing.						
6"	12"	18"	24"	36"	48"	Custom Len.
\$73.95	\$78.39	\$74.47	\$75.01	\$76.07	\$77.13	See Web
RG179B/U Coax, 75 Ohm						
Part No. <a href="#">PE3739</a>	Cable Dia.	Attn. @ 1 GHz	Power @ 1 GHz			
1 piece price shown. See web or call for volume pricing.						
6"	12"	18"	24"	36"	48"	Custom Len.
\$51.90	\$53.26	\$54.19	\$55.60	\$58.40	\$57.60	See Web

RG187A/U Coax, 75 Ohm						
Part No. <a href="#">PE38059</a>	Cable Dia.	Attn. @ 1 GHz	Power @ 1 GHz			
1 piece price shown. See web or call for volume pricing.						
12"	24"	36"	48"	60"	-	Custom Len.
\$53.77	\$60.67	\$60.21	\$63.64	\$67.06	-	See Web
RG62A/U Coax, 93 Ohm						
Part No. <a href="#">PE3899</a>	Cable Dia.	Attn. @ 1 GHz	Power @ 1 GHz			
1 piece price shown. See web or call for volume pricing.						
6"	12"	18"	24"	36"	48"	Custom Len.
\$74.46	\$74.46	\$75.23	\$75.97	\$77.47	\$79.00	See Web
RG180B/U Coax, 95 Ohm						
Part No. <a href="#">PE3245</a>	Cable Dia.	Attn. @ 1 GHz	Power @ 1 GHz			
1 piece price shown. See web or call for volume pricing.						
12"	24"	36"	48"	60"	-	Custom Len.
\$69.97	\$70.40	\$74.78	\$84.49	\$89.34	-	See Web
Standard Semi-Rigid Cable Assemblies						
PE-020SR Coax, 50 Ohm						
Part No. <a href="#">PE34191</a>	Cable Dia.	Attn. @ 1 GHz	Power @ 1 GHz			
1 piece price shown. See web or call for volume pricing.						
6"	12"	18"	24"	36"	48"	Custom Len.
\$145.76	\$155.98	\$166.52	\$177.04	\$186.51	\$206.18	See Web
PE-034SR Coax, 50 Ohm						
Part No. <a href="#">PE34193</a>	Cable Dia.	Attn. @ 1 GHz	Power @ 1 GHz			
1 piece price shown. See web or call for volume pricing.						
6"	12"	18"	24"	36"	48"	Custom Len.
\$150.27	\$147.87	\$154.50	\$170.07	\$183.41	\$187.83	See Web
PE-047SR Coax, 50 Ohm						
Part No. <a href="#">PE3656</a>	Cable Dia.	Attn. @ 1 GHz	Power @ 1 GHz			
1 piece price shown. See web or call for volume pricing.						
6"	12"	18"	24"	36"	48"	Custom Len.
\$96.46	\$102.84	\$107.88	\$114.34	\$119.17	\$140.98	See Web
PE-SR047AL Coax, 50 Ohm						
Part No. <a href="#">PE3387</a>	Cable Dia.	Attn. @ 1 GHz	Power @ 1 GHz			
1 piece price shown. See web or call for volume pricing.						
6"	12"	18"	24"	36"	48"	Custom Len.
\$97.96	\$103.39	\$102.52	\$107.53	\$124.01	\$125.71	See Web
PE-SR402AL Coax, 50 Ohm						
Part No. <a href="#">PE34180</a>	Cable Dia.	Attn. @ 1 GHz	Power @ 1 GHz			
1 piece price shown. See web or call for volume pricing.						
6"	12"	18"	24"	36"	48"	Custom Len.
\$56.27	\$61.72	\$67.30	\$72.89	\$84.08	\$95.92	See Web
PE-SR402TN Coax, 50 Ohm						
Part No. <a href="#">PE3C1015</a>	Cable Dia.	Attn. @ 1 GHz	Power @ 1 GHz			
1 piece price shown. See web or call for volume pricing.						
12"	24"	36"	48"	60"	72"	Custom Len.
\$54.97	\$62.61	\$62.62	\$68.49	\$74.35	\$80.21	See Web
PE-SR405AL Coax, 50 Ohm						
Part No. <a href="#">PE34182</a>	Cable Dia.	Attn. @ 1 GHz	Power @ 1 GHz			
1 piece price shown. See web or call for volume pricing.						
6"	12"	18"	24"	36"	48"	Custom Len.
\$53.35	\$57.94	\$63.17	\$68.39	\$78.86	\$84.22	See Web
RG401/U Coax, 50 Ohm						
Part No. <a href="#">PE33003</a>	Cable Dia.	Attn. @ 1 GHz	Power @ 1 GHz			
1 piece price shown. See web or call for volume pricing.						
6"	12"	18"	24"	36"	48"	Custom Len.
\$145.13	\$157.07	\$169.36	\$171.97	\$206.22	\$232.23	See Web
RG402/U Coax, 50 Ohm						
Part No. <a href="#">PE3492</a>	Cable Dia.	Attn. @ 1 GHz	Power @ 1 GHz			
1 piece price shown. See web or call for volume pricing.						
6"	12"	18"	24"	36"	48"	Custom Len.
\$54.49	\$58.66	\$62.97	\$67.27	\$75.86	\$84.97	See Web
RG405/U Coax, 50 Ohm						
Part No. <a href="#">PE3818</a>	Cable Dia.	Attn. @ 1 GHz	Power @ 1 GHz			
1 piece price shown. See web or call for volume pricing.						
6"	12"	18"	24"	36"	48"	Custom Len.
\$52.43	\$55.92	\$60.00	\$64.08	\$72.26	\$80.89	See Web
PE-SR401AL-STRAIGHT Coax, 50 Ohm						
Part No. <a href="#">PE34184</a>	Cable Dia.	Attn. @ 1 GHz	Power @ 1 GHz			
1 piece price shown. See web or call for volume pricing.						
6"	12"	18"	24"	36"	48"	Custom Len.
\$143.99	\$152.63	\$153.83	\$163.66	\$183.32	\$203.00	See Web
SMA MALE TO SMA MALE RIGHT ANGLE						
Corrugated Cable Assemblies						
SPP-250-LLPL Coax, 50 Ohm						
Part No. <a href="#">PE3C5894</a>	Cable Dia.	Attn. @ 1 GHz	Power @ 1 GHz			
1 piece price shown. See web or call for volume pricing.						
12"	24"	36"	48"	60"	50CM	Custom Len.
\$64.66	\$70.80	\$109.67	\$83.07	\$89.21	\$68.60	See Web



\*Coax Performance at 1 GHz Notes: Cable assembly max frequency may be lower than connector or coax max frequency



# For our complete selection of cable assemblies, please visit our website

Low Loss Flexible Cable Assemblies						
<b>PE-C195 Coax, 50 Ohm</b>						
Part No. <b>PE36475</b>	Cable Dia.	Attn. @ 1 GHz	Power @ 1 GHz	1 piece price shown. See web or call for volume pricing.		
12"	24"	36"	48"	60"	-	Custom Len.
\$51.46	\$52.32	\$49.24	\$50.03	\$50.82	-	See Web
<b>PE-C240 Coax, 50 Ohm</b>						
Part No. <b>PE38624</b>	Cable Dia.	Attn. @ 1 GHz	Power @ 1 GHz	1 piece price shown. See web or call for volume pricing.		
12"	24"	36"	48"	60"	-	Custom Len.
\$73.15	\$74.41	\$71.28	\$74.34	\$77.44	-	See Web
<b>LMR-240 Coax, 50 Ohm</b>						
Part No. <b>PE3C0104</b>	Cable Dia.	Attn. @ 1 GHz	Power @ 1 GHz	1 piece price shown. See web or call for volume pricing.		
12"	24"	36"	48"	60"	-	Custom Len.
\$46.84	\$46.11	\$47.19	\$50.16	\$51.25	-	See Web
<b>PE-P160LL Coax, 50 Ohm</b>						
Part No. <b>PE3C5246</b>	Cable Dia.	Attn. @ 1 GHz	Power @ 1 GHz	1 piece price shown. See web or call for volume pricing.		
12"	24"	36"	48"	60"	50CM	Custom Len.
\$262.97	\$285.44	\$307.90	\$330.36	\$352.80	\$277.36	See Web
<b>PE-P142LL-27478 Coax, 50 Ohm</b>						
Part No. <b>PE3M0128</b>	Cable Dia.	Attn. @ 1 GHz	Power @ 1 GHz	1 piece price shown. See web or call for volume pricing.		
12"	18"	24"	36"	48"	60"	Custom Len.
\$485.70	\$494.88	\$504.07	\$522.46	\$540.83	\$559.23	See Web
<b>PE-P160LL-27478 Coax, 50 Ohm</b>						
Part No. <b>PE3M0182</b>	Cable Dia.	Attn. @ 1 GHz	Power @ 1 GHz	1 piece price shown. See web or call for volume pricing.		
8"	12"	18"	24"	30"	36"	Custom Len.
\$484.14	\$489.47	\$497.43	\$505.41	\$513.38	\$521.34	See Web
<b>PE-P300LL-27478 Coax, 50 Ohm</b>						
Part No. <b>PE3M0226</b>	Cable Dia.	Attn. @ 1 GHz	Power @ 1 GHz	1 piece price shown. See web or call for volume pricing.		
12"	18"	24"	36"	48"	60"	Custom Len.
\$561.21	\$576.55	\$591.89	\$622.57	\$653.27	\$683.95	See Web
<b>Precision Flexible Cable Assemblies</b>						
<b>PE-P141 Coax, 50 Ohm</b>						
Part No. <b>PE351</b>	Cable Dia.	Attn. @ 1 GHz	Power @ 1 GHz	1 piece price shown. See web or call for volume pricing.		
6"	12"	24"	36"	48"	60"	Custom Len.
\$178.82	\$184.80	\$189.31	\$209.43	\$222.45	\$235.01	See Web
Part No. <b>PE3C0806</b>	Cable Dia.	Attn. @ 1 GHz	Power @ 1 GHz	1 piece price shown. See web or call for volume pricing.		
12"	24"	36"	48"	60"	72"	Custom Len.
\$152.09	\$164.33	\$176.60	\$188.87	\$201.12	\$213.39	See Web
<b>Low PIM Corrugated Cable Assemblies</b>						
<b>PE-1/4SFHC Coax, 50 Ohm</b>						
Part No. <b>PE3C7864</b>	Cable Dia.	Attn. @ 1 GHz	Power @ 1 GHz	1 piece price shown. See web or call for volume pricing.		
12"	24"	36"	48"	60"	50CM	Custom Len.
\$49.77	\$53.53	\$56.77	\$60.51	\$64.23	\$52.18	See Web
<b>SPP-250-LLPL Coax, 50 Ohm</b>						
Part No. <b>PE3C6210</b>	Cable Dia.	Attn. @ 1 GHz	Power @ 1 GHz	1 piece price shown. See web or call for volume pricing.		
12"	24"	36"	48"	60"	50CM	Custom Len.
\$52.84	\$58.49	\$64.62	\$70.76	\$76.88	\$56.27	See Web
<b>Test Flexible Cable Assemblies</b>						
<b>PE-P160 Coax, 50 Ohm</b>						
Part No. <b>PE367</b>	Cable Dia.	Attn. @ 1 GHz	Power @ 1 GHz	1 piece price shown. See web or call for volume pricing.		
12"	24"	36"	48"	60"	50CM	Custom Len.
Call	Call	\$379.08	\$406.33	Call	Call	See Web
<b>Low Loss Test Flexible Cable Assemblies</b>						
<b>PE-P300LL Coax, 50 Ohm</b>						
Part No. <b>PE3C1722</b>	Cable Dia.	Attn. @ 1 GHz	Power @ 1 GHz	1 piece price shown. See web or call for volume pricing.		
12"	24"	36"	48"	60"	50CM	Custom Len.
\$282.95	\$311.08	\$339.19	\$367.31	\$395.43	\$300.96	See Web
Part No. <b>PE3C3248</b>	Cable Dia.	Attn. @ 1 GHz	Power @ 1 GHz	1 piece price shown. See web or call for volume pricing.		
12"	24"	36"	48"	60"	50CM	Custom Len.
\$360.68	\$388.01	\$415.33	\$442.65	\$469.98	\$378.18	See Web
<b>Standard Formable Cable Assemblies</b>						
<b>PE-SR047FL Coax, 50 Ohm</b>						
Part No. <b>PE34197</b>	Cable Dia.	Attn. @ 1 GHz	Power @ 1 GHz	1 piece price shown. See web or call for volume pricing.		
6"	12"	18"	24"	36"	48"	Custom Len.
\$130.67	\$138.52	\$134.66	\$138.67	\$146.66	\$154.64	See Web

<b>PE-SR401FL Coax, 50 Ohm</b>						
Part No. <b>PE34202</b>	Cable Dia.	Attn. @ 1 GHz	Power @ 1 GHz	1 piece price shown. See web or call for volume pricing.		
6"	12"	18"	24"	36"	48"	Custom Len.
\$156.82	\$157.69	\$166.55	\$175.40	\$190.18	\$206.89	See Web
<b>PE-SR402FL Coax, 50 Ohm</b>						
Part No. <b>PE3483</b>	Cable Dia.	Attn. @ 1 GHz	Power @ 1 GHz	1 piece price shown. See web or call for volume pricing.		
6"	12"	18"	24"	36"	48"	Custom Len.
\$62.26	\$66.57	\$71.01	\$75.45	\$84.34	\$96.25	See Web
Part No. <b>PE39425</b>	Cable Dia.	Attn. @ 1 GHz	Power @ 1 GHz	1 piece price shown. See web or call for volume pricing.		
6"	9"	12"	18"	24"	-	Custom Len.
\$47.94	\$45.77	\$47.94	\$52.59	\$56.69	-	See Web
<b>PE-SR402FLJ Coax, 50 Ohm</b>						
Part No. <b>PE39439</b>	Cable Dia.	Attn. @ 1 GHz	Power @ 1 GHz	1 piece price shown. See web or call for volume pricing.		
6"	9"	12"	18"	24"	-	Custom Len.
\$56.10	\$52.43	\$56.10	\$60.85	\$65.60	-	See Web
<b>PE-SR405FL Coax, 50 Ohm</b>						
Part No. <b>PE39417</b>	Cable Dia.	Attn. @ 1 GHz	Power @ 1 GHz	1 piece price shown. See web or call for volume pricing.		
6"	9"	12"	18"	24"	-	Custom Len.
\$54.49	\$51.55	\$54.49	\$60.13	\$66.26	-	See Web
Part No. <b>PE3958</b>	Cable Dia.	Attn. @ 1 GHz	Power @ 1 GHz	1 piece price shown. See web or call for volume pricing.		
6"	12"	18"	24"	36"	48"	Custom Len.
\$80.44	\$81.60	\$87.48	\$93.36	\$105.12	\$115.26	See Web
<b>PE-SR405FLJ Coax, 50 Ohm</b>						
Part No. <b>PE3W02993</b>	Cable Dia.	Attn. @ 1 GHz	Power @ 1 GHz	1 piece price shown. See web or call for volume pricing.		
12"	24"	36"	48"	60"	50CM	Custom Len.
\$53.53	\$62.88	\$72.73	\$82.58	\$92.43	\$59.36	See Web
Part No. <b>PE3W03751</b>	Cable Dia.	Attn. @ 1 GHz	Power @ 1 GHz	1 piece price shown. See web or call for volume pricing.		
12"	24"	36"	48"	60"	50CM	Custom Len.
\$72.06	\$81.91	\$91.75	\$101.60	\$109.89	\$78.38	See Web
<b>Standard Flexible Cable Assemblies</b>						
<b>RG58C/U Coax, 50 Ohm</b>						
Part No. <b>PE3319</b>	Cable Dia.	Attn. @ 1 GHz	Power @ 1 GHz	1 piece price shown. See web or call for volume pricing.		
6"	12"	18"	24"	36"	48"	Custom Len.
\$61.12	\$61.54	\$62.00	\$62.44	\$58.59	\$59.42	See Web
<b>RG142B/U Coax, 50 Ohm</b>						
Part No. <b>PE3512</b>	Cable Dia.	Attn. @ 1 GHz	Power @ 1 GHz	1 piece price shown. See web or call for volume pricing.		
6"	12"	18"	24"	36"	48"	Custom Len.
\$57.83	\$61.07	\$64.43	\$67.75	\$74.44	\$75.48	See Web
<b>RG174A/U Coax, 50 Ohm</b>						
Part No. <b>PE3420</b>	Cable Dia.	Attn. @ 1 GHz	Power @ 1 GHz	1 piece price shown. See web or call for volume pricing.		
6"	12"	18"	24"	36"	48"	Custom Len.
\$70.20	\$70.52	\$70.83	\$71.16	\$71.79	\$67.97	See Web
<b>RG178B/U Coax, 50 Ohm</b>						
Part No. <b>PE3865</b>	Cable Dia.	Attn. @ 1 GHz	Power @ 1 GHz	1 piece price shown. See web or call for volume pricing.		
6"	12"	18"	24"	36"	48"	Custom Len.
\$88.60	\$89.15	\$83.09	\$83.60	\$84.66	\$85.72	See Web
<b>RG188A/U Coax, 50 Ohm</b>						
Part No. <b>PE3510</b>	Cable Dia.	Attn. @ 1 GHz	Power @ 1 GHz	1 piece price shown. See web or call for volume pricing.		
6"	12"	18"	24"	36"	48"	Custom Len.
\$71.39	\$72.73	\$68.55	\$69.78	\$78.22	\$81.10	See Web
Part No. <b>PE3W04442</b>	Cable Dia.	Attn. @ 1 GHz	Power @ 1 GHz	1 piece price shown. See web or call for volume pricing.		
12"	24"	36"	48"	60"	50CM	Custom Len.
\$59.65	\$62.59	\$65.53	\$68.47	\$71.39	\$61.52	See Web
<b>RG188-DS Coax, 50 Ohm</b>						
Part No. <b>PE3779</b>	Cable Dia.	Attn. @ 1 GHz	Power @ 1 GHz	1 piece price shown. See web or call for volume pricing.		
6"	12"	18"	24"	36"	48"	Custom Len.
\$58.83	\$60.71	\$62.64	\$64.57	\$63.68	\$67.42	See Web
<b>RG223/U Coax, 50 Ohm</b>						
Part No. <b>PE3429</b>	Cable Dia.	Attn. @ 1 GHz	Power @ 1 GHz	1 piece price shown. See web or call for volume pricing.		
6"	12"	18"	24"	36"	48"	Custom Len.
\$63.45	\$65.11	\$66.82	\$68.54	\$71.97	\$75.58	See Web
<b>RG316/U Coax, 50 Ohm</b>						
Part No. <b>PE3513</b>	Cable Dia.	Attn. @ 1 GHz	Power @ 1 GHz	1 piece price shown. See web or call for volume pricing.		
6"	12"	18"	24"	36"	48"	Custom Len.
\$70.70	\$72.38	\$74.09	\$72.76	\$79.24	\$82.87	See Web

Cable Assemblies

See Our Website For Current Pricing & Real-Time Stock Availability!

For Custom Lengths, Metric Lengths or Special Configurations, Please call (949) 261-1920



Technical Support  
+1 (949) 261-1920



Same-Day Shipping,  
Even Custom Cable Assemblies



# For our complete selection of cable assemblies, please visit our website

Cable Assemblies  
See Our Website For Current Pricing & Real-Time Stock Availability!

RG316-DS Coax, 50 Ohm						
Part No. <b>PE3344</b>						
1 piece price shown. See web or call for volume pricing.						
6"	12"	18"	24"	36"	48"	Custom Len.
\$62.23	\$62.23	\$63.84	\$65.43	\$68.64	\$71.84	See Web
RG400/U Coax, 50 Ohm						
Part No. <b>PE3003</b>						
1 piece price shown. See web or call for volume pricing.						
6"	12"	18"	24"	36"	48"	Custom Len.
\$70.14	\$74.09	\$78.15	\$82.23	\$90.35	\$98.95	See Web
PE-P086EAM Coax, 50 Ohm						
Part No. <b>PE3CA1040</b>						
1 piece price shown. See web or call for volume pricing.						
12"	24"	36"	50CM	100CM	102CM	Custom Len.
\$68.78	\$82.25	\$95.69	\$77.31	\$90.46	Call	See Web
PE-P141EAM Coax, 50 Ohm						
Part No. <b>PE3CA1036</b>						
1 piece price shown. See web or call for volume pricing.						
10"	11"	12"	14.500/	16"	24"	Custom Len.
\$79.54	\$79.54	\$79.55	Call		\$100.53	See Web
M17/60-RG142-27478 Coax, 50 Ohm						
Part No. <b>PE3M0024</b>						
1 piece price shown. See web or call for volume pricing.						
12"	18"	24"	30"	36"	48"	Custom Len.
\$303.76	\$279.10	\$282.24	\$285.02	\$287.98	\$293.88	See Web
M17/84-RG223-0XDS2 Coax, 50 Ohm						
Part No. <b>PE3M0052</b>						
1 piece price shown. See web or call for volume pricing.						
12"	18"	24"	30"	36"	48"	Custom Len.
\$280.81	\$286.09	\$291.39	\$296.67	\$301.96	\$312.54	See Web
M17/128-RG400-27478 Coax, 50 Ohm						
Part No. <b>PE3M0080</b>						
1 piece price shown. See web or call for volume pricing.						
12"	18"	24"	30"	36"	48"	Custom Len.
\$277.77	\$281.52	\$285.29	\$289.04	\$292.82	\$300.33	See Web
M17/113-RG316-27478 Coax, 50 Ohm						
Part No. <b>PE3M0091</b>						
1 piece price shown. See web or call for volume pricing.						
6"	8"	12"	16"	18"	24"	Custom Len.
\$204.96	\$205.31	\$226.64	\$206.76	\$207.13	\$208.21	See Web
M17/119-RG174-0XDS2 Coax, 50 Ohm						
Part No. <b>PE3M0106</b>						
1 piece price shown. See web or call for volume pricing.						
6"	8"	12"	16"	18"	24"	Custom Len.
\$204.29	\$204.42	\$204.71	\$204.99	\$205.13	\$205.56	See Web
M17/28-RG058-0XDS2 Coax, 50 Ohm						
Part No. <b>PE3M0120</b>						
1 piece price shown. See web or call for volume pricing.						
12"	18"	24"	30"	36"	48"	Custom Len.
\$284.55	\$285.19	\$285.85	\$286.49	\$287.14	\$288.44	See Web

## SMA MALE TO SMA FEMALE BULKHEAD

SEE MOUNTING HOLE SECTION ON PAGE 409

### Standard Flexible Cable Assemblies

M17/113-RG316-27478 Coax, 50 Ohm						
Part No. <b>PE3M0092</b>						
1 piece price shown. See web or call for volume pricing.						
6"	8"	12"	16"	18"	24"	Custom Len.
\$194.93	\$195.28	\$196.02	\$196.73	\$197.10	\$198.19	See Web
M17/119-RG174-0XDS2 Coax, 50 Ohm						
Part No. <b>PE3M0107</b>						
1 piece price shown. See web or call for volume pricing.						
6"	8"	12"	16"	18"	24"	Custom Len.
\$194.27	\$194.40	\$194.69	\$194.96	\$195.10	\$195.53	See Web

## SMA MALE TO SMA MALE RIGHT ANGLE

### Standard Semi-Rigid Cable Assemblies

PE-020SR Coax, 50 Ohm						
Part No. <b>PE34204</b>						
1 piece price shown. See web or call for volume pricing.						
6"	12"	18"	24"	36"	48"	Custom Len.
\$148.52	\$173.89	\$167.58	\$177.15	\$196.21	\$215.27	See Web
PE-034SR Coax, 50 Ohm						
Part No. <b>PE34206</b>						
1 piece price shown. See web or call for volume pricing.						
6"	12"	18"	24"	36"	48"	Custom Len.
\$143.11	\$149.74	\$156.45	\$163.10	\$176.43	\$189.77	See Web
PE-047SR Coax, 50 Ohm						
Part No. <b>PE3230</b>						
1 piece price shown. See web or call for volume pricing.						
6"	12"	18"	24"	36"	48"	Custom Len.
\$133.92	\$133.92	\$139.46	\$145.00	\$156.10	\$167.21	See Web

PE-SR047AL Coax, 50 Ohm						
Part No. <b>PE3393</b>						
1 piece price shown. See web or call for volume pricing.						
6"	12"	18"	24"	36"	48"	Custom Len.
\$120.34	\$125.09	\$129.86	\$134.59	\$144.15	\$153.72	See Web
PE-SR402AL Coax, 50 Ohm						
Part No. <b>PE34195</b>						
1 piece price shown. See web or call for volume pricing.						
6"	12"	18"	24"	36"	48"	Custom Len.
\$72.53	\$77.95	\$78.72	\$83.88	\$94.25	\$104.58	See Web
PE-SR405AL Coax, 50 Ohm						
Part No. <b>PE34199</b>						
1 piece price shown. See web or call for volume pricing.						
6"	12"	18"	24"	36"	48"	Custom Len.
\$70.18	\$74.73	\$79.34	\$83.97	\$93.13	\$102.37	See Web
RG401/U Coax, 50 Ohm						
Part No. <b>PE34220</b>						
1 piece price shown. See web or call for volume pricing.						
6"	12"	18"	24"	36"	48"	Custom Len.
\$158.37	\$170.31	\$166.36	\$177.87	\$200.97	\$224.06	See Web
RG402/U Coax, 50 Ohm						
Part No. <b>PE3821</b>						
1 piece price shown. See web or call for volume pricing.						
6"	12"	18"	24"	36"	48"	Custom Len.
\$74.14	\$78.32	\$76.52	\$80.54	\$88.56	\$96.61	See Web
RG405/U Coax, 50 Ohm						
Part No. <b>PE3822</b>						
1 piece price shown. See web or call for volume pricing.						
6"	12"	18"	24"	36"	48"	Custom Len.
\$78.72	\$78.72	\$82.52	\$86.29	\$101.34	\$101.37	See Web
PE-SR401AL-STRAIGHT Coax, 50 Ohm						
Part No. <b>PE34200</b>						
1 piece price shown. See web or call for volume pricing.						
6"	12"	18"	24"	36"	48"	Custom Len.
\$147.42	\$150.80	\$160.31	\$169.85	\$188.93	\$208.00	See Web

## Standard Flexible Cable Assemblies

RG59B/U Coax, 75 Ohm						
Part No. <b>PE3137</b>						
1 piece price shown. See web or call for volume pricing.						
6"	12"	18"	24"	36"	48"	Custom Len.
\$75.53	\$76.05	\$76.50	\$77.04	\$78.01	\$79.03	See Web
RG179B/U Coax, 75 Ohm						
Part No. <b>PE3459</b>						
1 piece price shown. See web or call for volume pricing.						
6"	12"	18"	24"	36"	48"	Custom Len.
\$68.89	\$68.89	\$70.18	\$71.49	\$74.09	\$76.68	See Web
RG62A/U Coax, 93 Ohm						
Part No. <b>PE3411</b>						
1 piece price shown. See web or call for volume pricing.						
6"	12"	18"	24"	36"	48"	Custom Len.
\$75.79	\$76.50	\$77.24	\$77.96	\$79.43	\$80.86	See Web
RG180B/U Coax, 95 Ohm						
Part No. <b>PE3352</b>						
1 piece price shown. See web or call for volume pricing.						
6"	12"	18"	24"	36"	48"	Custom Len.
\$65.23	\$67.34	\$69.44	\$71.55	\$75.86	\$80.08	See Web

## SMA MALE TO SMA FEMALE

Low Loss Flexible Cable Assemblies						
PE-C100-LSZH Coax, 50 Ohm						
Part No. <b>PE37995</b>						
1 piece price shown. See web or call for volume pricing.						
12"	24"	36"	48"	60"	-	Custom Len.
\$58.18	\$55.18	\$56.51	\$57.82	\$64.12	-	See Web
PE-C195 Coax, 50 Ohm						
Part No. <b>PE36201</b>						
1 piece price shown. See web or call for volume pricing.						
12"	24"	36"	48"	60"	-	Custom Len.
\$52.14	\$53.00	\$50.78	\$51.56	\$52.35	-	See Web
PE-C240 Coax, 50 Ohm						
Part No. <b>PE38638</b>						
1 piece price shown. See web or call for volume pricing.						
12"	24"	36"	48"	60"	-	Custom Len.
\$60.05	\$61.13	\$62.85	\$65.88	\$68.75	-	See Web
PE-C400 Coax, 50 Ohm						
Part No. <b>PE39148</b>						
1 piece price shown. See web or call for volume pricing.						
12"	24"	36"	48"	60"	-	Custom Len.
\$102.79	\$104.24	\$105.67	\$107.13	\$107.07	-	See Web

\*Coax Performance at 1 GHz Notes: Cable assembly max frequency may be lower than connector or coax max frequency

# For our complete selection of cable assemblies, please visit our website

LMR-240 Coax, 50 Ohm						
Part No. <a href="#">PE3W02466</a>	Cable Dia.			Attn. @ 1 GHz	Power @ 1 GHz	
1 piece price shown. See web or call for volume pricing.						
12"	24"	36"	48"	60"	50CM	Custom Len.
\$54.28	\$54.80	\$55.84	\$56.88	\$57.91	\$54.45	See Web
PE-P142LL Coax, 50 Ohm						
Part No. <a href="#">PE340</a>	Cable Dia.			Attn. @ 1 GHz	Power @ 1 GHz	
1 piece price shown. See web or call for volume pricing.						
12"	24"	36"	48"	60"	50CM	Custom Len.
\$164.20	\$181.80	\$199.42	\$217.01	\$234.61	\$175.49	See Web
PE-P142LL-27478 Coax, 50 Ohm						
Part No. <a href="#">PE3M0126</a>	Cable Dia.			Attn. @ 1 GHz	Power @ 1 GHz	
1 piece price shown. See web or call for volume pricing.						
12"	18"	24"	36"	48"	60"	Custom Len.
\$449.49	\$458.68	\$467.87	\$486.25	\$504.63	\$523.03	See Web
LMR-240-UF Coax, 50 Ohm						
Part No. <a href="#">PE3W04971</a>	Cable Dia.			Attn. @ 1 GHz	Power @ 1 GHz	
1 piece price shown. See web or call for volume pricing.						
12"	24"	36"	48"	60"	50CM	Custom Len.
\$52.58	\$54.06	\$55.05	\$56.53	\$58.01	\$53.52	See Web
Precision Formable Cable Assemblies						
PE-SR402FL Coax, 50 Ohm						
Part No. <a href="#">PE39426</a>	Cable Dia.			Attn. @ 1 GHz	Power @ 1 GHz	
1 piece price shown. See web or call for volume pricing.						
6"	9"	12"	18"	24"	-	Custom Len.
\$44.72	\$40.64	\$44.72	\$49.17	\$53.63	-	See Web
PE-SR405FL Coax, 50 Ohm						
Part No. <a href="#">PE39418</a>	Cable Dia.			Attn. @ 1 GHz	Power @ 1 GHz	
1 piece price shown. See web or call for volume pricing.						
6"	9"	12"	18"	24"	-	Custom Len.
\$42.09	\$44.63	\$44.63	\$50.57	\$55.97	-	See Web
PE-SR405FLJ Coax, 50 Ohm						
Part No. <a href="#">PE39432</a>	Cable Dia.			Attn. @ 1 GHz	Power @ 1 GHz	
1 piece price shown. See web or call for volume pricing.						
6"	9"	12"	18"	24"	-	Custom Len.
\$42.08	\$39.69	\$42.08	\$46.87	\$51.66	-	See Web
PE-80TEST Coax, 50 Ohm						
Part No. <a href="#">PE3TC0102</a>	Cable Dia.			Attn. @ 1 GHz	Power @ 1 GHz	
1 piece price shown. See web or call for volume pricing.						
24"	48"	72"	-	-	-	Custom Len.
\$386.89	\$479.84	\$572.80	-	-	-	See Web
Part No. <a href="#">PE3TC0202</a>	Cable Dia.			Attn. @ 1 GHz	Power @ 1 GHz	
1 piece price shown. See web or call for volume pricing.						
24"	48"	72"	-	-	-	Custom Len.
\$600.12	\$693.08	\$786.03	-	-	-	See Web
Low PIM Corrugated Cable Assemblies						
PE-1/4SFHC Coax, 50 Ohm						
Part No. <a href="#">PE3C7865</a>	Cable Dia.			Attn. @ 1 GHz	Power @ 1 GHz	
1 piece price shown. See web or call for volume pricing.						
12"	24"	36"	48"	60"	50CM	Custom Len.
\$49.22	\$52.98	\$56.23	\$59.96	\$63.68	\$51.63	See Web
SPP-250-LLPL Coax, 50 Ohm						
Part No. <a href="#">PE3C5883</a>	Cable Dia.			Attn. @ 1 GHz	Power @ 1 GHz	
1 piece price shown. See web or call for volume pricing.						
12"	24"	36"	48"	60"	50CM	Custom Len.
\$63.87	\$70.00	\$76.13	\$82.27	\$88.40	\$67.79	See Web
Standard Formable Cable Assemblies						
PE-SR407FL Coax, 50 Ohm						
Part No. <a href="#">PE34228</a>	Cable Dia.			Attn. @ 1 GHz	Power @ 1 GHz	
1 piece price shown. See web or call for volume pricing.						
6"	12"	18"	24"	36"	48"	Custom Len.
\$105.25	\$105.25	\$118.56	\$111.78	\$119.77	\$127.76	See Web
PE-SR401FL Coax, 50 Ohm						
Part No. <a href="#">PE34233</a>	Cable Dia.			Attn. @ 1 GHz	Power @ 1 GHz	
1 piece price shown. See web or call for volume pricing.						
6"	12"	18"	24"	36"	48"	Custom Len.
\$125.97	\$125.97	\$134.31	\$142.66	\$159.37	\$176.05	See Web
PE-SR402FL Coax, 50 Ohm						
Part No. <a href="#">PE3443</a>	Cable Dia.			Attn. @ 1 GHz	Power @ 1 GHz	
1 piece price shown. See web or call for volume pricing.						
6"	12"	18"	24"	36"	48"	Custom Len.
\$62.74	\$67.06	\$66.23	\$70.38	\$78.67	\$86.96	See Web
PE-SR402FLJ Coax, 50 Ohm						
Part No. <a href="#">PE39440</a>	Cable Dia.			Attn. @ 1 GHz	Power @ 1 GHz	
1 piece price shown. See web or call for volume pricing.						
6"	9"	12"	18"	24"	-	Custom Len.
\$42.91	Call	\$42.91	Call	\$52.87	-	See Web
PE-SR405FL Coax, 50 Ohm						
Part No. <a href="#">PE3651</a>	Cable Dia.			Attn. @ 1 GHz	Power @ 1 GHz	
1 piece price shown. See web or call for volume pricing.						
6"	12"	18"	24"	36"	48"	Custom Len.
\$76.58	\$76.58	\$88.94	\$95.17	\$100.09	\$110.30	See Web

Standard Flexible Cable Assemblies						
RG58C/U Coax, 50 Ohm						
Part No. <a href="#">PE3078</a>	Cable Dia.			Attn. @ 1 GHz	Power @ 1 GHz	
1 piece price shown. See web or call for volume pricing.						
6"	12"	18"	24"	36"	48"	Custom Len.
\$58.38	\$63.06	\$58.80	\$59.19	\$64.84	\$60.82	See Web
RG142B/U Coax, 50 Ohm						
Part No. <a href="#">PE3611</a>	Cable Dia.			Attn. @ 1 GHz	Power @ 1 GHz	
1 piece price shown. See web or call for volume pricing.						
6"	12"	18"	24"	36"	48"	Custom Len.
\$56.60	\$59.84	\$57.58	\$60.71	\$73.21	\$73.32	See Web
RG174A/U Coax, 50 Ohm						
Part No. <a href="#">PE3715</a>	Cable Dia.			Attn. @ 1 GHz	Power @ 1 GHz	
1 piece price shown. See web or call for volume pricing.						
6"	12"	18"	24"	36"	48"	Custom Len.
\$61.67	\$61.99	\$62.30	\$58.94	\$63.25	\$63.92	See Web
RG178B/U Coax, 50 Ohm						
Part No. <a href="#">PE3056</a>	Cable Dia.			Attn. @ 1 GHz	Power @ 1 GHz	
1 piece price shown. See web or call for volume pricing.						
6"	12"	18"	24"	36"	48"	Custom Len.
\$76.21	\$72.43	\$72.97	\$77.94	\$79.10	\$75.59	See Web
RG188A/U Coax, 50 Ohm						
Part No. <a href="#">PE3706</a>	Cable Dia.			Attn. @ 1 GHz	Power @ 1 GHz	
1 piece price shown. See web or call for volume pricing.						
6"	12"	18"	24"	36"	48"	Custom Len.
\$61.60	\$61.60	\$62.81	\$64.04	\$66.48	\$68.92	See Web
RG223/U Coax, 50 Ohm						
Part No. <a href="#">PE3697</a>	Cable Dia.			Attn. @ 1 GHz	Power @ 1 GHz	
1 piece price shown. See web or call for volume pricing.						
6"	12"	18"	24"	36"	48"	Custom Len.
\$52.12	\$53.80	\$55.02	\$56.73	\$60.15	\$59.85	See Web
RG316/U Coax, 50 Ohm						
Part No. <a href="#">PE3832</a>	Cable Dia.			Attn. @ 1 GHz	Power @ 1 GHz	
1 piece price shown. See web or call for volume pricing.						
6"	12"	18"	24"	36"	48"	Custom Len.
\$63.57	\$65.24	\$66.96	\$68.67	\$67.90	\$75.76	See Web
RG316-DS Coax, 50 Ohm						
Part No. <a href="#">PE3171</a>	Cable Dia.			Attn. @ 1 GHz	Power @ 1 GHz	
1 piece price shown. See web or call for volume pricing.						
6"	12"	18"	24"	36"	48"	Custom Len.
\$69.43	\$65.83	\$67.43	\$74.54	\$77.96	\$75.44	See Web
RG400/U Coax, 50 Ohm						
Part No. <a href="#">PE3864</a>	Cable Dia.			Attn. @ 1 GHz	Power @ 1 GHz	
1 piece price shown. See web or call for volume pricing.						
6"	12"	18"	24"	36"	48"	Custom Len.
\$63.47	\$63.47	\$67.31	\$71.13	\$78.79	\$86.46	See Web
PE-P141 Coax, 50 Ohm						
Part No. <a href="#">PE3C1876</a>	Cable Dia.			Attn. @ 1 GHz	Power @ 1 GHz	
1 piece price shown. See web or call for volume pricing.						
12"	24"	36"	48"	60"	50CM	Custom Len.
\$59.05	\$72.02	\$85.00	\$97.97	\$109.41	\$67.35	See Web
PE-P195 Coax, 50 Ohm						
Part No. <a href="#">PE3160</a>	Cable Dia.			Attn. @ 1 GHz	Power @ 1 GHz	
1 piece price shown. See web or call for volume pricing.						
6"	12"	18"	24"	36"	48"	Custom Len.
\$68.80	\$72.93	\$73.65	\$78.53	\$88.26	\$98.00	See Web
PE-VNA-R Coax, 50 Ohm						
Part No. <a href="#">PE3VNA1802</a>	Cable Dia.			Attn. @ 1 GHz	Power @ 1 GHz	
1 piece price shown. See web or call for volume pricing.						
24"	48"	-	-	-	-	Custom Len.
\$858.46	\$954.71	-	-	-	-	See Web
RG59B/U Coax, 75 Ohm						
Part No. <a href="#">PE3333</a>	Cable Dia.			Attn. @ 1 GHz	Power @ 1 GHz	
1 piece price shown. See web or call for volume pricing.						
6"	12"	18"	24"	36"	48"	Custom Len.
\$76.20	\$76.20	\$76.73	\$81.92	\$78.32	\$79.37	See Web
RG179B/U Coax, 75 Ohm						
Part No. <a href="#">PE3102</a>	Cable Dia.			Attn. @ 1 GHz	Power @ 1 GHz	
1 piece price shown. See web or call for volume pricing.						
6"	12"	18"	24"	36"	48"	Custom Len.
\$61.89	\$68.08	\$63.18	\$64.48	\$67.08	\$76.68	See Web
RG62A/U Coax, 93 Ohm						
Part No. <a href="#">PE3405</a>	Cable Dia.			Attn. @ 1 GHz	Power @ 1 GHz	
1 piece price shown. See web or call for volume pricing.						
6"	12"	18"	24"	36"	48"	Custom Len.
\$71.62	\$72.35	\$73.07	\$73.80	\$75.26	\$76.71	See Web
Standard Semi-Rigid Cable Assemblies						
PE-020SR Coax, 50 Ohm						
Part No. <a href="#">PE34224</a>	Cable Dia.			Attn. @ 1 GHz	Power @ 1 GHz	
1 piece price shown. See web or call for volume pricing.						
6"	12"	18"	24"	36"	48"	Custom Len.
\$147.41	\$156.96	\$166.48	\$176.03	\$195.09	\$214.16	See Web

Cable Assemblies

See Our Website For Current Pricing & Real-Time Stock Availability!

For Custom Lengths, Metric Lengths or Special Configurations, Please call (949) 261-1920



Technical Support  
+1 (949) 261-1920



Same-Day Shipping,  
Even Custom Cable Assemblies

# For our complete selection of cable assemblies, please visit our website

Cable Assemblies  
See Our Website For Current Pricing & Real-Time Stock Availability!

PE-034SR Coax, 50 Ohm						
Part No. <a href="#">PE34226</a>	Cable Dia.	Attn. @ 1 GHz	Power @ 1 GHz			
1 piece price shown. See web or call for volume pricing.						
6"	12"	18"	24"	36"	48"	Custom Len.
\$158.74	\$158.74	\$165.40	\$172.07	\$185.39	\$209.04	See Web
PE-047SR Coax, 50 Ohm						
Part No. <a href="#">PE3188</a>	Cable Dia.	Attn. @ 1 GHz	Power @ 1 GHz			
1 piece price shown. See web or call for volume pricing.						
6"	12"	18"	24"	36"	48"	Custom Len.
\$106.94	\$106.94	\$112.49	\$118.05	\$129.15	\$140.24	See Web
PE-SR047AL Coax, 50 Ohm						
Part No. <a href="#">PE3253</a>	Cable Dia.	Attn. @ 1 GHz	Power @ 1 GHz			
1 piece price shown. See web or call for volume pricing.						
6"	12"	18"	24"	36"	48"	Custom Len.
\$101.75	\$101.11	\$105.93	\$109.22	\$118.77	\$128.27	See Web
PE-SR402AL Coax, 50 Ohm						
Part No. <a href="#">PE34235</a>	Cable Dia.	Attn. @ 1 GHz	Power @ 1 GHz			
1 piece price shown. See web or call for volume pricing.						
6"	12"	18"	24"	36"	48"	Custom Len.
\$62.63	\$68.06	\$73.65	\$75.80	\$86.12	\$96.48	See Web
PE-SR405AL Coax, 50 Ohm						
Part No. <a href="#">PE34237</a>	Cable Dia.	Attn. @ 1 GHz	Power @ 1 GHz			
1 piece price shown. See web or call for volume pricing.						
6"	12"	18"	24"	36"	48"	Custom Len.
\$64.10	\$68.74	\$73.35	\$77.89	\$87.12	\$96.31	See Web
RG401/U Coax, 50 Ohm						
Part No. <a href="#">PE33896</a>	Cable Dia.	Attn. @ 1 GHz	Power @ 1 GHz			
1 piece price shown. See web or call for volume pricing.						
6"	12"	18"	24"	36"	48"	Custom Len.
\$133.29	\$133.29	\$153.58	\$157.09	\$180.88	\$204.68	See Web
RG402/U Coax, 50 Ohm						
Part No. <a href="#">PE3823</a>	Cable Dia.	Attn. @ 1 GHz	Power @ 1 GHz			
1 piece price shown. See web or call for volume pricing.						
6"	12"	18"	24"	36"	48"	Custom Len.
\$62.67	\$63.06	\$71.14	\$71.09	\$79.13	\$93.14	See Web
RG405/U Coax, 50 Ohm						
Part No. <a href="#">PE3824</a>	Cable Dia.	Attn. @ 1 GHz	Power @ 1 GHz			
1 piece price shown. See web or call for volume pricing.						
6"	12"	18"	24"	36"	48"	Custom Len.
\$73.96	\$72.16	\$75.94	\$79.72	\$87.26	\$94.83	See Web
PE-SR401AL-STRAIGHT Coax, 50 Ohm						
Part No. <a href="#">PE34230</a>	Cable Dia.	Attn. @ 1 GHz	Power @ 1 GHz			
1 piece price shown. See web or call for volume pricing.						
6"	12"	18"	24"	36"	48"	Custom Len.
\$112.20	\$121.72	\$131.26	\$140.78	\$159.84	\$178.92	See Web
Standard Flexible Cable Assemblies						
RG55B/U Coax, 53 Ohm						
Part No. <a href="#">PE3093</a>	Cable Dia.	Attn. @ 1 GHz	Power @ 1 GHz			
1 piece price shown. See web or call for volume pricing.						
6"	12"	18"	24"	36"	48"	Custom Len.
\$44.99	\$46.19	\$47.39	\$48.56	\$50.97	\$53.38	See Web
SMA MALE TO SMA FEMALE BULKHEAD						
SEE MOUNTING HOLE SECTION ON PAGE 409						
Low Loss Flexible Cable Assemblies						
PE-C100-LSZH Coax, 50 Ohm						
Part No. <a href="#">PE38240</a>	Cable Dia.	Attn. @ 1 GHz	Power @ 1 GHz			
1 piece price shown. See web or call for volume pricing.						
12"	24"	36"	48"	60"	-	Custom Len.
\$57.93	\$54.94	\$56.28	\$57.61	\$58.92	-	See Web
PE-C195 Coax, 50 Ohm						
Part No. <a href="#">PE36417</a>	Cable Dia.	Attn. @ 1 GHz	Power @ 1 GHz			
1 piece price shown. See web or call for volume pricing.						
12"	24"	36"	48"	60"	-	Custom Len.
\$44.12	\$45.58	\$47.05	\$48.51	\$50.05	-	See Web
LMR-195 Coax, 50 Ohm						
Part No. <a href="#">PE3C5767</a>	Cable Dia.	Attn. @ 1 GHz	Power @ 1 GHz			
1 piece price shown. See web or call for volume pricing.						
12"	24"	36"	48"	60"	50CM	Custom Len.
\$54.15	\$54.83	\$55.17	\$55.85	\$56.53	\$54.24	See Web
PE-P160LL Coax, 50 Ohm						
Part No. <a href="#">PE3C5242</a>	Cable Dia.	Attn. @ 1 GHz	Power @ 1 GHz			
1 piece price shown. See web or call for volume pricing.						
12"	24"	36"	48"	60"	50CM	Custom Len.
\$241.18	\$263.65	\$286.09	\$308.56	\$331.01	\$255.57	See Web
PE-P142LL-27478 Coax, 50 Ohm						
Part No. <a href="#">PE3M0127</a>	Cable Dia.	Attn. @ 1 GHz	Power @ 1 GHz			
1 piece price shown. See web or call for volume pricing.						
12"	18"	24"	36"	48"	60"	Custom Len.
\$484.90	\$494.09	\$503.27	\$521.66	\$540.05	\$558.43	See Web



PE-P160LL-27478 Coax, 50 Ohm						
Part No. <a href="#">PE3M0181</a>	Cable Dia.	Attn. @ 1 GHz	Power @ 1 GHz			
1 piece price shown. See web or call for volume pricing.						
8"	12"	18"	24"	30"	36"	Custom Len.
\$479.88	\$485.20	\$493.16	\$501.13	\$509.12	\$517.07	See Web
Low PIM Corrugated Cable Assemblies						
PE-1/4SFHC Coax, 50 Ohm						
Part No. <a href="#">PE3C7866</a>	Cable Dia.	Attn. @ 1 GHz	Power @ 1 GHz			
1 piece price shown. See web or call for volume pricing.						
12"	24"	36"	48"	60"	50CM	Custom Len.
\$52.00	\$55.25	\$58.97	\$62.70	\$66.42	\$54.41	See Web
Standard Formable Cable Assemblies						
PE-SR047FL Coax, 50 Ohm						
Part No. <a href="#">PE34245</a>	Cable Dia.	Attn. @ 1 GHz	Power @ 1 GHz			
1 piece price shown. See web or call for volume pricing.						
6"	12"	18"	24"	36"	48"	Custom Len.
\$107.77	\$111.63	\$115.53	\$119.37	\$127.11	\$134.86	See Web
PE-SR401FL Coax, 50 Ohm						
Part No. <a href="#">PE34249</a>	Cable Dia.	Attn. @ 1 GHz	Power @ 1 GHz			
1 piece price shown. See web or call for volume pricing.						
6"	12"	18"	24"	36"	48"	Custom Len.
\$120.85	\$129.00	\$137.07	\$145.21	\$161.40	\$177.59	See Web
PE-SR402FLJ Coax, 50 Ohm						
Part No. <a href="#">PE39441</a>	Cable Dia.	Attn. @ 1 GHz	Power @ 1 GHz			
1 piece price shown. See web or call for volume pricing.						
6"	9"	12"	18"	24"	-	Custom Len.
\$45.26	\$41.14	\$45.26	\$50.06	\$54.34	-	See Web
PE-SR405FL Coax, 50 Ohm						
Part No. <a href="#">PE39419</a>	Cable Dia.	Attn. @ 1 GHz	Power @ 1 GHz			
1 piece price shown. See web or call for volume pricing.						
4"	6"	9"	12"	18"	24"	Custom Len.
\$48.35	\$54.50	\$52.05	\$54.50	\$60.64	\$66.77	See Web
PE-SR405FLJ Coax, 50 Ohm						
Part No. <a href="#">PE39433</a>	Cable Dia.	Attn. @ 1 GHz	Power @ 1 GHz			
1 piece price shown. See web or call for volume pricing.						
6"	9"	12"	18"	24"	-	Custom Len.
\$20.96	\$43.80	\$20.96	\$25.88	\$29.98	-	See Web
Standard Flexible Cable Assemblies						
RG58C/U Coax, 50 Ohm						
Part No. <a href="#">PE3956</a>	Cable Dia.	Attn. @ 1 GHz	Power @ 1 GHz			
1 piece price shown. See web or call for volume pricing.						
6"	12"	18"	24"	36"	48"	Custom Len.
\$52.59	\$52.98	\$53.38	\$53.77	\$54.08	\$54.93	See Web
RG142B/U Coax, 50 Ohm						
Part No. <a href="#">PE3494</a>	Cable Dia.	Attn. @ 1 GHz	Power @ 1 GHz			
1 piece price shown. See web or call for volume pricing.						
6"	12"	18"	24"	36"	48"	Custom Len.
\$60.21	\$63.45	\$66.80	\$70.13	\$71.36	\$83.90	See Web
RG174A/U Coax, 50 Ohm						
Part No. <a href="#">PE3184</a>	Cable Dia.	Attn. @ 1 GHz	Power @ 1 GHz			
1 piece price shown. See web or call for volume pricing.						
6"	12"	18"	24"	36"	48"	Custom Len.
\$65.38	\$65.68	\$66.00	\$66.32	\$66.96	\$67.63	See Web
RG178B/U Coax, 50 Ohm						
Part No. <a href="#">PE3959</a>	Cable Dia.	Attn. @ 1 GHz	Power @ 1 GHz			
1 piece price shown. See web or call for volume pricing.						
6"	12"	18"	24"	36"	48"	Custom Len.
\$58.53	\$62.04	\$62.62	\$63.21	\$64.37	\$61.68	See Web
RG188A/U Coax, 50 Ohm						
Part No. <a href="#">PE3051</a>	Cable Dia.	Attn. @ 1 GHz	Power @ 1 GHz			
1 piece price shown. See web or call for volume pricing.						
6"	12"	18"	24"	36"	48"	Custom Len.
\$55.94	\$57.28	\$55.26	\$60.02	\$58.91	\$65.66	See Web
RG223/U Coax, 50 Ohm						
Part No. <a href="#">PE3553</a>	Cable Dia.	Attn. @ 1 GHz	Power @ 1 GHz			
1 piece price shown. See web or call for volume pricing.						
6"	12"	18"	24"	36"	48"	Custom Len.
\$59.47	\$55.57	\$57.16	\$64.55	\$61.93	\$71.60	See Web
RG316/U Coax, 50 Ohm						
Part No. <a href="#">PE3835</a>	Cable Dia.	Attn. @ 1 GHz	Power @ 1 GHz			
1 piece price shown. See web or call for volume pricing.						
5"	6"	12"	18"	24"	36"	Custom Len.
\$60.55	\$58.86	\$60.54	\$62.26	\$59.22	\$62.42	See Web
RG400/U Coax, 50 Ohm						
Part No. <a href="#">PE3924</a>	Cable Dia.	Attn. @ 1 GHz	Power @ 1 GHz			
1 piece price shown. See web or call for volume pricing.						
6"	12"	18"	24"	36"	48"	Custom Len.
\$69.24	\$73.20	\$71.60	\$81.33	\$83.10	\$90.76	See Web

\*Coax Performance at 1 GHz Notes: Cable assembly max frequency may be lower than connector or coax max frequency



For our complete selection of cable assemblies, please visit our website

PE-P086EAM Coax, 50 Ohm						
Part No. <a href="#">PE3CA1042</a>	Cable Dia.			Attn. @ 1 GHz	Power @ 1 GHz	
1 piece price shown. See web or call for volume pricing.						
12"	24"	36"	100"	50CM	100CM	Custom Len.
\$68.78	\$82.25	\$107.18	Call	Call	\$122.67	See Web
PE-P195 Coax, 50 Ohm						
Part No. <a href="#">PE3799</a>	Cable Dia.			Attn. @ 1 GHz	Power @ 1 GHz	
1 piece price shown. See web or call for volume pricing.						
6"	12"	18"	24"	0.195" dia.	12.5 dB/100ft	650 W
\$60.55	\$65.23	\$69.98	\$79.67	\$90.20	\$93.52	See Web
RG55B/U Coax, 53 Ohm						
Part No. <a href="#">PE3940</a>	Cable Dia.			Attn. @ 1 GHz	Power @ 1 GHz	
1 piece price shown. See web or call for volume pricing.						
6"	12"	18"	24"	0.202" dia.	16.5 dB/100ft	53 W
\$54.61	\$54.61	\$55.86	\$57.09	\$59.56	\$62.02	See Web
RG59B/U Coax, 75 Ohm						
Part No. <a href="#">PE3871</a>	Cable Dia.			Attn. @ 1 GHz	Power @ 1 GHz	
1 piece price shown. See web or call for volume pricing.						
6"	12"	18"	24"	0.242" dia.	11.5 dB/100ft	77 W
\$70.24	\$70.77	\$71.23	\$71.77	\$72.74	\$73.75	See Web
RG179B/U Coax, 75 Ohm						
Part No. <a href="#">PE3967</a>	Cable Dia.			Attn. @ 1 GHz	Power @ 1 GHz	
1 piece price shown. See web or call for volume pricing.						
6"	12"	18"	24"	0.1" dia.	25 dB/100ft	200 W
\$63.63	\$63.63	\$64.95	\$66.23	\$68.82	\$77.31	See Web
RG62A/U Coax, 93 Ohm						
Part No. <a href="#">PE3806</a>	Cable Dia.			Attn. @ 1 GHz	Power @ 1 GHz	
1 piece price shown. See web or call for volume pricing.						
6"	12"	18"	24"	0.242" dia.	13 dB/100ft	77 W
\$70.51	\$71.23	\$71.94	\$72.68	\$74.14	\$75.58	See Web
Standard Semi-Rigid Cable Assemblies						
PE-020SR Coax, 50 Ohm						
Part No. <a href="#">PE34241</a>	Cable Dia.			Attn. @ 1 GHz	Power @ 1 GHz	
1 piece price shown. See web or call for volume pricing.						
6"	12"	18"	24"	36"	48"	Custom Len.
\$147.87	\$157.44	\$166.93	\$176.51	\$195.56	\$214.63	See Web
PE-034SR Coax, 50 Ohm						
Part No. <a href="#">PE34243</a>	Cable Dia.			Attn. @ 1 GHz	Power @ 1 GHz	
1 piece price shown. See web or call for volume pricing.						
6"	12"	18"	24"	36"	48"	Custom Len.
\$151.63	\$158.29	\$164.97	\$171.62	\$184.95	\$198.31	See Web
PE-047SR Coax, 50 Ohm						
Part No. <a href="#">PE3531</a>	Cable Dia.			Attn. @ 1 GHz	Power @ 1 GHz	
1 piece price shown. See web or call for volume pricing.						
6"	12"	18"	24"	36"	48"	Custom Len.
\$109.27	\$114.68	\$120.07	\$125.43	\$136.23	\$146.95	See Web
PE-SR047AL Coax, 50 Ohm						
Part No. <a href="#">PE3382</a>	Cable Dia.			Attn. @ 1 GHz	Power @ 1 GHz	
1 piece price shown. See web or call for volume pricing.						
6"	12"	18"	24"	36"	48"	Custom Len.
\$108.69	\$113.45	\$118.19	\$123.02	\$132.51	\$142.09	See Web
PE-SR402AL Coax, 50 Ohm						
Part No. <a href="#">PE34252</a>	Cable Dia.			Attn. @ 1 GHz	Power @ 1 GHz	
1 piece price shown. See web or call for volume pricing.						
6"	12"	18"	24"	36"	48"	Custom Len.
\$69.02	\$67.68	\$72.85	\$78.02	\$88.37	\$98.73	See Web
PE-SR405AL Coax, 50 Ohm						
Part No. <a href="#">PE34254</a>	Cable Dia.			Attn. @ 1 GHz	Power @ 1 GHz	
1 piece price shown. See web or call for volume pricing.						
6"	12"	18"	24"	36"	48"	Custom Len.
\$64.37	\$64.30	\$74.68	\$73.48	\$82.71	\$91.89	See Web
RG401/U Coax, 50 Ohm						
Part No. <a href="#">PE34256</a>	Cable Dia.			Attn. @ 1 GHz	Power @ 1 GHz	
1 piece price shown. See web or call for volume pricing.						
6"	12"	18"	24"	36"	48"	Custom Len.
\$124.31	\$135.82	\$147.41	\$158.92	\$182.03	\$205.11	See Web
RG402/U Coax, 50 Ohm						
Part No. <a href="#">PE3825</a>	Cable Dia.			Attn. @ 1 GHz	Power @ 1 GHz	
1 piece price shown. See web or call for volume pricing.						
6"	12"	18"	24"	36"	48"	Custom Len.
\$66.28	\$65.25	\$69.27	\$73.27	\$81.32	\$89.34	See Web
PE3C2892						
Part No. <a href="#">PE3C2892</a>	Cable Dia.			Attn. @ 1 GHz	Power @ 1 GHz	
1 piece price shown. See web or call for volume pricing.						
6"	12"	18"	24"	36"	48"	Custom Len.
\$49.79	\$49.79	\$61.01	\$64.91	\$72.71	\$80.49	See Web
RG405/U Coax, 50 Ohm						
Part No. <a href="#">PE3826</a>	Cable Dia.			Attn. @ 1 GHz	Power @ 1 GHz	
1 piece price shown. See web or call for volume pricing.						
6"	12"	18"	24"	36"	48"	Custom Len.
\$64.88	\$71.37	\$75.45	\$79.55	\$79.99	\$87.55	See Web
PE-SR401AL-STRAIGHT Coax, 50 Ohm						
Part No. <a href="#">PE34247</a>	Cable Dia.			Attn. @ 1 GHz	Power @ 1 GHz	
1 piece price shown. See web or call for volume pricing.						
6"	12"	18"	24"	0.25" dia.	8 dB/100ft	1,400 W
\$139.79	\$139.79	\$149.62	\$159.45	\$179.12	\$198.80	See Web

SMA MALE TO REVERSE POLARITY SMA MALE						
Low Loss Flexible Cable Assemblies						
PE-C100-LSZH Coax, 50 Ohm						
Part No. <a href="#">PE37900</a>	Cable Dia.			Attn. @ 1 GHz	Power @ 1 GHz	
1 piece price shown. See web or call for volume pricing.						
12"	24"	36"	48"	60"	-	Custom Len.
\$55.07	\$56.53	\$54.13	\$54.96	\$56.29	-	See Web
LMR-240 Coax, 50 Ohm						
Part No. <a href="#">PE3W00906</a>	Cable Dia.			Attn. @ 1 GHz	Power @ 1 GHz	
1 piece price shown. See web or call for volume pricing.						
12"	24"	36"	48"	60"	50CM	Custom Len.
\$63.04	\$64.08	\$65.11	\$66.15	\$67.18	\$63.70	See Web
Standard Flexible Cable Assemblies						
RG58C/U Coax, 50 Ohm						
Part No. <a href="#">PE34116</a>	Cable Dia.			Attn. @ 1 GHz	Power @ 1 GHz	
1 piece price shown. See web or call for volume pricing.						
12"	24"	36"	48"	60"	72"	Custom Len.
\$65.55	\$66.44	\$62.30	\$63.11	\$63.92	\$64.73	See Web
RG142B/U Coax, 50 Ohm						
Part No. <a href="#">PE34614</a>	Cable Dia.			Attn. @ 1 GHz	Power @ 1 GHz	
1 piece price shown. See web or call for volume pricing.						
12"	24"	36"	48"	60"	72"	Custom Len.
\$57.41	\$63.70	\$70.00	\$76.32	\$82.61	\$88.92	See Web
RG174A/U Coax, 50 Ohm						
Part No. <a href="#">PE34331</a>	Cable Dia.			Attn. @ 1 GHz	Power @ 1 GHz	
1 piece price shown. See web or call for volume pricing.						
12"	24"	36"	48"	60"	72"	Custom Len.
\$60.21	\$56.25	\$56.73	\$57.19	\$57.68	\$58.16	See Web
RG178B/U Coax, 50 Ohm						
Part No. <a href="#">PE35208</a>	Cable Dia.			Attn. @ 1 GHz	Power @ 1 GHz	
1 piece price shown. See web or call for volume pricing.						
12"	24"	36"	48"	60"	72"	Custom Len.
\$79.14	\$80.30	\$74.08	\$75.12	\$76.18	\$77.24	See Web
RG188A/U Coax, 50 Ohm						
Part No. <a href="#">PE35210</a>	Cable Dia.			Attn. @ 1 GHz	Power @ 1 GHz	
1 piece price shown. See web or call for volume pricing.						
12"	24"	36"	48"	60"	72"	Custom Len.
\$57.75	\$60.19	\$62.63	\$65.07	\$67.52	\$69.96	See Web
RG223/U Coax, 50 Ohm						
Part No. <a href="#">PE34398</a>	Cable Dia.			Attn. @ 1 GHz	Power @ 1 GHz	
1 piece price shown. See web or call for volume pricing.						
12"	24"	36"	48"	60"	72"	Custom Len.
\$53.77	\$56.48	\$59.65	\$62.84	\$66.03	\$73.93	See Web
RG316/U Coax, 50 Ohm						
Part No. <a href="#">PE35212</a>	Cable Dia.			Attn. @ 1 GHz	Power @ 1 GHz	
1 piece price shown. See web or call for volume pricing.						
12"	24"	36"	48"	60"	72"	Custom Len.
\$58.83	\$62.27	\$65.70	\$64.37	\$67.67	\$70.97	See Web
RG316-DS Coax, 50 Ohm						
Part No. <a href="#">PE36963</a>	Cable Dia.			Attn. @ 1 GHz	Power @ 1 GHz	
1 piece price shown. See web or call for volume pricing.						
12"	24"	36"	48"	60"	-	Custom Len.
\$63.23	\$61.74	\$70.09	\$68.14	\$71.34	-	See Web
SMA MALE TO REVERSE POLARITY SMA MALE RIGHT ANGLE						
Standard Flexible Cable Assemblies						
RG174A/U Coax, 50 Ohm						
Part No. <a href="#">PE3W07225</a>	Cable Dia.			Attn. @ 1 GHz	Power @ 1 GHz	
1 piece price shown. See web or call for volume pricing.						
12"	24"	36"	48"	60"	50CM	Custom Len.
\$91.39	\$92.01	\$92.63	\$93.24	\$93.86	\$91.78	See Web
SMA MALE TO REVERSE THREAD SMA MALE						
Standard Flexible Cable Assemblies						
RG58C/U Coax, 50 Ohm						
Part No. <a href="#">PE35351</a>	Cable Dia.			Attn. @ 1 GHz	Power @ 1 GHz	
1 piece price shown. See web or call for volume pricing.						
12"	24"	36"	48"	60"	72"	Custom Len.
\$56.19	\$57.00	\$57.77	\$58.56	\$59.37	\$60.21	See Web
RG142B/U Coax, 50 Ohm						
Part No. <a href="#">PE35355</a>	Cable Dia.			Attn. @ 1 GHz	Power @ 1 GHz	
1 piece price shown. See web or call for volume pricing.						
12"	24"	36"	48"	60"	72"	Custom Len.
\$58.35	\$64.44	\$70.57	\$76.65	\$82.79	\$88.85	See Web

Cable Assemblies

See Our Website For Current Pricing & Real-Time Stock Availability!

For Custom Lengths, Metric Lengths or Special Configurations, Please call (949) 261-1920



Technical Support  
+1 (949) 261-1920



Same-Day Shipping,  
Even Custom Cable Assemblies



For our complete selection of cable assemblies, please visit our website

Cable Assemblies  
See Our Website For Current Pricing & Real-Time Stock Availability!

RG174A/U Coax, 50 Ohm						
Part No. <a href="#">PE35359</a>	Cable Dia.		Attn. @ 1 GHz	Power @ 1 GHz		
1 piece price shown. See web or call for volume pricing.	0.1" dia.		32 dB/100ft	16 W		
12"	24"	36"	48"	60"	72"	Custom Len.
\$57.90	\$58.35	\$58.90	\$59.37	\$59.88	\$60.33	See Web

RG178B/U Coax, 50 Ohm						
Part No. <a href="#">PE35363</a>	Cable Dia.		Attn. @ 1 GHz	Power @ 1 GHz		
1 piece price shown. See web or call for volume pricing.	0.072" dia.		44.4 dB/100ft	78 W		
12"	24"	36"	48"	60"	72"	Custom Len.
\$66.75	\$67.79	\$68.85	\$69.91	\$70.97	\$72.03	See Web

RG188A/U Coax, 50 Ohm						
Part No. <a href="#">PE35367</a>	Cable Dia.		Attn. @ 1 GHz	Power @ 1 GHz		
1 piece price shown. See web or call for volume pricing.	0.11" dia.		26 dB/100ft	160 W		
12"	24"	36"	48"	60"	72"	Custom Len.
\$59.75	\$62.12	\$64.44	\$66.81	\$69.20	\$71.50	See Web

RG223/U Coax, 50 Ohm						
Part No. <a href="#">PE35371</a>	Cable Dia.		Attn. @ 1 GHz	Power @ 1 GHz		
1 piece price shown. See web or call for volume pricing.	0.21" dia.		13.4 dB/100ft	53 W		
12"	24"	36"	48"	60"	72"	Custom Len.
\$59.89	\$63.08	\$66.26	\$69.44	\$72.63	\$75.83	See Web

RG316/U Coax, 50 Ohm						
Part No. <a href="#">PE35375</a>	Cable Dia.		Attn. @ 1 GHz	Power @ 1 GHz		
1 piece price shown. See web or call for volume pricing.	0.098" dia.		38 dB/100ft	160 W		
12"	24"	36"	48"	60"	72"	Custom Len.
\$60.73	\$64.03	\$67.34	\$70.64	\$73.93	\$77.24	See Web

**SMA MALE TO SMB PLUG**



**Standard Formable Cable Assemblies**

PE-SR405FL Coax, 50 Ohm						
Part No. <a href="#">PE34764</a>	Cable Dia.		Attn. @ 1 GHz	Power @ 1 GHz		
1 piece price shown. See web or call for volume pricing.	-		22.5 dB/100ft	130 W		
12"	24"	36"	48"	60"	-	Custom Len.
\$66.17	\$78.91	\$91.66	\$104.40	\$115.53	-	See Web

**Standard Flexible Cable Assemblies**

PE-B100 Coax, 50 Ohm						
Part No. <a href="#">PE34455</a>	Cable Dia.		Attn. @ 1 GHz	Power @ 1 GHz		
1 piece price shown. See web or call for volume pricing.	0.101" dia.					
6"	12"	18"	24"	36"	48"	Custom Len.
\$57.32	\$60.75	\$61.22	\$65.11	\$72.92	\$80.70	See Web

**RG58C/U Coax, 50 Ohm**

Part No. <a href="#">PE3172</a>	Cable Dia.		Attn. @ 1 GHz	Power @ 1 GHz		
1 piece price shown. See web or call for volume pricing.	0.195" dia.		20 dB/100ft	44 W		
6"	12"	18"	24"	36"	48"	Custom Len.
\$56.59	\$61.12	\$57.00	\$62.02	\$62.90	\$59.01	See Web

**RG142B/U Coax, 50 Ohm**

Part No. <a href="#">PE3181</a>	Cable Dia.		Attn. @ 1 GHz	Power @ 1 GHz		
1 piece price shown. See web or call for volume pricing.	0.195" dia.		12.9 dB/100ft			
6"	12"	18"	24"	36"	48"	Custom Len.
\$54.90	\$54.90	\$61.54	\$61.22	\$71.57	\$73.81	See Web

**RG174A/U Coax, 50 Ohm**

Part No. <a href="#">PE3908</a>	Cable Dia.		Attn. @ 1 GHz	Power @ 1 GHz		
1 piece price shown. See web or call for volume pricing.	0.1" dia.		32 dB/100ft	16 W		
6"	12"	18"	24"	36"	48"	Custom Len.
\$51.71	\$52.03	\$52.35	\$49.58	\$53.32	\$54.00	See Web

**RG178B/U Coax, 50 Ohm**

Part No. <a href="#">PE3548</a>	Cable Dia.		Attn. @ 1 GHz	Power @ 1 GHz		
1 piece price shown. See web or call for volume pricing.	0.072" dia.		44.4 dB/100ft	78 W		
6"	12"	18"	24"	36"	48"	Custom Len.
\$67.58	\$68.15	\$63.63	\$64.17	\$70.49	\$66.26	See Web

**RG188A/U Coax, 50 Ohm**

Part No. <a href="#">PE3755</a>	Cable Dia.		Attn. @ 1 GHz	Power @ 1 GHz		
1 piece price shown. See web or call for volume pricing.	0.11" dia.		26 dB/100ft	160 W		
6"	12"	18"	24"	36"	48"	Custom Len.
\$52.04	\$52.04	\$53.28	\$54.50	\$56.46	\$58.89	See Web

**RG188-DS Coax, 50 Ohm**

Part No. <a href="#">PE3722</a>	Cable Dia.		Attn. @ 1 GHz	Power @ 1 GHz		
1 piece price shown. See web or call for volume pricing.	0.122" dia.		30 dB/100ft	160 W		
6"	12"	18"	24"	36"	48"	Custom Len.
\$46.21	\$46.21	\$48.12	\$50.00	\$53.77	\$57.03	See Web

**RG198A/U Coax, 50 Ohm**

Part No. <a href="#">PE34448</a>	Cable Dia.		Attn. @ 1 GHz	Power @ 1 GHz		
1 piece price shown. See web or call for volume pricing.	0.08" dia.		49 dB/100ft	78 W		
6"	12"	18"	24"	36"	48"	Custom Len.
\$63.54	\$63.54	\$64.28	\$65.03	\$66.53	\$68.06	See Web

**RG223/U Coax, 50 Ohm**

Part No. <a href="#">PE3187</a>	Cable Dia.		Attn. @ 1 GHz	Power @ 1 GHz		
1 piece price shown. See web or call for volume pricing.	0.209" dia.		13.41 dB/100ft	50 W		
6"	12"	18"	24"	36"	48"	Custom Len.
\$52.27	\$54.89	\$53.88	\$58.32	\$58.17	\$65.38	See Web

RG316/U Coax, 50 Ohm						
Part No. <a href="#">PE3810</a>	Cable Dia.		Attn. @ 1 GHz	Power @ 1 GHz		
1 piece price shown. See web or call for volume pricing.	0.098" dia.		38 dB/100ft	160 W		
6"	12"	18"	24"	36"	48"	Custom Len.
\$52.62	\$54.31	\$55.52	\$57.22	\$60.67	\$64.30	See Web

RG316-DS Coax, 50 Ohm						
Part No. <a href="#">PE33657</a>	Cable Dia.		Attn. @ 1 GHz	Power @ 1 GHz		
1 piece price shown. See web or call for volume pricing.	0.114" dia.		30 dB/100ft	160 W		
6"	12"	18"	24"	36"	48"	Custom Len.
\$54.46	\$57.72	\$59.44	\$61.17	\$64.58	\$68.23	See Web

RG400/U Coax, 50 Ohm						
Part No. <a href="#">PE34452</a>	Cable Dia.		Attn. @ 1 GHz	Power @ 1 GHz		
1 piece price shown. See web or call for volume pricing.	0.195" dia.		14.7 dB/100ft	650 W		
6"	12"	18"	24"	36"	48"	Custom Len.
\$64.95	\$71.43	\$68.77	\$72.60	\$87.69	\$87.93	See Web

**Standard Semi-Rigid Cable Assemblies**

RG405/U Coax, 50 Ohm						
Part No. <a href="#">PE35527</a>	Cable Dia.		Attn. @ 1 GHz	Power @ 1 GHz		
1 piece price shown. See web or call for volume pricing.	-		22 dB/100ft	130 W		
12"	24"	36"	48"	60"	-	Custom Len.
\$58.18	\$70.99	\$73.27	\$80.84	\$88.38	-	See Web

**SMA MALE TO SMB PLUG RIGHT ANGLE**



**Low Loss Flexible Cable Assemblies**

PE-C100-LSZH Coax, 50 Ohm						
Part No. <a href="#">PE3W00416</a>	Cable Dia.		Attn. @ 1 GHz	Power @ 1 GHz		
1 piece price shown. See web or call for volume pricing.	0.109" dia.					
12"	24"	36"	48"	60"	50CM	Custom Len.
\$36.83	\$38.25	\$39.68	\$41.11	\$42.54	\$37.74	See Web

**Standard Flexible Cable Assemblies**

RG174A/U Coax, 50 Ohm						
Part No. <a href="#">PE3W04476</a>	Cable Dia.		Attn. @ 1 GHz	Power @ 1 GHz		
1 piece price shown. See web or call for volume pricing.	0.11" dia.		32 dB/100ft	17 W		
12"	24"	36"	48"	60"	50CM	Custom Len.
\$45.80	\$46.42	\$47.04	\$47.66	\$48.28	\$46.18	See Web

**SMA MALE TO SMB JACK**



**Standard Flexible Cable Assemblies**

RG316/U Coax, 50 Ohm						
Part No. <a href="#">PE3W03014</a>	Cable Dia.		Attn. @ 1 GHz	Power @ 1 GHz		
1 piece price shown. See web or call for volume pricing.	0.098" dia.		38 dB/100ft	160 W		
12"	24"	36"	48"	60"	50CM	Custom Len.
\$43.56	\$47.20	\$50.84	\$54.48	\$57.60	\$45.89	See Web

RG316-DS Coax, 50 Ohm						
Part No. <a href="#">PE3W05361</a>	Cable Dia.		Attn. @ 1 GHz	Power @ 1 GHz		
1 piece price shown. See web or call for volume pricing.	0.114" dia.		30 dB/100ft	85 W		
12"	24"	36"	48"	60"	50CM	Custom Len.
\$71.74	\$75.30	\$78.88	\$82.44	\$86.03	\$74.03	See Web

**SMA MALE TO SMC PLUG**



**Standard Flexible Cable Assemblies**

PE-B100 Coax, 50 Ohm						
Part No. <a href="#">PE34460</a>	Cable Dia.		Attn. @ 1 GHz	Power @ 1 GHz		
1 piece price shown. See web or call for volume pricing.	0.101" dia.					
6"	12"	14"	18"	24"	36"	Custom Len.
\$48.73	\$52.59	Call	\$55.87	\$59.62	\$67.13	See Web

RG58C/U Coax, 50 Ohm						
Part No. <a href="#">PE3210</a>	Cable Dia.		Attn. @ 1 GHz	Power @ 1 GHz		
1 piece price shown. See web or call for volume pricing.	0.195" dia.		20 dB/100ft	44 W		
6"	12"	18"	24"	36"	48"	Custom Len.
\$60.46	\$60.46	\$60.87	\$61.28	\$62.09	\$62.89	See Web



RG174A/U Coax, 50 Ohm						
Part No. <a href="#">PE3944</a>	Cable Dia.		Attn. @ 1 GHz	Power @ 1 GHz		
1 piece price shown. See web or call for volume pricing.	0.1" dia.		32 dB/100ft	16 W		
6"	12"	18"	24"	36"	48"	Custom Len.
\$56.54	\$56.54	\$56.78	\$57.03	\$57.50	\$57.98	See Web



RG178B/U Coax, 50 Ohm						
Part No. <a href="#">PE3W07493</a>	Cable Dia.		Attn. @ 1 GHz	Power @ 1 GHz		
1 piece price shown. See web or call for volume pricing.	0.11" dia.		32 dB/100ft	17 W		
12"	24"	36"	48"	60"	50CM	Custom Len.
\$45.03	\$45.65	\$46.28	\$46.90	\$47.52	\$45.41	See Web

RG178B/U Coax, 50 Ohm						
Part No. <a href="#">PE3561</a>	Cable Dia.		Attn. @ 1 GHz	Power @ 1 GHz		
1 piece price shown. See web or call for volume pricing.	0.072" dia.		44.4 dB/100ft	78 W		
6"	12"	18"	24"	36"	48"	Custom Len.
\$58.35	\$58.90	\$59.43	\$59.94	\$61.00	\$62.05	See Web

\*Coax Performance at 1 GHz Notes: Cable assembly max frequency may be lower than connector or coax max frequency

# For our complete selection of cable assemblies, please visit our website

RG188A/U Coax, 50 Ohm						
Part No. <a href="#">PE3736</a>			Cable Dia.	Attn. @ 1 GHz	Power @ 1 GHz	2
1 piece price shown. See web or call for volume pricing.			0.11" dia.	26 dB/100ft	160 W	
6"	12"	18"	24"	36"	48"	Custom Len.
\$46.13	\$47.31	\$48.51	\$49.65	\$52.04	\$54.45	See Web
RG188-DS Coax, 50 Ohm						
Part No. <a href="#">PE34458</a>			Cable Dia.	Attn. @ 1 GHz	Power @ 1 GHz	3
1 piece price shown. See web or call for volume pricing.			0.122" dia.	30 dB/100ft	160 W	
6"	12"	18"	24"	36"	48"	Custom Len.
\$51.04	\$51.04	\$52.91	\$54.30	\$58.04	\$61.78	See Web
RG196A/U Coax, 50 Ohm						
Part No. <a href="#">PE34450</a>			Cable Dia.	Attn. @ 1 GHz	Power @ 1 GHz	4
1 piece price shown. See web or call for volume pricing.			0.08" dia.	49 dB/100ft	78 W	
6"	12"	18"	24"	36"	48"	Custom Len.
\$64.04	\$64.04	\$64.79	\$65.56	\$67.05	\$68.56	See Web
RG223/U Coax, 50 Ohm						
Part No. <a href="#">PE3226</a>			Cable Dia.	Attn. @ 1 GHz	Power @ 1 GHz	5
1 piece price shown. See web or call for volume pricing.			0.209" dia.	13.41 dB/100ft	50 W	
6"	12"	18"	24"	36"	48"	Custom Len.
\$56.49	\$56.49	\$58.08	\$59.67	\$62.86	\$66.04	See Web
RG316/U Coax, 50 Ohm						
Part No. <a href="#">PE3809</a>			Cable Dia.	Attn. @ 1 GHz	Power @ 1 GHz	6
1 piece price shown. See web or call for volume pricing.			0.098" dia.	38 dB/100ft	160 W	
6"	12"	18"	24"	36"	48"	Custom Len.
\$53.09	\$53.09	\$54.18	\$60.24	\$58.94	\$62.12	See Web
RG316-DS Coax, 50 Ohm						
Part No. <a href="#">PE34456</a>			Cable Dia.	Attn. @ 1 GHz	Power @ 1 GHz	7
1 piece price shown. See web or call for volume pricing.			0.114" dia.	30 dB/100ft	160 W	
6"	12"	18"	24"	36"	48"	Custom Len.
\$46.56	\$46.56	\$48.18	\$52.83	\$55.78	\$55.73	See Web
RG400/U Coax, 50 Ohm						
Part No. <a href="#">PE34454</a>			Cable Dia.	Attn. @ 1 GHz	Power @ 1 GHz	8
1 piece price shown. See web or call for volume pricing.			0.195" dia.	14.7 dB/100ft	650 W	
6"	12"	18"	24"	36"	48"	Custom Len.
\$60.55	\$64.37	\$68.19	\$72.11	\$79.80	\$87.53	See Web
<b>SMA MALE TO SMP FEMALE</b>						
						
Standard Formable Cable Assemblies						
PE-SR047FL Coax, 50 Ohm						
Part No. <a href="#">PE36164</a>			Cable Dia.	Attn. @ 1 GHz	Power @ 1 GHz	9
1 piece price shown. See web or call for volume pricing.			0.047" dia.	36 dB/100ft	32 W	
12"	24"	36"	48"	60"	72"	Custom Len.
\$99.86	\$107.28	\$108.87	\$125.41	\$124.85	\$132.85	See Web
Standard Semi-Rigid Cable Assemblies						
RG405/U Coax, 50 Ohm						
Part No. <a href="#">PE36166</a>			Cable Dia.	Attn. @ 1 GHz	Power @ 1 GHz	10
1 piece price shown. See web or call for volume pricing.			0.072" dia.	22 dB/100ft	130 W	
12"	24"	36"	48"	60"	72"	Custom Len.
\$68.73	\$76.88	\$85.05	\$93.69	\$96.29	\$103.83	See Web
<b>SMA MALE TO SMP FEMALE RIGHT ANGLE</b>						
						
Flexible Cable Assemblies						
PE-P047 Coax, 50 Ohm						
Part No. <a href="#">PE3C4968</a>			Cable Dia.	Attn. @ 1 GHz	Power @ 1 GHz	11
1 piece price shown. See web or call for volume pricing.			0.098" dia.	35 dB/100ft	43 W	
12"	24"	36"	48"	60"	50CM	Custom Len.
\$108.02	\$116.95	\$121.41	\$130.35	\$139.29	\$109.27	See Web
Standard Formable Cable Assemblies						
PE-SR405FLJ Coax, 50 Ohm						
Part No. <a href="#">PE3W06701</a>			Cable Dia.	Attn. @ 1 GHz	Power @ 1 GHz	12
1 piece price shown. See web or call for volume pricing.			0.105" dia.	19.5 dB/100ft	121.5 W	
12"	24"	36"	48"	60"	50CM	Custom Len.
\$74.83	\$84.67	\$94.52	\$104.35	\$112.62	\$81.13	See Web
Standard Flexible Cable Assemblies						
RG316/U Coax, 50 Ohm						
Part No. <a href="#">PE3C3028</a>			Cable Dia.	Attn. @ 1 GHz	Power @ 1 GHz	13
1 piece price shown. See web or call for volume pricing.			0.098" dia.	38 dB/100ft	160 W	
12"	24"	36"	48"	60"	50CM	Custom Len.
\$60.13	\$60.07	\$63.40	\$66.75	\$70.06	\$58.88	See Web
Part No. <a href="#">PE3W05274</a>			Cable Dia.	Attn. @ 1 GHz	Power @ 1 GHz	14
1 piece price shown. See web or call for volume pricing.			0.098" dia.	38 dB/100ft	160 W	
12"	24"	36"	48"	60"	50CM	Custom Len.
\$51.13	\$66.17	\$69.77	\$73.38	\$77.00	\$64.87	See Web
<b>SMA MALE TO SSMA MALE</b>						
						
Low Loss Flexible Cable Assemblies						

PE-C100-LSZH Coax, 50 Ohm						
Part No. <a href="#">PE3W01283</a>			Cable Dia.	Attn. @ 1 GHz	Power @ 1 GHz	15
1 piece price shown. See web or call for volume pricing.			0.109" dia.	0.109" dia.	160 W	
12"	24"	36"	48"	60"	50CM	Custom Len.
\$54.34	\$55.26	\$56.66	\$58.09	\$59.50	\$54.74	See Web
Standard Flexible Cable Assemblies						
RG174A/U Coax, 50 Ohm						
Part No. <a href="#">PE35430</a>			Cable Dia.	Attn. @ 1 GHz	Power @ 1 GHz	16
1 piece price shown. See web or call for volume pricing.			0.1" dia.	32 dB/100ft	16 W	
6"	12"	18"	24"	36"	48"	Custom Len.
\$69.11	\$63.11	\$63.35	\$63.61	\$64.08	\$64.55	See Web
RG178B/U Coax, 50 Ohm						
Part No. <a href="#">PE3058</a>			Cable Dia.	Attn. @ 1 GHz	Power @ 1 GHz	17
1 piece price shown. See web or call for volume pricing.			0.072" dia.	44.41 dB/100ft	55 W	
6"	12"	18"	24"	36"	48"	Custom Len.
\$76.57	\$72.76	\$73.29	\$73.82	\$79.46	\$80.69	See Web
RG316-DS Coax, 50 Ohm						
Part No. <a href="#">PE37401</a>			Cable Dia.	Attn. @ 1 GHz	Power @ 1 GHz	19
1 piece price shown. See web or call for volume pricing.			0.114" dia.	30 dB/100ft	160 W	
12"	24"	36"	48"	60"	-	Custom Len.
\$70.17	\$73.61	\$71.36	\$74.58	\$77.76	-	See Web
RG316/U Coax, 50 Ohm						
Part No. <a href="#">PE3669</a>			Cable Dia.	Attn. @ 1 GHz	Power @ 1 GHz	18
1 piece price shown. See web or call for volume pricing.			0.098" dia.	38 dB/100ft	160 W	
6"	12"	18"	24"	36"	48"	Custom Len.
\$69.79	\$71.46	\$73.19	\$69.34	\$72.52	\$75.69	See Web
<b>SMA MALE TO SSMC PLUG</b>						
						
Low Loss Flexible Cable Assemblies						
LMR-100A-PVC Coax, 50 Ohm						
Part No. <a href="#">PE3C4422</a>			Cable Dia.	Attn. @ 1 GHz	Power @ 1 GHz	20
1 piece price shown. See web or call for volume pricing.			0.11" dia.	24 dB/100ft	160 W	
6"	12"	18"	24"	36"	48"	Custom Len.
\$54.56	\$54.97	\$50.83	\$51.25	\$56.63	\$52.87	See Web
Standard Formable Cable Assemblies						
PE-SR405FLJ Coax, 50 Ohm						
Part No. <a href="#">PE3C4444</a>			Cable Dia.	Attn. @ 1 GHz	Power @ 1 GHz	21
1 piece price shown. See web or call for volume pricing.			0.105" dia.	19.5 dB/100ft	121.5 W	
6"	12"	18"	24"	36"	48"	Custom Len.
\$67.85	\$72.41	\$77.10	\$81.78	\$82.35	\$90.63	See Web
Standard Flexible Cable Assemblies						
RG178B/U Coax, 50 Ohm						
Part No. <a href="#">PE3C4391</a>			Cable Dia.	Attn. @ 1 GHz	Power @ 1 GHz	22
1 piece price shown. See web or call for volume pricing.			0.072" dia.	44.41 dB/100ft	55 W	
6"	12"	18"	24"	36"	48"	Custom Len.
\$71.01	\$78.70	\$79.67	\$79.95	\$81.19	\$82.43	See Web
RG196A/U Coax, 50 Ohm						
Part No. <a href="#">PE3W06410</a>			Cable Dia.	Attn. @ 1 GHz	Power @ 1 GHz	23
1 piece price shown. See web or call for volume pricing.			0.08" dia.	49 dB/100ft	78 W	
12"	24"	36"	48"	60"	50CM	Custom Len.
\$72.55	\$74.18	\$75.82	\$77.44	\$79.08	\$73.59	See Web
RG316-DS Coax, 50 Ohm						
Part No. <a href="#">PE3C4437</a>			Cable Dia.	Attn. @ 1 GHz	Power @ 1 GHz	25
1 piece price shown. See web or call for volume pricing.			0.114" dia.	9.15 dB/100ft	85 W	
6"	12"	18"	24"	36"	48"	Custom Len.
\$63.67	\$65.33	\$60.96	\$68.78	\$65.61	\$75.85	See Web
RG316/U Coax, 50 Ohm						
Part No. <a href="#">PE3C4405</a>			Cable Dia.	Attn. @ 1 GHz	Power @ 1 GHz	24
1 piece price shown. See web or call for volume pricing.			0.098" dia.	38 dB/100ft	160 W	
6"	12"	18"	24"	36"	48"	Custom Len.
\$61.19	\$62.73	\$68.22	\$65.81	\$68.90	\$71.97	See Web
<b>SMA MALE TO SSMC PLUG RIGHT ANGLE</b>						
						
Low Loss Flexible Cable Assemblies						
LMR-100A-PVC Coax, 50 Ohm						
Part No. <a href="#">PE3C4423</a>			Cable Dia.	Attn. @ 1 GHz	Power @ 1 GHz	26
1 piece price shown. See web or call for volume pricing.			0.11" dia.	24 dB/100ft	160 W	
6"	12"	18"	24"	36"	48"	Custom Len.
\$49.00	\$49.41	\$49.83	\$47.42	\$48.25	\$51.99	See Web
Standard Formable Cable Assemblies						
PE-SR405FLJ Coax, 50 Ohm						
Part No. <a href="#">PE3C4484</a>			Cable Dia.	Attn. @ 1 GHz	Power @ 1 GHz	27
1 piece price shown. See web or call for volume pricing.			0.105" dia.	19.5 dB/100ft	121.5 W	
6"	12"	18"	24"	36"	48"	Custom Len.
\$58.27	\$68.65	\$66.54	\$70.68	\$87.43	\$87.23	See Web

Cable Assemblies

See Our Website For Current Pricing & Real-Time Stock Availability!

For Custom Lengths, Metric Lengths or Special Configurations, Please call (949) 261-1920



Technical Support  
+1 (949) 261-1920



Same-Day Shipping,  
Even Custom Cable Assemblies

For our complete selection of cable assemblies, please visit our website

Cable Assemblies

See Our Website For Current Pricing & Real-Time Stock Availability!

Standard Flexible Cable Assemblies						
RG178B/U Coax, 50 Ohm						
Part No.	PE3C4463			Cable Dia.	Attn. @ 1 GHz	Power @ 1 GHz
1 piece price shown. See web or call for volume pricing.						
6"	12"	18"	24"	0.072" dia.	44.41 dB/100ft	55 W
\$61.77	\$66.03	\$62.80	\$63.31	36"	48"	Custom Len.
\$64.34	\$65.36	See Web				
RG316/U Coax, 50 Ohm						
Part No.	PE3C4406			Cable Dia.	Attn. @ 1 GHz	Power @ 1 GHz
1 piece price shown. See web or call for volume pricing.						
6"	12"	18"	24"	0.098" dia.	38 dB/100ft	160 W
\$55.10	\$56.58	\$58.07	\$59.52	36"	48"	Custom Len.
\$62.49	\$65.44	See Web				
RG316-DS Coax, 50 Ohm						
Part No.	PE3C4471			Cable Dia.	Attn. @ 1 GHz	Power @ 1 GHz
1 piece price shown. See web or call for volume pricing.						
6"	12"	18"	24"	0.114" dia.	30 dB/100ft	85 W
\$52.32	\$58.76	\$60.46	\$56.52	36"	48"	Custom Len.
\$59.63	\$62.73	See Web				

**SMA MALE TO SSMC JACK**



Standard Flexible Cable Assemblies						
RG316-DS Coax, 50 Ohm						
Part No.	PE3W04458			Cable Dia.	Attn. @ 1 GHz	Power @ 1 GHz
1 piece price shown. See web or call for volume pricing.						
12"	24"	36"	48"	0.114" dia.	30 dB/100ft	85 W
\$57.15	\$60.71	\$64.29	\$67.87	60"	50CM	Custom Len.
\$71.44	\$59.44	See Web				

**SMA MALE TO SSMC JACK BULKHEAD**

SEE MOUNTING HOLE SECTION ON PAGE 409



Standard Formable Cable Assemblies						
PE-SR405FLJ Coax, 50 Ohm						
Part No.	PE3C4445			Cable Dia.	Attn. @ 1 GHz	Power @ 1 GHz
1 piece price shown. See web or call for volume pricing.						
6"	12"	18"	24"	0.105" dia.	19.5 dB/100ft	121.5 W
\$54.18	\$58.31	\$62.46	\$66.58	36"	48"	Custom Len.
\$74.87	\$83.14	See Web				

**Standard Flexible Cable Assemblies**

RG178B/U Coax, 50 Ohm						
Part No.	PE3C4392			Cable Dia.	Attn. @ 1 GHz	Power @ 1 GHz
1 piece price shown. See web or call for volume pricing.						
6"	12"	18"	24"	0.072" dia.	44.41 dB/100ft	55 W
\$66.66	\$71.20	\$67.68	\$68.20	36"	48"	Custom Len.
\$69.22	\$70.24	See Web				

**SMA MALE TO TNC MALE**



Low Loss Flexible Cable Assemblies						
PE-C195 Coax, 50 Ohm						
Part No.	PE36058			Cable Dia.	Attn. @ 1 GHz	Power @ 1 GHz
1 piece price shown. See web or call for volume pricing.						
12"	24"	36"	48"	0.195" dia.	11.3 dB/100ft	150 W
\$42.91	\$43.77	\$44.64	\$42.11	60"	-	Custom Len.
\$42.90	-	See Web				

PE-C240 Coax, 50 Ohm						
Part No.	PE38642			Cable Dia.	Attn. @ 1 GHz	Power @ 1 GHz
1 piece price shown. See web or call for volume pricing.						
12"	24"	36"	48"	0.24" dia.	9.2 dB/100ft	250 W
\$52.70	\$53.77	\$54.53	\$57.58	60"	-	Custom Len.
\$60.68	-	See Web				

LMR-195 Coax, 50 Ohm						
Part No.	PE3C4164			Cable Dia.	Attn. @ 1 GHz	Power @ 1 GHz
1 piece price shown. See web or call for volume pricing.						
12"	24"	36"	48"	0.195" dia.	11.8 dB/100ft	-
\$61.75	\$59.06	\$59.85	\$60.66	60"	-	Custom Len.
\$61.46	-	See Web				

PE-P142LL Coax, 50 Ohm						
Part No.	PE3C0847			Cable Dia.	Attn. @ 1 GHz	Power @ 1 GHz
1 piece price shown. See web or call for volume pricing.						
12"	24"	36"	48"	0.195" dia.	7.2 dB/100ft	-
\$156.54	\$174.15	\$191.76	\$209.35	60"	50CM	Custom Len.
\$226.96	\$167.82	See Web				

PE-P160LL Coax, 50 Ohm						
Part No.	PE3C5258			Cable Dia.	Attn. @ 1 GHz	Power @ 1 GHz
1 piece price shown. See web or call for volume pricing.						
12"	24"	36"	48"	0.16" dia.	-	50CM
\$222.74	\$245.21	\$267.66	\$290.11	60"	50CM	Custom Len.
\$312.56	\$237.13	See Web				

PE-P142LL-27478 Coax, 50 Ohm						
Part No.	PE3M0129			Cable Dia.	Attn. @ 1 GHz	Power @ 1 GHz
1 piece price shown. See web or call for volume pricing.						
12"	18"	24"	36"	0.195" dia.	-	60"
\$398.21	\$407.39	\$416.58	\$434.97	48"	60"	Custom Len.
\$453.35	\$471.74	See Web				

PE-P160LL-27478 Coax, 50 Ohm						
Part No.	PE3M0183			Cable Dia.	Attn. @ 1 GHz	Power @ 1 GHz
1 piece price shown. See web or call for volume pricing.						
8"	12"	18"	24"	0.16" dia.	-	30"
\$383.46	\$388.77	\$396.74	\$404.70	30"	36"	Custom Len.
\$412.68	\$420.65	See Web				

PE-P300LL-27478 Coax, 50 Ohm						
Part No.	PE3M0227			Cable Dia.	Attn. @ 1 GHz	Power @ 1 GHz
1 piece price shown. See web or call for volume pricing.						
12"	18"	24"	36"	0.3" dia.	-	60"
\$435.24	\$450.59	\$465.92	\$496.60	48"	60"	Custom Len.
\$527.30	\$557.98	See Web				

**Low Loss Test Flexible Cable Assemblies**

PE-P300LL Coax, 50 Ohm						
Part No.	PE338			Cable Dia.	Attn. @ 1 GHz	Power @ 1 GHz
1 piece price shown. See web or call for volume pricing.						
12"	24"	36"	48"	0.3" dia.	5.5 dB/100ft	32 W
\$298.59	\$326.70	Call	\$382.96	60"	50CM	Custom Len.
\$411.06	\$316.61	See Web				

PE-P300LL Coax, 50 Ohm						
Part No.	PE3C3242			Cable Dia.	Attn. @ 1 GHz	Power @ 1 GHz
1 piece price shown. See web or call for volume pricing.						
12"	24"	36"	48"	0.3" dia.	5.5 dB/100ft	32 W
\$236.63	\$263.97	\$291.28	\$318.61	60"	50CM	Custom Len.
\$345.94	\$254.14	See Web				

**Standard Formable Cable Assemblies**

PE-SR047FL Coax, 50 Ohm						
Part No.	PE34412			Cable Dia.	Attn. @ 1 GHz	Power @ 1 GHz
1 piece price shown. See web or call for volume pricing.						
6"	12"	18"	24"	0.047" dia.	36 dB/100ft	32 W
\$87.06	\$90.96	\$94.92	\$98.80	36"	48"	Custom Len.
\$106.67	\$112.94	See Web				

PE-SR401FL Coax, 50 Ohm						
Part No.	PE34422			Cable Dia.	Attn. @ 1 GHz	Power @ 1 GHz
1 piece price shown. See web or call for volume pricing.						
6"	12"	18"	24"	0.105" dia.	7.6 dB/100ft	1,400 W
\$168.38	\$176.98	\$175.31	\$183.65	36"	48"	Custom Len.
\$200.34	\$217.04	See Web				

PE-SR402FL Coax, 50 Ohm						
Part No.	PE33928			Cable Dia.	Attn. @ 1 GHz	Power @ 1 GHz
1 piece price shown. See web or call for volume pricing.						
6"	12"	18"	24"	0.18" dia.	11.88 dB/100ft	450 W
\$86.47	\$86.47	\$91.07	\$95.66	36"	48"	Custom Len.
\$104.84	\$112.44	See Web				

PE-SR405FL Coax, 50 Ohm						
Part No.	PE34416			Cable Dia.	Attn. @ 1 GHz	Power @ 1 GHz
1 piece price shown. See web or call for volume pricing.						
6"	12"	18"	24"	0.105" dia.	22.5 dB/100ft	130 W
\$75.17	\$75.21	\$80.93	\$86.61	36"	48"	Custom Len.
\$98.03	\$107.94	See Web				

**Standard Flexible Cable Assemblies**

RG8A/U Coax, 50 Ohm						
Part No.	PE33669			Cable Dia.	Attn. @ 1 GHz	Power @ 1 GHz
1 piece price shown. See web or call for volume pricing.						
12"	24"	36"	48"	0.405" dia.	8 dB/100ft	190 W
\$122.10	\$124.89	\$136.08	\$130.56	60"	-	Custom Len.
\$133.42	-	See Web				

RG58C/U Coax, 50 Ohm						
Part No.	PE3154			Cable Dia.	Attn. @ 1 GHz	Power @ 1 GHz
1 piece price shown. See web or call for volume pricing.						
12"	24"	36"	48"	0.195" dia.	20 dB/100ft	44 W
\$46.78	\$47.68	\$48.58	\$49.55	60"	72"	Custom Len.
\$50.46	\$51.39	See Web				

RG141A/U Coax, 50 Ohm						
Part No.	PE37580			Cable Dia.	Attn. @ 1 GHz	Power @ 1 GHz
1 piece price shown. See web or call for volume pricing.						
12"	24"	36"	48"	0.19" dia.	13 dB/100ft	650 W
\$53.51	\$59.55	\$66.10	\$72.61	60"	-	Custom Len.
\$79.20	-	See Web				

RG142B/U Coax, 50 Ohm						
Part No.	PE3664			Cable Dia.	Attn. @ 1 GHz	Power @ 1 GHz
1 piece price shown. See web or call for volume pricing.						
12"	24"	36"	48"	0.195" dia.	13 dB/100ft	650 W
\$50.45	\$59.67	\$66.36	\$73.43	60"	72"	Custom Len.
\$80.24	\$81.50	See Web				

RG174A/U Coax, 50 Ohm						
Part No.	PE3178			Cable Dia.	Attn. @ 1 GHz	Power @ 1 GHz
1 piece price shown. See web or call for volume pricing.						
12"	24"	36"	48"	0.11" dia.	32 dB/100ft	17 W
\$62.07	\$59.04	\$63.34	\$59.99	60"	72"	Custom Len.
\$60.45	\$65.30	See Web				

RG178B/U Coax, 50 Ohm						
Part No.	PE34248			Cable Dia.	Attn. @ 1 GHz	Power @ 1 GHz
1 piece price shown. See web or call for volume pricing.						
12"	24"	36"	48"	0.072" dia.	44.4 dB/100ft	78 W
\$77.25	\$78.41	\$74.97	\$76.04	60"	72"	Custom Len.
\$77.07	\$78.13	See Web				

RG188A/U Coax, 50 Ohm						
Part No.	PE33361			Cable Dia.	Attn. @ 1 GHz	Power @ 1 GHz
1 piece price shown. See web or call for volume pricing.						
12"	24"	36"	48"	0.11" dia.	26 dB/100ft	160 W
\$60.57	\$63.01	\$65.44	\$67.89	60"	72"	Custom Len.
\$70.33	\$72.76	See Web				

RG213/U Coax, 50 Ohm						
Part No.	PE33673			Cable Dia.	Attn. @ 1 GHz	Power @ 1 GHz
1 piece price shown. See web or call for volume pricing.						
12"	24"	36"	48"	0.405" dia.	8 dB/100ft	190 W
\$135.92	\$137.71	\$139.52	\$141.31	60"	72"	Custom Len.
\$143.12	\$144.92	See Web				

\*Coax Performance at 1 GHz Notes: Cable assembly max frequency may be lower than connector or coax max frequency



# For our complete selection of cable assemblies, please visit our website

RG214/U Coax, 50 Ohm						
Part No. <b>PE3176</b>			Cable Dia.	Attn. @ 1 GHz	Power @ 1 GHz	
1 piece price shown. See web or call for volume pricing.						
12"	24"	36"	48"	60"	72"	Custom Len.
\$151.58	\$159.51	\$167.48	\$175.40	\$183.34	\$191.29	See Web
RG223/U Coax, 50 Ohm						
Part No. <b>PE3535</b>			Cable Dia.	Attn. @ 1 GHz	Power @ 1 GHz	
1 piece price shown. See web or call for volume pricing.						
12"	24"	36"	48"	60"	72"	Custom Len.
\$51.13	\$54.09	\$57.50	\$61.14	\$60.56	\$68.12	See Web
RG316/U Coax, 50 Ohm						
Part No. <b>PE3174</b>			Cable Dia.	Attn. @ 1 GHz	Power @ 1 GHz	
1 piece price shown. See web or call for volume pricing.						
12"	24"	36"	48"	60"	72"	Custom Len.
\$66.52	\$69.97	\$73.41	\$77.04	\$80.54	\$84.04	See Web
RG316-DS Coax, 50 Ohm						
Part No. <b>PE34246</b>			Cable Dia.	Attn. @ 1 GHz	Power @ 1 GHz	
1 piece price shown. See web or call for volume pricing.						
12"	24"	36"	48"	60"	72"	Custom Len.
\$55.19	\$58.40	\$61.60	\$64.79	\$67.99	\$78.23	See Web
RG393/U Coax, 50 Ohm						
Part No. <b>PE34253</b>			Cable Dia.	Attn. @ 1 GHz	Power @ 1 GHz	
1 piece price shown. See web or call for volume pricing.						
12"	24"	36"	48"	60"	72"	Custom Len.
\$151.91	\$168.82	\$185.68	\$202.58	\$219.51	\$236.40	See Web
RG400/U Coax, 50 Ohm						
Part No. <b>PE33948</b>			Cable Dia.	Attn. @ 1 GHz	Power @ 1 GHz	
1 piece price shown. See web or call for volume pricing.						
12"	24"	36"	48"	60"	72"	Custom Len.
\$63.58	\$71.72	\$79.84	\$88.45	\$96.73	\$98.30	See Web
PE-P195 Coax, 50 Ohm						
Part No. <b>PE33396</b>			Cable Dia.	Attn. @ 1 GHz	Power @ 1 GHz	
1 piece price shown. See web or call for volume pricing.						
12"	24"	36"	48"	60"	-	Custom Len.
\$53.13	\$62.39	\$76.85	\$81.83	\$98.73	-	See Web
LMR-240 Coax, 50 Ohm						
Part No. <b>PE3CA1064</b>			Cable Dia.	Attn. @ 1 GHz	Power @ 1 GHz	
1 piece price shown. See web or call for volume pricing.						
12"	24"	36"	48"	60"	72"	Custom Len.
Call	Call	Call	Call	Call	Call	See Web
LMR-400 Coax, 50 Ohm						
Part No. <b>PE3CA1080</b>			Cable Dia.	Attn. @ 1 GHz	Power @ 1 GHz	
1 piece price shown. See web or call for volume pricing.						
12"	24"	36"	48"	60"	72"	Custom Len.
Call	Call	Call	Call	Call	Call	See Web
M17/60-RG142-27478 Coax, 50 Ohm						
Part No. <b>PE3M0026</b>			Cable Dia.	Attn. @ 1 GHz	Power @ 1 GHz	
1 piece price shown. See web or call for volume pricing.						
12"	18"	24"	30"	36"	48"	Custom Len.
\$203.73	\$206.69	\$209.65	\$212.59	\$215.55	\$221.47	See Web
M17/84-RG223-0XDS2 Coax, 50 Ohm						
Part No. <b>PE3M0054</b>			Cable Dia.	Attn. @ 1 GHz	Power @ 1 GHz	
1 piece price shown. See web or call for volume pricing.						
12"	18"	24"	30"	36"	48"	Custom Len.
\$208.38	\$213.68	\$218.97	\$224.25	\$229.56	\$240.12	See Web
M17/128-RG400-27478 Coax, 50 Ohm						
Part No. <b>PE3M0082</b>			Cable Dia.	Attn. @ 1 GHz	Power @ 1 GHz	
1 piece price shown. See web or call for volume pricing.						
12"	18"	24"	30"	36"	48"	Custom Len.
\$205.34	\$209.11	\$212.87	\$216.63	\$220.39	\$227.91	See Web
M17/113-RG316-27478 Coax, 50 Ohm						
Part No. <b>PE3M0096</b>			Cable Dia.	Attn. @ 1 GHz	Power @ 1 GHz	
1 piece price shown. See web or call for volume pricing.						
6"	8"	12"	16"	18"	24"	Custom Len.
\$195.98	\$196.33	\$197.06	\$197.79	\$198.15	\$199.23	See Web
M17/119-RG174-0XDS2 Coax, 50 Ohm						
Part No. <b>PE3M0111</b>			Cable Dia.	Attn. @ 1 GHz	Power @ 1 GHz	
1 piece price shown. See web or call for volume pricing.						
6"	8"	12"	16"	18"	24"	Custom Len.
\$195.32	\$195.44	\$195.73	\$196.01	\$196.16	\$196.58	See Web
M17/28-RG058-0XDS2 Coax, 50 Ohm						
Part No. <b>PE3M0122</b>			Cable Dia.	Attn. @ 1 GHz	Power @ 1 GHz	
1 piece price shown. See web or call for volume pricing.						
12"	18"	24"	30"	36"	48"	Custom Len.
\$316.07	\$316.70	\$317.36	\$318.00	\$318.66	\$319.96	See Web
RG55B/U Coax, 53 Ohm						
Part No. <b>PE34250</b>			Cable Dia.	Attn. @ 1 GHz	Power @ 1 GHz	
1 piece price shown. See web or call for volume pricing.						
12"	24"	36"	48"	60"	72"	Custom Len.
\$47.29	\$49.76	\$52.26	\$54.24	\$56.72	\$59.17	See Web
RG59B/U Coax, 75 Ohm						
Part No. <b>PE36848</b>			Cable Dia.	Attn. @ 1 GHz	Power @ 1 GHz	
1 piece price shown. See web or call for volume pricing.						
12"	24"	36"	48"	60"	-	Custom Len.
\$53.98	\$54.53	\$57.90	\$56.63	\$57.70	-	See Web

RG179B/U Coax, 75 Ohm						
Part No. <b>PE34255</b>			Cable Dia.	Attn. @ 1 GHz	Power @ 1 GHz	
1 piece price shown. See web or call for volume pricing.						
12"	24"	36"	48"	60"	72"	Custom Len.
\$60.86	\$63.47	\$66.08	\$68.66	\$71.26	\$73.86	See Web
Standard Semi-Rigid Cable Assemblies						
PE-SR047AL Coax, 50 Ohm						
Part No. <b>PE34410</b>			Cable Dia.	Attn. @ 1 GHz	Power @ 1 GHz	
1 piece price shown. See web or call for volume pricing.						
6"	12"	18"	24"	36"	48"	Custom Len.
\$87.99	\$92.81	\$97.62	\$102.51	\$110.58	\$120.16	See Web
PE-SR402AL Coax, 50 Ohm						
Part No. <b>PE34406</b>			Cable Dia.	Attn. @ 1 GHz	Power @ 1 GHz	
1 piece price shown. See web or call for volume pricing.						
6"	12"	18"	24"	36"	48"	Custom Len.
\$76.78	\$82.21	\$82.58	\$87.60	\$97.62	\$107.65	See Web
PE-SR405AL Coax, 50 Ohm						
Part No. <b>PE34414</b>			Cable Dia.	Attn. @ 1 GHz	Power @ 1 GHz	
1 piece price shown. See web or call for volume pricing.						
6"	12"	18"	24"	36"	48"	Custom Len.
\$68.39	\$73.01	\$77.62	\$82.18	\$91.43	\$100.59	See Web
RG401/U Coax, 50 Ohm						
Part No. <b>PE34418</b>			Cable Dia.	Attn. @ 1 GHz	Power @ 1 GHz	
1 piece price shown. See web or call for volume pricing.						
6"	12"	18"	24"	36"	48"	Custom Len.
\$162.34	\$174.27	\$175.92	\$187.50	\$210.60	\$233.62	See Web
RG402/U Coax, 50 Ohm						
Part No. <b>PE3089</b>			Cable Dia.	Attn. @ 1 GHz	Power @ 1 GHz	
1 piece price shown. See web or call for volume pricing.						
6"	12"	18"	24"	36"	48"	Custom Len.
\$78.35	\$78.35	\$82.35	\$86.37	\$94.41	\$102.44	See Web
RG405/U Coax, 50 Ohm						
Part No. <b>PE33420</b>			Cable Dia.	Attn. @ 1 GHz	Power @ 1 GHz	
1 piece price shown. See web or call for volume pricing.						
6"	12"	18"	24"	36"	48"	Custom Len.
\$76.78	\$76.78	\$85.48	\$84.35	\$91.90	\$99.44	See Web
PE-SR401AL-STRAIGHT Coax, 50 Ohm						
Part No. <b>PE34420</b>			Cable Dia.	Attn. @ 1 GHz	Power @ 1 GHz	
1 piece price shown. See web or call for volume pricing.						
6"	12"	18"	24"	36"	48"	Custom Len.
\$174.57	\$170.00	\$179.83	\$189.66	\$209.33	\$229.01	See Web
PE-047SR Coax, 50 Ohm						
Part No. <b>PE34408</b>			Cable Dia.	Attn. @ 1 GHz	Power @ 1 GHz	
1 piece price shown. See web or call for volume pricing.						
6"	12"	18"	24"	36"	48"	Custom Len.
\$88.59	\$94.05	\$99.53	\$104.95	\$114.29	\$125.04	See Web
SMA MALE TO TNC MALE RIGHT ANGLE						
						
Low Loss Flexible Cable Assemblies						
PE-P142LL Coax, 50 Ohm						
Part No. <b>PE3C0780</b>			Cable Dia.	Attn. @ 1 GHz	Power @ 1 GHz	
1 piece price shown. See web or call for volume pricing.						
12"	24"	36"	48"	60"	50CM	Custom Len.
\$243.96	\$261.57	\$279.15	\$296.76	\$314.36	\$255.24	See Web
PE-P160LL Coax, 50 Ohm						
Part No. <b>PE3C5259</b>			Cable Dia.	Attn. @ 1 GHz	Power @ 1 GHz	
1 piece price shown. See web or call for volume pricing.						
12"	24"	36"	48"	60"	50CM	Custom Len.
\$286.46	\$308.91	\$331.37	\$353.83	\$376.28	\$300.85	See Web
PE-P142LL-27478 Coax, 50 Ohm						
Part No. <b>PE3M0131</b>			Cable Dia.	Attn. @ 1 GHz	Power @ 1 GHz	
1 piece price shown. See web or call for volume pricing.						
12"	18"	24"	36"	48"	60"	Custom Len.
\$513.86	\$523.05	\$532.24	\$550.62	\$569.00	\$587.40	See Web
PE-P160LL-27478 Coax, 50 Ohm						
Part No. <b>PE3M0185</b>			Cable Dia.	Attn. @ 1 GHz	Power @ 1 GHz	
1 piece price shown. See web or call for volume pricing.						
8"	12"	18"	24"	30"	36"	Custom Len.
\$475.62	\$480.94	\$488.90	\$496.87	\$504.85	\$512.81	See Web
PE-P300LL-27478 Coax, 50 Ohm						
Part No. <b>PE3M0228</b>			Cable Dia.	Attn. @ 1 GHz	Power @ 1 GHz	
1 piece price shown. See web or call for volume pricing.						
12"	18"	24"	36"	48"	60"	Custom Len.
\$591.67	\$607.01	\$622.36	\$653.04	\$683.72	\$714.41	See Web
Standard Formable Cable Assemblies						
PE-SR405FLJ Coax, 50 Ohm						
Part No. <b>PE3W07181</b>			Cable Dia.	Attn. @ 1 GHz	Power @ 1 GHz	
1 piece price shown. See web or call for volume pricing.						
12"	24"	36"	48"	60"	50CM	Custom Len.
\$54.43	\$63.77	\$73.61	\$83.46	\$93.31	\$60.24	See Web

Cable Assemblies

See Our Website For Current Pricing & Real-Time Stock Availability!

For Custom Lengths, Metric Lengths or Special Configurations, Please call (949) 261-1920



Technical Support  
+1 (949) 261-1920



Same-Day Shipping,  
Even Custom Cable Assemblies



For our complete selection of cable assemblies, please visit our website

**SMA MALE TO TNC FEMALE**



**Flexible Cable Assemblies**

**LMR-195-FR Coax, 50 Ohm**

Part No. <a href="#">PE3C5480</a>	Cable Dia.	Attn. @ 1 GHz	Power @ 1 GHz
1 piece price shown. See web or call for volume pricing.			
12"	24"	36"	48"
\$43.56	\$42.22	\$43.34	\$44.46
60"	50CM	\$45.57	\$41.81
			See Web

89

**SMA MALE TO TNC FEMALE BULKHEAD**



SEE MOUNTING HOLE SECTION ON PAGE 409

**Low Loss Flexible Cable Assemblies**

**LMR-195 Coax, 50 Ohm**

Part No. <a href="#">PE3W02172</a>	Cable Dia.	Attn. @ 1 GHz	Power @ 1 GHz
1 piece price shown. See web or call for volume pricing.			
12"	24"	36"	48"
\$43.19	\$43.88	\$44.22	\$44.90
60"	50CM	\$45.59	\$43.28
			See Web

90

**PE-P142LL Coax, 50 Ohm**

Part No. <a href="#">PE3C2449</a>	Cable Dia.	Attn. @ 1 GHz	Power @ 1 GHz
1 piece price shown. See web or call for volume pricing.			
12"	24"	36"	48"
\$193.80	\$211.41	\$229.01	\$246.62
60"	50CM	\$264.22	\$205.08
			See Web

91

**PE-P142LL-27478 Coax, 50 Ohm**

Part No. <a href="#">PE3M0130</a>	Cable Dia.	Attn. @ 1 GHz	Power @ 1 GHz
1 piece price shown. See web or call for volume pricing.			
12"	18"	24"	36"
\$483.70	\$492.88	\$502.07	\$520.46
48"	60"	\$538.84	\$557.22
			See Web

92

**PE-P160LL-27478 Coax, 50 Ohm**

Part No. <a href="#">PE3M0184</a>	Cable Dia.	Attn. @ 1 GHz	Power @ 1 GHz
1 piece price shown. See web or call for volume pricing.			
8"	12"	18"	24"
\$471.35	\$476.67	\$484.63	\$492.60
30"	36"	\$500.58	\$508.55
			See Web

93

**Precision Formable Cable Assemblies**

**PE-SR405FL Coax, 50 Ohm**

Part No. <a href="#">PE39475</a>	Cable Dia.	Attn. @ 1 GHz	Power @ 1 GHz
1 piece price shown. See web or call for volume pricing.			
6"	9"	12"	18"
\$57.24	\$54.22	\$57.24	\$63.63
24"	-	Call	-
			See Web

94

**PE-SR405FLJ Coax, 50 Ohm**

Part No. <a href="#">PE39489</a>	Cable Dia.	Attn. @ 1 GHz	Power @ 1 GHz
1 piece price shown. See web or call for volume pricing.			
6"	9"	12"	18"
\$53.12	\$50.10	\$53.12	Call
24"	-	\$62.49	-
			See Web

95

**Standard Formable Cable Assemblies**

**PE-SR402FL Coax, 50 Ohm**

Part No. <a href="#">PE39483</a>	Cable Dia.	Attn. @ 1 GHz	Power @ 1 GHz
1 piece price shown. See web or call for volume pricing.			
6"	9"	12"	18"
\$53.55	\$50.52	\$53.55	\$57.66
24"	-	\$62.23	-
			See Web

96

**PE-SR402FLJ Coax, 50 Ohm**

Part No. <a href="#">PE39497</a>	Cable Dia.	Attn. @ 1 GHz	Power @ 1 GHz
1 piece price shown. See web or call for volume pricing.			
6"	9"	12"	18"
\$60.19	\$56.78	\$60.19	Call
24"	-	\$70.06	-
			See Web

97

**Standard Flexible Cable Assemblies**

**RG316/U Coax, 50 Ohm**

Part No. <a href="#">PE3W05224</a>	Cable Dia.	Attn. @ 1 GHz	Power @ 1 GHz
1 piece price shown. See web or call for volume pricing.			
12"	24"	36"	48"
\$59.59	\$63.20	\$66.80	\$70.41
60"	50CM	\$74.03	\$61.90
			See Web

98

**SMA MALE TO REVERSE POLARITY TNC MALE**



**Low Loss Flexible Cable Assemblies**

**PE-C195 Coax, 50 Ohm**

Part No. <a href="#">PE37120</a>	Cable Dia.	Attn. @ 1 GHz	Power @ 1 GHz
1 piece price shown. See web or call for volume pricing.			
12"	24"	36"	48"
\$47.99	\$44.42	\$45.22	\$46.00
60"	-	\$51.53	-
			See Web

99

**Standard Flexible Cable Assemblies**

**RG58C/U Coax, 50 Ohm**

Part No. <a href="#">PE34853</a>	Cable Dia.	Attn. @ 1 GHz	Power @ 1 GHz
1 piece price shown. See web or call for volume pricing.			
12"	24"	36"	48"
\$50.95	\$51.76	\$52.59	\$53.40
60"	72"	\$54.21	\$54.53
			See Web

1

**RG142B/U Coax, 50 Ohm**

Part No. <a href="#">PE34854</a>	Cable Dia.	Attn. @ 1 GHz	Power @ 1 GHz
1 piece price shown. See web or call for volume pricing.			
12"	24"	36"	48"
\$52.04	\$62.37	\$69.06	\$70.47
60"	72"	\$82.94	\$83.09
			See Web

2

**RG178B/U Coax, 50 Ohm**

Part No. <a href="#">PE35242</a>	Cable Dia.	Attn. @ 1 GHz	Power @ 1 GHz
1 piece price shown. See web or call for volume pricing.			
12"	24"	36"	48"
\$70.83	\$71.88	\$72.95	\$74.02
60"	72"	\$75.04	\$76.10
			See Web

3

**RG188A/U Coax, 50 Ohm**

Part No. <a href="#">PE35244</a>	Cable Dia.	Attn. @ 1 GHz	Power @ 1 GHz
1 piece price shown. See web or call for volume pricing.			
12"	24"	36"	48"
\$57.84	\$60.15	\$62.52	\$64.83
60"	72"	\$67.21	\$69.59
			See Web

4

**RG223/U Coax, 50 Ohm**

Part No. <a href="#">PE34397</a>	Cable Dia.	Attn. @ 1 GHz	Power @ 1 GHz
1 piece price shown. See web or call for volume pricing.			
12"	24"	36"	48"
\$48.83	\$52.04	\$54.75	\$57.94
60"	72"	\$61.13	\$64.32
			See Web

5

**RG316/U Coax, 50 Ohm**

Part No. <a href="#">PE34396</a>	Cable Dia.	Attn. @ 1 GHz	Power @ 1 GHz
1 piece price shown. See web or call for volume pricing.			
12"	24"	36"	48"
\$58.77	\$66.89	\$70.33	\$68.65
60"	72"	\$71.94	\$75.26
			See Web

6

**RG400/U Coax, 50 Ohm**

Part No. <a href="#">PE35246</a>	Cable Dia.	Attn. @ 1 GHz	Power @ 1 GHz
1 piece price shown. See web or call for volume pricing.			
12"	24"	36"	48"
\$55.06	\$62.77	\$70.51	\$78.23
60"	72"	\$85.93	\$93.67
			See Web

7

**SMA MALE TO HMCX32 1.2 PLUG**



**Standard Flexible Cable Assemblies**

**PE-81mm Coax, 50 Ohm**

Part No. <a href="#">PE3CA1030</a>	Cable Dia.	Attn. @ 1 GHz	Power @ 1 GHz
1 piece price shown. See web or call for volume pricing.			
3"	6"	12"	-
\$12.80	\$14.76	\$14.76	-
-	-	-	Custom Len.
			See Web

8

**SMA MALE TO UMCX PLUG**



**Standard Flexible Cable Assemblies**

**RG178B/U Coax, 50 Ohm**

Part No. <a href="#">PE38881</a>	Cable Dia.	Attn. @ 1 GHz	Power @ 1 GHz
1 piece price shown. See web or call for volume pricing.			
3"	6"	9"	12"
\$71.74	\$73.62	\$75.51	\$77.39
18"	24"	\$81.27	\$85.15
			See Web

9

**SMA MALE TO UMCX 2.1 PLUG**



**Standard Flexible Cable Assemblies**

**PE-81mm Coax, 50 Ohm**

Part No. <a href="#">PE3CA1028</a>	Cable Dia.	Attn. @ 1 GHz	Power @ 1 GHz
1 piece price shown. See web or call for volume pricing.			
3"	6"	12"	18"
\$17.35	\$16.63	\$14.76	Call
-	-	-	Custom Len.
			See Web

10

**SMA MALE TO UMCX 2.5 PLUG**



**Standard Flexible Cable Assemblies**

**RG178-DS Coax, 50 Ohm**

Part No. <a href="#">PE3CA1027</a>	Cable Dia.	Attn. @ 1 GHz	Power @ 1 GHz
1 piece price shown. See web or call for volume pricing.			
3"	6"	9"	12"
\$13.00	\$22.89	\$12.80	\$16.03
18"	Call	-	-
			See Web

11

**PE-81mm Coax, 50 Ohm**

Part No. <a href="#">PE3CA1023</a>	Cable Dia.	Attn. @ 1 GHz	Power @ 1 GHz
1 piece price shown. See web or call for volume pricing.			
3"	6"	12"	-
\$12.93	\$12.80	\$16.63	-
-	-	-	Custom Len.
			See Web

12

**PE-113mm Coax, 50 Ohm**

Part No. <a href="#">PE3CA1024</a>	Cable Dia.	Attn. @ 1 GHz	Power @ 1 GHz
1 piece price shown. See web or call for volume pricing.			
3"	6"	25CM	12"
\$16.10	\$16.10	Call	\$16.10
18"	-	-	\$17.49
			See Web

13

Cable Assemblies See Our Website For Current Pricing & Real-Time Stock Availability!

\*Coax Performance at 1 GHz Notes: Cable assembly max frequency may be lower than connector or coax max frequency

For our complete selection of cable assemblies, please visit our website

PE-137mm Coax, 50 Ohm							
Part No. <a href="#">PE3CA1025</a>				Cable Dia.	Attn. @ 1 GHz	Power @ 1 GHz	14
1 piece price shown. See web or call for volume pricing.				0.053" dia.	-	-	
3"	6"	12"	-	-	-	Custom Len.	
\$16.63	\$14.76	\$14.48	-	-	-	See Web	

RG178B/U Coax, 50 Ohm							
Part No. <a href="#">PE3CA1026</a>				Cable Dia.	Attn. @ 1 GHz	Power @ 1 GHz	15
1 piece price shown. See web or call for volume pricing.				0.07" dia.	-	-	
3"	4"	6"	9"	12"	44CM	Custom Len.	
Call	Call	\$12.80	\$14.76	\$14.76	Call	See Web	

**SMA MALE TO WMCX 1.6 PLUG**



**Standard Flexible Cable Assemblies**

PE-81mm Coax, 50 Ohm							
Part No. <a href="#">PE3CA1029</a>				Cable Dia.	Attn. @ 1 GHz	Power @ 1 GHz	16
1 piece price shown. See web or call for volume pricing.				0.032" dia.	-	-	
3"	6"	12"	-	-	-	Custom Len.	
\$14.76	\$14.76	\$14.76	-	-	-	See Web	

**SMA MALE TO NEX10 MALE**



**Low PIM Corrugated Cable Assemblies**

SPP-250-LLPL Coax, 50 Ohm							
Part No. <a href="#">PE3C6258</a>				Cable Dia.	Attn. @ 1 GHz	Power @ 1 GHz	17
1 piece price shown. See web or call for volume pricing.				0.28" dia.	5.5 dB/100ft	650 W	
12"	24"	36"	48"	60"	50CM	Custom Len.	
\$60.92	\$67.05	\$73.19	\$79.32	\$85.45	\$64.84	See Web	

**REVERSE POLARITY SMA MALE TO BNC MALE**



**Standard Flexible Cable Assemblies**

RG58C/U Coax, 50 Ohm							
Part No. <a href="#">PE35207</a>				Cable Dia.	Attn. @ 1 GHz	Power @ 1 GHz	18
1 piece price shown. See web or call for volume pricing.				0.195" dia.	20 dB/100ft	44 W	
12"	24"	36"	48"	60"	72"	Custom Len.	
\$55.47	\$60.82	\$61.72	\$57.91	\$58.72	\$59.52	See Web	

RG142B/U Coax, 50 Ohm							
Part No. <a href="#">PE35209</a>				Cable Dia.	Attn. @ 1 GHz	Power @ 1 GHz	19
1 piece price shown. See web or call for volume pricing.				0.195" dia.	13 dB/100ft	650 W	
12"	24"	36"	48"	60"	72"	Custom Len.	
\$51.46	\$57.30	\$63.61	\$75.51	\$76.19	\$82.52	See Web	

RG174A/U Coax, 50 Ohm							
Part No. <a href="#">PE3C3332</a>				Cable Dia.	Attn. @ 1 GHz	Power @ 1 GHz	20
1 piece price shown. See web or call for volume pricing.				0.11" dia.	32 dB/100ft	17 W	
12"	24"	36"	48"	60"	72"	Custom Len.	
\$47.78	\$53.20	\$48.67	\$49.19	\$49.64	\$50.16	See Web	

RG178B/U Coax, 50 Ohm							
Part No. <a href="#">PE35213</a>				Cable Dia.	Attn. @ 1 GHz	Power @ 1 GHz	21
1 piece price shown. See web or call for volume pricing.				0.072" dia.	44.4 dB/100ft	78 W	
12"	24"	36"	48"	60"	72"	Custom Len.	
\$75.58	\$76.65	\$77.69	\$78.75	\$84.87	\$80.86	See Web	

RG188A/U Coax, 50 Ohm							
Part No. <a href="#">PE3C3412</a>				Cable Dia.	Attn. @ 1 GHz	Power @ 1 GHz	22
1 piece price shown. See web or call for volume pricing.				0.11" dia.	26 dB/100ft	160 W	
12"	24"	36"	48"	60"	72"	Custom Len.	
\$49.59	\$51.82	\$54.12	\$55.92	\$58.14	\$60.42	See Web	

RG223/U Coax, 50 Ohm							
Part No. <a href="#">PE35217</a>				Cable Dia.	Attn. @ 1 GHz	Power @ 1 GHz	23
1 piece price shown. See web or call for volume pricing.				0.21" dia.	13.4 dB/100ft	53 W	
12"	24"	36"	48"	60"	72"	Custom Len.	
\$51.19	\$51.52	\$57.58	\$57.42	\$60.60	\$63.80	See Web	

RG316/U Coax, 50 Ohm							
Part No. <a href="#">PE3C3413</a>				Cable Dia.	Attn. @ 1 GHz	Power @ 1 GHz	24
1 piece price shown. See web or call for volume pricing.				0.102" dia.	38 dB/100ft	160 W	
12"	24"	36"	48"	60"	72"	Custom Len.	
\$50.47	\$58.43	\$61.88	\$59.52	\$62.71	\$65.88	See Web	

**REVERSE POLARITY SMA MALE TO MCX PLUG RIGHT ANGLE**



**Standard Flexible Cable Assemblies**

RG316/U Coax, 50 Ohm							
Part No. <a href="#">PE3C0481</a>				Cable Dia.	Attn. @ 1 GHz	Power @ 1 GHz	25
1 piece price shown. See web or call for volume pricing.				0.098" dia.	38 dB/100ft	160 W	
12"	24"	36"	48"	60"	72"	Custom Len.	
\$63.81	\$67.26	\$66.54	\$69.72	\$77.83	\$76.08	See Web	

**REVERSE POLARITY SMA MALE TO N MALE**



**Low Loss Flexible Cable Assemblies**

PE-C195 Coax, 50 Ohm							
Part No. <a href="#">PE36072</a>				Cable Dia.	Attn. @ 1 GHz	Power @ 1 GHz	26
1 piece price shown. See web or call for volume pricing.				0.195" dia.	11.3 dB/100ft	150 W	
12"	24"	36"	48"	60"	-	Custom Len.	
\$53.84	\$54.12	\$54.90	\$55.70	\$56.49	-	See Web	

**Standard Flexible Cable Assemblies**

RG58C/U Coax, 50 Ohm							
Part No. <a href="#">PE34727</a>				Cable Dia.	Attn. @ 1 GHz	Power @ 1 GHz	27
1 piece price shown. See web or call for volume pricing.				0.195" dia.	20 dB/100ft	44 W	
12"	24"	36"	48"	60"	72"	Custom Len.	
\$59.48	\$60.29	\$66.03	\$61.91	\$62.72	\$63.54	See Web	

RG142B/U Coax, 50 Ohm							
Part No. <a href="#">PE34361</a>				Cable Dia.	Attn. @ 1 GHz	Power @ 1 GHz	28
1 piece price shown. See web or call for volume pricing.				0.195" dia.	13 dB/100ft	650 W	
12"	24"	36"	48"	60"	72"	Custom Len.	
\$62.94	\$65.66	\$76.29	\$83.37	\$84.57	\$96.99	See Web	

RG174A/U Coax, 50 Ohm							
Part No. <a href="#">PE35221</a>				Cable Dia.	Attn. @ 1 GHz	Power @ 1 GHz	29
1 piece price shown. See web or call for volume pricing.				0.1" dia.	32 dB/100ft	16 W	
12"	24"	36"	48"	60"	72"	Custom Len.	
\$60.96	\$66.48	\$61.92	\$62.41	\$62.87	\$63.35	See Web	

RG178B/U Coax, 50 Ohm							
Part No. <a href="#">PE35223</a>				Cable Dia.	Attn. @ 1 GHz	Power @ 1 GHz	30
1 piece price shown. See web or call for volume pricing.				0.072" dia.	44.4 dB/100ft	78 W	
12"	24"	36"	48"	60"	72"	Custom Len.	
\$81.06	\$87.09	\$83.19	\$84.23	\$85.28	\$86.34	See Web	

RG188A/U Coax, 50 Ohm							
Part No. <a href="#">PE35225</a>				Cable Dia.	Attn. @ 1 GHz	Power @ 1 GHz	31
1 piece price shown. See web or call for volume pricing.				0.11" dia.	26 dB/100ft	160 W	
12"	24"	36"	48"	60"	72"	Custom Len.	
\$66.73	\$65.38	\$67.83	\$70.26	\$72.69	\$75.15	See Web	

RG223/U Coax, 50 Ohm							
Part No. <a href="#">PE35227</a>				Cable Dia.	Attn. @ 1 GHz	Power @ 1 GHz	32
1 piece price shown. See web or call for volume pricing.				0.21" dia.	13.4 dB/100ft	53 W	
12"	24"	36"	48"	60"	72"	Custom Len.	
\$56.27	\$59.46	\$62.66	\$70.11	\$73.61	\$72.20	See Web	

RG316/U Coax, 50 Ohm							
Part No. <a href="#">PE34770</a>				Cable Dia.	Attn. @ 1 GHz	Power @ 1 GHz	33
1 piece price shown. See web or call for volume pricing.				0.098" dia.	38 dB/100ft	160 W	
12"	24"	36"	48"	60"	72"	Custom Len.	
\$67.73	\$67.07	\$70.26	\$73.44	\$76.60	\$79.77	See Web	

RG400/U Coax, 50 Ohm							
Part No. <a href="#">PE34323</a>				Cable Dia.	Attn. @ 1 GHz	Power @ 1 GHz	34
1 piece price shown. See web or call for volume pricing.				0.195" dia.	14.7 dB/100ft	650 W	
12"	24"	36"	48"	60"	-	Custom Len.	
\$67.44	\$71.28	\$83.72	\$86.61	\$100.59	-	See Web	

PE-P195 Coax, 50 Ohm							
Part No. <a href="#">PE35508</a>				Cable Dia.	Attn. @ 1 GHz	Power @ 1 GHz	35
1 piece price shown. See web or call for volume pricing.				0.195" dia.	12.5 dB/100ft	650 W	
12"	24"	36"	48"	60"	-	Custom Len.	
\$68.23	\$77.97	\$87.70	\$97.43	\$107.17	-	See Web	

**REVERSE POLARITY SMA MALE TO N FEMALE BULKHEAD**



SEE MOUNTING HOLE SECTION ON PAGE 409

**Standard Flexible Cable Assemblies**

RG58C/U Coax, 50 Ohm							
Part No. <a href="#">PE3W02336</a>				Cable Dia.	Attn. @ 1 GHz	Power @ 1 GHz	36
1 piece price shown. See web or call for volume pricing.				0.195" dia.	20 dB/100ft	80 W	
12"	24"	36"	48"	60"	50CM	Custom Len.	
\$61.78	\$62.63	\$63.49	\$64.36	\$65.22	\$62.33	See Web	

RG142B/U Coax, 50 Ohm							
Part No. <a href="#">PE34575</a>				Cable Dia.	Attn. @ 1 GHz	Power @ 1 GHz	37
1 piece price shown. See web or call for volume pricing.				0.195" dia.	13 dB/100ft	650 W	
12"	24"	36"	48"	60"	-	Custom Len.	
\$64.19	\$70.49	\$76.77	\$83.10	\$89.39	-	See Web	

**REVERSE POLARITY SMA MALE TO REVERSE POLARITY SMA MALE**



**Standard Flexible Cable Assemblies**

RG142B/U Coax, 50 Ohm							
Part No. <a href="#">PE34750</a>				Cable Dia.	Attn. @ 1 GHz	Power @ 1 GHz	38
1 piece price shown. See web or call for volume pricing.				0.195" dia.	13 dB/100ft	650 W	
12"	18"	24"	36"	48"	60"	Custom Len.	
\$61.21	\$64.55	\$67.89	\$74.58	\$76.09	\$82.21	See Web	

Cable Assemblies

See Our Website For Current Pricing & Real-Time Stock Availability!

For Custom Lengths, Metric Lengths or Special Configurations, Please call (949) 261-1920



Technical Support  
+1 (949) 261-1920



Same-Day Shipping,  
Even Custom Cable Assemblies

For our complete selection of cable assemblies, please visit our website

**REVERSE POLARITY SMA MALE TO REVERSE POLARITY SMA FEMALE**



**Standard Flexible Cable Assemblies**

RG141A/U Coax, 50 Ohm						
Part No.	Cable Dia.			Attn. @ 1 GHz	Power @ 1 GHz	
Part No. <a href="#">PE3C5980</a>	0.195" dia.			13 dB/100ft	650 W	
1 piece price shown. See web or call for volume pricing.	12"	24"	36"	48"	60"	72"
\$85.55	\$101.03	\$107.62	\$115.61	\$123.62	\$98.11	See Web

39

**REVERSE POLARITY SMA MALE TO TNC MALE**



**Standard Flexible Cable Assemblies**

RG58C/U Coax, 50 Ohm						
Part No.	Cable Dia.			Attn. @ 1 GHz	Power @ 1 GHz	
Part No. <a href="#">PE35214</a>	0.195" dia.			20 dB/100ft	44 W	
1 piece price shown. See web or call for volume pricing.	12"	24"	36"	48"	60"	72"
\$60.61	\$61.50	\$57.74	\$58.55	\$59.37	\$60.17	See Web

40

RG142B/U Coax, 50 Ohm						
Part No.	Cable Dia.			Attn. @ 1 GHz	Power @ 1 GHz	
Part No. <a href="#">PE35216</a>	0.195" dia.			13 dB/100ft	650 W	
1 piece price shown. See web or call for volume pricing.	12"	24"	36"	48"	60"	72"
\$57.82	\$64.14	\$70.43	\$76.74	\$83.02	\$89.34	See Web

41

RG174A/U Coax, 50 Ohm						
Part No.	Cable Dia.			Attn. @ 1 GHz	Power @ 1 GHz	
Part No. <a href="#">PE35218</a>	0.1" dia.			32 dB/100ft	16 W	
1 piece price shown. See web or call for volume pricing.	12"	24"	36"	48"	60"	72"
\$60.86	\$61.34	\$61.86	\$62.33	\$62.77	\$63.30	See Web

42

RG178B/U Coax, 50 Ohm						
Part No.	Cable Dia.			Attn. @ 1 GHz	Power @ 1 GHz	
Part No. <a href="#">PE35220</a>	0.072" dia.			44.4 dB/100ft	78 W	
1 piece price shown. See web or call for volume pricing.	12"	24"	36"	48"	60"	72"
\$78.29	\$87.28	\$80.40	\$81.45	\$82.53	\$83.56	See Web

43

RG188A/U Coax, 50 Ohm						
Part No.	Cable Dia.			Attn. @ 1 GHz	Power @ 1 GHz	
Part No. <a href="#">PE35222</a>	0.11" dia.			26 dB/100ft	160 W	
1 piece price shown. See web or call for volume pricing.	12"	24"	36"	48"	60"	72"
\$62.72	\$65.10	\$67.40	\$69.77	\$72.11	\$74.45	See Web

44

RG223/U Coax, 50 Ohm						
Part No.	Cable Dia.			Attn. @ 1 GHz	Power @ 1 GHz	
Part No. <a href="#">PE35224</a>	0.21" dia.			13.4 dB/100ft	53 W	
1 piece price shown. See web or call for volume pricing.	12"	24"	36"	48"	60"	72"
\$54.77	\$57.96	\$61.15	\$64.34	\$67.52	\$70.70	See Web

45

RG316/U Coax, 50 Ohm						
Part No.	Cable Dia.			Attn. @ 1 GHz	Power @ 1 GHz	
Part No. <a href="#">PE35226</a>	0.098" dia.			38 dB/100ft	160 W	
1 piece price shown. See web or call for volume pricing.	12"	24"	36"	48"	60"	72"
\$68.74	\$71.90	\$75.08	\$78.26	\$86.87	\$84.61	See Web

46

**REVERSE THREAD SMA MALE TO REVERSE THREAD SMA MALE**



**Standard Flexible Cable Assemblies**

RG58C/U Coax, 50 Ohm						
Part No.	Cable Dia.			Attn. @ 1 GHz	Power @ 1 GHz	
Part No. <a href="#">PE35349</a>	0.195" dia.			20 dB/100ft	44 W	
1 piece price shown. See web or call for volume pricing.	12"	24"	36"	48"	60"	72"
\$67.67	\$68.53	\$69.32	\$70.11	\$70.91	\$71.71	See Web

47

RG142B/U Coax, 50 Ohm						
Part No.	Cable Dia.			Attn. @ 1 GHz	Power @ 1 GHz	
Part No. <a href="#">PE35353</a>	0.195" dia.			13 dB/100ft	650 W	
1 piece price shown. See web or call for volume pricing.	12"	24"	36"	48"	60"	72"
\$70.83	\$76.90	\$83.02	\$89.10	\$95.19	\$101.32	See Web

48

RG174A/U Coax, 50 Ohm						
Part No.	Cable Dia.			Attn. @ 1 GHz	Power @ 1 GHz	
Part No. <a href="#">PE35357</a>	0.1" dia.			32 dB/100ft	16 W	
1 piece price shown. See web or call for volume pricing.	12"	24"	36"	48"	60"	72"
\$76.13	\$76.63	\$77.10	\$77.57	\$78.05	\$78.53	See Web

49

RG178B/U Coax, 50 Ohm						
Part No.	Cable Dia.			Attn. @ 1 GHz	Power @ 1 GHz	
Part No. <a href="#">PE35361</a>	0.072" dia.			44.4 dB/100ft	78 W	
1 piece price shown. See web or call for volume pricing.	12"	24"	36"	48"	60"	72"
\$72.35	\$73.41	\$74.45	\$75.53	\$76.58	\$85.53	See Web

50

RG188A/U Coax, 50 Ohm						
Part No.	Cable Dia.			Attn. @ 1 GHz	Power @ 1 GHz	
Part No. <a href="#">PE35365</a>	0.11" dia.			26 dB/100ft	160 W	
1 piece price shown. See web or call for volume pricing.	12"	24"	36"	48"	60"	72"
\$73.68	\$76.05	\$78.37	\$80.75	\$83.02	\$85.42	See Web

51

**RG223/U Coax, 50 Ohm**

Part No.	Cable Dia.			Attn. @ 1 GHz	Power @ 1 GHz	
Part No. <a href="#">PE35369</a>	0.21" dia.			13.4 dB/100ft	53 W	
1 piece price shown. See web or call for volume pricing.	12"	24"	36"	48"	60"	72"
\$73.38	\$76.58	\$79.76	\$82.94	\$86.12	\$89.33	See Web

52

**RG316/U Coax, 50 Ohm**

Part No.	Cable Dia.			Attn. @ 1 GHz	Power @ 1 GHz	
Part No. <a href="#">PE35373</a>	0.098" dia.			38 dB/100ft	160 W	
1 piece price shown. See web or call for volume pricing.	12"	24"	36"	48"	60"	72"
\$74.61	\$77.89	\$81.19	\$84.49	\$87.79	\$91.10	See Web

53

**SMA MALE RIGHT ANGLE TO SMA MALE RIGHT ANGLE**



**Standard Flexible Cable Assemblies**

M17/60-RG142-27478 Coax, 50 Ohm						
Part No.	Cable Dia.			Attn. @ 1 GHz	Power @ 1 GHz	
Part No. <a href="#">PE3M0025</a>	0.195" dia.			13 dB/100ft	44 W	
1 piece price shown. See web or call for volume pricing.	12"	18"	24"	30"	36"	48"
\$310.29	\$313.24	\$316.20	\$319.15	\$322.11	\$328.04	See Web

54

M17/84-RG223-0XDS2 Coax, 50 Ohm						
Part No.	Cable Dia.			Attn. @ 1 GHz	Power @ 1 GHz	
Part No. <a href="#">PE3M0053</a>	0.212" dia.					
1 piece price shown. See web or call for volume pricing.	12"	18"	24"	30"	36"	48"
\$314.95	\$320.24	\$325.53	\$330.82	\$336.12	\$346.68	See Web

55

M17/128-RG400-27478 Coax, 50 Ohm						
Part No.	Cable Dia.			Attn. @ 1 GHz	Power @ 1 GHz	
Part No. <a href="#">PE3M0081</a>	0.195" dia.					
1 piece price shown. See web or call for volume pricing.	12"	18"	24"	30"	36"	48"
\$311.90	\$315.66	\$319.43	\$323.18	\$326.95	\$334.48	See Web

56

M17/113-RG316-27478 Coax, 50 Ohm						
Part No.	Cable Dia.			Attn. @ 1 GHz	Power @ 1 GHz	
Part No. <a href="#">PE3M0093</a>	0.098" dia.					
1 piece price shown. See web or call for volume pricing.	6"	8"	12"	16"	18"	24"
\$222.14	\$222.50	\$223.24	\$223.94	\$224.33	\$225.41	See Web

57

M17/119-RG174-0XDS2 Coax, 50 Ohm						
Part No.	Cable Dia.			Attn. @ 1 GHz	Power @ 1 GHz	
Part No. <a href="#">PE3M0108</a>	0.11" dia.					
1 piece price shown. See web or call for volume pricing.	6"	8"	12"	16"	18"	24"
\$221.48	\$221.61	\$221.91	\$222.17	\$222.33	\$222.75	See Web

58

M17/28-RG058-0XDS2 Coax, 50 Ohm						
Part No.	Cable Dia.			Attn. @ 1 GHz	Power @ 1 GHz	
Part No. <a href="#">PE3M0121</a>	0.195" dia.					
1 piece price shown. See web or call for volume pricing.	12"	18"	24"	30"	36"	48"
\$218.78	\$219.42	\$220.08	\$220.70	\$221.37	\$222.66	See Web

59

**SMA MALE RIGHT ANGLE TO SMA FEMALE BULKHEAD**  
SEE MOUNTING HOLE SECTION ON PAGE 409



**Standard Flexible Cable Assemblies**

M17/113-RG316-27478 Coax, 50 Ohm						
Part No.	Cable Dia.			Attn. @ 1 GHz	Power @ 1 GHz	
Part No. <a href="#">PE3M0094</a>	0.098" dia.					
1 piece price shown. See web or call for volume pricing.	6"	8"	12"	16"	18"	24"
\$212.13	\$212.48	\$213.21	\$213.94	\$214.30	\$215.39	See Web

60

M17/119-RG174-0XDS2 Coax, 50 Ohm						
Part No.	Cable Dia.			Attn. @ 1 GHz	Power @ 1 GHz	
Part No. <a href="#">PE3M0109</a>	0.11" dia.					
1 piece price shown. See web or call for volume pricing.	6"	8"	12"	16"	18"	24"
\$211.47	\$211.61	\$211.89	\$212.17	\$212.31	\$212.73	See Web

61

**SMA MALE RIGHT ANGLE TO TNC MALE**



**Standard Flexible Cable Assemblies**

M17/60-RG142-27478 Coax, 50 Ohm						
Part No.	Cable Dia.			Attn. @ 1 GHz	Power @ 1 GHz	
Part No. <a href="#">PE3M0027</a>	0.195" dia.					
1 piece price shown. See web or call for volume pricing.	12"	18"	24"	30"	36"	48"
\$242.86	\$245.81	\$248.76	\$251.71	\$254.68	\$260.59	See Web

62

M17/84-RG223-0XDS2 Coax, 50 Ohm						
Part No.	Cable Dia.			Attn. @ 1 GHz	Power @ 1 GHz	
Part No. <a href="#">PE3M0055</a>	0.212" dia.					
1 piece price shown. See web or call for volume pricing.	12"	18"	24"	30"	36"	48"
\$247.51	\$252.79	\$258.10	\$263.38	\$268.67	\$279.25	See Web

63

M17/128-RG400-27478 Coax, 50 Ohm						
Part No.	Cable Dia.			Attn. @ 1 GHz	Power @ 1 GHz	
Part No. <a href="#">PE3M0083</a>	0.195" dia.					
1 piece price shown. See web or call for volume pricing.	12"	18"	24"	30"	36"	48"
\$244.45	\$248.21	\$251.98	\$255.75	\$259.50	\$267.03	See Web

64

Cable Assemblies See Our Website For Current Pricing & Real-Time Stock Availability!

\*Coax Performance at 1 GHz Notes: Cable assembly max frequency may be lower than connector or coax max frequency



For our complete selection of cable assemblies, please visit our website

M17/113-RG316-27478 Coax, 50 Ohm						
Part No. <a href="#">PE3M0097</a>		Cable Dia.	Attn. @ 1 GHz	Power @ 1 GHz		
1 piece price shown. See web or call for volume pricing.						
6"	8"	12"	16"	18"	24"	Custom Len.
\$213.16	\$213.53	\$214.26	\$214.96	\$215.35	\$216.43	See Web
M17/119-RG174-0XDS2 Coax, 50 Ohm						
Part No. <a href="#">PE3M0112</a>		Cable Dia.	Attn. @ 1 GHz	Power @ 1 GHz		
1 piece price shown. See web or call for volume pricing.						
6"	8"	12"	16"	18"	24"	Custom Len.
\$212.50	\$212.64	\$212.93	\$213.20	\$213.36	\$213.77	See Web
M17/28-RG058-0XDS2 Coax, 50 Ohm						
Part No. <a href="#">PE3M0123</a>		Cable Dia.	Attn. @ 1 GHz	Power @ 1 GHz		
1 piece price shown. See web or call for volume pricing.						
12"	18"	24"	30"	36"	48"	Custom Len.
\$250.30	\$250.94	\$251.59	\$252.23	\$252.89	\$254.18	See Web
SMA MALE RIGHT ANGLE TO BNC MALE						
Low Loss Flexible Cable Assemblies						
PE-C195 Coax, 50 Ohm						
Part No. <a href="#">PE38093</a>		Cable Dia.	Attn. @ 1 GHz	Power @ 1 GHz		
1 piece price shown. See web or call for volume pricing.						
12"	24"	36"	48"	60"	50CM	Custom Len.
\$50.49	\$46.70	\$47.50	\$48.27	\$54.04	-	See Web
Standard Flexible Cable Assemblies						
RG58C/U Coax, 50 Ohm						
Part No. <a href="#">PE3850</a>		Cable Dia.	Attn. @ 1 GHz	Power @ 1 GHz		
1 piece price shown. See web or call for volume pricing.						
6"	12"	18"	24"	36"	48"	Custom Len.
\$57.78	\$57.78	\$58.21	\$64.46	\$65.34	\$60.23	See Web
RG142B/U Coax, 50 Ohm						
Part No. <a href="#">PE3780</a>		Cable Dia.	Attn. @ 1 GHz	Power @ 1 GHz		
1 piece price shown. See web or call for volume pricing.						
6"	12"	18"	24"	36"	48"	Custom Len.
\$50.35	\$50.60	\$53.79	\$56.46	\$62.74	\$69.06	See Web
RG174A/U Coax, 50 Ohm						
Part No. <a href="#">PE3C3448</a>		Cable Dia.	Attn. @ 1 GHz	Power @ 1 GHz		
1 piece price shown. See web or call for volume pricing.						
6"	12"	18"	24"	36"	48"	Custom Len.
\$56.92	\$57.22	\$57.54	\$57.85	\$58.50	\$58.32	See Web
RG178B/U Coax, 50 Ohm						
Part No. <a href="#">PE33257</a>		Cable Dia.	Attn. @ 1 GHz	Power @ 1 GHz		
1 piece price shown. See web or call for volume pricing.						
12"	24"	36"	48"	60"	-	Custom Len.
\$91.75	\$92.92	\$94.08	\$95.30	\$96.48	-	See Web
RG188A/U Coax, 50 Ohm						
Part No. <a href="#">PE3C3437</a>		Cable Dia.	Attn. @ 1 GHz	Power @ 1 GHz		
1 piece price shown. See web or call for volume pricing.						
6"	12"	18"	24"	36"	48"	Custom Len.
\$56.95	\$61.51	\$58.18	\$59.40	\$67.00	\$69.90	See Web
RG223/U Coax, 50 Ohm						
Part No. <a href="#">PE3733</a>		Cable Dia.	Attn. @ 1 GHz	Power @ 1 GHz		
1 piece price shown. See web or call for volume pricing.						
6"	12"	18"	24"	36"	48"	Custom Len.
\$65.87	\$67.54	\$63.00	\$70.96	\$74.38	\$78.00	See Web
RG303/U Coax, 50 Ohm						
Part No. <a href="#">PE39138</a>		Cable Dia.	Attn. @ 1 GHz	Power @ 1 GHz		
1 piece price shown. See web or call for volume pricing.						
12"	24"	36"	48"	60"	-	Custom Len.
\$47.65	\$56.16	\$59.82	\$66.12	\$72.42	-	See Web
RG316/U Coax, 50 Ohm						
Part No. <a href="#">PE3C3350</a>		Cable Dia.	Attn. @ 1 GHz	Power @ 1 GHz		
1 piece price shown. See web or call for volume pricing.						
6"	12"	18"	24"	36"	48"	Custom Len.
\$60.21	\$65.03	\$61.79	\$68.47	\$71.89	\$75.53	See Web
RG400/U Coax, 50 Ohm						
Part No. <a href="#">PE3642</a>		Cable Dia.	Attn. @ 1 GHz	Power @ 1 GHz		
1 piece price shown. See web or call for volume pricing.						
6"	12"	18"	24"	36"	48"	Custom Len.
\$66.18	\$68.82	\$70.00	\$73.83	\$81.50	\$89.15	See Web
PE-P195 Coax, 50 Ohm						
Part No. <a href="#">PE33889</a>		Cable Dia.	Attn. @ 1 GHz	Power @ 1 GHz		
1 piece price shown. See web or call for volume pricing.						
12"	24"	36"	48"	60"	-	Custom Len.
\$56.92	\$66.66	\$76.39	\$86.11	\$103.29	-	See Web
SMA MALE RIGHT ANGLE TO BNC FEMALE BULKHEAD						
SEE MOUNTING HOLE SECTION ON PAGE 409						
Standard Flexible Cable Assemblies						

RG316/U Coax, 50 Ohm						
Part No. <a href="#">PE3681</a>		Cable Dia.	Attn. @ 1 GHz	Power @ 1 GHz		
1 piece price shown. See web or call for volume pricing.						
12"	24"	36"	48"	60"	-	Custom Len.
\$72.61	\$76.06	\$74.87	\$83.13	\$81.20	-	See Web
RG400/U Coax, 50 Ohm						
Part No. <a href="#">PE34957</a>		Cable Dia.	Attn. @ 1 GHz	Power @ 1 GHz		
1 piece price shown. See web or call for volume pricing.						
12"	24"	36"	48"	60"	-	Custom Len.
\$84.10	\$85.55	\$93.20	\$100.87	\$107.03	-	See Web
SMA MALE RIGHT ANGLE TO MCX PLUG RIGHT ANGLE						
Standard Flexible Cable Assemblies						
RG316/U Coax, 50 Ohm						
Part No. <a href="#">PE3W10654</a>		Cable Dia.	Attn. @ 1 GHz	Power @ 1 GHz		
1 piece price shown. See web or call for volume pricing.						
12"	24"	36"	48"	60"	50CM	Custom Len.
\$65.56	\$69.21	\$72.86	\$76.51	\$80.16	\$64.24	See Web
Standard Semi-Rigid Cable Assemblies						
PE-SR405AL Coax, 50 Ohm						
Part No. <a href="#">PE3W02882</a>		Cable Dia.	Attn. @ 1 GHz	Power @ 1 GHz		
1 piece price shown. See web or call for volume pricing.						
12"	24"	36"	48"	60"	50CM	Custom Len.
\$59.16	\$69.32	\$79.47	\$89.62	\$99.79	\$65.67	See Web
SMA MALE RIGHT ANGLE TO MCX JACK						
Standard Flexible Cable Assemblies						
RG316/U Coax, 50 Ohm						
Part No. <a href="#">PE3W02744</a>		Cable Dia.	Attn. @ 1 GHz	Power @ 1 GHz		
1 piece price shown. See web or call for volume pricing.						
12"	24"	36"	48"	60"	50CM	Custom Len.
\$72.39	\$75.71	\$79.05	\$82.38	\$85.72	\$74.50	See Web
RG316-DS Coax, 50 Ohm						
Part No. <a href="#">PE3W01114</a>		Cable Dia.	Attn. @ 1 GHz	Power @ 1 GHz		
1 piece price shown. See web or call for volume pricing.						
12"	24"	36"	48"	60"	50CM	Custom Len.
\$64.07	\$67.41	\$70.73	\$74.08	\$77.41	\$66.21	See Web
SMA MALE RIGHT ANGLE TO MMCX PLUG RIGHT ANGLE						
Standard Flexible Cable Assemblies						
RG174A/U Coax, 50 Ohm						
Part No. <a href="#">PE36507</a>		Cable Dia.	Attn. @ 1 GHz	Power @ 1 GHz		
1 piece price shown. See web or call for volume pricing.						
12"	24"	36"	48"	60"	-	Custom Len.
\$73.61	\$74.23	\$74.88	\$75.55	\$68.81	-	See Web
SMA MALE RIGHT ANGLE TO N MALE						
Low Loss Flexible Cable Assemblies						
PE-P142LL-27478 Coax, 50 Ohm						
Part No. <a href="#">PE3M0156</a>		Cable Dia.	Attn. @ 1 GHz	Power @ 1 GHz		
1 piece price shown. See web or call for volume pricing.						
12"	18"	24"	36"	48"	60"	Custom Len.
\$497.76	\$506.96	\$516.15	\$534.54	\$552.91	\$571.30	See Web
PE-P160LL-27478 Coax, 50 Ohm						
Part No. <a href="#">PE3M0201</a>		Cable Dia.	Attn. @ 1 GHz	Power @ 1 GHz		
1 piece price shown. See web or call for volume pricing.						
8"	12"	18"	24"	36"	-	Custom Len.
\$484.14	\$489.47	\$497.43	\$505.41	\$513.38	\$521.34	See Web
PE-P300LL-27478 Coax, 50 Ohm						
Part No. <a href="#">PE3M0235</a>		Cable Dia.	Attn. @ 1 GHz	Power @ 1 GHz		
1 piece price shown. See web or call for volume pricing.						
12"	18"	24"	36"	48"	60"	Custom Len.
\$574.91	\$590.26	\$605.61	\$636.29	\$666.97	\$697.65	See Web
Low Loss Test Flexible Cable Assemblies						
PE-P300LL Coax, 50 Ohm						
Part No. <a href="#">PE3C3238</a>		Cable Dia.	Attn. @ 1 GHz	Power @ 1 GHz		
1 piece price shown. See web or call for volume pricing.						
12"	24"	36"	48"	60"	50CM	Custom Len.
\$270.71	\$298.01	\$325.31	\$352.62	\$379.91	\$288.22	See Web

Cable Assemblies

See Our Website For Current Pricing & Real-Time Stock Availability!

For Custom Lengths, Metric Lengths or Special Configurations, Please call (949) 261-1920



Technical Support  
+1 (949) 261-1920



Same-Day Shipping,  
Even Custom Cable Assemblies



For our complete selection of cable assemblies, please visit our website

Cable Assemblies

See Our Website For Current Pricing & Real-Time Stock Availability!

Standard Flexible Cable Assemblies						
RG142B/U Coax, 50 Ohm						
Part No.	PE3W00921			Cable Dia.	Attn. @ 1 GHz	Power @ 1 GHz
1 piece price shown. See web or call for volume pricing.						
12"	24"	36"	48"	0.195" dia.	13 dB/100ft	650 W
\$57.99	\$64.48	\$70.97	\$77.45	\$83.95	\$62.15	See Web

90

**SMA MALE RIGHT ANGLE TO N MALE RIGHT ANGLE**



Flexible Cable Assemblies						
LMR-195-FR Coax, 50 Ohm						
Part No.	PE3W05298			Cable Dia.	Attn. @ 1 GHz	Power @ 1 GHz
1 piece price shown. See web or call for volume pricing.						
12"	24"	36"	48"	0.195" dia.	11.8 dB/100ft	50CM Custom Len.
\$60.01	\$61.11	\$62.19	\$63.29	\$64.39	\$60.70	See Web

91

Low Loss Flexible Cable Assemblies						
LMR-195 Coax, 50 Ohm						
Part No.	PE3W00852			Cable Dia.	Attn. @ 1 GHz	Power @ 1 GHz
1 piece price shown. See web or call for volume pricing.						
12"	24"	36"	48"	0.195" dia.	50CM	Custom Len.
\$58.10	\$58.90	\$59.70	\$60.51	\$61.29	\$58.59	See Web

92

PE-P142LL Coax, 50 Ohm						
Part No.	PE3C1528			Cable Dia.	Attn. @ 1 GHz	Power @ 1 GHz
1 piece price shown. See web or call for volume pricing.						
12"	24"	36"	48"	0.195" dia.	7.2 dB/100ft	50CM Custom Len.
\$329.95	\$347.56	\$365.16	\$382.77	\$400.36	\$341.23	See Web

93

PE-P142LL-27478 Coax, 50 Ohm						
Part No.	PE3M0158			Cable Dia.	Attn. @ 1 GHz	Power @ 1 GHz
1 piece price shown. See web or call for volume pricing.						
12"	18"	24"	36"	48"	60"	Custom Len.
\$622.48	\$631.67	\$640.86	\$659.24	\$677.63	\$696.01	See Web

94

PE-P160LL-27478 Coax, 50 Ohm						
Part No.	PE3M0203			Cable Dia.	Attn. @ 1 GHz	Power @ 1 GHz
1 piece price shown. See web or call for volume pricing.						
8"	12"	18"	24"	30"	36"	Custom Len.
\$590.46	\$595.79	\$603.74	\$611.72	\$619.68	\$627.66	See Web

95

PE-P300LL-27478 Coax, 50 Ohm						
Part No.	PE3M0237			Cable Dia.	Attn. @ 1 GHz	Power @ 1 GHz
1 piece price shown. See web or call for volume pricing.						
12"	18"	24"	36"	48"	60"	Custom Len.
\$732.05	\$747.40	\$751.48	\$793.43	\$827.49	\$854.80	See Web

96

Low Loss Test Flexible Cable Assemblies						
PE-P300LL Coax, 50 Ohm						
Part No.	PE3C3249			Cable Dia.	Attn. @ 1 GHz	Power @ 1 GHz
1 piece price shown. See web or call for volume pricing.						
12"	24"	36"	48"	0.3" dia.	55 dB/100ft	50CM Custom Len.
\$489.56	\$516.90	\$544.22	\$571.55	\$598.87	\$507.07	See Web

97

**SMA MALE RIGHT ANGLE TO N FEMALE**



Low Loss Test Flexible Cable Assemblies						
PE-P300LL Coax, 50 Ohm						
Part No.	PE3C3250			Cable Dia.	Attn. @ 1 GHz	Power @ 1 GHz
1 piece price shown. See web or call for volume pricing.						
12"	24"	36"	48"	0.3" dia.	55 dB/100ft	50CM Custom Len.
\$389.60	\$416.91	\$444.24	\$471.57	\$498.89	\$407.08	See Web

98

**SMA MALE RIGHT ANGLE TO N FEMALE BULKHEAD**



SEE MOUNTING HOLE SECTION ON PAGE 409

Low Loss Flexible Cable Assemblies						
PE-P142LL Coax, 50 Ohm						
Part No.	PE3C2985			Cable Dia.	Attn. @ 1 GHz	Power @ 1 GHz
1 piece price shown. See web or call for volume pricing.						
12"	24"	36"	48"	0.195" dia.	10 dB/100ft	50CM Custom Len.
\$279.81	\$297.41	\$315.01	\$332.63	\$350.21	\$291.09	See Web

99

PE-P142LL-27478 Coax, 50 Ohm						
Part No.	PE3M0157			Cable Dia.	Attn. @ 1 GHz	Power @ 1 GHz
1 piece price shown. See web or call for volume pricing.						
12"	18"	24"	36"	48"	60"	Custom Len.
\$592.32	\$601.50	\$610.69	\$629.08	\$647.46	\$665.84	See Web

1

PE-P160LL-27478 Coax, 50 Ohm						
Part No.	PE3M0202			Cable Dia.	Attn. @ 1 GHz	Power @ 1 GHz
1 piece price shown. See web or call for volume pricing.						
8"	12"	18"	24"	30"	36"	Custom Len.
\$594.73	\$600.04	\$608.01	\$615.98	\$623.95	\$631.92	See Web

2

PE-P300LL-27478 Coax, 50 Ohm						
Part No.	PE3M0236			Cable Dia.	Attn. @ 1 GHz	Power @ 1 GHz
1 piece price shown. See web or call for volume pricing.						
12"	18"	24"	36"	48"	60"	Custom Len.
\$656.95	\$672.31	\$687.64	\$718.33	\$749.01	\$779.69	See Web

3

Precision Formable Cable Assemblies						
PE-SR402FL Coax, 50 Ohm						
Part No.	PE39456			Cable Dia.	Attn. @ 1 GHz	Power @ 1 GHz
1 piece price shown. See web or call for volume pricing.						
6"	9"	12"	18"	24"	-	Custom Len.
\$59.44	Call	\$59.44	\$64.03	\$68.62	-	See Web

4

PE-SR402FLJ Coax, 50 Ohm						
Part No.	PE39470			Cable Dia.	Attn. @ 1 GHz	Power @ 1 GHz
1 piece price shown. See web or call for volume pricing.						
6"	9"	12"	18"	24"	-	Custom Len.
\$60.93	Call	\$60.93	\$65.86	Call	-	See Web

5

Low Loss Test Flexible Cable Assemblies						
PE-P300LL Coax, 50 Ohm						
Part No.	PE3C3245			Cable Dia.	Attn. @ 1 GHz	Power @ 1 GHz
1 piece price shown. See web or call for volume pricing.						
12"	24"	36"	48"	0.3" dia.	5.5 dB/100ft	50CM Custom Len.
\$452.24	\$479.55	\$506.88	\$534.20	\$561.54	\$469.72	See Web

6

Standard Formable Cable Assemblies						
PE-SR405FL Coax, 50 Ohm						
Part No.	PE39448			Cable Dia.	Attn. @ 1 GHz	Power @ 1 GHz
1 piece price shown. See web or call for volume pricing.						
6"	9"	12"	18"	24"	-	Custom Len.
\$72.55	\$61.10	\$72.55	\$79.00	Call	-	See Web

7

PE-SR405FLJ Coax, 50 Ohm						
Part No.	PE39462			Cable Dia.	Attn. @ 1 GHz	Power @ 1 GHz
1 piece price shown. See web or call for volume pricing.						
6"	9"	12"	18"	24"	-	Custom Len.
\$68.28	\$57.72	\$68.28	Call	\$78.15	-	See Web

8

Standard Flexible Cable Assemblies						
RG174A/U Coax, 50 Ohm						
Part No.	PE34351			Cable Dia.	Attn. @ 1 GHz	Power @ 1 GHz
1 piece price shown. See web or call for volume pricing.						
12"	24"	36"	48"	0.1" dia.	32 dB/100ft	16 W Custom Len.
\$92.39	\$86.03	\$93.66	\$86.98	\$87.46	-	See Web

9

RG316/U Coax, 50 Ohm						
Part No.	PE33014			Cable Dia.	Attn. @ 1 GHz	Power @ 1 GHz
1 piece price shown. See web or call for volume pricing.						
12"	24"	36"	48"	0.102" dia.	38 dB/100ft	Custom Len.
\$83.22	\$83.20	\$86.37	\$93.73	\$92.72	-	See Web

10

RG400/U Coax, 50 Ohm						
Part No.	PE3179			Cable Dia.	Attn. @ 1 GHz	Power @ 1 GHz
1 piece price shown. See web or call for volume pricing.						
12"	24"	36"	48"	0.195" dia.	14.7 dB/100ft	600 W Custom Len.
\$85.31	\$88.17	\$101.58	\$103.49	\$109.59	-	See Web

11

**SMA MALE RIGHT ANGLE TO SMA MALE**



Flexible Cable Assemblies						
LMR-240 Coax, 50 Ohm						
Part No.	PE3C6658			Cable Dia.	Attn. @ 1 GHz	Power @ 1 GHz
1 piece price shown. See web or call for volume pricing.						
12"	24"	36"	48"	0.24" dia.	8 dB/100ft	Custom Len.
\$53.47	\$54.45	\$54.91	\$55.89	\$56.87	-	See Web

12

Low Loss Flexible Cable Assemblies						
PE-P142LL Coax, 50 Ohm						
Part No.	PE342			Cable Dia.	Attn. @ 1 GHz	Power @ 1 GHz
1 piece price shown. See web or call for volume pricing.						
12"	24"	36"	48"	0.195" dia.	7.2 dB/100ft	50CM Custom Len.
\$212.69	\$230.29	\$247.88	\$265.49	\$283.09	\$223.96	See Web

13

Standard Formable Cable Assemblies						
PE-SR405FLJ Coax, 50 Ohm						
Part No.	PE39431			Cable Dia.	Attn. @ 1 GHz	Power @ 1 GHz
1 piece price shown. See web or call for volume pricing.						
6"	9"	12"	18"	24"	-	Custom Len.
\$46.74	\$44.44	\$46.74	\$51.73	\$56.19	-	See Web

14

Standard Flexible Cable Assemblies						
RG316/U Coax, 50 Ohm						
Part No.	PE3W06425			Cable Dia.	Attn. @ 1 GHz	Power @ 1 GHz
1 piece price shown. See web or call for volume pricing.						
12"	24"	36"	48"	0.102" dia.	38 dB/100ft	50CM Custom Len.
\$59.70	\$63.29	\$66.90	\$70.52	\$74.13	\$62.01	See Web

15

RG316-DS Coax, 50 Ohm						
Part No.	PE3W06660			Cable Dia.	Attn. @ 1 GHz	Power @ 1 GHz
1 piece price shown. See web or call for volume pricing.						
12"	24"	36"	48"	0.114" dia.	30 dB/100ft	85 W Custom Len.
\$65.29	\$68.78	\$72.43	\$76.00	\$79.59	\$67.58	See Web

16

**SMA MALE RIGHT ANGLE TO SMA MALE RIGHT ANGLE**



Low Loss Flexible Cable Assemblies						
------------------------------------	--	--	--	--	--	--

\*Coax Performance at 1 GHz Notes: Cable assembly max frequency may be lower than connector or coax max frequency

# For our complete selection of cable assemblies, please visit our website

PE-C195 Coax, 50 Ohm						
Part No. <b>PE35347</b>	Cable Dia.				Attn. @ 1 GHz	Power @ 1 GHz
1 piece price shown. See web or call for volume pricing.	0.195" dia.				11.3 dB/100ft	150 W
12"	24"	36"	48"	60"	-	Custom Len.
\$60.65	\$56.93	\$57.72	\$58.51	\$59.30	-	See Web
PE-C240 Coax, 50 Ohm						
Part No. <b>PE38920</b>	Cable Dia.				Attn. @ 1 GHz	Power @ 1 GHz
1 piece price shown. See web or call for volume pricing.	0.24" dia.				9.2 dB/100ft	250 W
12"	24"	36"	48"	60"	-	Custom Len.
\$86.98	\$85.15	\$88.25	\$90.79	\$92.05	-	See Web
PE-P142LL Coax, 50 Ohm						
Part No. <b>PE3C1425</b>	Cable Dia.				Attn. @ 1 GHz	Power @ 1 GHz
1 piece price shown. See web or call for volume pricing.	0.195" dia.				7.2 dB/100ft	130 W
12"	24"	36"	48"	60"	50CM	Custom Len.
\$306.65	\$324.25	\$341.86	\$359.44	\$377.05	\$317.92	See Web
PE-P160LL Coax, 50 Ohm						
Part No. <b>PE3C5248</b>	Cable Dia.				Attn. @ 1 GHz	Power @ 1 GHz
1 piece price shown. See web or call for volume pricing.	0.16" dia.				-	50CM
12"	24"	36"	48"	60"	50CM	Custom Len.
\$303.22	\$325.68	\$348.12	\$370.58	\$393.04	\$317.61	See Web
PE-P142LL-27478 Coax, 50 Ohm						
Part No. <b>PE3M0152</b>	Cable Dia.				Attn. @ 1 GHz	Power @ 1 GHz
1 piece price shown. See web or call for volume pricing.	0.195" dia.				-	60"
12"	18"	24"	36"	48"	60"	Custom Len.
\$594.32	\$603.50	\$612.70	\$631.08	\$649.47	\$667.85	See Web
PE-P160LL-27478 Coax, 50 Ohm						
Part No. <b>PE3M0197</b>	Cable Dia.				Attn. @ 1 GHz	Power @ 1 GHz
1 piece price shown. See web or call for volume pricing.	0.16" dia.				-	36"
8"	12"	18"	24"	30"	36"	Custom Len.
\$599.00	\$604.31	\$612.28	\$620.24	\$628.22	\$636.19	See Web
PE-P300LL-27478 Coax, 50 Ohm						
Part No. <b>PE3M0232</b>	Cable Dia.				Attn. @ 1 GHz	Power @ 1 GHz
1 piece price shown. See web or call for volume pricing.	0.3" dia.				-	60"
12"	18"	24"	36"	48"	60"	Custom Len.
\$696.58	\$711.91	\$727.26	\$757.94	\$788.63	\$819.32	See Web
Low PIM Corrugated Cable Assemblies						
PE-1/4SFHC Coax, 50 Ohm						
Part No. <b>PE3C7867</b>	Cable Dia.				Attn. @ 1 GHz	Power @ 1 GHz
1 piece price shown. See web or call for volume pricing.	0.303" dia.				5.85 dB/100ft	50CM
12"	24"	36"	48"	60"	50CM	Custom Len.
\$50.89	\$54.15	\$57.87	\$61.60	\$65.32	\$53.30	See Web
SPP-250-LLPL Coax, 50 Ohm						
Part No. <b>PE3C5895</b>	Cable Dia.				Attn. @ 1 GHz	Power @ 1 GHz
1 piece price shown. See web or call for volume pricing.	0.28" dia.				-	50CM
12"	24"	36"	48"	60"	50CM	Custom Len.
\$66.26	\$72.40	\$78.53	\$84.67	\$90.80	\$70.19	See Web
Part No. <b>PE3C6208</b>	Cable Dia.				Attn. @ 1 GHz	Power @ 1 GHz
1 piece price shown. See web or call for volume pricing.	0.28" dia.				5.5 dB/100ft	650 W
12"	24"	36"	48"	60"	50CM	Custom Len.
\$57.61	\$63.75	\$69.88	\$76.00	\$82.14	\$61.52	See Web
Low Loss Test Flexible Cable Assemblies						
PE-P300LL Coax, 50 Ohm						
Part No. <b>PE3C2884</b>	Cable Dia.				Attn. @ 1 GHz	Power @ 1 GHz
1 piece price shown. See web or call for volume pricing.	0.3" dia.				5.5 dB/100ft	50CM
12"	24"	36"	48"	60"	50CM	Custom Len.
\$343.44	\$370.74	\$398.04	\$425.34	\$452.64	\$360.94	See Web
Standard Formable Cable Assemblies						
PE-SR407FL Coax, 50 Ohm						
Part No. <b>PE34209</b>	Cable Dia.				Attn. @ 1 GHz	Power @ 1 GHz
1 piece price shown. See web or call for volume pricing.	0.047" dia.				36 dB/100ft	32 W
6"	12"	18"	24"	36"	48"	Custom Len.
\$167.07	\$167.07	\$171.09	\$175.07	\$183.06	\$191.06	See Web
PE-SR401FL Coax, 50 Ohm						
Part No. <b>PE34217</b>	Cable Dia.				Attn. @ 1 GHz	Power @ 1 GHz
1 piece price shown. See web or call for volume pricing.	7.6 dB/100ft				-	1,400 W
6"	12"	18"	24"	36"	48"	Custom Len.
\$174.44	\$172.67	\$181.02	\$189.38	\$206.07	\$222.76	See Web
PE-SR402FL Coax, 50 Ohm						
Part No. <b>PE3417</b>	Cable Dia.				Attn. @ 1 GHz	Power @ 1 GHz
1 piece price shown. See web or call for volume pricing.	11.88 dB/100ft				-	450 W
6"	12"	18"	24"	36"	48"	Custom Len.
\$88.10	\$92.41	\$96.85	\$101.29	\$108.65	\$112.99	See Web
Part No. <b>PE39424</b>	Cable Dia.				Attn. @ 1 GHz	Power @ 1 GHz
1 piece price shown. See web or call for volume pricing.	11.88 dB/100ft				-	450 W
6"	9"	12"	18"	24"	-	Custom Len.
\$67.43	\$65.26	\$67.43	\$72.02	\$76.62	-	See Web
PE-SR402FLJ Coax, 50 Ohm						
Part No. <b>PE39438</b>	Cable Dia.				Attn. @ 1 GHz	Power @ 1 GHz
1 piece price shown. See web or call for volume pricing.	0.161" dia.				11.89 dB/100ft	303.4 W
6"	9"	12"	18"	24"	-	Custom Len.
\$33.61	\$31.44	\$33.61	\$38.41	\$43.20	-	See Web

PE-SR405FL Coax, 50 Ohm						
Part No. <b>PE3646</b>	Cable Dia.				Attn. @ 1 GHz	Power @ 1 GHz
1 piece price shown. See web or call for volume pricing.	22.5 dB/100ft				-	130 W
6"	12"	18"	24"	36"	48"	Custom Len.
\$108.46	\$112.81	\$118.95	\$120.06	\$131.64	\$143.24	See Web
Part No. <b>PE39416</b>	Cable Dia.				Attn. @ 1 GHz	Power @ 1 GHz
1 piece price shown. See web or call for volume pricing.	22.5 dB/100ft				-	130 W
6"	9"	12"	18"	24"	-	Custom Len.
\$67.29	\$67.29	\$71.31	\$77.55	\$83.79	-	See Web
PE-SR405FLJ Coax, 50 Ohm						
Part No. <b>PE39430</b>	Cable Dia.				Attn. @ 1 GHz	Power @ 1 GHz
1 piece price shown. See web or call for volume pricing.	0.098" dia.				19.5 dB/100ft	130 W
6"	9"	12"	18"	24"	-	Custom Len.
\$35.72	\$33.42	\$35.72	\$40.72	\$45.70	-	See Web
Standard Flexible Cable Assemblies						
RG58C/U Coax, 50 Ohm						
Part No. <b>PE3655</b>	Cable Dia.				Attn. @ 1 GHz	Power @ 1 GHz
1 piece price shown. See web or call for volume pricing.	0.195" dia.				-	650 W
6"	12"	18"	24"	36"	48"	Custom Len.
\$64.17	\$64.60	\$65.04	\$61.74	\$66.39	\$63.30	See Web
RG142B/U Coax, 50 Ohm						
Part No. <b>PE3514</b>	Cable Dia.				Attn. @ 1 GHz	Power @ 1 GHz
1 piece price shown. See web or call for volume pricing.	0.195" dia.				13 dB/100ft	650 W
6"	12"	18"	24"	36"	48"	Custom Len.
\$71.66	\$74.90	\$73.81	\$76.97	\$82.26	\$95.34	See Web
RG174A/U Coax, 50 Ohm						
Part No. <b>PE3775</b>	Cable Dia.				Attn. @ 1 GHz	Power @ 1 GHz
1 piece price shown. See web or call for volume pricing.	0.1" dia.				32 dB/100ft	16 W
6"	12"	18"	24"	36"	48"	Custom Len.
\$70.79	\$71.10	\$71.41	\$71.74	\$69.33	\$73.03	See Web
RG178B/U Coax, 50 Ohm						
Part No. <b>PE3876</b>	Cable Dia.				Attn. @ 1 GHz	Power @ 1 GHz
1 piece price shown. See web or call for volume pricing.	0.072" dia.				44.4 dB/100ft	78 W
6"	12"	18"	24"	36"	48"	Custom Len.
\$95.12	\$90.26	\$96.27	\$96.85	\$92.37	\$93.41	See Web
RG188A/U Coax, 50 Ohm						
Part No. <b>PE3511</b>	Cable Dia.				Attn. @ 1 GHz	Power @ 1 GHz
1 piece price shown. See web or call for volume pricing.	0.11" dia.				26 dB/100ft	160 W
6"	12"	18"	24"	36"	48"	Custom Len.
\$77.34	\$72.85	\$80.04	\$81.42	\$84.15	\$80.17	See Web
RG188-DS Coax, 50 Ohm						
Part No. <b>PE3347</b>	Cable Dia.				Attn. @ 1 GHz	Power @ 1 GHz
1 piece price shown. See web or call for volume pricing.	0.122" dia.				30 dB/100ft	160 W
6"	12"	18"	24"	36"	48"	Custom Len.
\$76.09	\$80.66	\$77.96	\$79.82	\$83.55	\$87.29	See Web
RG223/U Coax, 50 Ohm						
Part No. <b>PE3428</b>	Cable Dia.				Attn. @ 1 GHz	Power @ 1 GHz
1 piece price shown. See web or call for volume pricing.	0.21" dia.				13.4 dB/100ft	53 W
6"	12"	18"	24"	36"	48"	Custom Len.
\$68.60	\$70.26	\$67.87	\$69.46	\$72.65	\$80.73	See Web
RG316/U Coax, 50 Ohm						
Part No. <b>PE3515</b>	Cable Dia.				Attn. @ 1 GHz	Power @ 1 GHz
1 piece price shown. See web or call for volume pricing.	0.102" dia.				38 dB/100ft	48"
6"	12"	18"	24"	36"	48"	Custom Len.
\$72.35	\$74.03	\$75.76	\$77.45	\$80.90	\$84.54	See Web
RG316-DS Coax, 50 Ohm						
Part No. <b>PE3987</b>	Cable Dia.				Attn. @ 1 GHz	Power @ 1 GHz
1 piece price shown. See web or call for volume pricing.	0.114" dia.				30 dB/100ft	160 W
6"	12"	18"	24"	36"	48"	Custom Len.
\$75.55	\$77.22	\$78.93	\$80.65	\$84.08	\$82.43	See Web
RG400/U Coax, 50 Ohm						
Part No. <b>PE3713</b>	Cable Dia.				Attn. @ 1 GHz	Power @ 1 GHz
1 piece price shown. See web or call for volume pricing.	0.195" dia.				14.7 dB/100ft	650 W
6"	12"	18"	24"	36"	48"	Custom Len.
\$81.05	\$81.05	\$91.59	\$88.72	\$103.78	\$104.05	See Web
PE-P086EAM Coax, 50 Ohm						
Part No. <b>PE3CA1041</b>	Cable Dia.				Attn. @ 1 GHz	Power @ 1 GHz
1 piece price shown. See web or call for volume pricing.	0.104" dia.				-	100CM
7"	12"	24"	36"	50CM	100CM	Custom Len.
Call	\$76.87	\$90.33	\$103.78	\$85.41	\$107.56	See Web
PE-P141 Coax, 50 Ohm						
Part No. <b>PE3C1203</b>	Cable Dia.				Attn. @ 1 GHz	Power @ 1 GHz
1 piece price shown. See web or call for volume pricing.	0.163" dia.				11.2 dB/100ft	550 W
12"	24"	36"	48"	60"	50CM	Custom Len.
\$205.06	\$217.85	\$230.65	\$243.45	\$256.24	\$213.25	See Web
PE-P141EAM Coax, 50 Ohm						
Part No. <b>PE3CA1037</b>	Cable Dia.				Attn. @ 1 GHz	Power @ 1 GHz
1 piece price shown. See web or call for volume pricing.	0.163" dia.				-	100CM
12"	20.500	24"	36"	50CM	100CM	Custom Len.
\$89.40	Call	\$108.85	\$129.56	\$102.84	\$135.35	See Web
Standard Semi-Rigid Cable Assemblies						

Cable Assemblies

See Our Website For Current Pricing & Real-Time Stock Availability!

Continued on Next Page

For Custom Lengths, Metric Lengths or Special Configurations, Please call (949) 261-1920



Technical Support  
+1 (949) 261-1920



Same-Day Shipping,  
Even Custom Cable Assemblies

For our complete selection of cable assemblies, please visit our website

Cable Assemblies  
See Our Website For Current Pricing & Real-Time Stock Availability!

PE-020SR Coax, 50 Ohm						
Part No. <a href="#">PE34211</a>	Cable Dia.	Attn. @ 1 GHz	Power @ 1 GHz			
1 piece price shown. See web or call for volume pricing.						
6"	12"	18"	24"	36"	48"	Custom Len.
\$167.84	\$177.35	\$186.90	\$196.42	\$215.48	\$234.54	See Web
PE-034SR Coax, 50 Ohm						
Part No. <a href="#">PE34219</a>	Cable Dia.	Attn. @ 1 GHz	Power @ 1 GHz			
1 piece price shown. See web or call for volume pricing.						
6"	12"	18"	24"	36"	48"	Custom Len.
\$145.07	\$151.69	\$158.39	\$165.03	\$178.39	\$191.73	See Web
PE-047SR Coax, 50 Ohm						
Part No. <a href="#">PE3147</a>	Cable Dia.	Attn. @ 1 GHz	Power @ 1 GHz			
1 piece price shown. See web or call for volume pricing.						
6"	12"	18"	24"	36"	48"	Custom Len.
\$155.28	\$160.68	\$166.03	\$171.42	\$182.16	\$192.95	See Web
PE-SR047AL Coax, 50 Ohm						
Part No. <a href="#">PE3259</a>	Cable Dia.	Attn. @ 1 GHz	Power @ 1 GHz			
1 piece price shown. See web or call for volume pricing.						
6"	12"	18"	24"	36"	48"	Custom Len.
\$154.70	\$159.45	\$164.20	\$168.96	\$178.52	\$188.07	See Web
PE-SR402AL Coax, 50 Ohm						
Part No. <a href="#">PE34208</a>	Cable Dia.	Attn. @ 1 GHz	Power @ 1 GHz			
1 piece price shown. See web or call for volume pricing.						
6"	12"	18"	24"	36"	48"	Custom Len.
\$93.64	\$99.26	\$104.85	\$108.90	\$112.74	\$122.95	See Web
PE-SR405AL Coax, 50 Ohm						
Part No. <a href="#">PE34213</a>	Cable Dia.	Attn. @ 1 GHz	Power @ 1 GHz			
1 piece price shown. See web or call for volume pricing.						
6"	12"	18"	24"	36"	48"	Custom Len.
\$98.94	\$103.57	\$106.60	\$111.17	\$120.22	\$129.32	See Web
RG401/U Coax, 50 Ohm						
Part No. <a href="#">PE34223</a>	Cable Dia.	Attn. @ 1 GHz	Power @ 1 GHz			
1 piece price shown. See web or call for volume pricing.						
6"	12"	18"	24"	36"	48"	Custom Len.
\$179.97	\$179.97	\$191.88	\$203.77	\$227.56	\$251.36	See Web
RG402/U Coax, 50 Ohm						
Part No. <a href="#">PE3819</a>	Cable Dia.	Attn. @ 1 GHz	Power @ 1 GHz			
1 piece price shown. See web or call for volume pricing.						
6"	12"	18"	24"	36"	48"	Custom Len.
\$92.55	\$96.72	\$95.27	\$99.29	\$112.34	\$113.74	See Web
RG405/U Coax, 50 Ohm						
Part No. <a href="#">PE3820</a>	Cable Dia.	Attn. @ 1 GHz	Power @ 1 GHz			
1 piece price shown. See web or call for volume pricing.						
6"	12"	18"	24"	36"	48"	Custom Len.
\$98.03	\$101.65	\$105.27	\$107.45	\$114.68	\$121.84	See Web
PE-SR401AL-STRAIGHT Coax, 50 Ohm						
Part No. <a href="#">PE34215</a>	Cable Dia.	Attn. @ 1 GHz	Power @ 1 GHz			
1 piece price shown. See web or call for volume pricing.						
6"	12"	18"	24"	36"	48"	Custom Len.
\$175.71	\$175.71	\$185.55	\$195.39	\$215.06	\$234.72	See Web
Standard Flexible Cable Assemblies						
RG59B/U Coax, 75 Ohm						
Part No. <a href="#">PE3380</a>	Cable Dia.	Attn. @ 1 GHz	Power @ 1 GHz			
1 piece price shown. See web or call for volume pricing.						
6"	12"	18"	24"	36"	48"	Custom Len.
\$88.38	\$88.85	\$89.37	\$89.85	\$90.82	\$91.82	See Web
RG179B/U Coax, 75 Ohm						
Part No. <a href="#">PE3858</a>	Cable Dia.	Attn. @ 1 GHz	Power @ 1 GHz			
1 piece price shown. See web or call for volume pricing.						
6"	12"	18"	24"	36"	48"	Custom Len.
\$80.78	\$80.78	\$82.07	\$83.38	\$85.98	\$88.56	See Web
RG62A/U Coax, 93 Ohm						
Part No. <a href="#">PE3444</a>	Cable Dia.	Attn. @ 1 GHz	Power @ 1 GHz			
1 piece price shown. See web or call for volume pricing.						
6"	12"	18"	24"	36"	48"	Custom Len.
\$88.59	\$89.32	\$90.02	\$90.77	\$92.22	\$93.67	See Web
RG180B/U Coax, 95 Ohm						
Part No. <a href="#">PE3141</a>	Cable Dia.	Attn. @ 1 GHz	Power @ 1 GHz			
1 piece price shown. See web or call for volume pricing.						
6"	12"	18"	24"	36"	48"	Custom Len.
\$70.96	\$71.13	\$73.34	\$75.53	\$79.91	\$84.32	See Web
SMA MALE RIGHT ANGLE TO SMA FEMALE						
Low Loss Flexible Cable Assemblies						
PE-P142LL Coax, 50 Ohm						
Part No. <a href="#">PE3C2305</a>	Cable Dia.	Attn. @ 1 GHz	Power @ 1 GHz			
1 piece price shown. See web or call for volume pricing.						
12"	24"	36"	48"	60"	50CM	Custom Len.
\$244.91	\$262.52	\$280.13	\$297.74	\$315.33	\$256.20	See Web

Low PIM Corrugated Cable Assemblies						
PE-1/4SFHC Coax, 50 Ohm						
Part No. <a href="#">PE3C7868</a>	Cable Dia.	Attn. @ 1 GHz	Power @ 1 GHz			
1 piece price shown. See web or call for volume pricing.						
12"	24"	36"	48"	60"	50CM	Custom Len.
\$50.33	\$54.09	\$57.32	\$61.05	\$64.78	\$52.74	See Web
Standard Formable Cable Assemblies						
PE-SR405FLJ Coax, 50 Ohm						
Part No. <a href="#">PE3W02994</a>	Cable Dia.	Attn. @ 1 GHz	Power @ 1 GHz			
1 piece price shown. See web or call for volume pricing.						
12"	24"	36"	48"	60"	50CM	Custom Len.
\$53.86	\$63.21	\$73.05	\$82.89	\$92.74	\$59.67	See Web
SMA MALE RIGHT ANGLE TO SMA FEMALE BULKHEAD						
SEE MOUNTING HOLE SECTION ON PAGE 409						
Low Loss Flexible Cable Assemblies						
PE-C100 Coax, 50 Ohm						
Part No. <a href="#">PE3C7571</a>	Cable Dia.	Attn. @ 1 GHz	Power @ 1 GHz			
1 piece price shown. See web or call for volume pricing.						
12"	24"	36"	48"	60"	50CM	Custom Len.
\$56.76	\$58.32	\$59.89	\$61.45	\$63.01	\$57.76	See Web
PE-C100-LSZH Coax, 50 Ohm						
Part No. <a href="#">PE38574</a>	Cable Dia.	Attn. @ 1 GHz	Power @ 1 GHz			
1 piece price shown. See web or call for volume pricing.						
12"	24"	36"	48"	60"	-	Custom Len.
\$57.05	\$58.37	\$59.70	\$61.01	\$62.34	-	See Web
PE-P160LL Coax, 50 Ohm						
Part No. <a href="#">PE3C5244</a>	Cable Dia.	Attn. @ 1 GHz	Power @ 1 GHz			
1 piece price shown. See web or call for volume pricing.						
12"	24"	36"	48"	60"	50CM	Custom Len.
\$281.42	\$303.88	\$326.33	\$348.79	\$371.24	\$295.81	See Web
Precision Formable Cable Assemblies						
PE-SR402FL Coax, 50 Ohm						
Part No. <a href="#">PE39428</a>	Cable Dia.	Attn. @ 1 GHz	Power @ 1 GHz			
1 piece price shown. See web or call for volume pricing.						
6"	9"	12"	18"	24"	-	Custom Len.
\$47.64	\$45.46	\$47.64	\$52.27	\$56.38	-	See Web
PE-SR402FLJ Coax, 50 Ohm						
Part No. <a href="#">PE39442</a>	Cable Dia.	Attn. @ 1 GHz	Power @ 1 GHz			
1 piece price shown. See web or call for volume pricing.						
6"	9"	12"	18"	24"	33"	Custom Len.
\$49.17	\$46.95	Call	Call	\$58.59	Call	See Web
Low PIM Corrugated Cable Assemblies						
PE-1/4SFHC Coax, 50 Ohm						
Part No. <a href="#">PE3C7869</a>	Cable Dia.	Attn. @ 1 GHz	Power @ 1 GHz			
1 piece price shown. See web or call for volume pricing.						
12"	24"	36"	48"	60"	50CM	Custom Len.
\$53.11	\$56.35	\$60.07	\$63.80	\$67.53	\$55.01	See Web
Standard Formable Cable Assemblies						
PE-SR047FL Coax, 50 Ohm						
Part No. <a href="#">PE34307</a>	Cable Dia.	Attn. @ 1 GHz	Power @ 1 GHz			
1 piece price shown. See web or call for volume pricing.						
6"	12"	18"	24"	36"	48"	Custom Len.
\$142.14	\$145.97	\$149.89	\$153.72	\$161.48	\$169.21	See Web
PE-SR401FL Coax, 50 Ohm						
Part No. <a href="#">PE34319</a>	Cable Dia.	Attn. @ 1 GHz	Power @ 1 GHz			
1 piece price shown. See web or call for volume pricing.						
6"	12"	18"	24"	36"	48"	Custom Len.
\$135.82	\$143.97	\$152.02	\$160.17	\$176.37	\$192.56	See Web
PE-SR402FL Coax, 50 Ohm						
Part No. <a href="#">PE34299</a>	Cable Dia.	Attn. @ 1 GHz	Power @ 1 GHz			
1 piece price shown. See web or call for volume pricing.						
6"	12"	18"	24"	36"	48"	Custom Len.
\$80.86	\$78.87	\$82.99	\$87.14	\$95.44	\$103.72	See Web
PE-SR402FLJ Coax, 50 Ohm						
Part No. <a href="#">PE3C7582</a>	Cable Dia.	Attn. @ 1 GHz	Power @ 1 GHz			
1 piece price shown. See web or call for volume pricing.						
12"	24"	36"	48"	60"	50CM	Custom Len.
\$60.16	\$69.92	\$79.69	\$89.45	\$99.21	\$66.41	See Web
PE-SR405FL Coax, 50 Ohm						
Part No. <a href="#">PE34313</a>	Cable Dia.	Attn. @ 1 GHz	Power @ 1 GHz			
1 piece price shown. See web or call for volume pricing.						
6"	12"	18"	24"	36"	48"	Custom Len.
\$93.98	\$93.98	\$105.84	\$105.75	\$115.87	\$127.46	See Web
PE-SR402FL Coax, 50 Ohm						
Part No. <a href="#">PE39420</a>	Cable Dia.	Attn. @ 1 GHz	Power @ 1 GHz			
1 piece price shown. See web or call for volume pricing.						
6"	9"	12"	18"	24"	-	Custom Len.
\$56.01	\$53.59	\$56.01	\$62.15	\$68.28	-	See Web

\*Coax Performance at 1 GHz Notes: Cable assembly max frequency may be lower than connector or coax max frequency



For our complete selection of cable assemblies, please visit our website

Standard Flexible Cable Assemblies						
RG58C/U Coax, 50 Ohm						
Part No. <a href="#">PE3156</a>	Cable Dia.	Attn. @ 1 GHz	Power @ 1 GHz			
1 piece price shown. See web or call for volume pricing.						
6"	12"	18"	24"	36"	48"	Custom Len.
\$60.21	\$60.61	\$61.06	\$61.46	\$62.27	\$63.06	See Web
RG142B/U Coax, 50 Ohm						
Part No. <a href="#">PE3759</a>	Cable Dia.	Attn. @ 1 GHz	Power @ 1 GHz			
1 piece price shown. See web or call for volume pricing.						
6"	12"	18"	24"	36"	48"	Custom Len.
\$66.61	\$64.68	\$67.84	\$70.97	\$77.28	\$83.56	See Web
RG174A/U Coax, 50 Ohm						
Part No. <a href="#">PE3149</a>	Cable Dia.	Attn. @ 1 GHz	Power @ 1 GHz			
1 piece price shown. See web or call for volume pricing.						
6"	12"	18"	24"	36"	48"	Custom Len.
\$72.09	\$72.09	\$78.18	\$72.56	\$79.13	\$79.80	See Web
RG178B/U Coax, 50 Ohm						
Part No. <a href="#">PE3152</a>	Cable Dia.	Attn. @ 1 GHz	Power @ 1 GHz			
1 piece price shown. See web or call for volume pricing.						
6"	12"	18"	24"	36"	48"	Custom Len.
\$73.26	\$76.20	\$76.78	\$74.33	\$78.52	\$76.44	See Web
RG188A/U Coax, 50 Ohm						
Part No. <a href="#">PE3050</a>	Cable Dia.	Attn. @ 1 GHz	Power @ 1 GHz			
1 piece price shown. See web or call for volume pricing.						
6"	12"	18"	24"	36"	48"	Custom Len.
\$74.08	\$80.00	\$75.30	\$76.51	\$85.49	\$81.40	See Web
RG188-DS Coax, 50 Ohm						
Part No. <a href="#">PE34179</a>	Cable Dia.	Attn. @ 1 GHz	Power @ 1 GHz			
1 piece price shown. See web or call for volume pricing.						
6"	12"	18"	24"	36"	48"	Custom Len.
\$77.41	\$74.81	\$76.68	\$78.55	\$82.29	\$86.04	See Web
RG196A/U Coax, 50 Ohm						
Part No. <a href="#">PE34141</a>	Cable Dia.	Attn. @ 1 GHz	Power @ 1 GHz			
1 piece price shown. See web or call for volume pricing.						
6"	12"	18"	24"	36"	48"	Custom Len.
\$75.08	\$75.08	\$75.85	\$76.60	\$78.11	\$79.62	See Web
RG223/U Coax, 50 Ohm						
Part No. <a href="#">PE3800</a>	Cable Dia.	Attn. @ 1 GHz	Power @ 1 GHz			
1 piece price shown. See web or call for volume pricing.						
6"	12"	18"	24"	36"	48"	Custom Len.
\$64.80	\$61.54	\$63.14	\$64.73	\$67.93	\$71.11	See Web
RG316/U Coax, 50 Ohm						
Part No. <a href="#">PE3836</a>	Cable Dia.	Attn. @ 1 GHz	Power @ 1 GHz			
1 piece price shown. See web or call for volume pricing.						
6"	12"	18"	24"	36"	48"	Custom Len.
\$73.69	\$73.69	\$75.28	\$76.87	\$80.04	\$83.22	See Web
RG316-DS Coax, 50 Ohm						
Part No. <a href="#">PE34061</a>	Cable Dia.	Attn. @ 1 GHz	Power @ 1 GHz			
1 piece price shown. See web or call for volume pricing.						
6"	12"	18"	24"	36"	48"	Custom Len.
\$75.69	\$74.40	\$76.00	\$77.60	\$80.81	\$84.01	See Web
PE-P195 Coax, 50 Ohm						
Part No. <a href="#">PE33749</a>	Cable Dia.	Attn. @ 1 GHz	Power @ 1 GHz			
1 piece price shown. See web or call for volume pricing.						
6"	12"	18"	24"	36"	48"	Custom Len.
\$75.35	\$75.35	\$80.22	\$85.09	\$94.83	\$104.56	See Web
Standard Semi-Rigid Cable Assemblies						
PE-020SR Coax, 50 Ohm						
Part No. <a href="#">PE34309</a>	Cable Dia.	Attn. @ 1 GHz	Power @ 1 GHz			
1 piece price shown. See web or call for volume pricing.						
6"	12"	18"	24"	36"	48"	Custom Len.
\$167.20	\$176.70	\$186.20	\$195.75	\$214.82	\$233.88	See Web
PE-034SR Coax, 50 Ohm						
Part No. <a href="#">PE34321</a>	Cable Dia.	Attn. @ 1 GHz	Power @ 1 GHz			
1 piece price shown. See web or call for volume pricing.						
6"	12"	18"	24"	36"	48"	Custom Len.
\$153.59	\$160.23	\$166.88	\$173.56	\$186.90	\$200.19	See Web
PE-047SR Coax, 50 Ohm						
Part No. <a href="#">PE34303</a>	Cable Dia.	Attn. @ 1 GHz	Power @ 1 GHz			
1 piece price shown. See web or call for volume pricing.						
6"	12"	18"	24"	36"	48"	Custom Len.
\$143.64	\$149.04	\$154.44	\$159.77	\$170.59	\$181.30	See Web
PE-SR047AL Coax, 50 Ohm						
Part No. <a href="#">PE34305</a>	Cable Dia.	Attn. @ 1 GHz	Power @ 1 GHz			
1 piece price shown. See web or call for volume pricing.						
6"	12"	18"	24"	36"	48"	Custom Len.
\$143.05	\$147.81	\$152.56	\$157.38	\$166.88	\$176.43	See Web
PE-SR402AL Coax, 50 Ohm						
Part No. <a href="#">PE34297</a>	Cable Dia.	Attn. @ 1 GHz	Power @ 1 GHz			
1 piece price shown. See web or call for volume pricing.						
6"	12"	18"	24"	36"	48"	Custom Len.
\$69.98	\$74.99	\$80.01	\$85.02	\$95.04	\$105.09	See Web

PE-SR405AL Coax, 50 Ohm						
Part No. <a href="#">PE34311</a>	Cable Dia.	Attn. @ 1 GHz	Power @ 1 GHz			
1 piece price shown. See web or call for volume pricing.						
6"	12"	18"	24"	36"	48"	Custom Len.
\$91.68	\$91.68	\$96.42	\$101.17	\$109.15	\$118.50	See Web
RG401/U Coax, 50 Ohm						
Part No. <a href="#">PE34315</a>	Cable Dia.	Attn. @ 1 GHz	Power @ 1 GHz			
1 piece price shown. See web or call for volume pricing.						
6"	12"	18"	24"	36"	48"	Custom Len.
\$139.29	\$150.85	\$162.37	\$173.90	\$196.99	\$220.09	See Web
RG402/U Coax, 50 Ohm						
Part No. <a href="#">PE3679</a>	Cable Dia.	Attn. @ 1 GHz	Power @ 1 GHz			
1 piece price shown. See web or call for volume pricing.						
6"	12"	18"	24"	36"	48"	Custom Len.
\$77.12	\$77.12	\$81.12	\$85.15	\$93.17	\$101.21	See Web
RG405/U Coax, 50 Ohm						
Part No. <a href="#">PE3925</a>	Cable Dia.	Attn. @ 1 GHz	Power @ 1 GHz			
1 piece price shown. See web or call for volume pricing.						
6"	12"	18"	24"	36"	48"	Custom Len.
\$89.64	\$89.64	\$99.11	\$97.19	\$104.75	\$110.73	See Web
PE-SR401AL-STRAIGHT Coax, 50 Ohm						
Part No. <a href="#">PE34317</a>	Cable Dia.	Attn. @ 1 GHz	Power @ 1 GHz			
1 piece price shown. See web or call for volume pricing.						
6"	12"	18"	24"	36"	48"	Custom Len.
\$155.63	\$155.63	\$165.47	\$175.31	\$194.97	\$214.63	See Web
Standard Flexible Cable Assemblies						
RG59B/U Coax, 75 Ohm						
Part No. <a href="#">PE34160</a>	Cable Dia.	Attn. @ 1 GHz	Power @ 1 GHz			
1 piece price shown. See web or call for volume pricing.						
6"	12"	18"	24"	36"	48"	Custom Len.
\$76.50	\$76.99	\$77.51	\$77.96	\$78.94	\$79.95	See Web
RG179B/U Coax, 75 Ohm						
Part No. <a href="#">PE34135</a>	Cable Dia.	Attn. @ 1 GHz	Power @ 1 GHz			
1 piece price shown. See web or call for volume pricing.						
6"	12"	18"	24"	36"	48"	Custom Len.
\$67.55	\$68.85	\$70.18	\$71.43	\$74.08	\$76.71	See Web

**SMA MALE RIGHT ANGLE TO REVERSE POLARITY SMA MALE RIGHT ANGLE**



Standard Flexible Cable Assemblies						
RG174A/U Coax, 50 Ohm						
Part No. <a href="#">PE3W05106</a>	Cable Dia.	Attn. @ 1 GHz	Power @ 1 GHz			
1 piece price shown. See web or call for volume pricing.						
12"	24"	36"	48"	60"	50CM	Custom Len.
\$95.71	\$106.73	\$107.35	\$107.95	\$108.56	\$108.00	See Web

**SMA MALE RIGHT ANGLE TO REVERSE POLARITY SMA FEMALE**



Standard Flexible Cable Assemblies						
RG142B/U Coax, 50 Ohm						
Part No. <a href="#">PE3W03763</a>	Cable Dia.	Attn. @ 1 GHz	Power @ 1 GHz			
1 piece price shown. See web or call for volume pricing.						
12"	24"	36"	48"	60"	50CM	Custom Len.
\$73.28	\$79.76	\$86.25	\$92.74	\$99.24	\$77.43	See Web

**SMA MALE RIGHT ANGLE TO SMB PLUG**



Standard Flexible Cable Assemblies						
RG174A/U Coax, 50 Ohm						
Part No. <a href="#">PE33482</a>	Cable Dia.	Attn. @ 1 GHz	Power @ 1 GHz			
1 piece price shown. See web or call for volume pricing.						
12"	24"	36"	48"	60"	-	Custom Len.
\$73.10	\$73.74	\$74.36	\$75.03	\$75.68	-	See Web

**SMA MALE RIGHT ANGLE TO SMB PLUG RIGHT ANGLE**



Standard Formable Cable Assemblies						
PE-SR405FL Coax, 50 Ohm						
Part No. <a href="#">PE3W01739</a>	Cable Dia.	Attn. @ 1 GHz	Power @ 1 GHz			
1 piece price shown. See web or call for volume pricing.						
12"	24"	36"	48"	60"	50CM	Custom Len.
\$73.76	\$85.86	\$97.97	\$108.56	\$120.50	\$81.51	See Web

**SMA MALE RIGHT ANGLE TO SMC PLUG RIGHT ANGLE**



Standard Flexible Cable Assemblies						
------------------------------------	--	--	--	--	--	--

Cable Assemblies

See Our Website For Current Pricing & Real-Time Stock Availability!

Continued on Next Page

For Custom Lengths, Metric Lengths or Special Configurations, Please call (949) 261-1920

Technical Support  
+1 (949) 261-1920

Same-Day Shipping,  
Even Custom Cable Assemblies



For our complete selection of cable assemblies, please visit our website

Cable Assemblies

See Our Website For Current Pricing & Real-Time Stock Availability!

RG316/U Coax, 50 Ohm						
Part No. <a href="#">PE3740</a>	Cable Dia.	Attn. @ 1 GHz	Power @ 1 GHz			
1 piece price shown. See web or call for volume pricing.						
12"	24"	36"	48"	60"	50CM	Custom Len.
\$67.88	\$66.19	\$69.51	\$72.86	\$79.53	\$64.99	See Web

**SMA MALE RIGHT ANGLE TO SSMC PLUG**



**Low Loss Flexible Cable Assemblies**

LMR-100A-PVC Coax, 50 Ohm						
Part No. <a href="#">PE3C4424</a>	Cable Dia.	Attn. @ 1 GHz	Power @ 1 GHz			
1 piece price shown. See web or call for volume pricing.						
6"	12"	18"	24"	36"	48"	Custom Len.
\$65.74	\$66.18	\$66.57	\$66.99	\$67.79	\$68.61	See Web

**Standard Formable Cable Assemblies**

PE-SR405FLJ Coax, 50 Ohm						
Part No. <a href="#">PE3C4446</a>	Cable Dia.	Attn. @ 1 GHz	Power @ 1 GHz			
1 piece price shown. See web or call for volume pricing.						
6"	12"	18"	24"	36"	48"	Custom Len.
\$63.76	\$67.90	\$72.04	\$76.17	\$84.44	\$92.72	See Web

**Standard Flexible Cable Assemblies**

RG316/U Coax, 50 Ohm						
Part No. <a href="#">PE3C4407</a>	Cable Dia.	Attn. @ 1 GHz	Power @ 1 GHz			
1 piece price shown. See web or call for volume pricing.						
6"	12"	18"	24"	36"	48"	Custom Len.
\$69.23	\$70.71	\$72.20	\$73.66	\$76.64	\$79.59	See Web

**RG316-DS Coax, 50 Ohm**

Part No. <a href="#">PE3C4438</a>	Cable Dia.	Attn. @ 1 GHz	Power @ 1 GHz			
1 piece price shown. See web or call for volume pricing.						
6"	12"	18"	24"	36"	48"	Custom Len.
\$67.07	\$68.53	\$69.96	\$71.40	\$74.27	\$77.14	See Web

**SMA MALE RIGHT ANGLE TO SSMC PLUG RIGHT ANGLE**



**Low Loss Flexible Cable Assemblies**

LMR-100A-PVC Coax, 50 Ohm						
Part No. <a href="#">PE3C4425</a>	Cable Dia.	Attn. @ 1 GHz	Power @ 1 GHz			
1 piece price shown. See web or call for volume pricing.						
6"	12"	18"	24"	36"	48"	Custom Len.
\$61.99	\$66.15	\$62.80	\$63.21	\$64.02	\$64.83	See Web

**Standard Formable Cable Assemblies**

PE-SR405FLJ Coax, 50 Ohm						
Part No. <a href="#">PE3C4485</a>	Cable Dia.	Attn. @ 1 GHz	Power @ 1 GHz			
1 piece price shown. See web or call for volume pricing.						
6"	12"	18"	24"	36"	48"	Custom Len.
\$63.81	\$68.36	\$68.64	\$72.76	\$81.04	\$89.32	See Web

**Standard Flexible Cable Assemblies**

RG316/U Coax, 50 Ohm						
Part No. <a href="#">PE3C4408</a>	Cable Dia.	Attn. @ 1 GHz	Power @ 1 GHz			
1 piece price shown. See web or call for volume pricing.						
6"	12"	18"	24"	36"	48"	Custom Len.
\$68.37	\$76.91	\$71.47	\$72.99	\$76.09	\$79.16	See Web

**RG316-DS Coax, 50 Ohm**

Part No. <a href="#">PE3C4472</a>	Cable Dia.	Attn. @ 1 GHz	Power @ 1 GHz			
1 piece price shown. See web or call for volume pricing.						
6"	12"	18"	24"	36"	48"	Custom Len.
\$66.46	\$72.09	\$69.58	\$71.12	\$74.22	\$77.33	See Web

**SMA MALE RIGHT ANGLE TO SSMC JACK BULKHEAD**

SEE MOUNTING HOLE SECTION ON PAGE 409



**Standard Formable Cable Assemblies**

PE-SR405FLJ Coax, 50 Ohm						
Part No. <a href="#">PE3C4447</a>	Cable Dia.	Attn. @ 1 GHz	Power @ 1 GHz			
1 piece price shown. See web or call for volume pricing.						
6"	12"	18"	24"	36"	48"	Custom Len.
\$61.89	\$66.45	\$64.53	\$68.67	\$76.94	\$85.22	See Web

**SMA MALE RIGHT ANGLE TO TNC MALE**



**Low Loss Flexible Cable Assemblies**

PE-P142LL Coax, 50 Ohm						
Part No. <a href="#">PE3C1179</a>	Cable Dia.	Attn. @ 1 GHz	Power @ 1 GHz			
1 piece price shown. See web or call for volume pricing.						
6"	12"	24"	36"	48"	60"	Custom Len.
Call	\$242.53	\$260.13	\$277.74	\$295.33	\$312.93	See Web

**PE-P160LL Coax, 50 Ohm**

Part No. <a href="#">PE3C5261</a>	Cable Dia.	Attn. @ 1 GHz	Power @ 1 GHz			
1 piece price shown. See web or call for volume pricing.						
12"	24"	36"	48"	60"	50CM	Custom Len.
\$262.97	\$285.44	\$307.90	\$330.36	\$352.80	\$277.36	See Web

**PE-P142LL-27478 Coax, 50 Ohm**

Part No. <a href="#">PE3M0153</a>	Cable Dia.	Attn. @ 1 GHz	Power @ 1 GHz			
1 piece price shown. See web or call for volume pricing.						
12"	18"	24"	36"	48"	60"	Custom Len.
\$506.82	\$516.00	\$525.19	\$543.58	\$561.96	\$580.34	See Web

**PE-P160LL-27478 Coax, 50 Ohm**

Part No. <a href="#">PE3M0198</a>	Cable Dia.	Attn. @ 1 GHz	Power @ 1 GHz			
1 piece price shown. See web or call for volume pricing.						
8"	12"	18"	24"	36"	Custom Len.	
\$498.30	\$503.62	\$511.58	\$519.55	\$527.51	\$535.50	See Web

**PE-P300LL-27478 Coax, 50 Ohm**

Part No. <a href="#">PE3M0233</a>	Cable Dia.	Attn. @ 1 GHz	Power @ 1 GHz			
1 piece price shown. See web or call for volume pricing.						
12"	18"	24"	36"	48"	60"	Custom Len.
\$570.61	\$585.95	\$601.29	\$631.98	\$662.66	\$693.34	See Web

**Low Loss Test Flexible Cable Assemblies**

**PE-P300LL Coax, 50 Ohm**

Part No. <a href="#">PE3C1617</a>	Cable Dia.	Attn. @ 1 GHz	Power @ 1 GHz			
1 piece price shown. See web or call for volume pricing.						
12"	24"	36"	48"	60"	50CM	Custom Len.
\$302.94	\$330.25	\$357.56	\$384.85	\$412.16	\$320.45	See Web

**Standard Flexible Cable Assemblies**

**RG142B/U Coax, 50 Ohm**

Part No. <a href="#">PE3W06829</a>	Cable Dia.	Attn. @ 1 GHz	Power @ 1 GHz			
1 piece price shown. See web or call for volume pricing.						
12"	24"	36"	48"	60"	50CM	Custom Len.
\$68.50	\$74.97	\$81.46	\$87.94	\$94.43	\$72.63	See Web

**SMA MALE RIGHT ANGLE TO TNC MALE RIGHT ANGLE**



**Low Loss Flexible Cable Assemblies**

**PE-P142LL Coax, 50 Ohm**

Part No. <a href="#">PE3C1409</a>	Cable Dia.	Attn. @ 1 GHz	Power @ 1 GHz			
1 piece price shown. See web or call for volume pricing.						
12"	24"	36"	48"	60"	50CM	Custom Len.
\$349.76	\$347.56	\$365.16	\$382.77	\$401.79	\$341.23	See Web

**PE-P160LL Coax, 50 Ohm**

Part No. <a href="#">PE3C5262</a>	Cable Dia.	Attn. @ 1 GHz	Power @ 1 GHz			
1 piece price shown. See web or call for volume pricing.						
12"	24"	36"	48"	60"	50CM	Custom Len.
\$326.69	\$349.15	\$371.60	\$394.05	\$416.52	\$341.08	See Web

**PE-P142LL-27478 Coax, 50 Ohm**

Part No. <a href="#">PE3M0155</a>	Cable Dia.	Attn. @ 1 GHz	Power @ 1 GHz			
1 piece price shown. See web or call for volume pricing.						
12"	18"	24"	36"	48"	60"	Custom Len.
\$622.48	\$631.67	\$640.86	\$659.24	\$677.63	\$696.01	See Web

**PE-P160LL-27478 Coax, 50 Ohm**

Part No. <a href="#">PE3M0200</a>	Cable Dia.	Attn. @ 1 GHz	Power @ 1 GHz			
1 piece price shown. See web or call for volume pricing.						
8"	12"	18"	24"	36"	Custom Len.	
\$590.46	\$595.79	\$603.74	\$611.72	\$619.68	\$627.66	See Web

**PE-P300LL-27478 Coax, 50 Ohm**

Part No. <a href="#">PE3M0234</a>	Cable Dia.	Attn. @ 1 GHz	Power @ 1 GHz			
1 piece price shown. See web or call for volume pricing.						
12"	18"	24"	36"	48"	60"	Custom Len.
\$727.04	\$742.37	\$757.71	\$788.40	\$819.09	\$849.77	See Web

**SMA MALE RIGHT ANGLE TO TNC FEMALE BULKHEAD**

SEE MOUNTING HOLE SECTION ON PAGE 409



**Semi-Rigid Cable Assemblies**

**PE-SR402AL Coax, 50 Ohm**

Part No. <a href="#">PE3C2604</a>	Cable Dia.	Attn. @ 1 GHz	Power @ 1 GHz			
1 piece price shown. See web or call for volume pricing.						
12"	24"	36"	48"	60"	50CM	Custom Len.
\$89.94	\$100.96	\$106.48	\$115.88	\$126.75	\$91.48	See Web

**Low Loss Flexible Cable Assemblies**

**LMR-195 Coax, 50 Ohm**

Part No. <a href="#">PE3C0056</a>	Cable Dia.	Attn. @ 1 GHz	Power @ 1 GHz			
1 piece price shown. See web or call for volume pricing.						
12"	24"	36"	48"	60"	Custom Len.	
\$58.63	\$59.45	\$55.93	\$56.75	\$57.58	-	See Web

**PE-P142LL Coax, 50 Ohm**

Part No. <a href="#">PE3C1173</a>	Cable Dia.	Attn. @ 1 GHz	Power @ 1 GHz			
1 piece price shown. See web or call for volume pricing.						
12"	24"	36"	48"	60"	50CM	Custom Len.
\$297.69	\$298.44	\$316.04	\$333.65	\$351.26	\$292.12	See Web

\*Coax Performance at 1 GHz Notes: Cable assembly max frequency may be lower than connector or coax max frequency

For our complete selection of cable assemblies, please visit our website

PE-P160LL Coax, 50 Ohm						
Part No. <a href="#">PE3C5263</a>	Cable Dia.			Attn. @ 1 GHz	Power @ 1 GHz	
1 piece price shown. See web or call for volume pricing.						
12"	24"	36"	48"	60"	50CM	Custom Len.
\$291.47	\$313.95	\$336.40	\$358.84	\$381.31	\$305.86	See Web
PE-P142LL-27478 Coax, 50 Ohm						
Part No. <a href="#">PE3M0154</a>	Cable Dia.			Attn. @ 1 GHz	Power @ 1 GHz	
1 piece price shown. See web or call for volume pricing.						
12"	18"	24"	36"	48"	60"	Custom Len.
\$592.32	\$601.50	\$610.69	\$629.08	\$647.46	\$665.84	See Web
PE-P160LL-27478 Coax, 50 Ohm						
Part No. <a href="#">PE3M0199</a>	Cable Dia.			Attn. @ 1 GHz	Power @ 1 GHz	
1 piece price shown. See web or call for volume pricing.						
8"	12"	18"	24"	30"	36"	Custom Len.
\$586.19	\$591.52	\$599.47	\$607.45	\$615.42	\$623.38	See Web
Precision Formable Cable Assemblies						
PE-SR402FL Coax, 50 Ohm						
Part No. <a href="#">PE39484</a>	Cable Dia.			Attn. @ 1 GHz	Power @ 1 GHz	
1 piece price shown. See web or call for volume pricing.						
6"	9"	12"	18"	24"	-	Custom Len.
\$51.85	\$48.00	\$51.85	\$55.79	\$60.20	-	See Web
PE-SR402FLJ Coax, 50 Ohm						
Part No. <a href="#">PE39498</a>	Cable Dia.			Attn. @ 1 GHz	Power @ 1 GHz	
1 piece price shown. See web or call for volume pricing.						
6"	9"	12"	18"	24"	-	Custom Len.
\$55.78	\$52.12	Call	Call	Call	-	See Web
PE-SR405FL Coax, 50 Ohm						
Part No. <a href="#">PE39476</a>	Cable Dia.			Attn. @ 1 GHz	Power @ 1 GHz	
1 piece price shown. See web or call for volume pricing.						
2.500'/	6"	9"	12"	18"	24"	Custom Len.
Call	\$56.86	\$58.59	\$56.86	\$63.23	Call	See Web
Standard Formable Cable Assemblies						
PE-SR402FL Coax, 50 Ohm						
Part No. <a href="#">PE3W00169</a>	Cable Dia.			Attn. @ 1 GHz	Power @ 1 GHz	
1 piece price shown. See web or call for volume pricing.						
12"	24"	36"	48"	60"	50CM	Custom Len.
\$89.45	\$98.08	\$106.70	\$113.73	\$124.60	\$95.37	See Web
PE-SR405FLJ Coax, 50 Ohm						
Part No. <a href="#">PE39490</a>	Cable Dia.			Attn. @ 1 GHz	Power @ 1 GHz	
1 piece price shown. See web or call for volume pricing.						
6"	9"	12"	18"	24"	-	Custom Len.
\$58.85	\$49.41	\$58.85	\$63.61	\$68.35	-	See Web
Standard Flexible Cable Assemblies						
RG316/U Coax, 50 Ohm						
Part No. <a href="#">PE33073</a>	Cable Dia.			Attn. @ 1 GHz	Power @ 1 GHz	
1 piece price shown. See web or call for volume pricing.						
12"	24"	36"	48"	60"	-	Custom Len.
\$88.13	\$91.56	\$89.47	\$98.63	\$95.83	-	See Web
RG400/U Coax, 50 Ohm						
Part No. <a href="#">PE33759</a>	Cable Dia.			Attn. @ 1 GHz	Power @ 1 GHz	
1 piece price shown. See web or call for volume pricing.						
12"	24"	36"	48"	60"	-	Custom Len.
\$86.71	\$87.95	\$95.62	\$103.29	\$109.40	-	See Web
SMA MALE RIGHT ANGLE TO REVERSE POLARITY TNC MALE RIGHT ANGLE						
Flexible Flexible Cable Assemblies						
RG142B/U Coax, 50 Ohm						
Part No. <a href="#">PE3C7914</a>	Cable Dia.			Attn. @ 1 GHz	Power @ 1 GHz	
1 piece price shown. See web or call for volume pricing.						
12"	24"	36"	48"	60"	50CM	Custom Len.
\$85.59	\$91.97	\$98.34	\$104.71	\$109.54	\$83.31	See Web
SMA MALE RIGHT ANGLE TO NEX10 MALE						
Low PIM Corrugated Cable Assemblies						
SPP-250-LLPL Coax, 50 Ohm						
Part No. <a href="#">PE3C6259</a>	Cable Dia.			Attn. @ 1 GHz	Power @ 1 GHz	
1 piece price shown. See web or call for volume pricing.						
12"	24"	36"	48"	60"	50CM	Custom Len.
\$66.18	\$72.31	\$78.45	\$84.58	\$90.71	\$70.09	See Web
REVERSE POLARITY SMA MALE RIGHT ANGLE TO N MALE						
Standard Flexible Cable Assemblies						
RG400/U Coax, 50 Ohm						
Part No. <a href="#">PE35991</a>	Cable Dia.			Attn. @ 1 GHz	Power @ 1 GHz	
1 piece price shown. See web or call for volume pricing.						
12"	24"	36"	48"	60"	-	Custom Len.
\$91.11	\$106.54	\$113.05	\$121.55	\$120.07	-	See Web

REVERSE POLARITY SMA MALE RIGHT ANGLE TO N MALE RIGHT ANGLE						
Low Loss Flexible Cable Assemblies						
LMR-195 Coax, 50 Ohm						
Part No. <a href="#">PE3W02390</a>	Cable Dia.			Attn. @ 1 GHz	Power @ 1 GHz	
1 piece price shown. See web or call for volume pricing.						
12"	24"	36"	48"	60"	50CM	Custom Len.
\$81.40	\$82.20	\$82.99	\$83.80	\$84.60	\$81.92	See Web
REVERSE POLARITY SMA MALE RIGHT ANGLE TO SMA MALE						
Standard Flexible Cable Assemblies						
RG400/U Coax, 50 Ohm						
Part No. <a href="#">PE3W06085</a>	Cable Dia.			Attn. @ 1 GHz	Power @ 1 GHz	
1 piece price shown. See web or call for volume pricing.						
12"	24"	36"	48"	60"	50CM	Custom Len.
\$91.46	\$99.84	\$106.71	\$114.96	\$123.23	\$88.46	See Web
SMA FEMALE TO FAKRA PLUG						
Low Loss Flexible Cable Assemblies						
PE-C100-LSZH Coax, 50 Ohm						
Part No. <a href="#">PE39344A</a>	Cable Dia.			Attn. @ 1 GHz	Power @ 1 GHz	
1 piece price shown. See web or call for volume pricing.						
12"	24"	36"	48"	60"	-	Custom Len.
\$45.75	\$42.91	\$44.25	\$45.59	\$46.94	-	See Web
Part No. <a href="#">PE39344C</a>	Cable Dia.			Attn. @ 1 GHz	Power @ 1 GHz	
1 piece price shown. See web or call for volume pricing.						
12"	24"	36"	48"	60"	-	Custom Len.
\$45.75	\$42.91	\$44.25	\$45.59	\$46.94	-	See Web
Part No. <a href="#">PE39344D</a>	Cable Dia.			Attn. @ 1 GHz	Power @ 1 GHz	
1 piece price shown. See web or call for volume pricing.						
12"	24"	36"	48"	60"	-	Custom Len.
\$45.75	\$47.21	\$44.25	\$45.59	\$46.94	-	See Web
Part No. <a href="#">PE39344H</a>	Cable Dia.			Attn. @ 1 GHz	Power @ 1 GHz	
1 piece price shown. See web or call for volume pricing.						
12"	24"	36"	48"	60"	-	Custom Len.
\$47.09	\$44.16	\$45.50	\$46.82	\$48.17	-	See Web
Part No. <a href="#">PE39344J</a>	Cable Dia.			Attn. @ 1 GHz	Power @ 1 GHz	
1 piece price shown. See web or call for volume pricing.						
12"	24"	36"	48"	60"	-	Custom Len.
\$45.75	\$42.91	\$44.25	\$45.59	\$46.94	-	See Web
Part No. <a href="#">PE39344K</a>	Cable Dia.			Attn. @ 1 GHz	Power @ 1 GHz	
1 piece price shown. See web or call for volume pricing.						
12"	24"	36"	48"	60"	-	Custom Len.
\$41.59	\$47.21	\$44.25	\$45.59	\$46.94	-	See Web
Part No. <a href="#">PE39344Z</a>	Cable Dia.			Attn. @ 1 GHz	Power @ 1 GHz	
1 piece price shown. See web or call for volume pricing.						
12"	24"	36"	48"	60"	-	Custom Len.
\$41.59	\$46.38	\$44.25	\$45.59	\$46.94	-	See Web
Standard Flexible Cable Assemblies						
RG174A/U Coax, 50 Ohm						
Part No. <a href="#">PE39345A</a>	Cable Dia.			Attn. @ 1 GHz	Power @ 1 GHz	
1 piece price shown. See web or call for volume pricing.						
12"	24"	36"	48"	60"	32 dB/100ft	16 W
\$49.32	\$49.92	\$50.45	\$51.05	\$51.65	-	See Web
Part No. <a href="#">PE39345C</a>	Cable Dia.			Attn. @ 1 GHz	Power @ 1 GHz	
1 piece price shown. See web or call for volume pricing.						
12"	24"	36"	48"	60"	32 dB/100ft	16 W
\$54.24	\$49.92	\$50.45	\$51.05	\$51.65	-	See Web
Part No. <a href="#">PE39345D</a>	Cable Dia.			Attn. @ 1 GHz	Power @ 1 GHz	
1 piece price shown. See web or call for volume pricing.						
12"	24"	36"	48"	60"	32 dB/100ft	16 W
\$49.32	\$49.92	\$50.45	\$51.05	\$51.65	-	See Web
Part No. <a href="#">PE39345H</a>	Cable Dia.			Attn. @ 1 GHz	Power @ 1 GHz	
1 piece price shown. See web or call for volume pricing.						
12"	24"	36"	48"	60"	32 dB/100ft	16 W
\$49.32	\$49.92	\$50.45	\$51.05	\$51.65	-	See Web
Part No. <a href="#">PE39345I</a>	Cable Dia.			Attn. @ 1 GHz	Power @ 1 GHz	
1 piece price shown. See web or call for volume pricing.						
12"	24"	36"	48"	60"	32 dB/100ft	16 W
\$49.32	\$49.92	\$50.45	\$51.05	\$51.65	-	See Web
Part No. <a href="#">PE39345K</a>	Cable Dia.			Attn. @ 1 GHz	Power @ 1 GHz	
1 piece price shown. See web or call for volume pricing.						
12"	24"	36"	48"	60"	32 dB/100ft	16 W
\$49.32	\$49.92	\$50.45	\$51.05	\$51.65	-	See Web

Cable Assemblies See Our Website For Current Pricing & Real-Time Stock Availability!

For Custom Lengths, Metric Lengths or Special Configurations, Please call (949) 261-1920



Technical Support  
+1 (949) 261-1920



Same-Day Shipping,  
Even Custom Cable Assemblies

For our complete selection of cable assemblies, please visit our website

Cable Assemblies  
See Our Website For Current Pricing & Real-Time Stock Availability!

Part No.	Cable Dia.				Attn. @ 1 GHz	Power @ 1 GHz
Part No. <b>PE39345Z</b>	1 piece price shown. See web or call for volume pricing.				0.1" dia.	32 dB/100ft 16 W
12"	24"	36"	48"	60"	-	Custom Len.
\$54.24	\$49.92	\$50.45	\$51.05	\$51.65	-	See Web
<b>RG316/U Coax, 50 Ohm</b>						
Part No. <b>PE39346A</b>	1 piece price shown. See web or call for volume pricing.				0.098" dia.	38 dB/100ft 160 W
12"	24"	36"	48"	60"	-	Custom Len.
\$56.59	\$59.75	\$62.95	\$66.12	\$69.30	-	See Web
Part No. <b>PE39346C</b>	1 piece price shown. See web or call for volume pricing.				0.098" dia.	38 dB/100ft 160 W
12"	24"	36"	48"	60"	-	Custom Len.
\$51.92	\$54.60	\$57.77	\$60.94	\$64.10	-	See Web
Part No. <b>PE39346D</b>	1 piece price shown. See web or call for volume pricing.				0.098" dia.	38 dB/100ft 160 W
12"	24"	36"	48"	60"	-	Custom Len.
\$51.92	\$54.60	\$57.77	\$60.94	\$64.10	-	See Web
Part No. <b>PE39346H</b>	1 piece price shown. See web or call for volume pricing.				0.098" dia.	38 dB/100ft 160 W
12"	24"	36"	48"	60"	-	Custom Len.
\$51.92	\$54.60	\$57.77	\$60.94	\$64.10	-	See Web
Part No. <b>PE39346J</b>	1 piece price shown. See web or call for volume pricing.				0.098" dia.	38 dB/100ft 160 W
12"	24"	36"	48"	60"	-	Custom Len.
\$56.59	\$59.75	\$62.95	\$66.12	\$69.30	-	See Web
Part No. <b>PE39346K</b>	1 piece price shown. See web or call for volume pricing.				0.098" dia.	38 dB/100ft 160 W
12"	24"	36"	48"	60"	-	Custom Len.
\$56.58	\$54.60	\$57.77	\$60.94	\$64.10	-	See Web
Part No. <b>PE39346Z</b>	1 piece price shown. See web or call for volume pricing.				0.098" dia.	38 dB/100ft 160 W
12"	24"	36"	48"	60"	-	Custom Len.
\$51.92	\$54.60	\$57.77	\$60.94	\$64.10	-	See Web
<b>SMA FEMALE TO FAKRA JACK</b>						
<b>Low Loss Flexible Cable Assemblies</b>						
<b>PE-C100-LSZH Coax, 50 Ohm</b>						
Part No. <b>PE39349A</b>	1 piece price shown. See web or call for volume pricing.				0.109" dia.	25 dB/100ft
12"	24"	36"	48"	60"	-	Custom Len.
\$45.75	\$42.91	\$44.25	\$45.59	\$46.94	-	See Web
Part No. <b>PE39349B</b>	1 piece price shown. See web or call for volume pricing.				0.109" dia.	25 dB/100ft
12"	24"	36"	48"	60"	-	Custom Len.
\$45.75	\$42.91	\$44.25	\$45.59	\$46.94	-	See Web
Part No. <b>PE39349C</b>	1 piece price shown. See web or call for volume pricing.				0.109" dia.	25 dB/100ft
12"	24"	36"	48"	60"	-	Custom Len.
\$45.75	\$42.91	\$44.25	\$45.59	\$51.74	-	See Web
Part No. <b>PE39349D</b>	1 piece price shown. See web or call for volume pricing.				0.109" dia.	25 dB/100ft
12"	24"	36"	48"	60"	-	Custom Len.
\$43.27	\$44.74	\$43.51	\$44.84	\$49.27	-	See Web
Part No. <b>PE39349H</b>	1 piece price shown. See web or call for volume pricing.				0.109" dia.	25 dB/100ft
12"	24"	36"	48"	60"	-	Custom Len.
\$45.75	\$42.91	\$44.25	\$45.59	\$46.94	-	See Web
Part No. <b>PE39349J</b>	1 piece price shown. See web or call for volume pricing.				0.109" dia.	25 dB/100ft
12"	24"	36"	48"	60"	-	Custom Len.
\$45.75	\$42.91	\$44.25	\$45.59	\$46.94	-	See Web
Part No. <b>PE39349K</b>	1 piece price shown. See web or call for volume pricing.				0.109" dia.	25 dB/100ft
12"	24"	36"	48"	60"	-	Custom Len.
\$41.59	\$47.21	\$44.25	\$45.59	\$46.94	-	See Web
Part No. <b>PE39349Z</b>	1 piece price shown. See web or call for volume pricing.				0.109" dia.	25 dB/100ft
12"	24"	36"	48"	60"	-	Custom Len.
\$45.75	\$42.91	\$48.68	\$45.59	\$51.74	-	See Web
<b>Standard Flexible Cable Assemblies</b>						
<b>RG174A/U Coax, 50 Ohm</b>						
Part No. <b>PE39350A</b>	1 piece price shown. See web or call for volume pricing.				0.1" dia.	32 dB/100ft 16 W
12"	24"	36"	48"	60"	-	Custom Len.
\$54.24	\$54.23	\$54.71	\$55.18	\$55.68	-	See Web
Part No. <b>PE39350B</b>	1 piece price shown. See web or call for volume pricing.				0.1" dia.	32 dB/100ft 16 W
12"	24"	36"	48"	60"	-	Custom Len.
\$53.27	\$53.75	\$54.22	\$54.21	\$54.69	-	See Web
Part No. <b>PE39350C</b>	1 piece price shown. See web or call for volume pricing.				0.1" dia.	32 dB/100ft 16 W
12"	24"	36"	48"	60"	-	Custom Len.
\$54.24	\$54.23	\$54.71	\$55.18	\$55.68	-	See Web



Part No.	Cable Dia.				Attn. @ 1 GHz	Power @ 1 GHz
Part No. <b>PE39350D</b>	1 piece price shown. See web or call for volume pricing.				0.1" dia.	32 dB/100ft 16 W
12"	24"	36"	48"	60"	-	Custom Len.
\$52.28	\$49.92	\$50.45	\$51.05	\$51.65	-	See Web
Part No. <b>PE39350H</b>	1 piece price shown. See web or call for volume pricing.				0.1" dia.	32 dB/100ft 16 W
12"	24"	36"	48"	60"	-	Custom Len.
\$49.32	\$49.92	\$50.45	\$51.05	\$51.65	-	See Web
Part No. <b>PE39350I</b>	1 piece price shown. See web or call for volume pricing.				0.1" dia.	32 dB/100ft 16 W
12"	24"	36"	48"	60"	-	Custom Len.
\$49.32	\$49.92	\$50.45	\$51.05	\$51.65	-	See Web
Part No. <b>PE39350K</b>	1 piece price shown. See web or call for volume pricing.				0.1" dia.	32 dB/100ft 16 W
12"	24"	36"	48"	60"	-	Custom Len.
\$54.24	\$54.23	\$54.71	\$55.18	\$55.68	-	See Web
Part No. <b>PE39350Z</b>	1 piece price shown. See web or call for volume pricing.				0.1" dia.	32 dB/100ft 16 W
12"	24"	36"	48"	60"	-	Custom Len.
\$59.13	\$54.23	\$54.71	\$55.18	\$55.68	-	See Web
<b>RG316/U Coax, 50 Ohm</b>						
Part No. <b>PE39351A</b>	1 piece price shown. See web or call for volume pricing.				0.098" dia.	38 dB/100ft 160 W
12"	24"	36"	48"	60"	-	Custom Len.
\$56.59	\$59.75	\$62.95	\$66.12	\$69.30	-	See Web
Part No. <b>PE39351B</b>	1 piece price shown. See web or call for volume pricing.				0.098" dia.	38 dB/100ft 160 W
12"	24"	36"	48"	60"	-	Custom Len.
\$51.92	\$54.60	\$57.77	\$60.94	\$64.10	-	See Web
Part No. <b>PE39351C</b>	1 piece price shown. See web or call for volume pricing.				0.098" dia.	38 dB/100ft 160 W
12"	24"	36"	48"	60"	-	Custom Len.
\$62.23	\$59.75	\$62.95	\$66.12	\$69.30	-	See Web
Part No. <b>PE39351D</b>	1 piece price shown. See web or call for volume pricing.				0.098" dia.	38 dB/100ft 160 W
12"	24"	36"	48"	60"	-	Custom Len.
\$56.59	\$59.75	\$62.95	\$66.12	\$69.30	-	See Web
Part No. <b>PE39351H</b>	1 piece price shown. See web or call for volume pricing.				0.098" dia.	38 dB/100ft 160 W
12"	24"	36"	48"	60"	-	Custom Len.
\$51.92	\$54.60	\$57.77	\$60.94	\$64.10	-	See Web
Part No. <b>PE39351J</b>	1 piece price shown. See web or call for volume pricing.				0.098" dia.	38 dB/100ft 160 W
12"	24"	36"	48"	60"	-	Custom Len.
\$51.92	\$54.60	\$57.77	\$60.94	\$64.10	-	See Web
Part No. <b>PE39351K</b>	1 piece price shown. See web or call for volume pricing.				0.098" dia.	38 dB/100ft 160 W
12"	24"	36"	48"	60"	-	Custom Len.
\$51.92	\$54.60	\$57.77	\$60.94	\$64.10	-	See Web
<b>SMA FEMALE TO MCX PLUG RIGHT ANGLE</b>						
<b>Standard Formable Cable Assemblies</b>						
<b>PE-SR405FLJ Coax, 50 Ohm</b>						
Part No. <b>PE3W03859</b>	1 piece price shown. See web or call for volume pricing.				0.105" dia.	19.5 dB/100ft 121.5 W
12"	24"	36"	48"	60"	-	Custom Len.
\$74.14	\$83.99	\$93.82	\$103.67	\$111.95	\$80.44	See Web
<b>SMA FEMALE TO MMCX PLUG</b>						
<b>Standard Flexible Cable Assemblies</b>						
<b>RG188-DS Coax, 50 Ohm</b>						
Part No. <b>PE3W03032</b>	1 piece price shown. See web or call for volume pricing.				0.118" dia.	30 dB/100ft 160 W
12"	24"	36"	48"	60"	-	Custom Len.
\$65.26	\$69.33	\$73.40	\$77.45	\$81.52	\$67.87	See Web
<b>SMA FEMALE TO N MALE</b>						
<b>Low Loss Flexible Cable Assemblies</b>						
<b>PE-P142LL-27478 Coax, 50 Ohm</b>						
Part No. <b>PE3M0141</b>	1 piece price shown. See web or call for volume pricing.				0.195" dia.	
12"	18"	24"	36"	48"	60"	Custom Len.
\$461.57	\$470.76	\$479.95	\$498.33	\$516.71	\$535.10	See Web



\*Coax Performance at 1 GHz Notes: Cable assembly max frequency may be lower than connector or coax max frequency



For our complete selection of cable assemblies, please visit our website

Precision Flexible Cable Assemblies						
PE-P141 Coax, 50 Ohm						
Part No. <a href="#">PE356</a>	Cable Dia.			Attn. @ 1 GHz	Power @ 1 GHz	
1 piece price shown. See web or call for volume pricing.	0.163" dia.					
12"	24"	36"	48"	60"	72"	Custom Len.
\$188.89	\$189.82	\$213.52	\$226.54	\$224.62	\$251.63	See Web

**SMA FEMALE TO N MALE RIGHT ANGLE**



**Low Loss Flexible Cable Assemblies**

PE-P142LL-27478 Coax, 50 Ohm						
Part No. <a href="#">PE3M0143</a>	Cable Dia.			Attn. @ 1 GHz	Power @ 1 GHz	
1 piece price shown. See web or call for volume pricing.	0.195" dia.					
12"	18"	24"	36"	48"	60"	Custom Len.
\$586.28	\$595.47	\$604.65	\$623.04	\$641.42	\$659.80	See Web

**SMA FEMALE TO N FEMALE BULKHEAD**



SEE MOUNTING HOLE SECTION ON PAGE 409

**Low Loss Flexible Cable Assemblies**

PE-P142LL Coax, 50 Ohm						
Part No. <a href="#">PE3C3159</a>	Cable Dia.			Attn. @ 1 GHz	Power @ 1 GHz	
1 piece price shown. See web or call for volume pricing.	0.195" dia.			10 dB/100ft		
12"	24"	36"	48"	60"	50CM	Custom Len.
\$212.90	\$229.98	\$247.08	\$264.17	\$281.25	\$223.85	See Web

PE-P142LL-27478 Coax, 50 Ohm						
Part No. <a href="#">PE3M0142</a>	Cable Dia.			Attn. @ 1 GHz	Power @ 1 GHz	
1 piece price shown. See web or call for volume pricing.	0.195" dia.					
12"	18"	24"	36"	48"	60"	Custom Len.
\$556.09	\$565.29	\$574.48	\$592.87	\$611.24	\$629.63	See Web

**SMA FEMALE TO QMA MALE**



**Low Loss Flexible Cable Assemblies**

PE-C195 Coax, 50 Ohm						
Part No. <a href="#">PE38278</a>	Cable Dia.			Attn. @ 1 GHz	Power @ 1 GHz	
1 piece price shown. See web or call for volume pricing.	0.195" dia.			11.3 dB/100ft	150 W	
12"	24"	36"	48"	60"	72"	Custom Len.
\$54.37	\$54.66	\$55.39	\$56.19	\$56.91	\$57.64	See Web

**Standard Flexible Cable Assemblies**

RG58C/U Coax, 50 Ohm						
Part No. <a href="#">PE38277</a>	Cable Dia.			Attn. @ 1 GHz	Power @ 1 GHz	
1 piece price shown. See web or call for volume pricing.	0.195" dia.			20 dB/100ft	44 W	
12"	24"	36"	48"	60"	72"	Custom Len.
\$60.55	\$66.27	\$62.19	\$62.99	\$63.78	\$64.56	See Web

RG316/U Coax, 50 Ohm						
Part No. <a href="#">PE38276</a>	Cable Dia.			Attn. @ 1 GHz	Power @ 1 GHz	
1 piece price shown. See web or call for volume pricing.	0.098" dia.			38 dB/100ft	160 W	
12"	24"	36"	48"	60"	72"	Custom Len.
\$75.44	\$78.88	\$76.19	\$79.37	\$82.56	\$85.72	See Web

RG316-DS Coax, 50 Ohm						
Part No. <a href="#">PE38052</a>	Cable Dia.			Attn. @ 1 GHz	Power @ 1 GHz	
1 piece price shown. See web or call for volume pricing.	0.114" dia.			26.1 dB/100ft	160 W	
12"	24"	36"	48"	60"	72"	Custom Len.
\$84.96	\$88.20	\$91.43	\$94.65	\$97.83	\$101.05	See Web

**SMA FEMALE TO SMA MALE RIGHT ANGLE**



**Low Loss Flexible Cable Assemblies**

PE-P142LL-27478 Coax, 50 Ohm						
Part No. <a href="#">PE3M0137</a>	Cable Dia.			Attn. @ 1 GHz	Power @ 1 GHz	
1 piece price shown. See web or call for volume pricing.	0.195" dia.					
12"	18"	24"	36"	48"	60"	Custom Len.
\$558.11	\$567.30	\$576.50	\$594.88	\$613.26	\$631.65	See Web

**Standard Flexible Cable Assemblies**

RG174A/U Coax, 50 Ohm						
Part No. <a href="#">PE3W03981</a>	Cable Dia.			Attn. @ 1 GHz	Power @ 1 GHz	
1 piece price shown. See web or call for volume pricing.	0.11" dia.			32 dB/100ft	17 W	
12"	24"	36"	48"	60"	50CM	Custom Len.
\$54.01	\$54.13	\$54.75	\$55.37	\$55.98	\$54.41	See Web

**SMA FEMALE TO SMA FEMALE**



**Low Loss Flexible Cable Assemblies**

LMR-100A-PVC Coax, 50 Ohm						
Part No. <a href="#">PE3C0045</a>	Cable Dia.			Attn. @ 1 GHz	Power @ 1 GHz	
1 piece price shown. See web or call for volume pricing.	0.11" dia.			24 dB/100ft		
12"	24"	36"	48"	60"	-	Custom Len.
\$63.41	\$59.55	\$60.37	\$61.21	\$66.81	-	See Web

PE-P142LL Coax, 50 Ohm						
Part No. <a href="#">PE3C1239</a>	Cable Dia.			Attn. @ 1 GHz	Power @ 1 GHz	
1 piece price shown. See web or call for volume pricing.	0.195" dia.			10 dB/100ft		
12"	24"	36"	48"	60"	50CM	Custom Len.
\$198.40	\$216.01	\$233.61	\$251.22	\$268.82	\$209.69	See Web

PE-P142LL-27478 Coax, 50 Ohm						
Part No. <a href="#">PE3M0135</a>	Cable Dia.			Attn. @ 1 GHz	Power @ 1 GHz	
1 piece price shown. See web or call for volume pricing.	0.195" dia.					
12"	18"	24"	36"	48"	60"	Custom Len.
\$521.91	\$531.10	\$540.30	\$558.67	\$577.06	\$595.45	See Web

**Standard Formable Cable Assemblies**

PE-SR047FL Coax, 50 Ohm						
Part No. <a href="#">PE34833</a>	Cable Dia.			Attn. @ 1 GHz	Power @ 1 GHz	
1 piece price shown. See web or call for volume pricing.	0.047" dia.			36 dB/100ft	32 W	
12"	12"	18"	24"	36"	48"	Custom Len.
\$120.38	\$115.43	\$119.42	\$133.46	\$131.42	\$139.40	See Web

PE-SR401FL Coax, 50 Ohm						
Part No. <a href="#">PE3534</a>	Cable Dia.			Attn. @ 1 GHz	Power @ 1 GHz	
1 piece price shown. See web or call for volume pricing.	0.195" dia.			7.6 dB/100ft	1,400 W	
6"	12"	18"	24"	36"	48"	Custom Len.
\$98.10	\$106.27	\$112.94	\$120.99	\$137.19	\$153.40	See Web

PE-SR402FL Coax, 50 Ohm						
Part No. <a href="#">PE33964</a>	Cable Dia.			Attn. @ 1 GHz	Power @ 1 GHz	
1 piece price shown. See web or call for volume pricing.	0.195" dia.			11.88 dB/100ft	450 W	
6"	12"	18"	24"	36"	48"	Custom Len.
\$68.23	\$68.23	\$72.38	\$76.51	\$84.80	\$93.10	See Web

PE-SR405FL Coax, 50 Ohm						
Part No. <a href="#">PE34292</a>	Cable Dia.			Attn. @ 1 GHz	Power @ 1 GHz	
1 piece price shown. See web or call for volume pricing.	0.195" dia.			22.5 dB/100ft	130 W	
6"	12"	18"	24"	36"	48"	Custom Len.
\$96.35	\$96.35	\$102.73	\$107.58	\$120.16	\$132.73	See Web

**Standard Flexible Cable Assemblies**

RG58C/U Coax, 50 Ohm						
Part No. <a href="#">PE33547</a>	Cable Dia.			Attn. @ 1 GHz	Power @ 1 GHz	
1 piece price shown. See web or call for volume pricing.	0.195" dia.			20 dB/100ft	44 W	
12"	24"	36"	48"	60"	-	Custom Len.
\$69.41	\$65.07	\$65.88	\$72.14	\$67.50	-	See Web

RG142B/U Coax, 50 Ohm						
Part No. <a href="#">PE3578</a>	Cable Dia.			Attn. @ 1 GHz	Power @ 1 GHz	
1 piece price shown. See web or call for volume pricing.	0.195" dia.			13 dB/100ft	650 W	
12"	24"	36"	48"	60"	-	Custom Len.
\$52.71	\$58.52	\$64.83	\$76.84	\$77.42	-	See Web

RG174A/U Coax, 50 Ohm						
Part No. <a href="#">PE33120</a>	Cable Dia.			Attn. @ 1 GHz	Power @ 1 GHz	
1 piece price shown. See web or call for volume pricing.	0.11" dia.			32 dB/100ft	17 W	
12"	24"	36"	48"	60"	-	Custom Len.
\$63.63	\$69.35	\$64.57	\$70.66	\$65.55	-	See Web

RG223/U Coax, 50 Ohm						
Part No. <a href="#">PE33254</a>	Cable Dia.			Attn. @ 1 GHz	Power @ 1 GHz	
1 piece price shown. See web or call for volume pricing.	0.21" dia.			13.4 dB/100ft	53 W	
12"	24"	36"	48"	60"	-	Custom Len.
\$47.11	\$50.05	\$52.98	\$59.97	\$58.35	-	See Web

RG316/U Coax, 50 Ohm						
Part No. <a href="#">PE33047</a>	Cable Dia.			Attn. @ 1 GHz	Power @ 1 GHz	
1 piece price shown. See web or call for volume pricing.	0.102" dia.			38 dB/100ft		
12"	24"	36"	48"	60"	-	Custom Len.
\$70.33	\$73.77	\$72.69	\$80.84	\$84.35	-	See Web

**Standard Semi-Rigid Cable Assemblies**

PE-020SR Coax, 50 Ohm						
Part No. <a href="#">PE34917</a>	Cable Dia.			Attn. @ 1 GHz	Power @ 1 GHz	
1 piece price shown. See web or call for volume pricing.	0.195" dia.			85 dB/100ft	2.9 W	
6"	12"	18"	24"	36"	48"	Custom Len.
\$185.65	\$196.77	\$195.46	\$205.29	\$224.96	\$244.65	See Web

PE-034SR Coax, 50 Ohm						
Part No. <a href="#">PE34405</a>	Cable Dia.			Attn. @ 1 GHz	Power @ 1 GHz	
1 piece price shown. See web or call for volume pricing.	0.195" dia.			60 dB/100ft	10 W	
6"	12"	18"	24"	36"	48"	Custom Len.
\$163.99	\$170.46	\$167.48	\$174.14	\$187.46	\$200.78	See Web

PE-047SR Coax, 50 Ohm						
Part No. <a href="#">PE3758</a>	Cable Dia.			Attn. @ 1 GHz	Power @ 1 GHz	
1 piece price shown. See web or call for volume pricing.	0.195" dia.			40 dB/100ft	32 W	
6"	12"	18"	24"	36"	48"	Custom Len.
\$115.30	\$121.13	\$122.01	\$133.13	\$145.11	\$149.75	See Web

PE-SR047AL Coax, 50 Ohm						
Part No. <a href="#">PE34835</a>	Cable Dia.			Attn. @ 1 GHz	Power @ 1 GHz	
1 piece price shown. See web or call for volume pricing.	0.047" dia.			41 dB/100ft	32 W	
6"	12"	18"	24"	36"	48"	Custom Len.
\$121.33	\$115.17	\$120.08	\$125.00	\$134.84	\$144.69	See Web

Cable Assemblies

See Our Website For Current Pricing & Real-Time Stock Availability!

For Custom Lengths, Metric Lengths or Special Configurations, Please call (949) 261-1920



Technical Support  
+1 (949) 261-1920



Same-Day Shipping,  
Even Custom Cable Assemblies



For our complete selection of cable assemblies, please visit our website

Cable Assemblies

See Our Website For Current Pricing & Real-Time Stock Availability!

PE-SR402AL Coax, 50 Ohm						
Part No. <a href="#">PE34836</a>			Cable Dia.	Attn. @ 1 GHz	Power @ 1 GHz	20
1 piece price shown. See web or call for volume pricing.			0.141" dia.	13 dB/100ft	450 W	
6"	12"	18"	24"	36"	48"	Custom Len.
\$70.35	\$74.57	\$75.52	\$80.68	\$91.05	\$101.37	See Web
PE-SR405AL Coax, 50 Ohm						
Part No. <a href="#">PE34834</a>			Cable Dia.	Attn. @ 1 GHz	Power @ 1 GHz	21
1 piece price shown. See web or call for volume pricing.			0.141" dia.	23 dB/100ft	130 W	
6"	12"	18"	24"	36"	48"	Custom Len.
\$80.28	\$89.99	\$89.52	\$94.05	\$103.31	\$110.91	See Web
RG401/U Coax, 50 Ohm						
Part No. <a href="#">PE3521</a>			Cable Dia.	Attn. @ 1 GHz	Power @ 1 GHz	22
1 piece price shown. See web or call for volume pricing.			0.141" dia.	7.5 dB/100ft	870 W	
6"	12"	18"	24"	36"	48"	Custom Len.
\$118.40	\$118.40	\$130.31	\$142.19	\$165.99	\$189.80	See Web
RG402/U Coax, 50 Ohm						
Part No. <a href="#">PE3931</a>			Cable Dia.	Attn. @ 1 GHz	Power @ 1 GHz	23
1 piece price shown. See web or call for volume pricing.			0.141" dia.	12 dB/100ft	650 W	
6"	12"	18"	24"	36"	48"	Custom Len.
\$67.86	\$72.03	\$76.33	\$75.98	\$84.02	\$92.04	See Web
RG405/U Coax, 50 Ohm						
Part No. <a href="#">PE3109</a>			Cable Dia.	Attn. @ 1 GHz	Power @ 1 GHz	24
1 piece price shown. See web or call for volume pricing.			0.141" dia.	22 dB/100ft	130 W	
6"	12"	18"	24"	36"	48"	Custom Len.
\$68.95	\$68.95	\$72.74	\$76.51	\$84.06	\$91.62	See Web
PE-SR401AL-STRAIGHT Coax, 50 Ohm						
Part No. <a href="#">PE3524</a>			Cable Dia.	Attn. @ 1 GHz	Power @ 1 GHz	25
1 piece price shown. See web or call for volume pricing.			0.25" dia.	8 dB/100ft	1,400 W	
6"	12"	18"	24"	36"	48"	Custom Len.
\$99.53	\$107.67	\$117.22	\$126.73	\$145.79	\$164.86	See Web
Standard Flexible Cable Assemblies						
RG62A/U Coax, 93 Ohm						
Part No. <a href="#">PE3424</a>			Cable Dia.	Attn. @ 1 GHz	Power @ 1 GHz	26
1 piece price shown. See web or call for volume pricing.			0.242" dia.	13 dB/100ft	77 W	
12"	24"	36"	48"	60"	-	Custom Len.
\$69.98	\$71.36	\$72.74	\$74.14	\$75.53	-	See Web
SMA FEMALE TO SMA FEMALE BULKHEAD						
SEE MOUNTING HOLE SECTION ON PAGE 409						
Low Loss Flexible Cable Assemblies						
PE-P142LL-27478 Coax, 50 Ohm						
Part No. <a href="#">PE3M0136</a>			Cable Dia.	Attn. @ 1 GHz	Power @ 1 GHz	27
1 piece price shown. See web or call for volume pricing.			0.195" dia.	60"	50CM	
12"	18"	24"	36"	48"	60"	Custom Len.
\$557.31	\$566.50	\$575.69	\$594.08	\$612.45	\$630.85	See Web
SMA FEMALE TO SSMC PLUG						
Flexible Cable Assemblies						
LMR-100A-PVC Coax, 50 Ohm						
Part No. <a href="#">PE3W06055</a>			Cable Dia.	Attn. @ 1 GHz	Power @ 1 GHz	28
1 piece price shown. See web or call for volume pricing.			0.11" dia.	24 dB/100ft	55 W	
12"	24"	36"	48"	60"	50CM	Custom Len.
\$49.39	\$50.19	\$50.98	\$51.80	\$52.61	\$49.89	See Web
Low Loss Flexible Cable Assemblies						
LMR-100A-PVC Coax, 50 Ohm						
Part No. <a href="#">PE3C4426</a>			Cable Dia.	Attn. @ 1 GHz	Power @ 1 GHz	29
1 piece price shown. See web or call for volume pricing.			0.11" dia.	24 dB/100ft	55 W	
6"	12"	18"	24"	36"	48"	Custom Len.
\$59.67	\$66.09	\$66.50	\$60.90	\$61.72	\$62.52	See Web
Standard Flexible Cable Assemblies						
RG178B/U Coax, 50 Ohm						
Part No. <a href="#">PE3C4393</a>			Cable Dia.	Attn. @ 1 GHz	Power @ 1 GHz	30
1 piece price shown. See web or call for volume pricing.			0.072" dia.	44.41 dB/100ft	55 W	
6"	12"	18"	24"	36"	48"	Custom Len.
\$80.27	\$88.87	\$81.31	\$81.80	\$82.84	\$83.86	See Web
RG316/U Coax, 50 Ohm						
Part No. <a href="#">PE3C4409</a>			Cable Dia.	Attn. @ 1 GHz	Power @ 1 GHz	31
1 piece price shown. See web or call for volume pricing.			0.098" dia.	38 dB/100ft	160 W	
6"	12"	18"	24"	36"	48"	Custom Len.
\$71.31	\$72.87	\$74.41	\$75.93	\$79.03	\$82.10	See Web
SMA FEMALE TO SSMC PLUG RIGHT ANGLE						
Low Loss Flexible Cable Assemblies						
LMR-100A-PVC Coax, 50 Ohm						
Part No. <a href="#">PE3C4427</a>			Cable Dia.	Attn. @ 1 GHz	Power @ 1 GHz	32
1 piece price shown. See web or call for volume pricing.			0.11" dia.	24 dB/100ft	121.5 W	
6"	12"	18"	24"	36"	48"	Custom Len.
\$55.91	\$59.70	\$60.11	\$57.13	\$57.94	\$58.76	See Web

Standard Flexible Cable Assemblies						
RG178B/U Coax, 50 Ohm						
Part No. <a href="#">PE3C4464</a>			Cable Dia.	Attn. @ 1 GHz	Power @ 1 GHz	33
1 piece price shown. See web or call for volume pricing.			0.072" dia.	44.41 dB/100ft	55 W	
6"	12"	18"	24"	36"	48"	Custom Len.
\$71.01	\$71.54	\$72.05	\$72.56	\$73.59	\$74.62	See Web
RG316/U Coax, 50 Ohm						
Part No. <a href="#">PE3C4410</a>			Cable Dia.	Attn. @ 1 GHz	Power @ 1 GHz	34
1 piece price shown. See web or call for volume pricing.			0.098" dia.	38 dB/100ft	160 W	
6"	12"	18"	24"	36"	48"	Custom Len.
\$67.55	\$69.09	\$70.64	\$72.16	\$75.26	\$78.33	See Web
RG316-DS Coax, 50 Ohm						
Part No. <a href="#">PE3C4473</a>			Cable Dia.	Attn. @ 1 GHz	Power @ 1 GHz	35
1 piece price shown. See web or call for volume pricing.			0.114" dia.	30 dB/100ft	85 W	
6"	12"	18"	24"	36"	48"	Custom Len.
\$66.45	\$68.00	\$69.56	\$71.11	\$74.21	\$77.32	See Web
SMA FEMALE TO SSMC JACK BULKHEAD						
SEE MOUNTING HOLE SECTION ON PAGE 409						
Standard Flexible Cable Assemblies						
RG178B/U Coax, 50 Ohm						
Part No. <a href="#">PE3C4394</a>			Cable Dia.	Attn. @ 1 GHz	Power @ 1 GHz	36
1 piece price shown. See web or call for volume pricing.			0.072" dia.	44.41 dB/100ft	55 W	
6"	12"	18"	24"	36"	48"	Custom Len.
\$75.90	\$84.06	\$76.93	\$77.44	\$78.47	\$79.49	See Web
SMA FEMALE TO TNC MALE						
Low Loss Flexible Cable Assemblies						
LMR-100A-PVC Coax, 50 Ohm						
Part No. <a href="#">PE3W00825</a>			Cable Dia.	Attn. @ 1 GHz	Power @ 1 GHz	37
1 piece price shown. See web or call for volume pricing.			0.11" dia.	24 dB/100ft	50CM	
12"	24"	36"	48"	60"	50CM	Custom Len.
\$58.10	\$58.91	\$59.72	\$60.54	\$61.34	\$58.62	See Web
LMR-240 Coax, 50 Ohm						
Part No. <a href="#">PE3W00245</a>			Cable Dia.	Attn. @ 1 GHz	Power @ 1 GHz	38
1 piece price shown. See web or call for volume pricing.			0.24" dia.	60"	50CM	
12"	24"	36"	48"	60"	50CM	Custom Len.
Call	Call	Call	Call	Call	Call	See Web
PE-P142LL Coax, 50 Ohm						
Part No. <a href="#">PE3C3205</a>			Cable Dia.	Attn. @ 1 GHz	Power @ 1 GHz	39
1 piece price shown. See web or call for volume pricing.			0.195" dia.	10 dB/100ft	50CM	
12"	24"	36"	48"	60"	50CM	Custom Len.
\$187.38	\$204.99	\$222.58	\$240.18	\$257.78	\$198.65	See Web
PE-P142LL-27478 Coax, 50 Ohm						
Part No. <a href="#">PE3M0138</a>			Cable Dia.	Attn. @ 1 GHz	Power @ 1 GHz	40
1 piece price shown. See web or call for volume pricing.			0.195" dia.	60"	50CM	
12"	18"	24"	36"	48"	60"	Custom Len.
\$470.61	\$479.80	\$488.99	\$507.38	\$525.75	\$544.15	See Web
SMA FEMALE TO TNC MALE RIGHT ANGLE						
Low Loss Flexible Cable Assemblies						
PE-P142LL-27478 Coax, 50 Ohm						
Part No. <a href="#">PE3M0140</a>			Cable Dia.	Attn. @ 1 GHz	Power @ 1 GHz	41
1 piece price shown. See web or call for volume pricing.			0.195" dia.	60"	50CM	
12"	18"	24"	36"	48"	60"	Custom Len.
\$586.28	\$595.47	\$604.65	\$623.04	\$641.42	\$659.80	See Web
SMA FEMALE TO TNC FEMALE BULKHEAD						
SEE MOUNTING HOLE SECTION ON PAGE 409						
Low Loss Flexible Cable Assemblies						
PE-P142LL-27478 Coax, 50 Ohm						
Part No. <a href="#">PE3M0139</a>			Cable Dia.	Attn. @ 1 GHz	Power @ 1 GHz	42
1 piece price shown. See web or call for volume pricing.			0.195" dia.	60"	50CM	
12"	18"	24"	36"	48"	60"	Custom Len.
\$556.09	\$565.29	\$574.48	\$592.87	\$611.24	\$629.63	See Web
SMA FEMALE RIGHT ANGLE TO SMA FEMALE BULKHEAD						
SEE MOUNTING HOLE SECTION ON PAGE 409						
Precision Formable Cable Assemblies						
PE-SR405FLJ Coax, 50 Ohm						
Part No. <a href="#">PE39434</a>			Cable Dia.	Attn. @ 1 GHz	Power @ 1 GHz	43
1 piece price shown. See web or call for volume pricing.			0.098" dia.	19.5 dB/100ft	121.5 W	
6"	9"	12"	18"	24"	-	Custom Len.
\$58.11	\$60.09	\$60.09	\$67.01	\$68.28	-	See Web

\*Coax Performance at 1 GHz Notes: Cable assembly max frequency may be lower than connector or coax max frequency

For our complete selection of cable assemblies, please visit our website

**SMA FEMALE BULKHEAD TO SMA FEMALE BULKHEAD**

SEE MOUNTING HOLE SECTION ON PAGE 409



**Standard Flexible Cable Assemblies**

M17/113-RG316-27478 Coax, 50 Ohm

Part No. <a href="#">PE3M0095</a>	Cable Dia.				Attn. @ 1 GHz	Power @ 1 GHz
1 piece price shown. See web or call for volume pricing.						
6"	8"	12"	16"	18"	24"	Custom Len.
\$202.11	\$202.46	\$203.19	\$203.91	\$204.28	\$205.36	See Web

44

M17/119-RG174-0XDS2 Coax, 50 Ohm

Part No. <a href="#">PE3M0110</a>	Cable Dia.				Attn. @ 1 GHz	Power @ 1 GHz
1 piece price shown. See web or call for volume pricing.						
6"	8"	12"	16"	18"	24"	Custom Len.
\$201.44	\$201.58	\$222.05	\$202.14	\$202.27	\$202.71	See Web

45

**SMA FEMALE BULKHEAD TO TNC MALE**

SEE MOUNTING HOLE SECTION ON PAGE 409



**Standard Flexible Cable Assemblies**

M17/113-RG316-27478 Coax, 50 Ohm

Part No. <a href="#">PE3M0098</a>	Cable Dia.				Attn. @ 1 GHz	Power @ 1 GHz
1 piece price shown. See web or call for volume pricing.						
6"	8"	12"	16"	18"	24"	Custom Len.
\$203.15	\$203.51	\$204.24	\$204.96	\$205.33	\$206.41	See Web

46

M17/119-RG174-0XDS2 Coax, 50 Ohm

Part No. <a href="#">PE3M0113</a>	Cable Dia.				Attn. @ 1 GHz	Power @ 1 GHz
1 piece price shown. See web or call for volume pricing.						
6"	8"	12"	16"	18"	24"	Custom Len.
\$202.49	\$202.61	\$202.90	\$203.18	\$203.33	\$203.75	See Web

47

**SMA FEMALE BULKHEAD TO MCX PLUG RIGHT ANGLE**

SEE MOUNTING HOLE SECTION ON PAGE 409



**Precision Formable Cable Assemblies**

PE-SR405FL Coax, 50 Ohm

Part No. <a href="#">PE39421</a>	Cable Dia.				Attn. @ 1 GHz	Power @ 1 GHz
1 piece price shown. See web or call for volume pricing.						
6"	9"	12"	18"	24"	-	Custom Len.
\$48.12	\$43.72	\$48.12	\$54.04	\$60.41	-	See Web

48

**Standard Formable Cable Assemblies**

PE-SR405FLJ Coax, 50 Ohm

Part No. <a href="#">PE39435</a>	Cable Dia.				Attn. @ 1 GHz	Power @ 1 GHz
1 piece price shown. See web or call for volume pricing.						
6"	9"	12"	18"	24"	-	Custom Len.
\$42.31	\$40.00	\$42.31	\$47.29	\$52.27	-	See Web

49

**SMA FEMALE BULKHEAD TO MMCX PLUG**

SEE MOUNTING HOLE SECTION ON PAGE 409



**Standard Flexible Cable Assemblies**

RG316/U Coax, 50 Ohm

Part No. <a href="#">PE35575</a>	Cable Dia.				Attn. @ 1 GHz	Power @ 1 GHz
1 piece price shown. See web or call for volume pricing.						
12"	24"	36"	48"	60"	-	Custom Len.
\$63.94	\$67.39	\$70.81	\$69.86	\$73.02	-	See Web

50

**SMA FEMALE BULKHEAD TO MMCX PLUG RIGHT ANGLE**

SEE MOUNTING HOLE SECTION ON PAGE 409



**Precision Formable Cable Assemblies**

PE-SR405FL Coax, 50 Ohm

Part No. <a href="#">PE39422</a>	Cable Dia.				Attn. @ 1 GHz	Power @ 1 GHz
1 piece price shown. See web or call for volume pricing.						
6"	9"	12"	18"	24"	-	Custom Len.
\$47.87	\$44.80	\$47.87	\$54.31	\$60.17	-	See Web

51

**Standard Formable Cable Assemblies**

PE-SR405FLJ Coax, 50 Ohm

Part No. <a href="#">PE39436</a>	Cable Dia.				Attn. @ 1 GHz	Power @ 1 GHz
1 piece price shown. See web or call for volume pricing.						
6"	9"	12"	18"	24"	-	Custom Len.
\$64.36	\$62.07	\$64.36	\$69.30	\$74.22	-	See Web

52

**Standard Flexible Cable Assemblies**

RG174A/U Coax, 50 Ohm

Part No. <a href="#">PE34786</a>	Cable Dia.				Attn. @ 1 GHz	Power @ 1 GHz
1 piece price shown. See web or call for volume pricing.						
12"	24"	36"	48"	60"	50CM	Custom Len.
\$63.96	\$64.57	\$65.17	\$65.80	\$66.40	\$64.37	See Web

53

RG178B/U Coax, 50 Ohm

Part No. <a href="#">PE3C3821</a>	Cable Dia.				Attn. @ 1 GHz	Power @ 1 GHz
1 piece price shown. See web or call for volume pricing.						
12"	24"	36"	48"	60"	50CM	Custom Len.
\$69.37	\$67.84	\$68.95	\$70.09	\$71.22	\$67.42	See Web

54

RG188-DS Coax, 50 Ohm

Part No. <a href="#">PE3W00934</a>	Cable Dia.				Attn. @ 1 GHz	Power @ 1 GHz
1 piece price shown. See web or call for volume pricing.						
12"	50CM	24"	36"	100CM	48"	Custom Len.
\$75.95	\$78.37	\$79.71	\$83.47	\$84.53	\$87.23	See Web

55

RG316/U Coax, 50 Ohm

Part No. <a href="#">PE34686</a>	Cable Dia.				Attn. @ 1 GHz	Power @ 1 GHz
1 piece price shown. See web or call for volume pricing.						
12"	24"	36"	48"	60"	-	Custom Len.
\$64.93	\$68.35	\$71.79	\$71.94	\$78.93	-	See Web

56

Part No. <a href="#">PE3C1081</a>	Cable Dia.				Attn. @ 1 GHz	Power @ 1 GHz
1 piece price shown. See web or call for volume pricing.						
12"	50CM	24"	36"	100CM	48"	Custom Len.
\$64.58	\$63.07	\$64.26	\$67.60	\$68.54	\$70.94	See Web

57

**SMA FEMALE BULKHEAD TO N MALE**

SEE MOUNTING HOLE SECTION ON PAGE 409



**Low Loss Flexible Cable Assemblies**

PE-P142LL-27478 Coax, 50 Ohm

Part No. <a href="#">PE3M0149</a>	Cable Dia.				Attn. @ 1 GHz	Power @ 1 GHz
1 piece price shown. See web or call for volume pricing.						
12"	18"	24"	36"	48"	60"	Custom Len.
\$496.97	\$506.15	\$515.34	\$533.73	\$552.10	\$570.49	See Web

58

PE-P160LL-27478 Coax, 50 Ohm

Part No. <a href="#">PE3M0194</a>	Cable Dia.				Attn. @ 1 GHz	Power @ 1 GHz
1 piece price shown. See web or call for volume pricing.						
8"	12"	18"	24"	30"	36"	Custom Len.
\$479.88	\$485.20	\$493.16	\$501.13	\$509.12	\$517.07	See Web

59

**SMA FEMALE BULKHEAD TO N MALE RIGHT ANGLE**

SEE MOUNTING HOLE SECTION ON PAGE 409



**Low Loss Flexible Cable Assemblies**

PE-P142LL-27478 Coax, 50 Ohm

Part No. <a href="#">PE3M0151</a>	Cable Dia.				Attn. @ 1 GHz	Power @ 1 GHz
1 piece price shown. See web or call for volume pricing.						
12"	18"	24"	36"	48"	60"	Custom Len.
\$621.68	\$630.87	\$640.06	\$658.45	\$676.82	\$695.22	See Web

60

PE-P160LL-27478 Coax, 50 Ohm

Part No. <a href="#">PE3M0196</a>	Cable Dia.				Attn. @ 1 GHz	Power @ 1 GHz
1 piece price shown. See web or call for volume pricing.						
8"	12"	18"	24"	30"	36"	Custom Len.
\$586.19	\$591.52	\$599.47	\$607.45	\$615.42	\$623.38	See Web

61

**SMA FEMALE BULKHEAD TO N FEMALE BULKHEAD**

SEE MOUNTING HOLE SECTION ON PAGE 409



**Low Loss Flexible Cable Assemblies**

PE-P142LL-27478 Coax, 50 Ohm

Part No. <a href="#">PE3M0150</a>	Cable Dia.				Attn. @ 1 GHz	Power @ 1 GHz
1 piece price shown. See web or call for volume pricing.						
12"	18"	24"	36"	48"	60"	Custom Len.
\$591.51	\$600.70	\$609.88	\$628.27	\$646.65	\$665.03	See Web

62

PE-P160LL-27478 Coax, 50 Ohm

Part No. <a href="#">PE3M0195</a>	Cable Dia.				Attn. @ 1 GHz	Power @ 1 GHz
1 piece price shown. See web or call for volume pricing.						
8"	12"	18"	24"	30"	36"	Custom Len.
\$590.46	\$595.79	\$603.74	\$611.72	\$619.68	\$627.66	See Web

63

**SMA FEMALE BULKHEAD TO SMA MALE**

SEE MOUNTING HOLE SECTION ON PAGE 409



**Standard Formable Cable Assemblies**

PE-SR402FL Coax, 50 Ohm

Part No. <a href="#">PE3468</a>	Cable Dia.				Attn. @ 1 GHz	Power @ 1 GHz
1 piece price shown. See web or call for volume pricing.						
6"	12"	18"	24"	36"	48"	Custom Len.
\$65.15	\$69.46	\$73.90	\$73.81	\$82.11	\$90.39	See Web

64

Part No. <a href="#">PE39427</a>	Cable Dia.				Attn. @ 1 GHz	Power @ 1 GHz
1 piece price shown. See web or call for volume pricing.						
6"	9"	12"	18"	24"	-	Custom Len.
\$57.67	\$55.50	\$57.67	\$62.26	Call	-	See Web

65

PE-SR402FLJ Coax, 50 Ohm

Part No. <a href="#">PE3W04417</a>	Cable Dia.				Attn. @ 1 GHz	Power @ 1 GHz
1 piece price shown. See web or call for volume pricing.						
12"	24"	36"	48"	60"	50CM	Custom Len.
\$54.44	\$63.70	\$73.48	\$83.24	\$93.00	\$60.18	See Web

66

For Custom Lengths, Metric Lengths or Special Configurations, Please call (949) 261-1920



Technical Support  
+1 (949) 261-1920



Same-Day Shipping,  
Even Custom Cable Assemblies

Cable Assemblies

See Our Website For Current Pricing & Real-Time Stock Availability!

For our complete selection of cable assemblies, please visit our website

Cable Assemblies

See Our Website For Current Pricing & Real-Time Stock Availability!

Standard Flexible Cable Assemblies						
RG316-DS Coax, 50 Ohm						
Part No.	PE3973			Cable Dia.	Attn. @ 1 GHz	Power @ 1 GHz
1 piece price shown. See web or call for volume pricing.						
6"	12"	18"	24"	0.114" dia.	30 dB/100ft	85 W
\$58.67	\$60.33	\$62.05	\$63.78	\$63.31	\$66.51	See Web
PE-P141EAM Coax, 50 Ohm						
Part No.	PE3CA1038			Cable Dia.	Attn. @ 1 GHz	Power @ 1 GHz
1 piece price shown. See web or call for volume pricing.						
12"	24"	36"	50CM	100CM	-	Custom Len.
\$87.60	\$110.16	\$133.95	Call	\$125.56	-	See Web
SMA FEMALE BULKHEAD TO SMA MALE RIGHT ANGLE						
SEE MOUNTING HOLE SECTION ON PAGE 409						
Flexible Cable Assemblies						
LMR-195 Coax, 50 Ohm						
Part No.	PE3W05962			Cable Dia.	Attn. @ 1 GHz	Power @ 1 GHz
1 piece price shown. See web or call for volume pricing.						
12"	24"	36"	48"	0.195" dia.	11.8 dB/100ft	44 W
\$36.66	\$37.37	\$38.09	\$38.80	\$39.53	\$37.12	See Web
Low Loss Flexible Cable Assemblies						
PE-C195 Coax, 50 Ohm						
Part No.	PE3W07670			Cable Dia.	Attn. @ 1 GHz	Power @ 1 GHz
1 piece price shown. See web or call for volume pricing.						
12"	24"	36"	48"	0.195" dia.	11.7 dB/100ft	135 W
\$44.51	\$45.41	\$45.87	\$46.78	\$47.69	\$44.63	See Web
PE-P142LL-27478 Coax, 50 Ohm						
Part No.	PE3M0145			Cable Dia.	Attn. @ 1 GHz	Power @ 1 GHz
1 piece price shown. See web or call for volume pricing.						
12"	18"	24"	36"	48"	60"	Custom Len.
\$593.52	\$602.71	\$611.89	\$630.28	\$648.66	\$667.05	See Web
PE-P160LL-27478 Coax, 50 Ohm						
Part No.	PE3M0190			Cable Dia.	Attn. @ 1 GHz	Power @ 1 GHz
1 piece price shown. See web or call for volume pricing.						
8"	12"	18"	24"	30"	36"	Custom Len.
\$594.73	\$600.04	\$608.01	\$615.98	\$623.95	\$631.92	See Web
SMA FEMALE BULKHEAD TO SMA FEMALE						
SEE MOUNTING HOLE SECTION ON PAGE 409						
Standard Flexible Cable Assemblies						
RG316/U Coax, 50 Ohm						
Part No.	PE3W07334			Cable Dia.	Attn. @ 1 GHz	Power @ 1 GHz
1 piece price shown. See web or call for volume pricing.						
12"	24"	36"	48"	0.102" dia.	38 dB/100ft	32 W
\$54.21	\$57.81	\$61.42	\$65.03	\$68.64	\$56.52	See Web
SMA FEMALE BULKHEAD TO SMA FEMALE BULKHEAD						
SEE MOUNTING HOLE SECTION ON PAGE 409						
Low Loss Flexible Cable Assemblies						
PE-P160LL Coax, 50 Ohm						
Part No.	PE3C5247			Cable Dia.	Attn. @ 1 GHz	Power @ 1 GHz
1 piece price shown. See web or call for volume pricing.						
12"	24"	36"	48"	0.16" dia.	60"	50CM Custom Len.
\$259.63	\$308.73	\$299.98	\$322.08	\$344.21	\$269.90	See Web
PE-P142LL-27478 Coax, 50 Ohm						
Part No.	PE3M0144			Cable Dia.	Attn. @ 1 GHz	Power @ 1 GHz
1 piece price shown. See web or call for volume pricing.						
12"	18"	24"	36"	48"	60"	Custom Len.
\$592.71	\$601.90	\$611.09	\$629.47	\$647.86	\$666.25	See Web
PE-P160LL-27478 Coax, 50 Ohm						
Part No.	PE3M0189			Cable Dia.	Attn. @ 1 GHz	Power @ 1 GHz
1 piece price shown. See web or call for volume pricing.						
8"	12"	18"	24"	30"	36"	Custom Len.
\$590.46	\$595.79	\$603.74	\$611.72	\$619.68	\$627.66	See Web
Standard Formable Cable Assemblies						
PE-SR047FL Coax, 50 Ohm						
Part No.	PE34709			Cable Dia.	Attn. @ 1 GHz	Power @ 1 GHz
1 piece price shown. See web or call for volume pricing.						
6"	12"	18"	24"	0.047" dia.	36 dB/100ft	32 W
\$130.49	\$134.40	\$138.23	\$142.14	\$149.89	\$157.61	See Web
PE-SR401FL Coax, 50 Ohm						
Part No.	PE3794			Cable Dia.	Attn. @ 1 GHz	Power @ 1 GHz
1 piece price shown. See web or call for volume pricing.						
6"	12"	18"	24"	36"	48"	Custom Len.
\$116.91	\$132.54	\$133.10	\$141.23	\$157.44	\$173.64	See Web
PE-SR402FL Coax, 50 Ohm						
Part No.	PE33864			Cable Dia.	Attn. @ 1 GHz	Power @ 1 GHz
1 piece price shown. See web or call for volume pricing.						
6"	12"	18"	24"	36"	48"	Custom Len.
\$78.75	\$78.75	\$83.35	\$87.93	\$97.12	\$106.31	See Web

PE-SR405FL Coax, 50 Ohm						
Part No.	PE34070			Cable Dia.	Attn. @ 1 GHz	Power @ 1 GHz
1 piece price shown. See web or call for volume pricing.						
6"	12"	18"	24"	36"	48"	Custom Len.
\$84.49	\$84.49	\$95.80	\$96.25	\$106.52	\$118.11	See Web
Standard Flexible Cable Assemblies						
RG58C/U Coax, 50 Ohm						
Part No.	PE35404			Cable Dia.	Attn. @ 1 GHz	Power @ 1 GHz
1 piece price shown. See web or call for volume pricing.						
12"	24"	36"	48"	60"	-	Custom Len.
\$61.90	\$62.71	\$63.51	\$70.82	\$65.12	-	See Web
RG174A/U Coax, 50 Ohm						
Part No.	PE33382			Cable Dia.	Attn. @ 1 GHz	Power @ 1 GHz
1 piece price shown. See web or call for volume pricing.						
12"	24"	36"	48"	60"	-	Custom Len.
\$58.18	\$58.77	\$59.30	\$59.88	\$60.41	-	See Web
RG178B/U Coax, 50 Ohm						
Part No.	PE33084			Cable Dia.	Attn. @ 1 GHz	Power @ 1 GHz
1 piece price shown. See web or call for volume pricing.						
12"	24"	36"	48"	60"	-	Custom Len.
\$77.94	\$79.01	\$84.95	\$86.18	\$82.15	-	See Web
RG316/U Coax, 50 Ohm						
Part No.	PE33158			Cable Dia.	Attn. @ 1 GHz	Power @ 1 GHz
1 piece price shown. See web or call for volume pricing.						
12"	24"	36"	48"	60"	-	Custom Len.
\$64.39	\$71.70	\$70.72	\$73.90	\$77.08	-	See Web
RG316-DS Coax, 50 Ohm						
Part No.	PE38184			Cable Dia.	Attn. @ 1 GHz	Power @ 1 GHz
1 piece price shown. See web or call for volume pricing.						
12"	24"	36"	48"	60"	-	Custom Len.
\$70.97	\$78.66	\$77.37	\$85.75	\$89.25	-	See Web
Standard Semi-Rigid Cable Assemblies						
PE-020SR Coax, 50 Ohm						
Part No.	PE3932			Cable Dia.	Attn. @ 1 GHz	Power @ 1 GHz
1 piece price shown. See web or call for volume pricing.						
6"	12"	18"	24"	36"	48"	Custom Len.
\$166.48	\$176.03	\$185.54	\$195.09	\$214.16	\$233.23	See Web
PE-034SR Coax, 50 Ohm						
Part No.	PE3520			Cable Dia.	Attn. @ 1 GHz	Power @ 1 GHz
1 piece price shown. See web or call for volume pricing.						
6"	12"	18"	24"	36"	48"	Custom Len.
\$162.06	\$168.74	\$175.39	\$182.09	\$195.37	\$208.71	See Web
PE-047SR Coax, 50 Ohm						
Part No.	PE33789			Cable Dia.	Attn. @ 1 GHz	Power @ 1 GHz
1 piece price shown. See web or call for volume pricing.						
6"	12"	18"	24"	36"	48"	Custom Len.
\$145.64	\$145.64	\$151.18	\$156.74	\$167.84	\$178.94	See Web
PE-SR047AL Coax, 50 Ohm						
Part No.	PE3929			Cable Dia.	Attn. @ 1 GHz	Power @ 1 GHz
1 piece price shown. See web or call for volume pricing.						
6"	12"	18"	24"	36"	48"	Custom Len.
\$131.42	\$136.17	\$140.98	\$145.71	\$155.22	\$164.78	See Web
PE-SR402AL Coax, 50 Ohm						
Part No.	PE3903			Cable Dia.	Attn. @ 1 GHz	Power @ 1 GHz
1 piece price shown. See web or call for volume pricing.						
6"	12"	18"	24"	36"	48"	Custom Len.
\$63.25	\$68.25	\$73.28	\$78.29	\$88.33	\$98.37	See Web
PE-SR405AL Coax, 50 Ohm						
Part No.	PE34071			Cable Dia.	Attn. @ 1 GHz	Power @ 1 GHz
1 piece price shown. See web or call for volume pricing.						
6"	12"	18"	24"	36"	48"	Custom Len.
\$80.54	\$80.54	\$85.29	\$90.04	\$99.55	\$107.53	See Web
RG401/U Coax, 50 Ohm						
Part No.	PE3634			Cable Dia.	Attn. @ 1 GHz	Power @ 1 GHz
1 piece price shown. See web or call for volume pricing.						
6"	12"	18"	24"	36"	48"	Custom Len.
\$120.34	\$131.85	\$143.45	\$154.95	\$178.05	\$201.14	See Web
RG402/U Coax, 50 Ohm						
Part No.	PE33518			Cable Dia.	Attn. @ 1 GHz	Power @ 1 GHz
1 piece price shown. See web or call for volume pricing.						
6"	12"	18"	24"	36"	48"	Custom Len.
\$71.30	\$71.30	\$75.31	\$79.33	\$87.37	\$95.40	See Web
RG405/U Coax, 50 Ohm						
Part No.	PE33176			Cable Dia.	Attn. @ 1 GHz	Power @ 1 GHz
1 piece price shown. See web or call for volume pricing.						
6"	12"	18"	24"	36"	48"	Custom Len.
\$80.08	\$84.88	\$83.85	\$87.63	\$95.17	\$102.73	See Web
PE-SR401AL-STRAIGHT Coax, 50 Ohm						
Part No.	PE3764			Cable Dia.	Attn. @ 1 GHz	Power @ 1 GHz
1 piece price shown. See web or call for volume pricing.						
6"	12"	18"	24"	36"	48"	Custom Len.
\$118.34	\$127.89	\$137.40	\$146.95	\$166.03	\$185.09	See Web

\*Coax Performance at 1 GHz Notes: Cable assembly max frequency may be lower than connector or coax max frequency



For our complete selection of cable assemblies, please visit our website

**SMA FEMALE BULKHEAD TO REVERSE POLARITY SMA MALE**

SEE MOUNTING HOLE SECTION ON PAGE 409



**Standard Flexible Cable Assemblies**

**RG141A/U Coax, 50 Ohm**

Part No. <a href="#">PE3W02965</a>	Cable Dia.	Attn. @ 1 GHz	Power @ 1 GHz
1 piece price shown. See web or call for volume pricing.	0.19" dia.	13 dB/100ft	650 W
12" 24" 36" 48"	60"	50CM	Custom Len.
\$77.03 \$85.14 \$93.24 \$101.35	\$107.95	\$82.23	See Web

96

**SMA FEMALE BULKHEAD TO SMB PLUG RIGHT ANGLE**

SEE MOUNTING HOLE SECTION ON PAGE 409



**Low Loss Flexible Cable Assemblies**

**PE-C100-LSZH Coax, 50 Ohm**

Part No. <a href="#">PE3W00135</a>	Cable Dia.	Attn. @ 1 GHz	Power @ 1 GHz
1 piece price shown. See web or call for volume pricing.	0.109" dia.	25 dB/100ft	160 W
12" 24" 36" 48"	60"	50CM	Custom Len.
\$47.20 \$48.62 \$50.06 \$51.49	\$52.91	\$48.13	See Web

97

**SMA FEMALE BULKHEAD TO SMP FEMALE**

SEE MOUNTING HOLE SECTION ON PAGE 409



**Standard Flexible Cable Assemblies**

**PE-P086 Coax, 50 Ohm**

Part No. <a href="#">PE3C5233</a>	Cable Dia.	Attn. @ 1 GHz	Power @ 1 GHz
1 piece price shown. See web or call for volume pricing.	0.104" dia.	21.7 dB/100ft	55 W
12" 24" 36" 48"	60"	50CM	Custom Len.
\$67.98 \$76.46 \$84.94 \$93.40	\$101.88	\$73.41	See Web

98

**SMA FEMALE BULKHEAD TO SMP FEMALE RIGHT ANGLE**

SEE MOUNTING HOLE SECTION ON PAGE 409



**Low Loss Flexible Cable Assemblies**

**LMR-100A-PVC Coax, 50 Ohm**

Part No. <a href="#">PE3C3937</a>	Cable Dia.	Attn. @ 1 GHz	Power @ 1 GHz
1 piece price shown. See web or call for volume pricing.	0.11" dia.	24 dB/100ft	55 W
12" 24" 36" 48"	60"	50CM	Custom Len.
\$55.16 \$54.36 \$54.67 \$55.47	\$56.29	\$54.07	See Web

99

**SMA FEMALE BULKHEAD TO SSMC PLUG**

SEE MOUNTING HOLE SECTION ON PAGE 409



**Low Loss Flexible Cable Assemblies**

**LMR-100A-PVC Coax, 50 Ohm**

Part No. <a href="#">PE3C4428</a>	Cable Dia.	Attn. @ 1 GHz	Power @ 1 GHz
1 piece price shown. See web or call for volume pricing.	0.11" dia.	24 dB/100ft	55 W
6" 12" 18" 24" 36" 48"	60"	50CM	Custom Len.
\$54.30 \$59.21 \$56.26 \$58.92	\$57.47	\$65.09	See Web

1

**Standard Formable Cable Assemblies**

**PE-SR405FLJ Coax, 50 Ohm**

Part No. <a href="#">PE3C4448</a>	Cable Dia.	Attn. @ 1 GHz	Power @ 1 GHz
1 piece price shown. See web or call for volume pricing.	0.105" dia.	19.5 dB/100ft	121.5 W
6" 12" 18" 24" 36" 48"	60"	50CM	Custom Len.
\$64.53 \$75.56 \$72.83 \$76.95	\$85.23	\$93.50	See Web

2

**Standard Flexible Cable Assemblies**

**RG178B/U Coax, 50 Ohm**

Part No. <a href="#">PE3C4395</a>	Cable Dia.	Attn. @ 1 GHz	Power @ 1 GHz
1 piece price shown. See web or call for volume pricing.	0.072" dia.	44.41 dB/100ft	55 W
6" 12" 18" 24" 36" 48"	60"	50CM	Custom Len.
\$81.61 \$82.18 \$75.23 \$75.73	\$76.75	\$77.79	See Web

3

**RG316/U Coax, 50 Ohm**

Part No. <a href="#">PE3C4411</a>	Cable Dia.	Attn. @ 1 GHz	Power @ 1 GHz
1 piece price shown. See web or call for volume pricing.	0.098" dia.	38 dB/100ft	160 W
6" 12" 18" 24" 36" 48"	60"	50CM	Custom Len.
\$67.07 \$72.74 \$70.17 \$71.70	\$79.62	\$83.25	See Web

4

**SMA FEMALE BULKHEAD TO SSMC PLUG RIGHT ANGLE**

SEE MOUNTING HOLE SECTION ON PAGE 409



**Low Loss Flexible Cable Assemblies**

**LMR-100A-PVC Coax, 50 Ohm**

Part No. <a href="#">PE3C4429</a>	Cable Dia.	Attn. @ 1 GHz	Power @ 1 GHz
1 piece price shown. See web or call for volume pricing.	0.11" dia.	24 dB/100ft	55 W
6" 12" 18" 24" 36" 48"	60"	50CM	Custom Len.
\$51.00 \$52.56 \$52.97 \$55.15	\$54.19	\$61.32	See Web

5

**Standard Formable Cable Assemblies**

**PE-SR405FLJ Coax, 50 Ohm**

Part No. <a href="#">PE3C4486</a>	Cable Dia.	Attn. @ 1 GHz	Power @ 1 GHz
1 piece price shown. See web or call for volume pricing.	0.105" dia.	19.5 dB/100ft	121.5 W
6" 12" 18" 24" 36" 48"	60"	50CM	Custom Len.
\$61.14 \$71.81 \$69.42 \$81.19	\$81.81	\$90.10	See Web

6

**Standard Flexible Cable Assemblies**

**RG178B/U Coax, 50 Ohm**

Part No. <a href="#">PE3C4465</a>	Cable Dia.	Attn. @ 1 GHz	Power @ 1 GHz
1 piece price shown. See web or call for volume pricing.	0.072" dia.	44.41 dB/100ft	55 W
6" 12" 18" 24" 36" 48"	60"	50CM	Custom Len.
\$64.95 \$69.38 \$65.96 \$66.48	\$67.50	\$68.53	See Web

7

**RG316/U Coax, 50 Ohm**

Part No. <a href="#">PE3C4412</a>	Cable Dia.	Attn. @ 1 GHz	Power @ 1 GHz
1 piece price shown. See web or call for volume pricing.	0.098" dia.	38 dB/100ft	160 W
6" 12" 18" 24" 36" 48"	60"	50CM	Custom Len.
\$63.30 \$68.75 \$70.46 \$67.93	\$71.01	\$74.09	See Web

8

**RG316-DS Coax, 50 Ohm**

Part No. <a href="#">PE3C4474</a>	Cable Dia.	Attn. @ 1 GHz	Power @ 1 GHz
1 piece price shown. See web or call for volume pricing.	0.114" dia.	30 dB/100ft	85 W
6" 12" 18" 24" 36" 48"	60"	50CM	Custom Len.
\$69.63 \$78.32 \$80.04 \$74.31	\$77.41	\$80.52	See Web

9

**SMA FEMALE BULKHEAD TO SSMC JACK BULKHEAD**

SEE MOUNTING HOLE SECTION ON PAGE 409



**Standard Formable Cable Assemblies**

**PE-SR405FLJ Coax, 50 Ohm**

Part No. <a href="#">PE3C4449</a>	Cable Dia.	Attn. @ 1 GHz	Power @ 1 GHz
1 piece price shown. See web or call for volume pricing.	0.105" dia.	19.5 dB/100ft	121.5 W
6" 12" 18" 24" 36" 48"	60"	50CM	Custom Len.
\$57.05 \$61.19 \$65.32 \$69.46	\$77.73	\$86.01	See Web

10

**Standard Flexible Cable Assemblies**

**RG178B/U Coax, 50 Ohm**

Part No. <a href="#">PE3C4396</a>	Cable Dia.	Attn. @ 1 GHz	Power @ 1 GHz
1 piece price shown. See web or call for volume pricing.	0.072" dia.	44.41 dB/100ft	55 W
6" 12" 18" 24" 36" 48"	60"	50CM	Custom Len.
\$69.82 \$70.35 \$70.84 \$71.36	\$72.39	\$73.41	See Web

11

**SMA FEMALE BULKHEAD TO TNC MALE**

SEE MOUNTING HOLE SECTION ON PAGE 409



**Low Loss Flexible Cable Assemblies**

**PE-P160LL Coax, 50 Ohm**

Part No. <a href="#">PE3C5264</a>	Cable Dia.	Attn. @ 1 GHz	Power @ 1 GHz
1 piece price shown. See web or call for volume pricing.	0.16" dia.	60"	50CM
12" 24" 36" 48" 60"	50CM	Custom Len.	
\$241.18 \$263.65 \$286.09 \$308.56	\$331.01	\$255.57	See Web

12

**PE-P142LL-27478 Coax, 50 Ohm**

Part No. <a href="#">PE3M0146</a>	Cable Dia.	Attn. @ 1 GHz	Power @ 1 GHz
1 piece price shown. See web or call for volume pricing.	0.195" dia.	60"	50CM
12" 18" 24" 36" 48" 60"	50CM	Custom Len.	
\$506.02 \$515.21 \$524.40 \$542.78	\$561.16	\$579.55	See Web

13

**PE-P160LL-27478 Coax, 50 Ohm**

Part No. <a href="#">PE3M0191</a>	Cable Dia.	Attn. @ 1 GHz	Power @ 1 GHz
1 piece price shown. See web or call for volume pricing.	0.16" dia.	30"	36"
8" 12" 18" 24" 30" 36"	Custom Len.		
\$494.03 \$499.35 \$507.32 \$515.28	\$523.26	\$531.22	See Web

14

**SMA FEMALE BULKHEAD TO TNC MALE RIGHT ANGLE**

SEE MOUNTING HOLE SECTION ON PAGE 409



**Low Loss Flexible Cable Assemblies**

**PE-P160LL Coax, 50 Ohm**

Part No. <a href="#">PE3C5265</a>	Cable Dia.	Attn. @ 1 GHz	Power @ 1 GHz
1 piece price shown. See web or call for volume pricing.	0.16" dia.	60"	50CM
12" 24" 36" 48" 60"	50CM	Custom Len.	
\$304.90 \$263.65 \$286.09 \$308.56	\$331.01	\$255.57	See Web

15

**PE-P142LL-27478 Coax, 50 Ohm**

Part No. <a href="#">PE3M0148</a>	Cable Dia.	Attn. @ 1 GHz	Power @ 1 GHz
1 piece price shown. See web or call for volume pricing.	0.195" dia.	48"	60"
12" 18" 24" 36" 48" 60"	Custom Len.		
\$621.68 \$630.87 \$640.06 \$658.45	\$676.82	\$695.22	See Web

16

**PE-P160LL-27478 Coax, 50 Ohm**

Part No. <a href="#">PE3M0193</a>	Cable Dia.	Attn. @ 1 GHz	Power @ 1 GHz
1 piece price shown. See web or call for volume pricing.	0.16" dia.	30"	36"
8" 12" 18" 24" 30" 36"	Custom Len.		
\$586.19 \$591.52 \$599.47 \$607.45	\$615.42	\$623.38	See Web

17

For Custom Lengths, Metric Lengths or Special Configurations, Please call (949) 261-1920



Technical Support  
+1 (949) 261-1920



Same-Day Shipping,  
Even Custom Cable Assemblies

Cable Assemblies

See Our Website For Current Pricing & Real-Time Stock Availability!



For our complete selection of cable assemblies, please visit our website

**SMA FEMALE BULKHEAD TO TNC FEMALE BULKHEAD**

SEE MOUNTING HOLE SECTION ON PAGE 409



**Low Loss Flexible Cable Assemblies**

PE-P160LL Coax, 50 Ohm				Cable Dia.	Attn. @ 1 GHz	Power @ 1 GHz
1 piece price shown. See web or call for volume pricing.				0.16" dia.		
12"	24"	36"	48"	60"	50CM	Custom Len.
\$269.68	\$292.15	\$314.60	\$337.05	\$359.51	\$284.06	See Web

18

PE-P142LL-27478 Coax, 50 Ohm				Cable Dia.	Attn. @ 1 GHz	Power @ 1 GHz
1 piece price shown. See web or call for volume pricing.				0.195" dia.		
12"	18"	24"	36"	48"	60"	Custom Len.
\$591.76	\$600.70	\$609.88	\$628.27	\$646.65	\$665.03	See Web

19

PE-P160LL-27478 Coax, 50 Ohm				Cable Dia.	Attn. @ 1 GHz	Power @ 1 GHz
1 piece price shown. See web or call for volume pricing.				0.16" dia.		
8"	12"	18"	24"	30"	36"	Custom Len.
\$581.93	\$587.24	\$595.22	\$603.18	\$611.16	\$619.11	See Web

20

**SMA FEMALE BULKHEAD TO HMCX32 1.2 PLUG**

SEE MOUNTING HOLE SECTION ON PAGE 409



**Standard Flexible Cable Assemblies**

PE-81mm Coax, 50 Ohm				Cable Dia.	Attn. @ 1 GHz	Power @ 1 GHz
1 piece price shown. See web or call for volume pricing.				0.032" dia.		
3"	6"	12"	-	-	-	Custom Len.
\$15.89	\$14.76	\$20.10	-	-	-	See Web

21

**SMA FEMALE BULKHEAD TO UMCX PLUG RIGHT ANGLE**

SEE MOUNTING HOLE SECTION ON PAGE 409



**Standard Flexible Cable Assemblies**

RG178B/U Coax, 50 Ohm				Cable Dia.	Attn. @ 1 GHz	Power @ 1 GHz
1 piece price shown. See web or call for volume pricing.				0.072" dia.	44.4 dB/100ft	78 W
3"	6"	9"	12"	18"	24"	Custom Len.
\$73.40	\$75.28	\$77.16	\$79.05	\$82.93	\$84.09	See Web

22

**SMA FEMALE BULKHEAD TO UMCX 2.1 PLUG**

SEE MOUNTING HOLE SECTION ON PAGE 409



**Standard Flexible Cable Assemblies**

PE-81mm Coax, 50 Ohm				Cable Dia.	Attn. @ 1 GHz	Power @ 1 GHz
1 piece price shown. See web or call for volume pricing.				0.032" dia.		
3"	6"	12"	-	-	-	Custom Len.
\$12.80	\$14.76	\$14.07	-	-	-	See Web

23

**SMA FEMALE BULKHEAD TO UMCX 2.5 PLUG**

SEE MOUNTING HOLE SECTION ON PAGE 409



**Standard Flexible Cable Assemblies**

RG178B/U Coax, 50 Ohm				Cable Dia.	Attn. @ 1 GHz	Power @ 1 GHz
1 piece price shown. See web or call for volume pricing.				0.07" dia.		
3"	6"	9"	12"	14"	15"	Custom Len.
Call	\$14.76	\$14.76	\$13.71	Call	Call	See Web

24

RG178-DS Coax, 50 Ohm				Cable Dia.	Attn. @ 1 GHz	Power @ 1 GHz
1 piece price shown. See web or call for volume pricing.				0.086" dia.		
3"	6"	9"	12"	-	-	Custom Len.
Call	\$15.32	\$15.52	\$19.00	-	-	See Web

25

PE-81mm Coax, 50 Ohm				Cable Dia.	Attn. @ 1 GHz	Power @ 1 GHz
1 piece price shown. See web or call for volume pricing.				0.032" dia.		
3"	6"	12"	-	-	-	Custom Len.
\$14.76	\$13.05	\$14.76	-	-	-	See Web

26

PE-113mm Coax, 50 Ohm				Cable Dia.	Attn. @ 1 GHz	Power @ 1 GHz
1 piece price shown. See web or call for volume pricing.				0.044" dia.		
3"	6"	9"	12"	-	-	Custom Len.
\$16.29	\$14.13	\$14.33	\$14.13	-	-	See Web

27

PE-137mm Coax, 50 Ohm				Cable Dia.	Attn. @ 1 GHz	Power @ 1 GHz
1 piece price shown. See web or call for volume pricing.				0.053" dia.		
3"	6"	12"	-	-	-	Custom Len.
\$14.76	\$15.42	\$14.76	-	-	-	See Web

28

**SMA FEMALE BULKHEAD TO WMCX 1.6 PLUG**

SEE MOUNTING HOLE SECTION ON PAGE 409



**Standard Flexible Cable Assemblies**

PE-81mm Coax, 50 Ohm				Cable Dia.	Attn. @ 1 GHz	Power @ 1 GHz
1 piece price shown. See web or call for volume pricing.				0.032" dia.		
3"	10CM	6"	12"	-	-	Custom Len.
\$12.80	Call	\$14.76	\$14.76	-	-	See Web

29

**REVERSE POLARITY SMA FEMALE BULKHEAD TO SMA MALE**

SEE MOUNTING HOLE SECTION ON PAGE 409



**Standard Formable Cable Assemblies**

PE-SR405FLJ Coax, 50 Ohm				Cable Dia.	Attn. @ 1 GHz	Power @ 1 GHz
1 piece price shown. See web or call for volume pricing.				0.105" dia.	19.5 dB/100ft	121.5 W
12"	24"	36"	48"	60"	50CM	Custom Len.
\$75.12	\$84.97	\$94.82	\$104.66	\$112.92	\$81.44	See Web

30

**REVERSE POLARITY SMA FEMALE BULKHEAD TO SMA MALE**

SEE MOUNTING HOLE SECTION ON PAGE 409



**Standard Formable Cable Assemblies**

PE-SR405FLJ Coax, 50 Ohm				Cable Dia.	Attn. @ 1 GHz	Power @ 1 GHz
1 piece price shown. See web or call for volume pricing.				0.105" dia.	19.5 dB/100ft	121.5 W
12"	24"	36"	48"	60"	50CM	Custom Len.
\$97.86	\$107.70	\$115.91	\$125.62	\$135.33	\$104.17	See Web

31

**REVERSE POLARITY SMA FEMALE BULKHEAD TO HMCX32 1.2 PLUG**

SEE MOUNTING HOLE SECTION ON PAGE 409



**Standard Flexible Cable Assemblies**

PE-81mm Coax, 50 Ohm				Cable Dia.	Attn. @ 1 GHz	Power @ 1 GHz
1 piece price shown. See web or call for volume pricing.				0.032" dia.		
3"	6"	12"	-	-	-	Custom Len.
\$14.76	\$14.76	\$16.41	-	-	-	See Web

32

**REVERSE POLARITY SMA FEMALE BULKHEAD TO UMCX PLUG**

SEE MOUNTING HOLE SECTION ON PAGE 409



**Standard Flexible Cable Assemblies**

RG178B/U Coax, 50 Ohm				Cable Dia.	Attn. @ 1 GHz	Power @ 1 GHz
1 piece price shown. See web or call for volume pricing.				0.072" dia.	44.4 dB/100ft	78 W
3"	6"	9"	12"	18"	24"	Custom Len.
\$60.61	\$60.61	\$60.61	\$60.61	\$64.66	\$72.01	See Web

33

**REVERSE POLARITY SMA FEMALE BULKHEAD TO UMCX 2.1 PLUG**

SEE MOUNTING HOLE SECTION ON PAGE 409



**Standard Flexible Cable Assemblies**

PE-81mm Coax, 50 Ohm				Cable Dia.	Attn. @ 1 GHz	Power @ 1 GHz
1 piece price shown. See web or call for volume pricing.				0.032" dia.		
3"	6"	9"	12"	-	-	Custom Len.
\$14.76	\$16.29	Call	\$14.76	-	-	See Web

34

**REVERSE POLARITY SMA FEMALE BULKHEAD TO UMCX 2.5 PLUG**

SEE MOUNTING HOLE SECTION ON PAGE 409



**Standard Flexible Cable Assemblies**

RG178B/U Coax, 50 Ohm				Cable Dia.	Attn. @ 1 GHz	Power @ 1 GHz
1 piece price shown. See web or call for volume pricing.				0.07" dia.		
3"	6"	9"	12"	-	-	Custom Len.
Call	\$12.80	\$14.07	\$14.76	-	-	See Web

35

RG178-DS Coax, 50 Ohm				Cable Dia.	Attn. @ 1 GHz	Power @ 1 GHz
1 piece price shown. See web or call for volume pricing.				0.086" dia.		
3"	6"	9"	12"	-	-	Custom Len.
Call	\$16.03	\$16.03	\$13.71	-	-	See Web

36

PE-81mm Coax, 50 Ohm				Cable Dia.	Attn. @ 1 GHz	Power @ 1 GHz
1 piece price shown. See web or call for volume pricing.				0.032" dia.		
3"	6"	12"	-	-	-	Custom Len.
\$12.80	\$14.76	\$13.71	-	-	-	See Web

37

Cable Assemblies

See Our Website For Current Pricing & Real-Time Stock Availability!

\*Coax Performance at 1 GHz Notes: Cable assembly max frequency may be lower than connector or coax max frequency

For our complete selection of cable assemblies, please visit our website

PE-113mm Coax, 50 Ohm							
Part No. <a href="#">PE3CA1017</a>	Cable Dia.			Attn. @ 1 GHz	Power @ 1 GHz		
1 piece price shown. See web or call for volume pricing.	0.044" dia.						
3"	6"	12"	-	-	-	Custom Len.	38
\$14.76	\$14.76	\$14.76	-	-	-	See Web	

PE-137mm Coax, 50 Ohm							
Part No. <a href="#">PE3CA1018</a>	Cable Dia.			Attn. @ 1 GHz	Power @ 1 GHz		
1 piece price shown. See web or call for volume pricing.	0.053" dia.						
3"	6"	12"	-	-	-	Custom Len.	39
\$14.76	\$14.76	\$14.76	-	-	-	See Web	

**REVERSE POLARITY SMA FEMALE BULKHEAD TO WMCX 1.6 FLANGE**

SEE MOUNTING HOLE SECTION ON PAGE 409



**Standard Flexible Cable Assemblies**

PE-81mm Coax, 50 Ohm							
Part No. <a href="#">PE3CA1021</a>	Cable Dia.			Attn. @ 1 GHz	Power @ 1 GHz		
1 piece price shown. See web or call for volume pricing.	0.032" dia.						
3"	6"	12"	-	-	-	Custom Len.	40
\$12.80	\$12.80	\$14.76	-	-	-	See Web	

**REVERSE THREAD SMA FEMALE BULKHEAD TO UMCX PLUG RIGHT ANGLE**

SEE MOUNTING HOLE SECTION ON PAGE 409



**Standard Flexible Cable Assemblies**

RG178B/U Coax, 50 Ohm							
Part No. <a href="#">PE38301</a>	Cable Dia.			Attn. @ 1 GHz	Power @ 1 GHz		
1 piece price shown. See web or call for volume pricing.	0.072" dia.			44.4 dB/100ft	78 W		
3"	6"	9"	12"	18"	24"	Custom Len.	41
\$64.44	\$65.29	\$66.27	\$67.13	\$68.00	\$68.85	See Web	

**SMA FEMALE 2 HOLE FLANGE TO SMA FEMALE 2 HOLE FLANGE**

SEE MOUNTING HOLE SECTION ON PAGE 409



**Standard Formable Cable Assemblies**

PE-SR047FL Coax, 50 Ohm							
Part No. <a href="#">PE35154</a>	Cable Dia.			Attn. @ 1 GHz	Power @ 1 GHz		
1 piece price shown. See web or call for volume pricing.	0.047" dia.			36 dB/100ft	32 W		
6"	12"	18"	24"	36"	48"	Custom Len.	42
\$95.78	\$105.36	\$99.84	\$103.90	\$110.45	\$118.42	See Web	

PE-SR402FL Coax, 50 Ohm							
Part No. <a href="#">PE35108</a>	Cable Dia.			Attn. @ 1 GHz	Power @ 1 GHz		
1 piece price shown. See web or call for volume pricing.	0.072" dia.			11.88 dB/100ft	450 W		
6"	12"	18"	24"	36"	48"	Custom Len.	43
\$84.49	\$88.45	\$92.49	\$96.49	\$104.56	\$110.98	See Web	

PE-SR405FL Coax, 50 Ohm							
Part No. <a href="#">PE35114</a>	Cable Dia.			Attn. @ 1 GHz	Power @ 1 GHz		
1 piece price shown. See web or call for volume pricing.	0.072" dia.			22.5 dB/100ft	130 W		
6"	12"	18"	24"	36"	48"	Custom Len.	44
\$74.86	\$80.53	\$86.21	\$91.95	\$108.78	\$113.12	See Web	

**Standard Semi-Rigid Cable Assemblies**

PE-047SR Coax, 50 Ohm							
Part No. <a href="#">PE35064</a>	Cable Dia.			Attn. @ 1 GHz	Power @ 1 GHz		
1 piece price shown. See web or call for volume pricing.	0.047" dia.			40 dB/100ft	32 W		
6"	12"	18"	24"	36"	48"	Custom Len.	45
\$99.05	\$104.95	\$104.65	\$115.49	\$119.83	\$130.94	See Web	

RG402/U Coax, 50 Ohm							
Part No. <a href="#">PE3525</a>	Cable Dia.			Attn. @ 1 GHz	Power @ 1 GHz		
1 piece price shown. See web or call for volume pricing.	0.072" dia.			12 dB/100ft	650 W		
6"	12"	18"	24"	36"	48"	Custom Len.	46
\$84.36	\$88.25	\$92.15	\$105.67	\$103.83	\$110.05	See Web	

RG405/U Coax, 50 Ohm							
Part No. <a href="#">PE33191</a>	Cable Dia.			Attn. @ 1 GHz	Power @ 1 GHz		
1 piece price shown. See web or call for volume pricing.	0.072" dia.			22 dB/100ft	130 W		
6"	12"	18"	24"	36"	48"	Custom Len.	47
\$85.16	\$89.12	\$84.80	\$88.56	\$96.14	\$103.67	See Web	

**SMA FEMALE 2 HOLE FLANGE TO SMP FEMALE**

SEE MOUNTING HOLE SECTION ON PAGE 409



**Standard Semi-Rigid Cable Assemblies**

PE-047SR Coax, 50 Ohm							
Part No. <a href="#">PE3W05930</a>	Cable Dia.			Attn. @ 1 GHz	Power @ 1 GHz		
1 piece price shown. See web or call for volume pricing.	0.047" dia.			40 dB/100ft	32 W		
12"	24"	36"	48"	60"	50CM	Custom Len.	48
\$87.45	\$109.60	\$121.27	\$132.91	\$144.55	\$106.91	See Web	

**SMA FEMALE 2 HOLE FLANGE TO SMP FEMALE RIGHT ANGLE**

SEE MOUNTING HOLE SECTION ON PAGE 409



**Standard Formable Cable Assemblies**

PE-SR405FLJ Coax, 50 Ohm							
Part No. <a href="#">PE3W05557</a>	Cable Dia.			Attn. @ 1 GHz	Power @ 1 GHz		
1 piece price shown. See web or call for volume pricing.	0.105" dia.			19.5 dB/100ft	121.5 W		
12"	24"	36"	48"	60"	50CM	Custom Len.	49
\$116.97	\$126.68	\$136.40	\$146.13	\$155.87	\$123.20	See Web	

**SMA FEMALE 4 HOLE FLANGE TO MMCX PLUG RIGHT ANGLE**

SEE MOUNTING HOLE SECTION ON PAGE 409



**Low Loss Flexible Cable Assemblies**

LMR-100A-PVC Coax, 50 Ohm							
Part No. <a href="#">PE3C0064</a>	Cable Dia.			Attn. @ 1 GHz	Power @ 1 GHz		
1 piece price shown. See web or call for volume pricing.	0.11" dia.			24 dB/100ft			
12"	24"	36"	48"	60"	-	Custom Len.	50
\$107.58	\$102.31	\$103.14	\$103.99	\$104.82	-	See Web	

**SMA FEMALE 4 HOLE FLANGE TO SMA FEMALE 4 HOLE FLANGE**

SEE MOUNTING HOLE SECTION ON PAGE 409



**Standard Formable Cable Assemblies**

PE-SR047FL Coax, 50 Ohm							
Part No. <a href="#">PE35112</a>	Cable Dia.			Attn. @ 1 GHz	Power @ 1 GHz		
1 piece price shown. See web or call for volume pricing.	0.047" dia.			36 dB/100ft	32 W		
6"	12"	18"	24"	36"	48"	Custom Len.	51
\$112.85	\$112.27	\$116.12	\$120.01	\$127.76	\$135.50	See Web	

PE-SR402FL Coax, 50 Ohm							
Part No. <a href="#">PE35110</a>	Cable Dia.			Attn. @ 1 GHz	Power @ 1 GHz		
1 piece price shown. See web or call for volume pricing.	0.072" dia.			11.88 dB/100ft	450 W		
6"	12"	18"	24"	36"	48"	Custom Len.	52
\$101.00	\$105.02	\$107.53	\$111.49	\$119.37	\$127.32	See Web	

PE-SR405FL Coax, 50 Ohm							
Part No. <a href="#">PE35116</a>	Cable Dia.			Attn. @ 1 GHz	Power @ 1 GHz		
1 piece price shown. See web or call for volume pricing.	0.072" dia.			22.5 dB/100ft	130 W		
6"	12"	18"	24"	36"	48"	Custom Len.	53
\$106.03	\$110.83	\$110.34	\$116.13	\$127.74	\$139.33	See Web	

**Standard Semi-Rigid Cable Assemblies**

PE-047SR Coax, 50 Ohm							
Part No. <a href="#">PE35118</a>	Cable Dia.			Attn. @ 1 GHz	Power @ 1 GHz		
1 piece price shown. See web or call for volume pricing.	0.047" dia.			40 dB/100ft	32 W		
6"	12"	18"	24"	36"	48"	Custom Len.	54
\$122.19	\$129.53	\$135.52	\$133.28	\$144.39	\$155.48	See Web	

RG402/U Coax, 50 Ohm							
Part No. <a href="#">PE33502</a>	Cable Dia.			Attn. @ 1 GHz	Power @ 1 GHz		
1 piece price shown. See web or call for volume pricing.	0.072" dia.			12 dB/100ft	650 W		
6"	12"	18"	24"	36"	48"	Custom Len.	55
\$109.55	\$109.55	\$113.52	\$124.60	\$133.09	\$142.07	See Web	

RG405/U Coax, 50 Ohm							
Part No. <a href="#">PE3223</a>	Cable Dia.			Attn. @ 1 GHz	Power @ 1 GHz		
1 piece price shown. See web or call for volume pricing.	0.072" dia.			22 dB/100ft	130 W		
6"	12"	18"	24"	36"	48"	Custom Len.	56
\$108.94	\$108.94	\$119.52	\$123.54	\$123.85	\$131.29	See Web	

**SMB PLUG TO BNC MALE**



**Standard Flexible Cable Assemblies**

RG58C/U Coax, 50 Ohm							
Part No. <a href="#">PE3242</a>	Cable Dia.			Attn. @ 1 GHz	Power @ 1 GHz		
1 piece price shown. See web or call for volume pricing.	0.195" dia.			20 dB/100ft	44 W		
12"	24"	36"	48"	60"	72"	Custom Len.	57
\$53.86	\$54.26	\$55.16	\$56.11	\$57.03	\$57.93	See Web	

RG142B/U Coax, 50 Ohm							
Part No. <a href="#">PE3349</a>	Cable Dia.			Attn. @ 1 GHz	Power @ 1 GHz		
1 piece price shown. See web or call for volume pricing.	0.195" dia.			13 dB/100ft	650 W		
12"	24"	36"	48"	60"	72"	Custom Len.	58
\$52.85	\$59.05	\$65.73	\$72.82	\$74.61	\$86.43	See Web	

RG174A/U Coax, 50 Ohm							
Part No. <a href="#">PE3C3318</a>	Cable Dia.			Attn. @ 1 GHz	Power @ 1 GHz		
1 piece price shown. See web or call for volume pricing.	0.11" dia.			32 dB/100ft	17 W		
12"	24"	36"	48"	60"	72"	Custom Len.	59
\$42.08	\$42.72	\$43.38	\$44.04	\$44.69	\$45.35	See Web	

RG178B/U Coax, 50 Ohm							
Part No. <a href="#">PE33825</a>	Cable Dia.			Attn. @ 1 GHz	Power @ 1 GHz		
1 piece price shown. See web or call for volume pricing.	0.072" dia.			44.4 dB/100ft	78 W		
12"	24"	36"	48"	60"	-	Custom Len.	60
\$64.95	\$66.11	\$67.28	\$68.51	\$69.70	-	See Web	

RG188A/U Coax, 50 Ohm							
Part No. <a href="#">PE3C3428</a>	Cable Dia.			Attn. @ 1 GHz	Power @ 1 GHz		
1 piece price shown. See web or call for volume pricing.	0.11" dia.			26 dB/100ft	160 W		
12"	24"	36"	48"	60"	72"	Custom Len.	61
\$47.49	\$54.49	\$52.40	\$60.13	\$62.91	\$65.71	See Web	

Cable Assemblies

See Our Website For Current Pricing & Real-Time Stock Availability!

For Custom Lengths, Metric Lengths or Special Configurations, Please call (949) 261-1920

Technical Support  
+1 (949) 261-1920

Same-Day Shipping,  
Even Custom Cable Assemblies

For our complete selection of cable assemblies, please visit our website

Cable Assemblies

See Our Website For Current Pricing & Real-Time Stock Availability!

RG223/U Coax, 50 Ohm						
Part No. <b>PE3236</b>		Cable Dia.	Attn. @ 1 GHz	Power @ 1 GHz		
1 piece price shown. See web or call for volume pricing.						
12"	24"	36"	48"	60"	72"	Custom Len.
\$49.47	\$52.91	\$55.86	\$59.48	\$62.98	\$66.47	See Web

RG316/U Coax, 50 Ohm						
Part No. <b>PE3C3023</b>		Cable Dia.	Attn. @ 1 GHz	Power @ 1 GHz		
1 piece price shown. See web or call for volume pricing.						
12"	24"	36"	48"	60"	72"	Custom Len.
Call	Call	Call	Call	Call	Call	See Web

PE-P195 Coax, 50 Ohm						
Part No. <b>PE37250</b>		Cable Dia.	Attn. @ 1 GHz	Power @ 1 GHz		
1 piece price shown. See web or call for volume pricing.						
12"	24"	36"	48"	60"	72"	Custom Len.
\$58.36	\$68.89	\$74.51	\$84.26	\$93.99	-	See Web

**SMB PLUG TO N FEMALE**



**Standard Flexible Cable Assemblies**

RG141A/U Coax, 50 Ohm						
Part No. <b>PE3W04161</b>		Cable Dia.	Attn. @ 1 GHz	Power @ 1 GHz		
1 piece price shown. See web or call for volume pricing.						
12"	24"	36"	48"	60"	72"	Custom Len.
\$63.23	\$71.34	\$79.45	\$87.56	\$95.67	\$68.43	See Web

**SMB PLUG TO SMB PLUG**



**Standard Formable Cable Assemblies**

PE-SR405FL Coax, 50 Ohm						
Part No. <b>PE33837</b>		Cable Dia.	Attn. @ 1 GHz	Power @ 1 GHz		
1 piece price shown. See web or call for volume pricing.						
12"	24"	36"	48"	60"	72"	Custom Len.
\$63.64	\$74.45	\$85.36	\$96.17	\$107.05	-	See Web

**Standard Flexible Cable Assemblies**

PE-B100 Coax, 50 Ohm						
Part No. <b>PE34488</b>		Cable Dia.	Attn. @ 1 GHz	Power @ 1 GHz		
1 piece price shown. See web or call for volume pricing.						
12"	24"	36"	48"	60"	72"	Custom Len.
\$53.63	\$66.26	\$74.07	\$75.79	\$83.29	\$90.88	See Web

RG58C/U Coax, 50 Ohm						
Part No. <b>PE33650</b>		Cable Dia.	Attn. @ 1 GHz	Power @ 1 GHz		
1 piece price shown. See web or call for volume pricing.						
12"	24"	36"	48"	60"	72"	Custom Len.
\$64.07	\$70.09	\$70.98	\$66.49	\$67.31	\$68.10	See Web

RG142B/U Coax, 50 Ohm						
Part No. <b>PE33652</b>		Cable Dia.	Attn. @ 1 GHz	Power @ 1 GHz		
1 piece price shown. See web or call for volume pricing.						
12"	24"	36"	48"	60"	72"	Custom Len.
\$55.72	\$67.98	\$74.67	\$74.02	\$80.14	\$95.37	See Web

RG174A/U Coax, 50 Ohm						
Part No. <b>PE3853</b>		Cable Dia.	Attn. @ 1 GHz	Power @ 1 GHz		
1 piece price shown. See web or call for volume pricing.						
12"	24"	36"	48"	60"	72"	Custom Len.
\$49.34	\$49.81	\$50.29	\$50.78	\$51.26	\$51.74	See Web

RG178B/U Coax, 50 Ohm						
Part No. <b>PE33165</b>		Cable Dia.	Attn. @ 1 GHz	Power @ 1 GHz		
1 piece price shown. See web or call for volume pricing.						
12"	24"	36"	48"	60"	72"	Custom Len.
\$62.61	\$63.78	\$64.95	\$62.22	\$67.36	\$68.55	See Web

RG188A/U Coax, 50 Ohm						
Part No. <b>PE3587</b>		Cable Dia.	Attn. @ 1 GHz	Power @ 1 GHz		
1 piece price shown. See web or call for volume pricing.						
12"	24"	36"	48"	60"	72"	Custom Len.
\$55.94	\$58.68	\$56.66	\$59.11	\$61.55	\$69.91	See Web

RG188-DS Coax, 50 Ohm						
Part No. <b>PE3721</b>		Cable Dia.	Attn. @ 1 GHz	Power @ 1 GHz		
1 piece price shown. See web or call for volume pricing.						
12"	24"	36"	48"	60"	72"	Custom Len.
\$53.62	\$56.88	\$60.61	\$64.37	\$68.10	\$71.84	See Web

RG196A/U Coax, 50 Ohm						
Part No. <b>PE3588</b>		Cable Dia.	Attn. @ 1 GHz	Power @ 1 GHz		
1 piece price shown. See web or call for volume pricing.						
12"	24"	36"	48"	60"	72"	Custom Len.
\$60.61	\$62.12	\$67.35	\$65.13	\$70.58	\$68.15	See Web

RG223/U Coax, 50 Ohm						
Part No. <b>PE3166</b>		Cable Dia.	Attn. @ 1 GHz	Power @ 1 GHz		
1 piece price shown. See web or call for volume pricing.						
12"	24"	36"	48"	60"	72"	Custom Len.
\$61.58	\$65.01	\$68.44	\$67.67	\$70.84	\$74.05	See Web

RG316/U Coax, 50 Ohm						
Part No. <b>PE3915</b>		Cable Dia.	Attn. @ 1 GHz	Power @ 1 GHz		
1 piece price shown. See web or call for volume pricing.						
12"	24"	36"	48"	60"	72"	Custom Len.
\$55.95	\$59.38	\$62.81	\$66.46	\$69.96	\$73.47	See Web

RG316-DS Coax, 50 Ohm						
Part No. <b>PE33704</b>		Cable Dia.	Attn. @ 1 GHz	Power @ 1 GHz		
1 piece price shown. See web or call for volume pricing.						
12"	24"	36"	48"	60"	72"	Custom Len.
\$54.79	\$58.24	\$61.67	\$62.30	\$65.52	\$72.32	See Web

RG400/U Coax, 50 Ohm						
Part No. <b>PE34269</b>		Cable Dia.	Attn. @ 1 GHz	Power @ 1 GHz		
1 piece price shown. See web or call for volume pricing.						
12"	24"	36"	48"	60"	72"	Custom Len.
\$70.37	\$78.50	\$79.43	\$87.12	\$103.51	\$102.56	See Web

**SMB PLUG TO SMB PLUG RIGHT ANGLE**



**Standard Flexible Cable Assemblies**

PE-B100 Coax, 50 Ohm						
Part No. <b>PE34490</b>		Cable Dia.	Attn. @ 1 GHz	Power @ 1 GHz		
1 piece price shown. See web or call for volume pricing.						
12"	24"	36"	48"	60"	72"	Custom Len.
\$56.77	\$64.30	\$71.82	\$79.43	\$86.94	\$94.52	See Web

RG58C/U Coax, 50 Ohm						
Part No. <b>PE33666</b>		Cable Dia.	Attn. @ 1 GHz	Power @ 1 GHz		
1 piece price shown. See web or call for volume pricing.						
12"	24"	36"	48"	60"	72"	Custom Len.
\$66.46	\$67.28	\$68.08	\$68.89	\$69.70	\$70.51	See Web

RG142B/U Coax, 50 Ohm						
Part No. <b>PE33668</b>		Cable Dia.	Attn. @ 1 GHz	Power @ 1 GHz		
1 piece price shown. See web or call for volume pricing.						
12"	24"	36"	48"	60"	72"	Custom Len.
\$59.09	\$65.23	\$71.28	\$77.44	\$83.50	\$89.58	See Web

RG174A/U Coax, 50 Ohm						
Part No. <b>PE33175</b>		Cable Dia.	Attn. @ 1 GHz	Power @ 1 GHz		
1 piece price shown. See web or call for volume pricing.						
12"	24"	36"	48"	60"	72"	Custom Len.
\$60.83	\$61.31	\$61.78	\$68.85	\$69.49	\$70.14	See Web

RG178B/U Coax, 50 Ohm						
Part No. <b>PE33356</b>		Cable Dia.	Attn. @ 1 GHz	Power @ 1 GHz		
1 piece price shown. See web or call for volume pricing.						
12"	24"	36"	48"	60"	72"	Custom Len.
\$69.82	\$70.85	\$71.92	\$72.98	\$74.04	\$75.08	See Web

RG188A/U Coax, 50 Ohm						
Part No. <b>PE3592</b>		Cable Dia.	Attn. @ 1 GHz	Power @ 1 GHz		
1 piece price shown. See web or call for volume pricing.						
12"	24"	36"	48"	60"	72"	Custom Len.
\$58.18	\$60.46	\$62.85	\$65.23	\$67.55	\$69.91	See Web

RG188-DS Coax, 50 Ohm						
Part No. <b>PE33143</b>		Cable Dia.	Attn. @ 1 GHz	Power @ 1 GHz		
1 piece price shown. See web or call for volume pricing.						
12"	24"	36"	48"	60"	72"	Custom Len.
\$64.19	\$67.93	\$71.66	\$75.39	\$79.14	\$82.88	See Web

RG196A/U Coax, 50 Ohm						
Part No. <b>PE3593</b>		Cable Dia.	Attn. @ 1 GHz	Power @ 1 GHz		
1 piece price shown. See web or call for volume pricing.						
12"	24"	36"	48"	60"	72"	Custom Len.
\$65.04	\$66.48	\$67.95	\$69.37	\$70.83	\$72.28	See Web

RG223/U Coax, 50 Ohm						
Part No. <b>PE33670</b>		Cable Dia.	Attn. @ 1 GHz	Power @ 1 GHz		
1 piece price shown. See web or call for volume pricing.						
12"	24"	36"	48"	60"	72"	Custom Len.
\$56.26	\$59.43	\$67.60	\$65.82	\$69.06	\$72.28	See Web

RG316/U Coax, 50 Ohm						
Part No. <b>PE33672</b>		Cable Dia.	Attn. @ 1 GHz	Power @ 1 GHz		
1 piece price shown. See web or call for volume pricing.						
12"	24"	36"	48"	60"	72"	Custom Len.
\$59.09	\$62.40	\$65.69	\$68.97	\$72.28	\$75.58	See Web

RG316-DS Coax, 50 Ohm						
Part No. <b>PE34485</b>		Cable Dia.	Attn. @ 1 GHz	Power @ 1 GHz		
1 piece price shown. See web or call for volume pricing.						
12"	24"	36"	48"	60"	72"	Custom Len.
\$63.76	\$66.96	\$70.15	\$79.35	\$76.56	\$79.75	See Web

RG400/U Coax, 50 Ohm						
Part No. <b>PE34481</b>		Cable Dia.	Attn. @ 1 GHz	Power @ 1 GHz		
1 piece price shown. See web or call for volume pricing.						
12"	24"	36"	48"	60"	72"	Custom Len.
\$73.93	\$81.66	\$89.37	\$97.11	\$104.81	\$110.98	See Web

\*Coax Performance at 1 GHz Notes: Cable assembly max frequency may be lower than connector or coax max frequency



For our complete selection of cable assemblies, please visit our website

<b>SMB PLUG TO SMB JACK BULKHEAD</b>						
SEE MOUNTING HOLE SECTION ON PAGE 409						
Standard Flexible Cable Assemblies						
PE-B100 Coax, 50 Ohm						
Part No. <b>PE34491</b>	Cable Dia.	Attn. @ 1 GHz	Power @ 1 GHz			
1 piece price shown. See web or call for volume pricing.	0.101" dia.	13 dB/100ft	650 W			
12" 24" 36" 48"	60"	72"	Custom Len.			
\$56.46 \$64.03 \$71.55 \$79.09	\$86.66	\$94.19	See Web			
RG58C/U Coax, 50 Ohm						
Part No. <b>PE34493</b>	Cable Dia.	Attn. @ 1 GHz	Power @ 1 GHz			
1 piece price shown. See web or call for volume pricing.	0.195" dia.	20 dB/100ft	44 W			
12" 24" 36" 48"	60"	72"	Custom Len.			
\$73.00 \$73.81 \$74.63 \$75.42	\$76.22	\$77.04	See Web			
RG142B/U Coax, 50 Ohm						
Part No. <b>PE34495</b>	Cable Dia.	Attn. @ 1 GHz	Power @ 1 GHz			
1 piece price shown. See web or call for volume pricing.	0.195" dia.	13 dB/100ft	650 W			
12" 24" 36" 48"	60"	72"	Custom Len.			
\$70.11 \$83.81 \$82.26 \$88.38	\$94.45	\$100.59	See Web			
RG174A/U Coax, 50 Ohm						
Part No. <b>PE33674</b>	Cable Dia.	Attn. @ 1 GHz	Power @ 1 GHz			
1 piece price shown. See web or call for volume pricing.	0.1" dia.	32 dB/100ft	16 W			
12" 24" 36" 48"	60"	72"	Custom Len.			
\$56.54 \$57.18 \$54.30 \$58.49	\$59.13	\$55.73	See Web			
RG178B/U Coax, 50 Ohm						
Part No. <b>PE33676</b>	Cable Dia.	Attn. @ 1 GHz	Power @ 1 GHz			
1 piece price shown. See web or call for volume pricing.	0.072" dia.	44.4 dB/100ft	78 W			
12" 24" 36" 48"	60"	72"	Custom Len.			
\$62.94 \$59.34 \$60.37 \$61.44	\$62.48	\$68.87	See Web			
RG188A/U Coax, 50 Ohm						
Part No. <b>PE3591</b>	Cable Dia.	Attn. @ 1 GHz	Power @ 1 GHz			
1 piece price shown. See web or call for volume pricing.	0.11" dia.	26 dB/100ft	160 W			
12" 24" 36" 48"	60"	72"	Custom Len.			
\$51.70 \$59.09 \$55.99 \$58.29	\$60.68	\$62.99	See Web			
RG188-DS Coax, 50 Ohm						
Part No. <b>PE34489</b>	Cable Dia.	Attn. @ 1 GHz	Power @ 1 GHz			
1 piece price shown. See web or call for volume pricing.	0.122" dia.	30 dB/100ft	160 W			
12" 24" 36" 48"	60"	72"	Custom Len.			
\$61.32 \$65.17 \$64.24 \$67.98	\$71.73	\$75.46	See Web			
RG196A/U Coax, 50 Ohm						
Part No. <b>PE3130</b>	Cable Dia.	Attn. @ 1 GHz	Power @ 1 GHz			
1 piece price shown. See web or call for volume pricing.	0.08" dia.	49 dB/100ft	78 W			
12" 24" 36" 48"	60"	72"	Custom Len.			
\$58.71 \$63.79 \$61.73 \$63.24	\$64.73	\$66.24	See Web			
RG223/U Coax, 50 Ohm						
Part No. <b>PE34497</b>	Cable Dia.	Attn. @ 1 GHz	Power @ 1 GHz			
1 piece price shown. See web or call for volume pricing.	0.21" dia.	13.4 dB/100ft	53 W			
12" 24" 36" 48"	60"	72"	Custom Len.			
\$67.21 \$70.38 \$73.61 \$76.84	\$80.01	\$83.24	See Web			
RG316-DS Coax, 50 Ohm						
Part No. <b>PE34487</b>	Cable Dia.	Attn. @ 1 GHz	Power @ 1 GHz			
1 piece price shown. See web or call for volume pricing.	0.114" dia.	30 dB/100ft	160 W			
12" 24" 36" 48"	60"	72"	Custom Len.			
\$63.12 \$60.58 \$63.78 \$66.99	\$70.18	\$73.38	See Web			
RG400/U Coax, 50 Ohm						
Part No. <b>PE34483</b>	Cable Dia.	Attn. @ 1 GHz	Power @ 1 GHz			
1 piece price shown. See web or call for volume pricing.	0.195" dia.	14.7 dB/100ft	650 W			
12" 24" 36" 48"	60"	72"	Custom Len.			
\$78.29 \$86.03 \$93.73 \$101.44	\$107.67	\$115.27	See Web			

<b>SMB PLUG TO SMP FEMALE</b>						
Flexible Cable Assemblies						
PE-P086 Coax, 50 Ohm						
Part No. <b>PE3C6787</b>	Cable Dia.	Attn. @ 1 GHz	Power @ 1 GHz			
1 piece price shown. See web or call for volume pricing.	0.104" dia.	21.7 dB/100ft	650 W			
12" 24" 36" 48"	60"	50CM	Custom Len.			
\$78.28 \$87.44 \$92.01 \$101.17	\$108.79	\$79.57	See Web			

<b>SMB PLUG TO SSMA MALE</b>						
Standard Flexible Cable Assemblies						
RG178B/U Coax, 50 Ohm						
Part No. <b>PE3C7602</b>	Cable Dia.	Attn. @ 1 GHz	Power @ 1 GHz			
1 piece price shown. See web or call for volume pricing.	0.072" dia.	44.41 dB/100ft	55 W			
12" 24" 36" 48"	60"	50CM	Custom Len.			
\$66.81 \$68.06 \$69.30 \$70.54	\$71.78	\$67.60	See Web			

<b>SMB PLUG RIGHT ANGLE TO BNC MALE</b>						
Standard Flexible Cable Assemblies						
RG223/U Coax, 50 Ohm						
Part No. <b>PE3W06905</b>	Cable Dia.	Attn. @ 1 GHz	Power @ 1 GHz			
1 piece price shown. See web or call for volume pricing.	0.209" dia.	13.41 dB/100ft	50 W			
12" 24" 36" 48"	60"	50CM	Custom Len.			
\$48.38 \$51.98 \$55.06 \$58.62	\$62.18	\$50.67	See Web			

<b>SMB PLUG RIGHT ANGLE TO SMA MALE</b>						
Standard Flexible Cable Assemblies						
RG174A/U Coax, 50 Ohm						
Part No. <b>PE3W03030</b>	Cable Dia.	Attn. @ 1 GHz	Power @ 1 GHz			
1 piece price shown. See web or call for volume pricing.	0.11" dia.	32 dB/100ft	17 W			
12" 24" 36" 48"	60"	50CM	Custom Len.			
\$41.59 \$42.21 \$42.83 \$43.45	\$44.07	\$41.98	See Web			

<b>SMB PLUG RIGHT ANGLE TO SMB PLUG RIGHT ANGLE</b>						
Low Loss Flexible Cable Assemblies						
PE-C195 Coax, 50 Ohm						
Part No. <b>PE39120</b>	Cable Dia.	Attn. @ 1 GHz	Power @ 1 GHz			
1 piece price shown. See web or call for volume pricing.	0.195" dia.	11.3 dB/100ft	150 W			
12" 24" 36" 48"	60"	-	Custom Len.			
\$58.90 \$59.75 \$55.99 \$56.72	\$57.45	-	See Web			

Standard Flexible Cable Assemblies						
PE-B100 Coax, 50 Ohm						
Part No. <b>PE34465</b>	Cable Dia.	Attn. @ 1 GHz	Power @ 1 GHz			
1 piece price shown. See web or call for volume pricing.	0.101" dia.	72"	Custom Len.			
12" 24" 36" 48"	60"	\$105.37	See Web			
\$66.38 \$74.17 \$81.98 \$89.76	\$97.57					

Standard Flexible Cable Assemblies						
RG58C/U Coax, 50 Ohm						
Part No. <b>PE33654</b>	Cable Dia.	Attn. @ 1 GHz	Power @ 1 GHz			
1 piece price shown. See web or call for volume pricing.	0.195" dia.	20 dB/100ft	44 W			
12" 24" 36" 48"	60"	72"	Custom Len.			
\$75.62 \$70.82 \$71.64 \$72.44	\$73.25	\$80.18	See Web			

Standard Flexible Cable Assemblies						
RG142B/U Coax, 50 Ohm						
Part No. <b>PE33656</b>	Cable Dia.	Attn. @ 1 GHz	Power @ 1 GHz			
1 piece price shown. See web or call for volume pricing.	0.195" dia.	13 dB/100ft	650 W			
12" 24" 36" 48"	60"	72"	Custom Len.			
\$74.65 \$80.94 \$92.50 \$93.55	\$99.86	\$111.62	See Web			

Standard Flexible Cable Assemblies						
RG174A/U Coax, 50 Ohm						
Part No. <b>PE3916</b>	Cable Dia.	Attn. @ 1 GHz	Power @ 1 GHz			
1 piece price shown. See web or call for volume pricing.	0.11" dia.	32 dB/100ft	17 W			
12" 24" 36" 48"	60"	72"	Custom Len.			
\$69.85 \$70.50 \$65.63 \$66.11	\$66.57	\$67.06	See Web			

Standard Flexible Cable Assemblies						
RG178B/U Coax, 50 Ohm						
Part No. <b>PE33350</b>	Cable Dia.	Attn. @ 1 GHz	Power @ 1 GHz			
1 piece price shown. See web or call for volume pricing.	0.072" dia.	44.4 dB/100ft	78 W			
12" 24" 36" 48"	60"	72"	Custom Len.			
\$72.24 \$73.27 \$74.34 \$75.39	\$76.45	\$77.51	See Web			

Standard Flexible Cable Assemblies						
RG188A/U Coax, 50 Ohm						
Part No. <b>PE3589</b>	Cable Dia.	Attn. @ 1 GHz	Power @ 1 GHz			
1 piece price shown. See web or call for volume pricing.	0.11" dia.	26 dB/100ft	160 W			
12" 24" 36" 48"	60"	72"	Custom Len.			
\$66.75 \$76.16 \$71.62 \$74.07	\$76.50	\$78.94	See Web			

Standard Flexible Cable Assemblies						
RG188-DS Coax, 50 Ohm						
Part No. <b>PE34463</b>	Cable Dia.	Attn. @ 1 GHz	Power @ 1 GHz			
1 piece price shown. See web or call for volume pricing.	0.122" dia.	30 dB/100ft	160 W			
12" 24" 36" 48"	60"	72"	Custom Len.			
\$68.10 \$71.84 \$75.57 \$79.32	\$83.07	\$86.80	See Web			

Standard Flexible Cable Assemblies						
RG196A/U Coax, 50 Ohm						
Part No. <b>PE3590</b>	Cable Dia.	Attn. @ 1 GHz	Power @ 1 GHz			
1 piece price shown. See web or call for volume pricing.	0.08" dia.	49 dB/100ft	78 W			
12" 24" 36" 48"	60"	72"	Custom Len.			
\$67.29 \$68.74 \$70.18 \$71.62	\$73.07	\$74.51	See Web			

Standard Flexible Cable Assemblies						
RG223/U Coax, 50 Ohm						
Part No. <b>PE33121</b>	Cable Dia.	Attn. @ 1 GHz	Power @ 1 GHz			
1 piece price shown. See web or call for volume pricing.	0.209" dia.	13.41 dB/100ft	50 W			
12" 24" 36" 48"	60"	72"	Custom Len.			
\$71.51 \$74.70 \$77.88 \$81.08	\$84.27	\$87.45	See Web			

Standard Flexible Cable Assemblies						
RG316/U Coax, 50 Ohm						
Part No. <b>PE3917</b>	Cable Dia.	Attn. @ 1 GHz	Power @ 1 GHz			
1 piece price shown. See web or call for volume pricing.	0.098" dia.	38 dB/100ft	160 W			
12" 24" 36" 48"	60"	72"	Custom Len.			
\$69.00 \$77.95 \$75.35 \$85.02	\$81.70	\$92.02	See Web			

Cable Assemblies

See Our Website For Current Pricing & Real-Time Stock Availability!

For Custom Lengths, Metric Lengths or Special Configurations, Please call (949) 261-1920

Technical Support  
+1 (949) 261-1920

Same-Day Shipping,  
Even Custom Cable Assemblies



For our complete selection of cable assemblies, please visit our website

Cable Assemblies

See Our Website For Current Pricing & Real-Time Stock Availability!

RG316-DS Coax, 50 Ohm						
Part No. <a href="#">PE33476</a>	Cable Dia.	Attn. @ 1 GHz	Power @ 1 GHz			
1 piece price shown. See web or call for volume pricing.						
12"	24"	36"	48"	60"	72"	Custom Len.
\$73.10	\$76.53	\$74.08	\$77.28	\$80.48	\$83.68	See Web
RG400/U Coax, 50 Ohm						
Part No. <a href="#">PE34461</a>	Cable Dia.	Attn. @ 1 GHz	Power @ 1 GHz			
1 piece price shown. See web or call for volume pricing.						
12"	24"	36"	48"	60"	72"	Custom Len.
\$81.93	\$85.02	\$92.74	\$100.47	\$106.68	\$114.29	See Web
SMB PLUG RIGHT ANGLE TO SMB JACK BULKHEAD						
SEE MOUNTING HOLE SECTION ON PAGE 409						
Standard Flexible Cable Assemblies						
PE-B100 Coax, 50 Ohm						
Part No. <a href="#">PE34479</a>	Cable Dia.	Attn. @ 1 GHz	Power @ 1 GHz			
1 piece price shown. See web or call for volume pricing.						
12"	24"	36"	48"	60"	72"	Custom Len.
\$60.09	\$67.61	\$75.21	\$82.71	\$90.29	\$97.83	See Web
RG58C/U Coax, 50 Ohm						
Part No. <a href="#">PE34469</a>	Cable Dia.	Attn. @ 1 GHz	Power @ 1 GHz			
1 piece price shown. See web or call for volume pricing.						
12"	24"	36"	48"	60"	72"	Custom Len.
\$72.16	\$72.95	\$73.75	\$74.61	\$75.38	\$76.18	See Web
RG142B/U Coax, 50 Ohm						
Part No. <a href="#">PE34471</a>	Cable Dia.	Attn. @ 1 GHz	Power @ 1 GHz			
1 piece price shown. See web or call for volume pricing.						
12"	24"	36"	48"	60"	72"	Custom Len.
\$73.48	\$79.55	\$85.70	\$91.76	\$97.89	\$103.95	See Web
RG174A/U Coax, 50 Ohm						
Part No. <a href="#">PE33261</a>	Cable Dia.	Attn. @ 1 GHz	Power @ 1 GHz			
1 piece price shown. See web or call for volume pricing.						
12"	24"	36"	48"	60"	72"	Custom Len.
\$65.58	\$66.06	\$66.53	\$67.02	\$67.49	\$67.97	See Web
RG178B/U Coax, 50 Ohm						
Part No. <a href="#">PE34467</a>	Cable Dia.	Attn. @ 1 GHz	Power @ 1 GHz			
1 piece price shown. See web or call for volume pricing.						
12"	24"	36"	48"	60"	72"	Custom Len.
\$69.14	\$63.91	\$64.97	\$66.01	\$67.06	\$68.13	See Web
RG188A/U Coax, 50 Ohm						
Part No. <a href="#">PE33594</a>	Cable Dia.	Attn. @ 1 GHz	Power @ 1 GHz			
1 piece price shown. See web or call for volume pricing.						
12"	24"	36"	48"	60"	72"	Custom Len.
\$66.38	\$68.81	\$71.25	\$73.69	\$76.13	\$78.57	See Web
RG188-DS Coax, 50 Ohm						
Part No. <a href="#">PE34477</a>	Cable Dia.	Attn. @ 1 GHz	Power @ 1 GHz			
1 piece price shown. See web or call for volume pricing.						
12"	24"	36"	48"	60"	72"	Custom Len.
\$69.00	\$66.36	\$69.98	\$73.61	\$77.24	\$80.81	See Web
RG196A/U Coax, 50 Ohm						
Part No. <a href="#">PE33682</a>	Cable Dia.	Attn. @ 1 GHz	Power @ 1 GHz			
1 piece price shown. See web or call for volume pricing.						
12"	24"	36"	48"	60"	72"	Custom Len.
\$63.25	\$64.70	\$66.15	\$67.61	\$69.06	\$70.51	See Web
RG223/U Coax, 50 Ohm						
Part No. <a href="#">PE34473</a>	Cable Dia.	Attn. @ 1 GHz	Power @ 1 GHz			
1 piece price shown. See web or call for volume pricing.						
12"	24"	36"	48"	60"	72"	Custom Len.
\$70.57	\$73.80	\$76.99	\$80.19	\$83.45	\$86.61	See Web
RG316/U Coax, 50 Ohm						
Part No. <a href="#">PE33675</a>	Cable Dia.	Attn. @ 1 GHz	Power @ 1 GHz			
1 piece price shown. See web or call for volume pricing.						
12"	24"	36"	48"	60"	72"	Custom Len.
\$62.45	\$65.74	\$69.06	\$72.35	\$75.64	\$86.21	See Web
RG316-DS Coax, 50 Ohm						
Part No. <a href="#">PE33349</a>	Cable Dia.	Attn. @ 1 GHz	Power @ 1 GHz			
1 piece price shown. See web or call for volume pricing.						
12"	24"	36"	48"	60"	72"	Custom Len.
\$62.33	\$71.99	\$68.79	\$72.03	\$75.26	\$78.42	See Web
RG400/U Coax, 50 Ohm						
Part No. <a href="#">PE34475</a>	Cable Dia.	Attn. @ 1 GHz	Power @ 1 GHz			
1 piece price shown. See web or call for volume pricing.						
12"	24"	36"	48"	60"	72"	Custom Len.
\$88.33	\$96.04	\$103.77	\$109.93	\$117.55	\$125.15	See Web
SMB PLUG RIGHT ANGLE TO SSMB PLUG						
Standard Flexible Cable Assemblies						
RG174A/U Coax, 50 Ohm						
Part No. <a href="#">PE3W04513</a>	Cable Dia.	Attn. @ 1 GHz	Power @ 1 GHz			
1 piece price shown. See web or call for volume pricing.						
12"	24"	36"	48"	60"	72"	Custom Len.
\$62.35	\$62.97	\$63.58	\$64.20	\$64.82	\$62.12	See Web

SMC PLUG TO 10-32 MALE RIGHT ANGLE						
Standard Flexible Cable Assemblies						
RG196A/U Coax, 50 Ohm						
Part No. <a href="#">PE3W00597</a>	Cable Dia.	Attn. @ 1 GHz	Power @ 1 GHz			
1 piece price shown. See web or call for volume pricing.						
12"	24"	36"	48"	60"	72"	Custom Len.
\$79.01	\$80.51	\$82.01	\$83.50	\$85.00	\$79.97	See Web
SMC PLUG TO BNC MALE						
Standard Flexible Cable Assemblies						
RG58C/U Coax, 50 Ohm						
Part No. <a href="#">PE3244</a>	Cable Dia.	Attn. @ 1 GHz	Power @ 1 GHz			
1 piece price shown. See web or call for volume pricing.						
12"	24"	36"	48"	60"	72"	Custom Len.
\$55.37	\$56.18	\$60.46	\$57.78	\$62.34	\$59.42	See Web
RG174A/U Coax, 50 Ohm						
Part No. <a href="#">PE3C3425</a>	Cable Dia.	Attn. @ 1 GHz	Power @ 1 GHz			
1 piece price shown. See web or call for volume pricing.						
12"	24"	36"	48"	60"	72"	Custom Len.
\$48.17	\$48.82	\$49.46	\$46.06	\$50.79	\$47.03	See Web
RG188A/U Coax, 50 Ohm						
Part No. <a href="#">PE3C2578</a>	Cable Dia.	Attn. @ 1 GHz	Power @ 1 GHz			
1 piece price shown. See web or call for volume pricing.						
12"	24"	36"	48"	60"	72"	Custom Len.
\$45.70	\$48.16	\$50.61	\$53.09	\$59.16	\$57.47	See Web
RG223/U Coax, 50 Ohm						
Part No. <a href="#">PE3238</a>	Cable Dia.	Attn. @ 1 GHz	Power @ 1 GHz			
1 piece price shown. See web or call for volume pricing.						
12"	24"	36"	48"	60"	72"	Custom Len.
\$46.48	\$49.43	\$52.38	\$55.33	\$58.29	\$61.24	See Web
RG316/U Coax, 50 Ohm						
Part No. <a href="#">PE3C2599</a>	Cable Dia.	Attn. @ 1 GHz	Power @ 1 GHz			
1 piece price shown. See web or call for volume pricing.						
12"	24"	36"	48"	60"	72"	Custom Len.
\$47.42	\$50.89	\$54.36	\$57.49	\$56.36	\$59.52	See Web
SMC PLUG TO MCX PLUG						
Low Loss Flexible Cable Assemblies						
LMR-100A-PVC Coax, 50 Ohm						
Part No. <a href="#">PE3W04152</a>	Cable Dia.	Attn. @ 1 GHz	Power @ 1 GHz			
1 piece price shown. See web or call for volume pricing.						
12"	24"	36"	48"	60"	72"	Custom Len.
\$38.04	\$38.84	\$39.67	\$40.49	\$41.31	Call	See Web
SMC PLUG TO SMA MALE						
Low Loss Flexible Cable Assemblies						
LMR-100A-PVC Coax, 50 Ohm						
Part No. <a href="#">PE3W04200</a>	Cable Dia.	Attn. @ 1 GHz	Power @ 1 GHz			
1 piece price shown. See web or call for volume pricing.						
12"	24"	36"	48"	60"	72"	Custom Len.
\$44.04	\$44.86	\$45.68	\$46.49	\$47.31	\$44.58	See Web
SMC PLUG TO SMC PLUG						
Standard Flexible Cable Assemblies						
PE-B100 Coax, 50 Ohm						
Part No. <a href="#">PE34501</a>	Cable Dia.	Attn. @ 1 GHz	Power @ 1 GHz			
1 piece price shown. See web or call for volume pricing.						
12"	24"	36"	48"	60"	72"	Custom Len.
\$53.57	\$60.61	\$68.19	\$75.71	\$83.29	\$90.82	See Web
RG58C/U Coax, 50 Ohm						
Part No. <a href="#">PE33641</a>	Cable Dia.	Attn. @ 1 GHz	Power @ 1 GHz			
1 piece price shown. See web or call for volume pricing.						
12"	24"	36"	48"	60"	72"	Custom Len.
\$69.44	\$70.24	\$71.10	\$71.88	\$72.68	\$73.48	See Web
RG142B/U Coax, 50 Ohm						
Part No. <a href="#">PE3490</a>	Cable Dia.	Attn. @ 1 GHz	Power @ 1 GHz			
1 piece price shown. See web or call for volume pricing.						
12"	24"	36"	48"	60"	72"	Custom Len.
\$66.42	\$72.48	\$78.55	\$84.68	\$90.77	\$96.89	See Web

\*Coax Performance at 1 GHz Notes: Cable assembly max frequency may be lower than connector or coax max frequency

# For our complete selection of cable assemblies, please visit our website

RG174A/U Coax, 50 Ohm							
Part No. <b>PE3883</b>			Cable Dia.	Attn. @ 1 GHz	Power @ 1 GHz	44	
1 piece price shown. See web or call for volume pricing.			0.11" dia.	32 dB/100ft	16 W		
12"	24"	36"	48"	60"	72"		Custom Len.
\$51.09	\$55.31	\$55.95	\$52.55	\$53.03	\$53.51		See Web
RG178B/U Coax, 50 Ohm							
Part No. <b>PE3902</b>			Cable Dia.	Attn. @ 1 GHz	Power @ 1 GHz	45	
1 piece price shown. See web or call for volume pricing.			0.072" dia.	44.4 dB/100ft	78 W		
12"	24"	36"	48"	60"	72"		Custom Len.
\$61.19	\$62.23	\$63.29	\$69.63	\$65.40	\$66.46		See Web
RG188A/U Coax, 50 Ohm							
Part No. <b>PE3595</b>			Cable Dia.	Attn. @ 1 GHz	Power @ 1 GHz	46	
1 piece price shown. See web or call for volume pricing.			0.11" dia.	26 dB/100ft	160 W		
12"	24"	36"	48"	60"	72"		Custom Len.
\$54.80	\$54.13	\$56.58	\$59.02	\$61.46	\$63.90		See Web
RG188-DS Coax, 50 Ohm							
Part No. <b>PE33154</b>			Cable Dia.	Attn. @ 1 GHz	Power @ 1 GHz	47	
1 piece price shown. See web or call for volume pricing.			0.118" dia.	30 dB/100ft	160 W		
12"	24"	36"	48"	60"	72"		Custom Len.
\$49.59	\$53.25	\$56.38	\$60.02	\$63.64	\$67.21		See Web
RG196A/U Coax, 50 Ohm							
Part No. <b>PE3596</b>			Cable Dia.	Attn. @ 1 GHz	Power @ 1 GHz	48	
1 piece price shown. See web or call for volume pricing.			0.08" dia.	49 dB/100ft	78 W		
12"	24"	36"	48"	60"	72"		Custom Len.
\$57.05	\$58.51	\$59.94	\$61.40	\$62.85	\$64.30		See Web
RG223/U Coax, 50 Ohm							
Part No. <b>PE33647</b>			Cable Dia.	Attn. @ 1 GHz	Power @ 1 GHz	49	
1 piece price shown. See web or call for volume pricing.			0.21" dia.	13.4 dB/100ft	53 W		
12"	24"	36"	48"	60"	72"		Custom Len.
\$67.34	\$70.52	\$73.71	\$76.90	\$80.09	\$83.27		See Web
RG316/U Coax, 50 Ohm							
Part No. <b>PE3808</b>			Cable Dia.	Attn. @ 1 GHz	Power @ 1 GHz	50	
1 piece price shown. See web or call for volume pricing.			0.098" dia.	38 dB/100ft	160 W		
12"	24"	36"	48"	60"	72"		Custom Len.
\$59.13	\$62.57	\$66.00	\$69.63	\$66.46	\$69.63		See Web
RG316-DS Coax, 50 Ohm							
Part No. <b>PE34721</b>			Cable Dia.	Attn. @ 1 GHz	Power @ 1 GHz	51	
1 piece price shown. See web or call for volume pricing.			0.114" dia.	30 dB/100ft	160 W		
12"	24"	36"	48"	60"	72"		Custom Len.
\$54.11	\$56.82	\$60.01	\$63.21	\$66.41	\$74.35		See Web
RG400/U Coax, 50 Ohm							
Part No. <b>PE34494</b>			Cable Dia.	Attn. @ 1 GHz	Power @ 1 GHz	52	
1 piece price shown. See web or call for volume pricing.			0.195" dia.	14.7 dB/100ft	650 W		
12"	24"	36"	48"	60"	72"		Custom Len.
\$74.61	\$82.32	\$90.02	\$97.77	\$105.48	\$111.63		See Web

## SMC PLUG TO SMC PLUG RIGHT ANGLE



### Standard Flexible Cable Assemblies

PE-B100 Coax, 50 Ohm							
Part No. <b>PE34502</b>			Cable Dia.	Attn. @ 1 GHz	Power @ 1 GHz	53	
1 piece price shown. See web or call for volume pricing.			0.101" dia.				
12"	24"	36"	48"	60"	72"		Custom Len.
\$58.10	\$65.61	\$73.21	\$80.75	\$88.33	\$95.84		See Web
RG58C/U Coax, 50 Ohm							
Part No. <b>PE33658</b>			Cable Dia.	Attn. @ 1 GHz	Power @ 1 GHz	54	
1 piece price shown. See web or call for volume pricing.			0.195" dia.	20 dB/100ft	44 W		
12"	24"	36"	48"	60"	72"		Custom Len.
\$73.75	\$74.51	\$75.38	\$76.18	\$76.99	\$77.79		See Web
RG142B/U Coax, 50 Ohm							
Part No. <b>PE33660</b>			Cable Dia.	Attn. @ 1 GHz	Power @ 1 GHz	55	
1 piece price shown. See web or call for volume pricing.			0.195" dia.	13 dB/100ft	650 W		
12"	24"	36"	48"	60"	72"		Custom Len.
\$64.44	\$70.57	\$76.65	\$82.71	\$88.85	\$94.92		See Web
RG174A/U Coax, 50 Ohm							
Part No. <b>PE33556</b>			Cable Dia.	Attn. @ 1 GHz	Power @ 1 GHz	56	
1 piece price shown. See web or call for volume pricing.			0.1" dia.	32 dB/100ft	16 W		
12"	24"	36"	48"	60"	72"		Custom Len.
\$63.40	\$64.04	\$58.62	\$59.09	\$59.62	\$60.09		See Web
RG178B/U Coax, 50 Ohm							
Part No. <b>PE34492</b>			Cable Dia.	Attn. @ 1 GHz	Power @ 1 GHz	57	
1 piece price shown. See web or call for volume pricing.			0.072" dia.	44.4 dB/100ft	78 W		
12"	24"	36"	48"	60"	72"		Custom Len.
\$67.27	\$73.80	\$69.36	\$70.42	\$71.47	\$72.53		See Web
RG188A/U Coax, 50 Ohm							
Part No. <b>PE3600</b>			Cable Dia.	Attn. @ 1 GHz	Power @ 1 GHz	58	
1 piece price shown. See web or call for volume pricing.			0.11" dia.	26 dB/100ft	160 W		
12"	24"	36"	48"	60"	72"		Custom Len.
\$64.24	\$66.69	\$76.14	\$71.57	\$74.02	\$76.45		See Web
RG188-DS Coax, 50 Ohm							
Part No. <b>PE34499</b>			Cable Dia.	Attn. @ 1 GHz	Power @ 1 GHz	59	
1 piece price shown. See web or call for volume pricing.			0.122" dia.	30 dB/100ft	160 W		
12"	24"	36"	48"	60"	72"		Custom Len.
\$60.73	\$64.37	\$68.00	\$71.62	\$75.26	\$78.82		See Web

RG196A/U Coax, 50 Ohm							
Part No. <b>PE3601</b>			Cable Dia.	Attn. @ 1 GHz	Power @ 1 GHz	60	
1 piece price shown. See web or call for volume pricing.			0.08" dia.	49 dB/100ft	78 W		
12"	24"	36"	48"	60"	72"		Custom Len.
\$62.67	\$64.10	\$65.56	\$67.01	\$68.47	\$69.91		See Web
RG223/U Coax, 50 Ohm							
Part No. <b>PE33664</b>			Cable Dia.	Attn. @ 1 GHz	Power @ 1 GHz	61	
1 piece price shown. See web or call for volume pricing.			0.21" dia.	13.4 dB/100ft	53 W		
12"	24"	36"	48"	60"	72"		Custom Len.
\$65.24	\$68.41	\$71.60	\$74.78	\$77.98	\$81.17		See Web
RG316/U Coax, 50 Ohm							
Part No. <b>PE33363</b>			Cable Dia.	Attn. @ 1 GHz	Power @ 1 GHz	62	
1 piece price shown. See web or call for volume pricing.			0.098" dia.	38 dB/100ft	160 W		
12"	24"	36"	48"	60"	72"		Custom Len.
\$73.16	\$69.70	\$72.88	\$76.06	\$79.22	\$82.39		See Web
RG316-DS Coax, 50 Ohm							
Part No. <b>PE34518</b>			Cable Dia.	Attn. @ 1 GHz	Power @ 1 GHz	63	
1 piece price shown. See web or call for volume pricing.			0.114" dia.	26.1 dB/100ft	160 W		
12"	24"	36"	48"	60"	72"		Custom Len.
\$60.33	\$63.58	\$66.81	\$70.04	\$73.28	\$76.44		See Web
RG400/U Coax, 50 Ohm							
Part No. <b>PE34496</b>			Cable Dia.	Attn. @ 1 GHz	Power @ 1 GHz	64	
1 piece price shown. See web or call for volume pricing.			0.195" dia.	14.7 dB/100ft	650 W		
12"	24"	36"	48"	60"	72"		Custom Len.
\$79.28	\$87.00	\$94.73	\$102.43	\$108.63	\$116.23		See Web

## SMC PLUG TO SMC JACK BULKHEAD

SEE MOUNTING HOLE SECTION ON PAGE 409



### Standard Flexible Cable Assemblies

PE-B100 Coax, 50 Ohm							
Part No. <b>PE34509</b>			Cable Dia.	Attn. @ 1 GHz	Power @ 1 GHz	65	
1 piece price shown. See web or call for volume pricing.			0.101" dia.				
12"	24"	36"	48"	60"	72"		Custom Len.
\$56.46	\$63.96	\$71.55	\$79.09	\$86.61	\$94.19		See Web
RG58C/U Coax, 50 Ohm							
Part No. <b>PE34503</b>			Cable Dia.	Attn. @ 1 GHz	Power @ 1 GHz	66	
1 piece price shown. See web or call for volume pricing.			0.195" dia.	20 dB/100ft	44 W		
12"	24"	36"	48"	60"	72"		Custom Len.
\$73.41	\$74.19	\$75.04	\$75.86	\$76.65	\$77.44		See Web
RG142B/U Coax, 50 Ohm							
Part No. <b>PE34505</b>			Cable Dia.	Attn. @ 1 GHz	Power @ 1 GHz	67	
1 piece price shown. See web or call for volume pricing.			0.195" dia.	13 dB/100ft	650 W		
12"	24"	36"	48"	60"	72"		Custom Len.
\$72.11	\$78.23	\$84.29	\$90.44	\$96.49	\$102.56		See Web
RG174A/U Coax, 50 Ohm							
Part No. <b>PE33580</b>			Cable Dia.	Attn. @ 1 GHz	Power @ 1 GHz	68	
1 piece price shown. See web or call for volume pricing.			0.1" dia.	32 dB/100ft	16 W		
12"	24"	36"	48"	60"	72"		Custom Len.
\$53.84	\$54.33	\$54.30	\$54.78	\$55.26	\$55.73		See Web
RG178B/U Coax, 50 Ohm							
Part No. <b>PE33352</b>			Cable Dia.	Attn. @ 1 GHz	Power @ 1 GHz	69	
1 piece price shown. See web or call for volume pricing.			0.072" dia.	44.4 dB/100ft	78 W		
12"	24"	36"	48"	60"	72"		Custom Len.
\$75.80	\$81.50	\$77.89	\$78.96	\$80.00	\$81.06		See Web
RG188A/U Coax, 50 Ohm							
Part No. <b>PE33686</b>			Cable Dia.	Attn. @ 1 GHz	Power @ 1 GHz	70	
1 piece price shown. See web or call for volume pricing.			0.11" dia.	26 dB/100ft	160 W		
12"	24"	36"	48"	60"	72"		Custom Len.
\$51.70	\$54.12	\$55.93	\$58.29	\$60.61	\$62.99		See Web
RG188-DS Coax, 50 Ohm							
Part No. <b>PE34500</b>			Cable Dia.	Attn. @ 1 GHz	Power @ 1 GHz	71	
1 piece price shown. See web or call for volume pricing.			0.122" dia.	30 dB/100ft	160 W		
12"	24"	36"	48"	60"	72"		Custom Len.
\$52.98	\$56.11	\$59.75	\$63.37	\$66.95	\$70.57		See Web
RG196A/U Coax, 50 Ohm							
Part No. <b>PE33688</b>			Cable Dia.	Attn. @ 1 GHz	Power @ 1 GHz	72	
1 piece price shown. See web or call for volume pricing.			0.08" dia.	49 dB/100ft	78 W		
12"	24"	36"	48"	60"	72"		Custom Len.
\$71.88	\$73.35	\$74.78	\$76.25	\$77.69	\$79.15		See Web
RG223/U Coax, 50 Ohm							
Part No. <b>PE34507</b>			Cable Dia.	Attn. @ 1 GHz	Power @ 1 GHz	73	
1 piece price shown. See web or call for volume pricing.			0.21" dia.	13.4 dB/100ft	53 W		
12"	24"	36"	48"	60"	72"		Custom Len.
\$69.25	\$72.41	\$75.64	\$78.82	\$82.05	\$85.28		See Web
RG316/U Coax, 50 Ohm							
Part No. <b>PE33690</b>			Cable Dia.	Attn. @ 1 GHz	Power @ 1 GHz	74	
1 piece price shown. See web or call for volume pricing.			0.098" dia.	38 dB/100ft	160 W		
12"	24"	36"	48"	60"	72"		Custom Len.
\$56.34	\$55.44	\$58.77	\$62.05	\$65.36	\$68.65		See Web
RG316-DS Coax, 50 Ohm							
Part No. <b>PE34511</b>			Cable Dia.	Attn. @ 1 GHz	Power @ 1 GHz	75	
1 piece price shown. See web or call for volume pricing.			0.114" dia.	30 dB/100ft	160 W		
12"	24"	36"	48"	60"	72"		Custom Len.
\$56.28	\$65.33	\$62.68	\$72.41	\$69.08	\$72.28		See Web

Cable Assemblies

See Our Website For Current Pricing & Real-Time Stock Availability!

For Custom Lengths, Metric Lengths or Special Configurations, Please call (949) 261-1920



Technical Support  
+1 (949) 261-1920



Same-Day Shipping,  
Even Custom Cable Assemblies

For our complete selection of cable assemblies, please visit our website

Cable Assemblies  
See Our Website For Current Pricing & Real-Time Stock Availability!

RG400/U Coax, 50 Ohm						
Part No. <a href="#">PE34498</a>	1 piece price shown. See web or call for volume pricing.			Cable Dia. 0.195" dia.	Attn. @ 1 GHz 14.7 dB/100ft	Power @ 1 GHz 650 W
12"	24"	36"	48"	60"	72"	Custom Len.
\$80.34	\$88.07	\$95.76	\$103.50	\$109.68	\$117.29	See Web
<b>SMC PLUG RIGHT ANGLE TO BNC MALE</b>						
Standard Flexible Cable Assemblies						
RG174A/U Coax, 50 Ohm						
Part No. <a href="#">PE3C1988</a>	1 piece price shown. See web or call for volume pricing.			Cable Dia. 0.11" dia.	Attn. @ 1 GHz 32 dB/100ft	Power @ 1 GHz 17 W
12"	24"	36"	48"	60"	50CM	Custom Len.
\$53.32	\$51.91	\$52.53	\$53.15	\$53.77	\$51.68	See Web
<b>SMC PLUG RIGHT ANGLE TO SMC PLUG RIGHT ANGLE</b>						
Standard Flexible Cable Assemblies						
PE-B100 Coax, 50 Ohm						
Part No. <a href="#">PE34466</a>	1 piece price shown. See web or call for volume pricing.			Cable Dia. 0.101" dia.	Attn. @ 1 GHz 32 dB/100ft	Power @ 1 GHz 16 W
12"	24"	36"	48"	60"	72"	Custom Len.
\$63.11	\$70.64	\$78.23	\$85.76	\$93.34	\$100.87	See Web
RG58C/U Coax, 50 Ohm						
Part No. <a href="#">PE33643</a>	1 piece price shown. See web or call for volume pricing.			Cable Dia. 0.195" dia.	Attn. @ 1 GHz 20 dB/100ft	Power @ 1 GHz 44 W
12"	24"	36"	48"	60"	72"	Custom Len.
\$77.16	\$77.96	\$78.76	\$79.58	\$88.52	\$81.19	See Web
RG142B/U Coax, 50 Ohm						
Part No. <a href="#">PE33645</a>	1 piece price shown. See web or call for volume pricing.			Cable Dia. 0.195" dia.	Attn. @ 1 GHz 13 dB/100ft	Power @ 1 GHz 650 W
12"	24"	36"	48"	60"	72"	Custom Len.
\$69.11	\$75.21	\$81.33	\$87.40	\$93.46	\$99.62	See Web
RG174A/U Coax, 50 Ohm						
Part No. <a href="#">PE3918</a>	1 piece price shown. See web or call for volume pricing.			Cable Dia. 0.1" dia.	Attn. @ 1 GHz 32 dB/100ft	Power @ 1 GHz 16 W
12"	24"	36"	48"	60"	72"	Custom Len.
\$68.93	\$69.41	\$69.89	\$70.37	\$70.83	\$77.69	See Web
RG178B/U Coax, 50 Ohm						
Part No. <a href="#">PE3765</a>	1 piece price shown. See web or call for volume pricing.			Cable Dia. 0.072" dia.	Attn. @ 1 GHz 44.4 dB/100ft	Power @ 1 GHz 78 W
12"	24"	36"	48"	60"	72"	Custom Len.
\$71.46	\$72.62	\$68.27	\$69.34	\$70.40	\$71.45	See Web
RG188A/U Coax, 50 Ohm						
Part No. <a href="#">PE3597</a>	1 piece price shown. See web or call for volume pricing.			Cable Dia. 0.11" dia.	Attn. @ 1 GHz 26 dB/100ft	Power @ 1 GHz 160 W
12"	24"	36"	48"	60"	72"	Custom Len.
\$69.66	\$66.87	\$69.20	\$71.55	\$73.93	\$76.25	See Web
RG188-DS Coax, 50 Ohm						
Part No. <a href="#">PE34464</a>	1 piece price shown. See web or call for volume pricing.			Cable Dia. 0.122" dia.	Attn. @ 1 GHz 30 dB/100ft	Power @ 1 GHz 160 W
12"	24"	36"	48"	60"	72"	Custom Len.
\$65.74	\$69.37	\$73.01	\$76.65	\$80.28	\$83.83	See Web
RG196A/U Coax, 50 Ohm						
Part No. <a href="#">PE3598</a>	1 piece price shown. See web or call for volume pricing.			Cable Dia. 0.08" dia.	Attn. @ 1 GHz 49 dB/100ft	Power @ 1 GHz 78 W
12"	24"	36"	48"	60"	72"	Custom Len.
\$61.65	\$63.11	\$64.56	\$66.01	\$67.45	\$68.92	See Web
RG223/U Coax, 50 Ohm						
Part No. <a href="#">PE33649</a>	1 piece price shown. See web or call for volume pricing.			Cable Dia. 0.21" dia.	Attn. @ 1 GHz 13.4 dB/100ft	Power @ 1 GHz 53 W
12"	24"	36"	48"	60"	72"	Custom Len.
\$66.21	\$69.44	\$72.61	\$75.86	\$79.03	\$82.26	See Web
RG316/U Coax, 50 Ohm						
Part No. <a href="#">PE3919</a>	1 piece price shown. See web or call for volume pricing.			Cable Dia. 0.098" dia.	Attn. @ 1 GHz 38 dB/100ft	Power @ 1 GHz 160 W
12"	24"	36"	48"	60"	72"	Custom Len.
\$72.05	\$75.23	\$78.40	\$81.57	\$84.74	\$87.92	See Web
RG316-DS Coax, 50 Ohm						
Part No. <a href="#">PE34462</a>	1 piece price shown. See web or call for volume pricing.			Cable Dia. 0.114" dia.	Attn. @ 1 GHz 26.1 dB/100ft	Power @ 1 GHz 160 W
12"	24"	36"	48"	60"	72"	Custom Len.
\$65.36	\$68.58	\$71.82	\$75.04	\$78.29	\$81.45	See Web
RG400/U Coax, 50 Ohm						
Part No. <a href="#">PE34459</a>	1 piece price shown. See web or call for volume pricing.			Cable Dia. 0.195" dia.	Attn. @ 1 GHz 14.7 dB/100ft	Power @ 1 GHz 650 W
12"	24"	36"	48"	60"	72"	Custom Len.
\$77.29	\$85.02	\$92.74	\$100.47	\$106.68	\$114.29	See Web

SMC PLUG RIGHT ANGLE TO SMC JACK BULKHEAD						
SEE MOUNTING HOLE SECTION ON PAGE 409						
Standard Flexible Cable Assemblies						
PE-B100 Coax, 50 Ohm						
Part No. <a href="#">PE34486</a>	1 piece price shown. See web or call for volume pricing.			Cable Dia. 0.101" dia.	Attn. @ 1 GHz 32 dB/100ft	Power @ 1 GHz 16 W
12"	24"	36"	48"	60"	72"	Custom Len.
\$61.46	\$68.97	\$76.58	\$84.09	\$91.61	\$99.22	See Web
RG58C/U Coax, 50 Ohm						
Part No. <a href="#">PE34476</a>	1 piece price shown. See web or call for volume pricing.			Cable Dia. 0.195" dia.	Attn. @ 1 GHz 20 dB/100ft	Power @ 1 GHz 44 W
12"	24"	36"	48"	60"	72"	Custom Len.
\$77.69	\$78.49	\$79.34	\$80.14	\$80.93	\$81.72	See Web
RG142B/U Coax, 50 Ohm						
Part No. <a href="#">PE34478</a>	1 piece price shown. See web or call for volume pricing.			Cable Dia. 0.195" dia.	Attn. @ 1 GHz 13 dB/100ft	Power @ 1 GHz 650 W
12"	24"	36"	48"	60"	72"	Custom Len.
\$70.18	\$76.25	\$82.38	\$88.45	\$94.58	\$100.66	See Web
RG174A/U Coax, 50 Ohm						
Part No. <a href="#">PE34078</a>	1 piece price shown. See web or call for volume pricing.			Cable Dia. 0.1" dia.	Attn. @ 1 GHz 32 dB/100ft	Power @ 1 GHz 16 W
12"	24"	36"	48"	60"	72"	Custom Len.
\$61.00	\$61.46	\$62.00	\$62.45	\$62.90	\$63.45	See Web
RG178B/U Coax, 50 Ohm						
Part No. <a href="#">PE34470</a>	1 piece price shown. See web or call for volume pricing.			Cable Dia. 0.072" dia.	Attn. @ 1 GHz 44.4 dB/100ft	Power @ 1 GHz 78 W
12"	24"	36"	48"	60"	72"	Custom Len.
\$77.17	\$78.23	\$79.28	\$80.34	\$81.39	\$82.43	See Web
RG188A/U Coax, 50 Ohm						
Part No. <a href="#">PE3602</a>	1 piece price shown. See web or call for volume pricing.			Cable Dia. 0.11" dia.	Attn. @ 1 GHz 26 dB/100ft	Power @ 1 GHz 160 W
12"	24"	36"	48"	60"	72"	Custom Len.
\$62.85	\$65.23	\$67.55	\$69.91	\$72.22	\$74.61	See Web
RG188-DS Coax, 50 Ohm						
Part No. <a href="#">PE34484</a>	1 piece price shown. See web or call for volume pricing.			Cable Dia. 0.122" dia.	Attn. @ 1 GHz 30 dB/100ft	Power @ 1 GHz 160 W
12"	24"	36"	48"	60"	72"	Custom Len.
\$64.10	\$67.72	\$71.36	\$74.99	\$78.55	\$82.18	See Web
RG196A/U Coax, 50 Ohm						
Part No. <a href="#">PE33692</a>	1 piece price shown. See web or call for volume pricing.			Cable Dia. 0.08" dia.	Attn. @ 1 GHz 49 dB/100ft	Power @ 1 GHz 78 W
12"	24"	36"	48"	60"	72"	Custom Len.
\$77.56	\$79.03	\$80.46	\$81.94	\$83.38	\$84.83	See Web
RG223/U Coax, 50 Ohm						
Part No. <a href="#">PE34480</a>	1 piece price shown. See web or call for volume pricing.			Cable Dia. 0.21" dia.	Attn. @ 1 GHz 13.4 dB/100ft	Power @ 1 GHz 53 W
12"	24"	36"	48"	60"	72"	Custom Len.
\$67.29	\$70.51	\$73.68	\$76.90	\$80.14	\$83.29	See Web
RG316/U Coax, 50 Ohm						
Part No. <a href="#">PE34472</a>	1 piece price shown. See web or call for volume pricing.			Cable Dia. 0.098" dia.	Attn. @ 1 GHz 38 dB/100ft	Power @ 1 GHz 160 W
12"	24"	36"	48"	60"	72"	Custom Len.
\$63.78	\$67.06	\$70.38	\$73.68	\$76.99	\$80.28	See Web
RG316-DS Coax, 50 Ohm						
Part No. <a href="#">PE34474</a>	1 piece price shown. See web or call for volume pricing.			Cable Dia. 0.114" dia.	Attn. @ 1 GHz 26.1 dB/100ft	Power @ 1 GHz 160 W
12"	24"	36"	48"	60"	72"	Custom Len.
\$63.69	\$66.95	\$70.18	\$73.41	\$76.58	\$79.80	See Web
RG400/U Coax, 50 Ohm						
Part No. <a href="#">PE34482</a>	1 piece price shown. See web or call for volume pricing.			Cable Dia. 0.195" dia.	Attn. @ 1 GHz 14.7 dB/100ft	Power @ 1 GHz 650 W
12"	24"	36"	48"	60"	72"	Custom Len.
\$85.02	\$92.74	\$100.47	\$106.68	\$114.29	\$121.90	See Web
<b>SMC PLUG RIGHT ANGLE TO TNC FEMALE BULKHEAD</b>						
SEE MOUNTING HOLE SECTION ON PAGE 409						
Standard Flexible Cable Assemblies						
RG178B/U Coax, 50 Ohm						
Part No. <a href="#">PE3W05426</a>	1 piece price shown. See web or call for volume pricing.			Cable Dia. 0.072" dia.	Attn. @ 1 GHz 44.4 dB/100ft	Power @ 1 GHz 55 W
12"	24"	36"	48"	60"	50CM	Custom Len.
\$63.64	\$64.87	\$66.12	\$67.36	\$68.61	\$64.43	See Web
<b>SMC JACK BULKHEAD TO UM CX PLUG RIGHT ANGLE</b>						
SEE MOUNTING HOLE SECTION ON PAGE 409						
Standard Flexible Cable Assemblies						

\*Coax Performance at 1 GHz Notes: Cable assembly max frequency may be lower than connector or coax max frequency



For our complete selection of cable assemblies, please visit our website

RG178B/U Coax, 50 Ohm						
Part No. <a href="#">PE39035</a>	Cable Dia.			Attn. @ 1 GHz	Power @ 1 GHz	
1 piece price shown. See web or call for volume pricing.	0.072" dia.			44.4 dB/100ft	78 W	
3"	6"	9"	12"	18"	24"	Custom Len.
\$82.15	\$82.15	\$82.15	\$82.15	\$82.68	\$83.22	See Web

**SMP MALE BULKHEAD TO SMA MALE**

SEE MOUNTING HOLE SECTION ON PAGE 409

**Standard Formable Cable Assemblies**

PE-SR405FLJ Coax, 50 Ohm						
Part No. <a href="#">PE3W05498</a>	Cable Dia.			Attn. @ 1 GHz	Power @ 1 GHz	
1 piece price shown. See web or call for volume pricing.	0.105" dia.			19.5 dB/100ft	121.5 W	
12"	24"	36"	48"	60"	50CM	Custom Len.
\$82.86	\$92.69	\$102.54	\$110.83	\$120.54	\$89.16	See Web

**SMP MALE BULKHEAD TO SMP FEMALE RIGHT ANGLE**

SEE MOUNTING HOLE SECTION ON PAGE 409

**Standard Formable Cable Assemblies**

PE-SR405FLJ Coax, 50 Ohm						
Part No. <a href="#">PE3C7572</a>	Cable Dia.			Attn. @ 1 GHz	Power @ 1 GHz	
1 piece price shown. See web or call for volume pricing.	0.105" dia.			19.5 dB/100ft	121.5 W	
12"	24"	36"	48"	60"	50CM	Custom Len.
\$113.03	\$122.75	\$132.46	\$142.18	\$151.90	\$119.25	See Web

**SMP FEMALE TO SMA MALE**

**Semi-Rigid Cable Assemblies**

PE-047SR Coax, 50 Ohm						
Part No. <a href="#">PE36162</a>	Cable Dia.			Attn. @ 1 GHz	Power @ 1 GHz	
1 piece price shown. See web or call for volume pricing.	0.105" dia.			40 dB/100ft	32 W	
12"	24"	36"	48"	60"	72"	Custom Len.
\$100.94	\$111.53	\$122.94	\$134.04	\$148.46	\$160.68	See Web

**Standard Formable Cable Assemblies**

PE-SR405FL Coax, 50 Ohm						
Part No. <a href="#">PE36168</a>	Cable Dia.			Attn. @ 1 GHz	Power @ 1 GHz	
1 piece price shown. See web or call for volume pricing.	0.105" dia.			22.5 dB/100ft	105 W	
12"	24"	36"	48"	60"	72"	Custom Len.
\$91.59	\$104.06	\$114.92	\$121.63	\$140.47	\$144.82	See Web

PE-SR405FL Coax, 50 Ohm						
Part No. <a href="#">PE3W07044</a>	Cable Dia.			Attn. @ 1 GHz	Power @ 1 GHz	
1 piece price shown. See web or call for volume pricing.	0.105" dia.			22.5 dB/100ft	105 W	
12"	24"	36"	48"	60"	50CM	Custom Len.
\$55.41	\$68.25	\$81.09	\$93.93	\$106.76	\$63.64	See Web

**SMP FEMALE TO SMP FEMALE**

**Standard Formable Cable Assemblies**

PE-SR047FL Coax, 50 Ohm						
Part No. <a href="#">PE36148</a>	Cable Dia.			Attn. @ 1 GHz	Power @ 1 GHz	
1 piece price shown. See web or call for volume pricing.	0.047" dia.			36 dB/100ft	32 W	
12"	24"	36"	48"	60"	72"	Custom Len.
\$106.87	\$108.81	\$116.78	\$124.79	\$132.79	\$140.77	See Web

PE-SR405FL Coax, 50 Ohm						
Part No. <a href="#">PE36152</a>	Cable Dia.			Attn. @ 1 GHz	Power @ 1 GHz	
1 piece price shown. See web or call for volume pricing.	0.105" dia.			22.5 dB/100ft	130 W	
12"	24"	36"	48"	60"	72"	Custom Len.
\$82.70	\$95.17	\$100.78	\$110.64	\$121.90	\$133.17	See Web

PE-SR405FL Coax, 50 Ohm						
Part No. <a href="#">PE3C4341</a>	Cable Dia.			Attn. @ 1 GHz	Power @ 1 GHz	
1 piece price shown. See web or call for volume pricing.	0.105" dia.			22.5 dB/100ft	105 W	
12"	24"	36"	48"	60"	50CM	Custom Len.
\$69.01	\$81.84	\$94.68	\$107.53	\$118.70	\$77.24	See Web

**Standard Flexible Cable Assemblies**

PE-P047 Coax, 50 Ohm						
Part No. <a href="#">PE3C0757</a>	Cable Dia.			Attn. @ 1 GHz	Power @ 1 GHz	
1 piece price shown. See web or call for volume pricing.	0.056" dia.			35 dB/100ft	43 W	
12"	24"	36"	48"	60"	50CM	Custom Len.
\$73.64	\$79.35	\$87.90	\$96.44	\$104.98	\$76.27	See Web

**Standard Semi-Rigid Cable Assemblies**

PE-047SR Coax, 50 Ohm						
Part No. <a href="#">PE36146</a>	Cable Dia.			Attn. @ 1 GHz	Power @ 1 GHz	
1 piece price shown. See web or call for volume pricing.	0.105" dia.			40 dB/100ft	32 W	
12"	24"	36"	48"	60"	72"	Custom Len.
\$110.21	\$122.20	\$126.18	\$137.26	\$148.37	\$159.46	See Web

RG405/U Coax, 50 Ohm						
Part No. <a href="#">PE36150</a>	Cable Dia.			Attn. @ 1 GHz	Power @ 1 GHz	
1 piece price shown. See web or call for volume pricing.	0.105" dia.			22 dB/100ft	130 W	
12"	24"	36"	48"	60"	72"	Custom Len.
\$115.48	\$123.54	\$88.52	\$130.56	\$103.16	\$108.94	See Web

**SMP FEMALE TO SMP FEMALE RIGHT ANGLE**

**Standard Formable Cable Assemblies**

PE-SR047FL Coax, 50 Ohm						
Part No. <a href="#">PE36156</a>	Cable Dia.			Attn. @ 1 GHz	Power @ 1 GHz	
1 piece price shown. See web or call for volume pricing.	0.047" dia.			36 dB/100ft	32 W	
12"	24"	36"	48"	60"	72"	Custom Len.
\$101.37	\$107.72	\$115.47	\$123.20	\$130.95	\$138.69	See Web

PE-SR405FL Coax, 50 Ohm						
Part No. <a href="#">PE36160</a>	Cable Dia.			Attn. @ 1 GHz	Power @ 1 GHz	
1 piece price shown. See web or call for volume pricing.	0.105" dia.			22.5 dB/100ft	130 W	
12"	24"	36"	48"	60"	72"	Custom Len.
\$95.38	\$107.13	\$124.28	\$128.82	\$140.43	\$152.01	See Web

PE-SR405FLJ Coax, 50 Ohm						
Part No. <a href="#">PE3C0438</a>	Cable Dia.			Attn. @ 1 GHz	Power @ 1 GHz	
1 piece price shown. See web or call for volume pricing.	0.098" dia.			19.5 dB/100ft	130 W	
6"	9"	12"	18"	24"	-	Custom Len.
\$88.89	\$91.95	\$94.23	\$93.15	\$103.62	-	See Web

**Standard Semi-Rigid Cable Assemblies**

PE-047SR Coax, 50 Ohm						
Part No. <a href="#">PE36154</a>	Cable Dia.			Attn. @ 1 GHz	Power @ 1 GHz	
1 piece price shown. See web or call for volume pricing.	0.105" dia.			40 dB/100ft	32 W	
12"	24"	36"	48"	60"	72"	Custom Len.
\$104.49	\$121.22	\$124.50	\$135.30	\$146.05	\$156.85	See Web

RG405/U Coax, 50 Ohm						
Part No. <a href="#">PE36158</a>	Cable Dia.			Attn. @ 1 GHz	Power @ 1 GHz	
1 piece price shown. See web or call for volume pricing.	0.105" dia.			22 dB/100ft	130 W	
12"	24"	36"	48"	60"	72"	Custom Len.
\$91.04	\$98.59	\$106.13	\$112.12	\$119.55	\$127.01	See Web

**SMP FEMALE RIGHT ANGLE TO BNC MALE**

**Standard Flexible Cable Assemblies**

RG174A/U Coax, 50 Ohm						
Part No. <a href="#">PE3W06234</a>	Cable Dia.			Attn. @ 1 GHz	Power @ 1 GHz	
1 piece price shown. See web or call for volume pricing.	0.11" dia.			32 dB/100ft	17 W	
12"	18"	24"	36"	48"	60"	Custom Len.
\$45.49	\$44.08	\$44.38	\$44.98	\$45.58	\$46.18	See Web

**SMP FEMALE RIGHT ANGLE TO MMCX PLUG RIGHT ANGLE**

**Standard Formable Cable Assemblies**

PE-SR405FLJ Coax, 50 Ohm						
Part No. <a href="#">PE3C3221</a>	Cable Dia.			Attn. @ 1 GHz	Power @ 1 GHz	
1 piece price shown. See web or call for volume pricing.	0.098" dia.			19.5 dB/100ft	130 W	
12"	50CM	24"	36"	48"	60"	Custom Len.
\$78.89	\$80.27	\$83.54	\$92.66	\$95.22	\$101.77	See Web

**SMP FEMALE RIGHT ANGLE TO N FEMALE BULKHEAD**

SEE MOUNTING HOLE SECTION ON PAGE 409

**Flexible Cable Assemblies**

LMR-100A-PVC Coax, 50 Ohm						
Part No. <a href="#">PE3W05673</a>	Cable Dia.			Attn. @ 1 GHz	Power @ 1 GHz	
1 piece price shown. See web or call for volume pricing.	0.11" dia.			24 dB/100ft	130 W	
12"	24"	36"	48"	60"	50CM	Custom Len.
\$58.77	\$59.55	\$60.34	\$61.15	\$61.94	\$59.26	See Web

**SMP FEMALE RIGHT ANGLE TO SMA MALE RIGHT ANGLE**

**Standard Flexible Cable Assemblies**

RG316/U Coax, 50 Ohm						
Part No. <a href="#">PE3W05056</a>	Cable Dia.			Attn. @ 1 GHz	Power @ 1 GHz	
1 piece price shown. See web or call for volume pricing.	0.102" dia.			38 dB/100ft	105 W	
12"	24"	36"	48"	60"	50CM	Custom Len.
\$63.07	\$66.67	\$70.28	\$73.88	\$77.49	\$65.38	See Web

**SMP FEMALE RIGHT ANGLE TO SMA FEMALE**

**Standard Formable Cable Assemblies**

PE-SR405FL Coax, 50 Ohm						
Part No. <a href="#">PE3W05740</a>	Cable Dia.			Attn. @ 1 GHz	Power @ 1 GHz	
1 piece price shown. See web or call for volume pricing.	0.105" dia.			22.5 dB/100ft	105 W	
12"	24"	36"	48"	60"	50CM	Custom Len.
\$77.08	\$89.93	\$102.77	\$114.00	\$126.65	\$85.30	See Web

For Custom Lengths, Metric Lengths or Special Configurations, Please call (949) 261-1920



Technical Support  
+1 (949) 261-1920



Same-Day Shipping,  
Even Custom Cable Assemblies

Cable Assemblies

See Our Website For Current Pricing & Real-Time Stock Availability!



For our complete selection of cable assemblies, please visit our website

**SMP FEMALE RIGHT ANGLE TO SMA FEMALE 2 HOLE FLANGE**

SEE MOUNTING HOLE SECTION ON PAGE 409

**Standard Semi-Rigid Cable Assemblies**

**PE-047SR Coax, 50 Ohm**

Part No. <a href="#">PE3W05692</a>	Cable Dia.	Attn. @ 1 GHz	Power @ 1 GHz
1 piece price shown. See web or call for volume pricing.			
12"	18"	24"	36"
\$119.91	\$121.02	\$126.63	\$137.84
48"	60"	Custom Len.	See Web
\$149.05	\$160.27		

**SMP FEMALE RIGHT ANGLE TO SMP FEMALE**

**Standard Formable Cable Assemblies**

**PE-SR405FL Coax, 50 Ohm**

Part No. <a href="#">PE3W03777</a>	Cable Dia.	Attn. @ 1 GHz	Power @ 1 GHz
1 piece price shown. See web or call for volume pricing.			
12"	24"	36"	48"
\$84.10	\$96.95	\$108.26	\$120.93
60"	50CM	Custom Len.	See Web
\$133.58	\$92.33		

**SMP FEMALE RIGHT ANGLE TO SMP FEMALE RIGHT ANGLE**

**Standard Flexible Cable Assemblies**

**PE-P047 Coax, 50 Ohm**

Part No. <a href="#">PE3C4969</a>	Cable Dia.	Attn. @ 1 GHz	Power @ 1 GHz
1 piece price shown. See web or call for volume pricing.			
12"	50CM	24"	36"
\$111.74	\$112.53	\$115.55	\$123.97
100CM	48"	Custom Len.	See Web
\$126.34	\$132.40		

**Standard Semi-Rigid Cable Assemblies**

**PE-047SR Coax, 50 Ohm**

Part No. <a href="#">PE3W04802</a>	Cable Dia.	Attn. @ 1 GHz	Power @ 1 GHz
1 piece price shown. See web or call for volume pricing.			
12"	24"	36"	48"
\$63.45	\$75.27	\$87.07	\$98.89
60"	50CM	Custom Len.	See Web
\$109.17	\$71.01		

**SMP FEMALE RIGHT ANGLE TO REVERSE POLARITY TNC FEMALE BULKHEAD**

SEE MOUNTING HOLE SECTION ON PAGE 409

**Flexible Cable Assemblies**

**LMR-100A-PVC Coax, 50 Ohm**

Part No. <a href="#">PE3W05481</a>	Cable Dia.	Attn. @ 1 GHz	Power @ 1 GHz
1 piece price shown. See web or call for volume pricing.			
12"	24"	36"	48"
\$91.19	\$91.98	\$92.78	\$93.58
60"	50CM	Custom Len.	See Web
\$94.38	\$91.70		

**SSMA MALE TO SSMA MALE**

**Standard Flexible Cable Assemblies**

**RG174A/U Coax, 50 Ohm**

Part No. <a href="#">PE3673</a>	Cable Dia.	Attn. @ 1 GHz	Power @ 1 GHz
1 piece price shown. See web or call for volume pricing.			
6"	12"	18"	24"
\$70.51	\$70.69	\$70.97	\$71.23
36"	48"	Custom Len.	See Web
\$71.71	\$72.22		

**RG178B/U Coax, 50 Ohm**

Part No. <a href="#">PE33762</a>	Cable Dia.	Attn. @ 1 GHz	Power @ 1 GHz
1 piece price shown. See web or call for volume pricing.			
6"	12"	18"	24"
\$80.76	\$80.76	\$81.29	\$86.76
36"	48"	Custom Len.	See Web
\$82.87	\$89.15		

**RG188A/U Coax, 50 Ohm**

Part No. <a href="#">PE33700</a>	Cable Dia.	Attn. @ 1 GHz	Power @ 1 GHz
1 piece price shown. See web or call for volume pricing.			
12"	24"	36"	48"
\$67.72	\$69.98	\$72.22	\$74.45
60"	-	Custom Len.	See Web
\$76.65	-		

**RG316/U Coax, 50 Ohm**

Part No. <a href="#">PE33071</a>	Cable Dia.	Attn. @ 1 GHz	Power @ 1 GHz
1 piece price shown. See web or call for volume pricing.			
6"	12"	18"	24"
\$79.43	\$79.43	\$81.00	\$82.59
36"	48"	Custom Len.	See Web
\$85.77	\$88.94		

**SSMA MALE TO SSMA MALE RIGHT ANGLE**

**Standard Flexible Cable Assemblies**

**RG174A/U Coax, 50 Ohm**

Part No. <a href="#">PE36569</a>	Cable Dia.	Attn. @ 1 GHz	Power @ 1 GHz
1 piece price shown. See web or call for volume pricing.			
6"	12"	18"	24"
\$74.51	\$82.27	\$75.04	\$75.26
36"	48"	Custom Len.	See Web
\$75.79	\$76.25		

**RG178B/U Coax, 50 Ohm**

Part No. <a href="#">PE36571</a>	Cable Dia.	Attn. @ 1 GHz	Power @ 1 GHz
1 piece price shown. See web or call for volume pricing.			
6"	12"	18"	24"
\$105.81	\$106.34	\$106.85	\$107.39
36"	48"	Custom Len.	See Web
\$106.93	\$108.00		

**RG316/U Coax, 50 Ohm**

Part No. <a href="#">PE36573</a>	Cable Dia.	Attn. @ 1 GHz	Power @ 1 GHz
1 piece price shown. See web or call for volume pricing.			
6"	12"	18"	24"
\$80.54	\$77.56	\$79.20	\$80.86
36"	48"	Custom Len.	See Web
\$84.16	\$87.46		

**SSMA MALE RIGHT ANGLE TO SSMA MALE RIGHT ANGLE**

**Standard Flexible Cable Assemblies**

**RG174A/U Coax, 50 Ohm**

Part No. <a href="#">PE36570</a>	Cable Dia.	Attn. @ 1 GHz	Power @ 1 GHz
1 piece price shown. See web or call for volume pricing.			
6"	12"	18"	24"
\$78.62	\$78.82	\$79.09	\$79.34
36"	48"	Custom Len.	See Web
\$79.80	\$80.28		

**RG178B/U Coax, 50 Ohm**

Part No. <a href="#">PE36572</a>	Cable Dia.	Attn. @ 1 GHz	Power @ 1 GHz
1 piece price shown. See web or call for volume pricing.			
6"	12"	18"	24"
\$134.07	\$134.59	\$135.13	\$135.64
36"	48"	Custom Len.	See Web
\$136.66	\$137.72		

**RG316/U Coax, 50 Ohm**

Part No. <a href="#">PE36574</a>	Cable Dia.	Attn. @ 1 GHz	Power @ 1 GHz
1 piece price shown. See web or call for volume pricing.			
6"	12"	18"	24"
\$80.01	\$81.66	\$83.29	\$84.96
36"	48"	Custom Len.	See Web
\$88.25	\$91.55		

**RG316-DS Coax, 50 Ohm**

Part No. <a href="#">PE38407</a>	Cable Dia.	Attn. @ 1 GHz	Power @ 1 GHz
1 piece price shown. See web or call for volume pricing.			
12"	24"	36"	48"
\$76.25	\$79.28	\$82.26	\$85.22
60"	-	Custom Len.	See Web
\$88.25	-		

**SSMB PLUG TO SMA MALE**

**Flexible Cable Assemblies**

**LMR-100A-PVC Coax, 50 Ohm**

Part No. <a href="#">PE3W05115</a>	Cable Dia.	Attn. @ 1 GHz	Power @ 1 GHz
1 piece price shown. See web or call for volume pricing.			
12"	24"	36"	48"
Call	Call	Call	Call
60"	50CM	Custom Len.	See Web
Call	Call		

**Standard Flexible Cable Assemblies**

**RG188-DS Coax, 50 Ohm**

Part No. <a href="#">PE3W06018</a>	Cable Dia.	Attn. @ 1 GHz	Power @ 1 GHz
1 piece price shown. See web or call for volume pricing.			
12"	24"	36"	48"
\$56.07	\$60.14	\$64.21	\$68.27
60"	50CM	Custom Len.	See Web
\$72.34	\$58.68		

Part No. <a href="#">PE3W06717</a>	Cable Dia.	Attn. @ 1 GHz	Power @ 1 GHz
1 piece price shown. See web or call for volume pricing.			
12"	24"	36"	48"
\$87.00	\$91.07	\$95.13	\$99.20
60"	50CM	Custom Len.	See Web
\$103.16	\$89.60		

**SSMB PLUG TO SSMB PLUG**

**Standard Flexible Cable Assemblies**

**RG188-DS Coax, 50 Ohm**

Part No. <a href="#">PE3W06017</a>	Cable Dia.	Attn. @ 1 GHz	Power @ 1 GHz
1 piece price shown. See web or call for volume pricing.			
12"	24"	36"	48"
\$79.71	\$83.78	\$87.84	\$91.91
60"	50CM	Custom Len.	See Web
\$95.98	\$82.31		

**RG196A/U Coax, 50 Ohm**

Part No. <a href="#">PE3122</a>	Cable Dia.	Attn. @ 1 GHz	Power @ 1 GHz
1 piece price shown. See web or call for volume pricing.			
12"	24"	36"	48"
\$83.65	\$91.90	\$86.65	\$88.18
60"	72"	Custom Len.	See Web
\$89.68	\$91.18		

**RG316/U Coax, 50 Ohm**

Part No. <a href="#">PE3139</a>	Cable Dia.	Attn. @ 1 GHz	Power @ 1 GHz
1 piece price shown. See web or call for volume pricing.			
12"	24"	36"	48"
\$96.49	\$99.93	\$95.70	\$98.88
60"	72"	Custom Len.	See Web
\$102.05	\$105.23		

**SSMB PLUG RIGHT ANGLE TO SSMB PLUG RIGHT ANGLE**

**Standard Flexible Cable Assemblies**

Cable Assemblies

See Our Website For Current Pricing & Real-Time Stock Availability!

\*Coax Performance at 1 GHz Notes: Cable assembly max frequency may be lower than connector or coax max frequency

For our complete selection of cable assemblies, please visit our website

RG178B/U Coax, 50 Ohm						
Part No. <a href="#">PE3C4801</a>	Cable Dia.			Attn. @ 1 GHz	Power @ 1 GHz	
1 piece price shown. See web or call for volume pricing.	0.072" dia.			44.41 dB/100ft	55 W	
12"	24"	36"	48"	60"	50CM	Custom Len.
\$61.22	\$60.00	\$61.13	\$62.26	\$63.38	\$59.58	See Web

RG196A/U Coax, 50 Ohm						
Part No. <a href="#">PE3134</a>	Cable Dia.			Attn. @ 1 GHz	Power @ 1 GHz	
1 piece price shown. See web or call for volume pricing.	0.08" dia.			49 dB/100ft	78 W	
12"	24"	36"	48"	60"	72"	Custom Len.
\$71.38	\$72.90	\$74.40	\$75.91	\$77.42	\$78.92	See Web

RG316/U Coax, 50 Ohm						
Part No. <a href="#">PE3157</a>	Cable Dia.			Attn. @ 1 GHz	Power @ 1 GHz	
1 piece price shown. See web or call for volume pricing.	0.102" dia.			38 dB/100ft	78 W	
12"	24"	36"	48"	60"	72"	Custom Len.
\$93.77	\$97.20	\$94.82	\$97.97	\$107.78	\$104.33	See Web

**SSMC PLUG TO SMB JACK BULKHEAD**

SEE MOUNTING HOLE SECTION ON PAGE 409

**Standard Flexible Cable Assemblies**

RG178B/U Coax, 50 Ohm						
Part No. <a href="#">PE3W08023</a>	Cable Dia.			Attn. @ 1 GHz	Power @ 1 GHz	
1 piece price shown. See web or call for volume pricing.	0.072" dia.			44.41 dB/100ft	55 W	
12"	18"	24"	36"	48"	60"	Custom Len.
\$70.14	\$68.11	\$68.71	\$69.91	\$71.11	\$72.31	See Web

**SSMC PLUG TO SSMC PLUG**

**Low Loss Flexible Cable Assemblies**

**LMR-100A-PVC Coax, 50 Ohm**

Part No. <a href="#">PE3C4419</a>	Cable Dia.			Attn. @ 1 GHz	Power @ 1 GHz	
1 piece price shown. See web or call for volume pricing.	0.11" dia.			24 dB/100ft	55 W	
6"	12"	18"	24"	36"	48"	Custom Len.
\$71.31	\$78.91	\$72.14	\$72.54	\$73.35	\$74.16	See Web

**Standard Formable Cable Assemblies**

**PE-SR405FLJ Coax, 50 Ohm**

Part No. <a href="#">PE3C4441</a>	Cable Dia.			Attn. @ 1 GHz	Power @ 1 GHz	
1 piece price shown. See web or call for volume pricing.	0.105" dia.			19.5 dB/100ft	121.5 W	
6"	12"	18"	24"	36"	48"	Custom Len.
\$78.77	\$82.92	\$87.06	\$91.19	\$99.46	\$107.75	See Web

**Standard Flexible Cable Assemblies**

**RG178B/U Coax, 50 Ohm**

Part No. <a href="#">PE3C4388</a>	Cable Dia.			Attn. @ 1 GHz	Power @ 1 GHz	
1 piece price shown. See web or call for volume pricing.	0.072" dia.			44.41 dB/100ft	55 W	
6"	12"	18"	24"	36"	48"	Custom Len.
\$86.64	\$87.21	\$87.79	\$83.28	\$84.32	\$85.34	See Web

**RG316/U Coax, 50 Ohm**

Part No. <a href="#">PE3C4403</a>	Cable Dia.			Attn. @ 1 GHz	Power @ 1 GHz	
1 piece price shown. See web or call for volume pricing.	0.098" dia.			38 dB/100ft	160 W	
6"	12"	18"	24"	36"	48"	Custom Len.
\$77.71	\$79.26	\$80.81	\$82.32	\$85.42	\$88.49	See Web

**SSMC PLUG TO SSMC PLUG RIGHT ANGLE**

**Low Loss Flexible Cable Assemblies**

**LMR-100A-PVC Coax, 50 Ohm**

Part No. <a href="#">PE3C4420</a>	Cable Dia.			Attn. @ 1 GHz	Power @ 1 GHz	
1 piece price shown. See web or call for volume pricing.	0.11" dia.			24 dB/100ft	55 W	
6"	12"	18"	24"	36"	48"	Custom Len.
\$67.55	\$67.96	\$68.36	\$68.77	\$69.58	\$70.39	See Web

**Standard Formable Cable Assemblies**

**PE-SR405FLJ Coax, 50 Ohm**

Part No. <a href="#">PE3C4481</a>	Cable Dia.			Attn. @ 1 GHz	Power @ 1 GHz	
1 piece price shown. See web or call for volume pricing.	0.105" dia.			19.5 dB/100ft	121.5 W	
6"	12"	18"	24"	36"	48"	Custom Len.
\$75.37	\$79.51	\$83.66	\$87.79	\$96.06	\$104.33	See Web

**Standard Flexible Cable Assemblies**

**RG178B/U Coax, 50 Ohm**

Part No. <a href="#">PE3C4455</a>	Cable Dia.			Attn. @ 1 GHz	Power @ 1 GHz	
1 piece price shown. See web or call for volume pricing.	0.072" dia.			44.41 dB/100ft	55 W	
6"	12"	18"	24"	36"	48"	Custom Len.
\$72.48	\$73.01	\$73.53	\$74.05	\$75.05	\$76.09	See Web

**RG316/U Coax, 50 Ohm**

Part No. <a href="#">PE3C4404</a>	Cable Dia.			Attn. @ 1 GHz	Power @ 1 GHz	
1 piece price shown. See web or call for volume pricing.	0.098" dia.			38 dB/100ft	160 W	
6"	12"	18"	24"	36"	48"	Custom Len.
\$73.93	\$80.01	\$77.03	\$78.55	\$81.65	\$84.71	See Web

**SSMC PLUG TO SSMC JACK BULKHEAD**

SEE MOUNTING HOLE SECTION ON PAGE 409

**Standard Formable Cable Assemblies**

**PE-SR405FLJ Coax, 50 Ohm**

Part No. <a href="#">PE3C4442</a>	Cable Dia.			Attn. @ 1 GHz	Power @ 1 GHz	
1 piece price shown. See web or call for volume pricing.	0.105" dia.			19.5 dB/100ft	121.5 W	
6"	12"	18"	24"	36"	48"	Custom Len.
\$78.41	\$82.97	\$79.57	\$83.70	\$91.97	\$96.68	See Web

**Standard Flexible Cable Assemblies**

**RG178B/U Coax, 50 Ohm**

Part No. <a href="#">PE3C4389</a>	Cable Dia.			Attn. @ 1 GHz	Power @ 1 GHz	
1 piece price shown. See web or call for volume pricing.	0.072" dia.			44.41 dB/100ft	55 W	
6"	12"	18"	24"	36"	48"	Custom Len.
\$77.37	\$85.68	\$78.41	\$78.92	\$79.95	\$89.26	See Web

**SSMC PLUG TO SSMC JACK RIGHT ANGLE BULKHEAD**

SEE MOUNTING HOLE SECTION ON PAGE 409

**Standard Flexible Cable Assemblies**

**RG178B/U Coax, 50 Ohm**

Part No. <a href="#">PE3C4459</a>	Cable Dia.			Attn. @ 1 GHz	Power @ 1 GHz	
1 piece price shown. See web or call for volume pricing.	0.072" dia.			44.41 dB/100ft	55 W	
6"	12"	18"	24"	36"	48"	Custom Len.
\$74.69	\$75.22	\$75.71	\$76.22	\$77.26	\$78.28	See Web

**SSMC PLUG TO TNC MALE**

**Low Loss Flexible Cable Assemblies**

**LMR-100A-PVC Coax, 50 Ohm**

Part No. <a href="#">PE3C4434</a>	Cable Dia.			Attn. @ 1 GHz	Power @ 1 GHz	
1 piece price shown. See web or call for volume pricing.	0.11" dia.			24 dB/100ft	55 W	
6"	12"	18"	24"	36"	48"	Custom Len.
\$59.56	\$59.98	\$60.37	\$60.78	\$61.59	\$62.41	See Web

**Standard Formable Cable Assemblies**

**PE-SR405FLJ Coax, 50 Ohm**

Part No. <a href="#">PE3C4453</a>	Cable Dia.			Attn. @ 1 GHz	Power @ 1 GHz	
1 piece price shown. See web or call for volume pricing.	0.105" dia.			19.5 dB/100ft	121.5 W	
6"	12"	18"	24"	36"	48"	Custom Len.
\$65.82	\$69.96	\$74.10	\$78.23	\$86.50	\$94.79	See Web

**Standard Flexible Cable Assemblies**

**RG178B/U Coax, 50 Ohm**

Part No. <a href="#">PE3C4401</a>	Cable Dia.			Attn. @ 1 GHz	Power @ 1 GHz	
1 piece price shown. See web or call for volume pricing.	0.072" dia.			44.41 dB/100ft	55 W	
6"	12"	18"	24"	36"	48"	Custom Len.
\$71.52	\$72.04	\$72.55	\$73.06	\$74.09	\$75.10	See Web

**RG316/U Coax, 50 Ohm**

Part No. <a href="#">PE3C4417</a>	Cable Dia.			Attn. @ 1 GHz	Power @ 1 GHz	
1 piece price shown. See web or call for volume pricing.	0.098" dia.			58 dB/100ft	160 W	
6"	12"	18"	24"	36"	48"	Custom Len.
\$71.20	\$72.74	\$74.30	\$75.82	\$78.91	\$81.99	See Web

**SSMC PLUG RIGHT ANGLE TO SMA MALE**

**Standard Flexible Cable Assemblies**

**RG188-DS Coax, 50 Ohm**

Part No. <a href="#">PE3W04994</a>	Cable Dia.			Attn. @ 1 GHz	Power @ 1 GHz	
1 piece price shown. See web or call for volume pricing.	0.118" dia.			30 dB/100ft	160 W	
12"	24"	36"	48"	60"	50CM	Custom Len.
\$64.29	\$68.34	\$72.41	\$76.48	\$80.54	\$66.89	See Web

**SSMC PLUG RIGHT ANGLE TO SSMC PLUG RIGHT ANGLE**

**Low Loss Flexible Cable Assemblies**

**LMR-100A-PVC Coax, 50 Ohm**

Part No. <a href="#">PE3C4421</a>	Cable Dia.			Attn. @ 1 GHz	Power @ 1 GHz	
1 piece price shown. See web or call for volume pricing.	0.11" dia.			24 dB/100ft	55 W	
6"	12"	18"	24"	36"	48"	Custom Len.
\$63.77	\$64.19	\$64.58	\$65.00	\$65.81	\$66.61	See Web

**Standard Formable Cable Assemblies**

**PE-SR405FLJ Coax, 50 Ohm**

Part No. <a href="#">PE3C4482</a>	Cable Dia.			Attn. @ 1 GHz	Power @ 1 GHz	
1 piece price shown. See web or call for volume pricing.	0.105" dia.			19.5 dB/100ft	121.5 W	
6"	12"	18"	24"	36"	48"	Custom Len.
\$71.97	\$76.11	\$80.26	\$84.39	\$92.65	\$100.94	See Web

Cable Assemblies

See Our Website For Current Pricing & Real-Time Stock Availability!

For Custom Lengths, Metric Lengths or Special Configurations, Please call (949) 261-1920



Technical Support  
+1 (949) 261-1920



Same-Day Shipping,  
Even Custom Cable Assemblies

For our complete selection of cable assemblies, please visit our website

Cable Assemblies

See Our Website For Current Pricing & Real-Time Stock Availability!

Standard Flexible Cable Assemblies						
RG178B/U Coax, 50 Ohm						
Part No.	PE3C4457			Cable Dia.	Attn. @ 1 GHz	Power @ 1 GHz
1 piece price shown. See web or call for volume pricing.						
6"	12"	18"	24"	0.072" dia.	44.41 dB/100ft	55 W
\$63.25	\$63.77	\$64.28	\$64.79	36"	48"	Custom Len.
				\$65.82	\$66.84	See Web
RG316/U Coax, 50 Ohm						
Part No.	PE3C4374			Cable Dia.	Attn. @ 1 GHz	Power @ 1 GHz
1 piece price shown. See web or call for volume pricing.						
6"	12"	18"	24"	0.098" dia.	38 dB/100ft	160 W
\$70.15	\$71.71	\$73.25	\$74.77	36"	48"	Custom Len.
				\$77.87	\$80.94	See Web
RG316-DS Coax, 50 Ohm						
Part No.	PE3C4470			Cable Dia.	Attn. @ 1 GHz	Power @ 1 GHz
1 piece price shown. See web or call for volume pricing.						
6"	12"	18"	24"	0.114" dia.	30 dB/100ft	85 W
\$73.61	\$75.27	\$72.58	\$74.13	36"	48"	Custom Len.
				\$77.24	\$80.34	See Web

**SSMC PLUG RIGHT ANGLE TO SSMC JACK BULKHEAD**

SEE MOUNTING HOLE SECTION ON PAGE 409

**Standard Formable Cable Assemblies**

PE-SR405FLJ Coax, 50 Ohm						
Part No.	PE3C4483			Cable Dia.	Attn. @ 1 GHz	Power @ 1 GHz
1 piece price shown. See web or call for volume pricing.						
6"	12"	18"	24"	0.105" dia.	19.5 dB/100ft	121.5 W
\$67.88	\$72.02	\$76.16	\$80.29	36"	48"	Custom Len.
				\$88.55	\$96.84	See Web

**Standard Flexible Cable Assemblies**

RG178B/U Coax, 50 Ohm						
Part No.	PE3C4458			Cable Dia.	Attn. @ 1 GHz	Power @ 1 GHz
1 piece price shown. See web or call for volume pricing.						
6"	12"	18"	24"	0.072" dia.	44.41 dB/100ft	55 W
\$68.13	\$75.52	\$69.16	\$69.68	36"	48"	Custom Len.
				\$70.69	\$71.73	See Web

**SSMC PLUG RIGHT ANGLE TO SSMC JACK RIGHT ANGLE BULKHEAD**

SEE MOUNTING HOLE SECTION ON PAGE 409

**Standard Flexible Cable Assemblies**

RG178B/U Coax, 50 Ohm						
Part No.	PE3C4460			Cable Dia.	Attn. @ 1 GHz	Power @ 1 GHz
1 piece price shown. See web or call for volume pricing.						
6"	12"	18"	24"	0.072" dia.	44.41 dB/100ft	55 W
\$65.43	\$65.95	\$66.47	\$66.99	36"	48"	Custom Len.
				\$68.00	\$69.04	See Web

**SSMC PLUG RIGHT ANGLE TO TNC MALE**

**Low Loss Flexible Cable Assemblies**

LMR-100A-PVC Coax, 50 Ohm						
Part No.	PE3C4435			Cable Dia.	Attn. @ 1 GHz	Power @ 1 GHz
1 piece price shown. See web or call for volume pricing.						
6"	12"	18"	24"	0.11" dia.	24 dB/100ft	55 W
\$55.78	\$61.81	\$56.60	\$57.02	36"	48"	Custom Len.
				\$57.81	\$58.62	See Web

**Standard Formable Cable Assemblies**

PE-SR405FLJ Coax, 50 Ohm						
Part No.	PE3C4490			Cable Dia.	Attn. @ 1 GHz	Power @ 1 GHz
1 piece price shown. See web or call for volume pricing.						
6"	12"	18"	24"	0.105" dia.	19.5 dB/100ft	121.5 W
\$62.42	\$66.54	\$70.69	\$74.82	36"	48"	Custom Len.
				\$83.11	\$91.37	See Web

**Standard Flexible Cable Assemblies**

RG178B/U Coax, 50 Ohm						
Part No.	PE3C4468			Cable Dia.	Attn. @ 1 GHz	Power @ 1 GHz
1 piece price shown. See web or call for volume pricing.						
6"	12"	18"	24"	0.072" dia.	44.41 dB/100ft	55 W
\$62.27	\$62.79	\$63.30	\$63.82	36"	48"	Custom Len.
				\$64.84	\$65.86	See Web

**RG316/U Coax, 50 Ohm**

Part No.	PE3C4418			Cable Dia.	Attn. @ 1 GHz	Power @ 1 GHz
1 piece price shown. See web or call for volume pricing.						
6"	12"	18"	24"	0.098" dia.	58 dB/100ft	160 W
\$67.42	\$68.96	\$70.52	\$72.04	36"	48"	Custom Len.
				\$75.15	\$78.21	See Web

**RG316-DS Coax, 50 Ohm**

Part No.	PE3C4480			Cable Dia.	Attn. @ 1 GHz	Power @ 1 GHz
1 piece price shown. See web or call for volume pricing.						
6"	12"	18"	24"	0.114" dia.	9.15 dB/100ft	85 W
\$66.74	\$68.28	\$69.85	\$71.39	36"	48"	Custom Len.
				\$74.49	\$77.61	See Web

**SSMC PLUG RIGHT ANGLE TO TNC FEMALE BULKHEAD**

SEE MOUNTING HOLE SECTION ON PAGE 409

**Standard Flexible Cable Assemblies**

RG178B/U Coax, 50 Ohm						
Part No.	PE3W05518			Cable Dia.	Attn. @ 1 GHz	Power @ 1 GHz
1 piece price shown. See web or call for volume pricing.						
12"	24"	36"	48"	0.072" dia.	44.41 dB/100ft	55 W
\$66.20	\$67.43	\$68.67	\$69.92	60"	50CM	Custom Len.
				\$71.17	\$66.99	See Web

**SSMC JACK BULKHEAD TO SSMC JACK BULKHEAD**

SEE MOUNTING HOLE SECTION ON PAGE 409

**Standard Formable Cable Assemblies**

PE-SR405FLJ Coax, 50 Ohm						
Part No.	PE3C4443			Cable Dia.	Attn. @ 1 GHz	Power @ 1 GHz
1 piece price shown. See web or call for volume pricing.						
6"	12"	18"	24"	0.105" dia.	19.5 dB/100ft	121.5 W
\$63.78	\$67.93	\$72.06	\$76.19	36"	48"	Custom Len.
				\$84.46	\$92.74	See Web

**Standard Flexible Cable Assemblies**

RG178B/U Coax, 50 Ohm						
Part No.	PE3C4390			Cable Dia.	Attn. @ 1 GHz	Power @ 1 GHz
1 piece price shown. See web or call for volume pricing.						
6"	12"	18"	24"	0.072" dia.	44.41 dB/100ft	55 W
\$73.00	\$73.53	\$74.05	\$74.57	36"	48"	Custom Len.
				\$75.57	\$76.60	See Web

**SSMC JACK BULKHEAD TO SSMC JACK RIGHT ANGLE BULKHEAD**

SEE MOUNTING HOLE SECTION ON PAGE 409

**Standard Flexible Cable Assemblies**

RG178B/U Coax, 50 Ohm						
Part No.	PE3C4461			Cable Dia.	Attn. @ 1 GHz	Power @ 1 GHz
1 piece price shown. See web or call for volume pricing.						
6"	12"	18"	24"	0.072" dia.	44.41 dB/100ft	55 W
\$70.32	\$70.83	\$71.35	\$71.86	36"	48"	Custom Len.
				\$72.89	\$73.90	See Web

**SSMC JACK BULKHEAD TO TNC MALE**

SEE MOUNTING HOLE SECTION ON PAGE 409

**Standard Formable Cable Assemblies**

PE-SR405FLJ Coax, 50 Ohm						
Part No.	PE3C4454			Cable Dia.	Attn. @ 1 GHz	Power @ 1 GHz
1 piece price shown. See web or call for volume pricing.						
6"	12"	18"	24"	0.105" dia.	19.5 dB/100ft	121.5 W
\$58.31	\$62.46	\$66.60	\$70.72	36"	48"	Custom Len.
				\$79.01	\$87.27	See Web

**Standard Flexible Cable Assemblies**

RG178B/U Coax, 50 Ohm						
Part No.	PE3C4402			Cable Dia.	Attn. @ 1 GHz	Power @ 1 GHz
1 piece price shown. See web or call for volume pricing.						
6"	12"	18"	24"	0.072" dia.	44.41 dB/100ft	55 W
\$67.14	\$67.67	\$68.19	\$68.70	36"	48"	Custom Len.
				\$69.72	\$70.73	See Web

**SSMC JACK RIGHT ANGLE BULKHEAD TO SSMC JACK RIGHT ANGLE BULKHEAD**

SEE MOUNTING HOLE SECTION ON PAGE 409

**Standard Flexible Cable Assemblies**

RG178B/U Coax, 50 Ohm						
Part No.	PE3C4462			Cable Dia.	Attn. @ 1 GHz	Power @ 1 GHz
1 piece price shown. See web or call for volume pricing.						
6"	12"	18"	24"	0.072" dia.	44.41 dB/100ft	55 W
\$67.62	\$74.97	\$75.54	\$69.18	36"	48"	Custom Len.
				\$70.19	\$71.22	See Web

**TNC MALE TO BNC MALE**

**Low Loss Flexible Cable Assemblies**

PE-C195 Coax, 50 Ohm						
Part No.	PE37885			Cable Dia.	Attn. @ 1 GHz	Power @ 1 GHz
1 piece price shown. See web or call for volume pricing.						
12"	24"	36"	48"	0.195" dia.	11.3 dB/100ft	150 W
\$34.32	\$35.11	\$35.91	\$39.71	60"	-	Custom Len.
				\$40.60	-	See Web

**PE-C200 Coax, 50 Ohm**

Part No.	PE36068			Cable Dia.	Attn. @ 1 GHz	Power @ 1 GHz
1 piece price shown. See web or call for volume pricing.						
12"	24"	36"	48"	0.195" dia.	10.8 dB/100ft	170 W
\$50.91	\$55.06	\$59.70	\$64.37	60"	-	Custom Len.
				\$68.97	-	See Web

**PE-C240 Coax, 50 Ohm**

Part No.	PE37594			Cable Dia.	Attn. @ 1 GHz	Power @ 1 GHz
1 piece price shown. See web or call for volume pricing.						
12"	24"	36"	48"	0.24" dia.	9.2 dB/100ft	250 W
\$45.71	\$46.25	\$49.38	\$52.44	60"	-	Custom Len.
				\$55.06	-	See Web

**PE-C400 Coax, 50 Ohm**

Part No.	PE37563			Cable Dia.	Attn. @ 1 GHz	Power @ 1 GHz
1 piece price shown. See web or call for volume pricing.						
12"	24"	36"	48"	0.4" dia.	4.1 dB/100ft	550 W
\$90.82	\$92.22	\$93.62	\$94.98	60"	-	Custom Len.
				\$96.36	-	See Web

\*Coax Performance at 1 GHz Notes: Cable assembly max frequency may be lower than connector or coax max frequency



For our complete selection of cable assemblies, please visit our website

Standard Flexible Cable Assemblies							
RG8A/U Coax, 50 Ohm							
Part No. <a href="#">PE34504</a>	Cable Dia.			Attn. @ 1 GHz	Power @ 1 GHz		
1 piece price shown. See web or call for volume pricing.	0.405" dia.			8 dB/100ft	190 W		
12"	24"	36"	48"	60"	72"	Custom Len.	
\$79.01	\$82.12	\$85.23	\$88.35	\$91.46	\$94.57	See Web	
RG58C/U Coax, 50 Ohm							
Part No. <a href="#">PE3497</a>	Cable Dia.			Attn. @ 1 GHz	Power @ 1 GHz		
1 piece price shown. See web or call for volume pricing.	0.195" dia.			20 dB/100ft	44 W		
12"	24"	36"	48"	60"	72"	Custom Len.	
\$41.20	\$42.11	\$43.01	\$41.34	\$42.16	\$45.81	See Web	
RG58-P Coax, 50 Ohm							
Part No. <a href="#">PE35789</a>	Cable Dia.			Attn. @ 1 GHz	Power @ 1 GHz		
1 piece price shown. See web or call for volume pricing.	0.159" dia.			17.3 dB/100ft	632 W		
12"	24"	36"	48"	60"	-	Custom Len.	
\$54.60	\$60.09	\$65.59	\$71.08	\$76.58	-	See Web	
RG142B/U Coax, 50 Ohm							
Part No. <a href="#">PE3551</a>	Cable Dia.			Attn. @ 1 GHz	Power @ 1 GHz		
1 piece price shown. See web or call for volume pricing.	0.195" dia.			13 dB/100ft	650 W		
12"	24"	36"	48"	60"	72"	Custom Len.	
\$44.80	\$51.16	\$60.41	\$63.30	\$69.60	\$75.91	See Web	
RG174A/U Coax, 50 Ohm							
Part No. <a href="#">PE3C3400</a>	Cable Dia.			Attn. @ 1 GHz	Power @ 1 GHz		
1 piece price shown. See web or call for volume pricing.	0.11" dia.			32 dB/100ft	17 W		
12"	24"	36"	48"	60"	72"	Custom Len.	
\$49.26	\$49.75	\$50.22	\$50.67	\$51.17	\$51.63	See Web	
RG178B/U Coax, 50 Ohm							
Part No. <a href="#">PE39255</a>	Cable Dia.			Attn. @ 1 GHz	Power @ 1 GHz		
1 piece price shown. See web or call for volume pricing.	0.072" dia.			44.4 dB/100ft	78 W		
12"	24"	36"	48"	60"	-	Custom Len.	
\$73.26	\$76.25	\$83.45	\$90.63	\$97.77	-	See Web	
RG188A/U Coax, 50 Ohm							
Part No. <a href="#">PE3C3401</a>	Cable Dia.			Attn. @ 1 GHz	Power @ 1 GHz		
1 piece price shown. See web or call for volume pricing.	0.11" dia.			26 dB/100ft	160 W		
12"	24"	36"	48"	60"	72"	Custom Len.	
\$51.05	\$53.35	\$61.13	\$57.37	\$59.66	\$61.89	See Web	
RG213/U Coax, 50 Ohm							
Part No. <a href="#">PE33969</a>	Cable Dia.			Attn. @ 1 GHz	Power @ 1 GHz		
1 piece price shown. See web or call for volume pricing.	0.405" dia.			8 dB/100ft	190 W		
12"	24"	36"	48"	60"	72"	Custom Len.	
\$79.21	\$81.05	\$82.87	\$84.70	\$86.52	\$88.36	See Web	
RG214/U Coax, 50 Ohm							
Part No. <a href="#">PE33701</a>	Cable Dia.			Attn. @ 1 GHz	Power @ 1 GHz		
1 piece price shown. See web or call for volume pricing.	0.425" dia.			7.32 dB/100ft	190 W		
12"	24"	36"	48"	60"	72"	Custom Len.	
\$90.68	\$98.73	\$106.78	\$113.26	\$121.19	\$137.77	See Web	
RG223/U Coax, 50 Ohm							
Part No. <a href="#">PE3498</a>	Cable Dia.			Attn. @ 1 GHz	Power @ 1 GHz		
1 piece price shown. See web or call for volume pricing.	0.21" dia.			13.4 dB/100ft	53 W		
12"	24"	36"	48"	60"	72"	Custom Len.	
\$40.90	\$48.44	\$51.91	\$55.05	\$53.77	\$62.03	See Web	
RG316/U Coax, 50 Ohm							
Part No. <a href="#">PE3C3393</a>	Cable Dia.			Attn. @ 1 GHz	Power @ 1 GHz		
1 piece price shown. See web or call for volume pricing.	0.102" dia.			38 dB/100ft	160 W		
12"	24"	36"	48"	60"	72"	Custom Len.	
\$50.85	\$54.06	\$60.28	\$63.91	\$63.09	\$66.26	See Web	
RG393/U Coax, 50 Ohm							
Part No. <a href="#">PE37859</a>	Cable Dia.			Attn. @ 1 GHz	Power @ 1 GHz		
1 piece price shown. See web or call for volume pricing.	0.39" dia.			8.8 dB/100ft	1,700 W		
12"	24"	36"	48"	60"	-	Custom Len.	
\$83.50	\$106.56	\$113.64	\$129.32	\$144.94	-	See Web	
RG400/U Coax, 50 Ohm							
Part No. <a href="#">PE33535</a>	Cable Dia.			Attn. @ 1 GHz	Power @ 1 GHz		
1 piece price shown. See web or call for volume pricing.	0.195" dia.			14.7 dB/100ft	650 W		
12"	24"	36"	48"	60"	72"	Custom Len.	
\$53.97	\$64.82	\$68.79	\$81.53	\$89.84	\$98.12	See Web	
PE-P195 Coax, 50 Ohm							
Part No. <a href="#">PE37478</a>	Cable Dia.			Attn. @ 1 GHz	Power @ 1 GHz		
1 piece price shown. See web or call for volume pricing.	0.195" dia.			12.5 dB/100ft	650 W		
12"	24"	36"	48"	60"	-	Custom Len.	
\$45.32	\$54.45	\$62.90	\$71.88	\$80.86	-	See Web	
LMR-240 Coax, 50 Ohm							
Part No. <a href="#">PE3CA1091</a>	Cable Dia.			Attn. @ 1 GHz	Power @ 1 GHz		
1 piece price shown. See web or call for volume pricing.	0.24" dia.			-	-		
12"	24"	36"	48"	60"	72"	Custom Len.	
Call	Call	Call	Call	Call	Call	See Web	
RG55B/U Coax, 53 Ohm							
Part No. <a href="#">PE3904</a>	Cable Dia.			Attn. @ 1 GHz	Power @ 1 GHz		
1 piece price shown. See web or call for volume pricing.	0.202" dia.			16.5 dB/100ft	53 W		
12"	24"	36"	48"	60"	72"	Custom Len.	
\$40.72	\$43.19	\$45.68	\$48.17	\$50.67	\$53.15	See Web	
RG59B/U Coax, 75 Ohm							
Part No. <a href="#">PE3023</a>	Cable Dia.			Attn. @ 1 GHz	Power @ 1 GHz		
1 piece price shown. See web or call for volume pricing.	0.242" dia.			11.5 dB/100ft	77 W		
12"	24"	36"	48"	60"	72"	Custom Len.	
\$39.08	\$42.58	\$43.72	\$42.28	\$43.34	\$47.30	See Web	

RG179B/U Coax, 75 Ohm							
Part No. <a href="#">PE34510</a>	Cable Dia.			Attn. @ 1 GHz	Power @ 1 GHz		
1 piece price shown. See web or call for volume pricing.	0.1" dia.			25 dB/100ft	200 W		
12"	24"	36"	48"	60"	72"	Custom Len.	
\$53.31	\$55.44	\$58.10	\$60.68	\$63.30	\$65.88	See Web	
RG62A/U Coax, 93 Ohm							
Part No. <a href="#">PE34508</a>	Cable Dia.			Attn. @ 1 GHz	Power @ 1 GHz		
1 piece price shown. See web or call for volume pricing.	0.242" dia.			13 dB/100ft	77 W		
12"	24"	36"	48"	60"	72"	Custom Len.	
\$36.00	\$37.46	\$38.94	\$40.41	\$41.85	\$43.33	See Web	
TNC MALE TO MINI UHF MALE							
Low Loss Flexible Cable Assemblies							
LMR-195 Coax, 50 Ohm							
Part No. <a href="#">PE3C0047</a>	Cable Dia.			Attn. @ 1 GHz	Power @ 1 GHz		
1 piece price shown. See web or call for volume pricing.	0.195" dia.			11.8 dB/100ft	-		
12"	24"	36"	48"	60"	-	Custom Len.	
\$33.28	\$34.11	\$34.94	\$35.76	\$36.60	-	See Web	
TNC MALE TO N MALE							
Flexible Cable Assemblies							
LMR-195 Coax, 50 Ohm							
Part No. <a href="#">PE3W01959</a>	Cable Dia.			Attn. @ 1 GHz	Power @ 1 GHz		
1 piece price shown. See web or call for volume pricing.	0.195" dia.			11.8 dB/100ft	50CM		
12"	24"	36"	48"	60"	50CM	Custom Len.	
\$49.24	\$50.05	\$50.85	\$51.66	\$52.47	\$49.75	See Web	
Low Loss Flexible Cable Assemblies							
LMR-240 Coax, 50 Ohm							
Part No. <a href="#">PE3W04201</a>	Cable Dia.			Attn. @ 1 GHz	Power @ 1 GHz		
1 piece price shown. See web or call for volume pricing.	0.24" dia.			8 dB/100ft	50CM		
12"	24"	36"	48"	60"	50CM	Custom Len.	
\$44.95	\$45.92	\$46.91	\$47.88	\$48.86	\$45.57	See Web	
PE-P142LL-27478 Coax, 50 Ohm							
Part No. <a href="#">PE3M0162</a>	Cable Dia.			Attn. @ 1 GHz	Power @ 1 GHz		
1 piece price shown. See web or call for volume pricing.	0.195" dia.			-	-		
12"	18"	24"	36"	48"	60"	Custom Len.	
\$410.26	\$419.46	\$428.65	\$447.04	\$465.41	\$483.80	See Web	
PE-P160LL-27478 Coax, 50 Ohm							
Part No. <a href="#">PE3M0207</a>	Cable Dia.			Attn. @ 1 GHz	Power @ 1 GHz		
1 piece price shown. See web or call for volume pricing.	0.16" dia.			-	-		
8"	12"	18"	24"	30"	36"	Custom Len.	
\$383.46	\$388.77	\$396.74	\$404.70	\$412.68	\$420.65	See Web	
PE-P300LL-27478 Coax, 50 Ohm							
Part No. <a href="#">PE3M0240</a>	Cable Dia.			Attn. @ 1 GHz	Power @ 1 GHz		
1 piece price shown. See web or call for volume pricing.	0.3" dia.			-	-		
12"	18"	24"	36"	48"	60"	Custom Len.	
\$448.95	\$464.28	\$479.64	\$510.32	\$541.00	\$571.69	See Web	
TNC MALE TO N MALE RIGHT ANGLE							
Low Loss Flexible Cable Assemblies							
PE-P142LL-27478 Coax, 50 Ohm							
Part No. <a href="#">PE3M0164</a>	Cable Dia.			Attn. @ 1 GHz	Power @ 1 GHz		
1 piece price shown. See web or call for volume pricing.	0.195" dia.			-	-		
12"	18"	24"	36"	48"	60"	Custom Len.	
\$534.98	\$544.17	\$553.36	\$571.74	\$590.12	\$608.51	See Web	
PE-P160LL-27478 Coax, 50 Ohm							
Part No. <a href="#">PE3M0209</a>	Cable Dia.			Attn. @ 1 GHz	Power @ 1 GHz		
1 piece price shown. See web or call for volume pricing.	0.16" dia.			-	-		
8"	12"	18"	24"	30"	36"	Custom Len.	
\$489.78	\$495.07	\$503.06	\$511.01	\$518.99	\$526.95	See Web	
PE-P300LL-27478 Coax, 50 Ohm							
Part No. <a href="#">PE3M0242</a>	Cable Dia.			Attn. @ 1 GHz	Power @ 1 GHz		
1 piece price shown. See web or call for volume pricing.	0.3" dia.			-	-		
12"	18"	24"	36"	48"	60"	Custom Len.	
\$606.09	\$621.42	\$636.78	\$667.46	\$698.14	\$728.83	See Web	
TNC MALE TO N FEMALE BULKHEAD							
SEE MOUNTING HOLE SECTION ON PAGE 409							
Low Loss Flexible Cable Assemblies							
PE-P142LL-27478 Coax, 50 Ohm							
Part No. <a href="#">PE3M0163</a>	Cable Dia.			Attn. @ 1 GHz	Power @ 1 GHz		
1 piece price shown. See web or call for volume pricing.	0.195" dia.			-	-		
12"	18"	24"	36"	48"	60"	Custom Len.	
\$504.81	\$514.01	\$523.19	\$541.58	\$559.96	\$578.34	See Web	

Cable Assemblies

See Our Website For Current Pricing & Real-Time Stock Availability!

For Custom Lengths, Metric Lengths or Special Configurations, Please call (949) 261-1920



Technical Support  
+1 (949) 261-1920



Same-Day Shipping,  
Even Custom Cable Assemblies



For our complete selection of cable assemblies, please visit our website

Cable Assemblies

See Our Website For Current Pricing & Real-Time Stock Availability!

PE-P160LL-27478 Coax, 50 Ohm				
Part No. <a href="#">PE3M0208</a>	Cable Dia.	Attn. @ 1 GHz	Power @ 1 GHz	
1 piece price shown. See web or call for volume pricing.				
8"	12"	18"	24"	30"
\$494.03	\$499.35	\$507.32	\$515.28	\$523.26
22				
PE-P300LL-27478 Coax, 50 Ohm				
Part No. <a href="#">PE3M0241</a>	Cable Dia.	Attn. @ 1 GHz	Power @ 1 GHz	
1 piece price shown. See web or call for volume pricing.				
12"	18"	24"	36"	48"
\$530.98	\$546.33	\$561.68	\$592.36	\$623.04
23				
TNC MALE TO SMA MALE				
Low Loss Flexible Cable Assemblies				
LMR-195-FR Coax, 50 Ohm				
Part No. <a href="#">PE3W04028</a>	Cable Dia.	Attn. @ 1 GHz	Power @ 1 GHz	
1 piece price shown. See web or call for volume pricing.				
12"	24"	36"	48"	60"
\$31.02	\$44.13	\$45.24	\$46.35	\$47.44
24				
TNC MALE TO SMA MALE RIGHT ANGLE				
Flexible Cable Assemblies				
LMR-200 Coax, 50 Ohm				
Part No. <a href="#">PE3W07265</a>	Cable Dia.	Attn. @ 1 GHz	Power @ 1 GHz	
1 piece price shown. See web or call for volume pricing.				
12"	24"	36"	48"	60"
\$66.04	\$66.82	\$67.61	\$68.39	\$69.19
25				
TNC MALE TO SMP FEMALE RIGHT ANGLE				
Standard Flexible Cable Assemblies				
RG316/U Coax, 50 Ohm				
Part No. <a href="#">PE3W05738</a>	Cable Dia.	Attn. @ 1 GHz	Power @ 1 GHz	
1 piece price shown. See web or call for volume pricing.				
12"	24"	36"	48"	60"
\$57.43	\$60.76	\$69.23	\$67.45	\$70.79
26				
TNC MALE TO TNC MALE				
Flexible Cable Assemblies				
LMR-195-FR Coax, 50 Ohm				
Part No. <a href="#">PE3W05242</a>	Cable Dia.	Attn. @ 1 GHz	Power @ 1 GHz	
1 piece price shown. See web or call for volume pricing.				
12"	24"	36"	48"	60"
\$28.49	\$29.59	\$30.70	\$31.81	\$32.91
27				
Flexible Flexible Cable Assemblies				
RG174A/U Coax, 50 Ohm				
Part No. <a href="#">PE3C7891</a>	Cable Dia.	Attn. @ 1 GHz	Power @ 1 GHz	
1 piece price shown. See web or call for volume pricing.				
12"	24"	36"	48"	60"
\$66.17	\$66.78	\$67.40	\$68.01	\$68.63
28				
Low Loss Flexible Cable Assemblies				
PE-C195 Coax, 50 Ohm				
Part No. <a href="#">PE36555</a>	Cable Dia.	Attn. @ 1 GHz	Power @ 1 GHz	
1 piece price shown. See web or call for volume pricing.				
12"	24"	36"	48"	60"
\$42.98	\$43.86	\$40.67	\$45.64	\$46.53
29				
PE-C240 Coax, 50 Ohm				
Part No. <a href="#">PE35997</a>	Cable Dia.	Attn. @ 1 GHz	Power @ 1 GHz	
1 piece price shown. See web or call for volume pricing.				
12"	24"	36"	48"	60"
\$49.37	\$47.65	\$49.38	\$52.44	\$54.50
30				
PE-C400 Coax, 50 Ohm				
Part No. <a href="#">PE35886</a>	Cable Dia.	Attn. @ 1 GHz	Power @ 1 GHz	
1 piece price shown. See web or call for volume pricing.				
12"	24"	36"	48"	60"
\$99.92	\$95.70	\$99.46	\$104.75	\$106.59
31				
LMR-400-DB Coax, 50 Ohm				
Part No. <a href="#">PE3W00572</a>	Cable Dia.	Attn. @ 1 GHz	Power @ 1 GHz	
1 piece price shown. See web or call for volume pricing.				
12"	24"	36"	48"	60"
\$87.00	\$88.59	\$90.17	\$91.75	\$93.34
32				
LMR-195 Coax, 50 Ohm				
Part No. <a href="#">PE3C0042</a>	Cable Dia.	Attn. @ 1 GHz	Power @ 1 GHz	
1 piece price shown. See web or call for volume pricing.				
12"	24"	36"	48"	60"
\$39.81	\$40.62	\$41.47	\$42.34	\$43.19
33				

PE-P142LL-27478 Coax, 50 Ohm				
Part No. <a href="#">PE3C0117</a>	Cable Dia.	Attn. @ 1 GHz	Power @ 1 GHz	
1 piece price shown. See web or call for volume pricing.				
12"	24"	36"	48"	60"
\$57.91	\$58.74	\$59.56	\$60.42	\$58.97
34				
PE-P160LL Coax, 50 Ohm				
Part No. <a href="#">PE3M0159</a>	Cable Dia.	Attn. @ 1 GHz	Power @ 1 GHz	
1 piece price shown. See web or call for volume pricing.				
12"	18"	24"	36"	60"
\$419.33	\$428.52	\$437.70	\$456.09	\$474.47
35				
PE-P160LL Coax, 50 Ohm				
Part No. <a href="#">PE3C5249</a>	Cable Dia.	Attn. @ 1 GHz	Power @ 1 GHz	
1 piece price shown. See web or call for volume pricing.				
12"	24"	36"	48"	60"
\$222.74	\$245.21	\$267.66	\$290.11	\$312.56
36				
PE-P160LL-27478 Coax, 50 Ohm				
Part No. <a href="#">PE3M0204</a>	Cable Dia.	Attn. @ 1 GHz	Power @ 1 GHz	
1 piece price shown. See web or call for volume pricing.				
8"	12"	18"	24"	30"
\$397.61	\$402.91	\$410.89	\$418.85	\$426.83
37				
PE-P300LL-27478 Coax, 50 Ohm				
Part No. <a href="#">PE3M0238</a>	Cable Dia.	Attn. @ 1 GHz	Power @ 1 GHz	
1 piece price shown. See web or call for volume pricing.				
12"	18"	24"	36"	48"
\$444.62	\$459.96	\$475.31	\$506.00	\$536.67
38				
Precision Formable Cable Assemblies				
PE-SR402FL Coax, 50 Ohm				
Part No. <a href="#">PE39479</a>	Cable Dia.	Attn. @ 1 GHz	Power @ 1 GHz	
1 piece price shown. See web or call for volume pricing.				
6"	9"	12"	18"	24"
\$58.88	Call	\$63.20	Call	\$56.46
39				
PE-SR405FL Coax, 50 Ohm				
Part No. <a href="#">PE39471</a>	Cable Dia.	Attn. @ 1 GHz	Power @ 1 GHz	
1 piece price shown. See web or call for volume pricing.				
6"	9"	12"	18"	24"
Call	Call	Call	Call	Call
40				
Low Loss Test Flexible Cable Assemblies				
PE-P300LL Coax, 50 Ohm				
Part No. <a href="#">PE334</a>	Cable Dia.	Attn. @ 1 GHz	Power @ 1 GHz	
1 piece price shown. See web or call for volume pricing.				
12"	24"	36"	48"	60"
\$340.49	\$368.59	\$396.73	\$424.85	\$452.96
41				
PE-P142LL Coax, 50 Ohm				
Part No. <a href="#">PE347</a>	Cable Dia.	Attn. @ 1 GHz	Power @ 1 GHz	
1 piece price shown. See web or call for volume pricing.				
12"	24"	36"	48"	60"
\$168.98	\$186.58	\$204.19	\$221.79	\$239.40
42				
Standard Formable Cable Assemblies				
PE-SR047FL Coax, 50 Ohm				
Part No. <a href="#">PE34280</a>	Cable Dia.	Attn. @ 1 GHz	Power @ 1 GHz	
1 piece price shown. See web or call for volume pricing.				
6"	12"	18"	24"	36"
\$87.84	\$91.82	\$95.70	\$99.68	\$107.54
43				
PE-SR401FL Coax, 50 Ohm				
Part No. <a href="#">PE34282</a>	Cable Dia.	Attn. @ 1 GHz	Power @ 1 GHz	
1 piece price shown. See web or call for volume pricing.				
6"	12"	18"	24"	36"
\$184.95	\$184.95	\$193.30	\$201.65	\$218.35
44				
PE-SR402FL Coax, 50 Ohm				
Part No. <a href="#">PE3466</a>	Cable Dia.	Attn. @ 1 GHz	Power @ 1 GHz	
1 piece price shown. See web or call for volume pricing.				
6"	12"	18"	24"	36"
\$101.82	\$101.82	\$105.95	\$108.57	\$123.94
45				
PE-SR402FLJ Coax, 50 Ohm				
Part No. <a href="#">PE39493</a>	Cable Dia.	Attn. @ 1 GHz	Power @ 1 GHz	
1 piece price shown. See web or call for volume pricing.				
-	6"	9"	12"	18"
-	\$62.88	Call	Call	Call
46				
PE-SR405FL Coax, 50 Ohm				
Part No. <a href="#">PE3684</a>	Cable Dia.	Attn. @ 1 GHz	Power @ 1 GHz	
1 piece price shown. See web or call for volume pricing.				
6"	12"	18"	24"	36"
\$89.91	\$95.65	\$101.32	\$107.05	\$116.75
47				
PE-SR405FLJ Coax, 50 Ohm				
Part No. <a href="#">PE39485</a>	Cable Dia.	Attn. @ 1 GHz	Power @ 1 GHz	
1 piece price shown. See web or call for volume pricing.				
6"	9"	12"	18"	24"
\$55.86	\$58.14	\$60.41	\$65.11	\$59.63
48				
Standard Flexible Cable Assemblies				
PE-B100 Coax, 50 Ohm				
Part No. <a href="#">PE38830</a>	Cable Dia.	Attn. @ 1 GHz	Power @ 1 GHz	
1 piece price shown. See web or call for volume pricing.				
12"	24"	36"	48"	60"
\$64.83	\$72.03	\$79.20	\$86.34	\$93.62
49				

\*Coax Performance at 1 GHz Notes: Cable assembly max frequency may be lower than connector or coax max frequency

# For our complete selection of cable assemblies, please visit our website

RG8A/U Coax, 50 Ohm						
Part No. <a href="#">PE3418</a>	1 piece price shown. See web or call for volume pricing.			Cable Dia.	Attn. @ 1 GHz	Power @ 1 GHz
12"	24"	36"	48"	0.405" dia.	8 dB/100ft	190 W
\$73.35	\$72.16	\$75.21	\$78.15	60"	72"	Custom Len.
\$73.35	\$72.16	\$75.21	\$78.15	\$81.19	\$84.23	See Web
RG8X Coax, 50 Ohm						
Part No. <a href="#">PE35671</a>	1 piece price shown. See web or call for volume pricing.			Cable Dia.	Attn. @ 1 GHz	Power @ 1 GHz
12"	24"	36"	48"	0.242" dia.	13.5 dB/100ft	60 W
\$73.08	\$76.97	\$73.80	\$76.90	60"	-	Custom Len.
\$73.08	\$76.97	\$73.80	\$76.90	\$80.01	-	See Web
RG58C/U Coax, 50 Ohm						
Part No. <a href="#">PE3394</a>	1 piece price shown. See web or call for volume pricing.			Cable Dia.	Attn. @ 1 GHz	Power @ 1 GHz
12"	18"	24"	30"	0.195" dia.	20 dB/100ft	44 W
\$41.12	\$41.58	\$42.02	\$42.48	36"	48"	Custom Len.
\$41.12	\$41.58	\$42.02	\$42.48	\$42.93	\$43.89	See Web
RG142B/U Coax, 50 Ohm						
Part No. <a href="#">PE3544</a>	1 piece price shown. See web or call for volume pricing.			Cable Dia.	Attn. @ 1 GHz	Power @ 1 GHz
12"	24"	36"	48"	0.195" dia.	13 dB/100ft	650 W
\$53.00	\$59.20	\$65.88	\$72.96	60"	72"	Custom Len.
\$53.00	\$59.20	\$65.88	\$72.96	\$79.76	\$86.59	See Web
RG174A/U Coax, 50 Ohm						
Part No. <a href="#">PE3425</a>	1 piece price shown. See web or call for volume pricing.			Cable Dia.	Attn. @ 1 GHz	Power @ 1 GHz
12"	24"	36"	48"	0.1" dia.	32 dB/100ft	16 W
\$68.63	\$69.11	\$74.03	\$74.70	60"	72"	Custom Len.
\$68.63	\$69.11	\$74.03	\$74.70	\$70.54	\$71.01	See Web
RG188A/U Coax, 50 Ohm						
Part No. <a href="#">PE3434</a>	1 piece price shown. See web or call for volume pricing.			Cable Dia.	Attn. @ 1 GHz	Power @ 1 GHz
12"	24"	36"	48"	0.11" dia.	26 dB/100ft	160 W
\$69.46	\$71.89	\$74.34	\$76.77	60"	72"	Custom Len.
\$69.46	\$71.89	\$74.34	\$76.77	\$79.20	\$81.65	See Web
RG213/U Coax, 50 Ohm						
Part No. <a href="#">PE3421</a>	1 piece price shown. See web or call for volume pricing.			Cable Dia.	Attn. @ 1 GHz	Power @ 1 GHz
12"	24"	36"	48"	0.405" dia.	8 dB/100ft	190 W
\$73.46	\$75.28	\$77.10	\$78.93	60"	72"	Custom Len.
\$73.46	\$75.28	\$77.10	\$78.93	\$80.76	\$82.59	See Web
RG214/U Coax, 50 Ohm						
Part No. <a href="#">PE3435</a>	1 piece price shown. See web or call for volume pricing.			Cable Dia.	Attn. @ 1 GHz	Power @ 1 GHz
12"	24"	36"	48"	0.425" dia.	7.32 dB/100ft	190 W
\$98.94	\$111.85	\$120.29	\$129.22	60"	72"	Custom Len.
\$98.94	\$111.85	\$120.29	\$129.22	\$129.34	\$146.42	See Web
RG223/U Coax, 50 Ohm						
Part No. <a href="#">PE3414</a>	1 piece price shown. See web or call for volume pricing.			Cable Dia.	Attn. @ 1 GHz	Power @ 1 GHz
12"	24"	36"	48"	0.21" dia.	13.4 dB/100ft	53 W
\$51.64	\$54.58	\$58.00	\$61.62	60"	72"	Custom Len.
\$51.64	\$54.58	\$58.00	\$61.62	\$65.12	\$68.61	See Web
RG303/U Coax, 50 Ohm						
Part No. <a href="#">PE33013</a>	1 piece price shown. See web or call for volume pricing.			Cable Dia.	Attn. @ 1 GHz	Power @ 1 GHz
12"	24"	36"	48"	0.17" dia.	14 dB/100ft	650 W
\$46.53	\$53.68	\$56.09	\$62.41	60"	-	Custom Len.
\$46.53	\$53.68	\$56.09	\$62.41	\$74.95	-	See Web
RG316/U Coax, 50 Ohm						
Part No. <a href="#">PE3747</a>	1 piece price shown. See web or call for volume pricing.			Cable Dia.	Attn. @ 1 GHz	Power @ 1 GHz
12"	24"	36"	48"	0.098" dia.	38 dB/100ft	160 W
\$70.44	\$73.62	\$76.78	\$86.59	60"	72"	Custom Len.
\$70.44	\$73.62	\$76.78	\$86.59	\$83.15	\$93.59	See Web
RG316-DS Coax, 50 Ohm						
Part No. <a href="#">PE34316</a>	1 piece price shown. See web or call for volume pricing.			Cable Dia.	Attn. @ 1 GHz	Power @ 1 GHz
12"	24"	36"	48"	0.114" dia.	30 dB/100ft	160 W
\$64.25	\$67.45	\$76.25	\$73.84	60"	-	Custom Len.
\$64.25	\$67.45	\$76.25	\$73.84	\$77.05	-	See Web
RG393/U Coax, 50 Ohm						
Part No. <a href="#">PE33185</a>	1 piece price shown. See web or call for volume pricing.			Cable Dia.	Attn. @ 1 GHz	Power @ 1 GHz
12"	24"	36"	48"	0.39" dia.	7.5 dB/100ft	1,700 W
\$105.10	\$121.41	\$131.30	\$158.03	60"	-	Custom Len.
\$105.10	\$121.41	\$131.30	\$158.03	\$164.84	-	See Web
RG400/U Coax, 50 Ohm						
Part No. <a href="#">PE3608</a>	1 piece price shown. See web or call for volume pricing.			Cable Dia.	Attn. @ 1 GHz	Power @ 1 GHz
12"	24"	36"	48"	0.195" dia.	14.7 dB/100ft	650 W
\$62.86	\$68.10	\$79.11	\$83.42	60"	72"	Custom Len.
\$62.86	\$68.10	\$79.11	\$83.42	\$96.02	\$104.29	See Web
PE-P141EAM Coax, 50 Ohm						
Part No. <a href="#">PE3CA1043</a>	1 piece price shown. See web or call for volume pricing.			Cable Dia.	Attn. @ 1 GHz	Power @ 1 GHz
12"	24"	36"	50CM	0.163" dia.	-	Custom Len.
Call	\$321.79	\$312.90	Call	100CM	-	Custom Len.
Call	\$321.79	\$312.90	Call	Call	-	See Web
PE-P195 Coax, 50 Ohm						
Part No. <a href="#">PE35711</a>	1 piece price shown. See web or call for volume pricing.			Cable Dia.	Attn. @ 1 GHz	Power @ 1 GHz
12"	24"	36"	48"	0.195" dia.	12.5 dB/100ft	650 W
\$53.85	\$62.33	\$77.62	\$80.28	60"	-	Custom Len.
\$53.85	\$62.33	\$77.62	\$80.28	\$89.32	-	See Web
LMR-240 Coax, 50 Ohm						
Part No. <a href="#">PE3CA1087</a>	1 piece price shown. See web or call for volume pricing.			Cable Dia.	Attn. @ 1 GHz	Power @ 1 GHz
12"	24"	36"	48"	0.24" dia.	-	Custom Len.
Call	Call	Call	Call	60"	72"	Custom Len.
Call	Call	Call	Call	Call	Call	See Web

LMR-400-UF Coax, 50 Ohm						
Part No. <a href="#">PE3W00808</a>	1 piece price shown. See web or call for volume pricing.			Cable Dia.	Attn. @ 1 GHz	Power @ 1 GHz
12"	24"	36"	48"	0.405" dia.	5 dB/100ft	500 W
\$88.31	\$91.12	\$93.93	\$96.74	60"	50CM	Custom Len.
\$88.31	\$91.12	\$93.93	\$96.74	\$99.55	\$90.12	See Web
LMR-600 Coax, 50 Ohm						
Part No. <a href="#">PE3C0631</a>	1 piece price shown. See web or call for volume pricing.			Cable Dia.	Attn. @ 1 GHz	Power @ 1 GHz
12"	24"	36"	48"	0.59" dia.	2.62 dB/100ft	Custom Len.
Call	Call	Call	Call	60"	72"	Custom Len.
Call	Call	Call	Call	Call	Call	See Web
RG55B/U Coax, 53 Ohm						
Part No. <a href="#">PE3504</a>	1 piece price shown. See web or call for volume pricing.			Cable Dia.	Attn. @ 1 GHz	Power @ 1 GHz
12"	24"	36"	48"	0.202" dia.	16.5 dB/100ft	53 W
\$47.73	\$50.22	\$52.71	\$54.69	60"	72"	Custom Len.
\$47.73	\$50.22	\$52.71	\$54.69	\$57.15	\$59.62	See Web
RG59B/U Coax, 75 Ohm						
Part No. <a href="#">PE3402</a>	1 piece price shown. See web or call for volume pricing.			Cable Dia.	Attn. @ 1 GHz	Power @ 1 GHz
12"	18"	24"	30"	0.242" dia.	11.5 dB/100ft	77 W
\$41.53	\$42.08	\$45.19	\$43.13	36"	48"	Custom Len.
\$41.53	\$42.08	\$45.19	\$43.13	\$43.67	\$44.73	See Web
RG179B/U Coax, 75 Ohm						
Part No. <a href="#">PE3430</a>	1 piece price shown. See web or call for volume pricing.			Cable Dia.	Attn. @ 1 GHz	Power @ 1 GHz
12"	24"	36"	48"	0.1" dia.	25 dB/100ft	200 W
\$69.73	\$72.34	\$74.94	\$77.53	60"	72"	Custom Len.
\$69.73	\$72.34	\$74.94	\$77.53	\$80.14	\$82.72	See Web
RG62A/U Coax, 93 Ohm						
Part No. <a href="#">PE3408</a>	1 piece price shown. See web or call for volume pricing.			Cable Dia.	Attn. @ 1 GHz	Power @ 1 GHz
12"	24"	36"	48"	0.242" dia.	13 dB/100ft	77 W
\$42.05	\$43.56	\$48.83	\$46.61	60"	72"	Custom Len.
\$42.05	\$43.56	\$48.83	\$46.61	\$48.14	\$49.65	See Web
M17/60-RG142-27478 Coax, 50 Ohm						
Part No. <a href="#">PE3M0028</a>	1 piece price shown. See web or call for volume pricing.			Cable Dia.	Attn. @ 1 GHz	Power @ 1 GHz
12"	18"	24"	30"	0.195" dia.	36"	48"
\$170.43	\$173.38	\$176.35	\$179.30	\$182.26	\$188.17	See Web
M17/84-RG223-0XDS2 Coax, 50 Ohm						
Part No. <a href="#">PE3M0056</a>	1 piece price shown. See web or call for volume pricing.			Cable Dia.	Attn. @ 1 GHz	Power @ 1 GHz
12"	18"	24"	30"	0.212" dia.	36"	48"
\$175.09	\$180.37	\$185.68	\$190.96	\$196.24	\$206.83	See Web
M17/128-RG400-27478 Coax, 50 Ohm						
Part No. <a href="#">PE3M0084</a>	1 piece price shown. See web or call for volume pricing.			Cable Dia.	Attn. @ 1 GHz	Power @ 1 GHz
12"	18"	24"	30"	0.195" dia.	36"	48"
\$172.05	\$175.80	\$179.57	\$183.33	\$187.09	\$194.62	See Web
M17/113-RG316-27478 Coax, 50 Ohm						
Part No. <a href="#">PE3M0099</a>	1 piece price shown. See web or call for volume pricing.			Cable Dia.	Attn. @ 1 GHz	Power @ 1 GHz
6"	8"	12"	16"	0.098" dia.	18"	24"
\$204.19	\$204.55	\$205.28	\$205.95	\$206.36	\$207.46	See Web
M17/119-RG174-0XDS2 Coax, 50 Ohm						
Part No. <a href="#">PE3M0114</a>	1 piece price shown. See web or call for volume pricing.			Cable Dia.	Attn. @ 1 GHz	Power @ 1 GHz
6"	8"	12"	16"	0.11" dia.	18"	24"
\$203.53	\$203.66	\$203.95	\$204.23	\$204.38	\$204.80	See Web
M17/28-RG058-0XDS2 Coax, 50 Ohm						
Part No. <a href="#">PE3M0124</a>	1 piece price shown. See web or call for volume pricing.			Cable Dia.	Attn. @ 1 GHz	Power @ 1 GHz
12"	18"	24"	30"	0.195" dia.	36"	48"
\$281.81	\$282.45	\$283.11	\$283.75	\$284.41	\$285.70	See Web
Standard Semi-Rigid Cable Assemblies						
PE-047SR Coax, 50 Ohm						
Part No. <a href="#">PE34273</a>	1 piece price shown. See web or call for volume pricing.			Cable Dia.	Attn. @ 1 GHz	Power @ 1 GHz
6"	12"	18"	24"	0.098" dia.	40 dB/100ft	32 W
\$89.37	\$94.86	\$100.32	\$105.76	36"	48"	Custom Len.
\$89.37	\$94.86	\$100.32	\$105.76	\$115.07	\$125.82	See Web
PE-SR047AL Coax, 50 Ohm						
Part No. <a href="#">PE34277</a>	1 piece price shown. See web or call for volume pricing.			Cable Dia.	Attn. @ 1 GHz	Power @ 1 GHz
6"	12"	18"	24"	0.047" dia.	41 dB/100ft	32 W
\$88.78	\$93.62	\$98.49	\$103.31	36"	48"	Custom Len.
\$88.78	\$93.62	\$98.49	\$103.31	\$111.37	\$120.94	See Web
PE-SR402AL Coax, 50 Ohm						
Part No. <a href="#">PE34279</a>	1 piece price shown. See web or call for volume pricing.			Cable Dia.	Attn. @ 1 GHz	Power @ 1 GHz
6"	12"	18"	24"	0.141" dia.	13 dB/100ft	450 W
\$93.03	\$98.03	\$103.04	\$106.55	36"	48"	Custom Len.
\$93.03	\$98.03	\$103.04	\$106.55	\$116.45	\$126.31	See Web
PE-SR405AL Coax, 50 Ohm						
Part No. <a href="#">PE34284</a>	1 piece price shown. See web or call for volume pricing.			Cable Dia.	Attn. @ 1 GHz	Power @ 1 GHz
6"	12"	18"	24"	0.141" dia.	23 dB/100ft	130 W
\$88.85	\$93.40	\$98.03	\$102.65	36"	48"	Custom Len.
\$88.85	\$93.40	\$98.03	\$102.65	\$110.26	\$119.37	See Web
RG401/U Coax, 50 Ohm						
Part No. <a href="#">PE34271</a>	1 piece price shown. See web or call for volume pricing.			Cable Dia.	Attn. @ 1 GHz	Power @ 1 GHz
6"	12"	18"	24"	0.24" dia.	7.5 dB/100ft	870 W
\$187.57	\$199.51	\$192.95	\$204.47	36"	48"	Custom Len.
\$187.57	\$199.51	\$192.95	\$204.47	\$227.57	\$274.66	See Web

Cable Assemblies

See Our Website For Current Pricing & Real-Time Stock Availability!

For Custom Lengths, Metric Lengths or Special Configurations, Please call (949) 261-1920



Technical Support  
+1 (949) 261-1920



Same-Day Shipping,  
Even Custom Cable Assemblies

For our complete selection of cable assemblies, please visit our website

Cable Assemblies

See Our Website For Current Pricing & Real-Time Stock Availability!

RG402/U Coax, 50 Ohm						
Part No. <a href="#">PE3074</a>	Cable Dia.	Attn. @ 1 GHz	Power @ 1 GHz			
1 piece price shown. See web or call for volume pricing.						
6"	12"	18"	24"	36"	48"	Custom Len.
\$101.52	\$101.52	\$105.52	\$108.03	\$123.08	\$123.86	See Web
RG405/U Coax, 50 Ohm						
Part No. <a href="#">PE33391</a>	Cable Dia.	Attn. @ 1 GHz	Power @ 1 GHz			
1 piece price shown. See web or call for volume pricing.						
6"	12"	18"	24"	36"	48"	Custom Len.
\$87.84	\$91.55	\$95.19	\$98.88	\$106.13	\$111.87	See Web
PE-SR401AL-STRAIGHT Coax, 50 Ohm						
Part No. <a href="#">PE34275</a>	Cable Dia.	Attn. @ 1 GHz	Power @ 1 GHz			
1 piece price shown. See web or call for volume pricing.						
6"	12"	18"	24"	36"	48"	Custom Len.
\$167.84	\$177.35	\$186.90	\$196.42	\$215.48	\$234.54	See Web
TNC MALE TO TNC MALE RIGHT ANGLE						
Low Loss Flexible Cable Assemblies						
LMR-195 Coax, 50 Ohm						
Part No. <a href="#">PE3C0058</a>	Cable Dia.	Attn. @ 1 GHz	Power @ 1 GHz			
1 piece price shown. See web or call for volume pricing.						
12"	24"	36"	48"	60"	-	Custom Len.
\$54.56	\$55.38	\$56.22	\$57.08	\$57.91	-	See Web
PE-P160LL Coax, 50 Ohm						
Part No. <a href="#">PE3C5252</a>	Cable Dia.	Attn. @ 1 GHz	Power @ 1 GHz			
1 piece price shown. See web or call for volume pricing.						
12"	24"	36"	48"	60"	50CM	Custom Len.
\$286.46	\$308.91	\$331.37	\$353.83	\$376.28	\$300.85	See Web
PE-P142LL-27478 Coax, 50 Ohm						
Part No. <a href="#">PE3M0161</a>	Cable Dia.	Attn. @ 1 GHz	Power @ 1 GHz			
1 piece price shown. See web or call for volume pricing.						
12"	18"	24"	36"	48"	60"	Custom Len.
\$534.98	\$544.17	\$553.36	\$571.74	\$590.12	\$608.51	See Web
PE-P160LL-27478 Coax, 50 Ohm						
Part No. <a href="#">PE3M0206</a>	Cable Dia.	Attn. @ 1 GHz	Power @ 1 GHz			
1 piece price shown. See web or call for volume pricing.						
8"	12"	18"	24"	30"	36"	Custom Len.
\$489.78	\$495.07	\$503.06	\$511.01	\$518.99	\$526.95	See Web
PE-P300LL-27478 Coax, 50 Ohm						
Part No. <a href="#">PE3M0239</a>	Cable Dia.	Attn. @ 1 GHz	Power @ 1 GHz			
1 piece price shown. See web or call for volume pricing.						
12"	18"	24"	36"	48"	60"	Custom Len.
\$601.05	\$616.40	\$631.73	\$662.41	\$693.11	\$723.79	See Web
Precision Formable Cable Assemblies						
PE-SR402FL Coax, 50 Ohm						
Part No. <a href="#">PE39481</a>	Cable Dia.	Attn. @ 1 GHz	Power @ 1 GHz			
1 piece price shown. See web or call for volume pricing.						
6"	9"	12"	18"	24"	-	Custom Len.
Call	\$49.36	\$51.45	\$65.69	\$63.94	-	See Web
PE-SR402FLJ Coax, 50 Ohm						
Part No. <a href="#">PE39495</a>	Cable Dia.	Attn. @ 1 GHz	Power @ 1 GHz			
1 piece price shown. See web or call for volume pricing.						
6"	9"	12"	18"	24"	-	Custom Len.
\$54.33	Call	\$54.33	Call	Call	-	See Web
PE-SR405FLJ Coax, 50 Ohm						
Part No. <a href="#">PE39487</a>	Cable Dia.	Attn. @ 1 GHz	Power @ 1 GHz			
1 piece price shown. See web or call for volume pricing.						
6"	9"	12"	18"	24"	-	Custom Len.
Call	Call	\$54.04	\$65.69	\$66.68	-	See Web
Low Loss Test Flexible Cable Assemblies						
PE-P142LL Coax, 50 Ohm						
Part No. <a href="#">PE346</a>	Cable Dia.	Attn. @ 1 GHz	Power @ 1 GHz			
1 piece price shown. See web or call for volume pricing.						
12"	24"	36"	48"	60"	50CM	Custom Len.
\$259.48	\$277.09	\$294.69	\$312.29	\$329.89	\$270.76	See Web
Standard Flexible Cable Assemblies						
RG142B/U Coax, 50 Ohm						
Part No. <a href="#">PE33867</a>	Cable Dia.	Attn. @ 1 GHz	Power @ 1 GHz			
1 piece price shown. See web or call for volume pricing.						
12"	24"	36"	48"	60"	-	Custom Len.
\$69.00	\$75.67	\$82.35	\$89.43	\$96.24	-	See Web
PE-P141EAM Coax, 50 Ohm						
Part No. <a href="#">PE3CA1044</a>	Cable Dia.	Attn. @ 1 GHz	Power @ 1 GHz			
1 piece price shown. See web or call for volume pricing.						
6"	12"	24"	36"	50CM	100CM	Custom Len.
Call	\$403.90	\$378.31	Call	Call	Call	See Web

TNC MALE TO TNC FEMALE						
Precision Formable Cable Assemblies						
PE-SR405FL Coax, 50 Ohm						
Part No. <a href="#">PE39474</a>	Cable Dia.	Attn. @ 1 GHz	Power @ 1 GHz			
1 piece price shown. See web or call for volume pricing.						
6"	9"	12"	18"	24"	22.5 dB/100ft	130 W
\$50.50	Call	Call	\$57.81	\$63.69	-	Custom Len. See Web
PE-SR405FLJ Coax, 50 Ohm						
Part No. <a href="#">PE39488</a>	Cable Dia.	Attn. @ 1 GHz	Power @ 1 GHz			
1 piece price shown. See web or call for volume pricing.						
6"	9"	12"	18"	24"	0.098" dia.	19.5 dB/100ft
\$51.10	Call	\$51.57	\$55.37	\$59.63	-	Custom Len. See Web
Standard Formable Cable Assemblies						
PE-SR402FLJ Coax, 50 Ohm						
Part No. <a href="#">PE39496</a>	Cable Dia.	Attn. @ 1 GHz	Power @ 1 GHz			
1 piece price shown. See web or call for volume pricing.						
6"	9"	12"	18"	24"	0.161" dia.	11.89 dB/100ft
\$51.37	\$51.37	\$51.37	\$58.51	\$59.19	-	Custom Len. See Web
TNC MALE TO TNC FEMALE BULKHEAD						
Low Loss Flexible Cable Assemblies						
LMR-195 Coax, 50 Ohm						
Part No. <a href="#">PE3W00780</a>	Cable Dia.	Attn. @ 1 GHz	Power @ 1 GHz			
1 piece price shown. See web or call for volume pricing.						
12"	24"	36"	48"	60"	50CM	Custom Len.
\$42.70	\$42.79	\$42.86	\$42.95	\$43.04	\$42.75	See Web
PE-P142LL-27478 Coax, 50 Ohm						
Part No. <a href="#">PE3M0160</a>	Cable Dia.	Attn. @ 1 GHz	Power @ 1 GHz			
1 piece price shown. See web or call for volume pricing.						
12"	18"	24"	36"	48"	60"	Custom Len.
\$504.81	\$514.01	\$523.19	\$541.58	\$559.96	\$578.34	See Web
PE-P160LL-27478 Coax, 50 Ohm						
Part No. <a href="#">PE3M0205</a>	Cable Dia.	Attn. @ 1 GHz	Power @ 1 GHz			
1 piece price shown. See web or call for volume pricing.						
8"	12"	18"	24"	30"	36"	Custom Len.
\$485.51	\$490.80	\$498.79	\$506.74	\$514.72	\$522.69	See Web
Standard Formable Cable Assemblies						
PE-SR402FLJ Coax, 50 Ohm						
Part No. <a href="#">PE3W06580</a>	Cable Dia.	Attn. @ 1 GHz	Power @ 1 GHz			
1 piece price shown. See web or call for volume pricing.						
12"	24"	36"	48"	60"	50CM	Custom Len.
Call	Call	Call	Call	Call	Call	See Web
Standard Flexible Cable Assemblies						
PE-P141EAM Coax, 50 Ohm						
Part No. <a href="#">PE3CA1046</a>	Cable Dia.	Attn. @ 1 GHz	Power @ 1 GHz			
1 piece price shown. See web or call for volume pricing.						
12"	24"	36"	50CM	100CM	-	Custom Len.
\$391.29	Call	\$384.74	Call	Call	-	See Web
TNC MALE TO REVERSE POLARITY TNC MALE						
Low Loss Flexible Cable Assemblies						
PE-C195 Coax, 50 Ohm						
Part No. <a href="#">PE37137</a>	Cable Dia.	Attn. @ 1 GHz	Power @ 1 GHz			
1 piece price shown. See web or call for volume pricing.						
12"	24"	36"	48"	60"	-	Custom Len.
\$37.20	\$37.93	\$38.67	\$43.55	\$40.14	-	See Web
Standard Flexible Cable Assemblies						
RG58C/U Coax, 50 Ohm						
Part No. <a href="#">PE35228</a>	Cable Dia.	Attn. @ 1 GHz	Power @ 1 GHz			
1 piece price shown. See web or call for volume pricing.						
12"	24"	36"	48"	60"	72"	Custom Len.
\$44.65	\$42.93	\$43.79	\$44.60	\$45.39	\$49.25	See Web
RG142B/U Coax, 50 Ohm						
Part No. <a href="#">PE35230</a>	Cable Dia.	Attn. @ 1 GHz	Power @ 1 GHz			
1 piece price shown. See web or call for volume pricing.						
12"	24"	36"	48"	60"	72"	Custom Len.
\$50.59	\$56.43	\$62.73	\$69.04	\$75.32	\$81.63	See Web
RG213/U Coax, 50 Ohm						
Part No. <a href="#">PE35232</a>	Cable Dia.	Attn. @ 1 GHz	Power @ 1 GHz			
1 piece price shown. See web or call for volume pricing.						
12"	24"	36"	48"	60"	72"	Custom Len.
\$72.95	\$74.78	\$76.65	\$78.49	\$80.34	\$82.11	See Web

\*Coax Performance at 1 GHz Notes: Cable assembly max frequency may be lower than connector or coax max frequency



For our complete selection of cable assemblies, please visit our website

RG214/U Coax, 50 Ohm							
Part No. <a href="#">PE35234</a>				Cable Dia.	Attn. @ 1 GHz	Power @ 1 GHz	
1 piece price shown. See web or call for volume pricing.				0.425" dia.	7.32 dB/100ft	190 W	
12"	24"	36"	48"	60"	72"	Custom Len.	
\$89.97	\$98.10	\$114.46	\$112.74	\$120.73	\$128.74	See Web	

RG223/U Coax, 50 Ohm							
Part No. <a href="#">PE35236</a>				Cable Dia.	Attn. @ 1 GHz	Power @ 1 GHz	
1 piece price shown. See web or call for volume pricing.				0.21" dia.	13.4 dB/100ft	53 W	
12"	24"	36"	48"	60"	72"	Custom Len.	
\$47.46	\$48.05	\$51.26	\$54.02	\$57.17	\$64.48	See Web	

RG316/U Coax, 50 Ohm							
Part No. <a href="#">PE35238</a>				Cable Dia.	Attn. @ 1 GHz	Power @ 1 GHz	
1 piece price shown. See web or call for volume pricing.				0.098" dia.	38 dB/100ft	160 W	
12"	24"	36"	48"	60"	72"	Custom Len.	
\$68.00	\$71.28	\$74.61	\$77.89	\$81.19	\$84.49	See Web	

**REVERSE POLARITY TNC MALE TO BNC MALE**



**Standard Flexible Cable Assemblies**

RG58C/U Coax, 50 Ohm							
Part No. <a href="#">PE35229</a>				Cable Dia.	Attn. @ 1 GHz	Power @ 1 GHz	
1 piece price shown. See web or call for volume pricing.				0.195" dia.	20 dB/100ft	44 W	
12"	24"	36"	48"	60"	72"	Custom Len.	
\$45.68	\$46.49	\$47.31	\$48.14	\$48.96	\$49.75	See Web	

RG142B/U Coax, 50 Ohm							
Part No. <a href="#">PE35231</a>				Cable Dia.	Attn. @ 1 GHz	Power @ 1 GHz	
1 piece price shown. See web or call for volume pricing.				0.195" dia.	13 dB/100ft	650 W	
12"	24"	36"	48"	60"	72"	Custom Len.	
\$44.65	\$51.00	\$56.83	\$63.14	\$69.43	\$75.76	See Web	

RG213/U Coax, 50 Ohm							
Part No. <a href="#">PE35233</a>				Cable Dia.	Attn. @ 1 GHz	Power @ 1 GHz	
1 piece price shown. See web or call for volume pricing.				0.405" dia.	8 dB/100ft	190 W	
12"	24"	36"	48"	60"	72"	Custom Len.	
\$78.29	\$80.14	\$82.00	\$83.83	\$85.70	\$87.46	See Web	

RG214/U Coax, 50 Ohm							
Part No. <a href="#">PE34520</a>				Cable Dia.	Attn. @ 1 GHz	Power @ 1 GHz	
1 piece price shown. See web or call for volume pricing.				0.425" dia.	7.32 dB/100ft	190 W	
12"	24"	36"	48"	60"	72"	Custom Len.	
\$83.83	\$91.95	\$100.08	\$106.68	\$114.68	\$122.68	See Web	

RG223/U Coax, 50 Ohm							
Part No. <a href="#">PE35235</a>				Cable Dia.	Attn. @ 1 GHz	Power @ 1 GHz	
1 piece price shown. See web or call for volume pricing.				0.21" dia.	13.4 dB/100ft	53 W	
12"	24"	36"	48"	60"	72"	Custom Len.	
\$38.39	\$41.60	\$44.85	\$48.13	\$51.32	\$54.08	See Web	

RG316/U Coax, 50 Ohm							
Part No. <a href="#">PE3C3414</a>				Cable Dia.	Attn. @ 1 GHz	Power @ 1 GHz	
1 piece price shown. See web or call for volume pricing.				0.102" dia.	38 dB/100ft	160 W	
12"	24"	36"	48"	60"	72"	Custom Len.	
\$54.13	\$57.31	\$60.47	\$63.66	\$66.84	\$70.00	See Web	

**TNC MALE RIGHT ANGLE TO N MALE**



**Low Loss Flexible Cable Assemblies**

PE-P142LL Coax, 50 Ohm							
Part No. <a href="#">PE3C1041</a>				Cable Dia.	Attn. @ 1 GHz	Power @ 1 GHz	
1 piece price shown. See web or call for volume pricing.				0.195" dia.	10 dB/100ft	450 W	
12"	24"	36"	48"	60"	50CM	Custom Len.	
\$247.33	\$264.93	\$267.51	\$284.59	\$301.67	\$244.29	See Web	

PE-P142LL-27478 Coax, 50 Ohm							
Part No. <a href="#">PE3M0171</a>				Cable Dia.	Attn. @ 1 GHz	Power @ 1 GHz	
1 piece price shown. See web or call for volume pricing.				0.195" dia.		450 W	
12"	18"	24"	36"	48"	60"	Custom Len.	
\$525.93	\$535.12	\$544.31	\$562.70	\$581.08	\$599.46	See Web	

PE-P160LL-27478 Coax, 50 Ohm							
Part No. <a href="#">PE3M0216</a>				Cable Dia.	Attn. @ 1 GHz	Power @ 1 GHz	
1 piece price shown. See web or call for volume pricing.				0.16" dia.		450 W	
8"	12"	18"	24"	30"	36"	Custom Len.	
\$475.62	\$480.94	\$488.90	\$496.87	\$504.85	\$512.81	See Web	

PE-P300LL-27478 Coax, 50 Ohm							
Part No. <a href="#">PE3M0244</a>				Cable Dia.	Attn. @ 1 GHz	Power @ 1 GHz	
1 piece price shown. See web or call for volume pricing.				0.3" dia.		450 W	
12"	18"	24"	36"	48"	60"	Custom Len.	
\$605.38	\$620.72	\$636.07	\$666.74	\$697.43	\$728.11	See Web	

**TNC MALE RIGHT ANGLE TO N MALE RIGHT ANGLE**



**Low Loss Flexible Cable Assemblies**

PE-P142LL-27478 Coax, 50 Ohm							
Part No. <a href="#">PE3M0173</a>				Cable Dia.	Attn. @ 1 GHz	Power @ 1 GHz	
1 piece price shown. See web or call for volume pricing.				0.195" dia.		450 W	
12"	18"	24"	36"	48"	60"	Custom Len.	
\$650.65	\$659.83	\$669.02	\$687.41	\$705.79	\$724.17	See Web	

PE-P160LL-27478 Coax, 50 Ohm							
Part No. <a href="#">PE3M0218</a>				Cable Dia.	Attn. @ 1 GHz	Power @ 1 GHz	
1 piece price shown. See web or call for volume pricing.				0.16" dia.		450 W	
8"	12"	18"	24"	30"	36"	Custom Len.	
\$581.93	\$587.24	\$595.22	\$603.18	\$611.16	\$619.11	See Web	

PE-P300LL-27478 Coax, 50 Ohm							
Part No. <a href="#">PE3M0246</a>				Cable Dia.	Attn. @ 1 GHz	Power @ 1 GHz	
1 piece price shown. See web or call for volume pricing.				0.3" dia.		450 W	
12"	18"	24"	36"	48"	60"	Custom Len.	
\$762.51	\$777.86	\$793.20	\$823.88	\$854.57	\$885.25	See Web	

**TNC MALE RIGHT ANGLE TO N FEMALE BULKHEAD**



SEE MOUNTING HOLE SECTION ON PAGE 409

**Low Loss Flexible Cable Assemblies**

PE-P142LL-27478 Coax, 50 Ohm							
Part No. <a href="#">PE3M0172</a>				Cable Dia.	Attn. @ 1 GHz	Power @ 1 GHz	
1 piece price shown. See web or call for volume pricing.				0.195" dia.		450 W	
12"	18"	24"	36"	48"	60"	Custom Len.	
\$620.47	\$629.66	\$638.86	\$657.24	\$675.62	\$694.01	See Web	

PE-P160LL-27478 Coax, 50 Ohm							
Part No. <a href="#">PE3M0217</a>				Cable Dia.	Attn. @ 1 GHz	Power @ 1 GHz	
1 piece price shown. See web or call for volume pricing.				0.16" dia.		450 W	
8"	12"	18"	24"	30"	36"	Custom Len.	
\$586.19	\$591.52	\$599.47	\$607.45	\$615.42	\$623.38	See Web	

PE-P300LL-27478 Coax, 50 Ohm							
Part No. <a href="#">PE3M0245</a>				Cable Dia.	Attn. @ 1 GHz	Power @ 1 GHz	
1 piece price shown. See web or call for volume pricing.				0.3" dia.		450 W	
12"	18"	24"	36"	48"	60"	Custom Len.	
\$687.42	\$702.76	\$718.10	\$748.79	\$779.48	\$810.16	See Web	

**TNC MALE RIGHT ANGLE TO TNC MALE**



**Standard Formable Cable Assemblies**

PE-SR405FL Coax, 50 Ohm							
Part No. <a href="#">PE39473</a>				Cable Dia.	Attn. @ 1 GHz	Power @ 1 GHz	
1 piece price shown. See web or call for volume pricing.				22.5 dB/100ft		105 W	
6"	9"	12"	18"	24"	-	Custom Len.	
Call	\$51.73	Call	Call	Call	-	See Web	

**Standard Semi-Rigid Cable Assemblies**

PE-SR402AL Coax, 50 Ohm							
Part No. <a href="#">PE3W07649</a>				Cable Dia.	Attn. @ 1 GHz	Power @ 1 GHz	
1 piece price shown. See web or call for volume pricing.						450 W	
12"	24"	36"	48"	60"	50CM	Custom Len.	
\$75.52	\$86.38	\$97.25	\$106.60	\$117.31	\$82.48	See Web	

**TNC MALE RIGHT ANGLE TO TNC MALE RIGHT ANGLE**



**Low Loss Flexible Cable Assemblies**

PE-P142LL Coax, 50 Ohm							
Part No. <a href="#">PE3C1144</a>				Cable Dia.	Attn. @ 1 GHz	Power @ 1 GHz	
1 piece price shown. See web or call for volume pricing.				0.195" dia.	7.2 dB/100ft	450 W	
12"	24"	36"	48"	60"	50CM	Custom Len.	
\$353.28	\$370.88	\$388.46	\$406.08	\$423.68	\$364.55	See Web	

PE-P160LL Coax, 50 Ohm							
Part No. <a href="#">PE3C5250</a>				Cable Dia.	Attn. @ 1 GHz	Power @ 1 GHz	
1 piece price shown. See web or call for volume pricing.				0.16" dia.		450 W	
12"	24"	36"	48"	60"	50CM	Custom Len.	
\$350.17	\$372.63	\$395.08	\$417.54	\$439.99	\$364.55	See Web	

PE-P142LL-27478 Coax, 50 Ohm							
Part No. <a href="#">PE3M0170</a>				Cable Dia.	Attn. @ 1 GHz	Power @ 1 GHz	
1 piece price shown. See web or call for volume pricing.				0.195" dia.		450 W	
12"	18"	24"	36"	48"	60"	Custom Len.	
\$650.65	\$659.88	\$669.02	\$687.41	\$705.79	\$724.17	See Web	

PE-P160LL-27478 Coax, 50 Ohm							
Part No. <a href="#">PE3M0215</a>				Cable Dia.	Attn. @ 1 GHz	Power @ 1 GHz	
1 piece price shown. See web or call for volume pricing.				0.16" dia.		450 W	
8"	12"	18"	24"	30"	36"	Custom Len.	
\$581.93	\$587.24	\$595.22	\$603.18	\$611.16	\$619.11	See Web	

PE-P300LL-27478 Coax, 50 Ohm							
Part No. <a href="#">PE3M0243</a>				Cable Dia.	Attn. @ 1 GHz	Power @ 1 GHz	
1 piece price shown. See web or call for volume pricing.				0.3" dia.		450 W	
12"	18"	24"	36"	48"	60"	Custom Len.	
\$757.49	\$772.83	\$788.17	\$818.85	\$849.53	\$880.22	See Web	

Cable Assemblies

See Our Website For Current Pricing & Real-Time Stock Availability!

For Custom Lengths, Metric Lengths or Special Configurations, Please call (949) 261-1920



Technical Support  
+1 (949) 261-1920



Same-Day Shipping,  
Even Custom Cable Assemblies



For our complete selection of cable assemblies, please visit our website

Cable Assemblies

See Our Website For Current Pricing & Real-Time Stock Availability!

Precision Formable Cable Assemblies						
<b>PE-SR402FLJ Coax, 50 Ohm</b>						
Part No. <a href="#">PE39494</a>	Cable Dia.	Attn. @ 1 GHz	Power @ 1 GHz			
1 piece price shown. See web or call for volume pricing.	0.161" dia.	11.89 dB/100ft	450 W			
6"	9"	12"	18"	24"	Custom Len.	
\$56.76	\$56.76	\$56.76	Call	Call	See Web	
<b>PE-SR405FL Coax, 50 Ohm</b>						
Part No. <a href="#">PE39472</a>	Cable Dia.	Attn. @ 1 GHz	Power @ 1 GHz			
1 piece price shown. See web or call for volume pricing.	0.195" dia.	22.5 dB/100ft	130 W			
6"	9"	12"	18"	24"	Custom Len.	
Call	Call	Call	Call	Call	See Web	
<b>PE-SR405FLJ Coax, 50 Ohm</b>						
Part No. <a href="#">PE39486</a>	Cable Dia.	Attn. @ 1 GHz	Power @ 1 GHz			
1 piece price shown. See web or call for volume pricing.	0.098" dia.	19.5 dB/100ft	130 W			
6"	9"	12"	18"	24"	Custom Len.	
\$71.00	Call	\$28.45	Call	Call	See Web	
Standard Formable Cable Assemblies						
<b>PE-SR402FL Coax, 50 Ohm</b>						
Part No. <a href="#">PE39480</a>	Cable Dia.	Attn. @ 1 GHz	Power @ 1 GHz			
1 piece price shown. See web or call for volume pricing.	0.195" dia.	11.88 dB/100ft	450 W			
6"	9"	12"	18"	24"	Custom Len.	
\$67.88	Call	Call	Call	\$76.16	See Web	
Standard Flexible Cable Assemblies						
<b>RG142B/U Coax, 50 Ohm</b>						
Part No. <a href="#">PE3194</a>	Cable Dia.	Attn. @ 1 GHz	Power @ 1 GHz			
1 piece price shown. See web or call for volume pricing.	0.195" dia.	12.9 dB/100ft	Custom Len.			
12"	24"	36"	48"	-	Custom Len.	
\$87.04	\$93.73	\$94.73	\$101.04	-	See Web	
<b>RG400/U Coax, 50 Ohm</b>						
Part No. <a href="#">PE3W00037</a>	Cable Dia.	Attn. @ 1 GHz	Power @ 1 GHz			
1 piece price shown. See web or call for volume pricing.	0.195" dia.	14.7 dB/100ft	650 W			
12"	24"	36"	48"	60"	50CM Custom Len.	
\$102.78	\$109.58	\$117.85	\$126.11	\$134.37	\$106.63 See Web	
<b>PE-P141EAM Coax, 50 Ohm</b>						
Part No. <a href="#">PE3CA1045</a>	Cable Dia.	Attn. @ 1 GHz	Power @ 1 GHz			
1 piece price shown. See web or call for volume pricing.	0.163" dia.	-	Custom Len.			
12"	24"	36"	50CM	100CM	Custom Len.	
Call	Call	Call	Call	Call	See Web	
TNC MALE RIGHT ANGLE TO TNC FEMALE						
<b>Low Loss Flexible Cable Assemblies</b>						
<b>LMR-240 Coax, 50 Ohm</b>						
Part No. <a href="#">PE3W06709</a>	Cable Dia.	Attn. @ 1 GHz	Power @ 1 GHz			
1 piece price shown. See web or call for volume pricing.	0.24" dia.	8 dB/100ft	Custom Len.			
12"	18"	24"	36"	48"	60" Custom Len.	
\$60.90	\$59.07	\$59.55	\$60.47	\$61.41	\$62.35 See Web	
TNC MALE RIGHT ANGLE TO TNC FEMALE BULKHEAD						
SEE MOUNTING HOLE SECTION ON PAGE 409						
<b>Low Loss Flexible Cable Assemblies</b>						
<b>PE-P160LL Coax, 50 Ohm</b>						
Part No. <a href="#">PE3C5254</a>	Cable Dia.	Attn. @ 1 GHz	Power @ 1 GHz			
1 piece price shown. See web or call for volume pricing.	0.16" dia.	-	Custom Len.			
12"	24"	36"	48"	60"	50CM Custom Len.	
\$314.95	\$332.36	\$354.47	\$376.60	\$398.70	\$324.39 See Web	
TNC FEMALE TO SMA MALE						
<b>Standard Flexible Cable Assemblies</b>						
<b>RG55B/U Coax, 53 Ohm</b>						
Part No. <a href="#">PE3W07646</a>	Cable Dia.	Attn. @ 1 GHz	Power @ 1 GHz			
1 piece price shown. See web or call for volume pricing.	0.202" dia.	-	53 W			
12"	24"	36"	48"	60"	50CM Custom Len.	
\$46.53	\$49.61	\$52.68	\$55.26	\$58.30	\$48.50 See Web	
TNC FEMALE TO TNC MALE						
<b>Standard Formable Cable Assemblies</b>						
<b>PE-SR402FL Coax, 50 Ohm</b>						
Part No. <a href="#">PE39482</a>	Cable Dia.	Attn. @ 1 GHz	Power @ 1 GHz			
1 piece price shown. See web or call for volume pricing.	-	12 dB/100ft	400 W			
6"	9"	12"	18"	24"	Custom Len.	
Call	Call	\$51.57	\$62.40	\$63.06	See Web	

TNC FEMALE TO TNC FEMALE						
<b>Standard Flexible Cable Assemblies</b>						
<b>RG142B/U Coax, 50 Ohm</b>						
Part No. <a href="#">PE35480</a>	Cable Dia.	Attn. @ 1 GHz	Power @ 1 GHz			
1 piece price shown. See web or call for volume pricing.	0.195" dia.	13 dB/100ft	650 W			
12"	24"	36"	48"	60"	50CM Custom Len.	
\$53.12	\$59.01	\$65.38	\$71.75	\$78.12	\$50.81 See Web	
TNC FEMALE TO REVERSE POLARITY TNC MALE						
<b>Standard Flexible Cable Assemblies</b>						
<b>LMR-195 Coax, 50 Ohm</b>						
Part No. <a href="#">PE3C7597</a>	Cable Dia.	Attn. @ 1 GHz	Power @ 1 GHz			
1 piece price shown. See web or call for volume pricing.	0.195" dia.	11.8 dB/100ft	Custom Len.			
12"	24"	36"	48"	60"	50CM Custom Len.	
\$42.32	\$43.04	\$43.76	\$44.49	\$45.21	\$42.79 See Web	
REVERSE POLARITY TNC FEMALE TO REVERSE POLARITY SMA MALE						
<b>Standard Flexible Cable Assemblies</b>						
<b>RG55B/U Coax, 53 Ohm</b>						
Part No. <a href="#">PE3W07647</a>	Cable Dia.	Attn. @ 1 GHz	Power @ 1 GHz			
1 piece price shown. See web or call for volume pricing.	0.202" dia.	16.5 dB/100ft	53 W			
12"	24"	36"	48"	60"	50CM Custom Len.	
\$52.47	\$55.04	\$58.09	\$61.14	\$64.19	\$54.44 See Web	
TNC FEMALE BULKHEAD TO MCX PLUG RIGHT ANGLE						
SEE MOUNTING HOLE SECTION ON PAGE 409						
<b>Precision Formable Cable Assemblies</b>						
<b>PE-SR405FL Coax, 50 Ohm</b>						
Part No. <a href="#">PE39477</a>	Cable Dia.	Attn. @ 1 GHz	Power @ 1 GHz			
1 piece price shown. See web or call for volume pricing.	-	22.5 dB/100ft	130 W			
6"	9"	12"	15"	18"	24" Custom Len.	
\$19.99	\$23.01	\$26.04	Call	\$73.56	Call See Web	
<b>PE-SR405FLJ Coax, 50 Ohm</b>						
Part No. <a href="#">PE39491</a>	Cable Dia.	Attn. @ 1 GHz	Power @ 1 GHz			
1 piece price shown. See web or call for volume pricing.	0.098" dia.	19.5 dB/100ft	130 W			
6"	9"	12"	18"	24"	Custom Len.	
\$45.94	\$47.40	\$49.61	\$50.08	\$54.21	See Web	
<b>Standard Flexible Cable Assemblies</b>						
<b>RG174A/U Coax, 50 Ohm</b>						
Part No. <a href="#">PE33799</a>	Cable Dia.	Attn. @ 1 GHz	Power @ 1 GHz			
1 piece price shown. See web or call for volume pricing.	0.1" dia.	32 dB/100ft	16 W			
12"	24"	36"	48"	60"	Custom Len.	
\$72.12	\$67.26	\$67.71	\$68.20	\$68.68	See Web	
TNC FEMALE BULKHEAD TO MMCX PLUG RIGHT ANGLE						
SEE MOUNTING HOLE SECTION ON PAGE 409						
<b>Precision Formable Cable Assemblies</b>						
<b>PE-SR405FL Coax, 50 Ohm</b>						
Part No. <a href="#">PE39478</a>	Cable Dia.	Attn. @ 1 GHz	Power @ 1 GHz			
1 piece price shown. See web or call for volume pricing.	-	22.5 dB/100ft	130 W			
6"	9"	12"	18"	24"	Custom Len.	
\$49.76	Call	\$55.37	Call	Call	See Web	
<b>Standard Formable Cable Assemblies</b>						
<b>PE-SR405FLJ Coax, 50 Ohm</b>						
Part No. <a href="#">PE39492</a>	Cable Dia.	Attn. @ 1 GHz	Power @ 1 GHz			
1 piece price shown. See web or call for volume pricing.	0.098" dia.	19.5 dB/100ft	130 W			
6"	9"	12"	18"	24"	Custom Len.	
\$47.58	\$49.88	\$52.17	\$56.40	\$61.10	See Web	
<b>Standard Flexible Cable Assemblies</b>						
<b>RG188A/U Coax, 50 Ohm</b>						
Part No. <a href="#">PE35635</a>	Cable Dia.	Attn. @ 1 GHz	Power @ 1 GHz			
1 piece price shown. See web or call for volume pricing.	0.11" dia.	26 dB/100ft	160 W			
12"	24"	36"	48"	60"	Custom Len.	
\$79.32	\$82.06	\$84.80	\$80.77	\$83.21	See Web	
<b>RG316/U Coax, 50 Ohm</b>						
Part No. <a href="#">PE3W04293</a>	Cable Dia.	Attn. @ 1 GHz	Power @ 1 GHz			
1 piece price shown. See web or call for volume pricing.	0.098" dia.	38 dB/100ft	160 W			
12"	24"	36"	48"	60"	50CM Custom Len.	
\$92.61	\$96.21	\$99.83	\$103.44	\$107.04	\$94.93 See Web	

\*Coax Performance at 1 GHz Notes: Cable assembly max frequency may be lower than connector or coax max frequency

For our complete selection of cable assemblies, please visit our website

<b>TNC FEMALE BULKHEAD TO N MALE</b>						
SEE MOUNTING HOLE SECTION ON PAGE 409						
<b>Low Loss Flexible Cable Assemblies</b>						
PE-P142LL-27478 Coax, 50 Ohm						
Part No. <a href="#">PE3M0167</a>	Cable Dia.	Attn. @ 1 GHz	Power @ 1 GHz			
1 piece price shown. See web or call for volume pricing.						
12"	18"	24"	36"	48"	60"	Custom Len.
\$495.75	\$504.94	\$514.13	\$532.53	\$550.90	\$569.29	See Web
PE-P160LL-27478 Coax, 50 Ohm						
Part No. <a href="#">PE3M0212</a>	Cable Dia.	Attn. @ 1 GHz	Power @ 1 GHz			
1 piece price shown. See web or call for volume pricing.						
8"	12"	18"	24"	30"	36"	Custom Len.
\$471.35	\$476.67	\$484.63	\$492.60	\$500.58	\$508.55	See Web
<b>TNC FEMALE BULKHEAD TO N MALE RIGHT ANGLE</b>						
SEE MOUNTING HOLE SECTION ON PAGE 409						
<b>Low Loss Flexible Cable Assemblies</b>						
PE-P142LL-27478 Coax, 50 Ohm						
Part No. <a href="#">PE3M0169</a>	Cable Dia.	Attn. @ 1 GHz	Power @ 1 GHz			
1 piece price shown. See web or call for volume pricing.						
12"	18"	24"	36"	48"	60"	Custom Len.
\$620.47	\$629.66	\$638.86	\$657.24	\$675.62	\$694.01	See Web
PE-P160LL-27478 Coax, 50 Ohm						
Part No. <a href="#">PE3M0214</a>	Cable Dia.	Attn. @ 1 GHz	Power @ 1 GHz			
1 piece price shown. See web or call for volume pricing.						
8"	12"	18"	24"	30"	36"	Custom Len.
\$577.67	\$582.96	\$590.95	\$598.92	\$606.88	\$614.85	See Web
<b>TNC FEMALE BULKHEAD TO N FEMALE BULKHEAD</b>						
SEE MOUNTING HOLE SECTION ON PAGE 409						
<b>Low Loss Flexible Cable Assemblies</b>						
PE-P142LL-27478 Coax, 50 Ohm						
Part No. <a href="#">PE3M0168</a>	Cable Dia.	Attn. @ 1 GHz	Power @ 1 GHz			
1 piece price shown. See web or call for volume pricing.						
12"	18"	24"	36"	48"	60"	Custom Len.
\$590.30	\$599.49	\$608.67	\$627.07	\$645.45	\$663.83	See Web
PE-P160LL-27478 Coax, 50 Ohm						
Part No. <a href="#">PE3M0213</a>	Cable Dia.	Attn. @ 1 GHz	Power @ 1 GHz			
1 piece price shown. See web or call for volume pricing.						
8"	12"	18"	24"	30"	36"	Custom Len.
\$581.93	\$587.24	\$595.22	\$603.18	\$611.16	\$619.11	See Web
<b>TNC FEMALE BULKHEAD TO SMA MALE</b>						
SEE MOUNTING HOLE SECTION ON PAGE 409						
<b>Flexible Cable Assemblies</b>						
PE-P160LL Coax, 50 Ohm						
Part No. <a href="#">PE3C5260</a>	Cable Dia.	Attn. @ 1 GHz	Power @ 1 GHz			
1 piece price shown. See web or call for volume pricing.						
12"	24"	36"	48"	60"	50CM	Custom Len.
\$251.25	\$273.71	\$296.15	\$318.61	\$341.07	\$265.63	See Web
<b>TNC FEMALE BULKHEAD TO SMA MALE RIGHT ANGLE</b>						
SEE MOUNTING HOLE SECTION ON PAGE 409						
<b>Standard Formable Cable Assemblies</b>						
PE-SR405FLJ Coax, 50 Ohm						
Part No. <a href="#">PE3W03175</a>	Cable Dia.	Attn. @ 1 GHz	Power @ 1 GHz			
1 piece price shown. See web or call for volume pricing.						
12"	18"	24"	36"	48"	60"	Custom Len.
\$78.25	\$80.07	\$84.80	\$94.28	\$103.75	\$111.66	See Web
<b>Standard Flexible Cable Assemblies</b>						
RG174A/U Coax, 50 Ohm						
Part No. <a href="#">PE3W03417</a>	Cable Dia.	Attn. @ 1 GHz	Power @ 1 GHz			
1 piece price shown. See web or call for volume pricing.						
12"	24"	36"	48"	60"	50CM	Custom Len.
\$71.57	\$72.18	\$72.81	\$73.42	\$74.04	\$71.95	See Web
RG178B/U Coax, 50 Ohm						
Part No. <a href="#">PE3W05425</a>	Cable Dia.	Attn. @ 1 GHz	Power @ 1 GHz			
1 piece price shown. See web or call for volume pricing.						
12"	24"	36"	48"	60"	50CM	Custom Len.
\$76.67	\$77.91	\$79.15	\$80.39	\$81.64	\$77.45	See Web

<b>Standard Semi-Rigid Cable Assemblies</b>						
RG402/U Coax, 50 Ohm						
Part No. <a href="#">PE3W10767</a>	Cable Dia.	Attn. @ 1 GHz	Power @ 1 GHz			
1 piece price shown. See web or call for volume pricing.						
12"	24"	36"	48"	60"	50CM	Custom Len.
\$135.71	\$143.80	\$151.90	\$159.99	\$168.08	\$132.80	See Web
<b>TNC FEMALE BULKHEAD TO SMC PLUG RIGHT ANGLE</b>						
SEE MOUNTING HOLE SECTION ON PAGE 409						
<b>Standard Flexible Cable Assemblies</b>						
RG174A/U Coax, 50 Ohm						
Part No. <a href="#">PE36779</a>	Cable Dia.	Attn. @ 1 GHz	Power @ 1 GHz			
1 piece price shown. See web or call for volume pricing.						
12"	24"	36"	48"	60"	-	Custom Len.
\$83.92	\$76.76	\$77.25	\$77.73	\$78.21	-	See Web
<b>TNC FEMALE BULKHEAD TO SMP FEMALE RIGHT ANGLE</b>						
SEE MOUNTING HOLE SECTION ON PAGE 409						
<b>Standard Formable Cable Assemblies</b>						
PE-SR405FL Coax, 50 Ohm						
Part No. <a href="#">PE3W05541</a>	Cable Dia.	Attn. @ 1 GHz	Power @ 1 GHz			
1 piece price shown. See web or call for volume pricing.						
12"	24"	36"	48"	60"	50CM	Custom Len.
\$123.14	\$135.80	\$148.47	\$161.13	\$173.79	\$131.24	See Web
<b>TNC FEMALE BULKHEAD TO SSMC PLUG RIGHT ANGLE</b>						
SEE MOUNTING HOLE SECTION ON PAGE 409						
<b>Standard Flexible Cable Assemblies</b>						
RG188A/U Coax, 50 Ohm						
Part No. <a href="#">PE3W05752</a>	Cable Dia.	Attn. @ 1 GHz	Power @ 1 GHz			
1 piece price shown. See web or call for volume pricing.						
12"	24"	36"	48"	60"	50CM	Custom Len.
\$112.70	\$126.03	\$128.92	\$131.81	\$134.71	\$124.98	See Web
<b>TNC FEMALE BULKHEAD TO TNC MALE</b>						
SEE MOUNTING HOLE SECTION ON PAGE 409						
<b>Flexible Cable Assemblies</b>						
PE-P160LL Coax, 50 Ohm						
Part No. <a href="#">PE3C5253</a>	Cable Dia.	Attn. @ 1 GHz	Power @ 1 GHz			
1 piece price shown. See web or call for volume pricing.						
12"	24"	36"	48"	60"	50CM	Custom Len.
\$251.25	\$273.71	\$296.15	\$318.61	\$341.07	\$265.63	See Web
<b>Low Loss Flexible Cable Assemblies</b>						
PE-P142LL Coax, 50 Ohm						
Part No. <a href="#">PE348</a>	Cable Dia.	Attn. @ 1 GHz	Power @ 1 GHz			
1 piece price shown. See web or call for volume pricing.						
12"	24"	36"	48"	60"	50CM	Custom Len.
\$215.70	\$233.29	\$250.90	\$268.50	\$286.09	\$226.98	See Web
<b>TNC FEMALE BULKHEAD TO TNC MALE RIGHT ANGLE</b>						
SEE MOUNTING HOLE SECTION ON PAGE 409						
<b>Low Loss Flexible Cable Assemblies</b>						
PE-P142LL-27478 Coax, 50 Ohm						
Part No. <a href="#">PE3M0166</a>	Cable Dia.	Attn. @ 1 GHz	Power @ 1 GHz			
1 piece price shown. See web or call for volume pricing.						
12"	18"	24"	36"	48"	60"	Custom Len.
\$620.47	\$629.66	\$638.86	\$657.24	\$675.62	\$694.01	See Web
PE-P160LL-27478 Coax, 50 Ohm						
Part No. <a href="#">PE3M0211</a>	Cable Dia.	Attn. @ 1 GHz	Power @ 1 GHz			
1 piece price shown. See web or call for volume pricing.						
8"	12"	18"	24"	30"	36"	Custom Len.
\$577.67	\$582.96	\$590.95	\$598.92	\$606.88	\$614.85	See Web
<b>TNC FEMALE BULKHEAD TO TNC FEMALE BULKHEAD</b>						
SEE MOUNTING HOLE SECTION ON PAGE 409						
<b>Low Loss Flexible Cable Assemblies</b>						
PE-P142LL Coax, 50 Ohm						
Part No. <a href="#">PE3C2180</a>	Cable Dia.	Attn. @ 1 GHz	Power @ 1 GHz			
1 piece price shown. See web or call for volume pricing.						
12"	24"	36"	48"	60"	50CM	Custom Len.
\$255.05	\$272.66	\$290.26	\$307.86	\$325.47	\$266.33	See Web

Cable Assemblies

See Our Website For Current Pricing & Real-Time Stock Availability!

For Custom Lengths, Metric Lengths or Special Configurations, Please call (949) 261-1920



Technical Support  
+1 (949) 261-1920



Same-Day Shipping,  
Even Custom Cable Assemblies

For our complete selection of cable assemblies, please visit our website

Cable Assemblies  
See Our Website For Current Pricing & Real-Time Stock Availability!

PE-P160LL Coax, 50 Ohm						
Part No. <a href="#">PE3C5251</a>	Cable Dia.			Attn. @ 1 GHz	Power @ 1 GHz	
1 piece price shown. See web or call for volume pricing.						
12"	24"	36"	48"	60"	50CM	Custom Len.
\$279.74	\$302.20	\$324.65	\$347.11	\$369.56	\$294.13	See Web

PE-P142LL-27478 Coax, 50 Ohm						
Part No. <a href="#">PE3M0165</a>	Cable Dia.			Attn. @ 1 GHz	Power @ 1 GHz	
1 piece price shown. See web or call for volume pricing.						
12"	18"	24"	36"	48"	60"	Custom Len.
\$590.30	\$599.49	\$608.67	\$627.07	\$645.45	\$663.83	See Web

PE-P160LL-27478 Coax, 50 Ohm						
Part No. <a href="#">PE3M0210</a>	Cable Dia.			Attn. @ 1 GHz	Power @ 1 GHz	
1 piece price shown. See web or call for volume pricing.						
8"	12"	18"	24"	30"	36"	Custom Len.
\$573.39	\$578.70	\$586.68	\$594.65	\$602.61	\$610.58	See Web

**TNC FEMALE BULKHEAD TO UMCX PLUG RIGHT ANGLE**

SEE MOUNTING HOLE SECTION ON PAGE 409



**Standard Flexible Cable Assemblies**

RG178B/U Coax, 50 Ohm						
Part No. <a href="#">PE38304</a>	Cable Dia.			Attn. @ 1 GHz	Power @ 1 GHz	
1 piece price shown. See web or call for volume pricing.						
3"	6"	9"	12"	18"	24"	Custom Len.
\$58.58	\$60.46	\$62.36	\$64.24	\$64.66	\$68.70	See Web

**REVERSE POLARITY TNC FEMALE BULKHEAD TO MMCX PLUG**

SEE MOUNTING HOLE SECTION ON PAGE 409



**Low Loss Flexible Cable Assemblies**

LMR-100A-PVC Coax, 50 Ohm						
Part No. <a href="#">PE3W01379</a>	Cable Dia.			Attn. @ 1 GHz	Power @ 1 GHz	
1 piece price shown. See web or call for volume pricing.						
12"	24"	36"	48"	60"	50CM	Custom Len.
\$86.49	\$87.29	\$88.11	\$88.92	\$89.72	\$87.01	See Web

**REVERSE POLARITY TNC FEMALE BULKHEAD TO REVERSE POLARITY SMA MALE**

SEE MOUNTING HOLE SECTION ON PAGE 409



**Flexible Cable Assemblies**

LMR-100A-PVC Coax, 50 Ohm						
Part No. <a href="#">PE3W07758</a>	Cable Dia.			Attn. @ 1 GHz	Power @ 1 GHz	
1 piece price shown. See web or call for volume pricing.						
12"	24"	36"	48"	60"	50CM	Custom Len.
\$111.36	\$112.17	\$112.97	\$113.77	\$114.58	\$111.87	See Web

**REVERSE POLARITY TNC FEMALE BULKHEAD TO SSMC PLUG RIGHT ANGLE**

SEE MOUNTING HOLE SECTION ON PAGE 409



**Standard Flexible Cable Assemblies**

RG188A/U Coax, 50 Ohm						
Part No. <a href="#">PE3W05762</a>	Cable Dia.			Attn. @ 1 GHz	Power @ 1 GHz	
1 piece price shown. See web or call for volume pricing.						
12"	24"	36"	48"	60"	50CM	Custom Len.
\$103.09	\$106.02	\$107.44	\$110.34	\$113.23	\$104.96	See Web

**REVERSE POLARITY TNC FEMALE BULKHEAD TO REVERSE POLARITY TNC MALE**

SEE MOUNTING HOLE SECTION ON PAGE 409



**Standard Formable Cable Assemblies**

PE-SR402FLJ Coax, 50 Ohm						
Part No. <a href="#">PE3W05610</a>	Cable Dia.			Attn. @ 1 GHz	Power @ 1 GHz	
1 piece price shown. See web or call for volume pricing.						
12"	24"	36"	48"	60"	50CM	Custom Len.
\$90.60	\$100.37	\$108.60	\$118.23	\$127.87	\$96.85	See Web

**REVERSE POLARITY TNC FEMALE BULKHEAD TO UMCX PLUG**

SEE MOUNTING HOLE SECTION ON PAGE 409



**Standard Flexible Cable Assemblies**

RG178B/U Coax, 50 Ohm						
Part No. <a href="#">PE38303</a>	Cable Dia.			Attn. @ 1 GHz	Power @ 1 GHz	
1 piece price shown. See web or call for volume pricing.						
3"	6"	9"	12"	18"	24"	Custom Len.
\$58.90	\$58.90	\$58.90	\$61.25	\$62.95	\$66.99	See Web

**UHF MALE TO BNC MALE**



**Low Loss Flexible Cable Assemblies**

PE-C195 Coax, 50 Ohm						
Part No. <a href="#">PE38674</a>	Cable Dia.			Attn. @ 1 GHz	Power @ 1 GHz	
1 piece price shown. See web or call for volume pricing.						
12"	24"	36"	48"	60"	72"	Custom Len.
\$29.04	\$29.84	\$30.63	\$33.44	\$32.74	-	See Web

**Standard Flexible Cable Assemblies**

RG8A/U Coax, 50 Ohm						
Part No. <a href="#">PE34581</a>	Cable Dia.			Attn. @ 1 GHz	Power @ 1 GHz	
1 piece price shown. See web or call for volume pricing.						
12"	24"	36"	48"	60"	72"	Custom Len.
\$70.18	\$73.21	\$81.15	\$79.20	\$82.18	\$85.22	See Web

**RG58C/U Coax, 50 Ohm**

Part No. <a href="#">PE3057</a>	Cable Dia.			Attn. @ 1 GHz	Power @ 1 GHz	
1 piece price shown. See web or call for volume pricing.						
12"	24"	36"	48"	60"	72"	Custom Len.
\$40.43	\$41.34	\$42.23	\$43.19	\$44.11	\$45.03	See Web

**RG142B/U Coax, 50 Ohm**

Part No. <a href="#">PE3898</a>	Cable Dia.			Attn. @ 1 GHz	Power @ 1 GHz	
1 piece price shown. See web or call for volume pricing.						
12"	24"	36"	48"	60"	72"	Custom Len.
\$39.31	\$45.67	\$52.03	\$57.85	\$64.16	\$70.46	See Web

**RG213/U Coax, 50 Ohm**

Part No. <a href="#">PE34583</a>	Cable Dia.			Attn. @ 1 GHz	Power @ 1 GHz	
1 piece price shown. See web or call for volume pricing.						
12"	24"	36"	48"	60"	72"	Custom Len.
\$73.12	\$74.96	\$76.77	\$78.61	\$80.43	\$82.27	See Web

**RG214/U Coax, 50 Ohm**

Part No. <a href="#">PE33438</a>	Cable Dia.			Attn. @ 1 GHz	Power @ 1 GHz	
1 piece price shown. See web or call for volume pricing.						
12"	24"	36"	48"	60"	72"	Custom Len.
\$72.55	\$80.67	\$88.78	\$103.06	\$105.02	\$111.55	See Web

**RG223/U Coax, 50 Ohm**

Part No. <a href="#">PE3803</a>	Cable Dia.			Attn. @ 1 GHz	Power @ 1 GHz	
1 piece price shown. See web or call for volume pricing.						
12"	24"	36"	48"	60"	72"	Custom Len.
\$36.21	\$39.43	\$42.66	\$45.87	\$49.09	\$52.30	See Web

**RG225/U Coax, 50 Ohm**

Part No. <a href="#">PE34589</a>	Cable Dia.			Attn. @ 1 GHz	Power @ 1 GHz	
1 piece price shown. See web or call for volume pricing.						
12"	24"	36"	48"	60"	72"	Custom Len.
\$105.86	\$132.00	\$167.32	\$202.65	\$237.98	\$273.29	See Web

**RG393/U Coax, 50 Ohm**

Part No. <a href="#">PE34585</a>	Cable Dia.			Attn. @ 1 GHz	Power @ 1 GHz	
1 piece price shown. See web or call for volume pricing.						
12"	24"	36"	48"	60"	72"	Custom Len.
\$84.10	\$101.11	\$116.48	\$133.25	\$150.02	\$166.77	See Web

**RG400/U Coax, 50 Ohm**

Part No. <a href="#">PE3231</a>	Cable Dia.			Attn. @ 1 GHz	Power @ 1 GHz	
1 piece price shown. See web or call for volume pricing.						
12"	24"	36"	48"	60"	72"	Custom Len.
\$48.29	\$58.85	\$66.99	\$70.83	\$78.50	\$86.17	See Web

**PE-B400 Coax, 50 Ohm**

Part No. <a href="#">PE34579</a>	Cable Dia.			Attn. @ 1 GHz	Power @ 1 GHz	
1 piece price shown. See web or call for volume pricing.						
12"	24"	36"	48"	60"	72"	Custom Len.
\$68.39	\$70.18	\$71.94	\$73.75	\$75.53	\$77.29	See Web

**RG55B/U Coax, 53 Ohm**

Part No. <a href="#">PE34591</a>	Cable Dia.			Attn. @ 1 GHz	Power @ 1 GHz	
1 piece price shown. See web or call for volume pricing.						
12"	24"	36"	48"	60"	72"	Custom Len.
\$35.28	\$37.76	\$40.25	\$42.74	\$45.23	\$47.70	See Web

**RG59B/U Coax, 75 Ohm**

Part No. <a href="#">PE3543</a>	Cable Dia.			Attn. @ 1 GHz	Power @ 1 GHz	
1 piece price shown. See web or call for volume pricing.						
12"	24"	36"	48"	60"	72"	Custom Len.
\$31.87	\$32.87	\$33.86	\$34.85	\$35.88	\$36.86	See Web

**RG62A/U Coax, 93 Ohm**

Part No. <a href="#">PE34587</a>	Cable Dia.			Attn. @ 1 GHz	Power @ 1 GHz	
1 piece price shown. See web or call for volume pricing.						
12"	24"	36"	48"	60"	72"	Custom Len.
\$34.92	\$36.43	\$37.95	\$42.24	\$41.00	\$42.51	See Web

**UHF MALE TO UHF MALE**



**Low Loss Flexible Cable Assemblies**

\*Coax Performance at 1 GHz Notes: Cable assembly max frequency may be lower than connector or coax max frequency



For our complete selection of cable assemblies, please visit our website

PE-C195 Coax, 50 Ohm						
Part No. <a href="#">PE38632</a>	Cable Dia.	Attn. @ 1 GHz	Power @ 1 GHz			
1 piece price shown. See web or call for volume pricing.						
12"	24"	36"	48"	60"	-	Custom Len.
\$28.01	\$28.74	\$29.66	\$31.12	\$32.65	-	See Web
PE-C400 Coax, 50 Ohm						
Part No. <a href="#">PE35021</a>	Cable Dia.	Attn. @ 1 GHz	Power @ 1 GHz			
1 piece price shown. See web or call for volume pricing.						
12"	24"	36"	48"	60"	4.1 dB/100ft	550 W
\$55.37	\$57.50	\$62.77	\$68.07	\$73.35	-	See Web
Standard Flexible Cable Assemblies						
RG8A/U Coax, 50 Ohm						
Part No. <a href="#">PE3623</a>	Cable Dia.	Attn. @ 1 GHz	Power @ 1 GHz			
1 piece price shown. See web or call for volume pricing.						
12"	24"	36"	48"	60"	72"	Custom Len.
\$70.54	\$68.43	\$71.54	\$74.67	\$77.76	\$80.89	See Web
RG58C/U Coax, 50 Ohm						
Part No. <a href="#">PE3015</a>	Cable Dia.	Attn. @ 1 GHz	Power @ 1 GHz			
1 piece price shown. See web or call for volume pricing.						
12"	24"	36"	48"	60"	72"	Custom Len.
\$41.19	\$42.10	\$42.99	\$43.96	\$44.88	\$45.80	See Web
RG142B/U Coax, 50 Ohm						
Part No. <a href="#">PE33053</a>	Cable Dia.	Attn. @ 1 GHz	Power @ 1 GHz			
1 piece price shown. See web or call for volume pricing.						
12"	24"	36"	48"	60"	-	Custom Len.
\$41.20	\$47.94	\$54.19	\$57.42	\$63.74	-	See Web
RG213/U Coax, 50 Ohm						
Part No. <a href="#">PE3635</a>	Cable Dia.	Attn. @ 1 GHz	Power @ 1 GHz			
1 piece price shown. See web or call for volume pricing.						
12"	24"	36"	48"	60"	72"	Custom Len.
\$62.95	\$64.76	\$66.58	\$68.41	\$70.24	\$72.06	See Web
RG214/U Coax, 50 Ohm						
Part No. <a href="#">PE3796</a>	Cable Dia.	Attn. @ 1 GHz	Power @ 1 GHz			
1 piece price shown. See web or call for volume pricing.						
12"	24"	48"	60"	72"	-	Custom Len.
\$75.11	\$77.61	\$93.72	\$101.77	\$117.07	-	See Web
RG223/U Coax, 50 Ohm						
Part No. <a href="#">PE3845</a>	Cable Dia.	Attn. @ 1 GHz	Power @ 1 GHz			
1 piece price shown. See web or call for volume pricing.						
12"	24"	36"	48"	60"	72"	Custom Len.
\$34.99	\$38.21	\$41.44	\$44.66	\$47.87	\$51.08	See Web
RG393/U Coax, 50 Ohm						
Part No. <a href="#">PE33267</a>	Cable Dia.	Attn. @ 1 GHz	Power @ 1 GHz			
1 piece price shown. See web or call for volume pricing.						
12"	24"	36"	48"	60"	72"	Custom Len.
\$78.87	\$91.41	\$113.34	\$123.67	\$140.45	\$157.20	See Web
RG400/U Coax, 50 Ohm						
Part No. <a href="#">PE3743</a>	Cable Dia.	Attn. @ 1 GHz	Power @ 1 GHz			
1 piece price shown. See web or call for volume pricing.						
12"	24"	36"	48"	60"	-	Custom Len.
\$46.20	\$53.94	\$61.12	\$68.77	\$76.44	-	See Web
RG59B/U Coax, 75 Ohm						
Part No. <a href="#">PE3580</a>	Cable Dia.	Attn. @ 1 GHz	Power @ 1 GHz			
1 piece price shown. See web or call for volume pricing.						
12"	24"	36"	48"	60"	72"	Custom Len.
\$31.21	\$32.20	\$33.20	\$37.23	\$35.19	\$36.20	See Web

**HMCX32 1.2 PLUG TO HMCX32 1.2 PLUG**



**Standard Flexible Cable Assemblies**

**PE-81mm Coax, 50 Ohm**

Part No. <a href="#">PE3CA1058</a>	Cable Dia.	Attn. @ 1 GHz	Power @ 1 GHz			
1 piece price shown. See web or call for volume pricing.						
6"	9"	12"	2CM	-	-	Custom Len.
\$11.46	\$12.32	\$13.20	Call	-	-	See Web

**UMCX PLUG RIGHT ANGLE TO MCX PLUG**



**Standard Flexible Cable Assemblies**

**RG178B/U Coax, 50 Ohm**

Part No. <a href="#">PE38890</a>	Cable Dia.	Attn. @ 1 GHz	Power @ 1 GHz			
1 piece price shown. See web or call for volume pricing.						
3"	6"	9"	12"	18"	24"	Custom Len.
\$68.17	\$69.85	\$68.17	\$73.62	\$72.20	\$76.25	See Web

**UMCX PLUG RIGHT ANGLE TO MCX PLUG RIGHT ANGLE**



**Standard Flexible Cable Assemblies**

**RG178B/U Coax, 50 Ohm**

Part No. <a href="#">PE38502</a>	Cable Dia.	Attn. @ 1 GHz	Power @ 1 GHz			
1 piece price shown. See web or call for volume pricing.						
3"	6"	9"	12"	18"	24"	Custom Len.
\$63.00	\$64.26	\$63.00	\$63.00	\$67.04	\$71.09	See Web

**UMCX PLUG RIGHT ANGLE TO MCX JACK BULKHEAD**



SEE MOUNTING HOLE SECTION ON PAGE 409

**Standard Flexible Cable Assemblies**

**RG178B/U Coax, 50 Ohm**

Part No. <a href="#">PE38889</a>	Cable Dia.	Attn. @ 1 GHz	Power @ 1 GHz			
1 piece price shown. See web or call for volume pricing.						
3"	6"	9"	12"	18"	24"	Custom Len.
\$80.19	\$80.19	\$80.19	\$86.61	\$84.24	\$88.28	See Web

**PE-113mm Coax, 50 Ohm**

Part No. <a href="#">PE38298</a>	Cable Dia.	Attn. @ 1 GHz	Power @ 1 GHz			
1 piece price shown. See web or call for volume pricing.						
6"	12"	18"	-	-	-	Custom Len.
\$26.67	\$25.97	\$24.55	-	-	-	See Web

**UMCX PLUG RIGHT ANGLE TO REVERSE POLARITY MCX JACK BULKHEAD**



SEE MOUNTING HOLE SECTION ON PAGE 409

**Standard Flexible Cable Assemblies**

**RG178B/U Coax, 50 Ohm**

Part No. <a href="#">PE38302</a>	Cable Dia.	Attn. @ 1 GHz	Power @ 1 GHz			
1 piece price shown. See web or call for volume pricing.						
3"	6"	9"	12"	18"	24"	Custom Len.
\$82.15	\$82.15	\$82.15	\$82.15	\$86.21	\$90.25	See Web

**UMCX PLUG RIGHT ANGLE TO MMCX PLUG RIGHT ANGLE**



**Standard Flexible Cable Assemblies**

**RG178B/U Coax, 50 Ohm**

Part No. <a href="#">PE39078</a>	Cable Dia.	Attn. @ 1 GHz	Power @ 1 GHz			
1 piece price shown. See web or call for volume pricing.						
3"	6"	9"	12"	18"	24"	Custom Len.
\$69.11	\$70.99	\$72.88	\$74.76	\$78.64	\$82.54	See Web

**UMCX PLUG RIGHT ANGLE TO SSMB PLUG**



**Standard Flexible Cable Assemblies**

**RG178B/U Coax, 50 Ohm**

Part No. <a href="#">PE38930</a>	Cable Dia.	Attn. @ 1 GHz	Power @ 1 GHz			
1 piece price shown. See web or call for volume pricing.						
3"	6"	9"	12"	18"	24"	Custom Len.
\$107.73	\$107.73	\$107.73	\$107.73	\$112.53	\$126.73	See Web

**UMCX 2.1 PLUG TO UMCX 2.1 PLUG**



**Standard Flexible Cable Assemblies**

**PE-81mm Coax, 50 Ohm**

Part No. <a href="#">PE3CA1056</a>	Cable Dia.	Attn. @ 1 GHz	Power @ 1 GHz			
1 piece price shown. See web or call for volume pricing.						
6"	9"	12"	5CM	8CM	9CM	Custom Len.
\$9.26	\$11.27	\$11.94	Call	Call	Call	See Web

**UMCX 2.5 PLUG TO UMCX 2.5 PLUG**



**Standard Flexible Cable Assemblies**

**RG178B/U Coax, 50 Ohm**

Part No. <a href="#">PE3CA1054</a>	Cable Dia.	Attn. @ 1 GHz	Power @ 1 GHz			
1 piece price shown. See web or call for volume pricing.						
6"	9"	12"	-	-	-	Custom Len.
\$11.70	\$13.36	\$14.70	-	-	-	See Web

**RG178-DS Coax, 50 Ohm**

Part No. <a href="#">PE3CA1055</a>	Cable Dia.	Attn. @ 1 GHz	Power @ 1 GHz			
1 piece price shown. See web or call for volume pricing.						
6"	9"	12"	1000CM	-	-	Custom Len.
\$12.22	\$14.70	\$18.90	Call	-	-	See Web

For Custom Lengths, Metric Lengths or Special Configurations, Please call (949) 261-1920



Technical Support  
+1 (949) 261-1920



Same-Day Shipping,  
Even Custom Cable Assemblies

Cable Assemblies

See Our Website For Current Pricing & Real-Time Stock Availability!



For our complete selection of cable assemblies, please visit our website

Cable Assemblies

See Our Website For Current Pricing & Real-Time Stock Availability!

PE-81mm Coax, 50 Ohm						
Part No. <a href="#">PE3CA1051</a>	1 piece price shown. See web or call for volume pricing.			Cable Dia. 0.032" dia.	Attn. @ 1 GHz	Power @ 1 GHz
3"	6"	9"	12"	15"	36CM	Custom Len.
Call	\$8.91	\$9.69	\$15.83	Call	Call	See Web

PE-113mm Coax, 50 Ohm						
Part No. <a href="#">PE3CA1052</a>	1 piece price shown. See web or call for volume pricing.			Cable Dia. 0.044" dia.	Attn. @ 1 GHz	Power @ 1 GHz
1"	2"	3"	6"	9"	12"	Custom Len.
Call	Call	Call	\$10.20	\$10.07	\$11.94	See Web

PE-137mm Coax, 50 Ohm						
Part No. <a href="#">PE3CA1053</a>	1 piece price shown. See web or call for volume pricing.			Cable Dia. 0.053" dia.	Attn. @ 1 GHz	Power @ 1 GHz
6"	9"	12"	-	-	-	Custom Len.
\$10.64	\$11.46	\$12.46	-	-	-	See Web

23  
24  
25

**WMCX 1.6 PLUG TO WMCX 1.6 PLUG**

**Standard Flexible Cable Assemblies**

PE-81mm Coax, 50 Ohm						
Part No. <a href="#">PE3CA1057</a>	1 piece price shown. See web or call for volume pricing.			Cable Dia. 0.032" dia.	Attn. @ 1 GHz	Power @ 1 GHz
6"	9"	12"	-	-	-	Custom Len.
\$9.84	\$10.63	\$12.59	-	-	-	See Web

26

**NEX10 MALE TO NEX10 MALE**

**Low PIM Corrugated Cable Assemblies**

PE-1/4SFHC Coax, 50 Ohm						
Part No. <a href="#">PE3C7849</a>	1 piece price shown. See web or call for volume pricing.			Cable Dia. 0.303" dia.	Attn. @ 1 GHz	Power @ 1 GHz
12"	24"	36"	48"	60"	50CM	Custom Len.
\$69.11	\$72.84	\$76.57	\$80.29	\$84.02	\$71.50	See Web

27

SPP-250-LLPL Coax, 50 Ohm						
Part No. <a href="#">PE3C6253</a>	1 piece price shown. See web or call for volume pricing.			Cable Dia. 0.28" dia.	Attn. @ 1 GHz	Power @ 1 GHz
12"	24"	36"	48"	60"	50CM	Custom Len.
\$74.74	\$80.88	\$87.01	\$93.14	\$99.28	\$78.66	See Web

28

**NEX10 MALE TO NEX10 MALE RIGHT ANGLE**

**Low PIM Corrugated Cable Assemblies**

PE-1/4SFHC Coax, 50 Ohm						
Part No. <a href="#">PE3C7850</a>	1 piece price shown. See web or call for volume pricing.			Cable Dia. 0.303" dia.	Attn. @ 1 GHz	Power @ 1 GHz
12"	24"	36"	48"	60"	50CM	Custom Len.
\$74.61	\$78.34	\$82.06	\$85.79	\$89.52	\$77.00	See Web

29

**NEX10 MALE TO NEX10 FEMALE**

**Low PIM Corrugated Cable Assemblies**

PE-1/4SFHC Coax, 50 Ohm						
Part No. <a href="#">PE3C7851</a>	1 piece price shown. See web or call for volume pricing.			Cable Dia. 0.303" dia.	Attn. @ 1 GHz	Power @ 1 GHz
12"	24"	36"	48"	60"	50CM	Custom Len.
\$65.81	\$69.54	\$73.26	\$77.00	\$80.72	\$68.20	See Web

30

**NEX10 MALE TO NEX10 FEMALE BULKHEAD**

SEE MOUNTING HOLE SECTION ON PAGE 409

**Low PIM Corrugated Cable Assemblies**

PE-1/4SFHC Coax, 50 Ohm						
Part No. <a href="#">PE3C7852</a>	1 piece price shown. See web or call for volume pricing.			Cable Dia. 0.303" dia.	Attn. @ 1 GHz	Power @ 1 GHz
12"	24"	36"	48"	60"	50CM	Custom Len.
\$68.56	\$72.29	\$76.02	\$79.74	\$83.47	\$70.95	See Web

31

**NEX10 MALE RIGHT ANGLE TO NEX10 MALE RIGHT ANGLE**

**Low PIM Corrugated Cable Assemblies**

PE-1/4SFHC Coax, 50 Ohm						
Part No. <a href="#">PE3C7853</a>	1 piece price shown. See web or call for volume pricing.			Cable Dia. 0.303" dia.	Attn. @ 1 GHz	Power @ 1 GHz
12"	24"	36"	48"	60"	50CM	Custom Len.
\$80.11	\$83.83	\$87.56	\$91.29	\$95.01	\$82.50	See Web

32

NEX10 MALE RIGHT ANGLE TO NEX10 FEMALE						
Low PIM Corrugated Cable Assemblies						
PE-1/4SFHC Coax, 50 Ohm						
Part No. <a href="#">PE3C7854</a>	1 piece price shown. See web or call for volume pricing.			Cable Dia. 0.303" dia.	Attn. @ 1 GHz	Power @ 1 GHz
12"	24"	36"	48"	60"	50CM	Custom Len.
\$71.31	\$75.03	\$78.76	\$82.50	\$86.22	\$73.69	See Web

33

NEX10 MALE RIGHT ANGLE TO NEX10 FEMALE BULKHEAD						
SEE MOUNTING HOLE SECTION ON PAGE 409						
Low PIM Corrugated Cable Assemblies						
PE-1/4SFHC Coax, 50 Ohm						
Part No. <a href="#">PE3C7855</a>	1 piece price shown. See web or call for volume pricing.			Cable Dia. 0.303" dia.	Attn. @ 1 GHz	Power @ 1 GHz
12"	24"	36"	48"	60"	50CM	Custom Len.
\$74.06	\$77.79	\$81.51	\$85.24	\$88.96	\$76.45	See Web

34

1.85MM NMD FEMALE TO 1.85MM MALE						
Precision Flexible Cable Assemblies						
PE-VNA-HF Coax, 50 Ohm						
Part No. <a href="#">PE3TC0960</a>	1 piece price shown. See web or call for volume pricing.			Cable Dia. 0.27" dia.	Attn. @ 1 GHz	Power @ 1 GHz
24"	48"	-	-	-	-	Custom Len.
\$3,927.29	\$4,057.39	-	-	-	-	See Web

35

1.85MM NMD FEMALE TO 1.85MM FEMALE						
Precision Flexible Cable Assemblies						
PE-VNA-HF Coax, 50 Ohm						
Part No. <a href="#">PE3TC0970</a>	1 piece price shown. See web or call for volume pricing.			Cable Dia. 0.27" dia.	Attn. @ 1 GHz	Power @ 1 GHz
24"	48"	-	-	-	-	Custom Len.
\$3,927.29	\$4,057.39	-	-	-	-	See Web

36

2.4MM NMD FEMALE TO 2.4MM MALE						
Precision Flexible Cable Assemblies						
PE-VNA-HF Coax, 50 Ohm						
Part No. <a href="#">PE3TC0660</a>	1 piece price shown. See web or call for volume pricing.			Cable Dia. 0.27" dia.	Attn. @ 1 GHz	Power @ 1 GHz
24"	48"	-	-	-	-	Custom Len.
\$3,566.80	\$3,699.61	-	-	-	-	See Web

37

2.4MM NMD FEMALE TO 2.4MM FEMALE						
Precision Flexible Cable Assemblies						
PE-VNA-HF Coax, 50 Ohm						
Part No. <a href="#">PE3TC0670</a>	1 piece price shown. See web or call for volume pricing.			Cable Dia. 0.27" dia.	Attn. @ 1 GHz	Power @ 1 GHz
24"	48"	-	-	-	-	Custom Len.
\$3,566.80	\$3,699.61	-	-	-	-	See Web

38

2.92MM NMD FEMALE TO 2.92MM MALE						
Standard Flexible Cable Assemblies						
PE-VNA-R Coax, 50 Ohm						
Part No. <a href="#">PE3VNA4007</a>	1 piece price shown. See web or call for volume pricing.			Cable Dia. 0.43" dia.	Attn. @ 1 GHz	Power @ 1 GHz
24"	36"	48"	-	-	-	Custom Len.
\$2,456.91	\$2,573.07	\$2,685.71	-	-	-	See Web

39

2.92MM NMD FEMALE TO 2.92MM FEMALE						
Standard Flexible Cable Assemblies						
PE-VNA-R Coax, 50 Ohm						
Part No. <a href="#">PE3VNA4008</a>	1 piece price shown. See web or call for volume pricing.			Cable Dia. 0.43" dia.	Attn. @ 1 GHz	Power @ 1 GHz
24"	36"	48"	-	-	-	Custom Len.
\$2,527.30	\$2,643.47	\$2,752.60	-	-	-	See Web

40

\*Coax Performance at 1 GHz Notes: Cable assembly max frequency may be lower than connector or coax max frequency

For our complete selection of cable assemblies, please visit our website

### 3.5MM FEMALE TO 3.5MM NMD FEMALE



**Standard Flexible Cable Assemblies**  
PE-VNA-R Coax, 50 Ohm

Part No. <a href="#">PE3VNA2610</a>	Cable Dia.	Attn. @ 1 GHz	Power @ 1 GHz
1 piece price shown. See web or call for volume pricing.			
24"	36"	48"	-
\$1,876.08	\$1,985.20	\$2,094.34	-

41

### 3.5MM NMD FEMALE TO 3.5MM MALE



**Standard Flexible Cable Assemblies**  
PE-VNA-R Coax, 50 Ohm

Part No. <a href="#">PE3VNA2607</a>	Cable Dia.	Attn. @ 1 GHz	Power @ 1 GHz
1 piece price shown. See web or call for volume pricing.			
24"	36"	48"	-
\$1,840.88	\$1,950.00	\$2,059.13	-

42

### D-SUBMINIATURE RECEPTACLE TO BNC MALE



**Low Loss Flexible Cable Assemblies**  
LMR-100A-PVC Coax, 50 Ohm

Part No. <a href="#">PE3W01818</a>	Cable Dia.	Attn. @ 1 GHz	Power @ 1 GHz
1 piece price shown. See web or call for volume pricing.			
12"	24"	36"	48"
Call	Call	Call	Call

43

### MCX PLUG TO 75 OHM BNC MALE



**Standard Flexible Cable Assemblies**  
RG187A/U Coax, 75 Ohm

Part No. <a href="#">PE3C5491</a>	Cable Dia.	Attn. @ 1 GHz	Power @ 1 GHz
1 piece price shown. See web or call for volume pricing.			
12"	24"	36"	48"
\$52.00	\$53.18	\$56.76	\$60.84

44

### 2.92MM FEMALE BULKHEAD TO STRAIGHT CUT LEAD SEXLESS



SEE MOUNTING HOLE SECTION ON PAGE 409

**Standard Semi-Rigid Cable Assemblies**  
RG405/U Coax, 50 Ohm

Part No. <a href="#">PE3C7619</a>	Cable Dia.	Attn. @ 1 GHz	Power @ 1 GHz
1 piece price shown. See web or call for volume pricing.			
12"	24"	36"	48"
\$202.37	\$210.18	\$218.00	\$225.82

45

### 3.5MM FEMALE TO STRAIGHT CUT LEAD SEXLESS



**Standard Semi-Rigid Cable Assemblies**  
RG402/U Coax, 50 Ohm

Part No. <a href="#">PE3C7590</a>	Cable Dia.	Attn. @ 1 GHz	Power @ 1 GHz
1 piece price shown. See web or call for volume pricing.			
12"	24"	36"	48"
\$133.06	\$141.30	\$149.54	\$157.77

46

### BNC MALE TO NMO MOUNT SEXLESS



**Standard Flexible Cable Assemblies**  
RG58C/U Coax, 50 Ohm

Part No. <a href="#">PE37844</a>	Cable Dia.	Attn. @ 1 GHz	Power @ 1 GHz
1 piece price shown. See web or call for volume pricing.			
60"	120"	180"	-
\$47.11	\$55.14	\$54.77	-

47

### BNC MALE TO STRAIGHT CUT LEAD SEXLESS



**Standard Flexible Cable Assemblies**  
RG188A/U Coax, 50 Ohm

Part No. <a href="#">PE3C3583</a>	Cable Dia.	Attn. @ 1 GHz	Power @ 1 GHz
1 piece price shown. See web or call for volume pricing.			
12"	50CM	24"	36"
\$26.40	\$27.42	\$28.39	\$31.07

48

### BNC FEMALE TO NMO MOUNT SEXLESS



**Standard Flexible Cable Assemblies**  
RG58C/U Coax, 50 Ohm

Part No. <a href="#">PE37845</a>	Cable Dia.	Attn. @ 1 GHz	Power @ 1 GHz
1 piece price shown. See web or call for volume pricing.			
60"	120"	180"	-
\$45.92	\$49.99	\$54.04	-

49

### FME PLUG TO NMO MOUNT SEXLESS



**Standard Flexible Cable Assemblies**  
RG58C/U Coax, 50 Ohm

Part No. <a href="#">PE37842</a>	Cable Dia.	Attn. @ 1 GHz	Power @ 1 GHz
1 piece price shown. See web or call for volume pricing.			
60"	120"	180"	-
\$49.32	\$53.38	\$56.91	-

50

### FME JACK TO NMO MOUNT SEXLESS



**Standard Flexible Cable Assemblies**  
RG58C/U Coax, 50 Ohm

Part No. <a href="#">PE37843</a>	Cable Dia.	Attn. @ 1 GHz	Power @ 1 GHz
1 piece price shown. See web or call for volume pricing.			
60"	120"	180"	-
\$45.25	\$49.32	\$53.38	-

51

### MINI UHF MALE TO NMO MOUNT SEXLESS



**Standard Flexible Cable Assemblies**  
RG58C/U Coax, 50 Ohm

Part No. <a href="#">PE37846</a>	Cable Dia.	Attn. @ 1 GHz	Power @ 1 GHz
1 piece price shown. See web or call for volume pricing.			
60"	120"	180"	-
\$45.84	\$49.92	\$54.00	-

52

### MINI UHF FEMALE TO NMO MOUNT SEXLESS



**Standard Flexible Cable Assemblies**  
RG58C/U Coax, 50 Ohm

Part No. <a href="#">PE37847</a>	Cable Dia.	Attn. @ 1 GHz	Power @ 1 GHz
1 piece price shown. See web or call for volume pricing.			
60"	120"	180"	-
\$49.71	\$53.77	\$57.31	-

53

### N MALE TO NMO MOUNT SEXLESS



**Standard Flexible Cable Assemblies**  
RG58C/U Coax, 50 Ohm

Part No. <a href="#">PE37850</a>	Cable Dia.	Attn. @ 1 GHz	Power @ 1 GHz
1 piece price shown. See web or call for volume pricing.			
60"	120"	180"	-
\$57.61	\$62.16	\$66.73	-

54

### N FEMALE TO NMO MOUNT SEXLESS



**Standard Flexible Cable Assemblies**  
RG58C/U Coax, 50 Ohm

Part No. <a href="#">PE37851</a>	Cable Dia.	Attn. @ 1 GHz	Power @ 1 GHz
1 piece price shown. See web or call for volume pricing.			
60"	120"	180"	-
\$53.25	\$56.77	\$66.26	-

55

### SMA MALE TO NMO MOUNT SEXLESS



**Standard Flexible Cable Assemblies**  
RG58C/U Coax, 50 Ohm

Part No. <a href="#">PE37840</a>	Cable Dia.	Attn. @ 1 GHz	Power @ 1 GHz
1 piece price shown. See web or call for volume pricing.			
60"	120"	180"	-
\$56.19	\$55.94	\$65.30	-

56

Cable Assemblies

See Our Website For Current Pricing & Real-Time Stock Availability!

For Custom Lengths, Metric Lengths or Special Configurations, Please call (949) 261-1920

Technical Support  
+1 (949) 261-1920

Same-Day Shipping,  
Even Custom Cable Assemblies

For our complete selection of cable assemblies, please visit our website

Cable Assemblies  
See Our Website For Current Pricing & Real-Time Stock Availability!

SMA MALE TO STRAIGHT CUT LEAD SEXLESS						
Flexible Cable Assemblies						
RG188-DS Coax, 50 Ohm						
Part No.	Cable Dia.			Attn. @ 1 GHz	Power @ 1 GHz	
Part No. <b>PE3C6848</b>	0.118" dia.			30 dB/100ft	160 W	67
1 piece price shown. See web or call for volume pricing.						
12"	24"	36"	48"	60"	50CM	Custom Len.
\$27.68	\$31.05	\$33.10	\$37.20	\$41.29	\$27.52	See Web

SMA FEMALE TO NMO MOUNT SEXLESS						
Standard Flexible Cable Assemblies						
RG58C/U Coax, 50 Ohm						
Part No.	Cable Dia.			Attn. @ 1 GHz	Power @ 1 GHz	
Part No. <b>PE37841</b>	0.195" dia.			20 dB/100ft	44 W	68
1 piece price shown. See web or call for volume pricing.						
60"	120"	180"	-	-	-	Custom Len.
\$66.04	\$65.05	\$69.10	-	-	-	See Web

SMA FEMALE TO TRIMMED LEAD SEXLESS						
Standard Semi-Rigid Cable Assemblies						
PE-020SR Coax, 50 Ohm						
Part No.	Cable Dia.			Attn. @ 1 GHz	Power @ 1 GHz	
Part No. <b>PE3CA1104</b>	0.02" dia.			15CM	Custom Len.	69
1 piece price shown. See web or call for volume pricing.						
-	3"	6"	9"	12"	Call	See Web
-	\$104.73	\$122.24	\$141.22	\$158.09	Call	See Web

SMA FEMALE TO TRIMMED LEAD SEXLESS						
Standard Semi-Rigid Cable Assemblies						
PE-034SR Coax, 50 Ohm						
Part No.	Cable Dia.			Attn. @ 1 GHz	Power @ 1 GHz	
Part No. <b>PE3CA1105</b>	0.034" dia.			-	Custom Len.	60
1 piece price shown. See web or call for volume pricing.						
3"	15CM	6"	9"	12"	-	See Web
\$39.51	Call	\$47.19	\$54.03	\$60.72	-	See Web

SMA FEMALE TO TRIMMED LEAD SEXLESS						
Standard Semi-Rigid Cable Assemblies						
PE-SR047TN Coax, 50 Ohm						
Part No.	Cable Dia.			Attn. @ 1 GHz	Power @ 1 GHz	
Part No. <b>PE3CA1106</b>	0.047" dia.			-	Custom Len.	61
1 piece price shown. See web or call for volume pricing.						
3"	6"	9"	12"	-	-	See Web
\$43.95	\$46.98	\$52.38	\$57.66	-	-	See Web

SMA FEMALE TO STRAIGHT CUT LEAD SEXLESS						
Standard Semi-Rigid Cable Assemblies						
PE-020SR Coax, 50 Ohm						
Part No.	Cable Dia.			Attn. @ 1 GHz	Power @ 1 GHz	
Part No. <b>PE3CA1107</b>	0.02" dia.			-	Custom Len.	62
1 piece price shown. See web or call for volume pricing.						
3"	6"	9"	12"	-	-	See Web
\$67.10	\$88.37	\$107.53	\$127.92	-	-	See Web

SMA FEMALE TO STRAIGHT CUT LEAD SEXLESS						
Standard Semi-Rigid Cable Assemblies						
PE-034SR Coax, 50 Ohm						
Part No.	Cable Dia.			Attn. @ 1 GHz	Power @ 1 GHz	
Part No. <b>PE3CA1102</b>	0.034" dia.			-	Custom Len.	63
1 piece price shown. See web or call for volume pricing.						
3"	6"	9"	12"	-	-	See Web
\$34.79	\$40.61	\$46.47	\$52.35	-	-	See Web

SMA FEMALE TO STRAIGHT CUT LEAD SEXLESS						
Standard Semi-Rigid Cable Assemblies						
PE-047SR Coax, 50 Ohm						
Part No.	Cable Dia.			Attn. @ 1 GHz	Power @ 1 GHz	
Part No. <b>PE3CA1103</b>	0.047" dia.			-	Custom Len.	64
1 piece price shown. See web or call for volume pricing.						
3"	6"	9"	12"	-	-	See Web
\$34.58	\$40.42	\$46.26	\$52.15	-	-	See Web

SSMA MALE TO TRIMMED LEAD SEXLESS						
Formable Cable Assemblies						
PE-SR405FL Coax, 50 Ohm						
Part No.	Cable Dia.			Attn. @ 1 GHz	Power @ 1 GHz	
Part No. <b>PE3C6783</b>	22.5 dB/100ft			105 W	Custom Len.	65
1 piece price shown. See web or call for volume pricing.						
12"	24"	36"	48"	60"	50CM	See Web
\$78.14	\$90.98	\$97.41	\$108.72	\$121.38	\$79.95	See Web

SSMB PLUG RIGHT ANGLE TO STRAIGHT CUT LEAD SEXLESS						
Standard Flexible Cable Assemblies						
RG316/U Coax, 50 Ohm						
Part No.	Cable Dia.			Attn. @ 1 GHz	Power @ 1 GHz	
Part No. <b>PE3C7425</b>	0.102" dia.			38 dB/100ft	105 W	66
1 piece price shown. See web or call for volume pricing.						
12"	50CM	24"	36"	100CM	48"	Custom Len.
Call	Call	Call	Call	Call	Call	See Web

TNC FEMALE TO NMO MOUNT SEXLESS						
Standard Flexible Cable Assemblies						
RG58C/U Coax, 50 Ohm						
Part No.	Cable Dia.			Attn. @ 1 GHz	Power @ 1 GHz	
Part No. <b>PE37849</b>	0.195" dia.			20 dB/100ft	44 W	67
1 piece price shown. See web or call for volume pricing.						
60"	120"	180"	-	-	-	Custom Len.
\$54.69	\$58.74	\$62.77	-	-	-	See Web

UMCX PLUG RIGHT ANGLE TO STRAIGHT CUT LEAD SEXLESS						
Standard Flexible Cable Assemblies						
RG178B/U Coax, 50 Ohm						
Part No.	Cable Dia.			Attn. @ 1 GHz	Power @ 1 GHz	
Part No. <b>PE38296</b>	0.072" dia.			-	Custom Len.	68
1 piece price shown. See web or call for volume pricing.						
3"	6"	9"	12"	24"	-	See Web
\$46.71	\$30.80	\$46.71	\$30.80	\$34.87	\$41.10	See Web

75 OHM 1.6/5.6 PLUG TO 75 OHM 1.6/5.6 PLUG						
Standard Flexible Cable Assemblies						
RG59B/U Coax, 75 Ohm						
Part No.	Cable Dia.			Attn. @ 1 GHz	Power @ 1 GHz	
Part No. <b>PE36109</b>	0.242" dia.			11.5 dB/100ft	77 W	69
1 piece price shown. See web or call for volume pricing.						
12"	24"	36"	48"	60"	72"	Custom Len.
\$45.05	\$46.04	\$47.05	\$48.05	\$49.05	\$50.05	See Web

75 OHM 1.6/5.6 PLUG TO 75 OHM 1.6/5.6 PLUG						
Standard Flexible Cable Assemblies						
RG179B/U Coax, 75 Ohm						
Part No.	Cable Dia.			Attn. @ 1 GHz	Power @ 1 GHz	
Part No. <b>PE36111</b>	0.1" dia.			25 dB/100ft	200 W	70
1 piece price shown. See web or call for volume pricing.						
12"	24"	36"	48"	60"	72"	Custom Len.
\$54.53	\$57.17	\$59.82	\$62.40	\$65.04	\$67.61	See Web

75 OHM 1.6/5.6 PLUG TO 75 OHM 1.6/5.6 PLUG						
Standard Flexible Cable Assemblies						
RG187A/U Coax, 75 Ohm						
Part No.	Cable Dia.			Attn. @ 1 GHz	Power @ 1 GHz	
Part No. <b>PE36113</b>	0.11" dia.			25 dB/100ft	200 W	71
1 piece price shown. See web or call for volume pricing.						
12"	24"	36"	48"	60"	72"	Custom Len.
\$55.61	\$65.36	\$62.77	\$66.42	\$70.04	\$73.68	See Web

75 OHM 1.6/5.6 PLUG TO 75 OHM 1.6/5.6 PLUG RIGHT ANGLE						
Standard Flexible Cable Assemblies						
RG179B/U Coax, 75 Ohm						
Part No.	Cable Dia.			Attn. @ 1 GHz	Power @ 1 GHz	
Part No. <b>PE36117</b>	0.1" dia.			25 dB/100ft	200 W	72
1 piece price shown. See web or call for volume pricing.						
12"	24"	36"	48"	60"	72"	Custom Len.
\$64.83	\$67.40	\$70.04	\$72.68	\$75.26	\$77.89	See Web

75 OHM 1.6/5.6 PLUG TO 75 OHM 1.6/5.6 PLUG RIGHT ANGLE						
Standard Flexible Cable Assemblies						
RG187A/U Coax, 75 Ohm						
Part No.	Cable Dia.			Attn. @ 1 GHz	Power @ 1 GHz	
Part No. <b>PE36119</b>	0.11" dia.			25 dB/100ft	200 W	73
1 piece price shown. See web or call for volume pricing.						
12"	24"	36"	48"	60"	72"	Custom Len.
\$65.82	\$69.44	\$73.07	\$76.65	\$80.28	\$83.89	See Web

75 OHM 1.6/5.6 PLUG TO 75 OHM BNC MALE						
Standard Flexible Cable Assemblies						
RG59B/U Coax, 75 Ohm						
Part No.	Cable Dia.			Attn. @ 1 GHz	Power @ 1 GHz	
Part No. <b>PE36127</b>	0.242" dia.			11.5 dB/100ft	77 W	74
1 piece price shown. See web or call for volume pricing.						
12"	24"	36"	48"	60"	72"	Custom Len.
\$44.34	\$49.04	\$46.47	\$47.55	\$48.59	\$49.67	See Web

75 OHM 1.6/5.6 PLUG TO 75 OHM BNC MALE						
Standard Flexible Cable Assemblies						
RG179B/U Coax, 75 Ohm						
Part No.	Cable Dia.			Attn. @ 1 GHz	Power @ 1 GHz	
Part No. <b>PE36129</b>	0.1" dia.			25 dB/100ft	200 W	75
1 piece price shown. See web or call for volume pricing.						
12"	24"	36"	48"	60"	72"	Custom Len.
\$52.11	\$54.20	\$56.86	\$59.48	\$62.05	\$64.70	See Web

75 OHM 1.6/5.6 PLUG TO 75 OHM BNC MALE						
Standard Flexible Cable Assemblies						
RG187A/U Coax, 75 Ohm						
Part No.	Cable Dia.			Attn. @ 1 GHz	Power @ 1 GHz	
Part No. <b>PE36131</b>	0.11" dia.			25 dB/100ft	200 W	76
1 piece price shown. See web or call for volume pricing.						
12"	24"	36"	48"	60"	Custom Len.	See Web
\$53.11	\$56.26	\$59.88	\$63.45	\$67.06	\$70.69	See Web

\*Coax Performance at 1 GHz Notes: Cable assembly max frequency may be lower than connector or coax max frequency

For our complete selection of cable assemblies, please visit our website

**75 OHM 1.6/5.6 PLUG RIGHT ANGLE TO 75 OHM 1.6/5.6 PLUG RIGHT ANGLE**



**Standard Flexible Cable Assemblies**

RG179B/U Coax, 75 Ohm				
Part No. <a href="#">PE36123</a>	Cable Dia.	Attn. @ 1 GHz	Power @ 1 GHz	
1 piece price shown. See web or call for volume pricing.				
12"	24"	36"	48"	72"
\$75.04	\$77.69	\$80.28	\$82.91	\$85.54 \$88.12
See Web				

RG187A/U Coax, 75 Ohm				
Part No. <a href="#">PE36125</a>	Cable Dia.	Attn. @ 1 GHz	Power @ 1 GHz	
1 piece price shown. See web or call for volume pricing.				
12"	24"	36"	48"	60"
\$76.05	\$79.69	\$83.29	\$86.94	\$90.57 \$94.13
See Web				

**75 OHM BNC MALE TO 75 OHM BNC MALE**



**Standard Flexible Cable Assemblies**

RG6A/U Coax, 75 Ohm				
Part No. <a href="#">PE33197</a>	Cable Dia.	Attn. @ 1 GHz	Power @ 1 GHz	
1 piece price shown. See web or call for volume pricing.				
12"	24"	36"	48"	60"
\$48.77	\$50.31	\$55.99	\$55.74	\$63.95 \$67.88
See Web				

RG6-CATV Coax, 75 Ohm				
Part No. <a href="#">PE37808</a>	Cable Dia.	Attn. @ 1 GHz	Power @ 1 GHz	
1 piece price shown. See web or call for volume pricing.				
12"	24"	36"	48"	60"
\$63.54	\$64.85	\$66.18	\$67.57	\$63.39 -
See Web				

RG11A/U Coax, 75 Ohm				
Part No. <a href="#">PE33399</a>	Cable Dia.	Attn. @ 1 GHz	Power @ 1 GHz	
1 piece price shown. See web or call for volume pricing.				
12"	24"	36"	48"	60"
\$74.44	\$76.33	\$78.22	\$80.11	\$82.00 \$83.88
See Web				

RG59B/U Coax, 75 Ohm				
Part No. <a href="#">PE33188</a>	Cable Dia.	Attn. @ 1 GHz	Power @ 1 GHz	
1 piece price shown. See web or call for volume pricing.				
12"	24"	36"	48"	60"
\$44.11	\$45.26	\$46.42	\$47.64	\$48.82 \$49.98
See Web				

RG179B/U Coax, 75 Ohm				
Part No. <a href="#">PE33401</a>	Cable Dia.	Attn. @ 1 GHz	Power @ 1 GHz	
1 piece price shown. See web or call for volume pricing.				
12"	24"	36"	48"	60"
\$54.66	\$57.47	\$60.28	\$63.26	\$66.13 \$69.00
See Web				

PE-B150 Coax, 75 Ohm				
Part No. <a href="#">PE33405</a>	Cable Dia.	Attn. @ 1 GHz	Power @ 1 GHz	
1 piece price shown. See web or call for volume pricing.				
12"	24"	36"	48"	60"
\$62.69	\$68.73	\$69.73	\$65.30	\$66.18 \$67.04
See Web				

PE-B159-BL Coax, 75 Ohm				
Part No. <a href="#">PE38130</a>	Cable Dia.	Attn. @ 1 GHz	Power @ 1 GHz	
1 piece price shown. See web or call for volume pricing.				
12"	24"	36"	48"	60"
\$48.87	\$49.57	\$50.27	\$50.98	\$51.68 \$52.88
See Web				

**75 OHM BNC MALE TO 75 OHM BNC MALE RIGHT ANGLE**



**Standard Flexible Cable Assemblies**

RG6A/U Coax, 75 Ohm				
Part No. <a href="#">PE33407</a>	Cable Dia.	Attn. @ 1 GHz	Power @ 1 GHz	
1 piece price shown. See web or call for volume pricing.				
12"	24"	36"	48"	60"
\$74.23	\$77.20	\$80.14	\$83.09	\$86.02 \$88.95
See Web				

RG59B/U Coax, 75 Ohm				
Part No. <a href="#">PE33196</a>	Cable Dia.	Attn. @ 1 GHz	Power @ 1 GHz	
1 piece price shown. See web or call for volume pricing.				
12"	24"	36"	48"	60"
\$60.75	\$61.82	\$67.90	\$63.92	\$64.99 \$66.03
See Web				

Part No. <a href="#">PE3W00288</a>				
Cable Dia.	Attn. @ 1 GHz	Power @ 1 GHz		
1 piece price shown. See web or call for volume pricing.				
12"	24"	36"	48"	60"
\$78.10	\$79.20	\$80.31	\$81.43	\$82.54 \$78.81
See Web				

RG179B/U Coax, 75 Ohm				
Part No. <a href="#">PE33412</a>	Cable Dia.	Attn. @ 1 GHz	Power @ 1 GHz	
1 piece price shown. See web or call for volume pricing.				
12"	24"	36"	48"	60"
\$67.27	\$70.08	\$69.88	\$75.86	\$75.05 \$77.68
See Web				

RG187A/U Coax, 75 Ohm				
Part No. <a href="#">PE33414</a>	Cable Dia.	Attn. @ 1 GHz	Power @ 1 GHz	
1 piece price shown. See web or call for volume pricing.				
12"	24"	36"	48"	60"
\$68.49	\$72.68	\$76.88	\$75.83	\$79.57 \$83.29
See Web				

**75 OHM BNC MALE TO 75 OHM BNC FEMALE**



**Standard Flexible Cable Assemblies**

RG6A/U Coax, 75 Ohm				
Part No. <a href="#">PE33437</a>	Cable Dia.	Attn. @ 1 GHz	Power @ 1 GHz	
1 piece price shown. See web or call for volume pricing.				
12"	24"	36"	48"	60"
\$86.50	\$89.44	\$93.38	\$95.33	\$107.34 \$101.22
See Web				

RG11A/U Coax, 75 Ohm				
Part No. <a href="#">PE33439</a>	Cable Dia.	Attn. @ 1 GHz	Power @ 1 GHz	
1 piece price shown. See web or call for volume pricing.				
12"	24"	36"	48"	60"
Call	Call	Call	Call	Call
See Web				

RG179B/U Coax, 75 Ohm				
Part No. <a href="#">PE33443</a>	Cable Dia.	Attn. @ 1 GHz	Power @ 1 GHz	
1 piece price shown. See web or call for volume pricing.				
12"	24"	36"	48"	60"
\$58.18	\$64.48	\$63.37	\$65.97	\$68.57 \$75.99
See Web				

RG187A/U Coax, 75 Ohm				
Part No. <a href="#">PE33445</a>	Cable Dia.	Attn. @ 1 GHz	Power @ 1 GHz	
1 piece price shown. See web or call for volume pricing.				
12"	24"	36"	48"	60"
\$59.26	\$63.00	\$66.74	\$70.49	\$74.21 \$77.96
See Web				

**75 OHM BNC MALE TO 75 OHM BNC FEMALE BULKHEAD**



SEE MOUNTING HOLE SECTION ON PAGE 409

**Standard Flexible Cable Assemblies**

RG6A/U Coax, 75 Ohm				
Part No. <a href="#">PE33417</a>	Cable Dia.	Attn. @ 1 GHz	Power @ 1 GHz	
1 piece price shown. See web or call for volume pricing.				
12"	24"	36"	48"	60"
\$93.75	\$96.70	\$99.65	\$102.57	\$105.52 \$106.95
See Web				

RG59B/U Coax, 75 Ohm				
Part No. <a href="#">PE33179</a>	Cable Dia.	Attn. @ 1 GHz	Power @ 1 GHz	
1 piece price shown. See web or call for volume pricing.				
12"	24"	36"	48"	60"
\$65.67	\$66.80	\$61.81	\$62.86	\$63.92 \$64.98
See Web				

RG179B/U Coax, 75 Ohm				
Part No. <a href="#">PE33421</a>	Cable Dia.	Attn. @ 1 GHz	Power @ 1 GHz	
1 piece price shown. See web or call for volume pricing.				
12"	24"	36"	48"	60"
\$67.93	\$70.73	\$68.10	\$70.69	\$73.28 \$75.90
See Web				

PE-B150 Coax, 75 Ohm				
Part No. <a href="#">PE33425</a>	Cable Dia.	Attn. @ 1 GHz	Power @ 1 GHz	
1 piece price shown. See web or call for volume pricing.				
12"	24"	36"	48"	60"
\$75.89	\$76.75	\$77.62	\$78.49	\$79.35 \$80.25
See Web				

PE-B159-BL Coax, 75 Ohm				
Part No. <a href="#">PE38132</a>	Cable Dia.	Attn. @ 1 GHz	Power @ 1 GHz	
1 piece price shown. See web or call for volume pricing.				
12"	24"	36"	48"	60"
\$54.35	\$55.99	\$57.64	\$59.30	\$61.00 \$62.67
See Web				

**75 OHM BNC MALE RIGHT ANGLE TO 75 OHM BNC MALE RIGHT ANGLE**



**Standard Flexible Cable Assemblies**

RG6A/U Coax, 75 Ohm				
Part No. <a href="#">PE33426</a>	Cable Dia.	Attn. @ 1 GHz	Power @ 1 GHz	
1 piece price shown. See web or call for volume pricing.				
12"	24"	36"	48"	60"
\$93.64	\$96.58	\$99.52	\$102.45	\$105.39 \$106.85
See Web				

RG59B/U Coax, 75 Ohm				
Part No. <a href="#">PE33430</a>	Cable Dia.	Attn. @ 1 GHz	Power @ 1 GHz	
1 piece price shown. See web or call for volume pricing.				
12"	24"	36"	48"	60"
\$81.84	\$82.89	\$90.68	\$85.00	\$86.06 \$87.12
See Web				

RG179B/U Coax, 75 Ohm				
Part No. <a href="#">PE33432</a>	Cable Dia.	Attn. @ 1 GHz	Power @ 1 GHz	
1 piece price shown. See web or call for volume pricing.				
12"	24"	36"	48"	60"
\$75.44	\$78.02	\$80.63	\$83.23	\$85.83 \$88.42
See Web				

Cable Assemblies

See Our Website For Current Pricing & Real-Time Stock Availability!

For Custom Lengths, Metric Lengths or Special Configurations, Please call (949) 261-1920

Technical Support  
+1 (949) 261-1920

Same-Day Shipping,  
Even Custom Cable Assemblies



For our complete selection of cable assemblies, please visit our website

Cable Assemblies  
See Our Website For Current Pricing & Real-Time Stock Availability!

RG187A/U Coax, 75 Ohm						
Part No. <a href="#">PE33434</a>	Cable Dia.		Attn. @ 1 GHz	Power @ 1 GHz		
1 piece price shown. See web or call for volume pricing.						
12"	24"	36"	48"	60"	72"	Custom Len.
\$76.49	\$80.24	\$89.47	\$87.71	\$91.45	\$95.19	See Web
<b>75 OHM BNC FEMALE TO 75 OHM BNC FEMALE</b>						
Standard Flexible Cable Assemblies						
RG6A/U Coax, 75 Ohm						
Part No. <a href="#">PE33448</a>	Cable Dia.		Attn. @ 1 GHz	Power @ 1 GHz		
1 piece price shown. See web or call for volume pricing.						
12"	24"	36"	48"	60"	72"	Custom Len.
\$109.93	\$111.94	\$113.91	\$115.91	\$117.86	\$119.89	See Web
RG11A/U Coax, 75 Ohm						
Part No. <a href="#">PE33450</a>	Cable Dia.		Attn. @ 1 GHz	Power @ 1 GHz		
1 piece price shown. See web or call for volume pricing.						
12"	24"	36"	48"	60"	72"	Custom Len.
\$98.94	\$100.73	\$102.56	\$104.41	\$106.20	\$106.55	See Web
RG179B/U Coax, 75 Ohm						
Part No. <a href="#">PE33451</a>	Cable Dia.		Attn. @ 1 GHz	Power @ 1 GHz		
1 piece price shown. See web or call for volume pricing.						
12"	24"	36"	48"	60"	72"	Custom Len.
\$59.04	\$61.65	\$64.30	\$66.87	\$69.51	\$76.91	See Web
RG187A/U Coax, 75 Ohm						
Part No. <a href="#">PE33456</a>	Cable Dia.		Attn. @ 1 GHz	Power @ 1 GHz		
1 piece price shown. See web or call for volume pricing.						
12"	24"	36"	48"	60"	72"	Custom Len.
\$60.09	\$63.64	\$67.29	\$70.91	\$74.51	\$78.15	See Web
<b>75 OHM BNC FEMALE BULKHEAD TO 75 OHM BNC FEMALE BULKHEAD</b>						
SEE MOUNTING HOLE SECTION ON PAGE 409						
Flexible Cable Assemblies						
RG187A/U Coax, 75 Ohm						
Part No. <a href="#">PE3W07034</a>	Cable Dia.		Attn. @ 1 GHz	Power @ 1 GHz		
1 piece price shown. See web or call for volume pricing.						
12"	24"	36"	48"	60"	50CM	Custom Len.
\$73.47	\$78.03	\$80.27	\$84.89	\$89.47	\$74.10	See Web
Standard Flexible Cable Assemblies						
RG62A/U Coax, 93 Ohm						
Part No. <a href="#">PE3W06444</a>	Cable Dia.		Attn. @ 1 GHz	Power @ 1 GHz		
1 piece price shown. See web or call for volume pricing.						
12"	24"	36"	48"	60"	50CM	Custom Len.
\$74.04	\$76.57	\$79.11	\$81.66	\$84.20	\$75.65	See Web
<b>75 OHM F MALE TO 75 OHM BNC MALE</b>						
Standard Flexible Cable Assemblies						
RG6-CATV Coax, 75 Ohm						
Part No. <a href="#">PE36145</a>	Cable Dia.		Attn. @ 1 GHz	Power @ 1 GHz		
1 piece price shown. See web or call for volume pricing.						
12"	24"	36"	48"	60"	72"	Custom Len.
\$36.42	\$37.75	\$36.66	\$40.49	\$41.83	\$40.12	See Web
RG11A/U Coax, 75 Ohm						
Part No. <a href="#">PE36147</a>	Cable Dia.		Attn. @ 1 GHz	Power @ 1 GHz		
1 piece price shown. See web or call for volume pricing.						
12"	24"	36"	48"	60"	72"	Custom Len.
\$58.61	\$60.52	\$62.40	\$64.28	\$66.18	\$68.06	See Web
RG59B/U Coax, 75 Ohm						
Part No. <a href="#">PE36149</a>	Cable Dia.		Attn. @ 1 GHz	Power @ 1 GHz		
1 piece price shown. See web or call for volume pricing.						
12"	24"	36"	48"	60"	72"	Custom Len.
\$32.01	\$30.70	\$34.31	\$35.53	\$36.71	\$34.96	See Web
RG59-WHITE Coax, 75 Ohm						
Part No. <a href="#">PE36151</a>	Cable Dia.		Attn. @ 1 GHz	Power @ 1 GHz		
1 piece price shown. See web or call for volume pricing.						
12"	24"	36"	48"	60"	72"	Custom Len.
\$29.78	\$31.96	\$34.13	\$36.31	\$38.49	\$40.67	See Web
RG179B/U Coax, 75 Ohm						
Part No. <a href="#">PE36153</a>	Cable Dia.		Attn. @ 1 GHz	Power @ 1 GHz		
1 piece price shown. See web or call for volume pricing.						
12"	24"	36"	48"	60"	72"	Custom Len.
\$43.80	\$46.65	\$49.48	\$48.44	\$51.06	\$53.69	See Web
RG187A/U Coax, 75 Ohm						
Part No. <a href="#">PE36155</a>	Cable Dia.		Attn. @ 1 GHz	Power @ 1 GHz		
1 piece price shown. See web or call for volume pricing.						
12"	24"	36"	48"	60"	72"	Custom Len.
\$47.20	\$47.49	\$51.26	\$54.53	\$58.27	\$62.01	See Web

75 OHM F MALE TO 75 OHM F MALE						
Low Loss Flexible Cable Assemblies						
PE-SF200LL75 Coax, 75 Ohm						
Part No. <a href="#">PE3TC1202</a>	Cable Dia.		Attn. @ 1 GHz	Power @ 1 GHz		
1 piece price shown. See web or call for volume pricing.						
24"	36"	48"	72"	100CM	200CM	Custom Len.
\$94.44	\$106.82	\$117.55	\$141.95	\$108.77	\$148.82	See Web
Standard Flexible Cable Assemblies						
RG6A/U Coax, 75 Ohm						
Part No. <a href="#">PE37163</a>	Cable Dia.		Attn. @ 1 GHz	Power @ 1 GHz		
1 piece price shown. See web or call for volume pricing.						
12"	24"	36"	48"	60"	-	Custom Len.
\$18.78	\$23.88	\$27.86	\$31.21	\$35.16	-	See Web
RG6-CATV Coax, 75 Ohm						
Part No. <a href="#">PE36132</a>	Cable Dia.		Attn. @ 1 GHz	Power @ 1 GHz		
1 piece price shown. See web or call for volume pricing.						
12"	24"	36"	48"	60"	72"	Custom Len.
\$21.53	\$22.90	\$24.28	\$25.72	\$27.10	\$27.73	See Web
RG11A/U Coax, 75 Ohm						
Part No. <a href="#">PE36135</a>	Cable Dia.		Attn. @ 1 GHz	Power @ 1 GHz		
1 piece price shown. See web or call for volume pricing.						
12"	24"	36"	48"	60"	72"	Custom Len.
\$43.99	\$45.89	\$51.20	\$49.70	\$51.62	\$53.51	See Web
RG59B/U Coax, 75 Ohm						
Part No. <a href="#">PE36141</a>	Cable Dia.		Attn. @ 1 GHz	Power @ 1 GHz		
1 piece price shown. See web or call for volume pricing.						
12"	24"	36"	48"	60"	72"	Custom Len.
\$18.70	\$19.87	\$21.06	\$22.32	\$22.01	\$23.11	See Web
RG59-WHITE Coax, 75 Ohm						
Part No. <a href="#">PE36143</a>	Cable Dia.		Attn. @ 1 GHz	Power @ 1 GHz		
1 piece price shown. See web or call for volume pricing.						
12"	24"	36"	48"	60"	72"	Custom Len.
\$18.52	\$20.77	\$23.02	\$25.27	\$27.55	\$28.93	See Web
RG179B/U Coax, 75 Ohm						
Part No. <a href="#">PE36137</a>	Cable Dia.		Attn. @ 1 GHz	Power @ 1 GHz		
1 piece price shown. See web or call for volume pricing.						
12"	24"	36"	48"	60"	72"	Custom Len.
\$30.08	\$30.95	\$35.75	\$36.27	\$38.86	\$41.52	See Web
RG187A/U Coax, 75 Ohm						
Part No. <a href="#">PE36139</a>	Cable Dia.		Attn. @ 1 GHz	Power @ 1 GHz		
1 piece price shown. See web or call for volume pricing.						
12"	24"	36"	48"	60"	72"	Custom Len.
\$31.05	\$31.77	\$35.30	\$38.73	\$42.28	\$45.80	See Web
PE-B159-BL Coax, 75 Ohm						
Part No. <a href="#">PE38136</a>	Cable Dia.		Attn. @ 1 GHz	Power @ 1 GHz		
1 piece price shown. See web or call for volume pricing.						
12"	24"	36"	48"	60"	72"	Custom Len.
\$24.94	\$27.33	\$30.14	\$33.06	\$36.00	\$38.99	See Web
<b>75 OHM F MALE TO 75 OHM F MALE RIGHT ANGLE</b>						
Standard Flexible Cable Assemblies						
RG59B/U Coax, 75 Ohm						
Part No. <a href="#">PE38343</a>	Cable Dia.		Attn. @ 1 GHz	Power @ 1 GHz		
1 piece price shown. See web or call for volume pricing.						
12"	24"	36"	48"	60"	-	Custom Len.
\$24.13	\$27.72	\$26.31	\$27.41	\$27.72	-	See Web
PE-B159-BL Coax, 75 Ohm						
Part No. <a href="#">PE38137</a>	Cable Dia.		Attn. @ 1 GHz	Power @ 1 GHz		
1 piece price shown. See web or call for volume pricing.						
12"	24"	36"	48"	60"	72"	Custom Len.
\$37.81	\$39.44	\$41.11	\$42.80	\$44.46	\$46.13	See Web
<b>75 OHM F MALE TO 75 OHM F FEMALE</b>						
Low Loss Flexible Cable Assemblies						
PE-SF200LL75 Coax, 75 Ohm						
Part No. <a href="#">PE3TC1203</a>	Cable Dia.		Attn. @ 1 GHz	Power @ 1 GHz		
1 piece price shown. See web or call for volume pricing.						
24"	36"	48"	72"	100CM	200CM	Custom Len.
\$94.44	\$106.82	\$117.55	\$141.95	\$108.77	\$148.82	See Web

\*Coax Performance at 1 GHz Notes: Cable assembly max frequency may be lower than connector or coax max frequency

For our complete selection of cable assemblies, please visit our website

**75 OHM F MALE TO 75 OHM F FEMALE BULKHEAD**

SEE MOUNTING HOLE SECTION ON PAGE 409



**Standard Flexible Cable Assemblies**

RG179B/U Coax, 75 Ohm						
Part No. <a href="#">PE3C5570</a>	Cable Dia.	Attn. @ 1 GHz	Power @ 1 GHz			
1 piece price shown. See web or call for volume pricing.				0.1" dia.	25 dB/100ft	29
12"	24"	36"	48"	60"	-	Custom Len.
\$29.86	\$32.49	\$35.10	\$37.73	\$40.37	-	See Web

PE-B159-BL Coax, 75 Ohm						
Part No. <a href="#">PE38138</a>	Cable Dia.	Attn. @ 1 GHz	Power @ 1 GHz			
1 piece price shown. See web or call for volume pricing.				0.159" dia.	10.5 dB/100ft	30
12"	24"	36"	48"	60"	72"	Custom Len.
\$31.54	\$33.20	\$34.85	\$36.53	\$38.19	\$39.86	See Web

**75 OHM F FEMALE TO 75 OHM F FEMALE**



**Low Loss Flexible Cable Assemblies**

PE-SF200LL75 Coax, 75 Ohm						
Part No. <a href="#">PE3TC1206</a>	Cable Dia.	Attn. @ 1 GHz	Power @ 1 GHz			
1 piece price shown. See web or call for volume pricing.				0.195" dia.		31
24"	36"	48"	72"	100CM	200CM	Custom Len.
\$94.44	\$106.82	\$117.55	\$141.95	\$108.77	\$148.82	See Web

**75 OHM MINI SMB PLUG TO 75 OHM BNC MALE**



**Standard Flexible Cable Assemblies**

RG59B/U Coax, 75 Ohm						
Part No. <a href="#">PE34701</a>	Cable Dia.	Attn. @ 1 GHz	Power @ 1 GHz			
1 piece price shown. See web or call for volume pricing.				0.242" dia.	11.5 dB/100ft	32
12"	24"	36"	48"	60"	72"	Custom Len.
\$52.72	\$53.87	\$51.87	\$52.91	\$56.89	\$54.56	See Web

RG179B/U Coax, 75 Ohm						
Part No. <a href="#">PE34703</a>	Cable Dia.	Attn. @ 1 GHz	Power @ 1 GHz			
1 piece price shown. See web or call for volume pricing.				0.1" dia.	25 dB/100ft	33
12"	24"	36"	48"	60"	72"	Custom Len.
\$58.83	\$61.64	\$64.46	\$67.43	\$65.91	\$68.51	See Web

RG187A/U Coax, 75 Ohm						
Part No. <a href="#">PE34705</a>	Cable Dia.	Attn. @ 1 GHz	Power @ 1 GHz			
1 piece price shown. See web or call for volume pricing.				0.11" dia.	25 dB/100ft	34
12"	24"	36"	48"	60"	72"	Custom Len.
\$59.96	\$60.30	\$64.04	\$72.81	\$71.52	\$75.26	See Web

PE-B159-BK Coax, 75 Ohm						
Part No. <a href="#">PE38040</a>	Cable Dia.	Attn. @ 1 GHz	Power @ 1 GHz			
1 piece price shown. See web or call for volume pricing.				0.159" dia.	10.5 dB/100ft	35
12"	24"	36"	48"	60"	72"	Custom Len.
Call	Call	Call	Call	Call	Call	See Web

**75 OHM MINI SMB PLUG TO 75 OHM MINI SMB PLUG**



**Standard Flexible Cable Assemblies**

RG59B/U Coax, 75 Ohm						
Part No. <a href="#">PE34681</a>	Cable Dia.	Attn. @ 1 GHz	Power @ 1 GHz			
1 piece price shown. See web or call for volume pricing.				0.242" dia.	11.5 dB/100ft	36
12"	24"	36"	48"	60"	72"	Custom Len.
\$56.32	\$57.31	\$58.29	\$59.30	\$60.28	\$61.27	See Web

RG179B/U Coax, 75 Ohm						
Part No. <a href="#">PE34683</a>	Cable Dia.	Attn. @ 1 GHz	Power @ 1 GHz			
1 piece price shown. See web or call for volume pricing.				0.1" dia.	25 dB/100ft	37
12"	24"	36"	48"	60"	72"	Custom Len.
\$59.37	\$61.95	\$64.55	\$67.15	\$69.76	\$77.27	See Web

RG187A/U Coax, 75 Ohm						
Part No. <a href="#">PE34685</a>	Cable Dia.	Attn. @ 1 GHz	Power @ 1 GHz			
1 piece price shown. See web or call for volume pricing.				0.11" dia.	25 dB/100ft	38
12"	24"	36"	48"	60"	72"	Custom Len.
\$57.00	\$60.61	\$64.24	\$73.25	\$71.43	\$75.04	See Web

PE-B159-BL Coax, 75 Ohm						
Part No. <a href="#">PE38139</a>	Cable Dia.	Attn. @ 1 GHz	Power @ 1 GHz			
1 piece price shown. See web or call for volume pricing.				0.159" dia.	10.5 dB/100ft	39
12"	24"	36"	48"	60"	72"	Custom Len.
Call	Call	Call	Call	Call	Call	See Web

**75 OHM MINI SMB PLUG TO 75 OHM MINI SMB PLUG RIGHT ANGLE**



**Standard Flexible Cable Assemblies**

RG59B/U Coax, 75 Ohm						
Part No. <a href="#">PE34687</a>	Cable Dia.	Attn. @ 1 GHz	Power @ 1 GHz			
1 piece price shown. See web or call for volume pricing.				0.242" dia.	11.5 dB/100ft	40
12"	24"	36"	48"	60"	72"	Custom Len.
\$64.56	\$65.56	\$66.53	\$67.55	\$68.53	\$74.24	See Web

RG179B/U Coax, 75 Ohm						
Part No. <a href="#">PE34689</a>	Cable Dia.	Attn. @ 1 GHz	Power @ 1 GHz			
1 piece price shown. See web or call for volume pricing.				0.1" dia.	25 dB/100ft	41
12"	24"	36"	48"	60"	72"	Custom Len.
\$72.40	\$68.39	\$71.03	\$73.68	\$76.25	\$78.89	See Web

RG187A/U Coax, 75 Ohm						
Part No. <a href="#">PE34690</a>	Cable Dia.	Attn. @ 1 GHz	Power @ 1 GHz			
1 piece price shown. See web or call for volume pricing.				0.11" dia.	25 dB/100ft	42
12"	24"	36"	48"	60"	72"	Custom Len.
\$66.81	\$70.44	\$74.08	\$77.62	\$81.26	\$84.89	See Web

PE-B159-BL Coax, 75 Ohm						
Part No. <a href="#">PE38140</a>	Cable Dia.	Attn. @ 1 GHz	Power @ 1 GHz			
1 piece price shown. See web or call for volume pricing.				0.159" dia.	10.5 dB/100ft	43
12"	24"	36"	48"	60"	72"	Custom Len.
\$82.05	\$83.70	\$85.36	\$87.00	\$88.66	\$90.29	See Web

**75 OHM MINI SMB PLUG TO 75 OHM MINI SMB JACK**



**Standard Flexible Cable Assemblies**

PE-B159-BL Coax, 75 Ohm						
Part No. <a href="#">PE38141</a>	Cable Dia.	Attn. @ 1 GHz	Power @ 1 GHz			
1 piece price shown. See web or call for volume pricing.				0.159" dia.	10.5 dB/100ft	44
12"	24"	36"	48"	60"	72"	Custom Len.
Call	Call	Call	Call	Call	Call	See Web

**75 OHM MINI SMB PLUG TO 75 OHM TNC MALE**



**Standard Flexible Cable Assemblies**

RG59B/U Coax, 75 Ohm						
Part No. <a href="#">PE3C6086</a>	Cable Dia.	Attn. @ 1 GHz	Power @ 1 GHz			
1 piece price shown. See web or call for volume pricing.				0.242" dia.	11.5 dB/100ft	45
12"	24"	36"	48"	60"	50CM	Custom Len.
\$57.53	\$58.63	\$59.74	\$60.85	\$61.96	\$58.23	See Web

**75 OHM MINI SMB PLUG RIGHT ANGLE TO 75 OHM F FEMALE BULKHEAD**



SEE MOUNTING HOLE SECTION ON PAGE 409

**Standard Flexible Cable Assemblies**

RG187A/U Coax, 75 Ohm						
Part No. <a href="#">PE3W07602</a>	Cable Dia.	Attn. @ 1 GHz	Power @ 1 GHz			
1 piece price shown. See web or call for volume pricing.				0.102" dia.	200 W	46
12"	24"	36"	48"	60"	50CM	Custom Len.
\$53.50	\$57.58	\$62.14	\$66.72	\$71.27	\$55.94	See Web

**75 OHM MINI SMB PLUG RIGHT ANGLE TO 75 OHM MINI SMB PLUG RIGHT ANGLE**



**Standard Flexible Cable Assemblies**

RG59B/U Coax, 75 Ohm						
Part No. <a href="#">PE34692</a>	Cable Dia.	Attn. @ 1 GHz	Power @ 1 GHz			
1 piece price shown. See web or call for volume pricing.				0.242" dia.	11.5 dB/100ft	47
12"	24"	36"	48"	60"	72"	Custom Len.
\$79.34	\$80.34	\$81.33	\$82.32	\$83.29	\$84.29	See Web

RG179B/U Coax, 75 Ohm						
Part No. <a href="#">PE34694</a>	Cable Dia.	Attn. @ 1 GHz	Power @ 1 GHz			
1 piece price shown. See web or call for volume pricing.				0.1" dia.	25 dB/100ft	48
12"	24"	36"	48"	60"	72"	Custom Len.
\$83.54	\$78.56	\$89.16	\$83.77	\$86.36	\$88.95	See Web

RG187A/U Coax, 75 Ohm						
Part No. <a href="#">PE34696</a>	Cable Dia.	Attn. @ 1 GHz	Power @ 1 GHz			
1 piece price shown. See web or call for volume pricing.				0.11" dia.	25 dB/100ft	49
12"	24"	36"	48"	60"	72"	Custom Len.
\$70.04	\$73.68	\$77.24	\$80.86	\$84.49	\$88.12	See Web

**75 OHM N MALE TO 75 OHM BNC MALE**



**Standard Flexible Cable Assemblies**

RG6A/U Coax, 75 Ohm						
Part No. <a href="#">PE3341</a>	Cable Dia.	Attn. @ 1 GHz	Power @ 1 GHz			
1 piece price shown. See web or call for volume pricing.				0.332" dia.	11 dB/100ft	50
12"	24"	36"	48"	60"	72"	Custom Len.
\$61.83	\$61.29	\$64.23	\$67.16	\$70.11	\$73.05	See Web

Cable Assemblies

See Our Website For Current Pricing & Real-Time Stock Availability!

For Custom Lengths, Metric Lengths or Special Configurations, Please call (949) 261-1920



Technical Support  
+1 (949) 261-1920



Same-Day Shipping,  
Even Custom Cable Assemblies

For our complete selection of cable assemblies, please visit our website

Cable Assemblies

See Our Website For Current Pricing & Real-Time Stock Availability!

RG11A/U Coax, 75 Ohm						
Part No. <b>PE3396</b>		Cable Dia.	Attn. @ 1 GHz	Power @ 1 GHz	51	
1 piece price shown. See web or call for volume pricing.						
12"	24"	36"	48"	60"	72"	Custom Len.
\$72.35	\$74.19	\$76.05	\$77.84	\$79.69	\$81.45	See Web
RG59B/U Coax, 75 Ohm						
Part No. <b>PE33605</b>		Cable Dia.	Attn. @ 1 GHz	Power @ 1 GHz	52	
1 piece price shown. See web or call for volume pricing.						
12"	24"	36"	48"	60"	72"	Custom Len.
\$53.70	\$54.25	\$55.32	\$60.94	\$57.42	\$63.27	See Web
RG179B/U Coax, 75 Ohm						
Part No. <b>PE3398</b>		Cable Dia.	Attn. @ 1 GHz	Power @ 1 GHz	53	
1 piece price shown. See web or call for volume pricing.						
12"	24"	36"	48"	60"	72"	Custom Len.
\$64.68	\$67.28	\$74.18	\$77.16	\$80.01	\$82.88	See Web
RG187A/U Coax, 75 Ohm						
Part No. <b>PE3400</b>		Cable Dia.	Attn. @ 1 GHz	Power @ 1 GHz	54	
1 piece price shown. See web or call for volume pricing.						
12"	24"	36"	48"	60"	72"	Custom Len.
\$62.05	\$65.61	\$69.25	\$72.89	\$76.50	\$80.14	See Web
75 OHM N MALE TO 75 OHM F MALE						
Low Loss Flexible Cable Assemblies						
PE-SF200LL75 Coax, 75 Ohm						
Part No. <b>PE3TC1205</b>		Cable Dia.	Attn. @ 1 GHz	Power @ 1 GHz	55	
1 piece price shown. See web or call for volume pricing.						
24"	36"	48"	72"	100CM	200CM	Custom Len.
\$128.07	\$140.28	\$152.49	\$176.89	\$143.72	\$183.76	See Web
Standard Flexible Cable Assemblies						
PE-75Test.35 Coax, 75 Ohm						
Part No. <b>PE3CA1031</b>		Cable Dia.	Attn. @ 1 GHz	Power @ 1 GHz	56	
1 piece price shown. See web or call for volume pricing.						
40CM	60CM	100CM	-	-	-	Custom Len.
Call	\$284.41	Call	-	-	-	See Web
75 OHM N MALE TO 75 OHM F FEMALE						
Low Loss Flexible Cable Assemblies						
PE-SF200LL75 Coax, 75 Ohm						
Part No. <b>PE3TC1204</b>		Cable Dia.	Attn. @ 1 GHz	Power @ 1 GHz	57	
1 piece price shown. See web or call for volume pricing.						
24"	36"	48"	72"	100CM	200CM	Custom Len.
\$128.07	\$140.28	\$152.49	\$176.89	\$143.72	\$183.76	See Web
75 OHM N MALE TO 75 OHM N MALE						
Low Loss Flexible Cable Assemblies						
PE-SF200LL75 Coax, 75 Ohm						
Part No. <b>PE3TC1200</b>		Cable Dia.	Attn. @ 1 GHz	Power @ 1 GHz	58	
1 piece price shown. See web or call for volume pricing.						
6"	12"	24"	36"	48"	72"	Custom Len.
		\$163.01	\$175.22	\$187.43	\$211.83	See Web
Standard Flexible Cable Assemblies						
RG6A/U Coax, 75 Ohm						
Part No. <b>PE3612</b>		Cable Dia.	Attn. @ 1 GHz	Power @ 1 GHz	59	
1 piece price shown. See web or call for volume pricing.						
12"	24"	36"	48"	60"	72"	Custom Len.
\$66.63	\$69.56	\$72.52	\$75.46	\$78.40	\$81.34	See Web
RG11A/U Coax, 75 Ohm						
Part No. <b>PE3616</b>		Cable Dia.	Attn. @ 1 GHz	Power @ 1 GHz	60	
1 piece price shown. See web or call for volume pricing.						
12"	24"	36"	48"	60"	72"	Custom Len.
\$75.86	\$84.19	\$86.47	\$88.87	\$91.19	\$84.96	See Web
RG59B/U Coax, 75 Ohm						
Part No. <b>PE3528</b>		Cable Dia.	Attn. @ 1 GHz	Power @ 1 GHz	61	
1 piece price shown. See web or call for volume pricing.						
12"	24"	36"	48"	60"	72"	Custom Len.
\$66.75	\$71.88	\$68.84	\$69.90	\$75.40	\$76.57	See Web
RG179B/U Coax, 75 Ohm						
Part No. <b>PE3307</b>		Cable Dia.	Attn. @ 1 GHz	Power @ 1 GHz	62	
1 piece price shown. See web or call for volume pricing.						
12"	24"	36"	48"	60"	72"	Custom Len.
\$77.82	\$80.42	\$83.00	\$85.63	\$88.22	\$96.81	See Web
RG187A/U Coax, 75 Ohm						
Part No. <b>PE3581</b>		Cable Dia.	Attn. @ 1 GHz	Power @ 1 GHz	63	
1 piece price shown. See web or call for volume pricing.						
12"	24"	36"	48"	60"	72"	Custom Len.
\$74.40	\$84.56	\$81.60	\$85.22	\$88.85	\$92.49	See Web

PE-75Test.35 Coax, 75 Ohm						
Part No. <b>PE3CA1032</b>		Cable Dia.	Attn. @ 1 GHz	Power @ 1 GHz	64	
1 piece price shown. See web or call for volume pricing.						
60CM	80CM	90CM	100CM	-	-	Custom Len.
\$323.03	Call	Call	Call	-	-	See Web
75 OHM N MALE TO 75 OHM N FEMALE						
Low Loss Flexible Cable Assemblies						
PE-SF200LL75 Coax, 75 Ohm						
Part No. <b>PE3TC1201</b>		Cable Dia.	Attn. @ 1 GHz	Power @ 1 GHz	65	
1 piece price shown. See web or call for volume pricing.						
24"	36"	48"	72"	100CM	200CM	Custom Len.
\$158.04	\$170.25	\$182.45	\$206.87	\$173.67	\$213.72	See Web
75 OHM N FEMALE TO 75 OHM N FEMALE						
Standard Flexible Cable Assemblies						
RG11A/U Coax, 75 Ohm						
Part No. <b>PE3W04530</b>		Cable Dia.	Attn. @ 1 GHz	Power @ 1 GHz	66	
1 piece price shown. See web or call for volume pricing.						
12"	24"	36"	48"	60"	50CM	Custom Len.
\$95.71	\$98.14	\$100.57	\$103.02	\$105.45	\$97.27	See Web
75 OHM RCA MALE TO 75 OHM RCA MALE						
Standard Flexible Cable Assemblies						
PE-B159-BL Coax, 75 Ohm						
Part No. <b>PE38133</b>		Cable Dia.	Attn. @ 1 GHz	Power @ 1 GHz	67	
1 piece price shown. See web or call for volume pricing.						
12"	24"	36"	48"	60"	72"	Custom Len.
\$50.91	\$52.59	\$54.23	\$55.39	\$57.05	\$58.70	See Web
75 OHM RCA MALE TO 75 OHM RCA MALE RIGHT ANGLE						
Standard Flexible Cable Assemblies						
PE-B159-BL Coax, 75 Ohm						
Part No. <b>PE38134</b>		Cable Dia.	Attn. @ 1 GHz	Power @ 1 GHz	68	
1 piece price shown. See web or call for volume pricing.						
12"	24"	36"	48"	60"	72"	Custom Len.
\$54.12	\$55.27	\$56.91	\$58.56	\$60.21	\$61.86	See Web
75 OHM RCA MALE TO 75 OHM RCA FEMALE BULKHEAD						
SEE MOUNTING HOLE SECTION ON PAGE 409						
Standard Flexible Cable Assemblies						
PE-B159-BL Coax, 75 Ohm						
Part No. <b>PE38135</b>		Cable Dia.	Attn. @ 1 GHz	Power @ 1 GHz	69	
1 piece price shown. See web or call for volume pricing.						
12"	24"	36"	48"	60"	72"	Custom Len.
\$50.91	\$52.59	\$54.23	\$55.39	\$57.05	\$58.70	See Web
75 OHM SMB PLUG TO 75 OHM BNC MALE						
Standard Flexible Cable Assemblies						
RG59B/U Coax, 75 Ohm						
Part No. <b>PE33270</b>		Cable Dia.	Attn. @ 1 GHz	Power @ 1 GHz	70	
1 piece price shown. See web or call for volume pricing.						
12"	24"	36"	48"	60"	72"	Custom Len.
\$57.97	\$59.11	\$60.26	\$56.85	\$57.90	\$58.94	See Web
RG179B/U Coax, 75 Ohm						
Part No. <b>PE33247</b>		Cable Dia.	Attn. @ 1 GHz	Power @ 1 GHz	71	
1 piece price shown. See web or call for volume pricing.						
12"	24"	36"	48"	60"	72"	Custom Len.
\$63.15	\$61.07	\$68.78	\$71.75	\$74.62	\$77.47	See Web
PE-B150 Coax, 75 Ohm						
Part No. <b>PE33644</b>		Cable Dia.	Attn. @ 1 GHz	Power @ 1 GHz	72	
1 piece price shown. See web or call for volume pricing.						
12"	24"	36"	48"	60"	72"	Custom Len.
\$64.39	\$65.26	\$66.13	\$67.00	\$67.87	\$68.74	See Web

\*Coax Performance at 1 GHz Notes: Cable assembly max frequency may be lower than connector or coax max frequency



For our complete selection of cable assemblies, please visit our website

75 OHM SMB PLUG TO 75 OHM SMB PLUG						
Standard Flexible Cable Assemblies						
RG59B/U Coax, 75 Ohm						
Part No. <a href="#">PE3041</a>	Cable Dia.	Attn. @ 1 GHz	Power @ 1 GHz			
1 piece price shown. See web or call for volume pricing.	0.242" dia.	11.5 dB/100ft	77 W			
12"	24"	36"	48"	60"	72"	Custom Len.
\$65.83	\$66.88	\$67.94	\$69.00	\$70.04	\$71.10	See Web
RG179B/U Coax, 75 Ohm						
Part No. <a href="#">PE3100</a>	Cable Dia.	Attn. @ 1 GHz	Power @ 1 GHz			
1 piece price shown. See web or call for volume pricing.	0.1" dia.	29.15 dB/100ft	25 W			
12"	24"	36"	48"	60"	72"	Custom Len.
\$59.62	\$67.19	\$64.83	\$67.45	\$70.11	\$78.72	See Web
PE-B150 Coax, 75 Ohm						
Part No. <a href="#">PE3112</a>	Cable Dia.	Attn. @ 1 GHz	Power @ 1 GHz			
1 piece price shown. See web or call for volume pricing.	0.15" dia.	20 dB/100ft	25 W			
12"	24"	36"	48"	60"	72"	Custom Len.
\$64.44	\$65.23	\$66.10	\$66.87	\$67.72	\$68.53	See Web

75 OHM SMC PLUG TO 75 OHM BNC MALE						
Standard Flexible Cable Assemblies						
RG59B/U Coax, 75 Ohm						
Part No. <a href="#">PE33330</a>	Cable Dia.	Attn. @ 1 GHz	Power @ 1 GHz			
1 piece price shown. See web or call for volume pricing.	0.242" dia.	11.5 dB/100ft	77 W			
12"	24"	36"	48"	60"	72"	Custom Len.
\$51.14	\$54.85	\$53.28	\$54.34	\$58.37	\$55.95	See Web
RG179B/U Coax, 75 Ohm						
Part No. <a href="#">PE33586</a>	Cable Dia.	Attn. @ 1 GHz	Power @ 1 GHz			
1 piece price shown. See web or call for volume pricing.	0.1" dia.	20 dB/100ft	200 W			
12"	24"	36"	48"	60"	72"	Custom Len.
\$66.14	\$64.99	\$71.76	\$70.18	\$77.60	\$80.46	See Web
PE-B150 Coax, 75 Ohm						
Part No. <a href="#">PE33646</a>	Cable Dia.	Attn. @ 1 GHz	Power @ 1 GHz			
1 piece price shown. See web or call for volume pricing.	0.15" dia.	20 dB/100ft	25 W			
12"	24"	36"	48"	60"	72"	Custom Len.
\$69.49	\$74.69	\$71.23	\$72.11	\$72.97	\$78.83	See Web

75 OHM SMC PLUG TO 75 OHM SMC PLUG						
Standard Flexible Cable Assemblies						
RG59B/U Coax, 75 Ohm						
Part No. <a href="#">PE3362</a>	Cable Dia.	Attn. @ 1 GHz	Power @ 1 GHz			
1 piece price shown. See web or call for volume pricing.	0.242" dia.	11.5 dB/100ft	77 W			
12"	24"	36"	48"	60"	72"	Custom Len.
\$62.50	\$63.56	\$71.05	\$66.66	\$66.73	\$67.77	See Web
RG179B/U Coax, 75 Ohm						
Part No. <a href="#">PE3376</a>	Cable Dia.	Attn. @ 1 GHz	Power @ 1 GHz			
1 piece price shown. See web or call for volume pricing.	0.1" dia.	25 dB/100ft	200 W			
12"	24"	36"	48"	60"	72"	Custom Len.
\$64.83	\$67.40	\$70.04	\$72.61	\$75.26	\$77.89	See Web
PE-B150 Coax, 75 Ohm						
Part No. <a href="#">PE3388</a>	Cable Dia.	Attn. @ 1 GHz	Power @ 1 GHz			
1 piece price shown. See web or call for volume pricing.	0.15" dia.	20 dB/100ft	25 W			
12"	24"	36"	48"	60"	72"	Custom Len.
\$78.53	\$84.26	\$80.27	\$81.13	\$82.01	\$82.87	See Web

75 OHM TNC MALE TO 75 OHM BNC MALE						
Standard Flexible Cable Assemblies						
RG6A/U Coax, 75 Ohm						
Part No. <a href="#">PE35350</a>	Cable Dia.	Attn. @ 1 GHz	Power @ 1 GHz			
1 piece price shown. See web or call for volume pricing.	0.332" dia.	11 dB/100ft	125 W			
12"	24"	36"	48"	60"	72"	Custom Len.
\$55.79	\$55.58	\$58.52	\$61.46	\$64.41	\$67.35	See Web
RG11A/U Coax, 75 Ohm						
Part No. <a href="#">PE35354</a>	Cable Dia.	Attn. @ 1 GHz	Power @ 1 GHz			
1 piece price shown. See web or call for volume pricing.	0.405" dia.		150 W			
12"	24"	36"	48"	60"	72"	Custom Len.
\$88.02	\$89.93	\$91.79	\$93.69	\$95.58	\$97.46	See Web
RG59B/U Coax, 75 Ohm						
Part No. <a href="#">PE35358</a>	Cable Dia.	Attn. @ 1 GHz	Power @ 1 GHz			
1 piece price shown. See web or call for volume pricing.	0.242" dia.	11.5 dB/100ft	77 W			
12"	24"	36"	48"	60"	72"	Custom Len.
\$48.38	\$49.43	\$50.49	\$51.55	\$52.62	\$56.62	See Web

RG179B/U Coax, 75 Ohm						
Part No. <a href="#">PE35362</a>	Cable Dia.	Attn. @ 1 GHz	Power @ 1 GHz			
1 piece price shown. See web or call for volume pricing.	0.1" dia.	25 dB/100ft	200 W			
12"	24"	36"	48"	60"	72"	Custom Len.
\$63.54	\$66.34	\$64.03	\$66.64	\$69.23	\$71.82	See Web
RG187A/U Coax, 75 Ohm						
Part No. <a href="#">PE35366</a>	Cable Dia.	Attn. @ 1 GHz	Power @ 1 GHz			
1 piece price shown. See web or call for volume pricing.	0.11" dia.	25 dB/100ft	200 W			
12"	24"	36"	48"	60"	72"	Custom Len.
\$55.44	\$59.09	\$62.72	\$66.27	\$69.91	\$73.53	See Web

75 OHM TNC MALE TO 75 OHM TNC MALE						
Standard Flexible Cable Assemblies						
RG6A/U Coax, 75 Ohm						
Part No. <a href="#">PE35348</a>	Cable Dia.	Attn. @ 1 GHz	Power @ 1 GHz			
1 piece price shown. See web or call for volume pricing.	0.332" dia.	11 dB/100ft	125 W			
12"	24"	36"	48"	60"	72"	Custom Len.
\$58.54	\$61.48	\$64.43	\$67.36	\$70.31	\$73.25	See Web
RG11A/U Coax, 75 Ohm						
Part No. <a href="#">PE35352</a>	Cable Dia.	Attn. @ 1 GHz	Power @ 1 GHz			
1 piece price shown. See web or call for volume pricing.	0.405" dia.		150 W			
12"	24"	36"	48"	60"	72"	Custom Len.
\$97.17	\$98.94	\$100.78	\$102.56	\$104.41	\$106.27	See Web
RG59B/U Coax, 75 Ohm						
Part No. <a href="#">PE35356</a>	Cable Dia.	Attn. @ 1 GHz	Power @ 1 GHz			
1 piece price shown. See web or call for volume pricing.	0.242" dia.	11.5 dB/100ft	77 W			
12"	24"	36"	48"	60"	72"	Custom Len.
\$56.19	\$60.70	\$61.85	\$59.36	\$60.40	\$65.38	See Web
RG179B/U Coax, 75 Ohm						
Part No. <a href="#">PE35360</a>	Cable Dia.	Attn. @ 1 GHz	Power @ 1 GHz			
1 piece price shown. See web or call for volume pricing.	0.1" dia.	25 dB/100ft	200 W			
12"	24"	36"	48"	60"	72"	Custom Len.
\$71.53	\$68.83	\$71.43	\$74.04	\$76.64	\$85.86	See Web
RG187A/U Coax, 75 Ohm						
Part No. <a href="#">PE35364</a>	Cable Dia.	Attn. @ 1 GHz	Power @ 1 GHz			
1 piece price shown. See web or call for volume pricing.	0.11" dia.	25 dB/100ft	200 W			
12"	24"	36"	48"	60"	72"	Custom Len.
\$61.27	\$64.83	\$68.47	\$72.11	\$75.71	\$79.34	See Web

75 OHM BNC MALE TO STRAIGHT CUT LEAD SEXLESS						
Flexible Cable Assemblies						
RG187A/U Coax, 75 Ohm						
Part No. <a href="#">PE39599</a>	Cable Dia.	Attn. @ 1 GHz	Power @ 1 GHz			
1 piece price shown. See web or call for volume pricing.	0.11" dia.	25 dB/100ft	200 W			
12"	24"	36"	48"	60"	50CM	Custom Len.
\$48.62	\$53.44	\$53.98	\$54.56	\$55.62	\$49.27	See Web

BNC TWINAX PLUG TO BNC TWINAX PLUG						
Standard Flexible Cable Assemblies						
RG108A/U Coax, 78 Ohm						
Part No. <a href="#">PE3480</a>	Cable Dia.	Attn. @ 1 GHz	Power @ 1 GHz			
1 piece price shown. See web or call for volume pricing.	0.235" dia.	26.2 dB/100ft	30 W			
18"	36"	60"	90"	120"	180"	Custom Len.
\$83.32	\$87.43	\$93.12	\$119.37	\$107.11	\$119.39	See Web

3/4"-20 TWINAX MALE TO 3/4"-20 TWINAX MALE						
Standard Flexible Cable Assemblies						
PE-S330 Coax, 100 Ohm						
Part No. <a href="#">PE3930</a>	Cable Dia.	Attn. @ 1 GHz	Power @ 1 GHz			
1 piece price shown. See web or call for volume pricing.	0.33" dia.					
18"	36"	60"	90"	120"	180"	Custom Len.
\$88.28	\$92.66	\$98.50	\$105.80	\$111.52	\$125.91	See Web

BANANA PLUG TO SMA MALE						
Standard Flexible Cable Assemblies						
RG188-DS Coax, 50 Ohm						
Part No. <a href="#">PE3W06020</a>	Cable Dia.	Attn. @ 1 GHz	Power @ 1 GHz			
1 piece price shown. See web or call for volume pricing.	0.118" dia.	30 dB/100ft	160 W			
12"	24"	36"	48"	60"	50CM	Custom Len.
\$41.59	\$45.70	\$49.79	\$53.89	\$57.47	\$44.22	See Web

Cable Assemblies

See Our Website For Current Pricing & Real-Time Stock Availability!

For Custom Lengths, Metric Lengths or Special Configurations, Please call (949) 261-1920

Technical Support  
+1 (949) 261-1920

Same-Day Shipping,  
Even Custom Cable Assemblies



# CIRCULATORS AND ISOLATORS

## Circulators

### Dual Junction



Connector	Frequency Range (MHz.)	Maximum Power	VSWR Max.	Isolation (dB Min.)	Model No	1 Pc. Price	See Web for Volume Pricing	ROW
N	1,000 - 2,000	50 Watt	1.35:1	36	<a href="#">PE83CR1014</a>	\$1,523.70	See Web for Volume Pricing	1
	1,700 - 2,200		1.25:1	40	<a href="#">PE83CR1016</a>	\$907.52		2
	2,000 - 4,000	10 Watt	1.3:1	36	<a href="#">PE83CR1018</a>	\$911.36		3
	4,000 - 8,000			40	<a href="#">PE83CR1020</a>	\$692.23		4
	7,000 - 12,400		40	<a href="#">PE83CR1022</a>	\$643.64	5		
SMA	1,000 - 2,000	50 Watt	1.35:1	36	<a href="#">PE83CR1013</a>	\$1,793.42		6
	1,700 - 2,200		1.25:1	40	<a href="#">PE83CR1015</a>	\$942.92		7
	2,000 - 4,000	10 Watt	1.3:1	40	<a href="#">PE83CR1017</a>	\$838.00		8
	4,000 - 8,000			36	<a href="#">PE83CR1019</a>	\$875.89		9
	7,000 - 12,400		40	<a href="#">PE83CR1021</a>	\$643.64	10		
	8,000 - 18,000	5 Watt	1.45:1	32	<a href="#">PE83CR1023</a>	\$862.87		11
	11,000 - 18,000		1.25:1	40	<a href="#">PE83CR1024</a>	\$835.96		12
	18,000 - 26,500		1.4:1	34	<a href="#">PE83CR1025</a>	\$938.62		13

### Single Junction



Connector	Frequency Range (MHz.)	Maximum Power	VSWR Max.	Isolation (dB Min.)	Model No	1 Pc. Price	See Web for Volume Pricing	ROW
2.92mm	18,000 - 26,500	10 Watt	1.8:1	12	<a href="#">PE83CR1027</a>	\$1,044.68	See Web for Volume Pricing	14
	22,000 - 33,000		1.7:1	13	<a href="#">PE83CR1028</a>	\$1,002.04		15
	26,500 - 40,000		1.8:1	12	<a href="#">PE83CR1032</a>	\$1,133.02		16
	32,000 - 36,000		1.8:1	14	<a href="#">PE83CR1029</a>	\$1,075.15		17
N	135 - 175	150 Watt	1.3:1	20	<a href="#">PE8427</a>	\$1,602.97		18
	330 - 403				<a href="#">PE8429</a>	\$1,428.51		19
	380 - 460	1000 Watt	1.25:1	20	<a href="#">PE8423</a>	\$555.01		20
	450 - 520	150 Watt			<a href="#">PE8431</a>	\$1,365.49		21
	698 - 960	1000 Watt	1.3:1	18	<a href="#">PE8419</a>	\$456.10		22
	1,000 - 2,000	10 Watt	1.35:1	18	<a href="#">PE8410</a>	\$1,024.77		23
	1,000 - 2,000	100 Watt			<a href="#">PE83CR1001</a>	\$1,218.25		24
	1,700 - 2,200	10 Watt	1.25:1	20	<a href="#">PE8415</a>	\$470.11		25
	1,700 - 2,200	100 Watt			<a href="#">PE83CR1003</a>	\$754.98		26
	2,000 - 4,000	10 Watt	1.3:1	18	<a href="#">PE8411</a>	\$756.13	27	
	2,000 - 4,000	100 Watt			<a href="#">PE83CR1005</a>	\$727.71	28	
	2,000 - 4,000	100 Watt	1.35:1	20	<a href="#">PE83CR1031</a>	\$386.82	29	
	4,000 - 8,000				<a href="#">PE8412</a>	\$632.95	30	
	4,000 - 8,000	50 Watt	1.3:1	18	<a href="#">PE83CR1007</a>	\$573.93	31	
7,000 - 12,400	10 Watt	<a href="#">PE8413</a>			\$542.32	32		
7,000 - 12,400	50 Watt	1.25:1	20	<a href="#">PE83CR1009</a>	\$472.04	33		
SMA	135 - 175	150 Watt	1.3:1	20	<a href="#">PE8426</a>	\$1,635.02	34	
	330 - 403				<a href="#">PE8428</a>	\$1,484.22	35	
	380 - 460	1000 Watt	1.25:1	20	<a href="#">PE8422</a>	\$546.82	36	
	450 - 520	150 Watt			<a href="#">PE8430</a>	\$1,365.49	37	
	698 - 960	1000 Watt	1.3:1	18	<a href="#">PE8418</a>	\$475.39	38	
	700 - 800	10 Watt	1.25:1	19	<a href="#">PE83CR001</a>	\$205.75	39	
	800 - 960				<a href="#">PE83CR007</a>	\$262.42	40	
	1,000 - 2,000				<a href="#">PE83CR003</a>	\$315.62	41	
	1,000 - 2,000	100 Watt	1.35:1	17	<a href="#">PE8400</a>	\$774.63	42	
	1,000 - 2,000				<a href="#">PE83CR1000</a>	\$1,218.25	43	
	1,700 - 2,200				<a href="#">PE8414</a>	\$498.71	44	
	1,700 - 2,200	100 Watt	1.25:1	20	<a href="#">PE83CR1002</a>	\$725.95	45	

Circulators & Isolators

See Our Website For Current Pricing & Real-Time Stock Availability!

## Circulators

### Single Junction



Connector	Frequency Range (MHz.)	Maximum Power	VSWR Max.	Isolation (dB Min.)	Model No	1 Pc. Price	See Web for Volume Pricing			R O W
SMA	1,700 - 2,400	10 Watt	1.3:1	17	<a href="#">PE83CR004</a>	\$201.97	See Web for Volume Pricing			46
	2,000 - 4,000				<a href="#">PE83CR005</a>	\$252.73				47
	2,000 - 4,000				100 Watt	1.3:1				18
	2,000 - 4,000	<a href="#">PE83CR1004</a>	\$686.92	49						
	2,000 - 4,000	25 Watt	1.35:1	18	<a href="#">PE83CR1030</a>	\$417.27				50
	2,000 - 6,000				<a href="#">PE8432</a>	\$932.00				51
	3,000 - 5,000	10 Watt	1.3:1	18	<a href="#">PE83CR1033</a>	\$466.00				52
	4,000 - 8,000				<a href="#">PE83CR006</a>	\$252.29				53
	4,000 - 8,000				<a href="#">PE8402</a>	\$328.70				54
	4,000 - 8,000	50 Watt	1.3:1	18	<a href="#">PE83CR1006</a>	\$654.16				55
	4,000 - 8,000				<a href="#">PE83CR1034</a>	\$435.55				56
	6,000 - 18,000	10 Watt	1.5:1	14	<a href="#">PE8433</a>	\$868.32				57
	7,000 - 12,400				<a href="#">PE83CR000</a>	\$210.06				58
	7,000 - 12,400				<a href="#">PE8403</a>	\$303.37				59
	7,000 - 12,400	50 Watt	1.25:1	20	<a href="#">PE83CR1008</a>	\$490.45				60
	8,000 - 12,000				<a href="#">PE83CR1026</a>	\$539.10				61
	8,000 - 18,000	10 Watt	1.55:1	13	<a href="#">PE83CR002</a>	\$315.62				62
	8,000 - 18,000				<a href="#">PE8404</a>	\$367.00				63
	8,000 - 18,000				50 Watt	1.45:1				16
	11,000 - 18,000	<a href="#">PE8405</a>	\$404.60	65						
11,000 - 18,000	10 Watt	1.25:1	20	<a href="#">PE83CR1011</a>	\$539.76	66				
11,000 - 18,000	50 Watt			<a href="#">PE8406</a>	\$375.33	67				
18,000 - 26,500	10 Watt	1.4:1	17	<a href="#">PE83CR1012</a>	\$558.92	68				
18,000 - 26,500	50 Watt									

## Isolators

### Dual Junction



Connector	Frequency Range (MHz.)	Maximum Power	VSWR Max.	Isolation (dB Min.)	Model No	1 Pc. Price	See Web for Volume Pricing			R O W
N	1,000 - 2,000	50 Watt	1.35:1	36	<a href="#">PE83IR1014</a>	\$1,525.43	See Web for Volume Pricing			69
	1,700 - 2,200				<a href="#">PE83IR1016</a>	\$880.41				70
	2,000 - 4,000				<a href="#">PE83IR1018</a>	\$858.84				71
	4,000 - 8,000	10 Watt	1.3:1	36	<a href="#">PE83IR1020</a>	\$725.65				72
	7,000 - 12,400	5 Watt			<a href="#">PE83IR1022</a>	\$625.01				73
SMA	1,000 - 2,000	50 Watt	1.35:1	36	<a href="#">PE83IR1013</a>	\$1,525.43	74			
	1,700 - 2,200				1.25:1	40	<a href="#">PE83IR1015</a>	\$928.44	75	
	2,000 - 4,000						<a href="#">PE83IR1017</a>	\$874.80	76	
	4,000 - 8,000	10 Watt	1.3:1	36	<a href="#">PE83IR1019</a>	\$811.73	77			
	7,000 - 12,400	5 Watt			1.25:1	40	<a href="#">PE83IR1021</a>	\$917.73	78	
	8,000 - 18,000		1.45:1	32			<a href="#">PE83IR1023</a>	\$883.61	79	
	11,000 - 18,000		1.25:1	40			<a href="#">PE83IR1024</a>	\$823.11	80	
	18,000 - 26,500	1.4:1	34	<a href="#">PE83IR1025</a>	\$946.99	81				

### Single Junction



Connector	Frequency Range (MHz.)	Maximum Power	VSWR Max.	Isolation (dB Min.)	Model No	1-4	5-9	10-24	25+	R O W
2.4mm	35,000 - 42,500	10 Watt	1.6:1	14	<a href="#">PE83IR1038</a>	\$1,038.61	\$986.68	\$934.75	\$893.20	82
2.92mm	18,000 - 26,500	10 Watt	1.7:1	14	<a href="#">PE83IR1033</a>	\$817.17	\$776.31	\$735.45	\$702.77	83
	18,000 - 26,500				<a href="#">PE83IR1041</a>	\$1,771.57	\$1,682.99	\$1,594.41	\$1,523.55	84

Circulators & Isolators

See Our Website For Current Pricing & Real-Time Stock Availability!



Technical Support  
+1 (949) 261-1920



Same-Day Shipping,  
Even Custom Cable Assemblies

## Isolators

### Single Junction



Connector	Frequency Range (MHz.)	Maximum Power	VSWR Max.	Isolation (dB Min.)	Model No	1 Pc. Price	See Web for Volume Pricing	R O W
2.92mm	22,000 - 33,000	10 Watt	1.8:1	13	<a href="#">PE83IR1035</a>	\$817.17		85
	26,500 - 40,000	5 Watt	1.5:1	14	<a href="#">PE8320</a>	\$1,228.00		86
	26,500 - 40,000	10 Watt	1.7:1	12	<a href="#">PE83IR1036</a>	\$817.17		87
	26,500 - 40,000	10 Watt	1.7:1	12	<a href="#">PE83IR1037</a>	\$817.17		88
	27,000 - 31,000	5 Watt	1.25:1	20	<a href="#">PE8319</a>	\$1,117.19		89
N	135 - 175	150 Watt	1.3:1	20	<a href="#">PE8322</a>	\$1,641.50		90
	330 - 403		1.25:1		<a href="#">PE8324</a>	\$1,121.98		91
	380 - 460	100 Watt	1.25:1		<a href="#">PE8425</a>	\$581.69		92
	450 - 520	150 Watt	1.25:1		<a href="#">PE8326</a>	\$1,063.94		93
	698 - 960	1000 Watt	1.3:1		18	<a href="#">PE8421</a>	\$505.88	
	1,000 - 2,000	10 Watt	1.35:1	17	<a href="#">PE8310</a>	\$1,215.87		95
	1,000 - 2,000				<a href="#">PE83IR003</a>	\$432.91		96
	1,000 - 2,000	100 Watt	1.25:1	18	<a href="#">PE83IR1001</a>	\$1,346.60		97
	1,700 - 2,200	10 Watt			<a href="#">PE8417</a>	\$278.99		98
	1,700 - 2,200	100 Watt	1.3:1	20	<a href="#">PE83IR1003</a>	\$791.43		99
	2,000 - 4,000	10 Watt			<a href="#">PE8311</a>	\$759.13		1
	2,000 - 4,000	100 Watt	1.3:1	20	<a href="#">PE83IR1005</a>	\$751.36		2
	4,000 - 8,000	10 Watt			<a href="#">PE8312</a>	\$648.15		3
	4,000 - 8,000	50 Watt	1.25:1	20	<a href="#">PE83IR1007</a>	\$661.52		4
	7,000 - 12,400	10 Watt			<a href="#">PE8313</a>	\$822.41		5
SMA	135 - 175	150 Watt	1.3:1	20	<a href="#">PE8321</a>	\$1,857.38		6
	330 - 403		1.25:1		<a href="#">PE8323</a>	\$1,519.90		7
	380 - 460	100 Watt	1.25:1		<a href="#">PE8424</a>	\$543.62		8
	450 - 520	150 Watt	1.25:1		<a href="#">PE8325</a>	\$1,398.32		9
	698 - 960	1000 Watt	1.3:1		18	<a href="#">PE8420</a>	\$478.12	
	800 - 900	100 Watt	1.25:1	20	<a href="#">PE83IR007</a>	\$245.81		11
	1,000 - 2,000	10 Watt	1.35:1	18	<a href="#">PE8300</a>	\$769.90		12
	1,000 - 2,000		1.4:1	17	<a href="#">PE83IR002</a>	\$340.96		13
	1,000 - 2,000	100 Watt	1.5:1	16	<a href="#">PE83IR1032</a>	\$714.25		14
	1,000 - 2,000		1.35:1	18	<a href="#">PE83IR1000</a>	\$1,292.00		15
	1,700 - 2,200	10 Watt	1.25:1	20	<a href="#">PE8416</a>	\$510.69		16
	1,700 - 2,200	100 Watt			<a href="#">PE83IR1002</a>	\$803.28		17
	1,700 - 2,400	10 Watt	1.35:1	18	<a href="#">PE83IR004</a>	\$238.20		18
	2,000 - 4,000		1.3:1		<a href="#">PE8301</a>	\$627.29		19
	2,000 - 4,000		1.4:1		<a href="#">PE83IR005</a>	\$331.41		20
	2,000 - 4,000	100 Watt	1.3:1	20	<a href="#">PE83IR1004</a>	\$745.21		21
	2,000 - 6,000	10 Watt	1.8:1	12	<a href="#">PE83IR1039</a>	\$483.45		22
	2,000 - 6,000	25 Watt	1.5:1	14	<a href="#">PE8327</a>	\$863.07		23
	2,000 - 8,000	10 Watt	1.35:1	15	<a href="#">PE8316</a>	\$1,407.36		24
	2,000 - 10,000			13	<a href="#">PE8317</a>	\$1,407.36		25
	3,500 - 12,800	2 Watt	1.5:1	17	<a href="#">PE8314</a>	\$1,301.92		26
	4,000 - 8,000	10 Watt	1.3:1	18	<a href="#">PE8302</a>	\$359.79		27
	4,000 - 8,000		1.35:1		<a href="#">PE83IR006</a>	\$328.28		28
	4,000 - 8,000	30 Watt	1.3:1	19	<a href="#">PE83IR1040</a>	\$489.68		29
	4,000 - 8,000	50 Watt		18	<a href="#">PE83IR1006</a>	\$549.27		30
	4,000 - 18,000	10 Watt	1.5:1	15	<a href="#">PE8315</a>	\$1,357.58		31
	6,000 - 18,000			14	<a href="#">PE8328</a>	\$1,099.00		32
	6,000 - 18,000	10 Watt	1.6:1	10	<a href="#">PE83IR1029</a>	\$548.95		33
	6,000 - 18,000				<a href="#">PE83IR1030</a>	\$548.95		34
	6,000 - 18,000				<a href="#">PE83IR1031</a>	\$548.95		35
	7,000 - 12,400	1 Watt	1.3:1	18	<a href="#">PE8303</a>	\$317.32		36
	7,000 - 12,400				<a href="#">PE83IR000</a>	\$310.71		37
	8,000 - 12,000	10 Watt	1.35:1	20	<a href="#">PE83IR1026</a>	\$424.18		38
	8,000 - 12,000				<a href="#">PE83IR1027</a>	\$424.18		39
	8,000 - 18,000	1 Watt	1.45:1	16	<a href="#">PE8304</a>	\$337.34		40
8,000 - 18,000	10 Watt	1.5:1	<a href="#">PE83IR001</a>		\$304.80		41	
8,000 - 18,000	50 Watt	1.45:1	18	<a href="#">PE83IR1010A</a>	\$501.52		42	
11,000 - 18,000	1 Watt	1.25:1	20	<a href="#">PE8305</a>	\$309.49		43	
11,000 - 18,000	50 Watt			<a href="#">PE83IR1011</a>	\$524.32		44	
12,000 - 18,000	10 Watt	1.35:1	20	<a href="#">PE83IR1028</a>	\$449.14		45	
17,300 - 22,000		1.25:1		<a href="#">PE8318</a>	\$637.94		46	
18,000 - 26,500	1 Watt	1.4:1	17	<a href="#">PE8306</a>	\$311.48		47	
18,000 - 26,500	10 Watt	1.7:1	14	<a href="#">PE83IR1034</a>	\$804.69		48	
18,000 - 26,500	50 Watt	1.4:1	17	<a href="#">PE83IR1012</a>	\$594.68		49	

See Web  
for  
Volume  
Pricing

Circulators & Isolators

See Our Website For Current Pricing & Real-Time Stock Availability!

# INDEX GUIDE TO COAXIAL CABLES

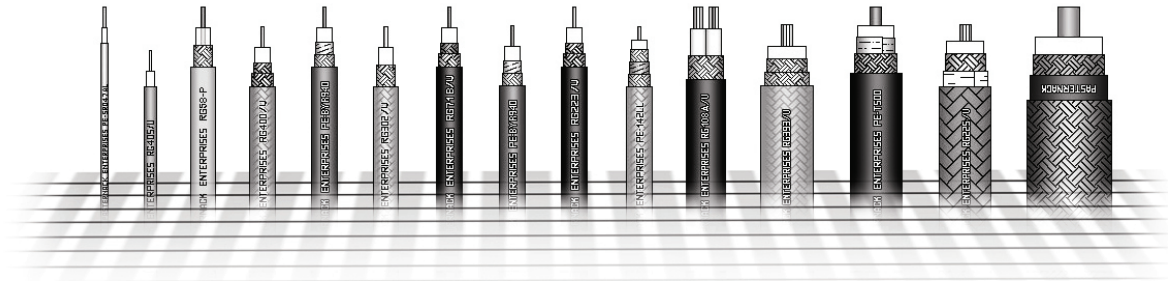

## COAXIAL CABLES.....225

### 75 OHM BROADCAST.....226



Pasternack's selection of 75 Ohm Broadcast coaxial cable includes RG59-P plenum cable, commercial grade RG6-CATV, HD mini 59 cable in multiple colors as well as PTFE jacketed RG187A/U.

### RG MIL-C-17 TYPE CABLE.....227



Pasternack offers 31 different MIL-C-17 compliant coaxial cable types. These cables are available in various diameters, jacket materials, impedances, and velocity factors, providing numerous RF cable options to fit your specific requirements.

### COMMUNICATIONS.....226

Our selection of Low Loss cable is designed with high Velocity Factor (VF) dielectric materials and two outer shields for communications applications requiring Low Loss and High Isolation. These cables are offered in several popular sizes including 0.195", 0.240", 0.400", and 0.600" diameters.



### SEMIRIGID AND FORMABLE.....228

Pasternack's Precision Cables are designed for RF and Microwave applications with frequencies up to 65 GHz. These cables are constructed of copper jacketed and tinned aluminum semirigid designs; and tinned braid conformable cable in both FEP jacketed and unjacketed designs. The semi rigid and conformable cables are available from 0.020 to 0.250 inches in diameter.

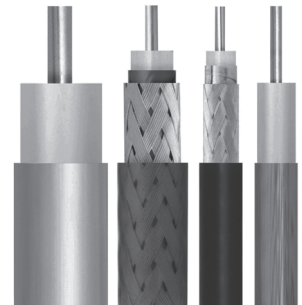

### HIGH PERFORMANCE.....227

Pasternack's line of High Performance Flexible Cable has high Velocity Factors of 70 to 85% and incorporate Spiral Wrapped outer conductors for superior shielding under flexure. These cables are used as flexible cable alternatives to semirigid cable and in many cases use the same connectors.



### TWINAX.....230

Pasternack offers two versions of Twinax cable with an impedance of 100 or 78 ohms. Twinax cable has two center conductors surrounded by a dielectric. The dielectric is surrounded by a braided outer conductor covered by a PVC jacket material. This construction creates a shielded, twisted pair with superior performance when compared to unshielded, twisted pair cable.





# COAXIAL CABLES

Meets or Exceeds MIL-C-17 Specifications Where Applicable

MODEL NO.	COAX IMPEDANCE (Ohm)	JACKET DIAMETER (in)	NUMBER OF SHIELDS	VELOCITY FACTOR (%)	MAX. POWER HANDLING AT 1 GHz (W)	JACKET MATERIAL	PRICE PER FOOT		ROW
	MAXIMUM FREQUENCY (GHz.)	CONDUCTOR DIAM.(in) [strands]	RF SHIELDING (min dB)	ATTENUATION AT 1 GHz. (dB/100 ft)	MAXIMUM OPERATING VOLTAGE (V RMS)	MINIMUM BEND RADIUS (in)	1-99 FT 500-999 FT	100-499 FT 1000 + FT	
<b>75 OHM BROADCAST</b>									
<a href="#">LMR-400-75</a>	75 2.5	0.405 0.065[1]	2 90	85		PE 1	\$1.36 \$1.36	\$1.36 \$1.36	1
<a href="#">PE-B150</a>	75 5	0.150 0.017[7]	1	20	25 600	PVC	\$1.20 \$1.08	\$1.14 \$1.03	2
<a href="#">PE-B159-BK</a>	75 3	0.159 0.023[1]	2	83 10.5	300	PVC 1.5	\$1.17 \$1.05	\$1.11 \$1.01	3
<a href="#">PE-B159-BL</a>	75 3	0.159 0.023[1]	2	83 10.5	300	PVC 1.5	\$1.24 \$1.12	\$1.18 \$1.07	4
<a href="#">PE-B159-GR</a>	75 3	0.159 0.023[1]	2	83 10.5	300	PVC 1.5	\$1.01 \$0.91	\$0.96 \$0.87	5
<a href="#">PE-B159-RD</a>	75 3	0.159 0.023[1]	2	83 10.5	300	PVC 1.5	\$1.05 \$0.95	\$1.00 \$0.90	6
<a href="#">PE-B159-WH</a>	75 3	0.159 0.023[1]	2	83 10.5	300	PVC 1.5	\$0.95 \$0.86	\$0.90 \$0.82	7
<a href="#">PE-B159-YW</a>	75 3	0.159 0.023[1]	2	83 10.5	300	PVC 1.5	\$1.00 \$0.90	\$0.95 \$0.86	8
<a href="#">PE-B305</a>	75 1	0.305 0.031[1]	2	9.2	52 2,900	PVC	\$3.04 \$2.74	\$2.89 \$2.61	9
<a href="#">RG11A/U</a>	75 1	0.405 [7]	1 45	66 8.11	150	PVC	\$2.60 \$2.34	\$2.47 \$2.24	10
<a href="#">RG179B/U</a>	75 3	0.100 0.012[7]	1	70 29.15	900	FEP	\$3.16 \$2.84	\$3.00 \$2.72	11
<a href="#">RG187A/U</a>	75 3	0.102 0.012[7]	1	70 25	200 2,000	PTFE	\$4.96 \$4.46	\$4.71 \$4.27	12
<a href="#">RG302/U</a>	75 3	0.206 0.025[7]	1	69 13	650 1,700	FEP	\$8.26 \$7.43	\$7.85 \$7.10	13
<a href="#">RG59B/U</a>	75 1	0.242 0.022[1]	1	66 11.5	77 2,300	PVC (NC)	\$1.18 \$1.06	\$1.12 \$1.01	14
<a href="#">RG6A/U</a>	75 1	0.332 0.029[1]	2 90	66 11	100	PVC (NC)	\$6.37 \$5.73	\$6.05 \$5.48	15
<a href="#">RG6-CATV</a>	75 3	0.278 0.04[1]	3 70	85 6.55	6.5	PVC (NC)	\$1.57 \$1.41	\$1.49 \$1.35	16
<b>COMMUNICATIONS</b>									
<a href="#">LMR-200-UF</a>	50 5.8	0.195 0.044	2 90	83 12.18		TPE 0.5	\$2.22 \$2.22	\$2.22 \$2.22	17
<a href="#">LMR-100A-PVC</a>	50 5.8	0.110 0.018[1]	2 90	66 24		PVC 0.25	\$0.77 \$0.77	\$0.77 \$0.77	18
<a href="#">LMR-195</a>	50 5.8	0.195 0.037[1]	2 90	80 11.8		PE 0.5	\$0.67 \$0.67	\$0.67 \$0.67	19
<a href="#">LMR-195-FR</a>	50 5.8	0.195 0.037[1]	2 90	76 11.8		FRPE 0.5	\$1.05 \$1.05	\$1.05 \$1.05	20
<a href="#">LMR-195-LLPL</a>	50 8	0.195 0.037[1]	2 90	80 11.8		PVC (FR) 0.5	\$8.29 \$8.29	\$8.29 \$8.29	21
<a href="#">LMR-200</a>	50 5.8	0.195 0.044[1]	2 90	83 10.5		PE 0.5	\$0.75 \$0.75	\$0.75 \$0.75	22
<a href="#">LMR-200-FR</a>	50 5.8	0.195 0.044[1]	2 90	83		FRPE 0.5	\$1.06 \$1.06	\$1.06 \$1.06	23
<a href="#">LMR-240</a>	50 5.8	0.240 0.056[1]	2 90	84 8		PE 0.75	\$0.92 \$0.92	\$0.92 \$0.92	24
<a href="#">LMR-240-DB</a>	50 5.8	0.240 0.056[1]	2 90	84 7.66		PE 0.75	\$1.06 \$1.06	\$1.06 \$1.06	25
<a href="#">LMR-240-UF</a>	50 5.8	0.240 0.056	2 90	84 9.19		TPE 0.75	\$1.12 \$1.12	\$1.12 \$1.12	26
<a href="#">LMR-400</a>	50 6	0.405 0.108[1]	2 90	85 4.25		PE 1	\$1.30 \$1.30	\$1.30 \$1.30	27
<a href="#">LMR-400-DB</a>	50 6	0.405 0.108[1]	2 90	85 4.15		PE 1	\$1.39 \$1.39	\$1.39 \$1.39	28

Coaxial Cables

See Our Website For Current Pricing & Real-Time Stock Availability!

# COAXIAL CABLES

Meets or Exceeds MIL-C-17 Specifications Where Applicable

MODEL NO.	COAX IMPEDANCE (Ohm)	JACKET DIAMETER (in)	NUMBER OF SHIELDS	VELOCITY FACTOR (%)	MAX. POWER HANDLING AT 1 GHz (W)	JACKET MATERIAL	PRICE PER FOOT		ROW
	MAXIMUM FREQUENCY (GHz.)	CONDUCTOR DIAM. (in) [strands]	RF SHIELDING (min dB)	ATTENUATION AT 1 GHz. (dB/100 ft)	MAXIMUM OPERATING VOLTAGE (V RMS)	MINIMUM BEND RADIUS (in)	1-99 FT 500-999 FT	100-499 FT 1000 + FT	
<b>COMMUNICATIONS</b>									
<a href="#">LMR-400-UF</a>	50	0.405	2	85		TPE	\$1.88	\$1.88	29
	5.8	0.108	90	5		1	\$1.88	\$1.88	
<a href="#">LMR-500</a>	50	0.500	2	86		PE	\$2.06	\$2.06	30
	5.8	0.142[1]	90	3.1		1.25	\$2.06	\$2.06	
<a href="#">LMR-500-DB</a>	50	0.500	2	86		PE	\$2.32	\$2.32	31
	5.8	0.142[1]	90	3.1		1.25	\$2.32	\$2.32	
<a href="#">LMR-600</a>	50	0.590	2	87		PE	\$2.34	\$2.34	32
	5.8	0.176[1]	90	2.62		1.5	\$2.34	\$2.34	
<a href="#">LMR-600-DB</a>	50	0.590	2	87		PE	\$2.81	\$2.81	33
	5.8	0.176[1]	90	2.62		1.5	\$2.81	\$2.81	
<a href="#">PE-1/2FAC</a>	50	0.629	1	88		PE	\$5.76	\$5.47	34
	8.8	0.189[1]	120	2.2		2.75	\$5.18	\$4.95	
<a href="#">PE-1/2SFHC</a>	50	0.519	1	82		PE	\$5.73	\$5.44	35
	10.2	0.141[1]	120	3.41	1,000	0.6	\$5.16	\$4.93	
<a href="#">PE-1/4SFHC</a>	50	0.303	1	82		PE	\$3.98	\$3.78	36
	20.4	0.075[1]	120	5.85		0.5	\$3.58	\$3.42	
<a href="#">PE-B400</a>	50	0.403	2		190	PVC	\$2.57	\$2.44	37
	4	0.103[1]		6	600		\$2.31	\$2.21	
<a href="#">PE-C100-LSZH</a>	50	0.109	2	66	40	LSZH	\$1.67	\$1.59	38
	5.8	0.018[1]	90	25		0.25	\$1.50	\$1.44	
<a href="#">PE-C195</a>	50	0.195	2	80	135	PE	\$0.91	\$0.86	39
	5.8	0.037[1]	90	11.7		0.5	\$0.82	\$0.78	
<a href="#">PE-C200</a>	50	0.195	2	83	170	PE	\$1.10	\$1.05	40
	5.8	0.044[1]	90	10.8	1,000		\$0.99	\$0.95	
<a href="#">PE-C240</a>	50	0.240	2	84	250	PE	\$1.49	\$1.42	41
	5.8	0.056[1]	90	7.98		0.75	\$1.34	\$1.28	
<a href="#">PE-C300</a>	50	0.300	2	85	350	PE	\$3.74	\$3.55	42
	2.5	0.07[1]		6.3	2,000	1.5	\$3.37	\$3.22	
<a href="#">PE-C400</a>	50	0.405	2	85	480	PE	\$1.66	\$1.58	43
	5.8	0.108[1]	90	4.1			\$1.49	\$1.43	
<a href="#">PE-C500</a>	50	0.500	2	86	720	PE	\$5.73	\$5.44	44
	6	0.142[1]	90	3.5	3,000		\$5.16	\$4.93	
<a href="#">PE-C600</a>	50	0.590	2	87	900	PE	\$3.00	\$2.85	45
	5.8	0.176[1]	90	2.7			\$2.70	\$2.58	
<b>HIGH PERFORMANCE</b>									
<a href="#">PE-P047</a>	50	0.056	2	70	43	FEP	\$9.67	\$9.19	46
	20	0.011[1]	90	35		0.2	\$8.70	\$8.32	
<a href="#">PE-P086</a>	50	0.104	2	70		FEP	\$10.61	\$10.08	47
	18	0.02[1]	110	21.7			\$9.55	\$9.12	
<a href="#">PE-P086HF</a>	50	0.104	2	70		FEP	\$8.79	\$8.35	48
	40	0.02[1]		21.1		0.52	\$7.91	\$7.56	
<a href="#">PE-P141</a>	50	0.163	2	70	600	FEP	\$14.43	\$13.71	49
	18	0.037[1]	110	11.2			\$12.99	\$12.41	
<a href="#">PE-P141HF</a>	50	0.163	2	70		FEP	\$16.47	\$15.65	50
	31	0.037[1]		13		0.82	\$14.82	\$14.16	
<a href="#">PE-P142LL</a>	50	0.195	3	80	820	FEP	Call	Call	51
	18	0.051[1]		8.2			Call	Call	
<a href="#">PE-P160LL</a>	50	0.160	3	83	560	FEP	Call	Call	52
	18	0.04[1]		11			Call	Call	
<a href="#">PE-P195</a>	50	0.195	3	70	650	FEP	\$12.73	\$12.09	53
	22	0.037[1]		12.5	1,900		\$11.46	\$10.95	
<a href="#">PE-P300LL</a>	50	0.300	3	83	1,700	FEP	Call	Call	54
	18	0.089[1]		5.1			Call	Call	
<b>RG MIL-C-17 TYPE CABLE</b>									
<a href="#">RG141A/U</a>	50	0.190	1	70	650	PTFE (FG)	\$8.17	\$7.76	55
	10	0.037[1]		13			\$7.35	\$7.03	

Coaxial Cables

See Our Website For Current Pricing & Real-Time Stock Availability!



Technical Support  
+1 (949) 261-1920



Same-Day Shipping,  
Even Custom Cable Assemblies

# COAXIAL CABLES

Meets or Exceeds MIL-C-17 Specifications Where Applicable

MODEL NO.	COAX IMPEDANCE (Ohm)	JACKET DIAMETER (in)	NUMBER OF SHIELDS	VELOCITY FACTOR (%)	MAX. POWER HANDLING AT 1 GHz (W)	JACKET MATERIAL	PRICE PER FOOT		ROW
	MAXIMUM FREQUENCY (GHz.)	CONDUCTOR DIAM. (in) [strands]	RF SHIELDING (min dB)	ATTENUATION AT 1 GHz. (dB/100 ft)	MAXIMUM OPERATING VOLTAGE (V RMS)	MINIMUM BEND RADIUS (in)	1-99 FT 500-999 FT	100-499 FT 1000 + FT	
<b>RG MIL-C-17 TYPE CABLE</b>									
<a href="#">RG142B/U</a>	50 8	0.195 0.037[1]	2	70 12.9	1,900	FEP	\$6.73 \$6.06	\$6.39 \$5.79	56
<a href="#">RG174A/U</a>	50 1	0.110 0.019[7]	1	66 32	17	PVC	\$0.65 \$0.59	\$0.62 \$0.56	57
<a href="#">RG178B/U</a>	50 3	0.072 0.012[7]	1	70 44.41	55 1,000	FEP	\$1.18 \$1.06	\$1.12 \$1.01	58
<a href="#">RG180B/U</a>	95 3	0.141 0.012[7]	1	70	250	FEP	\$5.42 \$4.88	\$5.15 \$4.66	59
<a href="#">RG188A/U</a>	50 3	0.110 0.02[7]	1	26	160	PTFE	\$3.20 \$2.88	\$3.04 \$2.75	60
<a href="#">RG188-DS</a>	50 10	0.118 0.02[7]	2	30	160	PTFE	\$4.53 \$4.08	\$4.30 \$3.90	61
<a href="#">RG196A/U</a>	50 1	0.080 0.011[7]	1	49	78	PTFE	\$1.70 \$1.53	\$1.62 \$1.46	62
<a href="#">RG213/U</a>	50 1	0.405 0.09[7]	1	66 9	190 3,700	PVC	\$1.79 \$1.64	\$1.71 \$1.60	63
<a href="#">RG214/U</a>	50 11	0.425 0.089[7]	2	66 7.32	170 5,000	PVC	\$9.41 \$8.47	\$8.94 \$8.09	64
<a href="#">RG217/U</a>	50 1	0.545 0.106[1]	2	66 5.8	260 5,200	PVC	\$5.76 \$5.18	\$5.47 \$4.95	65
<a href="#">RG218/U</a>	50 1	0.870 0.195[1]	1	66 5	600 11,000	PVC	\$14.61 \$13.15	\$13.88 \$12.56	66
<a href="#">RG223/U</a>	50 12.4	0.209 0.035[1]	2	66 13.41	50 1,900	PVC	\$3.56 \$3.20	\$3.38 \$3.06	67
<a href="#">RG225/U</a>	50 10	0.430 0.094[7]	2	70 7.5	1,700 3,700	PTFE (FG)	\$40.35 \$36.32	\$38.33 \$34.70	68
<a href="#">RG303/U</a>	50 3	0.170 0.037[1]	1	14	650	FEP	\$7.74 \$6.97	\$7.35 \$6.66	69
<a href="#">RG316/U</a>	50 3	0.102 0.02[7]	1	69 38	900	FEP	\$3.28 \$2.95	\$3.12 \$2.82	70
<a href="#">RG316-DS</a>	50 3	0.114 0.02[7]	2 85	70 29	120 1,200	FEP 0.59	\$3.71 \$3.34	\$3.52 \$3.19	71
<a href="#">RG393/U</a>	50 10	0.390 0.094[7]	2	70 7.5	1,700	FEP	\$18.91 \$17.02	\$17.96 \$16.26	72
<a href="#">RG400/U</a>	50 12.4	0.195 [19]	2	70 14.7	600 1,900	FEP	\$8.31 \$7.48	\$7.89 \$7.15	73
<a href="#">RG55B/U</a>	53 3	0.202 0.032[1]	2	66 16.5	53	PE	\$3.27 \$2.94	\$3.11 \$2.81	74
<a href="#">RG58C/U</a>	50 5	0.195 0.036[19]	1	66 20	44 1,900	PVC (NC) 0.98	\$0.96 \$0.86	\$0.91 \$0.83	75
<a href="#">RG58-P (1)</a>	53 1	0.159 0.032[1]	1 45	70 17.3	143	FEP	\$9.99 \$8.99	\$9.49 \$8.59	76
<a href="#">RG58-TPX</a>	50 6	0.190 0.035[1]	1	69	1,400	TPX 1.9	Call Call	Call Call	77
<a href="#">RG62A/U</a>	93 1	0.239 0.025[1]	1 45	83 8.7	77	PVC	\$2.73 \$2.46	\$2.59 \$2.35	78
<a href="#">RG8A/U</a>	50 1	0.405 0.085[7]	1	66 8	190	PVC (NC)	\$3.86 \$3.47	\$3.67 \$3.32	79
<a href="#">RG8X</a>	50 1	0.242 0.056[19]	1	13.5	60 2,500	PVC (NC)	\$4.64 \$4.18	\$4.41 \$3.99	80
<b>SEMIRIGID AND FORMABLE</b>									
<a href="#">PECX001</a>	50 115	0.013[1]	1	77 30	101	0.125	\$14.93 \$13.44	\$14.18 \$12.84	81
<a href="#">PECX002</a>	50 115	0.013[1]	1	77 30	101	0.125	\$17.68 \$15.91	\$16.80 \$15.20	82
<a href="#">PECX003</a>	50 72	0.02[1]	1	77 20	188	0.25	\$21.08 \$18.97	\$20.03 \$18.13	83

Coaxial Cables

See Our Website For Current Pricing & Real-Time Stock Availability!

# COAXIAL CABLES

Meets or Exceeds MIL-C-17 Specifications Where Applicable

MODEL NO.	COAX IMPEDANCE (Ohm)	JACKET DIAMETER (in)	NUMBER OF SHIELDS	VELOCITY FACTOR (%)	MAX. POWER HANDLING AT 1 GHz (W)	JACKET MATERIAL	PRICE PER FOOT		ROW
	MAXIMUM FREQUENCY (GHz.)	CONDUCTOR DIAM. (in) [strands]	RF SHIELDING (min dB)	ATTENUATION AT 1 GHz. (dB/100 ft)	MAXIMUM OPERATING VOLTAGE (V RMS)	MINIMUM BEND RADIUS (in)	1-99 FT 500-999 FT	100-499 FT 1000 + FT	
<b>SEMIRIGID AND FORMABLE</b>									
<a href="#">PECX004</a>	50 72	0.02[1]	1	77 20	188	0.25	\$23.73 \$21.36	\$22.54 \$20.41	84
<a href="#">PECX005</a>	50 62	0.023[1]	1	77 17	314	0.25	\$9.93 \$8.94	\$9.43 \$8.54	85
<a href="#">PECX006</a>	50 62	0.023[1]	1	77 17	231	0.25	\$12.43 \$11.19	\$11.81 \$10.69	86
<a href="#">PECX007</a>	50 34	0.04[1]	1	77 10.5	580	0.5	\$16.60 \$14.94	\$15.77 \$14.28	87
<a href="#">PECX008</a>	50 34	0.04[1]	1	77 10.5	580	0.5	\$16.59 \$14.93	\$15.76 \$14.27	88
<a href="#">PE-020SR (8)</a>	50 27	0.004[1]	1	85	2.9		\$24.12 \$21.71	\$22.91 \$20.74	89
<a href="#">PE-034SR (2,8)</a>	50 40	0.008[1]	1	60	10		\$13.77 \$12.39	\$13.08 \$11.84	90
<a href="#">PE-047SR (3,8)</a>	50 40	0.011[1]	1	40	32		\$12.39 \$11.15	\$11.77 \$10.66	91
<a href="#">PE-047SR-STRAIGHT</a>	50 40	0.047 0.011[1]	1	40		0.05	\$13.36 \$12.02	\$12.69 \$11.49	92
<a href="#">PE-118SR (2)</a>	50 46	0.032[1]	1	12.5	500 3,000	0.4	\$47.89 \$43.10	\$45.50 \$41.19	93
<a href="#">PE-SR047AL (3,6)</a>	50 20	0.011[1]	1 90	70 41	32		\$11.40 \$10.26	\$10.83 \$9.80	94
<a href="#">PE-SR047AL-STRAIGHT</a>	50 20	0.047 0.011[1]	1 90	70 41	1,000	0.05	\$12.52 \$11.27	\$11.89 \$10.77	95
<a href="#">PE-SR047FL (12)</a>	50 20	0.011[1]	1	70 36	32		\$10.20 \$9.18	\$9.69 \$8.77	96
<a href="#">PE-SR401AL-STRAIGHT</a>	50 18	0.064	1	70 7.5	661		\$25.17 \$22.65	\$23.91 \$21.65	97
<a href="#">PE-SR401FL (11)</a>	50 18	0.065[1]	1 100	70 6.8	279	0.75	\$19.38 \$17.44	\$18.41 \$16.67	98
<a href="#">PE-SR402-75 (3,8)</a>	75 36	0.02[1]	1	12.5	280 3,500	0.1	\$12.19 \$10.97	\$11.58 \$10.48	99
<a href="#">PE-SR402-75-STRAIGHT</a>	75 36	0.02[1]	1	12.5			\$12.52 \$11.27	\$11.89 \$10.77	1
<a href="#">PE-SR402AL (3,10)</a>	50 36	0.036[1]	1	70 13	450		\$11.40 \$10.26	\$10.83 \$9.80	2
<a href="#">PE-SR402AL-STRAIGHT</a>	50 36	0.141 0.036[1]	1	70 13		0.1	\$11.57 \$10.41	\$10.99 \$9.95	3
<a href="#">PE-SR402FL (4)</a>	50 20	0.037[1]	110	70 12	400		\$9.87 \$8.88	\$9.38 \$8.49	4
<a href="#">PE-SR402FLJ (13)</a>	50 34	0.161 0.036[1]	100	70 11.89	303.4 1,900	FEP 0.315	\$10.42 \$9.38	\$9.90 \$8.96	5
<a href="#">PE-SR402TN</a>	50 36	0.036	1	70 12		1	\$7.13 \$6.42	\$6.77 \$6.13	6
<a href="#">PE-SR402TN-STRAIGHT</a>	50 36	0.036	1	70 12		1	\$9.81 \$8.83	\$9.32 \$8.44	7
<a href="#">PE-SR405AL (3,9)</a>	50 40	0.02[1]	1	23	130	0.05	\$10.85 \$9.77	\$10.31 \$9.33	8
<a href="#">PE-SR405AL-STRAIGHT</a>	50 40	0.02[1]	1	23		0.05	\$10.85 \$9.77	\$10.31 \$9.33	9
<a href="#">PE-SR405FL (5)</a>	50 20	0.02[1]	1	70 22.5	105		\$13.47 \$12.12	\$12.80 \$11.58	10
<a href="#">PE-SR405FLJ (14)</a>	50 61	0.105 0.02[1]	1 100	70 19.5	121.5 1,500	FEP 0.5	\$10.52 \$9.47	\$9.99 \$9.05	11
<a href="#">PE-SR405TN</a>	50 40	0.02[1]	1	22		0.05	\$6.99 \$6.29	\$6.64 \$6.01	12
<a href="#">PE-SR405TN-STRAIGHT</a>	50 40	0.02[1]	1	22		0.05	\$8.20 \$7.38	\$7.79 \$7.05	13

Coaxial Cables

See Our Website For Current Pricing & Real-Time Stock Availability!



Technical Support  
+1 (949) 261-1920



Same-Day Shipping,  
Even Custom Cable Assemblies



# COAXIAL CABLES

Meets or Exceeds MIL-C-17 Specifications Where Applicable

MODEL NO.	COAX IMPEDANCE (Ohm)	JACKET DIAMETER (in)	NUMBER OF SHIELDS	VELOCITY FACTOR (%)	MAX. POWER HANDLING AT 1 GHz (W)	JACKET MATERIAL	PRICE PER FOOT		R O W
	MAXIMUM FREQUENCY (GHz.)	CONDUCTOR DIAM. (in) [strands]	RF SHIELDING (min dB)	ATTENUATION AT 1 GHz. (dB/100 ft)	MAXIMUM OPERATING VOLTAGE (V RMS)	MINIMUM BEND RADIUS (in)	1-99 FT 500-999 FT	100-499 FT 1000 + FT	
<b>SEMIRIGID AND FORMABLE</b>									
<a href="#">RG401/U (2,8)</a>	50 20	0.064[1]	1	70 7.5	1,400 3,000		\$26.32 \$23.69	\$25.00 \$22.64	14
<a href="#">RG402/U (3,8)</a>	50 34	0.036[1]	1	70 11.1	450		\$8.67 \$7.80	\$8.24 \$7.46	15
<a href="#">RG402/U-STRAIGHT</a>	50 33	0.036[1]	1	70 12	450		\$9.44 \$8.50	\$8.97 \$8.12	16
<a href="#">RG405/U (3,8)</a>	50 40	0.02[1]	1 -110	70 22	130		\$9.10 \$8.19	\$8.65 \$7.83	17
<a href="#">RG405/U-STRAIGHT</a>	50 40	0.02[1]	1 -110	70 22	130		\$11.22 \$10.10	\$10.66 \$9.65	18
<a href="#">SPF-250</a>	50 5.8	0.303 0.075[1]	1	83		FRPE 1.25	\$3.00 \$3.00	\$3.00 \$3.00	19
<a href="#">SPF-375</a>	50 6	0.435 0.11[1]	1	83		FRPE 1.75	\$3.83 \$3.83	\$3.83 \$3.83	20
<a href="#">SPF-500</a>	50 6	0.545 0.14[1]	1	83		FRPE 2.25	\$4.33 \$4.33	\$4.33 \$4.33	21
<a href="#">SPO-250</a>	50 5.8	0.303 0.075[1]	1	83		PE 1.25	\$2.28 \$2.28	\$2.28 \$2.28	22
<a href="#">SPO-375</a>	50 6	0.430 0.11[1]	1	83		PE 1.75	\$2.85 \$2.85	\$2.85 \$2.85	23
<a href="#">SPO-500</a>	50 6	0.530 0.14[1]	1	83		PE 2.25	\$3.07 \$3.07	\$3.07 \$3.07	24
<a href="#">SPP-250-LLPL</a>	50 5.8	0.280 0.068[1]	1 100	76 5.5	650	FEP 1.25	\$5.68 \$5.68	\$5.68 \$5.68	25
<a href="#">SPP-375-LLPL</a>	50 5.8	0.402 0.108[1]	1 100	76		FEP 1.25	\$7.96 \$7.96	\$7.96 \$7.96	26
<a href="#">SPP-500-LLPL</a>	50 5.8	0.500 0.136[1]	1	76		FEP 1.5	\$10.28 \$10.28	\$10.28 \$10.28	27
<a href="#">TFT-402-LF</a>	50 5.8	0.160 0.037[1]	2 80	76		FEP 0.75	\$2.09 \$1.88	\$1.99 \$1.80	28
<b>TWINAX</b>									
<a href="#">PE-S330 (TWINAX)</a>	100 0.4	0.330 0.037[7]	2		300	PVC	\$6.19 \$5.57	\$5.88 \$5.32	29
<a href="#">RG108A/U (TWINAX)</a>	78 1	0.235 0.038[7]	1	66 34.6	30	PVC	\$3.14 \$2.83	\$2.98 \$2.70	30

## NOTES:

- (1) P = PLENUM CABLE, NEC 725-2(b) CLASS 2 - **REQUIRES SPECIAL CONNECTORS**
- (2) SEMI-RIGID CABLE, SOLD IN 5 FEET, STRAIGHT PIECES ONLY
- (3) SEMI-RIGID CABLE, SOLD IN EITHER 5 FEET, STRAIGHT PIECES OR COILS OF 50 FEET
- (4) RE-SHAPEABLE VERSION OF RG402/U
- (5) RE-SHAPEABLE VERSION OF RG405/U
- (6) TINNED ALUMINUM VERSION OF PE-047SR
- (7) TINNED ALUMINUM VERSION OF RG401/U
- (8) BARE COPPER JACKET
- (9) TINNED ALUMINUM VERSION OF RG405/U
- (10) TINNED ALUMINUM VERSION OF RG402/U
- (11) RE-SHAPEABLE VERSION OF RG401/U
- (12) RE-SHAPEABLE VERSION OF PE-047SR
- (13) JACKETED RE-SHAPEABLE VERSION OF RG402/U
- (14) JACKETED RE-SHAPEABLE VERSION OF RG405/U

## MATERIALS:

Al (Tn)	TIN PLATED ALUMINUM
Cu	BARE COPPER
Cu (Tn)	TIN PLATED COPPER
FEP	FLUORINATED ETHYLENE PROPYLENE
LSZH	LOW SMOKE ZERO HALOGEN
PE	POLYETHYLENE
PTFE	POLYTETRAFLUOROETHYLENE
PTFE (FR)	FIBERGLASS REINFORCED PTFE
PVC	POLYVINYLCHLORIDE
PVC (NC)	NON-CONTAMINATED PVC
PVC (FR)	FIBERGLASS REINFORCED PVC

Coaxial Cables

See Our Website For Current Pricing & Real-Time Stock Availability!

# Connector Selection Guide

## 3 Easy Ways to Find your Product.....

### 1. Search by PE Part Number

If you know the PE part number you are searching for, please reference our Part Number Index on Page [395](#)

### 2. Quick Reference Guide

(Page number refers to first appearance of product in the Connector Section)

Connector Series	Page	Connector Series	Page	Connector Series	Page	Connector Series	Page
1.0/2.3	<a href="#">237</a>	75 Ohm Mini SMB	<a href="#">294</a>	HN	<a href="#">254</a>	Rev. Pol. N	<a href="#">265</a>
1.0mm	<a href="#">237</a>	75 Ohm N	<a href="#">295</a>	LC	<a href="#">255</a>	Rev. Pol. SMA	<a href="#">274</a>
1.85mm	<a href="#">237</a>	75 Ohm RCA	<a href="#">296</a>	MC-Card	<a href="#">255</a>	Rev. Pol. TNC	<a href="#">288</a>
10-32	<a href="#">238</a>	75 Ohm SMB	<a href="#">296</a>	MCX	<a href="#">255</a>	Rev. Thread SMA	<a href="#">276</a>
2.2-5	<a href="#">239</a>	75 Ohm SMC	<a href="#">297</a>	MHV	<a href="#">257</a>	SC	<a href="#">267</a>
2.4mm	<a href="#">239</a>	75 Ohm TNC	<a href="#">298</a>	Mini SMP	<a href="#">258</a>	SHV	<a href="#">268</a>
2.92mm	<a href="#">240</a>	Banana	<a href="#">300</a>	Mini UHF	<a href="#">258</a>	SMA	<a href="#">269</a>
3.5mm	<a href="#">242</a>	BMA	<a href="#">245</a>	MMBX	<a href="#">259</a>	SMB	<a href="#">277</a>
3/4"-20 Twinax	<a href="#">299</a>	BNC	<a href="#">247</a>	MMCX	<a href="#">259</a>	SMC	<a href="#">279</a>
4.1/9.5 Mini DIN	<a href="#">242</a>	BNC Twinax	<a href="#">299</a>	N	<a href="#">260</a>	SMP	<a href="#">280</a>
4.3-10	<a href="#">242</a>	C	<a href="#">251</a>	NEX10	<a href="#">266</a>	SSMA	<a href="#">282</a>
7/16 DIN	<a href="#">243</a>	D-Sub	<a href="#">252</a>	NMO Mount	<a href="#">266</a>	SSMB	<a href="#">284</a>
75 Ohm 1.0/2.3	<a href="#">291</a>	Double Banana	<a href="#">300</a>	QMA	<a href="#">266</a>	SSMC	<a href="#">284</a>
75 Ohm 1.6/5.6	<a href="#">291</a>	FAKRA	<a href="#">252</a>	QN	<a href="#">267</a>	TNC	<a href="#">285</a>
75 Ohm BNC	<a href="#">291</a>	FME	<a href="#">253</a>	Rev. Pol. BNC	<a href="#">249</a>	UHF	<a href="#">290</a>
75 Ohm F	<a href="#">293</a>	GR874	<a href="#">254</a>	Rev. Pol. MCX	<a href="#">256</a>	UMCX	<a href="#">290</a>
75 Ohm MCX	<a href="#">294</a>						

### 3. Connector Locator

Connector Type	Page
<b>1.0/2.3 Jack Connectors</b>	
Right Angle, Bulkhead, Cable Connectors	<a href="#">237</a>
Right Angle, PCB Mount	<a href="#">237</a>
Straight, Bulkhead, Cable Connectors	<a href="#">237</a>
Straight, Bulkhead, PCB Mount	<a href="#">237</a>
Straight, PCB Mount	<a href="#">237</a>
<b>1.0/2.3 Plug Connectors</b>	
Right Angle, Cable Connectors	<a href="#">237</a>
Straight, Cable Connectors	<a href="#">237</a>
<b>1.0mm Female Connectors</b>	
Straight, PCB Mount	<a href="#">237</a>
<b>1.85mm Female Connectors</b>	
Straight, 2 Hole Flange, Field Replaceable Contact	<a href="#">238</a>
Straight, 4 Hole Flange, Field Replaceable Contact	<a href="#">238</a>
Straight, Bulkhead, Cable Connectors	<a href="#">238</a>
Straight, Cable Connectors	<a href="#">238</a>
Straight, PCB Mount	<a href="#">238</a>
<b>1.85mm Male Connectors</b>	
Straight, Cable Connectors	<a href="#">237</a>
Straight, PCB Mount	<a href="#">238</a>
Straight, Threaded, Field Replaceable Contact	<a href="#">238</a>
<b>10-32 Female Connectors</b>	
Right Angle, PCB Mount	<a href="#">239</a>
Straight, Bulkhead, Cable Connectors	<a href="#">239</a>

Connector Type	Page
Straight, Bulkhead, Terminal	<a href="#">239</a>
Straight, Cable Connectors	<a href="#">238</a>
Straight, PCB Mount	<a href="#">238</a>
<b>10-32 Male Connectors</b>	
Right Angle, Cable Connectors	<a href="#">238</a>
Straight, Cable Connectors	<a href="#">238</a>
<b>2.2-5 Female Connectors</b>	
Straight, Bulkhead, Cable Connectors	<a href="#">239</a>
Straight, Cable Connectors	<a href="#">239</a>
<b>2.2-5 Male Connectors</b>	
Right Angle, Cable Connectors	<a href="#">239</a>
Straight, Cable Connectors	<a href="#">239</a>
<b>2.4mm Female Connectors</b>	
Straight, 2 Hole Flange, Field Replaceable Contact	<a href="#">240</a>
Straight, 4 Hole Flange, Field Replaceable Contact	<a href="#">240</a>
Straight, Bulkhead, Cable Connectors	<a href="#">240</a>
Straight, Cable Connectors	<a href="#">240</a>
Straight, PCB Mount	<a href="#">240</a>
<b>2.4mm Male Connectors</b>	
Straight, 2 Hole Flange, Terminal	<a href="#">240</a>
Straight, Cable Connectors	<a href="#">239</a>
Straight, PCB Mount	<a href="#">239</a>
<b>2.92mm Female Connectors</b>	
Straight, 2 Hole Flange, Field Replaceable Contact	<a href="#">241</a>



# Connector Locator

Connector Type	Page
Straight, 4 Hole Flange, Cable Connectors	<a href="#">241</a>
Straight, 4 Hole Flange, Field Replaceable Contact	<a href="#">241</a>
Straight, Bulkhead, Cable Connectors	<a href="#">241</a>
Straight, Cable Connectors	<a href="#">241</a>
Straight, PCB Mount	<a href="#">241</a>
<b>2.92mm Male Connectors</b>	
Straight, 2 Hole Flange, Field Replaceable Contact	<a href="#">241</a>
Straight, Cable Connectors	<a href="#">240</a>
Straight, PCB Mount	<a href="#">241</a>
<b>3.5mm Female Connectors</b>	
Straight, Bulkhead, Cable Connectors	<a href="#">242</a>
Straight, Cable Connectors	<a href="#">242</a>
<b>3.5mm Male Connectors</b>	
Straight, Cable Connectors	<a href="#">242</a>
<b>4.1/9.5 Mini DIN Female Connectors</b>	
Straight, Bulkhead, Cable Connectors	<a href="#">242</a>
Straight, Cable Connectors	<a href="#">242</a>
<b>4.1/9.5 Mini DIN Male Connectors</b>	
Right Angle, Cable Connectors	<a href="#">242</a>
Straight, Cable Connectors	<a href="#">242</a>
<b>4.3-10 Female Connectors</b>	
Straight, 4 Hole Flange, Cable Connectors	<a href="#">243</a>
Straight, 4 Hole Flange, Terminal	<a href="#">243</a>
Straight, Bulkhead, Cable Connectors	<a href="#">243</a>
Straight, Cable Connectors	<a href="#">243</a>
<b>4.3-10 Male Connectors</b>	
Right Angle, Cable Connectors	<a href="#">243</a>
Straight, Cable Connectors	<a href="#">242</a>
<b>7/16 DIN Female Connectors</b>	
Straight, 4 Hole Flange, Cable Connectors	<a href="#">245</a>
Straight, 4 Hole Flange, Terminal	<a href="#">245</a>
Straight, Bulkhead, Cable Connectors	<a href="#">245</a>
Straight, Bulkhead, Terminal	<a href="#">245</a>
Straight, Cable Connectors	<a href="#">244</a>
<b>7/16 DIN Male Connectors</b>	
Right Angle, Cable Connectors	<a href="#">244</a>
Straight, Cable Connectors	<a href="#">244</a>
<b>75 Ohm 1.0/2.3 Jack Connectors</b>	
Right Angle, Bulkhead, PCB Mount	<a href="#">291</a>
Straight, Bulkhead, PCB Mount	<a href="#">291</a>
<b>75 Ohm 1.0/2.3 Plug Connectors</b>	
Straight, Cable Connectors	<a href="#">291</a>
<b>75 Ohm 1.6/5.6 Jack Connectors</b>	
Right Angle, Bulkhead, Cable Connectors	<a href="#">291</a>
Right Angle, PCB Mount	<a href="#">291</a>
Straight, Bulkhead, PCB Mount	<a href="#">291</a>
<b>75 Ohm 1.6/5.6 Plug Connectors</b>	
Right Angle, Cable Connectors	<a href="#">291</a>
Straight, Cable Connectors	<a href="#">291</a>
<b>75 Ohm BNC Female Connectors</b>	
Right Angle, 4 Hole Flange, Terminal	<a href="#">293</a>
Right Angle, Bulkhead, Terminal	<a href="#">293</a>
Straight, 4 Hole Flange, Cable Connectors	<a href="#">292</a>

Connector Type	Page
Straight, 4 Hole Flange, Terminal	<a href="#">293</a>
Straight, Bulkhead, Cable Connectors	<a href="#">292</a>
Straight, Bulkhead, PCB Mount	<a href="#">292</a>
Straight, Bulkhead, Terminal	<a href="#">292</a>
Straight, Cable Connectors	<a href="#">292</a>
Straight, PCB Mount	<a href="#">292</a>
<b>75 Ohm BNC Male Connectors</b>	
Right Angle, Cable Connectors	<a href="#">292</a>
Straight, 4 Hole Flange, Terminal	<a href="#">292</a>
Straight, Bulkhead, Terminal	<a href="#">292</a>
Straight, Cable Connectors	<a href="#">291</a>
<b>75 Ohm F Female Connectors</b>	
Right Angle, Bulkhead, PCB Mount	<a href="#">294</a>
Right Angle, PCB Mount	<a href="#">294</a>
Straight, 4 Hole Flange, Terminal	<a href="#">294</a>
Straight, Bulkhead, Cable Connectors	<a href="#">293</a>
Straight, Bulkhead, PCB Mount	<a href="#">294</a>
Straight, Bulkhead, Terminal	<a href="#">294</a>
Straight, PCB Mount	<a href="#">293</a>
Straight, Thread-In, Terminal	<a href="#">294</a>
<b>75 Ohm F Male Connectors</b>	
Right Angle, Cable Connectors	<a href="#">293</a>
Straight, Cable Connectors	<a href="#">293</a>
<b>75 Ohm MCX Jack Connectors</b>	
Right Angle, PCB Mount	<a href="#">294</a>
Straight, Cable Connectors	<a href="#">294</a>
Straight, PCB Mount	<a href="#">294</a>
<b>75 Ohm MCX Plug Connectors</b>	
Right Angle, Cable Connectors	<a href="#">294</a>
Straight, Cable Connectors	<a href="#">294</a>
<b>75 Ohm Mini SMB Jack Connectors</b>	
Right Angle, Bulkhead, PCB Mount	<a href="#">295</a>
Right Angle, PCB Mount	<a href="#">295</a>
Straight, 2 Hole Flange, Terminal	<a href="#">295</a>
Straight, Cable Connectors	<a href="#">295</a>
Straight, PCB Mount	<a href="#">295</a>
<b>75 Ohm Mini SMB Plug Connectors</b>	
Right Angle, Cable Connectors	<a href="#">295</a>
Straight, Cable Connectors	<a href="#">294</a>
<b>75 Ohm N Female Connectors</b>	
Straight, 4 Hole Flange, Terminal	<a href="#">296</a>
Straight, Bulkhead, Terminal	<a href="#">296</a>
Straight, Cable Connectors	<a href="#">295</a>
<b>75 Ohm N Male Connectors</b>	
Right Angle, Cable Connectors	<a href="#">295</a>
Straight, 4 Hole Flange, Terminal	<a href="#">295</a>
Straight, Cable Connectors	<a href="#">295</a>
<b>75 Ohm RCA Female Connectors</b>	
Straight, Bulkhead, Cable Connectors	<a href="#">296</a>
<b>75 Ohm RCA Male Connectors</b>	
Right Angle, Cable Connectors	<a href="#">296</a>
Straight, Cable Connectors	<a href="#">296</a>
<b>75 Ohm SMB Jack Connectors</b>	

# Connector Locator

Connector Type	Page
Right Angle, PCB Mount	<a href="#">297</a>
Straight, Bulkhead, Cable Connectors	<a href="#">297</a>
Straight, Bulkhead, Terminal	<a href="#">297</a>
Straight, Cable Connectors	<a href="#">297</a>
Straight, PCB Mount	<a href="#">297</a>
<b>75 Ohm SMB Plug Connectors</b>	
Right Angle, Cable Connectors	<a href="#">296</a>
Straight, Bulkhead, Terminal	<a href="#">296</a>
Straight, Cable Connectors	<a href="#">296</a>
Straight, PCB Mount	<a href="#">296</a>
<b>75 Ohm SMC Jack Connectors</b>	
Right Angle, PCB Mount	<a href="#">298</a>
Straight, Bulkhead, Cable Connectors	<a href="#">298</a>
Straight, Bulkhead, Terminal	<a href="#">298</a>
Straight, Cable Connectors	<a href="#">298</a>
Straight, PCB Mount	<a href="#">298</a>
<b>75 Ohm SMC Plug Connectors</b>	
Right Angle, Cable Connectors	<a href="#">298</a>
Right Angle, PCB Mount	<a href="#">298</a>
Straight, Bulkhead, Terminal	<a href="#">297</a>
Straight, Cable Connectors	<a href="#">297</a>
<b>75 Ohm TNC Female Connectors</b>	
Straight, 4 Hole Flange, Terminal	<a href="#">299</a>
Straight, Bulkhead, Cable Connectors	<a href="#">298</a>
Straight, Bulkhead, Terminal	<a href="#">298</a>
<b>75 Ohm TNC Male Connectors</b>	
Right Angle, Cable Connectors	<a href="#">298</a>
Straight, Cable Connectors	<a href="#">298</a>
<b>78 Ohm BNC Twinax Jack Connectors</b>	
Right Angle, PCB Mount	<a href="#">299</a>
Straight, 4 Hole Flange, Terminal	<a href="#">299</a>
Straight, Bulkhead, Cable Connectors	<a href="#">299</a>
Straight, Bulkhead, Terminal	<a href="#">299</a>
Straight, Cable Connectors	<a href="#">299</a>
Straight, PCB Mount	<a href="#">299</a>
<b>78 Ohm BNC Twinax Plug Connectors</b>	
Straight, Cable Connectors	<a href="#">299</a>
<b>95 Ohm 3/4"-20 Twinax Female Connectors</b>	
Straight, 4 Hole Flange, Terminal	<a href="#">300</a>
Straight, Bulkhead, Terminal	<a href="#">300</a>
Straight, Cable Connectors	<a href="#">299</a>
<b>95 Ohm 3/4"-20 Twinax Male Connectors</b>	
Straight, Cable Connectors	<a href="#">299</a>
<b>Banana Plug Connectors</b>	
Straight, Cable Connectors	<a href="#">300</a>
<b>BMA Jack Connectors</b>	
Right Angle, 2 Hole Flange, Cable Connectors	<a href="#">247</a>
Straight, 2 Hole Flange, Cable Connectors	<a href="#">246</a>
Straight, 2 Hole Flange, Terminal	<a href="#">246</a>
Straight, 4 Hole Flange, Terminal	<a href="#">246</a>
Straight, Bulkhead, Cable Connectors	<a href="#">246</a>
Straight, Cable Connectors	<a href="#">246</a>
Straight, PCB Mount	<a href="#">246</a>

Connector Type	Page
Straight, Terminal	<a href="#">246</a>
Straight, Thread-In, Terminal	<a href="#">247</a>
<b>BMA Plug Connectors</b>	
Right Angle, PCB Mount	<a href="#">246</a>
Straight, 2 Hole Flange, Field Replaceable Contact	<a href="#">245</a>
Straight, 2 Hole Flange, Terminal	<a href="#">246</a>
Straight, 4 Hole Flange, Terminal	<a href="#">246</a>
Straight, Bulkhead, Cable Connectors	<a href="#">245</a>
Straight, PCB Mount	<a href="#">245</a>
Straight, Thread-In, Terminal	<a href="#">246</a>
<b>BNC Female Connectors</b>	
Right Angle, 4 Hole Flange, Terminal	<a href="#">249</a>
Right Angle, Bulkhead, Terminal	<a href="#">249</a>
Straight, 4 Hole Flange, Cable Connectors	<a href="#">249</a>
Straight, 4 Hole Flange, Terminal	<a href="#">249</a>
Straight, Bulkhead, Cable Connectors	<a href="#">249</a>
Straight, Bulkhead, PCB Mount	<a href="#">249</a>
Straight, Bulkhead, Terminal	<a href="#">249</a>
Straight, Cable Connectors	<a href="#">248</a>
Straight, PCB Mount	<a href="#">248</a>
<b>BNC Male Connectors</b>	
Right Angle, Cable Connectors	<a href="#">248</a>
Straight, 4 Hole Flange, Terminal	<a href="#">248</a>
Straight, Bulkhead, Terminal	<a href="#">248</a>
Straight, Cable Connectors	<a href="#">247</a>
<b>C Female Connectors</b>	
Straight, 4 Hole Flange, Cable Connectors	<a href="#">251</a>
Straight, 4 Hole Flange, Terminal	<a href="#">251</a>
Straight, Bulkhead, Cable Connectors	<a href="#">251</a>
Straight, Bulkhead, Terminal	<a href="#">251</a>
Straight, Cable Connectors	<a href="#">251</a>
<b>C Male Connectors</b>	
Right Angle, Cable Connectors	<a href="#">251</a>
Straight, 4 Hole Flange, Terminal	<a href="#">251</a>
Straight, Cable Connectors	<a href="#">251</a>
<b>Double Banana Plug Connectors</b>	
Straight, Cable Connectors	<a href="#">300</a>
<b>D-Sub Plug Connectors</b>	
Right Angle, Cable Connectors	<a href="#">252</a>
Straight, Cable Connectors	<a href="#">252</a>
<b>D-Sub Receptacle Connectors</b>	
Right Angle, Cable Connectors	<a href="#">252</a>
Straight, Cable Connectors	<a href="#">252</a>
<b>FAKRA Jack Connectors</b>	
Right Angle, Cable Connectors	<a href="#">253</a>
Right Angle, PCB Mount	<a href="#">253</a>
Straight, Cable Connectors	<a href="#">253</a>
<b>FAKRA Plug Connectors</b>	
Right Angle, PCB Mount	<a href="#">253</a>
Straight, Cable Connectors	<a href="#">252</a>
Straight, PCB Mount	<a href="#">252</a>
<b>FME Jack Connectors</b>	
Straight, Cable Connectors	<a href="#">254</a>





# Connector Locator

Connector Type	Page
<b>FME Plug Connectors</b>	
Straight, Bulkhead, Terminal	<a href="#">253</a>
Straight, Cable Connectors	<a href="#">253</a>
<b>GR874 Sexless Connectors</b>	
Straight, Cable Connectors	<a href="#">254</a>
<b>HN Female Connectors</b>	
Straight, 4 Hole Flange, Terminal	<a href="#">254</a>
Straight, Bulkhead, Terminal	<a href="#">254</a>
Straight, Cable Connectors	<a href="#">254</a>
<b>HN Male Connectors</b>	
Right Angle, Cable Connectors	<a href="#">254</a>
Straight, Cable Connectors	<a href="#">254</a>
<b>LC Female Connectors</b>	
Straight, 4 Hole Flange, Terminal	<a href="#">255</a>
Straight, Cable Connectors	<a href="#">255</a>
<b>LC Male Connectors</b>	
Right Angle, Cable Connectors	<a href="#">255</a>
Straight, Cable Connectors	<a href="#">255</a>
<b>MC-Card Plug Connectors</b>	
Right Angle, Cable Connectors	<a href="#">255</a>
Straight, Cable Connectors	<a href="#">255</a>
<b>MCX Jack Connectors</b>	
Right Angle, Bulkhead, Terminal	<a href="#">256</a>
Right Angle, PCB Mount	<a href="#">256</a>
Straight, 2 Hole Flange, Terminal	<a href="#">256</a>
Straight, Bulkhead, Cable Connectors	<a href="#">256</a>
Straight, Bulkhead, Terminal	<a href="#">256</a>
Straight, Cable Connectors	<a href="#">256</a>
Straight, PCB Mount	<a href="#">256</a>
<b>MCX Plug Connectors</b>	
Right Angle, Cable Connectors	<a href="#">255</a>
Right Angle, PCB Mount	<a href="#">256</a>
Straight, Cable Connectors	<a href="#">255</a>
Straight, PCB Mount	<a href="#">255</a>
<b>MHV Female Connectors</b>	
Straight, 4 Hole Flange, Cable Connectors	<a href="#">258</a>
Straight, 4 Hole Flange, Terminal	<a href="#">258</a>
Straight, Bulkhead, Cable Connectors	<a href="#">257</a>
Straight, Bulkhead, Terminal	<a href="#">257</a>
Straight, Cable Connectors	<a href="#">257</a>
<b>MHV Male Connectors</b>	
Right Angle, Cable Connectors	<a href="#">257</a>
Straight, Cable Connectors	<a href="#">257</a>
<b>Mini SMP Female Connectors</b>	
Right Angle, Cable Connectors	<a href="#">258</a>
Straight, Cable Connectors	<a href="#">258</a>
<b>Mini SMP Male Connectors</b>	
Right Angle, PCB Mount	<a href="#">258</a>
Straight, PCB Mount	<a href="#">258</a>
Straight, Solder, Terminal	<a href="#">258</a>
<b>Mini UHF Female Connectors</b>	
Straight, 4 Hole Flange, Terminal	<a href="#">259</a>
Straight, Bulkhead, Cable Connectors	<a href="#">258</a>

Connector Type	Page
Straight, Bulkhead, PCB Mount	<a href="#">259</a>
Straight, Bulkhead, Terminal	<a href="#">259</a>
Straight, Cable Connectors	<a href="#">258</a>
<b>Mini UHF Male Connectors</b>	
Straight, Cable Connectors	<a href="#">258</a>
<b>MMBX Jack Connectors</b>	
Straight, PCB Mount	<a href="#">259</a>
Straight, Thread-In, Terminal	<a href="#">259</a>
<b>MMBX Plug Connectors</b>	
Right Angle, Cable Connectors	<a href="#">259</a>
Straight, Cable Connectors	<a href="#">259</a>
Straight, PCB Mount	<a href="#">259</a>
<b>MMCX Jack Connectors</b>	
Right Angle, PCB Mount	<a href="#">260</a>
Straight, Cable Connectors	<a href="#">260</a>
Straight, PCB Mount	<a href="#">260</a>
<b>MMCX Plug Connectors</b>	
Right Angle, Cable Connectors	<a href="#">260</a>
Straight, Cable Connectors	<a href="#">259</a>
Straight, PCB Mount	<a href="#">260</a>
<b>N Female Connectors</b>	
Right Angle, 4 Hole Flange, Terminal	<a href="#">265</a>
Right Angle, Bulkhead, PCB Mount	<a href="#">265</a>
Straight, 2 Hole Flange, Terminal	<a href="#">264</a>
Straight, 4 Hole Flange, Cable Connectors	<a href="#">264</a>
Straight, 4 Hole Flange, Terminal	<a href="#">265</a>
Straight, Bulkhead, Cable Connectors	<a href="#">263</a>
Straight, Bulkhead, PCB Mount	<a href="#">264</a>
Straight, Bulkhead, Terminal	<a href="#">264</a>
Straight, Cable Connectors	<a href="#">262</a>
Straight, PCB Mount	<a href="#">263</a>
Straight, Press-In, Terminal	<a href="#">265</a>
<b>N Male Connectors</b>	
Right Angle, Cable Connectors	<a href="#">262</a>
Straight, 4 Hole Flange, Terminal	<a href="#">262</a>
Straight, Bulkhead, Terminal	<a href="#">261</a>
Straight, Cable Connectors	<a href="#">260</a>
<b>NEX10 Female Connectors</b>	
Straight, Bulkhead, Cable Connectors	<a href="#">266</a>
Straight, Cable Connectors	<a href="#">266</a>
<b>NEX10 Male Connectors</b>	
Right Angle, Cable Connectors	<a href="#">266</a>
Straight, Cable Connectors	<a href="#">266</a>
<b>NMO Mount Sexless Connectors</b>	
Straight, Cable Connectors	<a href="#">266</a>
<b>QMA Female Connectors</b>	
Right Angle, PCB Mount	<a href="#">267</a>
Straight, Bulkhead, Cable Connectors	<a href="#">267</a>
Straight, Cable Connectors	<a href="#">267</a>
Straight, PCB Mount	<a href="#">267</a>
<b>QMA Male Connectors</b>	
Right Angle, Cable Connectors	<a href="#">266</a>
Straight, Cable Connectors	<a href="#">266</a>

# Connector Locator

Connector Type	Page
<b>QN Female Connectors</b>	
Straight, 4 Hole Flange, Terminal	<a href="#">267</a>
Straight, Bulkhead, Cable Connectors	<a href="#">267</a>
<b>QN Male Connectors</b>	
Right Angle, Cable Connectors	<a href="#">267</a>
Straight, Cable Connectors	<a href="#">267</a>
<b>Reverse Polarity BNC Female Connectors</b>	
Right Angle, Bulkhead, Terminal	<a href="#">250</a>
Straight, 4 Hole Flange, Terminal	<a href="#">250</a>
Straight, Bulkhead, Cable Connectors	<a href="#">250</a>
Straight, Bulkhead, Terminal	<a href="#">250</a>
Straight, Cable Connectors	<a href="#">250</a>
<b>Reverse Polarity BNC Male Connectors</b>	
Right Angle, Cable Connectors	<a href="#">250</a>
Straight, 4 Hole Flange, Terminal	<a href="#">250</a>
Straight, Cable Connectors	<a href="#">249</a>
<b>Reverse Polarity MCX Jack Connectors</b>	
Right Angle, Bulkhead, PCB Mount	<a href="#">257</a>
Straight, Bulkhead, Cable Connectors	<a href="#">257</a>
Straight, Bulkhead, PCB Mount	<a href="#">257</a>
<b>Reverse Polarity MCX Plug Connectors</b>	
Right Angle, Cable Connectors	<a href="#">256</a>
Straight, Cable Connectors	<a href="#">256</a>
<b>Reverse Polarity N Female Connectors</b>	
Straight, Cable Connectors	<a href="#">265</a>
<b>Reverse Polarity N Male Connectors</b>	
Straight, Cable Connectors	<a href="#">265</a>
<b>Reverse Polarity SMA Female Connectors</b>	
Right Angle, Bulkhead, PCB Mount	<a href="#">276</a>
Right Angle, PCB Mount	<a href="#">276</a>
Straight, 2 Hole Flange, Terminal	<a href="#">276</a>
Straight, 4 Hole Flange, Terminal	<a href="#">276</a>
Straight, Bulkhead, Cable Connectors	<a href="#">275</a>
Straight, Bulkhead, PCB Mount	<a href="#">276</a>
Straight, Bulkhead, Terminal	<a href="#">276</a>
Straight, Cable Connectors	<a href="#">275</a>
Straight, PCB Mount	<a href="#">275</a>
<b>Reverse Polarity SMA Male Connectors</b>	
Right Angle, Cable Connectors	<a href="#">275</a>
Straight, Cable Connectors	<a href="#">275</a>
<b>Reverse Polarity TNC Female Connectors</b>	
Straight, 4 Hole Flange, Terminal	<a href="#">289</a>
Straight, Bulkhead, Cable Connectors	<a href="#">289</a>
Straight, Bulkhead, Terminal	<a href="#">289</a>
Straight, Cable Connectors	<a href="#">289</a>
<b>Reverse Polarity TNC Male Connectors</b>	
Right Angle, Cable Connectors	<a href="#">289</a>
Straight, 4 Hole Flange, Terminal	<a href="#">289</a>
Straight, Cable Connectors	<a href="#">288</a>
<b>Reverse Thread SMA Female Connectors</b>	
Right Angle, PCB Mount	<a href="#">277</a>
Straight, 4 Hole Flange, Terminal	<a href="#">277</a>
Straight, Bulkhead, Cable Connectors	<a href="#">277</a>

Connector Type	Page
Straight, Cable Connectors	<a href="#">276</a>
Straight, PCB Mount	<a href="#">277</a>
<b>Reverse Thread SMA Male Connectors</b>	
Right Angle, Cable Connectors	<a href="#">276</a>
Straight, Cable Connectors	<a href="#">276</a>
<b>SC Female Connectors</b>	
Straight, 4 Hole Flange, Terminal	<a href="#">268</a>
Straight, Bulkhead, Terminal	<a href="#">268</a>
<b>SC Male Connectors</b>	
Right Angle, Cable Connectors	<a href="#">268</a>
Straight, Cable Connectors	<a href="#">267</a>
<b>SHV Jack Connectors</b>	
Straight, 4 Hole Flange, Terminal	<a href="#">268</a>
Straight, Bulkhead, Cable Connectors	<a href="#">268</a>
Straight, Bulkhead, Terminal	<a href="#">268</a>
<b>SHV Plug Connectors</b>	
Straight, Bulkhead, Terminal	<a href="#">268</a>
Straight, Cable Connectors	<a href="#">268</a>
<b>SMA Female Connectors</b>	
Right Angle, 2 Hole Flange, Terminal	<a href="#">274</a>
Right Angle, 4 Hole Flange, Field Replaceable Contact	<a href="#">274</a>
Right Angle, 4 Hole Flange, Terminal	<a href="#">274</a>
Right Angle, Bulkhead, PCB Mount	<a href="#">274</a>
Right Angle, Bulkhead, Terminal	<a href="#">274</a>
Right Angle, PCB Mount	<a href="#">274</a>
Straight, 2 Hole Flange, Cable Connectors	<a href="#">273</a>
Straight, 2 Hole Flange, Field Replaceable Contact	<a href="#">273</a>
Straight, 2 Hole Flange, Terminal	<a href="#">273</a>
Straight, 4 Hole Flange, Cable Connectors	<a href="#">273</a>
Straight, 4 Hole Flange, Field Replaceable Contact	<a href="#">273</a>
Straight, 4 Hole Flange, Terminal	<a href="#">274</a>
Straight, Bulkhead, Cable Connectors	<a href="#">272</a>
Straight, Bulkhead, PCB Mount	<a href="#">272</a>
Straight, Bulkhead, Terminal	<a href="#">272</a>
Straight, Cable Connectors	<a href="#">271</a>
Straight, PCB Mount	<a href="#">271</a>
Straight, Press-In, Terminal	<a href="#">274</a>
<b>SMA Male Connectors</b>	
Right Angle, Cable Connectors	<a href="#">270</a>
Straight, 2 Hole Flange, Field Replaceable Contact	<a href="#">270</a>
Straight, 2 Hole Flange, Terminal	<a href="#">270</a>
Straight, 4 Hole Flange, Field Replaceable Contact	<a href="#">270</a>
Straight, 4 Hole Flange, Terminal	<a href="#">270</a>
Straight, Bulkhead, Terminal	<a href="#">270</a>
Straight, Cable Connectors	<a href="#">269</a>
Straight, PCB Mount	<a href="#">269</a>
<b>SMB Jack Connectors</b>	
Right Angle, Bulkhead, PCB Mount	<a href="#">279</a>
Right Angle, Bulkhead, Terminal	<a href="#">279</a>
Right Angle, PCB Mount	<a href="#">278</a>
Straight, 2 Hole Flange, Terminal	<a href="#">278</a>
Straight, 4 Hole Flange, Terminal	<a href="#">278</a>
Straight, Bulkhead, Cable Connectors	<a href="#">278</a>



# Connector Locator







Connector Type	Page
Straight, Bulkhead, PCB Mount	<a href="#">278</a>
Straight, Bulkhead, Terminal	<a href="#">278</a>
Straight, Cable Connectors	<a href="#">278</a>
Straight, PCB Mount	<a href="#">278</a>
<b>SMB Plug Connectors</b>	
Right Angle, Cable Connectors	<a href="#">278</a>
Right Angle, PCB Mount	<a href="#">278</a>
Straight, Bulkhead, Terminal	<a href="#">277</a>
Straight, Cable Connectors	<a href="#">277</a>
Straight, PCB Mount	<a href="#">277</a>
<b>SMC Jack Connectors</b>	
Right Angle, Bulkhead, Terminal	<a href="#">280</a>
Right Angle, PCB Mount	<a href="#">280</a>
Straight, 4 Hole Flange, Terminal	<a href="#">280</a>
Straight, Bulkhead, Cable Connectors	<a href="#">279</a>
Straight, Bulkhead, PCB Mount	<a href="#">280</a>
Straight, Bulkhead, Terminal	<a href="#">280</a>
Straight, Cable Connectors	<a href="#">279</a>
Straight, PCB Mount	<a href="#">279</a>
<b>SMC Plug Connectors</b>	
Right Angle, Cable Connectors	<a href="#">279</a>
Right Angle, PCB Mount	<a href="#">279</a>
Straight, Cable Connectors	<a href="#">279</a>
Straight, PCB Mount	<a href="#">279</a>
<b>SMP Female Connectors</b>	
Right Angle, Cable Connectors	<a href="#">282</a>
Straight, Cable Connectors	<a href="#">282</a>
Straight, PCB Mount	<a href="#">282</a>
<b>SMP Male Connectors</b>	
Right Angle, PCB Mount	<a href="#">281</a>
Straight, 2 Hole Flange, Cable Connectors	<a href="#">281</a>
Straight, 2 Hole Flange, Shroud	<a href="#">281</a>
Straight, 2 Hole Flange, Terminal	<a href="#">281</a>
Straight, Bulkhead, Cable Connectors	<a href="#">281</a>
Straight, PCB Mount	<a href="#">280</a>
Straight, Solder, Shroud	<a href="#">281</a>
Straight, Solder, Terminal	<a href="#">281</a>
Straight, Terminal	<a href="#">281</a>
Straight, Thread-In, Shroud	<a href="#">281</a>
Straight, Thread-In, Terminal	<a href="#">281</a>
<b>SSMA Female Connectors</b>	
Right Angle, PCB Mount	<a href="#">283</a>
Straight, 2 Hole Flange, Cable Connectors	<a href="#">283</a>
Straight, 2 Hole Flange, Terminal	<a href="#">283</a>
Straight, 4 Hole Flange, Cable Connectors	<a href="#">283</a>
Straight, 4 Hole Flange, Terminal	<a href="#">283</a>
Straight, Bulkhead, Cable Connectors	<a href="#">283</a>
Straight, Bulkhead, PCB Mount	<a href="#">283</a>
Straight, Bulkhead, Terminal	<a href="#">283</a>
Straight, Cable Connectors	<a href="#">283</a>
Straight, PCB Mount	<a href="#">283</a>
<b>SSMA Male Connectors</b>	
Right Angle, Cable Connectors	<a href="#">282</a>

Connector Type	Page
Straight, 4 Hole Flange, Terminal	<a href="#">282</a>
Straight, Cable Connectors	<a href="#">282</a>
Straight, PCB Mount	<a href="#">282</a>
<b>SSMB Jack Connectors</b>	
Right Angle, PCB Mount	<a href="#">284</a>
Straight, 4 Hole Flange, Terminal	<a href="#">284</a>
Straight, Bulkhead, Cable Connectors	<a href="#">284</a>
Straight, Bulkhead, Terminal	<a href="#">284</a>
Straight, Cable Connectors	<a href="#">284</a>
Straight, PCB Mount	<a href="#">284</a>
<b>SSMB Plug Connectors</b>	
Right Angle, Cable Connectors	<a href="#">284</a>
Straight, Cable Connectors	<a href="#">284</a>
<b>SSMC Jack Connectors</b>	
Right Angle, Bulkhead, Cable Connectors	<a href="#">285</a>
Right Angle, Bulkhead, PCB Mount	<a href="#">285</a>
Right Angle, Bulkhead, Terminal	<a href="#">285</a>
Right Angle, PCB Mount	<a href="#">285</a>
Straight, 2 Hole Flange, Terminal	<a href="#">285</a>
Straight, 4 Hole Flange, Terminal	<a href="#">285</a>
Straight, Bulkhead, Cable Connectors	<a href="#">285</a>
Straight, Bulkhead, Terminal	<a href="#">285</a>
Straight, PCB Mount	<a href="#">285</a>
<b>SSMC Plug Connectors</b>	
Right Angle, Cable Connectors	<a href="#">284</a>
Right Angle, PCB Mount	<a href="#">284</a>
Straight, Cable Connectors	<a href="#">284</a>
<b>TNC Female Connectors</b>	
Right Angle, Bulkhead, Cable Connectors	<a href="#">288</a>
Right Angle, Bulkhead, PCB Mount	<a href="#">288</a>
Right Angle, Bulkhead, Terminal	<a href="#">288</a>
Right Angle, PCB Mount	<a href="#">288</a>
Straight, 4 Hole Flange, Cable Connectors	<a href="#">288</a>
Straight, 4 Hole Flange, Terminal	<a href="#">288</a>
Straight, Bulkhead, Cable Connectors	<a href="#">287</a>
Straight, Bulkhead, PCB Mount	<a href="#">287</a>
Straight, Bulkhead, Terminal	<a href="#">288</a>
Straight, Cable Connectors	<a href="#">287</a>
<b>TNC Male Connectors</b>	
Right Angle, Cable Connectors	<a href="#">286</a>
Straight, 4 Hole Flange, Terminal	<a href="#">286</a>
Straight, Cable Connectors	<a href="#">285</a>
<b>TNC Sexless Connectors</b>	
Straight, Cable Connectors	<a href="#">285</a>
<b>UHF Female Connectors</b>	
Straight, 4 Hole Flange, Terminal	<a href="#">290</a>
Straight, Bulkhead, Terminal	<a href="#">290</a>
Straight, Cable Connectors	<a href="#">290</a>
<b>UHF Male Connectors</b>	
Straight, Cable Connectors	<a href="#">290</a>
<b>UHF Sexless Connectors</b>	
Straight, Cable Connectors	<a href="#">290</a>
<b>UMCX Jack Connectors</b>	
Straight, PCB Mount	<a href="#">290</a>



## 1.0mm Connectors

Connection Method	Product Image	Attachment Cable/Contact	Coax Type / Termination Type	Model No.	PRICE				ROW
					1	2-4	5-9	10 +	
	<b>Female</b>								
PCB Mount		Clamp/Solder (Captive Contact)	End Launch	<a href="#">PE45403</a>	\$1,166.08	\$1,125.27	\$1,084.45	\$1,049.47	1

## 1.0/2.3 Connectors

Connection Method	Product Image	Attachment Cable/Contact	Coax Type / Termination Type	Model No.	PRICE				ROW
					1-24	25-49	50-99	100 +	
	<b>Plug</b>								
Cable Connectors		Crimp/Solder	RG174, RG316, RG188, LMR-100, PE-B100, PE-C100, .100 inch	<a href="#">PE44244</a>	\$16.44	\$15.62	\$14.80	\$14.14	2
			RG188-DS, RG316-DS	<a href="#">PE45166</a>	\$12.97	\$12.32	\$11.67	\$11.15	3
			RG55, RG142, RG223, RG400	<a href="#">PE44242</a>	\$14.76	\$14.02	\$13.28	\$12.69	4
			RG58, RG303, RG141, PE-C195, PE-P195, LMR-195, .195 inch	<a href="#">PE44243</a>	\$16.97	\$16.12	\$15.27	\$14.59	5
	<b>Plug Right Angle</b>								
Cable Connectors		Crimp/Solder	RG174, RG316, RG188, LMR-100, PE-B100, PE-C100, .100 inch	<a href="#">PE44249</a>	\$16.47	\$15.65	\$14.82	\$14.16	6
			RG316-DS, RG188-DS	<a href="#">PE44783</a>	\$18.08	\$17.18	\$16.27	\$15.55	7
			RG55, RG142, RG223, RG400	<a href="#">PE44247</a>	\$17.16	\$16.30	\$15.44	\$14.76	8
			RG58, RG303, RG141, PE-C195, PE-P195, LMR-195, .195 inch	<a href="#">PE44248</a>	\$18.92	\$17.97	\$17.03	\$16.27	9
	<b>Jack</b>								
PCB Mount		Solder	Thru Hole with .200 inch x .055 inch Hole Spacing	<a href="#">PE44257</a>	\$11.76	\$11.17	\$10.58	\$10.11	10
	<b>Jack, Bulkhead Mount</b>								
Cable Connectors		Crimp/Solder	.100 inch, RG316, RG174, RG188, LMR-100, LMR-100A, LMR-100A-FR, PE-C100, PE-B100 with .217 inch DD Hole	<a href="#">PE44254</a>	\$18.80	\$17.86	\$16.92	\$16.17	11
		Solder/Solder	PE-SR405AL, PE-SR405FL, RG405 with .235 inch D Hole	<a href="#">PE44256</a>	\$20.81	\$19.77	\$18.73	\$17.90	12
PCB Mount		Solder	Thru Hole with .220 inch Diameter	<a href="#">PE44259</a>	\$14.52	\$13.79	\$13.07	\$12.49	13
	<b>Jack Right Angle</b>								
PCB Mount		Solder	Thru Hole with .200 inch x .055 inch Hole Spacing	<a href="#">PE44258</a>	\$14.81	\$14.07	\$13.33	\$12.74	14
	<b>Jack Right Angle, Bulkhead Mount</b>								
Cable Connectors		Crimp/Solder	RG174, RG316, RG188 with .236 inch DD Hole	<a href="#">PE44261</a>	\$17.63	\$16.75	\$15.87	\$15.16	15
			RG58 with .236 inch DD Hole	<a href="#">PE44260</a>	\$17.97	\$17.07	\$16.17	\$15.45	16

## 1.85mm Connectors

Connection Method	Product Image	Attachment Cable/Contact	Coax Type / Termination Type	Model No.	PRICE				ROW
					1 Pc.	See Web for Volume Pricing			
	<b>Male</b>								
Cable Connectors		Clamp/Solder	PE-047SR, PE-SR047AL, PE-SR047FL	<a href="#">PE44799</a>	\$131.93				17
			PE-P086, PE-P086LL	<a href="#">PE45005</a>	\$96.63				18
		Solder	PE-047SR, PE-SR047AL, PE-SR047FL	<a href="#">PE45410</a>	\$98.30		See Web for Volume Pricing		19
			PECX001, PECX002	<a href="#">PE45482</a>	\$120.89			20	
			PECX003, PECX004	<a href="#">PE45484</a>	\$120.89			21	
			PE-SR405AL, PE-SR405FL, PE-SR405FLJ, PE-SR405TN, RG405	<a href="#">PE44336</a>	\$163.48			22	
PE-SR405AL, RG405, PE-SR405FLJ	<a href="#">PE45413</a>	\$102.13		23					

\* Fits MIL-C-17 and equivalent cable versions only



Technical Support  
+1 (949) 261-1920









Same-Day Shipping,  
Even Custom  
Cable Assemblies

Connectors







See Our Website For Current Pricing & Real-Time Stock Availability!



## 1.85mm Connectors

Connection Method	Product Image	Attachment Cable/Contact	Coax Type / Termination Type	Model No.	PRICE				ROW
					1 Pc.	See Web for Volume Pricing			
PCB Mount		Clamp/Solder (Captive Contact)	End Launch	<a href="#">PE45517</a>	\$313.68				24
			End Launch	<a href="#">PE45518</a>	\$296.12				25
<b>Male, Threaded Mount</b>									
Field Replaceable		Field Replaceable	.009 inch Pin	<a href="#">PE44338</a>	\$171.11				26
<b>Female</b>									
Cable Connectors		Clamp/Solder	PE-047SR, PE-SR047AL, PE-SR047FL	<a href="#">PE44800</a>	\$148.98			See Web for Volume Pricing	27
PCB Mount		Clamp/Solder (Captive Contact)	End Launch	<a href="#">PE45515</a>	\$275.77				28
			End Launch	<a href="#">PE45402</a>	\$256.13				29
			End Launch	<a href="#">PE45477</a>	\$187.58				30
End Launch	<a href="#">PE45516</a>	\$274.10			31				
<b>Female, Bulkhead Mount</b>									
Cable Connectors		Clamp/Solder	PE-SR405AL, PE-SR405FL, PE-SR405FLJ, PE-SR405TN, RG405 with .252 inch D Hole	<a href="#">PE44802</a>	\$141.00				32
<b>Female, 2 Hole Flange Mount</b>									
Field Replaceable		Field Replaceable	0.009 inch Pin	<a href="#">PE45632</a>	\$81.03				33
			0.009 inch Pin	<a href="#">PE45633</a>	\$77.14				34
<b>Female, 4 Hole Flange Mount</b>									
Field Replaceable		Field Replaceable	0.009 inch Pin	<a href="#">PE45631</a>	\$60.60				35
			0.009 inch Pin with .340 inch Hole Spacing	<a href="#">PE45630</a>	\$65.09				36

## 10-32 Connectors





Connection Method	Product Image	Attachment Cable/Contact	Coax Type / Termination Type	Model No.	PRICE				ROW
					1-24	25-49	50-99	100 +	
<b>Male</b>									
Cable Connectors		Clamp/Solder	RG174, RG316, RG188, PE-B100, PE-C100, .100 inch, LMR-100	<a href="#">PE44353</a>	\$38.30	\$36.39	\$34.47	\$32.94	37
			RG178, RG196	<a href="#">PE44354</a>	\$45.12	\$43.32	\$41.96	\$41.06	38
		Crimp/Solder	RG174, RG316, RG188, LMR-100, PE-B100, PE-C100, .100 inch	<a href="#">PE44351</a>	\$27.36	\$25.99	\$24.62	\$23.53	39
			RG178, RG196	<a href="#">PE44352</a>	\$41.52	\$39.44	\$37.37	\$35.71	40
			RG188-DS, RG316-DS	<a href="#">PE45170</a>	\$26.82	\$25.48	\$24.14	\$23.07	41
<b>Male Right Angle</b>									
Cable Connectors		Crimp/Solder	RG174, RG316, RG188, PE-B100, PE-C100, .100 inch, LMR-100	<a href="#">PE44355</a>	\$27.63	\$26.25	\$24.87	\$23.76	42
			RG178, RG196	<a href="#">PE44356</a>	\$45.58	\$43.30	\$41.02	\$39.20	43
			RG316-DS, RG188-DS	<a href="#">PE45032</a>	\$27.91	\$26.51	\$25.12	\$24.00	44
<b>Female</b>									
Cable Connectors		Clamp/Solder	RG174, RG316, RG188, PE-B100, PE-C100, .100 inch, LMR-100	<a href="#">PE44363</a>	\$45.85	\$43.56	\$41.27	\$39.43	45
			RG178, RG196	<a href="#">PE44364</a>	\$38.65	\$36.72	\$34.79	\$33.24	46
		Crimp/Solder	RG174, RG316, RG188, PE-B100, PE-C100, .100 inch, LMR-100	<a href="#">PE44361</a>	\$36.90	\$35.06	\$33.21	\$31.73	47
			RG178, RG196	<a href="#">PE44362</a>	\$35.09	\$33.69	\$32.63	\$31.93	48
			RG188-DS, RG316-DS	<a href="#">PE45171</a>	\$27.73	\$26.34	\$24.96	\$23.85	49
PCB Mount		Solder	Thru Hole with .200 inch x .067 inch Hole Spacing	<a href="#">PE44359</a>	\$27.78	\$26.39	\$25.00	\$23.89	50

\* Fits MIL-C-17 and equivalent cable versions only





Connectors

See Our Website For Current Pricing & Real-Time Stock Availability!



## 10-32 Connectors

Connection Method	Product Image	Attachment Cable/Contact	Coax Type / Termination Type	Model No.	PRICE				ROW
					1-24	25-49	50-99	100 +	
<b>Female, Bulkhead Mount</b>									
Cable Connectors		Clamp/Solder	.100 inch, RG316, RG174, RG188, LMR-100, LMR-100A, LMR-100A-FR, PE-C100, PE-B100 with .295 inch D Hole	<a href="#">PE44367</a>	\$34.83	\$33.09	\$31.35	\$29.95	51
			RG178, RG196 with .295 inch D Hole	<a href="#">PE44368</a>	\$40.23	\$38.22	\$36.21	\$34.60	52
		Crimp/Solder	RG174, RG316, RG188 with .295 inch D Hole	<a href="#">PE44365</a>	\$37.62	\$35.74	\$33.86	\$32.35	53
			RG178, RG196 with .295 inch D Hole	<a href="#">PE44366</a>	\$36.35	\$34.53	\$32.72	\$31.26	54
Terminal		Solder	Solder Cup with .177 inch D Hole	<a href="#">PE44357</a>	\$29.51	\$28.03	\$26.56	\$25.38	55
			Solder Cup with .295 inch D Hole	<a href="#">PE44358</a>	\$38.65	\$36.72	\$34.79	\$33.24	56
<b>Female Right Angle</b>									
PCB Mount		Solder	Thru Hole with .200 inch x .067 inch Hole Spacing	<a href="#">PE44360</a>	\$33.97	\$32.27	\$30.57	\$29.21	57

## 2.2-5 Connectors

Connection Method	Product Image	Attachment Cable/Contact	Coax Type / Termination Type	Model No.	PRICE				ROW
					1-24	25-49	50-99	100 +	
<b>Male</b>									
Cable Connectors		Solder/Solder	PE-1/4SFHC, SPP-250-LLPL, SPO-250, SPF-250	<a href="#">PE45673</a>	\$18.48	\$17.56	\$16.63	\$15.89	58
			PE-1/4SFHC, SPP-250-LLPL, SPO-250, SPF-250	<a href="#">PE45677</a>	\$24.08	\$22.88	\$21.67	\$20.71	59
			TFT-402, TFT-402-LF	<a href="#">TC-402-225M-LP</a>	\$25.30	\$25.30	\$25.30	\$25.30	60
<b>Male Right Angle</b>									
Cable Connectors		Solder/Solder	PE-1/4SFHC, SPP-250-LLPL, SPO-250, SPF-250	<a href="#">PE45674</a>	\$25.20	\$23.94	\$22.68	\$21.67	61
<b>Female</b>									
Cable Connectors		Solder/Solder	PE-1/4SFHC, SPP-250-LLPL, SPO-250, SPF-250	<a href="#">PE45675</a>	\$18.48	\$17.56	\$16.63	\$15.89	62
			TFT-402, TFT-402-LF	<a href="#">TC-402-225F-LP</a>	\$25.30	\$25.30	\$25.30	\$25.30	63
<b>Female, Bulkhead Mount</b>									
Cable Connectors		Solder/Solder	PE-1/4SFHC, SPP-250-LLPL, SPO-250, SPF-250	<a href="#">PE45676</a>	\$21.28	\$20.22	\$19.15	\$18.30	64







## 2.4mm Connectors

Connection Method	Product Image	Attachment Cable/Contact	Coax Type / Termination Type	Model No.	1 Pc.	See Web for Volume Pricing			ROW
<b>Male</b>									
Cable Connectors		Clamp/Solder	PE-SR405AL, PE-SR405FL, PE-SR405FLJ, PE-SR405TN, RG405	<a href="#">PE45541</a>	\$97.71	See Web for Volume Pricing			65
			PE-047SR, PE-SR047AL, PE-SR047FL	<a href="#">PE45411</a>	\$93.62				66
	Solder	PE-SR405AL, PE-SR405FL, RG405	<a href="#">PE44215</a>	\$100.05	67				
		PE-SR405AL, RG405, PE-SR405FLJ	<a href="#">PE45414</a>	\$93.62	68				
PCB Mount		Clamp	Vertical Launch	<a href="#">PE45457</a>	\$52.89				69
			Vertical Launch	<a href="#">PE45456</a>	\$51.90				70
		Clamp/Solder (Captive Contact)	End Launch	<a href="#">PE45514</a>	\$186.76				71
End Launch	<a href="#">PE45513</a>		\$229.32	72					



\* Fits MIL-C-17 and equivalent cable versions only



## 2.4mm Connectors

Connection Method	Product Image	Attachment Cable/Contact	Coax Type / Termination Type	Model No.	PRICE			ROW
					1 Pc.	See Web for Volume Pricing		
<b>Male, 2 Hole Flange Mount</b>								
Terminal		Solder	Pin with .481 inch Hole Spacing	<a href="#">PE44220</a>	\$174.91			73
<b>Female</b>								
Cable Connectors		Clamp/Solder	PE-SR405AL, PE-SR405FL, PE-SR405FLJ, PE-SR405TN, RG405	<a href="#">PE44216</a>	\$205.60			74
PCB Mount		Clamp	Vertical Launch	<a href="#">PE45455</a>	\$49.44	See Web for Volume Pricing		75
			Vertical Launch	<a href="#">PE45454</a>	\$49.44			76
		Clamp/Solder (Captive Contact)	End Launch	<a href="#">PE45511</a>	\$206.99			77
			End Launch	<a href="#">PE45512</a>	\$230.89			78
			End Launch	<a href="#">PE45473</a>	\$100.13			79
			End Launch	<a href="#">PE45472</a>	\$104.04			80
			End Launch	<a href="#">PE45476</a>	\$104.04			81
			End Launch	<a href="#">PE45401</a>	\$190.77			82
End Launch	<a href="#">PE45474</a>	\$98.26	83					
End Launch	<a href="#">PE45475</a>	\$98.26	84					
<b>Female, Bulkhead Mount</b>								
Cable Connectors		Clamp/Solder	PE-SR405AL, PE-SR405FL, PE-SR405FLJ, PE-SR405TN, RG405 with .252 inch D Hole	<a href="#">PE44801</a>	\$149.71			85
<b>Female, 2 Hole Flange Mount</b>								
Field Replaceable		Field Replaceable	0.009 inch Pin	<a href="#">PE45626</a>	\$65.77	See Web for Volume Pricing		86
			0.009 inch Pin	<a href="#">PE45622</a>	\$60.92			87
			0.009 inch Pin with .481 inch Hole Spacing	<a href="#">PE45618</a>	\$50.61			88
			0.012 inch Pin	<a href="#">PE45623</a>	\$49.20			89
			0.012 inch Pin	<a href="#">PE45627</a>	\$53.10			90
			0.012 inch Pin with .481 inch Hole Spacing	<a href="#">PE45619</a>	\$49.26			91
			0.015 inch Pin	<a href="#">PE45624</a>	\$51.65			92
			0.015 inch Pin	<a href="#">PE45628</a>	\$55.24			93
			0.015 inch Pin with .481 inch Hole Spacing	<a href="#">PE45620</a>	\$51.73			94
			0.02 inch Pin	<a href="#">PE45625</a>	\$54.11			95
			0.02 inch Pin	<a href="#">PE45629</a>	\$57.87			96
			0.02 inch Pin with .481 inch Hole Spacing	<a href="#">PE45621</a>	\$54.19			97
<b>Female, 4 Hole Flange Mount</b>								
Field Replaceable		Field Replaceable	0.009 inch Pin	<a href="#">PE45614</a>	\$53.25			98
			0.009 inch Pin with .340 inch Hole Spacing	<a href="#">PE45610</a>	\$58.03			99
			0.012 inch Pin	<a href="#">PE45615</a>	\$42.60			1
			0.012 inch Pin with .340 inch Hole Spacing	<a href="#">PE45611</a>	\$53.83			2
			0.015 inch Pin	<a href="#">PE45616</a>	\$44.74			3
			0.015 inch Pin with .340 inch Hole Spacing	<a href="#">PE45612</a>	\$49.21			4
			0.02 inch Pin	<a href="#">PE45617</a>	\$46.85			5
			0.02 inch Pin with .340 inch Hole Spacing	<a href="#">PE45613</a>	\$44.99			6

## 2.92mm Connectors











Connection Method	Product Image	Attachment Cable/Contact	Coax Type / Termination Type	Model No.	PRICE			ROW
					1 Pc.	See Web for Volume Pricing		
<b>Male</b>								
Cable Connectors		Clamp/Solder	PE-SR047FL, PE-SR047AL, PE-047SR	<a href="#">PE44797</a>	\$120.42	See Web for Volume Pricing		7
			PE-SR405AL, PE-SR405FL, PE-SR405FLJ, PE-SR405TN, RG405	<a href="#">PE44796</a>	\$88.35			8
		Solder	PE-047SR, PE-SR047AL, PE-SR047FL	<a href="#">PE45412</a>	\$85.12			9
			PE-118SR, 0.118 inch	<a href="#">PE45486</a>	\$119.14			10
			PE-120SRLL, Tinned 120LL	<a href="#">PE45487</a>	\$112.97			11
			PECX001, PECX002	<a href="#">PE45483</a>	\$112.97			12
			PECX005, PECX006	<a href="#">PE45485</a>	\$114.66			13
			PE-SR402AL, PE-SR402FL, PE-SR402FLJ, PE-SR402TN, RG402	<a href="#">PE4987</a>	\$51.35			14
			PE-SR405AL, PE-SR405FL, RG405	<a href="#">PE4988</a>	\$54.17			15
			PE-SR405AL, RG405, PE-SR405FLJ	<a href="#">PE45415</a>	\$85.12			16

\* Fits MIL-C-17 and equivalent cable versions only

Connectors

See Our Website For Current Pricing & Real-Time Stock Availability!

## 2.92mm Connectors

Connection Method	Product Image	Attachment Cable/Contact	Coax Type / Termination Type	Model No.	PRICE			ROW
					1 Pc.	See Web for Volume Pricing		
PCB Mount		Clamp	Vertical Launch	<a href="#">PE45453</a>	\$49.29	See Web for Volume Pricing		17
			Vertical Launch	<a href="#">PE45452</a>	\$49.29			18
		Clamp/Solder (Captive Contact)	End Launch	<a href="#">PE45509</a>	\$200.97			19
			End Launch	<a href="#">PE45510</a>	\$189.56			20
<b>Male, 2 Hole Flange Mount</b>								
Field Replaceable		Field Replaceable	.012 inch Pin with .481 inch Hole Spacing	<a href="#">PE44232</a>	\$77.38			21
<b>Female</b>								
Cable Connectors		Clamp/Solder	PE-047SR, PE-SR047AL, PE-SR047FL	<a href="#">PE44798</a>	\$134.88			22
			PE-SR402AL, PE-SR402FL, RG402	<a href="#">PE44227</a>	\$136.09			23
PCB Mount		Clamp	Vertical Launch	<a href="#">PE45450</a>	\$46.06	See Web for Volume Pricing		24
			Vertical Launch	<a href="#">PE45451</a>	\$46.06			25
		Clamp/Solder (Captive Contact)	End Launch	<a href="#">PE45508</a>	\$172.57			26
			End Launch	<a href="#">PE45507</a>	\$182.92			27
			End Launch	<a href="#">PE45470</a>	\$77.01			28
			End Launch	<a href="#">PE45400</a>	\$180.09			29
			End Launch	<a href="#">PE45467</a>	\$77.01			30
			End Launch	<a href="#">PE45468</a>	\$77.01			31
			End Launch	<a href="#">PE45469</a>	\$77.01			32
			End Launch	<a href="#">PE45471</a>	\$72.73			33
<b>Female, Bulkhead Mount</b>								
Cable Connectors		Clamp/Solder	PE-SR405AL, PE-SR405FL, PE-SR405FLJ, PE-SR405TN, RG405 with .235 inch D Hole	<a href="#">PE4992</a>	\$174.91			34
<b>Female, 2 Hole Flange Mount</b>								
Field Replaceable		Field Replaceable	0.009 inch Pin	<a href="#">PE45602</a>	\$44.59	See Web for Volume Pricing		35
			0.009 inch Pin	<a href="#">PE45606</a>	\$44.59			36
			0.009 inch Pin with .481 inch Hole Spacing	<a href="#">PE45598</a>	\$47.27			37
			0.012 inch Pin	<a href="#">PE45603</a>	\$35.67			38
			0.012 inch Pin	<a href="#">PE45607</a>	\$35.67			39
			.012 inch Pin with .481 inch Hole Spacing	<a href="#">PE44229</a>	\$144.37			40
			0.012 inch Pin with .481 inch Hole Spacing	<a href="#">PE45599</a>	\$39.68			41
			0.015 inch Pin	<a href="#">PE45604</a>	\$37.46			42
			0.015 inch Pin	<a href="#">PE45608</a>	\$37.46			43
			0.015 inch Pin with .481 inch Hole Spacing	<a href="#">PE45600</a>	\$41.66			44
			0.02 inch Pin	<a href="#">PE45605</a>	\$39.24			45
			0.02 inch Pin	<a href="#">PE45609</a>	\$39.24			46
0.02 inch Pin with .481 inch Hole Spacing	<a href="#">PE45601</a>	\$37.95	47					
<b>Female, 4 Hole Flange Mount</b>								
Cable Connectors		Clamp/Non-Solder Contact	PE-047SR, PE-SR047FL	<a href="#">PE44905</a>	\$126.59			48
		Solder/Non-Solder Contact	RG405, PE-SR405FL	<a href="#">PE44904</a>	\$125.61			49
Field Replaceable		Field Replaceable	0.009 inch Pin	<a href="#">PE45590</a>	\$45.40	See Web for Volume Pricing		50
			0.009 inch Pin with .340 inch Hole Spacing	<a href="#">PE45594</a>	\$46.73			51
			0.012 inch Pin	<a href="#">PE45591</a>	\$36.32			52
			0.012 inch Pin with .340 inch Hole Spacing	<a href="#">PE45595</a>	\$37.39			53
			0.015 inch Pin	<a href="#">PE45592</a>	\$38.14			54
			0.015 inch Pin with .340 inch Hole Spacing	<a href="#">PE45596</a>	\$39.26			55
			0.02 inch Pin	<a href="#">PE45593</a>	\$39.95			56
0.02 inch Pin with .340 inch Hole Spacing	<a href="#">PE45597</a>	\$37.46	57					

Connectors

See Our Website For Current Pricing & Real-Time Stock Availability!



\* Fits MIL-C-17 and equivalent cable versions only

 Technical Support  
+1 (949) 261-1920





 Same-Day Shipping,  
Even Custom Cable Assemblies







### 3.5mm Connectors

Connection Method	Product Image	Attachment Cable/Contact	Coax Type / Termination Type	Model No.	PRICE				ROW
					1 Pc.	See Web for Volume Pricing			
<b>Male</b>									
Cable Connectors		Clamp/Solder	PE-SR402AL, PE-SR402FL, PE-SR402FLJ, PE-SR402TN, RG402	<a href="#">PE4981</a>	\$102.12				58
			PE-SR405AL, PE-SR405FL, PE-SR405FLJ, PE-SR405TN, RG405	<a href="#">PE4982</a>	\$108.11				59
<b>Female</b>									
Cable Connectors		Clamp/Solder	PE-SR402AL, PE-SR402FL, PE-SR402FLJ, PE-SR402TN, RG402	<a href="#">PE45011</a>	\$107.29	See Web for Volume Pricing			60
			VNA Test Cable	<a href="#">PE45398</a>	\$688.39				61
<b>Female, Bulkhead Mount</b>									
Cable Connectors		Clamp/Solder	PE-SR402AL, PE-SR402FL, RG402 with .235 inch D Hole	<a href="#">PE4985</a>	\$294.90				62

### 4.1/9.5 Mini DIN Connectors

Connection Method	Product Image	Attachment Cable/Contact	Coax Type / Termination Type	Model No.	PRICE				ROW
					1-24	25-49	50-99	100 +	
<b>Male</b>									
Cable Connectors		Solder/Solder	PE-1/4SFHC, SPP-250-LLPL, SPO-250, SPF-250	<a href="#">PE45650</a>	\$16.24	\$15.43	\$14.62	\$13.97	63
			SPP-250-LLPL	<a href="#">PE45421</a>	\$30.31	\$28.79	\$27.28	\$26.07	64
<b>Male Right Angle</b>									
Cable Connectors		Solder/Solder	PE-1/4SFHC, SPP-250-LLPL, SPO-250, SPF-250	<a href="#">PE45651</a>	\$21.28	\$20.22	\$19.15	\$18.30	65
			SPP-250-LLPL	<a href="#">PE45422</a>	\$41.66	\$39.58	\$37.49	\$35.83	66
			SPP-250-LLPL	<a href="#">TC-SPP250-4195M-RALP</a>	\$19.71	\$19.71	\$19.71	\$19.71	67
<b>Female</b>									
Cable Connectors		Solder/Solder	PE-1/4SFHC, SPP-250-LLPL, SPO-250, SPF-250	<a href="#">PE45652</a>	\$20.16	\$19.15	\$18.14	\$17.34	68
			SPP-250-LLPL	<a href="#">PE45420</a>	\$34.08	\$32.38	\$30.67	\$29.31	69
			TFT-402, TFT-402-LF	<a href="#">TC-402-4195F-LP</a>	\$13.20	\$13.20	\$13.20	\$13.20	70
<b>Female, Bulkhead Mount</b>									
Cable Connectors		Solder/Solder	PE-1/4SFHC, SPP-250-LLPL, SPO-250, SPF-250	<a href="#">PE45653</a>	\$22.96	\$21.81	\$20.66	\$19.75	71

### 4.3-10 Connectors







Connection Method	Product Image	Attachment Cable/Contact	Coax Type / Termination Type	Model No.	PRICE				ROW
					1-24	25-49	50-99	100 +	
<b>Male</b>									
Cable Connectors		Clamp/Solder	RG213, RG8, RG225, RG214, RG393	<a href="#">PE45295</a>	\$48.07	\$45.67	\$43.26	\$41.34	72
			RG213, RG8, RG225, RG214, RG393	<a href="#">PE45296</a>	\$73.08	\$69.43	\$65.77	\$62.85	73
		Crimp/Non-Solder Contact	LMR-240	<a href="#">EZ-240-4310M-X</a>	\$22.17	\$22.17	\$22.17	\$22.17	74
			LMR-240	<a href="#">TC-240-4310M-X</a>	\$22.17	\$22.17	\$22.17	\$22.17	75
			LMR-400	<a href="#">TC-400-4310M-X</a>	\$22.79	\$22.79	\$22.79	\$22.79	76
		Crimp/Solder	LMR-600	<a href="#">TC-600-4310M-X</a>	\$24.64	\$24.64	\$24.64	\$24.64	77
			PE-1/2SFHC	<a href="#">PE45299</a>	\$20.03	\$19.03	\$18.03	\$17.23	78
			PE-1/2SFHC	<a href="#">PE45300</a>	\$32.30	\$30.69	\$29.07	\$27.78	79
		Solder/Solder	PE-1/4SFHC	<a href="#">PE45298</a>	\$19.75	\$18.76	\$17.78	\$16.99	80

\* Fits MIL-C-17 and equivalent cable versions only



Connectors

See Our Website For Current Pricing & Real-Time Stock Availability!

## 4.3-10 Connectors

Connection Method	Product Image	Attachment Cable/Contact	Coax Type / Termination Type	Model No.	PRICE				ROW
					1-24	25-49	50-99	100 +	
<b>Male</b>									
Cable Connectors		Solder/Solder	PE-1/4SFHC	<a href="#">PE45297</a>	\$45.44	\$43.17	\$40.90	\$39.08	81
			PE-1/4SFHC, SPP-250-LLPL, SPO-250, SPF-250	<a href="#">PE45654</a>	\$19.04	\$18.09	\$17.14	\$16.37	82
			PE-1/4SFHC, SPP-250-LLPL, SPO-250, SPF-250	<a href="#">PE45658</a>	\$20.16	\$19.15	\$18.14	\$17.34	83
			PE-1/4SFHC, SPP-250-LLPL, SPO-250, SPF-250	<a href="#">PE45659</a>	\$19.04	\$18.09	\$17.14	\$16.37	84
			RG402, PE-SR402AL, PE-SR402FL, PE-SR402FLJ	<a href="#">PE45301</a>	\$33.65	\$31.97	\$30.29	\$28.94	85
			SPO-375, SPF-375, SPP-375-LLPL	<a href="#">TC-375-4310M-LP</a>	\$18.48	\$18.48	\$18.48	\$18.48	86
			SPP-250-LLPL	<a href="#">PE45418</a>	\$31.55	\$29.97	\$28.40	\$27.13	87
			SPP-500-LLPL, SPO-500, SPF-500	<a href="#">TC-500-4310M-LP</a>	\$18.48	\$18.48	\$18.48	\$18.48	88
TFT-402, TFT-402-LF	<a href="#">TC-402-4310MS-LP</a>	\$20.90	\$20.90	\$20.90	\$20.90	89			
TFT-402, TFT-402-LF	<a href="#">TC-402-4310M-LP</a>	\$19.80	\$19.80	\$19.80	\$19.80	90			
<b>Male Right Angle</b>									
Cable Connectors		Solder/Solder	PE-1/2SFHC	<a href="#">PE45302</a>	\$51.74	\$49.15	\$46.57	\$44.50	91
			PE-1/4SFHC, SPP-250-LLPL, SPO-250, SPF-250	<a href="#">PE45655</a>	\$21.28	\$20.22	\$19.15	\$18.30	92
			RG402, PE-SR402AL, PE-SR402FL, PE-SR402FLJ	<a href="#">PE45303</a>	\$57.15	\$54.29	\$51.44	\$49.15	93
			SPP-250-LLPL	<a href="#">PE45419</a>	\$41.66	\$39.58	\$37.49	\$35.83	94
			SPP-250-LLPL, SPO-250, SPF-250	<a href="#">TC-250-4310M-RA-LP</a>	\$19.71	\$19.71	\$19.71	\$19.71	95
TFT-402, TFT-402-LF	<a href="#">TC-402-4310M-RA-LP</a>	\$20.90	\$20.90	\$20.90	\$20.90	96			
<b>Female</b>									
Cable Connectors		Solder/Solder	PE-1/4SFHC, SPP-250-LLPL, SPO-250, SPF-250	<a href="#">PE45656</a>	\$20.16	\$19.15	\$18.14	\$17.34	97
			SPP-250-LLPL	<a href="#">PE45417</a>	\$34.08	\$32.38	\$30.67	\$29.31	98
			SPP-250-LLPL, SPO-250, SPF-250	<a href="#">TC-SPP250-4310F-LP</a>	\$18.48	\$18.48	\$18.48	\$18.48	99
			TFT-402, TFT-402-LF	<a href="#">TC-402-4310F-LP</a>	\$19.80	\$19.80	\$19.80	\$19.80	1
<b>Female, Bulkhead Mount</b>									
Cable Connectors		Solder/Solder	PE-1/4SFHC, SPP-250-LLPL, SPO-250, SPF-250	<a href="#">PE45657</a>	\$21.28	\$20.22	\$19.15	\$18.30	2
			TFT-402, TFT-402-LF	<a href="#">TC-402-4310F-BH-LP</a>	\$20.90	\$20.90	\$20.90	\$20.90	3
<b>Female, 4 Hole Flange Mount</b>									
Cable Connectors		Solder/Solder	PE-1/4SFHC, SPP-250-LLPL, SPO-250, SPF-250	<a href="#">PE45686</a>	\$22.40	\$21.28	\$20.16	\$19.26	4
			RG402, PE-SR402AL, PE-SR402FL, PE-SR402FLJ	<a href="#">PE45304</a>	\$27.92	\$26.52	\$25.13	\$24.01	5
Terminal		Solder	Solder Cup	<a href="#">PE45306</a>	\$21.97	\$20.87	\$19.77	\$18.89	6

## 7/16 DIN Connectors

Connection Method	Product Image	Attachment Cable/Contact	Coax Type / Termination Type	Model No.	PRICE		ROW
					1 Pc.	See Web for Volume Pricing	
<b>Male</b>							
Cable Connectors		Clamp/Non-Solder Contact	1/2 inch Flexible, PE-1/2FAC	<a href="#">PE44738</a>	\$46.77	See Web for Volume Pricing	7
			1/2 inch Helical, 1/2 inch Superflexible, PE-1/2 Helical, PE-1/2SFHC	<a href="#">PE44732</a>	\$50.09		8
			1/4 inch Superflexible, PE-1/4SFHC	<a href="#">PE44728</a>	\$71.12		9
		Clamp/Solder	7/8 inch Annular	<a href="#">PE44993</a>	\$51.23		10
			7/8 inch Annular	<a href="#">PE44568</a>	\$62.05		11
			7/8 inch Helical	<a href="#">PE44558</a>	\$97.41		12
			PE-SR401AL, PE-SR401FL, RG401	<a href="#">PE44278</a>	\$49.09		13
			RG14, RG217	<a href="#">PE44276</a>	\$162.14		14
			RG17, RG218, RG219	<a href="#">PE44277</a>	\$177.87		15
			RG393, RG214, RG225, RG215, RG8	<a href="#">PE4567</a>	\$46.64		16
			RG58, RG55, RG141, RG142, RG223, RG400	<a href="#">PE45037</a>	\$122.01		17
			Crimp/Non-Solder Contact	Solder	LMR-400, PE-C400, PE-B400, PE-B405		<a href="#">EZ-400-716M-X</a>
	LMR-600, PE-C600	<a href="#">EZ-600-716M-X</a>			\$27.10		19
	LMR-600, PE-C600	<a href="#">PE45001</a>			\$67.04		20

\* Fits MIL-C-17 and equivalent cable versions only









# 7/16 DIN Connectors





Connection Method	Product Image	Attachment Cable/Contact	Coax Type / Termination Type	Model No.	PRICE		ROW
					1 Pc.	See Web for Volume Pricing	
<b>Male</b>							
Cable Connectors		Crimp/Non-Solder Contact	PE-C240, RG8X, .240 inch, LMR-240, LMR-240-DB, LMR-240-UF, B7808A	<a href="#">PE44994</a>	\$48.29	See Web for Volume Pricing	21
			PE-C400, PE-B400, PE-B405, LMR-400, LMR-400-DB, LMR-400-UF, .400 inch	<a href="#">PE44538</a>	\$70.26		22
		Crimp/Solder	PE-C195, PE-P195, RG58, RG141, RG303, LMR-195, .195 inch	<a href="#">PE44536</a>	\$44.03		23
			RG213, RG8	<a href="#">PE4570</a>	\$120.89		24
			RG214, RG9, RG225, RG393	<a href="#">PE4571</a>	\$60.97		25
			RG55, RG141, RG142, RG223, RG400	<a href="#">PE4568</a>	\$93.72		26
			RG58	<a href="#">PE4569</a>	\$107.02		27
		Solder/Solder	PE-1/4SFHC, SPP-250-LLPL, SPO-250, SPF-250	<a href="#">PE45660</a>	\$16.24		28
			SPP-250-LLPL	<a href="#">PE45424</a>	\$34.73		29
			SPP-250-LLPL, SPO-250, SPF-250	<a href="#">TC-250-716M-LP</a>	\$14.78		30
			SPP-375-LLPL, SPO-375, SPF-375	<a href="#">TC-375-716M-LP</a>	\$14.78		31
			SPP-500-LLPL, SPO-500, SPF-500	<a href="#">TC-500-716M-LP</a>	\$12.32		32
TFT-402, TFT-402-LF	<a href="#">TC-402-716M-LP</a>	\$15.95	33				
<b>Male Right Angle</b>							
Cable Connectors		Clamp/Non-Solder Contact	1/2 inch Annular, 1/2 inch Flexible, PE-1/2FAC	<a href="#">PE44569</a>	\$54.36	See Web for Volume Pricing	34
			1/2 inch Helical	<a href="#">PE44979</a>	\$38.19		35
		Clamp/Solder	RG14, RG217	<a href="#">PE44282</a>	\$235.39		36
			RG213, RG214, RG8, RG9, RG225, RG393, RG215	<a href="#">PE44280</a>	\$140.80		37
		Crimp/Non-Solder Contact	LMR-400, PE-C400, PE-B400, PE-B405	<a href="#">EZ-400-716M-RA-X</a>	\$24.64		38
		Crimp/Solder	LMR-195, LMR-195-FR, PE-C195, PE-P195	<a href="#">PE45046</a>	\$46.79		39
			PE-C240, RG8X, .240 inch, LMR-240, LMR-240-DB, LMR-240-UF, B7808A	<a href="#">PE44541</a>	\$91.30		40
		Solder/Solder	PE-C600, .600 inch, LMR-600, LMR-600-DB	<a href="#">PE45640</a>	\$88.46		41
			PE-1/4SFHC, SPP-250-LLPL, SPO-250, SPF-250	<a href="#">PE45661</a>	\$21.28		42
			SPP-250-LLPL	<a href="#">PE45425</a>	\$49.22		43
SPP-250-LLPL			<a href="#">TC-SPP250-716M-RA-LP</a>	\$19.71	44		
TFT-402, TFT-402-LF	<a href="#">TC-402-716M-RA-LP</a>	\$20.90	45				
<b>Female</b>							
Cable Connectors		Clamp/Non-Solder Contact	1/2 inch Flexible, PE-1/2FAC	<a href="#">PE44740</a>	\$38.97	See Web for Volume Pricing	46
			1/2 inch Superflexible, PE-1/2SFHC	<a href="#">PE44734</a>	\$50.09		47
		Clamp/Solder	1/2 inch Helical	<a href="#">PE44560</a>	\$44.86		48
			PE-SR401AL, PE-SR401FL, RG401	<a href="#">PE44289</a>	\$123.34		49
			PE-SR402AL, PE-SR402FL, RG402	<a href="#">PE44290</a>	\$116.96		50
			RG14, RG217	<a href="#">PE44288</a>	\$160.92		51
			RG213, RG55, RG141, RG142, RG223, RG400, RG303, PE-C195, PE-P195, LMR-195	<a href="#">PE44283</a>	\$163.48		52
			RG58, RG55, RG141, RG142, RG223, RG400	<a href="#">PE44285</a>	\$147.04		53
		Crimp/Non-Solder Contact	PE-C240, LMR-240, RG8X	<a href="#">PE44545</a>	\$66.19		54
		Crimp/Solder	PE-C195, PE-P195, RG58, RG141, RG303, LMR-195, .195 inch	<a href="#">PE44544</a>	\$40.81		55
			PE-C400, PE-B400, PE-B405, LMR-400, LMR-400-DB, LMR-400-UF	<a href="#">PE44546</a>	\$79.58		56
			RG213, RG8	<a href="#">PE44284</a>	\$134.42		57
			RG214, RG9, RG225, RG393	<a href="#">PE4575</a>	\$165.12		58
			RG55, RG142, RG223, RG400	<a href="#">PE44286</a>	\$150.51		59
		Solder/Solder	RG58	<a href="#">PE44287</a>	\$109.16		60
PE-1/4SFHC, SPP-250-LLPL, SPO-250, SPF-250			<a href="#">PE45662</a>	\$16.24	61		
SPP-250-LLPL			<a href="#">PE45423</a>	\$34.08	62		
SPP-250-LLPL	<a href="#">TC-SPP250-716F-LP</a>	\$14.78	63				

\* Fits MIL-C-17 and equivalent cable versions only

## 7/16 DIN Connectors

Connection Method	Product Image	Attachment Cable/Contact	Coax Type / Termination Type	Model No.	PRICE			ROW		
					1 Pc.	See Web for Volume Pricing				
<b>Female</b>										
Cable Connectors		Solder/Solder	SPP-375-LLPL, SPO-375, SPF-375	<a href="#">TC-SPP375-716F-LP</a>	\$14.78			64		
			TFT-402, TFT-402-LF	<a href="#">TC-402-716F-LP</a>	\$15.95			65		
<b>Female, Bulkhead Mount</b>										
Cable Connectors		Crimp/Solder	.195 inch, RG58, RG141, RG303, LMR-195, LMR-195-FR, PE-C195, PE-P195 with 1.161 inch DD Hole	<a href="#">PE44548</a>	\$109.22	See Web for Volume Pricing		66		
			.400 inch, LMR-400, LMR-400-DB, LMR-400-UF, PE-B405, PE-C400, PE-B400 with 1.161 inch DD Hole	<a href="#">PE44550</a>	\$94.66			67		
			PE-C240, RG8X, .240 inch, LMR-240, LMR-240-DB, LMR-240-UF, B7808A	<a href="#">PE44549</a>	\$82.51			68		
			PE-C600, LMR-600, LMR-600-DB, .600 inch with 1.161 inch DD Hole	<a href="#">PE44551</a>	\$113.17			69		
			RG55, RG142, RG223, RG400 with 1.161 inch DD Hole	<a href="#">PE44656</a>	\$81.45			70		
		Solder/Solder	PE-1/4SFHC, SPP-250-LLPL, SPO-250, SPF-250	<a href="#">PE45663</a>	\$28.34			71		
Terminal		Solder	Solder Cup	<a href="#">PE4572</a>	\$185.02			72		
<b>Female, 4 Hole Flange Mount</b>										
Cable Connectors		Clamp/Solder	RG14, RG217 with .975 inch Hole Spacing	<a href="#">PE44292</a>	\$199.28	See Web for Volume Pricing		73		
			RG214, RG213, RG393, RG8, RG225, RG215, RG9 with .975 inch Hole Spacing	<a href="#">PE44291</a>	\$192.54			74		
		Solder/Solder	TFT-402, TFT-402-LF	<a href="#">TC-402-716F-PM-LP</a>	\$17.05					75
Terminal		Field Replaceable	Slotted Contact	<a href="#">PE44717</a>	\$146.38					76
			Solder Cup with .975 inch Hole Spacing	<a href="#">PE4573</a>	\$102.08					77
		Solder	Stub	<a href="#">PE45000</a>	\$59.90					78
			Threaded Pin	Pin with .975 inch Hole Spacing	<a href="#">PE4574</a>	\$103.09			79	
		Pin with .975 inch Hole Spacing	<a href="#">PE4574A</a>	\$41.23			80			

## BMA Connectors

Connection Method	Product Image	Attachment Cable/Contact	Coax Type / Termination Type	Model No.	PRICE			ROW		
					1 Pc.	See Web for Volume Pricing				
<b>Plug</b>										
PCB Mount		Solder	Thru Hole	<a href="#">PE45336</a>	\$40.26			81		
			Thru Hole	<a href="#">PE45335</a>	\$63.48			82		
<b>Plug, Bulkhead Mount</b>										
Cable Connectors		Crimp/Solder	RG142, RG223, RG400, RG55	<a href="#">PE45318</a>	\$37.16	See Web for Volume Pricing		83		
			RG178, RG196	<a href="#">PE45315</a>	\$84.28			84		
			RG188-DS, RG316-DS	<a href="#">PE45317</a>	\$38.22			85		
			RG316, RG188, RG174, PE-C100, LMR-100A	<a href="#">PE45316</a>	\$51.94			86		
		Solder/Non-Solder Contact	RG402, PE-SR402AL, PE-SR402FL, PE-SR402FLJ, PE-SR402TN	<a href="#">PE45314</a>	\$26.25					87
			RG402, PE-SR402AL, PE-SR402FL, PE-SR402FLJ, PE-SR402TN	<a href="#">PE45313</a>	\$62.41					88
			RG405, PE-SR405AL, PE-SR405FL, PE-SR405FLJ, PE-SR405TN	<a href="#">PE45310</a>	\$46.78					89
			RG405, PE-SR405AL, PE-SR405FL, PE-SR405FLJ, PE-SR405TN	<a href="#">PE45311</a>	\$27.21					90
<b>Plug, 2 Hole Flange Mount</b>										
Field Replaceable		Field Replaceable	.012 inch Pin with .481 inch Hole Spacing	<a href="#">PE45345</a>	\$244.68			91		
			.020 inch Pin with .481 inch Hole Spacing	<a href="#">PE45346</a>	\$233.67			92		
			.036 inch Pin with .481 inch Hole Spacing	<a href="#">PE45348</a>	\$78.11			93		

\* Fits MIL-C-17 and equivalent cable versions only



Technical Support  
+1 (949) 261-1920















Same-Day Shipping,  
Even Custom  
Cable Assemblies

Connectors

See Our Website For Current Pricing & Real-Time Stock Availability!



# BMA Connectors



Connection Method	Product Image	Attachment Cable/Contact	Coax Type / Termination Type	Model No.	PRICE			ROW	
					1 Pc.	See Web for Volume Pricing			
<b>Plug, 2 Hole Flange Mount</b>									
Terminal		Solder	Stub with .481 inch Hole Spacing	<a href="#">PE45347</a>	\$70.95			94	
			Stub with .481 inch Hole Spacing	<a href="#">PE45341</a>	\$42.90			95	
			Stub with .481 inch Hole Spacing	<a href="#">PE45342</a>	\$38.71			96	
			Stub with .481 inch Hole Spacing	<a href="#">PE45343</a>	\$12.88			97	
			Stub with .481 inch Hole Spacing	<a href="#">PE45344</a>	\$21.82			98	
<b>Plug, 4 Hole Flange Mount</b>									
Terminal		Solder	Stub with .340 inch Hole Spacing	<a href="#">PE45339</a>	\$39.30		See Web for Volume Pricing	99	
<b>Plug, Thread-In</b>									
Terminal		None	Pin	<a href="#">PE45350</a>	\$113.33			1	
			Pin	<a href="#">PE45351</a>	\$69.33			2	
			Pin	<a href="#">PE45352</a>	\$129.45			3	
			Pin	<a href="#">PE45353</a>	\$142.48			4	
<b>Plug Right Angle</b>									
PCB Mount		Solder	Surface Mount	<a href="#">PE45333</a>	\$144.82			5	
			Thru Hole	<a href="#">PE45355</a>	\$41.86			6	
<b>Jack</b>									
Cable Connectors		Crimp/Solder	RG142, RG223, RG400, RG55	<a href="#">PE45320</a>	\$110.17			7	
			RG316, RG188, RG174, PE-C100, LMR-100A	<a href="#">PE45319</a>	\$84.41			8	
		Solder/Non-Solder Contact	RG402, PE-SR402AL, PE-SR402FL, PE-SR402FLJ, PE-SR402TN	<a href="#">PE45328</a>	\$82.13			9	
			Solder/Solder	RG405, PE-SR405AL, PE-SR405FL, PE-SR405FLJ	<a href="#">PE45324</a>	\$74.91	See Web for Volume Pricing		10
RG405, PE-SR405AL, PE-SR405FL, PE-SR405FLJ	<a href="#">PE45325</a>	\$106.56		11					
PCB Mount		Solder	Surface Mount	<a href="#">PE45338</a>	\$61.46				12
			Thru Hole	<a href="#">PE45337</a>	\$54.93				13
Terminal		Solder	Stub	<a href="#">PE45349</a>	\$197.46			14	
<b>Jack, Bulkhead Mount</b>									
Cable Connectors		Solder/Solder	RG405, PE-SR405AL, PE-SR405FL, PE-SR405FLJ	<a href="#">PE45323</a>	\$48.60			15	
<b>Jack, 2 Hole Flange Mount</b>									
Cable Connectors		Crimp/Solder	RG316, RG188, RG174, LMR-100A, PE-C100-LSZH	<a href="#">PE45321</a>	\$54.89			16	
			Solder/Non-Solder Contact	RG405, PE-SR405AL, PE-SR405FL, PE-SR405FLJ	<a href="#">PE45322</a>	\$57.50	See Web for Volume Pricing		17
	Solder/Solder	RG402, PE-SR402AL, PE-SR402FL, PE-SR402FLJ, PE-SR402TN		<a href="#">PE45326</a>	\$62.34	18			
		RG402, PE-SR402AL, PE-SR402FL, PE-SR402FLJ, PE-SR402TN	<a href="#">PE45327</a>	\$39.76	19				
Terminal		Solder	Stub	<a href="#">PE45340</a>	\$63.58				20
<b>Jack, 4 Hole Flange Mount</b>									
Terminal		Solder	Stub with .340 inch Hole Spacing	<a href="#">PE45334</a>	\$62.69			21	

\* Fits MIL-C-17 and equivalent cable versions only





Connectors

See Our Website For Current Pricing & Real-Time Stock Availability!

## BMA Connectors

Connection Method	Product Image	Attachment Cable/Contact	Coax Type / Termination Type	Model No.	PRICE				ROW
					1-24	25-49	50-99	100 +	
<b>Jack, Thread-In</b>									
Terminal		None	Pin	<a href="#">PE45354</a>	\$65.64	\$62.36	\$59.08	\$56.45	22
<b>Jack Right Angle, 2 Hole Flange Mount</b>									
Cable Connectors		Crimp/Solder	RG142, RG223, RG400, RG55	<a href="#">PE45332</a>	\$61.15	\$58.09	\$55.04	\$52.59	23
		Solder/Solder	RG402, PE-SR402AL, PE-SR402FL, PE-SR402FLJ, PE-SR402TN	<a href="#">PE45329</a>	\$73.68	\$70.00	\$66.31	\$63.36	24
			RG405, PE-SR405AL, PE-SR405FL, PE-SR405FLJ	<a href="#">PE45330</a>	\$80.24	\$76.23	\$72.22	\$69.01	25
			RG405, PE-SR405AL, PE-SR405FL, PE-SR405FLJ	<a href="#">PE45331</a>	\$67.56	\$64.18	\$60.80	\$58.10	26

## BNC Connectors

Connection Method	Product Image	Attachment Cable/Contact	Coax Type / Termination Type	Model No.	PRICE				ROW
					1-24	25-49	50-99	100 +	
<b>Male</b>									
Cable Connectors		Clamp/Solder	LMR-240, PE-C240	<a href="#">TC-240-BMC</a>	\$19.79	\$19.79	\$19.79	\$19.79	27
			PE-B150, RG180, RG195	<a href="#">PE4383</a>	\$42.80	\$40.66	\$38.52	\$36.81	28
			PE-B400, PE-B405, PE-C400, LMR-400, .400 inch	<a href="#">PE4386</a>	\$31.40	\$29.83	\$28.26	\$27.00	29
			PE-C200	<a href="#">PE44040</a>	\$18.17	\$17.26	\$16.35	\$15.63	30
			PE-C300	<a href="#">PE44042</a>	\$16.67	\$15.84	\$15.00	\$14.34	31
			PE-SR401AL, PE-SR401FL, RG401	<a href="#">PE4380</a>	\$25.55	\$24.27	\$23.00	\$21.97	32
			PE-SR402AL, PE-SR402FL, RG402	<a href="#">PE4206</a>	\$23.40	\$22.23	\$21.06	\$20.12	33
			PE-SR405AL, PE-SR405FL, RG405	<a href="#">PE4207</a>	\$26.41	\$25.09	\$23.77	\$22.71	34
			RG174, RG316, RG188, .100 inch, PE-B100, PE-C100, LMR-100	<a href="#">PE4084</a>	\$16.84	\$16.00	\$15.16	\$14.48	35
			RG178, RG196	<a href="#">PE4384</a>	\$18.97	\$18.02	\$17.07	\$16.31	36
			RG58, RG55, RG141, RG142, RG223, RG400, RG303, PE-C195, PE-P195, LMR-195	<a href="#">PE4023</a>	\$10.08	\$9.68	\$9.37	\$9.17	37
			RG59*, RG62*, RG71	<a href="#">PE4024</a>	\$11.88	\$11.29	\$10.69	\$10.22	38
			RG6	<a href="#">PE4377</a>	\$19.47	\$18.50	\$17.52	\$16.74	39
			RG8, RG215, RG225, RG214, RG393, RG213	<a href="#">PE4109</a>	\$21.81	\$20.72	\$19.63	\$18.76	40
			RG8X, PE-C240, .240 inch, B7808A, LMR-240	<a href="#">PE4379</a>	\$21.16	\$20.10	\$19.04	\$18.20	41
		Crimp/Crimp	.100 inch, RG316, RG174, RG188, LMR-100, LMR-100, LMR-100-FR, PE-C100, PE-B100	<a href="#">PE45045</a>	\$8.58	\$8.15	\$7.72	\$7.38	42
			RG316-DS, RG188-DS	<a href="#">PE45114</a>	\$9.48	\$9.01	\$8.53	\$8.15	43
			RG59*, RG62*, RG71	<a href="#">PE4018</a>	\$10.93	\$10.38	\$9.84	\$9.40	44
		Crimp/Non-Solder Contact	LMR-400, PE-C400, LMR-400-DB	<a href="#">EZ-400-BM-X</a>	\$16.63	\$16.63	\$16.63	\$16.63	45
			<b>Female</b>						
		Crimp/Solder	LMR-200, PE-C200	<a href="#">TC-200-BM-X</a>	\$14.69	\$14.69	\$14.69	\$14.69	46
			LMR-240, PE-C240	<a href="#">TC-240-BM-X</a>	\$12.32	\$12.32	\$12.32	\$12.32	47
			LMR-400, PE-C400	<a href="#">TC-400-BM-X</a>	\$14.78	\$14.78	\$14.78	\$14.78	48
			PE-B150, RG180, RG195	<a href="#">PE4247</a>	\$15.66	\$14.88	\$14.09	\$13.47	49
			PE-B305	<a href="#">PE4210</a>	\$15.04	\$14.29	\$13.54	\$12.93	50
			PE-C240, RG8X, .240 inch, LMR-240, LMR-240-DB, LMR-240-UF, B7808A	<a href="#">PE44640</a>	\$17.72	\$16.83	\$15.95	\$15.24	51
			PE-C400, LMR-400	<a href="#">PE44294</a>	\$34.38	\$32.66	\$30.94	\$29.57	52
			RG178, RG196	<a href="#">PE4643</a>	\$27.69	\$26.31	\$24.92	\$23.81	53
			RG213, RG215, RG8	<a href="#">PE4378</a>	\$28.12	\$26.71	\$25.31	\$24.18	54
			RG214, RG9, RG225, RG393	<a href="#">PE4351</a>	\$25.96	\$24.66	\$23.36	\$22.33	55
			RG55, RG141, RG142, RG223, RG400	<a href="#">PE4044</a>	\$8.50	\$8.08	\$7.65	\$7.31	56
			RG58, RG303, RG141, PE-C195, PE-P195, LMR-195, .195 inch	<a href="#">PE4016</a>	\$7.79	\$7.40	\$7.01	\$6.70	57
			RG58 Plenum, RG122, RG58-P	<a href="#">PE4381</a>	\$28.67	\$27.24	\$25.80	\$24.66	58
RG59* Plenum, RG59*-P, RG302			<a href="#">PE4382</a>	\$20.81	\$19.77	\$18.73	\$17.90	59	
PE-047SR, PE-SR047AL, PE-SR047FL			<a href="#">PE4974</a>	\$43.25	\$41.09	\$38.93	\$37.20	60	
PE-SR401AL, PE-SR401FL, RG401			<a href="#">PE4908</a>	\$54.43	\$51.71	\$48.99	\$46.81	61	
PE-SR402AL, PE-SR402FL, PE-SR402FLJ, PE-SR402TN, RG402			<a href="#">PE4650</a>	\$12.65	\$12.02	\$11.39	\$10.88	62	
			Solder/Solder	PE-SR405AL, PE-SR405FL, RG405	<a href="#">PE4651</a>	\$28.93	\$27.48	\$26.04	\$24.88

Connectors

See Our Website For Current Pricing & Real-Time Stock Availability!

\* Fits MIL-C-17 and equivalent cable versions only

















Technical Support  
+1 (949) 261-1920



Same-Day Shipping,  
Even Custom  
Cable Assemblies

# BNC Connectors











Connection Method	Product Image	Attachment Cable/Contact	Coax Type / Termination Type	Model No.	PRICE				ROW
					1-24	25-49	50-99	100 +	
<b>Male, Bulkhead Mount</b>									
Terminal		Solder	Solder Cup with .350 inch D Hole	<a href="#">PE4211</a>	\$18.33	\$17.41	\$16.50	\$15.76	64
<b>Male, 4 Hole Flange Mount</b>									
Terminal		Solder	Solder Cup with .531 inch Hole Spacing	<a href="#">PE4082</a>	\$20.08	\$19.08	\$18.07	\$17.27	65
<b>Male Right Angle</b>									
Cable Connectors		Clamp/Solder	RG174, RG316, RG188, .100 inch, PE-B100, PE-C100, LMR-100	<a href="#">PE4307</a>	\$54.29	\$51.58	\$48.86	\$46.69	66
			RG178, RG196	<a href="#">PE4388</a>	\$26.85	\$25.51	\$24.17	\$23.09	67
			RG213, RG214, RG8, RG9, RG11*, RG225, RG393, RG144*, RG216*, RG215	<a href="#">PE4387</a>	\$41.75	\$39.66	\$37.58	\$35.91	68
			RG58, RG55, RG141, RG142, RG223, RG400, RG303, PE-C195, PE-P195, LMR-195	<a href="#">PE4053</a>	\$21.52	\$20.44	\$19.37	\$18.51	69
			RG59*, RG62*	<a href="#">PE4320</a>	\$27.59	\$26.21	\$24.83	\$23.73	70
		Crimp/Crimp	RG58, RG303, RG141, PE-C195, PE-P195, LMR-195, .195 inch	<a href="#">PE4298</a>	\$27.41	\$26.04	\$24.67	\$23.57	71
		Crimp/Solder	PE-C200, LMR-200	<a href="#">PE44843</a>	\$22.25	\$21.14	\$20.03	\$19.14	72
			PE-C240, RG8X, .240 inch, LMR-240, LMR-240-DB, LMR-240-UF, B7808A	<a href="#">PE44641</a>	\$28.62	\$27.19	\$25.76	\$24.61	73
			RG174, RG316, RG188, .100 inch, PE-B100, PE-C100, LMR-100	<a href="#">PE4393</a>	\$25.90	\$24.61	\$23.31	\$22.27	74
			RG188-DS, RG316-DS	<a href="#">PE4396</a>	\$32.66	\$31.03	\$29.39	\$28.09	75
	Solder/Solder	RG55, RG141, RG142, RG223, RG400	<a href="#">PE4345</a>	\$12.63	\$12.00	\$11.37	\$10.86	76	
		RG59*, RG62*, RG71	<a href="#">PE4195</a>	\$28.72	\$27.28	\$25.85	\$24.70	77	
		PE-SR402AL, PE-SR402FL, PE-SR402FLJ, PE-SR402TN, RG402	<a href="#">PE4092</a>	\$41.81	\$39.72	\$37.63	\$35.96	78	
		Solder/Solder	PE-SR405AL, PE-SR405FL, RG405	<a href="#">PE45239</a>	\$43.55	\$41.37	\$39.20	\$37.45	79
<b>Female</b>									
Cable Connectors		Clamp/Solder	PE-SR401AL, PE-SR401FL, RG401	<a href="#">PE44674</a>	\$33.71	\$32.02	\$30.34	\$28.99	80
			PE-SR402AL, PE-SR402FL, RG402	<a href="#">PE4204</a>	\$31.44	\$29.87	\$28.30	\$27.04	81
			PE-SR405AL, PE-SR405FL, RG405	<a href="#">PE4205</a>	\$32.66	\$31.03	\$29.39	\$28.09	82
			RG174, RG316, RG188	<a href="#">PE4321</a>	\$16.02	\$15.22	\$14.42	\$13.78	83
			RG178, RG196	<a href="#">PE4389</a>	\$21.49	\$20.42	\$19.34	\$18.48	84
		Crimp/Solder	RG213, RG214, RG8, RG9, RG11*, RG225, RG393, RG144*, RG216*, RG215	<a href="#">PE4212</a>	\$50.69	\$48.16	\$45.62	\$43.59	85
			RG58, RG55, RG141, RG142, RG223, RG400, RG303, PE-C195, PE-P195, LMR-195	<a href="#">PE4058</a>	\$13.25	\$12.59	\$11.93	\$11.40	86
			RG59*, RG62*, RG71	<a href="#">PE4057</a>	\$11.51	\$10.93	\$10.36	\$9.90	87
			PE-C195, PE-P195, RG58, RG141, RG303, LMR-195, .195 inch	<a href="#">PE4070</a>	\$10.68	\$10.15	\$9.61	\$9.18	88
			PE-C240, RG8X, .240 inch, LMR-240, LMR-240-DB, LMR-240-UF, B7808A	<a href="#">PE44642</a>	\$9.11	\$8.65	\$8.20	\$7.83	89
	Crimp/Solder	RG174, RG316, RG188, LMR-100, PE-B100, PE-C100, .100 inch	<a href="#">PE4079</a>	\$13.88	\$13.19	\$12.49	\$11.94	90	
		RG174, RG316, RG188, LMR-100, PE-B100, PE-C100, .100 inch	<a href="#">PE45395</a>	\$15.94	\$14.82	\$13.71	\$12.75	91	
		RG55, RG141, RG142, RG223, RG400	<a href="#">PE4397</a>	\$12.41	\$11.79	\$11.17	\$10.67	92	
		Solder/Solder	RG59*, RG62*, RG71	<a href="#">PE4308</a>	\$10.34	\$9.82	\$9.31	\$8.89	93
		Solder/Solder	PE-SR401FL, PE-SR401AL, RG401	<a href="#">PE45150</a>	\$33.99	\$32.29	\$30.59	\$29.23	94
PCB Mount		Solder	End Launch	<a href="#">PE44616</a>	\$15.43	\$14.66	\$13.89	\$13.27	95
<b>Female, Bulkhead Mount</b>									
Cable Connectors		Clamp/Solder	PE-SR402AL, PE-SR402FL, RG402	<a href="#">PE4915</a>	\$38.12	\$36.21	\$34.31	\$32.78	96
			PE-SR405AL, PE-SR405FL, RG405	<a href="#">PE4916</a>	\$35.29	\$33.53	\$31.76	\$30.35	97
			RG174, RG316, RG188 with .480 inch D Hole	<a href="#">PE4319</a>	\$19.75	\$18.76	\$17.78	\$16.99	98
			RG178, RG196 with .480 inch D Hole	<a href="#">PE4391</a>	\$23.78	\$22.59	\$21.40	\$20.45	99
			RG214, RG213, RG393, RG8, RG225, RG11*, RG216*, RG144*, RG215, RG9 with .480 inch D Hole	<a href="#">PE4632</a>	\$54.77	\$52.03	\$49.29	\$47.10	1
			RG316-DS, RG188-DS	<a href="#">PE44886</a>	\$33.96	\$32.26	\$30.56	\$29.21	2

\* Fits MIL-C-17 and equivalent cable versions only

Connectors

See Our Website For Current Pricing & Real-Time Stock Availability!

## BNC Connectors

Connection Method	Product Image	Attachment Cable/Contact	Coax Type / Termination Type	Model No.	PRICE				ROW
					1-24	25-49	50-99	100 +	
<b>Female, Bulkhead Mount</b>									
Cable Connectors		Clamp/Solder	RG58, RG142, RG223, RG400, RG141, RG303, RG55, LMR-195, PE-C195, PE-P195 with .480 inch D Hole	<a href="#">PE4078</a>	\$22.94	\$21.79	\$20.65	\$19.73	3
		Crimp/Crimp	RG58, PE-C195, PE-P195, LMR-195	<a href="#">PE45064</a>	\$17.01	\$16.16	\$15.31	\$14.63	4
		Crimp/Solder	RG174, RG316, RG188, LMR-100, PE-B100, PE-C100, .100 inch with .480 inch D Hole	<a href="#">PE4106</a>	\$17.94	\$17.04	\$16.15	\$15.43	5
			RG178, RG196 with .480 inch D Hole	<a href="#">PE44658</a>	\$24.52	\$23.29	\$22.07	\$21.09	6
			RG188-DS, RG316-DS with .480 inch D Hole	<a href="#">PE4392</a>	\$21.89	\$20.80	\$19.70	\$18.83	7
			RG316, RG174, LMR-100	<a href="#">PE45131</a>	\$35.69	\$33.91	\$32.12	\$30.69	8
			RG55, RG142, RG223, RG400, RG141 with .480 inch D Hole	<a href="#">PE4209</a>	\$22.84	\$21.70	\$20.56	\$19.64	9
			RG58 with .480 inch D Hole	<a href="#">PE4208</a>	\$15.71	\$14.92	\$14.14	\$13.51	10
PCB Mount		Solder	End Launch with .500 inch Diameter	<a href="#">PE44618</a>	\$22.81	\$21.67	\$20.53	\$19.62	12
			Terminal		Eyelet	<a href="#">PE44890</a>	\$30.46	\$28.94	\$27.41
Eyelet	<a href="#">PE44891</a>	\$100.93	\$95.88		\$90.84	\$86.80	14		
Solder Cup with .350 inch D Hole	<a href="#">PE4015</a>	\$10.11	\$9.60		\$9.10	\$8.69	15		
Solder Cup with .350 inch D Hole	<a href="#">PE4091</a>	\$10.82	\$10.28		\$9.74	\$9.31	16		
Solder Cup with .410 inch D Hole	<a href="#">PE4014</a>	\$8.84	\$8.40		\$7.96	\$7.60	17		
Solder Cup with .480 inch D Hole	<a href="#">PE4318</a>	\$22.32	\$21.20		\$20.09	\$19.20	18		
Spade with .350 inch D Hole	<a href="#">PE4077</a>	\$27.56	\$26.18		\$24.80	\$23.70	19		
Turret with .480 inch D Hole	<a href="#">PE4049</a>	\$21.16	\$20.10	\$19.04	\$18.20	20			
<b>Female, 4 Hole Flange Mount</b>									
Cable Connectors		Clamp/Solder	RG316-DS, RG188-DS	<a href="#">PE44887</a>	\$42.81	\$40.67	\$38.53	\$36.82	21
			RG58, RG142, RG223, RG400, RG141, RG303, RG55, LMR-195, PE-C195, PE-P195 with .500 inch Threaded Hole Spacing	<a href="#">PE4056</a>	\$20.50	\$19.48	\$18.45	\$17.63	22
		Solder/Solder	PE-047SR, PE-SR047FL, PE-SR047AL	<a href="#">PE44888</a>	\$44.80	\$42.56	\$40.32	\$38.53	23
Terminal		Field Replaceable	Slotted Contact	<a href="#">PE44720</a>	\$58.28	\$55.37	\$52.45	\$50.12	24
			Solder	Solder Cup with .500 inch Threaded Hole Spacing	<a href="#">PE4010</a>	\$11.17	\$10.61	\$10.05	\$9.61
	Solder Cup with .500 inch Hole Spacing	<a href="#">PE4394</a>		\$15.92	\$15.12	\$14.33	\$13.69	26	
	Solder Cup with .718 inch Hole Spacing	<a href="#">PE4395</a>		\$27.66	\$26.28	\$24.89	\$23.79	27	
Turret with .531 inch Hole Spacing	<a href="#">PE4011</a>	\$23.02	\$21.87	\$20.72	\$19.80	28			
<b>Female Right Angle, Bulkhead Mount</b>									
Terminal		Solder	Solder Cup with .361 inch D Hole	<a href="#">PE4055</a>	\$30.55	\$29.02	\$27.50	\$26.27	29
<b>Female Right Angle, 4 Hole Flange Mount</b>									
Terminal		Solder	Solder Cup with .531 inch Hole Spacing	<a href="#">PE4317</a>	\$36.08	\$34.28	\$32.47	\$31.03	30

## Reverse Polarity BNC Connectors

Connection Method	Product Image	Attachment Cable/Contact	Coax Type / Termination Type	Model No.	PRICE				ROW
					1-24	25-49	50-99	100 +	
<b>Male</b>									
Cable Connectors		Clamp/Solder	PE-SR402AL, PE-SR402FL, RG402	<a href="#">PE4722</a>	\$26.24	\$24.93	\$23.62	\$22.57	31
			RG174, RG316, RG188, LMR-100, PE-B100, PE-C100, .100 inch	<a href="#">PE4719</a>	\$40.63	\$38.60	\$36.57	\$34.94	32
			RG178, RG196	<a href="#">PE4721</a>	\$29.76	\$28.27	\$26.78	\$25.59	33
			RG213, RG214, RG8, RG9, RG225, RG393, RG215	<a href="#">PE4711</a>	\$40.63	\$38.60	\$36.57	\$34.94	34
			RG58, RG55, RG141, RG142, RG223, RG400, RG303, PE-C195, PE-P195, LMR-195	<a href="#">PE4714</a>	\$40.26	\$38.25	\$36.23	\$34.62	35

\* Fits MIL-C-17 and equivalent cable versions only



Technical Support  
+1 (949) 261-1920



Same-Day Shipping,  
Even Custom  
Cable Assemblies

Connectors

See Our Website For Current Pricing & Real-Time Stock Availability!



# Reverse Polarity BNC Connectors











Connection Method	Product Image	Attachment Cable/Contact	Coax Type / Termination Type	Model No.	PRICE				ROW
					1-24	25-49	50-99	100 +	
<b>Male</b>									
Cable Connectors		Clamp/Solder	RG59*, RG62*	<a href="#">PE4717</a>	\$16.79	\$15.95	\$15.11	\$14.44	36
			RG174, RG316, RG188, LMR-100, PE-B100, PE-C100, .100 inch	<a href="#">PE4720</a>	\$27.37	\$26.00	\$24.63	\$23.54	37
		Crimp/Solder	RG213, RG8	<a href="#">PE4712</a>	\$32.61	\$30.98	\$29.35	\$28.04	38
			RG214, RG9, RG225, RG393	<a href="#">PE4713</a>	\$34.83	\$33.09	\$31.35	\$29.95	39
			RG55, RG141, RG142, RG223, RG400	<a href="#">PE4715</a>	\$16.68	\$15.85	\$15.01	\$14.34	40
			RG58, RG303, RG141, PE-C195, PE-P195, LMR-195, .195 inch	<a href="#">PE4716</a>	\$19.96	\$18.96	\$17.96	\$17.17	41
			RG59*, RG62*	<a href="#">PE4718</a>	\$18.92	\$17.97	\$17.03	\$16.27	42
<b>Male, 4 Hole Flange Mount</b>									
Terminal		Solder	Solder Cup with .531 inch Hole Spacing	<a href="#">PE4762</a>	\$27.55	\$26.17	\$24.80	\$23.69	43
<b>Male Right Angle</b>									
Cable Connectors		Clamp/Solder	RG174, RG316, RG188	<a href="#">PE4732</a>	\$28.11	\$26.70	\$25.30	\$24.17	44
			RG213, RG214, RG8, RG9, RG225, RG393, RG215	<a href="#">PE4727</a>	\$50.34	\$47.82	\$45.31	\$43.29	45
			RG58, RG55, RG141, RG142, RG223, RG400, RG303, PE-C195, PE-P195, LMR-195	<a href="#">PE4728</a>	\$27.96	\$26.56	\$25.16	\$24.05	46
		Crimp/Solder	RG174, RG316, RG188	<a href="#">PE4733</a>	\$27.30	\$25.94	\$24.57	\$23.48	47
			RG55, RG141, RG142, RG223, RG400	<a href="#">PE4729</a>	\$27.80	\$26.41	\$25.02	\$23.91	48
			RG58, RG303, RG141, PE-C195, PE-P195, LMR-195, .195 inch	<a href="#">PE4730</a>	\$33.23	\$31.57	\$29.91	\$28.58	49
			<b>Female</b>						
Cable Connectors		Clamp/Solder	PE-SR402AL, PE-SR402FL, RG402	<a href="#">PE4744</a>	\$26.73	\$25.39	\$24.06	\$22.99	50
			PE-SR405AL, PE-SR405FL, RG405	<a href="#">PE4745</a>	\$27.02	\$25.67	\$24.32	\$23.24	51
			RG174, RG316, RG188	<a href="#">PE4741</a>	\$33.74	\$32.05	\$30.37	\$29.02	52
			RG178, RG196	<a href="#">PE4743</a>	\$33.74	\$32.05	\$30.37	\$29.02	53
			RG213, RG214, RG8, RG9, RG225, RG393	<a href="#">PE4735</a>	\$41.90	\$39.81	\$37.71	\$36.03	54
			RG55, RG58, RG141, RG142, RG223, RG400	<a href="#">PE4736</a>	\$40.63	\$38.60	\$36.57	\$34.94	55
		Crimp/Solder	RG174, RG316, RG188	<a href="#">PE4742</a>	\$28.72	\$27.28	\$25.85	\$24.70	56
			RG188-DS, RG316-DS	<a href="#">PE45182</a>	\$25.35	\$24.08	\$22.82	\$21.80	57
			RG55, RG141, RG142, RG223, RG400	<a href="#">PE4737</a>	\$25.45	\$24.18	\$22.91	\$21.89	58
			RG58	<a href="#">PE4738</a>	\$29.27	\$27.81	\$26.34	\$25.17	59
RG59*, RG62*	<a href="#">PE4739</a>	\$27.83	\$26.44	\$25.05	\$23.93	60			
<b>Female, Bulkhead Mount</b>									
Cable Connectors		Clamp/Solder	PE-SR405AL, PE-SR405FL, RG405 with .480 inch D Hole	<a href="#">PE4755</a>	\$28.11	\$26.70	\$25.30	\$24.17	61
			RG174, RG316, RG188 with .480 inch D Hole	<a href="#">PE4751</a>	\$25.75	\$24.46	\$23.18	\$22.15	62
			RG55, RG58, RG141, RG142, RG223, RG400 with .480 inch D Hole	<a href="#">PE4746</a>	\$42.58	\$40.45	\$38.32	\$36.62	63
			RG59*, RG62* with .480 inch D Hole	<a href="#">PE4749</a>	\$38.08	\$36.18	\$34.27	\$32.75	64
		Crimp/Solder	.100 inch, RG316, RG174, RG188, LMR-100, LMR-100A, LMR-100A-FR, PE-C100, PE-B100 with .480 inch D Hole	<a href="#">PE4752</a>	\$30.76	\$29.22	\$27.68	\$26.45	65
			RG55, RG142, RG223, RG400 with .480 inch D Hole	<a href="#">PE4747</a>	\$28.11	\$26.70	\$25.30	\$24.17	66
			RG58, RG141 with .480 inch D Hole	<a href="#">PE4748</a>	\$29.60	\$28.12	\$26.64	\$25.46	67
Terminal		Solder	Solder Cup with .350 inch D Hole	<a href="#">PE4758</a>	\$16.87	\$16.03	\$15.18	\$14.51	68
			Solder Cup with .410 inch D Hole	<a href="#">PE4757</a>	\$18.38	\$17.46	\$16.54	\$15.81	69
			Solder Cup with .480 inch D Hole	<a href="#">PE4764</a>	\$26.69	\$25.36	\$24.02	\$22.95	70
<b>Female, 4 Hole Flange Mount</b>									
Terminal		Solder	Solder Cup with .500 inch Threaded Hole Spacing	<a href="#">PE4756</a>	\$28.14	\$26.73	\$25.33	\$24.20	71
			Solder Cup with .500 inch Hole Spacing	<a href="#">PE4763</a>	\$28.15	\$26.74	\$25.34	\$24.21	72
<b>Female Right Angle, Bulkhead Mount</b>									
Terminal		Solder	Solder Cup with .361 inch D Hole	<a href="#">PE4759</a>	\$49.36	\$46.89	\$44.42	\$42.45	73

\* Fits MIL-C-17 and equivalent cable versions only

Connectors

See Our Website For Current Pricing & Real-Time Stock Availability!

# C Connectors

Connection Method	Product Image	Attachment Cable/Contact	Coax Type / Termination Type	Model No.	PRICE				ROW
					1-24	25-49	50-99	100 +	
<b>Male</b>									
Cable Connectors		Clamp/Solder	RG14, RG217	<a href="#">PE4951</a>	\$67.73	\$64.34	\$60.96	\$58.25	74
			RG174, RG316, RG188	<a href="#">PE4953</a>	\$39.63	\$37.65	\$35.67	\$34.08	75
			RG213, RG214, RG8, RG9, RG11*, RG225, RG393, RG144*, RG216*, RG215	<a href="#">PE4950</a>	\$53.96	\$51.26	\$48.56	\$46.41	76
			RG213, RG214, RG8, RG9, RG11*, RG225, RG393, RG144*, RG216*, RG215	<a href="#">PE4243</a>	\$69.37	\$65.90	\$62.43	\$59.66	77
			RG218	<a href="#">PE4954</a>	\$98.88	\$93.94	\$88.99	\$85.04	78
			RG55, RG58, RG141, RG142, RG223, RG303, RG400, PE-C195, PE-P195, LMR-195	<a href="#">PE4242</a>	\$54.44	\$51.72	\$49.00	\$46.82	79
	RG59*, RG62*, RG71	<a href="#">PE4952</a>	\$54.60	\$52.42	\$50.78	\$49.69	80		
		Crimp/Solder	RG213, RG8	<a href="#">PE4518</a>	\$39.63	\$37.65	\$35.67	\$34.08	81
			RG214, RG9, RG225, RG393	<a href="#">PE4375</a>	\$30.20	\$28.69	\$27.18	\$25.97	82
			RG55, RG141, RG142, RG223, RG400	<a href="#">PE4445</a>	\$31.53	\$29.95	\$28.38	\$27.12	83
RG58, RG303, RG141, PE-C195, PE-P195, LMR-195, .195 inch			<a href="#">PE4517</a>	\$41.97	\$39.87	\$37.77	\$36.09	84	
<b>Male, 4 Hole Flange Mount</b>									
Terminal		Solder	Solder Cup with .718 inch Hole Spacing	<a href="#">PE44096</a>	\$76.85	\$73.01	\$69.17	\$66.09	85
<b>Male Right Angle</b>									
Cable Connectors		Clamp/Solder	RG213, RG214, RG8, RG9, RG11*, RG225, RG393, RG144*, RG216*, RG215	<a href="#">PE4244</a>	\$74.03	\$70.33	\$66.63	\$63.67	86
			RG55, RG58, RG141, RG142, RG223, RG303, RG400, PE-C195, PE-P195, LMR-195	<a href="#">PE4957</a>	\$99.28	\$94.32	\$89.35	\$85.38	87
		Crimp/Solder	PE-P195, PE-C195, RG58, RG141, RG303, .195 inch, LMR-195	<a href="#">PE4959</a>	\$96.57	\$91.74	\$86.91	\$83.05	88
			RG213, RG8	<a href="#">PE4955</a>	\$79.50	\$75.53	\$71.55	\$68.37	89
			RG214, RG9, RG225, RG393	<a href="#">PE4949</a>	\$92.66	\$88.03	\$83.39	\$79.69	90
RG55, RG141, RG142, RG223, RG400	<a href="#">PE4958</a>	\$75.96	\$72.16	\$68.36	\$65.33	91			
<b>Female</b>									
Cable Connectors		Clamp/Solder	RG14, RG217	<a href="#">PE4963</a>	\$76.23	\$72.42	\$68.61	\$65.56	92
			RG213, RG214, RG8, RG9, RG11*, RG225, RG393, RG144*, RG216*, RG215	<a href="#">PE4960</a>	\$61.41	\$58.34	\$55.27	\$52.81	93
			RG55, RG58, RG141, RG142, RG223, RG303, RG400, PE-C195, PE-P195, LMR-195	<a href="#">PE4961</a>	\$82.35	\$78.23	\$74.12	\$70.82	94
<b>Female, Bulkhead Mount</b>									
Cable Connectors		Clamp/Solder	RG214, RG213, RG393, RG8, RG225, RG11*, RG216*, RG144*, RG215, RG9 with .720 inch D Hole	<a href="#">PE4964</a>	\$73.81	\$70.12	\$66.43	\$63.48	95
			RG58, RG142, RG223, RG400, RG141, RG303, RG55, LMR-400, PE-C195, PE-P195 with .596 inch D Hole	<a href="#">PE44099</a>	\$77.76	\$73.87	\$69.98	\$66.87	96
			RG58, RG55, RG141, RG142, RG223, RG400 with .720 inch D Hole	<a href="#">PE4965</a>	\$87.02	\$82.67	\$78.32	\$74.84	97
			RG59*, RG62* with .596 inch D Hole	<a href="#">PE44098</a>	\$35.03	\$33.28	\$31.53	\$30.13	98
Terminal		Solder	Solder Cup with .720 inch D Hole	<a href="#">PE4240</a>	\$59.33	\$56.96	\$55.18	\$53.99	99
			Solder Cup with .720 inch D Hole	<a href="#">PE4971</a>	\$83.12	\$78.96	\$74.81	\$71.48	1
			Solder Cup with .720 inch D Hole	<a href="#">PE4972</a>	\$83.12	\$78.96	\$74.81	\$71.48	2
			Turret with .350 inch D Hole	<a href="#">PE4973</a>	\$87.31	\$82.94	\$78.58	\$75.09	3
<b>Female, 4 Hole Flange Mount</b>									
Cable Connectors		Clamp/Solder	RG213, RG214, RG393, RG11*	<a href="#">PE4CO1013</a>	\$80.32	\$76.30	\$72.29	\$69.08	4
			RG214, RG213, RG393, RG8, RG225, RG11*, RG216*, RG144*, RG215, RG9 with .718 inch Hole Spacing	<a href="#">PE4967</a>	\$88.13	\$83.72	\$79.32	\$75.79	5
			RG58, RG142, RG223, RG400, RG141, RG303, RG55, LMR-400, PE-C195, PE-P195 with .718 inch Hole Spacing	<a href="#">PE4969</a>	\$64.24	\$61.03	\$57.82	\$55.25	6
Cable Connectors		Crimp/Solder	RG214, RG9, RG225, RG393 with .718 inch Hole Spacing	<a href="#">PE4374</a>	\$74.05	\$70.35	\$66.65	\$63.68	7
			Terminal		Solder	Solder Cup with .718 inch Hole Spacing	<a href="#">PE4241</a>	\$27.58	\$26.20

Connectors

See Our Website For Current Pricing & Real-Time Stock Availability!

\* Fits MIL-C-17 and equivalent cable versions only









Technical Support  
+1 (949) 261-1920



Same-Day Shipping,  
Even Custom  
Cable Assemblies



### D-Sub Connectors

Connection Method	Product Image	Attachment Cable/Contact	Coax Type / Termination Type	Model No.	PRICE				ROW
					1-24	25-49	50-99	100 +	
<b>Receptacle</b>									
Cable Connectors		Crimp/Solder	PE-C195, PE-P195, RG58, RG141, RG303, LMR-195, .195 inch	<a href="#">PE4800</a>	\$17.68	\$16.80	\$15.91	\$15.20	9
			RG174, RG316, RG188, .100 inch, PE-B100, PE-C100, LMR-100	<a href="#">PE4801</a>	\$19.45	\$18.48	\$17.51	\$16.73	10
		Solder/Solder	RG180, RG195	<a href="#">PE4807</a>	\$9.62	\$9.14	\$8.66	\$8.27	11
			RG55, RG142, RG223, RG400	<a href="#">PE4838</a>	\$14.83	\$14.09	\$13.35	\$12.75	12
			RG58, RG141, RG303	<a href="#">PE4804</a>	\$15.14	\$14.38	\$13.63	\$13.02	13
<b>Receptacle Right Angle</b>									
Cable Connectors		Crimp/Solder	RG58, RG141, RG303	<a href="#">PE4816</a>	\$28.53	\$27.39	\$26.53	\$25.96	14
<b>Plug</b>									
Cable Connectors		Crimp/Solder	PE-C195, PE-P195, RG58, RG141, RG303, LMR-195, .195 inch	<a href="#">PE4808</a>	\$17.70	\$16.82	\$15.93	\$15.22	15
			RG180, RG195, PE-B150	<a href="#">PE4815</a>	\$20.90	\$19.86	\$18.81	\$17.97	16
		Solder/Solder	RG58, RG141, RG303	<a href="#">PE4812</a>	\$14.72	\$13.98	\$13.25	\$12.66	17
<b>Plug Right Angle</b>									
Cable Connectors		Solder/Solder	PE-SR405AL, PE-SR405FL, RG405	<a href="#">PE44038</a>	\$23.87	\$22.92	\$22.20	\$21.72	18

### D-Subminiature Connectors





Connection Method	Product Image	Attachment Cable/Contact	Coax Type / Termination Type	Model No.	PRICE				ROW
					1-24	25-49	50-99	100 +	
<b>Plug Right Angle</b>									
Cable Connectors		Solder/Solder	RG55, RG142, RG223, RG400	<a href="#">PE44036</a>	\$15.61	\$14.83	\$14.05	\$13.42	19

### FAKRA Connectors



Connection Method	Product Image	Attachment Cable/Contact	Coax Type / Termination Type	Model No.	PRICE				ROW
					1-24	25-49	50-99	100 +	
<b>Plug</b>									
Cable Connectors		Crimp/Solder	RG174, RG316, RG188, .100 inch, PE-B100, PE-C100, LMR-100 with Black Color	<a href="#">PE45404A</a>	\$6.32	\$6.00	\$5.69	\$5.44	20
			RG174, RG316, RG188, .100 inch, PE-B100, PE-C100, LMR-100 with White Color	<a href="#">PE45404B</a>	\$6.32	\$5.88	\$5.44	\$5.06	21
			RG174, RG316, RG188, .100 inch, PE-B100, PE-C100, LMR-100 with Blue Color	<a href="#">PE45404C</a>	\$6.32	\$6.00	\$5.69	\$5.44	22
			RG174, RG316, RG188, .100 inch, PE-B100, PE-C100, LMR-100 with Bordeaux Color	<a href="#">PE45404D</a>	\$6.32	\$6.00	\$5.69	\$5.44	23
			RG174, RG316, RG188, .100 inch, PE-B100, PE-C100, LMR-100 with Violet Color	<a href="#">PE45404H</a>	\$6.32	\$6.00	\$5.69	\$5.44	24
			RG174, RG316, RG188, .100 inch, PE-B100, PE-C100, LMR-100 with Beige Color	<a href="#">PE45404I</a>	\$6.32	\$6.00	\$5.69	\$5.44	25
			RG174, RG316, RG188, .100 inch, PE-B100, PE-C100, LMR-100 with Curry Color	<a href="#">PE45404K</a>	\$6.32	\$6.00	\$5.69	\$5.44	26
			RG174, RG316, RG188, .100 inch, PE-B100, PE-C100, LMR-100 with Water Blue Color	<a href="#">PE45404Z</a>	\$6.32	\$6.00	\$5.69	\$5.44	27
PCB Mount		Solder	Thru Hole with Black Color	<a href="#">PE44649A</a>	\$7.10	\$6.75	\$6.39	\$6.11	28
			Thru Hole with White Color	<a href="#">PE44649B</a>	\$3.48	\$3.31	\$3.13	\$2.99	29
			Thru Hole with Blue Color	<a href="#">PE44649C</a>	\$7.10	\$6.75	\$6.39	\$6.11	30
			Thru Hole with Bordeaux Color	<a href="#">PE44649D</a>	\$3.98	\$3.78	\$3.58	\$3.42	31
			Thru Hole with Violet Color	<a href="#">PE44649H</a>	\$3.48	\$3.31	\$3.13	\$2.99	32
			Thru Hole with Beige Color	<a href="#">PE44649I</a>	\$5.60	\$5.32	\$5.04	\$4.82	33
			Thru Hole with Curry Color	<a href="#">PE44649K</a>	\$3.48	\$3.31	\$3.13	\$2.99	34
Thru Hole with Water Blue Color	<a href="#">PE44649Z</a>	\$7.32	\$6.95	\$6.59	\$6.30	35			

\* Fits MIL-C-17 and equivalent cable versions only

# FAKRA Connectors

Connection Method	Product Image	Attachment Cable/Contact	Coax Type / Termination Type	Model No.	PRICE				ROW
					1-24	25-49	50-99	100 +	
<b>Plug Right Angle</b>									
PCB Mount		Solder	Thru Hole with Black Color	<a href="#">PE44651A</a>	\$9.93	\$9.43	\$8.94	\$8.54	36
			Thru Hole with White Color	<a href="#">PE44651B</a>	\$5.98	\$5.68	\$5.38	\$5.14	37
			Thru Hole with Blue Color	<a href="#">PE44651C</a>	\$9.93	\$9.43	\$8.94	\$8.54	38
			Thru Hole with Bordeaux Color	<a href="#">PE44651D</a>	\$8.85	\$8.41	\$7.97	\$7.61	39
			Thru Hole with Violet Color	<a href="#">PE44651H</a>	\$7.39	\$7.02	\$6.65	\$6.36	40
			Thru Hole with Beige Color	<a href="#">PE44651I</a>	\$7.39	\$7.02	\$6.65	\$6.36	41
			Thru Hole with Curry Color	<a href="#">PE44651K</a>	\$7.91	\$7.51	\$7.12	\$6.80	42
			Thru Hole with Water Blue Color	<a href="#">PE44651Z</a>	\$9.14	\$8.68	\$8.23	\$7.86	43
<b>Jack</b>									
Cable Connectors		Crimp/Solder	RG174, RG316, RG188, .100 inch, PE-B100, PE-C100, LMR-100 with Black Color	<a href="#">PE44646A</a>	\$8.17	\$7.76	\$7.35	\$7.03	44
			RG174, RG316, RG188, .100 inch, PE-B100, PE-C100, LMR-100 with White Color	<a href="#">PE44646B</a>	\$8.17	\$7.76	\$7.35	\$7.03	45
			RG174, RG316, RG188, .100 inch, PE-B100, PE-C100, LMR-100 with Blue Color	<a href="#">PE44646C</a>	\$8.17	\$7.76	\$7.35	\$7.03	46
			RG174, RG316, RG188, .100 inch, PE-B100, PE-C100, LMR-100 with Bordeaux Color	<a href="#">PE44646D</a>	\$7.10	\$6.75	\$6.39	\$6.11	47
			RG174, RG316, RG188, .100 inch, PE-B100, PE-C100, LMR-100 with Violet Color	<a href="#">PE44646H</a>	\$8.17	\$7.76	\$7.35	\$7.03	48
			RG174, RG316, RG188, .100 inch, PE-B100, PE-C100, LMR-100 with Beige Color	<a href="#">PE44646I</a>	\$7.28	\$6.92	\$6.55	\$6.26	49
			RG174, RG316, RG188, .100 inch, PE-B100, PE-C100, LMR-100 with Curry Color	<a href="#">PE44646K</a>	\$8.17	\$7.76	\$7.35	\$7.03	50
			RG174, RG316, RG188, .100 inch, PE-B100, PE-C100, LMR-100 with Water Blue Color	<a href="#">PE44646Z</a>	\$7.52	\$7.14	\$6.77	\$6.47	51
			RG188-DS, RG316-DS with Black Color	<a href="#">PE45176</a>	\$6.22	\$5.91	\$5.60	\$5.35	52
			RG316-DS, RG188-DS with Water Blue Color	<a href="#">PE45176Z</a>	\$5.89	\$5.48	\$5.07	\$4.71	53
<b>Jack Right Angle</b>									
Cable Connectors		Crimp/Solder	RG174, RG316, RG188, .100 inch, PE-B100, PE-C100, LMR-100 with Black Color	<a href="#">PE44648A</a>	\$9.93	\$9.43	\$8.94	\$8.54	54
			RG174, RG316, RG188, .100 inch, PE-B100, PE-C100, LMR-100 with White Color	<a href="#">PE44648B</a>	\$9.93	\$9.43	\$8.94	\$8.54	55
			RG174, RG316, RG188, .100 inch, PE-B100, PE-C100, LMR-100 with Blue Color	<a href="#">PE44648C</a>	\$9.93	\$9.43	\$8.94	\$8.54	56
			RG174, RG316, RG188, .100 inch, PE-B100, PE-C100, LMR-100 with Bordeaux Color	<a href="#">PE44648D</a>	\$7.91	\$7.51	\$7.12	\$6.80	57
			RG174, RG316, RG188, .100 inch, PE-B100, PE-C100, LMR-100 with Violet Color	<a href="#">PE44648H</a>	\$8.85	\$8.41	\$7.97	\$7.61	58
			RG174, RG316, RG188, .100 inch, PE-B100, PE-C100, LMR-100 with Beige Color	<a href="#">PE44648I</a>	\$5.73	\$5.44	\$5.16	\$4.93	59
			RG174, RG316, RG188, .100 inch, PE-B100, PE-C100, LMR-100 with Curry Color	<a href="#">PE44648K</a>	\$8.85	\$8.41	\$7.97	\$7.61	60
			RG174, RG316, RG188, .100 inch, PE-B100, PE-C100, LMR-100 with Water Blue Color	<a href="#">PE44648Z</a>	\$9.58	\$9.10	\$8.62	\$8.24	61
			PCB Mount		Solder	Thru Hole with Black Color	<a href="#">PE44650A</a>	\$5.65	\$5.37
Thru Hole with White Color	<a href="#">PE44650B</a>	\$8.12				\$7.71	\$7.31	\$6.98	63
Thru Hole with Blue Color	<a href="#">PE44650C</a>	\$7.07				\$6.72	\$6.36	\$6.08	64
Thru Hole with Bordeaux Color	<a href="#">PE44650D</a>	\$5.92				\$5.62	\$5.33	\$5.09	65
Thru Hole with Violet Color	<a href="#">PE44650H</a>	\$4.96				\$4.71	\$4.46	\$4.27	66
Thru Hole with Beige Color	<a href="#">PE44650I</a>	\$5.98				\$5.68	\$5.38	\$5.14	67
Thru Hole with Water Blue Color	<a href="#">PE44650Z</a>	\$10.37				\$9.85	\$9.33	\$8.92	68

# FME Connectors

Connection Method	Product Image	Attachment Cable/Contact	Coax Type / Termination Type	Model No.	PRICE				ROW
					1-24	25-49	50-99	100 +	
<b>Plug</b>									
Cable Connectors		Crimp/Solder	RG174, RG316, RG188	<a href="#">PE44297</a>	\$13.42	\$12.75	\$12.08	\$11.54	69
			RG55, RG142, RG223, RG400	<a href="#">PE44296</a>	\$12.16	\$11.55	\$10.94	\$10.46	70
			RG58	<a href="#">PE44295</a>	\$14.80	\$14.06	\$13.32	\$12.73	71
<b>Plug, Bulkhead Mount</b>									
Terminal		Solder	Solder Cup with .350 inch D Hole	<a href="#">PE44149</a>	\$9.54	\$9.06	\$8.59	\$8.20	72

\* Fits MIL-C-17 and equivalent cable versions only













## FME Connectors

Connection Method	Product Image	Attachment Cable/Contact	Coax Type / Termination Type	Model No.	PRICE				ROW
					1-24	25-49	50-99	100 +	
	<b>Jack</b>								
Cable Connectors		Crimp/Solder	RG174, RG316, RG188	<a href="#">PE44148</a>	\$13.86	\$13.17	\$12.47	\$11.92	73
			RG55, RG142, RG223, RG400	<a href="#">PE44147</a>	\$9.91	\$9.41	\$8.92	\$8.52	74
			RG58, RG303, RG141, PE-C195, PE-P195, LMR-195, .195 inch	<a href="#">PE44146</a>	\$11.32	\$10.75	\$10.19	\$9.74	75

## GR874 Connectors

Connection Method	Product Image	Attachment Cable/Contact	Coax Type / Termination Type	Model No.	PRICE				ROW
					1-24	25-49	50-99	100 +	
	<b>Sexless</b>								
Cable Connectors		Accessories		<a href="#">PE4348</a>	\$52.60	\$49.97	\$47.34	\$45.24	76
		Crimp/Solder	RG214, RG9, RG225, RG393	<a href="#">PE4352</a>	\$95.75	\$90.96	\$86.18	\$82.35	77
	RG55, RG58, RG141, RG142, RG223, RG400		<a href="#">PE4233</a>	\$30.76	\$29.22	\$27.68	\$26.45	78	





## HN Connectors



Connection Method	Product Image	Attachment Cable/Contact	Coax Type / Termination Type	Model No.	1 Pc.	See Web for Volume Pricing			ROW	
	<b>Male</b>									
Cable Connectors		Clamp/Solder	RG14, RG217	<a href="#">PE4475</a>	\$51.61	See Web for Volume Pricing				79
			RG17, RG218, RG219	<a href="#">PE4476</a>	\$137.88					80
			RG213, RG214, RG8, RG9, RG225, RG393	<a href="#">PE4182</a>	\$28.84					81
			RG58, RG55, RG141, RG142, RG223, RG400, RG303, PE-C195, PE-P195, LMR-195	<a href="#">PE4198</a>	\$39.11					82
			RG59*, RG62*, RG71	<a href="#">PE4479</a>	\$62.01					83
		Crimp/Solder	RG213, RG215, RG8	<a href="#">PE4473</a>	\$45.86					84
			RG214, RG9, RG225, RG393	<a href="#">PE4474</a>	\$47.50					85
			RG55, RG142, RG223, RG400, RG141	<a href="#">PE4477</a>	\$43.17					86
			RG58, RG141	<a href="#">PE4478</a>	\$38.12					87
				<b>Male Right Angle</b>						
Cable Connectors		Clamp/Solder	RG14, RG217	<a href="#">PE45307</a>	\$83.12					88
			RG213, RG8, RG393, RG225, RG214, RG393, RG9	<a href="#">PE4230</a>	\$69.50					89
			RG55, RG58, RG141, RG142, RG223, RG303, RG400, PE-C195, PE-P195, LMR-195	<a href="#">PE4480</a>	\$83.73					90
	<b>Female</b>									
Cable Connectors		Clamp/Solder	RG213, RG8, RG225, RG214, RG393	<a href="#">PE4229</a>	\$63.89	See Web for Volume Pricing				91
			RG401, PE-SR401AL, PE-SR401FL	<a href="#">PE4229-401</a>	\$63.89					92
	<b>Female, Bulkhead Mount</b>									
Terminal		Solder	Turret with .765 inch DD Hole	<a href="#">PE4481</a>	\$69.46					93
	<b>Female, 4 Hole Flange Mount</b>									
Terminal		Field Replaceable	Slotted Contact	<a href="#">PE44718</a>	\$65.42					94
		Solder	Solder Cup with .906 inch Hole Spacing	<a href="#">PE4183</a>	\$34.62					95



\* Fits MIL-C-17 and equivalent cable versions only

Connectors

See Our Website For Current Pricing & Real-Time Stock Availability!











LC Connectors									
Connection Method	Product Image	Attachment Cable/Contact	Coax Type / Termination Type	Model No.	PRICE				ROW
					1-9	10-24	25-49	50+	
<b>Male</b>									
Cable Connectors		Clamp/Solder	RG14, RG217	<a href="#">PE4563</a>	\$220.92	\$209.87	\$198.83	\$189.99	96
			RG213, RG214, RG8, RG9, RG225, RG393, RG215	<a href="#">PE4564</a>	\$173.72	\$165.03	\$156.35	\$149.40	97
			RG218, RG219, RG17	<a href="#">PE4323</a>	\$234.06	\$222.36	\$210.65	\$201.29	98
<b>Male Right Angle</b>									
Cable Connectors		Clamp/Solder	RG14, RG217	<a href="#">PE44448</a>	\$351.96				99
			RG213, RG214, RG8, RG9, RG225, RG393, RG215	<a href="#">PE44447</a>	\$269.63				1
<b>Female</b>									
Cable Connectors		Clamp/Solder	RG17, RG218, RG219	<a href="#">PE44451</a>	\$291.25		See Web for Volume Pricing		2
			RG213, RG214, RG8, RG9, RG225, RG393, RG215	<a href="#">PE44450</a>	\$227.68				3
<b>Female, 4 Hole Flange Mount</b>									
Terminal		Solder	Pin	<a href="#">PE45519</a>	\$192.42				4
			Pin with 1.44 inch Hole Spacing	<a href="#">PE4192</a>	\$113.60				5

MC-Card Connectors									
Connection Method	Product Image	Attachment Cable/Contact	Coax Type / Termination Type	Model No.	PRICE				ROW
					1-24	25-49	50-99	100 +	
<b>Plug</b>									
Cable Connectors		Crimp/Solder	RG174, RG316, RG188	<a href="#">PE44309</a>	\$12.35	\$11.73	\$11.12	\$10.62	6
			RG178, RG196	<a href="#">PE44310</a>	\$12.35	\$11.73	\$11.12	\$10.62	7
			RG188-DS, RG316-DS	<a href="#">PE45169</a>	\$12.20	\$11.59	\$10.98	\$10.49	8
<b>Plug Right Angle</b>									
Cable Connectors		Crimp/Solder	RG174, RG316, RG188, LMR-100, PE-B100, PE-C100, .100 inch	<a href="#">PE44308</a>	\$14.99	\$14.24	\$13.49	\$12.89	9
			RG178, RG196	<a href="#">PE44311</a>	\$16.55	\$15.72	\$14.90	\$14.23	10
			RG188-DS, RG316-DS	<a href="#">PE45168</a>	\$13.01	\$12.36	\$11.71	\$11.19	11



MCX Connectors									
Connection Method	Product Image	Attachment Cable/Contact	Coax Type / Termination Type	Model No.	PRICE				ROW
					1-24	25-49	50-99	100 +	
<b>Plug</b>									
Cable Connectors		Crimp/Solder	RG178, RG196	<a href="#">PE4552</a>	\$20.94	\$19.89	\$18.85	\$18.01	12
			RG188-DS, RG316-DS	<a href="#">PE4878</a>	\$15.05	\$14.30	\$13.55	\$12.94	13
			RG316, RG174, RG188, LMR-100, PE-B100, PE-C100, .100 inch	<a href="#">PE4551</a>	\$13.38	\$12.71	\$12.04	\$11.51	14
			RG55, RG141, RG142, RG223, RG400	<a href="#">PE4881</a>	\$32.80	\$31.49	\$30.50	\$29.85	15
			RG58	<a href="#">PE4880</a>	\$26.57	\$25.51	\$24.71	\$24.18	16
PCB Mount		Solder	PE-SR405AL, PE-SR405FL, PE-SR405FLJ, PE-SR405TN, RG405	<a href="#">PE4876</a>	\$26.18	\$24.87	\$23.56	\$22.51	17
			Surface Mount	<a href="#">PE44613</a>	\$18.74	\$17.80	\$16.87	\$16.12	18
			Thru Hole with .200 inch x .052 inch Hole Spacing	<a href="#">PE4559</a>	\$24.00	\$22.80	\$21.60	\$20.64	19
<b>Plug Right Angle</b>									
Cable Connectors		Crimp/Solder	RG174, RG316, RG188, LMR-100, PE-B100, PE-C100, .100 inch	<a href="#">PE4553</a>	\$18.24	\$17.33	\$16.42	\$15.69	20
			RG178, RG196	<a href="#">PE4554</a>	\$20.12	\$19.11	\$18.11	\$17.30	21
			RG188-DS, RG316-DS	<a href="#">PE4879</a>	\$18.17	\$17.26	\$16.35	\$15.63	22

\* Fits MIL-C-17 and equivalent cable versions only

## MCX Connectors

Connection Method	Product Image	Attachment Cable/Contact	Coax Type / Termination Type	Model No.	PRICE				ROW
					1-24	25-49	50-99	100 +	
<b>Plug Right Angle</b>									
Cable Connectors		Crimp/Solder	RG55, RG142, RG223, RG400	<a href="#">PE4883</a>	\$18.23	\$17.32	\$16.41	\$15.68	23
			RG58, RG303, RG141, PE-C195, PE-P195, LMR-195, .195 inch	<a href="#">PE4882</a>	\$22.61	\$21.48	\$20.35	\$19.44	24
		Solder	PE-SR405AL, PE-SR405FL, PE-SR405FLJ, PE-SR405TN, RG405	<a href="#">PE4877</a>	\$29.77	\$28.28	\$26.79	\$25.60	25
		Solder/Solder	PE-SR405AL, PE-SR405FL, PE-SR405FLJ, PE-SR405TN, RG405	<a href="#">PE44698</a>	\$9.89	\$9.40	\$8.90	\$8.51	26
PCB Mount		Solder	Thru Hole with .200 inch x .067 inch Hole Spacing	<a href="#">PE44830</a>	\$19.72	\$18.93	\$18.34	\$17.95	27
<b>Jack</b>									
Cable Connectors		Crimp/Solder	RG174, RG316, RG188, PE-B100, PE-C100, .100 inch, LMR-100	<a href="#">PE4562</a>	\$25.62	\$24.34	\$23.06	\$22.03	28
			RG178, RG196	<a href="#">PE4884</a>	\$32.52	\$30.89	\$29.27	\$27.97	29
			RG188-DS, RG316-DS	<a href="#">PE4885</a>	\$21.31	\$20.24	\$19.18	\$18.33	30
PCB Mount		Solder	.042 inch End Launch	<a href="#">PE4893</a>	\$26.30	\$24.99	\$23.67	\$22.62	31
			.062 inch End Launch	<a href="#">PE4892</a>	\$15.38	\$14.61	\$13.84	\$13.23	32
			End Launch	<a href="#">PE44661</a>	\$23.38	\$22.21	\$21.04	\$20.11	33
			Surface Mount	<a href="#">PE44660</a>	\$35.18	\$33.42	\$31.66	\$30.25	34
			Surface Mount	<a href="#">PE4889</a>	\$18.04	\$17.14	\$16.24	\$15.51	35
			Thru Hole with .200 inch x .052 inch Hole Spacing	<a href="#">PE4555</a>	\$15.28	\$14.52	\$13.75	\$13.14	36
			Thru Hole with .200 inch x .067 inch Hole Spacing	<a href="#">PE44303</a>	\$19.37	\$18.40	\$17.43	\$16.66	37
<b>Jack, Bulkhead Mount</b>									
Cable Connectors		Crimp/Solder	RG174, RG316, RG188, LMR-100, PE-B100, PE-C100, .100 inch with .177 inch D Hole	<a href="#">PE4887</a>	\$24.73	\$23.49	\$22.26	\$21.27	38
			RG178, RG196 with .177 inch D Hole	<a href="#">PE4886</a>	\$27.10	\$25.75	\$24.39	\$23.31	39
			RG188-DS, RG316-DS with .177 inch D Hole	<a href="#">PE4888</a>	\$19.12	\$18.16	\$17.21	\$16.44	40
Terminal		Solder	Turret with .177 inch D Hole	<a href="#">PE4561</a>	\$21.30	\$20.24	\$19.17	\$18.32	41
<b>Jack, 2 Hole Flange Mount</b>									
Terminal		Solder	Pin with .328 inch Hole Spacing	<a href="#">PE4894</a>	\$28.53	\$27.10	\$25.68	\$24.54	42
			Solder Cup with .328 inch Hole Spacing	<a href="#">PE4891</a>	\$30.26	\$28.75	\$27.23	\$26.02	43
<b>Jack Right Angle</b>									
PCB Mount		Solder	Surface Mount	<a href="#">PE4890</a>	\$25.01	\$23.76	\$22.51	\$21.51	44
			Thru Hole with .200 inch x .052 inch Hole Spacing	<a href="#">PE4556</a>	\$18.66	\$17.73	\$16.79	\$16.05	45
			Thru Hole with .200 inch x .052 inch Hole Spacing	<a href="#">PE45274</a>	\$17.11	\$16.25	\$15.40	\$14.71	46
<b>Jack Right Angle, Bulkhead Mount</b>									
Terminal		Solder	Turret with .177 inch D Hole	<a href="#">PE4560</a>	\$50.28	\$47.77	\$45.25	\$43.24	47

## Reverse Polarity MCX Connectors



Connection Method	Product Image	Attachment Cable/Contact	Coax Type / Termination Type	Model No.	PRICE				ROW
					1-24	25-49	50-99	100 +	
<b>Plug</b>									
Cable Connectors		Crimp/Solder	RG174, RG316, RG188, .100 inch, PE-B100, PE-C100, LMR-100	<a href="#">PE44369</a>	\$27.83	\$26.44	\$25.05	\$23.93	48
			RG178, RG196	<a href="#">PE44370</a>	\$27.06	\$25.71	\$24.35	\$23.27	49
<b>Plug Right Angle</b>									
Cable Connectors		Crimp/Solder	RG178, RG196	<a href="#">PE45051</a>	\$8.67	\$8.32	\$8.06	\$7.89	50
			RG316, RG188, RG174	<a href="#">PE45050</a>	\$9.63	\$9.15	\$8.67	\$8.28	51

\* Fits MIL-C-17 and equivalent cable versions only









Connectors

See Our Website For Current Pricing & Real-Time Stock Availability!

## Reverse Polarity MCX Connectors

Connection Method	Product Image	Attachment Cable/Contact	Coax Type / Termination Type	Model No.	PRICE				ROW
					1-24	25-49	50-99	100 +	
<b>Jack, Bulkhead Mount</b>									
Cable Connectors		Crimp/Solder	RG178, RG196 with .177 inch D Hole	<a href="#">PE44374</a>	\$33.12	\$31.46	\$29.81	\$28.48	52
PCB Mount		Solder	End Launch with .177 inch D Hole	<a href="#">PE44377</a>	\$31.03	\$29.48	\$27.93	\$26.69	53
<b>Jack Right Angle, Bulkhead Mount</b>									
PCB Mount		Solder	Thru Hole with .177 inch D Hole	<a href="#">PE44376</a>	\$34.83	\$33.09	\$31.35	\$29.95	54

## MHV Connectors

Connection Method	Product Image	Attachment Cable/Contact	Coax Type / Termination Type	Model No.	PRICE		ROW		
					1 Pc.	See Web for Volume Pricing			
<b>Male</b>									
Cable Connectors		Clamp/Solder	RG174, RG316, RG188	<a href="#">PE4494</a>	\$19.39	See Web for Volume Pricing	55		
			RG213, RG214, RG8, RG9, RG11*, RG225, RG393, RG144*, RG216*, RG215	<a href="#">PE4299</a>	\$35.21		56		
			RG58, RG55, RG141, RG142, RG223, RG400, RG303, PE-C195, PE-P195, LMR-195	<a href="#">PE4076</a>	\$21.24		57		
			RG59*, RG62*, RG71	<a href="#">PE4098</a>	\$19.40		58		
		Crimp/Solder	RG174, RG316, RG188, LMR-100, PE-B100, PE-C100, .100 inch	<a href="#">PE4933</a>	\$50.11		59		
			RG213, RG8	<a href="#">PE4493</a>	\$35.60		60		
			RG214, RG9, RG225, RG393	<a href="#">PE4350</a>	\$40.14		61		
			RG55, RG141, RG142, RG223, RG400	<a href="#">PE4657</a>	\$22.48		62		
			RG58, RG303, RG141, PE-C195, PE-P195, LMR-195, .195 inch	<a href="#">PE4093</a>	\$29.03	63			
			RG59*, RG62*, RG71	<a href="#">PE4075</a>	\$20.95	64			
<b>Male Right Angle</b>									
Cable Connectors		Clamp/Solder	RG174, RG316, RG188	<a href="#">PE4710</a>	\$38.12		65		
			RG213, RG214, RG8, RG9, RG11*, RG225, RG393	<a href="#">PE4709</a>	\$67.36		66		
			RG58, RG55, RG141, RG142, RG223, RG400, RG303, PE-C195, PE-P195, LMR-195	<a href="#">PE4226</a>	\$38.81		67		
			RG59*, RG62*, RG71	<a href="#">PE4227</a>	\$36.17		68		
<b>Female</b>									
Cable Connectors		Clamp/Solder	RG174, RG316, RG188	<a href="#">PE44104</a>	\$31.44	See Web for Volume Pricing	69		
			RG58, RG55, RG141, RG142, RG223, RG400, RG303, PE-C195, PE-P195, LMR-195	<a href="#">PE4225</a>	\$28.69		70		
			RG59*, RG62*, RG71	<a href="#">PE4181</a>	\$26.77		71		
		Crimp/Solder	PE-P195, PE-C195, RG58, RG141, RG303, .195 inch, LMR-195	<a href="#">PE44102</a>	\$32.32		72		
			RG55, RG141, RG142, RG223, RG400	<a href="#">PE44100</a>	\$30.37		73		
			RG59*, RG62*	<a href="#">PE44103</a>	\$39.35	74			
<b>Female, Bulkhead Mount</b>									
Cable Connectors		Clamp/Solder	RG174, RG316, RG188	<a href="#">PE44111</a>	\$53.52		75		
			RG213, RG214, RG8, RG9, RG11*, RG225, RG393	<a href="#">PE44105</a>	\$70.80		76		
			RG55, RG58, RG141, RG142, RG223, RG303, RG400, PE-C195, PE-P195, LMR-195	<a href="#">PE44106</a>	\$55.40		77		
			RG59*, RG62*, RG71	<a href="#">PE44109</a>	\$51.86		78		
		Crimp/Solder	RG55, RG141, RG142, RG223, RG400	<a href="#">PE44107</a>	\$33.00		79		
RG58, RG303, RG141, PE-C195, PE-P195, LMR-195, .195 inch			<a href="#">PE44108</a>	\$44.62	80				
Terminal		Solder	RG59*, RG62*, RG71	<a href="#">PE44110</a>	\$55.97	81			
			Solder Cup	<a href="#">PE44896</a>	\$124.93	82			
			Solder Cup with .480 inch D Hole	<a href="#">PE4495</a>	\$52.98	83			
			Solder Cup with .380 inch DD Hole	<a href="#">PE4193</a>	\$27.94	84			
			Solder Cup with .380 inch DD Hole	<a href="#">PE4311</a>	\$53.03	85			
			Turret with .537 inch D Hole	<a href="#">PE4312</a>	\$43.88	86			

Connectors



See Our Website For Current Pricing & Real-Time Stock Availability!

\* Fits MIL-C-17 and equivalent cable versions only













## MHV Connectors

Connection Method	Product Image	Attachment Cable/Contact	Coax Type / Termination Type	Model No.	PRICE				ROW
					1-24	25-49	50-99	100 +	
<b>Female, 4 Hole Flange Mount</b>									
Cable Connectors		Clamp/Solder	RG214, RG213, RG393, RG8, RG225, RG11*, RG216*, RG144*, RG215, RG9 with .718 inch Hole Spacing	<a href="#">PE44112</a>	\$59.31	\$56.34	\$53.38	\$51.01	87
			RG58, RG142, RG223, RG400, RG141, RG303, RG55, LMR-400, PE-C195, PE-P195 with .500 inch Threaded Hole Spacing	<a href="#">PE4313</a>	\$52.21	\$49.60	\$46.99	\$44.90	88
			RG59*, RG62*, RG71 with .500 inch Threaded Hole Spacing	<a href="#">PE4314</a>	\$55.88	\$53.09	\$50.29	\$48.06	89
Terminal		Solder	Solder Cup	<a href="#">PE45035</a>	\$62.56	\$59.43	\$56.30	\$53.80	90
			Solder Cup with .500 inch Threaded Hole Spacing	<a href="#">PE4228</a>	\$35.97	\$34.17	\$32.37	\$30.93	91

## Mini SMP Connectors

Connection Method	Product Image	Attachment Cable/Contact	Coax Type / Termination Type	Model No.	PRICE				ROW
					1-24	25-49	50-99	100 +	
<b>Male</b>									
PCB Mount		Solder	Edge Launch	<a href="#">PE44969</a>	\$32.79	\$31.15	\$29.51	\$28.20	92
			End Launch	<a href="#">PE44490</a>	\$30.07	\$28.57	\$27.06	\$25.86	93
			Surface Mount	<a href="#">PE44489</a>	\$35.58	\$33.80	\$32.02	\$30.60	94
			Thru Hole	<a href="#">PE44970</a>	\$61.54	\$58.46	\$55.39	\$52.92	95
<b>Male, Solder</b>									
Terminal		Solder	Pin	<a href="#">PE44973</a>	\$42.81	\$40.67	\$38.53	\$36.82	96
<b>Male Right Angle</b>									
PCB Mount		Solder	Surface Mount	<a href="#">PE44968</a>	\$74.84	\$71.10	\$67.36	\$64.36	97
<b>Female</b>									
Cable Connectors		Solder	PE-047SR, PE-SR047AL, PE-SR047FL	<a href="#">PE44491</a>	\$43.05	\$40.90	\$38.75	\$37.02	98
			PE-047SR, PE-SR047FL	<a href="#">PE44971</a>	\$49.88	\$47.39	\$44.89	\$42.90	99
			PE-SR405AL, PE-SR405FL, PE-SR405FLJ, PE-SR405TN, RG405	<a href="#">PE44974</a>	\$39.68	\$37.70	\$35.71	\$34.12	1
			PE-SR405AL, PE-SR405FL, PE-SR405FLJ, PE-SR405TN, RG405	<a href="#">PE44492</a>	\$42.47	\$40.35	\$38.22	\$36.52	2
<b>Female Right Angle</b>									
Cable Connectors		Solder	PE-047SR, PE-SR047AL, PE-SR047FL	<a href="#">PE44493</a>	\$55.40	\$52.63	\$49.86	\$47.64	3
			PE-SR405AL, PE-SR405FL, PE-SR405FLJ, PE-SR405TN, RG405	<a href="#">PE44494</a>	\$49.84	\$47.35	\$44.86	\$42.86	4
			PE-SR405AL, PE-SR405FL, PE-SR405FLJ, PE-SR405TN, RG405	<a href="#">PE44972</a>	\$64.15	\$60.94	\$57.74	\$55.17	5

## Mini UHF Connectors

Connection Method	Product Image	Attachment Cable/Contact	Coax Type / Termination Type	Model No.	PRICE				ROW
					1-24	25-49	50-99	100 +	
<b>Male</b>									
Cable Connectors		Crimp/Solder	RG174, RG316, RG188	<a href="#">PE44090</a>	\$13.98	\$13.28	\$12.58	\$12.02	6
			RG55, RG141, RG142, RG223, RG400	<a href="#">PE44088</a>	\$12.64	\$12.01	\$11.38	\$10.87	7
			RG55, RG141, RG142, RG223, RG400	<a href="#">PE4521</a>	\$7.85	\$7.46	\$7.07	\$6.75	8
			RG58, RG303, RG141, PE-C195, PE-P195, LMR-195, .195 inch	<a href="#">PE4342</a>	\$7.85	\$7.46	\$7.07	\$6.75	9
<b>Female</b>									
Cable Connectors		Crimp/Solder	RG174, RG316, RG188	<a href="#">PE44085</a>	\$5.63	\$5.35	\$5.07	\$4.84	10
			RG55, RG141, RG142, RG223, RG400	<a href="#">PE44083</a>	\$12.16	\$11.55	\$10.94	\$10.46	11
			RG58, RG303, RG141, PE-C195, PE-P195, LMR-195, .195 inch	<a href="#">PE44084</a>	\$15.94	\$15.14	\$14.35	\$13.71	12
<b>Female, Bulkhead Mount</b>									
Cable Connectors		Crimp/Solder	.195 inch, RG58, RG141, RG303, LMR-195, LMR-195-FR, PE-C195, PE-P195 with .410 inch D Hole	<a href="#">PE44087</a>	\$17.96	\$17.06	\$16.16	\$15.45	13
			RG55, RG141, RG142, RG223, RG400 with .410 inch D Hole	<a href="#">PE44086</a>	\$14.83	\$14.09	\$13.35	\$12.75	14

\* Fits MIL-C-17 and equivalent cable versions only

Connectors

See Our Website For Current Pricing & Real-Time Stock Availability!

## Mini UHF Connectors

Connection Method	Product Image	Attachment Cable/Contact	Coax Type / Termination Type	Model No.	PRICE				ROW
					1-24	25-49	50-99	100 +	
PCB Mount		Solder	Thru Hole with .380 inch Diameter	<a href="#">PE44092</a>	\$13.04	\$12.39	\$11.74	\$11.21	15
Terminal			Solder Cup with .350 inch D Hole	<a href="#">PE44089</a>	\$9.74	\$9.25	\$8.77	\$8.38	16
			Solder Cup with .350 inch D Hole	<a href="#">PE4644</a>	\$7.76	\$7.37	\$6.98	\$6.67	17
<b>Female, 4 Hole Flange Mount</b>									
Terminal		Solder	Solder Cup with .437 inch Hole Spacing	<a href="#">PE44091</a>	\$13.11	\$12.45	\$11.80	\$11.27	18

## MMBX Connectors

Connection Method	Product Image	Attachment Cable/Contact	Coax Type / Termination Type	Model No.	PRICE				ROW
					1 Pc.	See Web for Volume Pricing			
<b>Plug</b>									
Cable Connectors		Crimp/Solder	RG178, RG196	<a href="#">PE45250</a>	\$13.69				19
			RG316, RG174	<a href="#">PE45251</a>	\$15.47				20
			RG316-DS, RG188-DS	<a href="#">PE45252</a>	\$12.22				21
		Solder/Non-Solder Contact	RG405, PE-SR405FL, PE-SR405FLJ	<a href="#">PE45253</a>	\$15.82				22
PCB Mount		Solder/Solder	Surface Mount	<a href="#">PE45259TR1</a>	\$20.28				23
			Surface Mount	<a href="#">PE45259TR750</a>	\$9,962.61				24
<b>Plug Right Angle</b>									
Cable Connectors		Crimp/Solder	RG178, RG196	<a href="#">PE45254</a>	\$18.12				25
			RG316, RG174	<a href="#">PE45255</a>	\$18.60				26
			RG316-DS, RG188-DS	<a href="#">PE45256</a>	\$18.12				27
		Solder/Solder	RG405, PE-SR405FL, PE-SR405FLJ	<a href="#">PE45257</a>	\$18.12		See Web for Volume Pricing		28
<b>Jack</b>									
PCB Mount		Solder	Edge Launch	<a href="#">PE45261</a>	\$18.51				29
			Surface Mount	<a href="#">PE45262TR1</a>	\$12.64				30
			Surface Mount	<a href="#">PE45262TR750</a>	\$6,150.69				31
			Through Hole	<a href="#">PE45265TR500</a>	\$5,154.70				32
			Through Hole	<a href="#">PE45265TR1</a>	\$15.29				33
<b>Jack, Thread-In</b>									
Terminal		Solder	Pin	<a href="#">PE45267</a>	\$14.21				34

## MMCX Connectors

Connection Method	Product Image	Attachment Cable/Contact	Coax Type / Termination Type	Model No.	PRICE				ROW
					1-24	25-49	50-99	100 +	
<b>Plug</b>									
Cable Connectors		Crimp/Solder	RG174, RG316, RG188, LMR-100, PE-B100, PE-C100, .100 inch	<a href="#">PE4896</a>	\$18.54	\$17.61	\$16.69	\$15.94	35
			RG178, RG196	<a href="#">PE4897</a>	\$18.09	\$17.19	\$16.28	\$15.56	36
			RG178, RG196	<a href="#">PE44645</a>	\$19.55	\$18.57	\$17.60	\$16.81	37
			RG188-DS, RG316-DS	<a href="#">PE44874</a>	\$20.57	\$19.54	\$18.51	\$17.69	38
		Solder	PE-047SR, PE-SR047AL, PE-SR047FL	<a href="#">PE44456</a>	\$23.31	\$22.14	\$20.98	\$20.05	39
			PE-SR405AL, PE-SR405FL, PE-SR405FLJ, PE-SR405TN, RG405	<a href="#">PE44453</a>	\$21.76	\$20.67	\$19.58	\$18.71	40

\* Fits MIL-C-17 and equivalent cable versions only



Technical Support  
+1 (949) 261-1920













Same-Day Shipping,  
Even Custom  
Cable Assemblies



Connectors

See Our Website For Current Pricing & Real-Time Stock Availability!

## MMCX Connectors

Connection Method	Product Image	Attachment Cable/Contact	Coax Type / Termination Type	Model No.	PRICE				ROW
					1-24	25-49	50-99	100 +	
	<b>Plug</b>								
PCB Mount		Solder	End Launch	<a href="#">PE44663</a>	\$25.74	\$24.45	\$23.17	\$22.14	41
			Thru Hole with .100 inch x .031 inch Hole Spacing	<a href="#">PE4905</a>	\$29.04	\$27.59	\$26.14	\$24.97	42
	<b>Plug Right Angle</b>								
Cable Connectors		Crimp/Solder	RG174, RG316, RG188, LMR-100, PE-B100, PE-C100, .100 inch	<a href="#">PE4898</a>	\$12.64	\$12.01	\$11.38	\$10.87	43
			RG178, RG196	<a href="#">PE4899</a>	\$20.97	\$19.92	\$18.87	\$18.03	44
			RG316-DS, RG188-DS	<a href="#">PE44784</a>	\$23.40	\$22.23	\$21.06	\$20.12	45
		Solder	PE-047SR, PE-SR047AL, PE-SR047FL	<a href="#">PE44457</a>	\$27.79	\$26.40	\$25.01	\$23.90	46
	Solder/Solder	PE-SR405AL, PE-SR405FL, PE-SR405FLJ, PE-SR405TN, RG405	<a href="#">PE44699</a>	\$9.80	\$9.31	\$8.82	\$8.43	47	
	<b>Jack</b>								
Cable Connectors		Crimp/Solder	RG174, RG316, RG188, .100 inch, PE-B100, PE-C100, LMR-100	<a href="#">PE4901</a>	\$18.62	\$17.69	\$16.76	\$16.01	48
			RG178, RG196	<a href="#">PE4902</a>	\$18.62	\$17.69	\$16.76	\$16.01	49
			RG316-DS, RG188-DS	<a href="#">PE44852</a>	\$20.66	\$19.63	\$18.59	\$17.77	50
		Solder	PE-047SR, PE-SR047AL, PE-SR047FL	<a href="#">PE44459</a>	\$34.20	\$32.49	\$30.78	\$29.41	51
	PE-SR405AL, PE-SR405FL, PE-SR405FLJ, PE-SR405TN, RG405		<a href="#">PE44458</a>	\$32.37	\$30.75	\$29.13	\$27.84	52	
PCB Mount		Solder	Surface Mount	<a href="#">PE44662</a>	\$23.83	\$22.64	\$21.45	\$20.49	53
			Thru Hole with .100 inch x .031 inch Hole Spacing	<a href="#">PE4904</a>	\$16.05	\$15.25	\$14.45	\$13.80	54
	<b>Jack Right Angle</b>								
PCB Mount		Solder	Thru Hole with .100 inch x .031 inch Hole Spacing	<a href="#">PE4903</a>	\$25.48	\$24.21	\$22.93	\$21.91	55

## N Connectors







Connection Method	Product Image	Attachment Cable/Contact	Coax Type / Termination Type	Model No.	PRICE				ROW
					1-24	25-49	50-99	100 +	
	<b>Male</b>								
Cable Connectors		Clamp	7/8 inch Annular, 7/8 inch Helical, 7/8 inch Superflexible, 7/8 inch Flexible	<a href="#">PE44976</a>	\$63.60	\$60.42	\$57.24	\$54.70	56
			1/2 inch Helical, 1/2 inch Superflexible, PE-1/2 Helical, PE-1/2SFHC	<a href="#">PE44729</a>	\$50.97	\$48.42	\$45.87	\$43.83	57
		Clamp/Non-Solder Contact	1/4 inch Superflexible, PE-1/4SFHC	<a href="#">PE44726</a>	\$64.48	\$61.26	\$58.03	\$55.45	58
			LMR-400, PE-C400, PE-B400, PE-B405	<a href="#">EZ-400-NMC-2-D</a>	\$24.64	\$24.64	\$24.64	\$24.64	59
			LMR-600, PE-C600	<a href="#">EZ-600-NMC-2-D</a>	\$24.64	\$24.64	\$24.64	\$24.64	60
			PE-1/2FAC, 1/2 inch Flexible, 1/2 inch Annular	<a href="#">PE44735</a>	\$45.31	\$43.04	\$40.78	\$38.97	61
		Clamp/Solder	LMR-240, PE-C240	<a href="#">TC-240-NMC</a>	\$18.36	\$18.36	\$18.36	\$18.36	62
			PE-C300	<a href="#">PE44045</a>	\$24.56	\$23.33	\$22.10	\$21.12	63
			PE-C400, PE-B400, PE-B405, LMR-400, LMR-400-DB, LMR-400-UF, .400 inch	<a href="#">PE4133</a>	\$26.39	\$25.33	\$24.54	\$24.01	64
			PE-C500, LMR-500	<a href="#">PE44046</a>	\$40.39	\$38.37	\$36.35	\$34.74	65
			PE-C600, .600 inch, LMR-600	<a href="#">PE44349</a>	\$80.00	\$76.00	\$72.00	\$68.80	66
			PE-P142LL	<a href="#">PE44825</a>	\$50.07	\$47.57	\$45.06	\$43.06	67
			PE-P160LL	<a href="#">PE45446</a>	\$88.53	\$84.10	\$79.68	\$76.14	68
			PE-P300LL	<a href="#">PE44809</a>	\$79.51	\$75.53	\$71.56	\$68.38	69
PE-SR401AL, PE-SR401FL, RG401	<a href="#">PE4434</a>	\$23.40	\$22.23	\$21.06	\$20.12	70			
PE-SR402AL, PE-SR402FL, RG402	<a href="#">PE4006</a>	\$23.40	\$22.23	\$21.06	\$20.12	71			
PE-SR405AL, PE-SR405FL, RG405	<a href="#">PE4129</a>	\$22.99	\$21.84	\$20.69	\$19.77	72			

\* Fits MIL-C-17 and equivalent cable versions only

Connectors

See Our Website For Current Pricing & Real-Time Stock Availability!

# N Connectors

Connection Method	Product Image	Attachment Cable/Contact	Coax Type / Termination Type	Model No.	PRICE		ROW
					1 Pc.	See Web for Volume Pricing	
<b>Male</b>							
Cable Connectors		Clamp/Solder	RG14, RG217	<a href="#">PE4221</a>	\$35.35	See Web for Volume Pricing	73
			RG17, RG218, RG219	<a href="#">PE4433</a>	\$107.29		74
			RG174, RG316, RG188	<a href="#">PE4224</a>	\$19.39		75
			RG213, RG214, RG8, RG9, RG11*, RG225, RG393, RG144*, RG216*, RG215	<a href="#">PE4062</a>	\$18.61		76
			RG58, RG55, RG141, RG142, RG223, RG400, RG303, PE-C195, PE-P195, LMR-195	<a href="#">PE4081</a>	\$15.12		77
	RG59*, RG62*, RG71	<a href="#">PE4331</a>	\$21.69	78			
		Clamp/Solder (Captive Contact)	RG213, RG214, RG8, RG9, RG11*, RG225, RG393, RG144*, RG216*, RG215	<a href="#">PE4132</a>	\$19.27		79
				Crimp/Crimp	PE-C195, PE-P195, RG58, RG141, RG303, LMR-195, .195 inch		<a href="#">PE44520</a>
	RG55, RG141, RG142, RG223, RG400	<a href="#">PE4042</a>			\$23.07		81
		Crimp/Non-Solder Contact	LMR-200, PE-C200	<a href="#">EZ-200-NMH-X</a>	\$16.00		82
			LMR-240, PE-C240, RG8X	<a href="#">EZ-240-NMH-X</a>	\$12.75		83
			LMR-400, PE-C400	<a href="#">EZ-400-NMH-PL-X</a>	\$15.40		84
			LMR-400, PE-C400, PE-B400, PE-B405	<a href="#">EZ-400-NMH-X</a>	\$14.78		85
			LMR-600, PE-C600	<a href="#">EZ-600-NMH-X</a>	\$21.56		86
		Crimp/Solder	LMR-195, PE-C195	<a href="#">TC-195-NMH-X</a>	\$13.25		87
			LMR-200, PE-C200	<a href="#">TC-200-NMH-X</a>	\$17.14		88
			LMR-240, PE-C240	<a href="#">TC-240-NMH-X</a>	\$15.09		89
			LMR-400, PE-C400, PE-B405	<a href="#">TC-400-NMH-X</a>	\$14.78		90
			LMR-600, PE-C600	<a href="#">TC-600-NMH-X</a>	\$20.33		91
			PE-B400, PE-B405, PE-C400, LMR-400, .400 inch	<a href="#">PE4550</a>	\$17.23		92
			PE-C240, RG8X, .240 inch, LMR-240, LMR-240-DB, LMR-240-UF, B7808A	<a href="#">PE44521</a>	\$18.04		93
			PE-C400, PE-B400, PE-B405, LMR-400, LMR-400-DB, LMR-400-UF, .400 inch	<a href="#">PE44522</a>	\$21.37		94
			PE-C600, LMR-600, LMR-600-DB, .600 inch	<a href="#">PE44454</a>	\$36.66		95
			PE-C600, LMR-600, LMR-600-DB, .600 inch	<a href="#">PE44523</a>	\$70.85		96
			RG174, RG316, RG188, LMR-100, PE-B100, PE-C100, .100 inch	<a href="#">PE4429</a>	\$21.87		97
			RG178, RG196	<a href="#">PE4647</a>	\$30.48		98
			RG213, RG215, RG8	<a href="#">PE4430</a>	\$19.85		99
			RG214, RG9, RG225, RG393	<a href="#">PE4048</a>	\$22.33		1
			RG223, RG142, RG400, RG55	<a href="#">PE44788</a>	\$18.91		2
			RG58, RG141, RG303, LMR-195, PE-C195, PE-P195, .195 inch	<a href="#">PE4329</a>	\$15.12		3
			RG59*, RG62*, RG71	<a href="#">PE4432</a>	\$19.40		4
			RG8X, PE-C240, .240 inch, B7808A, LMR-240	<a href="#">PE4344</a>	\$15.05		5
			PE-047SR, PE-SR047AL, PE-SR047FL	<a href="#">PE4934</a>	\$37.37		6
			PE-1/4SFHC, SPP-250-LLPL, SPO-250, SPF-250	<a href="#">PE45664</a>	\$13.44		7
	PE-SR401AL, PE-SR401FL, RG401	<a href="#">PE4376</a>	\$50.22	8			
	PE-SR402AL, PE-SR402FL, PE-SR402FLJ, PE-SR402TN, RG402	<a href="#">PE4140</a>	\$27.80	9			
	PE-SR402AL, PE-SR402FL, PE-SR402FLJ, PE-SR402TN, RG402	<a href="#">PE44701</a>	\$21.21	10			
	PE-SR402AL, PE-SR402FL, PE-SR402FLJ, PE-SR402TN, RG402	<a href="#">PE45002</a>	\$38.36	11			
	PE-SR405AL, PE-SR405FL, PE-SR405FLJ, PE-SR405TN, RG405	<a href="#">PE44700</a>	\$20.03	12			
	SPO-500, SPP-500	<a href="#">TC-500-NM-LP</a>	\$9.86	13			
	SPP-250-LLPL	<a href="#">PE45427</a>	\$27.76	14			
	SPP-250-LLPL, SPO-250, SPF-250	<a href="#">TC-250-NM-LP</a>	\$12.32	15			
	SPP-375-LLPL, SPO-375, SPF-375	<a href="#">TC-375-NM-LP</a>	\$12.32	16			
	TFT-402, TFT-402-LF	<a href="#">TC-402-NM-LP</a>	\$14.30	17			
		Threaded	VNA Test Cable	<a href="#">PE45505</a>	\$472.12		18
<b>Male, Bulkhead Mount</b>							
Terminal		Solder	Solder Cup with .350 inch D Hole	<a href="#">PE4490</a>	\$47.10	19	
			Solder Cup with .350 inch D Hole	<a href="#">PE4490BK</a>	\$46.22	20	
			Solder Cup with .640 inch DD Hole	<a href="#">PE4489</a>	\$41.54	21	









Connectors

See Our Website For Current Pricing & Real-Time Stock Availability!

\* Fits MIL-C-17 and equivalent cable versions only



# N Connectors

Connection Method	Product Image	Attachment Cable/Contact	Coax Type / Termination Type	Model No.	PRICE			ROW		
					1 Pc.	See Web for Volume Pricing				
<b>Male, 4 Hole Flange Mount</b>										
Terminal		Solder	Pin with .718 inch Hole Spacing	<a href="#">PE4491</a>	\$36.90			22		
			Pin with .718 inch Hole Spacing	<a href="#">PE44653</a>	\$86.21			23		
			Solder Cup with .718 inch Hole Spacing	<a href="#">PE4131</a>	\$19.12			24		
<b>Male Right Angle</b>										
Cable Connectors		Clamp/Non-Solder Contact	1/2 inch Helical, 1/2 inch Superflexible, PE-1/2 Helical, PE-1/2SFHC	<a href="#">PE44554</a>	\$87.10			25		
				Clamp/Solder	1/2 inch Annular, 1/2 inch Flexible, PE-1/2FAC	<a href="#">PE45358</a>	\$87.55			26
	PE-B400, PE-B405, PE-C400	<a href="#">PE4938</a>			\$28.56			27		
	PE-P142LL	<a href="#">PE44816</a>			\$157.99			28		
	PE-P160LL	<a href="#">PE45448</a>			\$142.68			29		
	PE-P300LL	<a href="#">PE45225</a>			\$158.99			30		
	PE-SR401AL, PE-SR401FL, RG401	<a href="#">PE4935</a>			\$33.12			31		
	RG213, RG8, RG215, RG225, RG214, RG393	<a href="#">PE4136</a>			\$26.84			32		
	RG58, RG55, RG141, RG142, RG223, RG400, RG303, PE-C195, PE-P195, LMR-195	<a href="#">PE4135</a>	\$24.86			33				
		Crimp/Non-Solder Contact	LMR-400, PE-C400, PE-B400, PE-B405	<a href="#">EZ-400-NMH-RA-X</a>	\$29.56			34		
			LMR-600, PE-C600	<a href="#">EZ-600-NMH-RA-X</a>	\$30.80			35		
		Crimp/Solder	LMR-195, PE-C195	<a href="#">TC-195-NMH-RA-D</a>	\$15.25		See Web for Volume Pricing	36		
			PE-C195, PE-P195, RG58, RG141, RG303, LMR-195, .195 inch	<a href="#">PE44524</a>	\$43.11	37				
			PE-C200, LMR-200	<a href="#">PE44844</a>	\$55.81	38				
			PE-C240, RG8X, .240 inch, LMR-240, LMR-240-DB, LMR-240-UF, B7808A	<a href="#">PE44525</a>	\$58.91	39				
			PE-C400, PE-B400, PE-B405, LMR-400, LMR-400-DB, LMR-400-UF, .400 inch	<a href="#">PE44526</a>	\$44.66	40				
			PE-C600, LMR-600, LMR-600-DB, .600 inch	<a href="#">PE44527</a>	\$64.27	41				
			RG174, RG316, RG188, .100 inch, PE-B100, PE-C100, LMR-100	<a href="#">PE44675</a>	\$37.02	42				
			RG213, RG8	<a href="#">PE4482</a>	\$41.82	43				
			RG214, RG9, RG225, RG393	<a href="#">PE4483</a>	\$54.03	44				
			RG55, RG141, RG142, RG223, RG400	<a href="#">PE4484</a>	\$31.09	45				
			RG58	<a href="#">PE4485</a>	\$27.56	46				
				Solder/Solder	LMR-400, PE-C400, PE-B405	<a href="#">TC-400-NMH-RA-D</a>		\$21.56		47
					PE-1/4SFHC, SPP-250-LLPL, SPO-250, SPF-250	<a href="#">PE45665</a>		\$16.24		48
	PE-SR402AL, PE-SR402FL, PE-SR402FLJ, PE-SR402TN, RG402	<a href="#">PE44703</a>			\$26.34		49			
PE-SR402AL, PE-SR402FL, RG402	<a href="#">PE4936</a>	\$39.43				50				
PE-SR405AL, PE-SR405FL, PE-SR405FLJ, RG405	<a href="#">PE4937</a>	\$28.55				51				
PE-SR405AL, PE-SR405FL, PE-SR405FLJ, RG405	<a href="#">PE44702</a>	\$23.94				52				
SPO-250, SPF-250, SPP-250-LLPL	<a href="#">TC-250-NM-RA-LP</a>	\$14.78				53				
SPO-500, SPF-500	<a href="#">TC-SPO500-NM-RA-LP</a>	\$14.78				54				
SPP-250-LLPL	<a href="#">PE45428</a>	\$31.05				55				
TFT-402, TFT-402-LF	<a href="#">TC-402-NM-RA-LP</a>	\$15.95		56						
<b>Female</b>										
Cable Connectors		Clamp/Non-Solder Contact	1/2 inch Helical, 1/2 inch Superflexible, PE-1/2 Helical, PE-1/2SFHC	<a href="#">PE44731</a>	\$50.09			57		
			1/4 inch Superflexible, PE-1/4SFHC	<a href="#">PE44727</a>	\$64.59			58		
			7/8 inch annular	<a href="#">PE45036</a>	\$68.71			59		
			7/8 inch Helical	<a href="#">PE45203</a>	\$55.60			60		
			PE-1/2FAC, 1/2 inch Flexible, 1/2 inch Annular	<a href="#">PE44737</a>	\$48.22			61		
		Clamp/Solder	1/2 inch Annular	<a href="#">PE44565</a>	\$91.17		See Web for Volume Pricing	62		
			PE-B400, PE-B405, PE-C400, LMR-400, .400 inch	<a href="#">PE4372</a>	\$34.79	63				
			PE-C600	<a href="#">PE44350</a>	\$83.12	64				
			PE-P300LL	<a href="#">PE45245</a>	\$111.50	65				
			PE-SR401AL, PE-SR401FL, RG401	<a href="#">PE4439</a>	\$26.85	66				
			PE-SR402AL, PE-SR402FL, RG402	<a href="#">PE4138</a>	\$23.40	67				
			PE-SR405AL, PE-SR405FL, RG405	<a href="#">PE4130</a>	\$20.60	68				
			RG14, RG217	<a href="#">PE4645</a>	\$77.21	69				
			RG17, RG218, RG219	<a href="#">PE4646</a>	\$85.69	70				
			RG174, RG316, RG188	<a href="#">PE4437</a>	\$22.48	71				

\* Fits MIL-C-17 and equivalent cable versions only

Connectors

See Our Website For Current Pricing & Real-Time Stock Availability!

# N Connectors











Connection Method	Product Image	Attachment Cable/Contact	Coax Type / Termination Type	Model No.	PRICE		ROW
					1 Pc.	See Web for Volume Pricing	
<b>Female</b>							
Cable Connectors		Clamp/Solder	RG213, RG214, RG8, RG9, RG11*, RG225, RG393, RG144*, RG216*, RG215	<a href="#">PE4061</a>	\$20.38	See Web for Volume Pricing	72
			RG58, RG55, RG141, RG142, RG223, RG400, RG303, PE-C195, PE-P195, LMR-195	<a href="#">PE4072</a>	\$19.93		73
			RG59*, RG62*, RG71	<a href="#">PE4330</a>	\$20.14		74
		Clamp/Solder (Captive Contact)	RG213, RG214, RG8, RG9, RG11*, RG225, RG393, RG144*, RG216*, RG215	<a href="#">PE4059</a>	\$33.89		75
				Crimp/Crimp	RG55, RG141, RG142, RG223, RG400		<a href="#">PE4134</a>
		Crimp/Non-Solder Contact	LMR-600, PE-C600		<a href="#">EZ-600-NF-X</a>		\$24.64
				Crimp/Solder	LMR-400, PE-C400		<a href="#">TC-400-NF-X</a>
	PE-C195, PE-P195, RG58, RG141, RG303, LMR-195, .195 inch	<a href="#">PE44532</a>			\$18.23		79
	PE-C240, RG8X, .240 inch, LMR-240, LMR-240-DB, LMR-240-UF, B7808A	<a href="#">PE44533</a>			\$19.30		80
	PE-C400, PE-B400, PE-B405, LMR-400, LMR-400-DB, LMR-400-UF, .400 inch	<a href="#">PE44534</a>			\$27.60		81
	PE-C600, LMR-600, LMR-600-DB, .600 inch	<a href="#">PE44535</a>			\$54.94		82
	RG174, RG316, RG188, LMR-100, PE-B100, PE-C100, .100 inch	<a href="#">PE4438</a>			\$26.27		83
	RG188-DS, RG316-DS	<a href="#">PE45172</a>			\$23.94		84
	RG213, RG8	<a href="#">PE4435</a>			\$18.17		85
	RG214, RG9, RG225, RG393	<a href="#">PE4191</a>			\$24.43		86
	RG223, RG142, RG400, RG55	<a href="#">PE44789</a>			\$23.59		87
	RG58	<a href="#">PE4436</a>	\$17.87	88			
		Solder/Solder	PE-047SR, PE-SR047AL, PE-SR047FL	<a href="#">PE4945</a>	\$43.25		89
			PE-1/4SFHC, SPP-250-LLPL, SPO-250, SPF-250	<a href="#">PE45666</a>	\$13.44		90
			PE-SR402AL, PE-SR402FL, PE-SR402FLJ, PE-SR402TN, RG402	<a href="#">PE44705</a>	\$27.88		91
PE-SR402AL, PE-SR402FL, RG402			<a href="#">PE4652</a>	\$51.47	92		
PE-SR405AL, PE-SR405FL, PE-SR405FLJ, RG405			<a href="#">PE4653</a>	\$34.29	93		
PE-SR405AL, PE-SR405FL, PE-SR405FLJ, RG405			<a href="#">PE44704</a>	\$38.15	94		
	Threaded	SPO-375, SPF-375	<a href="#">TC-SPP375-NF-LP</a>	\$13.80	95		
		SPP-250-LLPL	<a href="#">PE45426</a>	\$27.76	96		
PCB Mount		Solder	VNA Test Cable	<a href="#">PE45502</a>	\$421.62	97	
			Thru Hole with .400 inch x .062 inch Hole Spacing	<a href="#">PE44396</a>	\$29.78	98	
<b>Female, Bulkhead Mount</b>							
Cable Connectors		Clamp/Solder	PE-B400, PE-B405, PE-C400 with .640 inch DD Hole	<a href="#">PE4943</a>	\$25.75	See Web for Volume Pricing	99
			PE-P142LL	<a href="#">PE44813</a>	\$106.68		1
			PE-P160LL	<a href="#">PE45447</a>	\$109.39		2
			PE-P300LL	<a href="#">PE44807</a>	\$125.56		3
			PE-SR401AL, PE-SR401FL, RG401 with .640 inch DD Hole	<a href="#">PE4942</a>	\$27.81		4
			PE-SR402AL, PE-SR402FL, RG402 with .640 inch DD Hole	<a href="#">PE4113</a>	\$21.61		5
			PE-SR405AL, PE-SR405FL, RG405, PE-SR405TN with .640 inch DD Hole	<a href="#">PE4443</a>	\$23.40		6
			RG174, RG316, RG188 with .640 inch DD Hole	<a href="#">PE4441</a>	\$24.91		7
			RG178 with .640 inch DD Hole	<a href="#">PE44633</a>	\$24.91		8
			RG188-DS, RG316-DS with .640 inch DD Hole	<a href="#">PE45173</a>	\$22.68		9
			RG214, RG213, RG393, RG8, RG225, RG11*, RG216*, RG144*, RG215, RG9 with .640 inch DD Hole	<a href="#">PE4223</a>	\$28.67		10
			RG58, RG142, RG223, RG400, RG141, RG303, RG55, LMR-400, PE-C195, PE-P195 with .640 inch DD Hole	<a href="#">PE4114</a>	\$23.87		11
RG59*, RG62* with .640 inch DD Hole	<a href="#">PE4297</a>	\$31.57	12				

Connectors

See Our Website For Current Pricing & Real-Time Stock Availability!

\* Fits MIL-C-17 and equivalent cable versions only

# N Connectors





Connection Method	Product Image	Attachment Cable/Contact	Coax Type / Termination Type	Model No.	PRICE				ROW
					1-24	25-49	50-99	100 +	
<b>Female, Bulkhead Mount</b>									
Cable Connectors		Crimp/Crimp	RG55, RG142, RG223, RG400 with .640 inch DD Hole	<a href="#">PE4371</a>	\$23.67	\$22.49	\$21.30	\$20.36	13
			RG58, RG303, RG141, PE-C195, PE-P195, LMR-195, .195 inch with .640 inch DD Hole	<a href="#">PE4440</a>	\$20.05	\$19.05	\$18.05	\$17.24	14
			Crimp/Non-Solder Contact	LMR-400, PE-C400, PE-B400, PE-B405	<a href="#">EZ-400-NF-BH</a>	\$23.00	\$23.00	\$23.00	\$23.00
	LMR-600, PE-C600			<a href="#">EZ-600-NF-BH</a>	\$40.70	\$40.70	\$40.70	\$40.70	16
		Crimp/Solder	.240 inch, RG8X, LMR-240, B7808A, LMR-240-DB, LMR-240-UF, PE-C240 with .640 inch DD Hole	<a href="#">PE44529</a>	\$20.28	\$19.27	\$18.25	\$17.44	17
			.400 inch, LMR-400, LMR-400-DB, LMR-400-UF, PE-B405, PE-C400, PE-B400 with .640 inch DD Hole	<a href="#">PE44530</a>	\$27.50	\$26.13	\$24.75	\$23.65	18
			LMR-200, PE-C200	<a href="#">PE45047</a>	\$25.80	\$24.77	\$23.99	\$23.48	19
			LMR-240, PE-C240	<a href="#">TC-240-NF-BH-X</a>	\$24.02	\$24.02	\$24.02	\$24.02	20
			PE-C195, PE-P195, RG58, RG141, RG303, LMR-195, .195 inch with .640 inch DD Hole	<a href="#">PE44528</a>	\$27.92	\$26.52	\$25.13	\$24.01	21
			PE-C600, LMR-600 with .640 inch DD Hole	<a href="#">PE44531</a>	\$51.12	\$48.56	\$46.01	\$43.96	22
			RG174, RG316, RG188, LMR-100, PE-B100, PE-C100, .100 inch with .640 inch DD Hole	<a href="#">PE4442</a>	\$30.34	\$28.82	\$27.31	\$26.09	23
			RG188-DS, RG316-DS	<a href="#">PE44877</a>	\$32.94	\$31.29	\$29.65	\$28.33	24
			RG213, RG8 with .640 inch DD Hole	<a href="#">PE4940</a>	\$34.41	\$32.69	\$30.97	\$29.59	25
			RG214, RG9, RG225, RG393 with .640 inch DD Hole	<a href="#">PE4941</a>	\$21.44	\$20.37	\$19.30	\$18.44	26
		Solder/Solder	PE-047SR, PE-SR047AL, PE-SR047FL with .640 inch DD Hole	<a href="#">PE4946</a>	\$38.08	\$36.18	\$34.27	\$32.75	27
			PE-1/4SFHC, SPP-250-LLPL, SPO-250, SPF-250	<a href="#">PE45667</a>	\$13.44	\$12.77	\$12.10	\$11.56	28
			PE-SR402AL, PE-SR402FL, PE-SR402FLJ, PE-SR402TN, RG402 with .640 inch DD Hole	<a href="#">PE44707</a>	\$24.59	\$23.36	\$22.13	\$21.15	29
			PE-SR402AL, PE-SR402FL, PE-SR402FLJ, PE-SR402TN, RG402 with .640 inch DD Hole	<a href="#">PE4654</a>	\$42.05	\$39.95	\$37.85	\$36.16	30
			PE-SR405AL, PE-SR405FL, PE-SR405FLJ, PE-SR405TN, RG405	<a href="#">PE44706</a>	\$26.34	\$25.02	\$23.71	\$22.65	31
			PE-SR405AL, PE-SR405FL, RG405 with .640 inch DD Hole	<a href="#">PE4655</a>	\$39.02	\$37.07	\$35.12	\$33.56	32
SPP-250-LLPL			<a href="#">TC-SPP250-NF-BH-LP</a>	\$12.32	\$12.32	\$12.32	\$12.32	33	
TFT-402, TFT-402-LF			<a href="#">TC-402-NF-BH-LP</a>	\$14.30	\$14.30	\$14.30	\$14.30	34	
PCB Mount		Solder	End Launch with .630 inch Diameter	<a href="#">PE44615</a>	\$34.80	\$33.06	\$31.32	\$29.93	35
			Thru Hole with .640 inch DD Hole	<a href="#">PE44397</a>	\$53.01	\$50.36	\$47.71	\$45.59	36
Terminal		Solder	Pin with .640 inch DD Hole	<a href="#">PE4139</a>	\$23.64	\$22.46	\$21.28	\$20.33	37
			Solder Cup with .380 inch Diameter	<a href="#">PE4488</a>	\$16.32	\$15.50	\$14.69	\$14.04	38
			Solder Cup with .640 inch DD Hole	<a href="#">PE4137</a>	\$34.71	\$32.97	\$31.24	\$29.85	39
<b>Female, 2 Hole Flange Mount</b>									
Terminal		Solder	Pin with 1.0 inch Hole Spacing	<a href="#">PE44079</a>	\$53.57	\$50.89	\$48.21	\$46.07	40
			Solder Cup with 1.0 inch Hole Spacing	<a href="#">PE44077</a>	\$31.71	\$30.12	\$28.54	\$27.27	41
<b>Female, 4 Hole Flange Mount</b>									
Cable Connectors		Clamp/Solder	PE-SR401AL, PE-SR401FL, RG401 with .718 inch Hole Spacing	<a href="#">PE44071</a>	\$27.56	\$26.18	\$24.80	\$23.70	42
			PE-SR402AL, PE-SR402FL, PE-SR402FLJ, PE-SR402TN, RG402 with .718 inch Hole Spacing	<a href="#">PE44072</a>	\$27.81	\$26.42	\$25.03	\$23.92	43
			PE-SR405AL, PE-SR405FL, RG405 with .718 inch Hole Spacing	<a href="#">PE44073</a>	\$27.37	\$26.00	\$24.63	\$23.54	44
			RG174, RG316, RG188 with .718 inch Hole Spacing	<a href="#">PE44070</a>	\$21.39	\$20.32	\$19.25	\$18.40	45
			RG58, RG142, RG223, RG400, RG141, RG303, RG55, LMR-400, PE-C195, PE-P195 with .718 inch Hole Spacing	<a href="#">PE4141</a>	\$21.87	\$20.78	\$19.68	\$18.81	46
		Clamp/Solder (Captive Contact)	RG214, RG213, RG393, RG8, RG225, RG11*, RG216*, RG144*, RG215, RG9 with .718 inch Hole Spacing	<a href="#">PE4060</a>	\$28.93	\$27.48	\$26.04	\$24.88	47
				Crimp/Solder	.195 inch, RG58, RG141, RG303, LMR-195, LMR-195-FR, PE-C195, PE-P195 with .718 inch Hole Spacing	<a href="#">PE44069</a>	\$27.08	\$25.73	\$24.37
	RG213, RG8 with .718 inch Hole Spacing	<a href="#">PE44065</a>			\$25.06	\$23.81	\$22.55	\$21.55	49
	RG214, RG9, RG225, RG393 with .718 inch Hole Spacing	<a href="#">PE44066</a>			\$28.69	\$27.26	\$25.82	\$24.67	50
	RG316, RG174, LMR-100	<a href="#">PE45133</a>			\$23.40	\$22.23	\$21.06	\$20.12	51
			RG55, RG141, RG142, RG223, RG400 with .718 inch Hole Spacing	<a href="#">PE44068</a>	\$27.34	\$25.97	\$24.61	\$23.51	52

\* Fits MIL-C-17 and equivalent cable versions only



Connectors

See Our Website For Current Pricing & Real-Time Stock Availability!

## N Connectors

Connection Method	Product Image	Attachment Cable/Contact	Coax Type / Termination Type	Model No.	PRICE				ROW
					1-24	25-49	50-99	100 +	
<b>Female, 4 Hole Flange Mount</b>									
Terminal		Field Replaceable	Slotted Contact	<a href="#">PE44721</a>	\$35.80	\$34.01	\$32.22	\$30.79	53
			Slotted Contact	<a href="#">PE44722</a>	\$36.83	\$34.99	\$33.15	\$31.67	54
		Solder	Pin with .340 inch Hole Spacing	<a href="#">PE4355</a>	\$24.43	\$23.21	\$21.99	\$21.01	55
			Pin with .500 inch Hole Spacing	<a href="#">PE4444</a>	\$24.66	\$23.43	\$22.19	\$21.21	56
			Pin with .718 inch Hole Spacing	<a href="#">PE4328</a>	\$23.37	\$22.20	\$21.03	\$20.10	57
			Solder Cup	<a href="#">PE45085</a>	\$21.13	\$20.07	\$19.02	\$18.17	58
			Solder Cup with .718 inch Hole Spacing	<a href="#">PE4487</a>	\$62.93	\$59.78	\$56.64	\$54.12	59
Tab with .718 inch Hole Spacing	<a href="#">PE4492</a>	\$35.15	\$33.39	\$31.64	\$30.23	60			
<b>Female, Press-In</b>									
Terminal		Solder	Pin with .500 inch Diameter	<a href="#">PE44074</a>	\$32.55	\$30.92	\$29.30	\$27.99	61
			Solder Cup with .500 inch Diameter	<a href="#">PE44076</a>	\$20.22	\$19.21	\$18.20	\$17.39	62
			Tab with .500 inch Diameter	<a href="#">PE44075</a>	\$21.05	\$20.00	\$18.95	\$18.10	63
<b>Female Right Angle, Bulkhead Mount</b>									
PCB Mount		Solder	Thru Hole with .596 inch D Hole	<a href="#">PE44398</a>	\$30.73	\$29.19	\$27.66	\$26.43	64
<b>Female Right Angle, 4 Hole Flange Mount</b>									
Terminal		Solder	Solder Cup with .718 inch Hole Spacing	<a href="#">PE4486</a>	\$51.73	\$49.14	\$46.56	\$44.49	65

## Reverse Polarity N Connectors

Connection Method	Product Image	Attachment Cable/Contact	Coax Type / Termination Type	Model No.	PRICE				ROW
					1-24	25-49	50-99	100 +	
<b>Male</b>									
Cable Connectors		Crimp/Solder	PE-C400, PE-B400, PE-B405, LMR-400, LMR-400-DB, LMR-400-UF, .400 inch	<a href="#">PE44470</a>	\$39.06	\$37.11	\$35.15	\$33.59	66
			RG213, RG8, RG215	<a href="#">PE44472</a>	\$38.65	\$36.72	\$34.79	\$33.24	67
			RG214, RG393	<a href="#">PE44474</a>	\$32.09	\$30.49	\$28.88	\$27.60	68
<b>Female</b>									
Cable Connectors		Crimp/Solder	RG213, RG8	<a href="#">PE44478</a>	\$27.86	\$26.47	\$25.07	\$23.96	69
			RG214, RG9, RG225, RG393	<a href="#">PE44477</a>	\$33.81	\$32.12	\$30.43	\$29.08	70
			RG55, RG141, RG142, RG223, RG400	<a href="#">PE44475</a>	\$31.30	\$29.74	\$28.17	\$26.92	71
			RG58	<a href="#">PE44476</a>	\$34.45	\$32.73	\$31.01	\$29.63	72

## N, 7mm, SC Torque Wrenches



Type	Bit Hex Size (in.)	Preset Torque (in.-lbs.)	Model No	1-9	10-24	25-49	50+	ROW
N, 7mm, SC	20 mm	14 in.-lbs	<a href="#">PE5011-7</a>	\$318.02	\$305.30	\$295.76	\$289.40	
		8.1 in.-lbs	<a href="#">PE5019-5</a>	\$242.40	\$230.28	\$218.16	\$208.46	
	3/4 inch	14 in.-lbs	<a href="#">PE5019-4</a>	\$240.14	\$228.13	\$216.13	\$206.52	
		13/16 inch	14 in.-lbs	<a href="#">PE5019-8</a>	\$240.14	\$228.13	\$216.13	\$206.52

\* Fits MIL-C-17 and equivalent cable versions only



Technical Support  
+1 (949) 261-1920



Same-Day Shipping,  
Even Custom  
Cable Assemblies

Connectors

See Our Website For Current Pricing & Real-Time Stock Availability!



## NEX10 Connectors

Connection Method	Product Image	Attachment Cable/Contact	Coax Type / Termination Type	Model No.	PRICE				ROW
					1-24	25-49	50-99	100 +	
<b>Male</b>									
Cable Connectors		Solder/Solder	PE-1/4SFHC, SPP-250-LLPL, SPO-250, SPF-250	<a href="#">PE45672</a>	\$22.40	\$21.28	\$20.16	\$19.26	73
			PE-1/4SFHC, SPP-250-LLPL, SPO-250, SPF-250	<a href="#">PE45668</a>	\$18.48	\$17.56	\$16.63	\$15.89	74
			TFT-402, TFT-402-LF	<a href="#">TC-402-NX10M-LP</a>	\$20.79	\$20.79	\$20.79	\$20.79	75
<b>Male Right Angle</b>									
Cable Connectors		Solder/Solder	PE-1/4SFHC, SPP-250-LLPL, SPO-250, SPF-250	<a href="#">PE45669</a>	\$24.08	\$22.88	\$21.67	\$20.71	76
			TFT-402, TFT-402-LF	<a href="#">TC-402-NX10M-RA-LP</a>	\$25.30	\$25.30	\$25.30	\$25.30	77
<b>Female</b>									
Cable Connectors		Solder/Solder	PE-1/4SFHC, SPP-250-LLPL, SPO-250, SPF-250	<a href="#">PE45670</a>	\$15.12	\$14.36	\$13.61	\$13.00	78
<b>Female, Bulkhead Mount</b>									
Cable Connectors		Solder/Solder	PE-1/4SFHC, SPP-250-LLPL, SPO-250, SPF-250	<a href="#">PE45671</a>	\$17.92	\$17.02	\$16.13	\$15.41	79

## NMO Mount Connectors

Connection Method	Product Image	Attachment Cable/Contact	Coax Type / Termination Type	Model No.	PRICE				ROW
					1-24	25-49	50-99	100 +	
<b>Sexless</b>									
Cable Connectors		Crimp/Solder	PE-C195, PE-P195, RG58, RG55, RG141, RG142, RG223, RG400, RG303, LMR-195	<a href="#">PE51021</a>	\$17.06	\$16.21	\$15.35	\$14.67	80
			RG58, LMR-195	<a href="#">PE51167</a>	\$25.35	\$24.08	\$22.82	\$21.80	81

## QMA Connectors





Connection Method	Product Image	Attachment Cable/Contact	Coax Type / Termination Type	Model No.	PRICE				ROW
					1-24	25-49	50-99	100 +	
<b>Male</b>									
Cable Connectors		Crimp/Solder	LMR-200, PE-C200	<a href="#">PE45224</a>	\$16.40	\$15.58	\$14.76	\$14.10	82
			PE-C195, PE-P195, RG58, RG141, RG303, LMR-195, .195 inch	<a href="#">PE44503</a>	\$23.60	\$22.42	\$21.24	\$20.30	83
			RG174, RG316, RG188, .100 inch, PE-B100, PE-C100, LMR-100	<a href="#">PE44501</a>	\$32.09	\$30.49	\$28.88	\$27.60	84
			RG55, RG142, RG223, RG400	<a href="#">PE44514</a>	\$22.57	\$21.44	\$20.31	\$19.41	85
		Solder/Non-Solder Contact	PE-SR402AL, PE-SR402FL, PE-SR402FLJ, PE-SR402TN, RG402	<a href="#">PE44496</a>	\$50.28	\$47.77	\$45.25	\$43.24	86
				Solder/Solder	PE-1/4SFHC, SPP-250-LLPL, SPO-250, SPF-250	<a href="#">PE45682</a>	\$11.02	\$10.47	\$9.92
PE-SR405AL, PE-SR405FL, RG405	<a href="#">PE44495</a>	\$24.71			\$23.47	\$22.24	\$21.25	88	
SPP-250-LLPL	<a href="#">PE45430</a>	\$23.35			\$22.18	\$21.02	\$20.08	89	
TFT-402, TFT-402-LF	<a href="#">TC-402-QM-LP</a>	\$10.63	\$10.63	\$10.63	\$10.63	90			
<b>Male Right Angle</b>									
Cable Connectors		Crimp/Non-Solder Contact	LMR-240, PE-C240, LMR-240-UF	<a href="#">EZ-240-QM-RA-X</a>	\$19.50	\$19.50	\$19.50	\$19.50	91
				Crimp/Solder	PE-C195, PE-P195, RG58, RG141, RG303, LMR-195, .195 inch	<a href="#">PE44506</a>	\$31.30	\$29.74	\$28.17
	RG174, RG316, RG188	<a href="#">PE45284</a>			\$26.46	\$25.14	\$23.81	\$22.76	93
	RG316-DS, RG188-DS	<a href="#">PE44505</a>			\$34.32	\$32.60	\$30.89	\$29.52	94
	RG55, RG142, RG223, RG400	<a href="#">PE44515</a>			\$32.91	\$31.26	\$29.62	\$28.30	95
		Solder/Solder	PE-1/4SFHC, SPP-250-LLPL, SPO-250, SPF-250	<a href="#">PE45683</a>	\$15.12	\$14.36	\$13.61	\$13.00	96
			PE-SR402AL, PE-SR402FL, PE-SR402FLJ, PE-SR402TN, RG402	<a href="#">PE44498</a>	\$29.59	\$28.11	\$26.63	\$25.45	97
			PE-SR405AL, PE-SR405FL, RG405	<a href="#">PE44497</a>	\$27.83	\$26.44	\$25.05	\$23.93	98
			SPP-250-LLPL	<a href="#">PE45431</a>	\$25.69	\$24.41	\$23.12	\$22.09	99
	TFT-402, TFT-402-LF	<a href="#">TC-402-QM-RA-LP</a>	\$15.95	\$15.95	\$15.95	\$15.95	1		

\* Fits MIL-C-17 and equivalent cable versions only







Connectors

See Our Website For Current Pricing & Real-Time Stock Availability!

## QMA Connectors

Connection Method	Product Image	Attachment Cable/Contact	Coax Type / Termination Type	Model No.	PRICE				ROW
					1-24	25-49	50-99	100 +	
<b>Female</b>									
Cable Connectors		Solder/Solder	PE-1/4SFHC, SPP-250-LLPL, SPO-250, SPF-250	<a href="#">PE45684</a>	\$10.83	\$10.29	\$9.75	\$9.31	2
			SPP-250-LLPL	<a href="#">PE45429</a>	\$19.47	\$18.50	\$17.52	\$16.74	3
PCB Mount		Solder	Surface Mount	<a href="#">PE44510</a>	\$26.26	\$24.95	\$23.63	\$22.58	4
			Thru Hole	<a href="#">PE44512</a>	\$17.12	\$16.26	\$15.41	\$14.72	5
<b>Female, Bulkhead Mount</b>									
Cable Connectors		Crimp/Solder	RG174, RG316, RG188, .100 inch, PE-B100, PE-C100, LMR-100 with .268 inch D Hole	<a href="#">PE44507</a>	\$26.75	\$25.41	\$24.08	\$23.01	6
			RG316-DS, RG188-DS with .268 inch D Hole	<a href="#">PE44508</a>	\$20.79	\$19.75	\$18.71	\$17.88	7
		Solder/Solder	PE-1/4SFHC, SPP-250-LLPL, SPO-250, SPF-250	<a href="#">PE45685</a>	\$13.44	\$12.77	\$12.10	\$11.56	8
			PE-SR402AL, PE-SR402FL, PE-SR402FLJ, PE-SR402TN, RG402 with .268 inch D Hole	<a href="#">PE44500</a>	\$24.34	\$23.12	\$21.91	\$20.93	9
			PE-SR405AL, PE-SR405FL, RG405 with .268 inch D Hole	<a href="#">PE45218</a>	\$31.84	\$30.25	\$28.66	\$27.38	10
<b>Female Right Angle</b>									
PCB Mount		Solder	Surface Mount	<a href="#">PE44511</a>	\$16.58	\$15.92	\$15.42	\$15.09	11

## QN Connectors

Connection Method	Product Image	Attachment Cable/Contact	Coax Type / Termination Type	Model No.	PRICE				ROW
					1-24	25-49	50-99	100 +	
<b>Male</b>									
Cable Connectors		Crimp/Solder	LMR-240, PE-C240	<a href="#">PE45222</a>	\$33.54	\$32.20	\$31.19	\$30.52	12
			RG213, RG215	<a href="#">PE44597</a>	\$76.89	\$73.81	\$71.51	\$69.97	13
			RG55, RG141, RG142, RG223, RG400	<a href="#">PE44978</a>	\$31.49	\$29.92	\$28.34	\$27.08	14
			RG58, RG303, RG141, PE-C195, PE-P195, LMR-195	<a href="#">PE45071</a>	\$28.30	\$27.17	\$26.32	\$25.75	15
		Solder/Solder	PE-SR402AL, PE-SR402FL, RG402	<a href="#">PE44599</a>	\$39.39	\$37.42	\$35.45	\$33.88	16
<b>Male Right Angle</b>									
Cable Connectors		Crimp/Solder	LMR-400, PE-C400, LMR-400-DB	<a href="#">PE45223</a>	\$54.37	\$51.65	\$48.93	\$46.76	17
			PE-C195, PE-P195, RG58, RG141, RG303, LMR-195, .195 inch	<a href="#">PE44601</a>	\$45.97	\$43.67	\$41.37	\$39.53	18
			RG214, RG225	<a href="#">PE44603</a>	\$47.33	\$44.96	\$42.60	\$40.70	19
			RG55, RG141, RG142, RG223, RG400	<a href="#">PE44600</a>	\$48.66	\$46.23	\$43.79	\$41.85	20
		Solder/Solder	PE-SR402AL, PE-SR402FL, PE-SR402FLJ, PE-SR402TN, RG402	<a href="#">PE44604</a>	\$45.81	\$43.52	\$41.23	\$39.40	21
<b>Female, Bulkhead Mount</b>									
Cable Connectors		Crimp/Solder	RG213, RG215 with .500 inch Diameter	<a href="#">PE44607</a>	\$51.69	\$49.11	\$46.52	\$44.45	22
			RG214, RG225 with .500 inch Diameter	<a href="#">PE44608</a>	\$103.37	\$99.24	\$96.13	\$94.07	23
<b>Female, 4 Hole Flange Mount</b>									
Terminal		Solder	Solder Cup	<a href="#">PE44610</a>	\$73.22	\$69.56	\$65.90	\$62.97	24





## SC Connectors

Connection Method	Product Image	Attachment Cable/Contact	Coax Type / Termination Type	Model No.	PRICE				ROW
					1-9	10-24	25-49	50+	
<b>Male</b>									
Cable Connectors		Clamp/Solder	RG213, RG214, RG8, RG9, RG225, RG393, RG215	<a href="#">PE4520</a>	\$188.79	\$179.35	\$169.91	\$162.36	25
			RG55, RG58, RG141, RG142, RG223, RG303, RG400, PE-C195, PE-P195, LMR-195	<a href="#">PE45479</a>	\$133.55	\$126.87	\$120.20	\$114.85	26







\* Fits MIL-C-17 and equivalent cable versions only



## SC Connectors

Connection Method	Product Image	Attachment Cable/Contact	Coax Type / Termination Type	Model No.	PRICE				ROW
					1 Pc.	See Web for Volume Pricing			
<b>Male</b>									
Cable Connectors		Crimp/Solder	RG214, RG9, RG225, RG393	<a href="#">PE4232</a>	\$66.95	See Web for Volume Pricing			27
			RG55, RG141, RG142, RG223, RG400	<a href="#">PE4231</a>	\$136.09				28
<b>Male Right Angle</b>									
Cable Connectors		Clamp/Solder	RG213, RG214, RG8, RG9, RG225, RG393, RG215	<a href="#">PE4979</a>	\$182.21				29
			RG58, RG55, RG141, RG142, RG223, RG400	<a href="#">PE4978</a>	\$152.60				30
<b>Female, Bulkhead Mount</b>									
Terminal		Solder	Eyelet with .655 inch D Hole	<a href="#">PE4980</a>	\$40.20	See Web for Volume Pricing			31
<b>Female, 4 Hole Flange Mount</b>									
Terminal		Solder	Solder Cup with .718 inch Hole Spacing	<a href="#">PE4322</a>	\$45.95				32

## SHV Connectors

Connection Method	Product Image	Attachment Cable/Contact	Coax Type / Termination Type	Model No.	PRICE				ROW
					1-24	25-49	50-99	100 +	
<b>Plug</b>									
Cable Connectors		Clamp/Solder	RG174, RG316, RG188, LMR-100, PE-B100, PE-C100, .100 inch	<a href="#">PE4498</a>	\$42.23	\$40.12	\$38.01	\$36.32	33
			RG58, RG55, RG141, RG142, RG223, RG400, RG303, PE-C195, PE-P195, LMR-195	<a href="#">PE4316</a>	\$29.26	\$27.80	\$26.33	\$25.16	34
			RG59*, RG62*, RG71	<a href="#">PE4100</a>	\$27.41	\$26.04	\$24.67	\$23.57	35
			RG8, RG213, RG214	<a href="#">PE4333</a>	\$42.58	\$40.45	\$38.32	\$36.62	36
		Crimp/Solder	RG213, RG8	<a href="#">PE4496</a>	\$39.27	\$37.31	\$35.34	\$33.77	37
			RG214, RG9, RG225, RG393	<a href="#">PE4349</a>	\$44.74	\$42.50	\$40.27	\$38.48	38
			RG55, RG142, RG223, RG400	<a href="#">PE4497</a>	\$39.63	\$37.65	\$35.67	\$34.08	39
			RG58, RG303, RG141, PE-C195, PE-P195, LMR-195, .195 inch	<a href="#">PE4194</a>	\$50.24	\$47.73	\$45.22	\$43.21	40
			RG59*, RG62*, RG71	<a href="#">PE4343</a>	\$44.89	\$42.65	\$40.40	\$38.61	41
<b>Plug, Bulkhead Mount</b>									
Terminal		Solder	Solder Cup with .350 inch D Hole	<a href="#">PE44118</a>	\$54.41	\$51.69	\$48.97	\$46.79	42
<b>Jack, Bulkhead Mount</b>									
Cable Connectors		Clamp/Solder	RG174, RG316, RG188 with .480 inch D Hole	<a href="#">PE45556</a>	\$55.04	\$52.29	\$49.54	\$47.33	43
			RG213, RG214, RG8, RG9, RG225, RG393, RG215 with .480 inch D Hole	<a href="#">PE44049</a>	\$70.81	\$67.27	\$63.73	\$60.90	44
			RG58, RG142, RG223, RG400, RG141, RG303, RG55, LMR-400, PE-C195, PE-P195 with .480 inch D Hole	<a href="#">PE44080</a>	\$54.04	\$51.34	\$48.64	\$46.47	45
			RG59*, RG62*, RG71 with .480 inch D Hole	<a href="#">PE4315</a>	\$54.04	\$51.34	\$48.64	\$46.47	46
Terminal		Solder	Solder Cup with .350 inch D Hole	<a href="#">PE4239</a>	\$25.80	\$24.51	\$23.22	\$22.19	47
			Solder Cup with .350 inch D Hole	<a href="#">PE4500</a>	\$72.04	\$68.44	\$64.84	\$61.95	48
			Solder Cup with .480 inch D Hole	<a href="#">PE4499</a>	\$36.07	\$34.27	\$32.46	\$31.02	49
<b>Jack, 4 Hole Flange Mount</b>									
Terminal		Solder	Solder Cup with .500 inch Hole Spacing	<a href="#">PE4501</a>	\$41.25	\$39.19	\$37.13	\$35.48	50

\* Fits MIL-C-17 and equivalent cable versions only

Connectors

See Our Website For Current Pricing & Real-Time Stock Availability!

# SMA Connectors

Connection Method	Product Image	Attachment Cable/Contact	Coax Type / Termination Type	Model No.	PRICE				ROW
					1-24	25-49	50-99	100 +	
	<b>Male</b>								
PCB Mount		Clamp	Vertical Launch	<a href="#">PE45460</a>	\$41.00	\$38.95	\$36.90	\$35.26	51
			Vertical Launch	<a href="#">PE45461</a>	\$43.42	\$41.68	\$40.38	\$39.51	52
Cable Connectors		Clamp/Solder	PE-P142LL	<a href="#">PE44826</a>	\$43.17	\$41.01	\$38.85	\$37.13	53
			PE-P160LL	<a href="#">PE45440</a>	\$85.22	\$80.96	\$76.70	\$73.29	54
			PE-P300LL	<a href="#">PE44808</a>	\$67.04	\$63.69	\$60.34	\$57.65	55
			PE-P300LL	<a href="#">PE45042</a>	\$70.35	\$70.35	\$70.35	\$70.35	56
			PE-SR401AL, PE-SR401FL, RG401	<a href="#">PE4403</a>	\$47.04	\$44.69	\$42.34	\$40.45	57
			RG174, RG316, RG188, PE-B100, PE-C100, .100 inch, LMR-100	<a href="#">PE4026</a>	\$32.40	\$30.78	\$29.16	\$27.86	58
			RG178, RG196	<a href="#">PE4214</a>	\$58.74	\$55.80	\$52.87	\$50.52	59
			RG180, RG195, PE-B150	<a href="#">PE4399</a>	\$26.62	\$25.29	\$23.96	\$22.89	60
			RG188-DS, RG316-DS	<a href="#">PE4400</a>	\$34.60	\$32.87	\$31.14	\$29.76	61
			RG213, RG214, RG8, RG9, RG11*, RG225, RG393, RG144*, RG216*, RG215	<a href="#">PE4332</a>	\$92.20	\$87.59	\$82.98	\$79.29	62
			RG316, RG174, LMR-100	<a href="#">PE45142</a>	\$16.67	\$15.84	\$15.00	\$14.34	63
			RG55, RG58, RG141, RG142, RG223, RG303, RG400, PE-C195, PE-P195, LMR-195	<a href="#">PE4027</a>	\$31.32	\$29.75	\$28.19	\$26.94	64
			RG58, RG303, LMR-195, PE-P195	<a href="#">PE45140</a>	\$26.24	\$24.93	\$23.62	\$22.57	65
		Crimp/Crimp	RG174, RG316, RG188, LMR-100, PE-B100, PE-C100, .100 inch	<a href="#">PE4003</a>	\$12.43	\$11.81	\$11.19	\$10.69	66
			Crimp/Non-Solder Contact	LMR-240, PE-C240	<a href="#">EZ-240-SM-X</a>	\$10.17	\$10.17	\$10.17	\$10.17
		Crimp/Solder	LMR-195, PE-C195	<a href="#">TC-195-SM-SS-X</a>	\$15.25	\$15.25	\$15.25	\$15.25	68
			LMR-200, PE-C200	<a href="#">TC-200-SM-SS-X</a>	\$14.00	\$14.00	\$14.00	\$14.00	69
			LMR-200, PE-C200	<a href="#">PE45040</a>	\$8.60	\$8.26	\$8.00	\$7.83	70
			LMR-240, PE-C240, LMR-240-UF	<a href="#">TC-240-SM-SS-X</a>	\$10.71	\$10.71	\$10.71	\$10.71	71
			LMR-400, PE-C400	<a href="#">TC-400-SM-X</a>	\$14.78	\$14.78	\$14.78	\$14.78	72
			PE-B150, RG180, RG195	<a href="#">PE4578</a>	\$27.75	\$26.36	\$24.98	\$23.87	73
			PE-C195, PE-P195, RG58, RG141, RG303, LMR-195, .195 inch	<a href="#">PE44460</a>	\$83.53	\$80.19	\$77.68	\$76.01	74
			PE-C240, RG8X, .240 inch, LMR-240, LMR-240-DB, LMR-240-UF, B7808A	<a href="#">PE44637</a>	\$19.92	\$18.92	\$17.93	\$17.13	75
			PE-C400, PE-B400, PE-B405, LMR-400, LMR-400-DB, LMR-400-UF, .400 inch	<a href="#">PE44668</a>	\$31.83	\$30.24	\$28.65	\$27.37	76
			PE-P195	<a href="#">PE44203</a>	\$19.99	\$18.99	\$17.99	\$17.19	77
			RG142, RG223, RG400, RG55	<a href="#">PE44461</a>	\$67.13	\$64.44	\$62.43	\$61.09	78
			RG174, RG316, RG188	<a href="#">PE45145</a>	\$13.32	\$12.65	\$11.99	\$11.46	79
			RG178, RG196	<a href="#">PE4398</a>	\$22.43	\$21.31	\$20.19	\$19.29	80
			RG188-DS, RG316-DS	<a href="#">PE4401</a>	\$6.88	\$6.54	\$6.19	\$5.92	81
			RG55, RG142, RG223, RG400, RG141	<a href="#">PE4008</a>	\$14.24	\$13.53	\$12.82	\$12.25	82
			RG58, RG303, RG141, PE-C195, PE-P195, LMR-195, .195 inch	<a href="#">PE4215</a>	\$13.76	\$13.07	\$12.38	\$11.83	83
			RG59*, RG62*, RG71	<a href="#">PE4294</a>	\$28.93	\$27.48	\$26.04	\$24.88	84
				Crimp/Solder (Captive Contact)	RG174, RG316, RG188, LMR-100, PE-B100, PE-C100, .100 inch	<a href="#">PE4589</a>	\$21.18	\$20.12	\$19.06
	RG55, RG141, RG142, RG223, RG400	<a href="#">PE4576</a>	\$32.08		\$30.48	\$28.87	\$27.59	86	
	RG58	<a href="#">PE4577</a>	\$27.15		\$25.79	\$24.44	\$23.35	87	
	Solder	PE-SR402AL, PE-SR402FL, PE-SR402FLJ, PE-SR402TN, RG402	<a href="#">PE44691</a>	\$10.15	\$9.64	\$9.14	\$8.73	88	
RG405, RG405 Tinned		<a href="#">PE45481</a>	\$42.95	\$40.80	\$38.66	\$36.94	89		
RG405, RG405 Tinned, PE-SR405AL, PE-SR405FL, PE-SR405FLJ, PE-SR405TN		<a href="#">PE45480</a>	\$42.95	\$40.80	\$38.66	\$36.94	90		
	Solder (Without Contact)	PE-SR402AL, PE-SR402FL, PE-SR402FLJ, PE-SR402TN, RG402	<a href="#">PE4007</a>	\$11.80	\$11.21	\$10.62	\$10.15	91	
	Solder/Solder	PE-020SR	<a href="#">PE4918</a>	\$50.69	\$48.16	\$45.62	\$43.59	92	
		PE-034SR	<a href="#">PE4917</a>	\$88.35	\$83.93	\$79.52	\$75.98	93	
		PE-047SR, PE-SR047AL, PE-SR047FL	<a href="#">PE44757</a>	\$38.79	\$36.07	\$33.36	\$31.03	94	
		PE-047SR, PE-SR047AL, PE-SR047FL	<a href="#">PE4404</a>	\$32.70	\$31.07	\$29.43	\$28.12	95	
		PE-1/4SFHC, SPP-250-LLPL, SPO-250, SPF-250	<a href="#">PE45678</a>	\$7.98	\$7.58	\$7.18	\$6.86	96	
		PE-SR401AL, PE-SR401FL, RG401	<a href="#">PE4907</a>	\$48.96	\$46.51	\$44.06	\$42.11	97	

Connectors

See Our Website For Current Pricing & Real-Time Stock Availability!











\* Fits MIL-C-17 and equivalent cable versions only

Technical Support  
+1 (949) 261-1920

Same-Day Shipping,  
Even Custom Cable Assemblies



# SMA Connectors



Connection Method	Product Image	Attachment Cable/Contact	Coax Type / Termination Type	Model No.	PRICE			ROW	
					1 Pc.	See Web for Volume Pricing			
<b>Male</b>									
Cable Connectors		Solder/Solder	PE-SR402AL, PE-SR402FL, PE-SR402FLJ, PE-SR402TN, RG402	<a href="#">PE4112</a>	\$12.20	See Web for Volume Pricing			98
			PE-SR405AL, PE-SR405FL, PE-SR405FLJ, PE-SR405TN, RG405	<a href="#">PE44690</a>	\$11.42				99
			PE-SR405AL, PE-SR405FL, RG405	<a href="#">PE4005</a>	\$9.07				1
			RG174, RG316, RG188, LMR-100, PE-B100, PE-C100, .100 inch	<a href="#">PE4036</a>	\$16.48				2
			RG178, RG196	<a href="#">PE4213</a>	\$21.12				3
			RG188-DS, RG316-DS	<a href="#">PE4402</a>	\$19.11				4
			RG405, PE-SR405FL, PE-SR405FLJ	<a href="#">PE45135</a>	\$10.64				5
			RG58, RG55, RG142, RG223, RG400	<a href="#">PE4037</a>	\$17.63				6
			SPP-250-LLPL	<a href="#">PE45543</a>	\$16.02				7
			TFT-402, TFT-402-LF	<a href="#">TC-402-SM-LP</a>	\$7.98				8
PCB Mount		Solder	RG174, RG316, RG188	<a href="#">PE4590</a>	\$19.38				9
			RG58, RG55, RG142, RG223, RG400	<a href="#">PE4587</a>	\$24.58				10
Terminal		Solder	.042 inch End Launch	<a href="#">PE44210</a>	\$37.56				11
			.062 inch End Launch	<a href="#">PE4913</a>	\$36.91				12
			.062 inch End Launch	<a href="#">PE4912</a>	\$35.55				13
			Thru Hole with .200 inch x .067 inch Hole Spacing	<a href="#">PE4525</a>	\$24.96				14
<b>Male, Bulkhead Mount</b>									
Terminal		Solder	Solder Cup with .235 inch D Hole	<a href="#">PE4354</a>	\$23.10				15
			Stub with .250 inch Diameter	<a href="#">PE4531</a>	\$44.48				16
<b>Male, 2 Hole Flange Mount</b>									
Field Replaceable		Field Replaceable	.036 inch Pin	<a href="#">PE44032</a>	\$21.34	See Web for Volume Pricing			17
Terminal		Solder	Solder Cup	<a href="#">PE45139</a>	\$11.56				18
			Solder Cup with .481 inch Hole Spacing	<a href="#">PE4125</a>	\$33.13				19
			Stub with .481 inch Hole Spacing	<a href="#">PE4127</a>	\$16.61				20
<b>Male, 4 Hole Flange Mount</b>									
Field Replaceable		Field Replaceable	.012 inch Pin	<a href="#">PE44018</a>	\$30.37				21
			.012 inch Pin	<a href="#">PE44005</a>	\$41.13				22
			.015 inch Pin	<a href="#">PE44019</a>	\$50.34				23
			.018 inch Pin	<a href="#">PE44007</a>	\$26.24				24
			.020 inch Pin	<a href="#">PE44008</a>	\$43.55				25
			.020 inch Pin	<a href="#">PE44021</a>	\$27.27				26
			.036 inch Pin	<a href="#">PE44009</a>	\$26.75				27
Terminal		Solder	Pin with .340 inch Hole Spacing	<a href="#">PE4541</a>	\$59.29				28
			Solder Cup with .340 inch Hole Spacing	<a href="#">PE45204</a>	\$55.89				29
			Stub with .340 inch Hole Spacing	<a href="#">PE4126</a>	\$32.56				30
<b>Male Right Angle</b>									
Cable Connectors		Clamp/Solder	PE-P142LL	<a href="#">PE44817</a>	\$133.42	See Web for Volume Pricing			31
			PE-P160LL	<a href="#">PE45442</a>	\$120.49				32
			PE-P300LL	<a href="#">PE45041</a>	\$134.77				33
			PE-SR402AL, PE-SR402FL, PE-SR402FLJ, PE-SR402TN, RG402	<a href="#">PE44996</a>	\$105.75				34
			RG174, RG316, RG188, .100 inch, PE-B100, PE-C100, LMR-100	<a href="#">PE4028</a>	\$37.92				35
			RG178, RG196	<a href="#">PE4108</a>	\$23.79				36
			RG180, RG195	<a href="#">PE4579</a>	\$28.26				37
			RG188-DS, RG316-DS	<a href="#">PE4407</a>	\$57.23				38
			RG58, RG55, RG141, RG142, RG223, RG303, RG400, LMR-195, PE-C195	<a href="#">PE45048</a>	\$55.13				39
				Crimp/Non-Solder Contact	LMR-240				<a href="#">EZ-240-SM-RA-X</a>
	Crimp/Solder	PE-B150, RG180, RG195	<a href="#">PE4580</a>	\$27.52	41				
		PE-C200, LMR-200	<a href="#">PE45546</a>	\$25.83	42				
		PE-C240, RG8X, .240 inch, LMR-240, LMR-240-DB, LMR-240-UF, B7808A	<a href="#">PE44638</a>	\$31.57	43				

\* Fits MIL-C-17 and equivalent cable versions only

Connectors

See Our Website For Current Pricing & Real-Time Stock Availability!

# SMA Connectors

Connection Method	Product Image	Attachment Cable/Contact	Coax Type / Termination Type	Model No.	PRICE				ROW
					1-24	25-49	50-99	100 +	
<b>Male Right Angle</b>									
Cable Connectors		Crimp/Solder	RG174, RG316, RG188, LMR-100, PE-B100, PE-C100, .100 inch	<a href="#">PE4009</a>	\$22.97	\$21.82	\$20.67	\$19.75	44
			RG178, RG196	<a href="#">PE4296</a>	\$31.54	\$29.96	\$28.39	\$27.12	45
			RG188-DS, RG316-DS	<a href="#">PE4408</a>	\$21.89	\$20.80	\$19.70	\$18.83	46
			RG316, RG174, RG188	<a href="#">PE45144</a>	\$22.49	\$20.92	\$19.34	\$17.99	47
			RG55, RG142, RG223, RG400, RG141	<a href="#">PE4002</a>	\$21.14	\$20.08	\$19.03	\$18.18	48
			RG58, RG303, RG141, PE-C195, PE-P195, LMR-195, .195 inch	<a href="#">PE4405</a>	\$13.46	\$12.79	\$12.11	\$11.58	49
			RG59*, RG62*, RG71	<a href="#">PE4327</a>	\$39.04	\$37.09	\$35.14	\$33.57	50
			PE-020SR	<a href="#">PE4920</a>	\$73.13	\$69.47	\$65.82	\$62.89	51
			PE-034SR	<a href="#">PE4919</a>	\$65.94	\$62.64	\$59.35	\$56.71	52
			PE-047SR, PE-SR047AL, PE-SR047FL	<a href="#">PE45282</a>	\$66.66	\$63.33	\$59.99	\$57.33	53
	PE-1/4SFHC, SPP-250-LLPL, SPO-250, SPF-250	<a href="#">PE45679</a>	\$9.12	\$8.66	\$8.21	\$7.84	54		
	PE-SR401AL, PE-SR401FL, RG401	<a href="#">PE4932</a>	\$66.99	\$63.64	\$60.29	\$57.61	55		
	PE-SR402AL, PE-SR402FL, PE-SR402FLJ, PE-SR402TN, RG402	<a href="#">PE4083</a>	\$24.71	\$23.47	\$22.24	\$21.25	56		
	PE-SR402AL, PE-SR402FL, PE-SR402FLJ, PE-SR402TN, RG402	<a href="#">PE44693</a>	\$15.57	\$14.79	\$14.01	\$13.39	57		
	PE-SR405AL, PE-SR405FL, PE-SR405FLJ, PE-SR405TN, RG405	<a href="#">PE44692</a>	\$13.86	\$13.17	\$12.47	\$11.92	58		
	PE-SR405AL, PE-SR405FL, RG405	<a href="#">PE4025</a>	\$36.54	\$34.71	\$32.89	\$31.42	59		
	RG178, RG196	<a href="#">PE4406</a>	\$27.37	\$26.00	\$24.63	\$23.54	60		
	RG188-DS, RG316-DS	<a href="#">PE4409</a>	\$27.41	\$26.04	\$24.67	\$23.57	61		
	RG316, RG174, RG188, LMR-100, PE-B100, PE-C100, .100 inch	<a href="#">PE4038</a>	\$22.80	\$21.66	\$20.52	\$19.61	62		
	RG58, RG55, RG142, RG223, RG400	<a href="#">PE4039</a>	\$20.69	\$19.66	\$18.62	\$17.79	63		
SPP-250-LLPL	<a href="#">PE45434</a>	\$17.13	\$16.27	\$15.42	\$14.73	64			
<b>Female</b>									
Cable Connectors		Clamp/Solder	PE-P142LL	<a href="#">PE44814</a>	\$75.48	\$71.71	\$67.93	\$64.91	65
			RG178, RG196	<a href="#">PE4591</a>	\$32.54	\$30.91	\$29.29	\$27.98	66
			RG188-DS, RG316-DS	<a href="#">PE4415</a>	\$36.52	\$34.69	\$32.87	\$31.41	67
			RG213, RG214, RG8, RG9, RG11*, RG225, RG393	<a href="#">PE4411</a>	\$69.11	\$65.65	\$62.20	\$59.43	68
			RG316, RG174, RG188, PE-B100, PE-C100, .100 inch, LMR-100	<a href="#">PE4030</a>	\$37.00	\$35.15	\$33.30	\$31.82	69
			RG55, RG58, RG141, RG142, RG223, RG303, RG400, PE-C195, PE-P195, LMR-195	<a href="#">PE4031</a>	\$49.40	\$46.93	\$44.46	\$42.48	70
			PE-C240, RG8X, .240 inch, LMR-240, LMR-240-DB, LMR-240-UF, B7808A	<a href="#">PE44639</a>	\$27.41	\$26.04	\$24.67	\$23.57	71
			PE-C400, PE-B400, PE-B405, LMR-400, LMR-400-DB, LMR-400-UF, .400 inch	<a href="#">PE44669</a>	\$52.92	\$50.27	\$47.63	\$45.51	72
			RG174, RG316, RG188, .100 inch, PE-B100, PE-C100, LMR-100	<a href="#">PE4414</a>	\$22.67	\$21.54	\$20.40	\$19.50	73
			RG178, RG196	<a href="#">PE4325</a>	\$34.59	\$32.86	\$31.13	\$29.75	74
	RG188-DS, RG316-DS	<a href="#">PE4416</a>	\$22.48	\$21.36	\$20.23	\$19.33	75		
	RG316, RG174, LMR-100, RG188, PE-B100, PE-C100, 0.100 inch	<a href="#">PE45137</a>	\$9.40	\$8.93	\$8.46	\$8.08	76		
	RG55, RG142, RG223	<a href="#">PE4412</a>	\$17.55	\$16.67	\$15.80	\$15.09	77		
	RG58, RG303, RG141, PE-C195, PE-P195, LMR-195	<a href="#">PE4413</a>	\$20.05	\$19.05	\$18.05	\$17.24	78		
	RG59*, RG62*	<a href="#">PE4326</a>	\$31.42	\$29.85	\$28.28	\$27.02	79		
	PE-020SR	<a href="#">PE4922</a>	\$71.82	\$68.23	\$64.64	\$61.77	80		
	PE-034SR	<a href="#">PE4921</a>	\$65.94	\$62.64	\$59.35	\$56.71	81		
	PE-047SR, PE-SR047AL, PE-SR047FL	<a href="#">PE4418</a>	\$38.96	\$37.01	\$35.06	\$33.51	82		
	PE-1/4SFHC, SPP-250-LLPL, SPO-250, SPF-250	<a href="#">PE45680</a>	\$8.55	\$8.12	\$7.70	\$7.35	83		
	PE-SR401AL, PE-SR401FL, RG401	<a href="#">PE4930</a>	\$33.24	\$31.58	\$29.92	\$28.59	84		
PE-SR402AL, PE-SR402FL, PE-SR402FLJ, PE-SR402TN, RG402	<a href="#">PE4115</a>	\$20.13	\$19.12	\$18.12	\$17.31	85			
PE-SR402AL, PE-SR402FL, PE-SR402FLJ, PE-SR402TN, RG402	<a href="#">PE44695</a>	\$13.85	\$13.16	\$12.47	\$11.91	86			
PE-SR405AL, PE-SR405FL, PE-SR405FLJ, PE-SR405TN, RG405	<a href="#">PE44694</a>	\$9.72	\$9.23	\$8.75	\$8.36	87			
PE-SR405AL, PE-SR405FL, PE-SR405FLJ, RG405	<a href="#">PE4116</a>	\$26.12	\$24.81	\$23.51	\$22.46	88			
RG178, RG196	<a href="#">PE4592</a>	\$28.56	\$27.13	\$25.70	\$24.56	89			
RG188-DS, RG316-DS	<a href="#">PE4417</a>	\$17.28	\$16.42	\$15.55	\$14.86	90			
RG316, RG174, RG188	<a href="#">PE4040</a>	\$17.86	\$16.97	\$16.07	\$15.36	91			
RG58, RG55, RG142, RG223, RG400	<a href="#">PE4041</a>	\$19.27	\$18.31	\$17.34	\$16.57	92			
SPP-250-LLPL	<a href="#">PE45432</a>	\$16.83	\$15.99	\$15.15	\$14.47	93			
Vertical Launch	<a href="#">PE45459</a>	\$40.57	\$38.54	\$36.51	\$34.89	94			
PCB Mount		Clamp	Vertical Launch	<a href="#">PE45458</a>	\$40.57	\$38.54	\$36.51	\$34.89	95

Connectors

See Our Website For Current Pricing & Real-Time Stock Availability!

\* Fits MIL-C-17 and equivalent cable versions only











Technical Support  
+1 (949) 261-1920



Same-Day Shipping,  
Even Custom  
Cable Assemblies

# SMA Connectors







Connection Method	Product Image	Attachment Cable/Contact	Coax Type / Termination Type	Model No.	PRICE				ROW		
					1-24	25-49	50-99	100 +			
<b>Female</b>											
PCB Mount		Clamp/Solder (Captive Contact)	End Launch	<a href="#">PE45466</a>	\$55.11	\$52.35	\$49.60	\$47.39	96		
			End Launch	<a href="#">PE45463</a>	\$57.24	\$54.38	\$51.52	\$49.23	97		
			End Launch	<a href="#">PE45462</a>	\$57.24	\$54.38	\$51.52	\$49.23	98		
			End Launch	<a href="#">PE45464</a>	\$57.24	\$54.38	\$51.52	\$49.23	99		
			End Launch	<a href="#">PE45465</a>	\$57.24	\$54.38	\$51.52	\$49.23	1		
		Solder	.031 inch End Launch	<a href="#">PE44206</a>	\$23.42	\$22.25	\$21.08	\$20.14	2		
			.042 inch End Launch	<a href="#">PE44207</a>	\$30.14	\$28.63	\$27.13	\$25.92	3		
			.042 inch End Launch	<a href="#">PE44204</a>	\$28.25	\$26.84	\$25.43	\$24.30	4		
			.047 inch End Launch	<a href="#">PE44205</a>	\$32.29	\$30.68	\$29.06	\$27.77	5		
			.047 inch End Launch	<a href="#">PE44208</a>	\$30.79	\$29.25	\$27.71	\$26.48	6		
			.062 inch End Launch	<a href="#">PE4542</a>	\$21.39	\$20.32	\$19.25	\$18.40	7		
			.062 inch End Launch	<a href="#">PE4543</a>	\$22.88	\$21.74	\$20.59	\$19.68	8		
			.078 inch End Launch	<a href="#">PE44614</a>	\$38.48	\$36.56	\$34.63	\$33.09	9		
			End Launch	<a href="#">PE44235</a>	\$26.18	\$24.87	\$23.56	\$22.51	10		
			Surface Mount	<a href="#">PE4910</a>	\$20.38	\$19.36	\$18.34	\$17.53	11		
	Solder/Solder (Captive Contact)	Thru Hole	<a href="#">PE4117</a>	\$16.59	\$15.76	\$14.93	\$14.27	12			
		Thru Hole with .200 inch x .067 inch Hole Spacing	<a href="#">PE44827</a>	\$12.52	\$11.89	\$11.27	\$10.77	13			
		1/16 inch Stripline	<a href="#">PE4534</a>	\$49.16	\$46.70	\$44.24	\$42.28	14			
			1/8 inch Stripline	<a href="#">PE4190</a>	\$48.89	\$46.45	\$44.00	\$42.05	15		
<b>Female, Bulkhead Mount</b>											
Cable Connectors		Clamp/Solder	PE-P160LL	<a href="#">PE45441</a>	\$101.29	\$96.23	\$91.16	\$87.11	16		
			RG178, RG196 with .235 inch D Hole	<a href="#">PE4421</a>	\$42.81	\$40.67	\$38.53	\$36.82	17		
			RG188-DS, RG316-DS with .235 inch D Hole	<a href="#">PE4424</a>	\$45.74	\$43.45	\$41.17	\$39.34	18		
			RG316, RG174, RG188, PE-B100, PE-C100, .100 inch, LMR-100 with .235 inch D Hole	<a href="#">PE4032</a>	\$40.88	\$38.84	\$36.79	\$35.16	19		
			RG58, RG142, RG223, RG400, RG141, RG303, RG55, LMR-400, PE-C195, PE-P195 with .235 inch D Hole	<a href="#">PE4033</a>	\$44.02	\$41.82	\$39.62	\$37.86	20		
		Crimp/Solder	RG174, RG316, RG188, .100 inch, PE-B100, PE-C100, LMR-100 with .235 inch D Hole	<a href="#">PE44643</a>	\$22.95	\$21.80	\$20.66	\$19.74	21		
			RG178, RG196 with .235 inch D Hole	<a href="#">PE4422</a>	\$32.31	\$30.69	\$29.08	\$27.79	22		
			RG178, RG196 with .235 inch D Hole	<a href="#">PE45292</a>	\$19.75	\$18.76	\$17.78	\$16.99	23		
			RG188-DS, RG316-DS with .235 inch D Hole	<a href="#">PE4425</a>	\$25.52	\$24.24	\$22.97	\$21.95	24		
			RG316, RG174, LMR-100	<a href="#">PE45136</a>	\$17.76	\$16.87	\$15.98	\$15.27	25		
			RG316, RG174, RG188, PE-B100, PE-C100, .100 inch, LMR-100 with .235 inch D Hole	<a href="#">PE4427</a>	\$20.21	\$19.20	\$18.19	\$17.38	26		
			RG55, RG142, RG223, RG141 with .235 inch D Hole	<a href="#">PE4419</a>	\$24.71	\$23.47	\$22.24	\$21.25	27		
			RG58 with .235 inch D Hole	<a href="#">PE4420</a>	\$21.89	\$20.80	\$19.70	\$18.83	28		
			RG58, RG303, LMR-195	<a href="#">PE45138</a>	\$12.78	\$12.14	\$11.50	\$10.99	29		
			RG58, RG303, LMR-195, PE-P195	<a href="#">PE45141</a>	\$14.40	\$13.68	\$12.96	\$12.38	30		
			RG59*, RG62*, RG71 with .235 inch D Hole	<a href="#">PE4914</a>	\$29.08	\$27.63	\$26.17	\$25.01	31		
				Solder/Solder	PE-020SR with .235 inch D Hole	<a href="#">PE4924</a>	\$72.32	\$68.70	\$65.09	\$62.20	32
					PE-034SR with .235 inch D Hole	<a href="#">PE4923</a>	\$75.19	\$71.43	\$67.67	\$64.66	33
					PE-1/4SFHC, SPP-250-LLPL, SPO-250, SPF-250	<a href="#">PE45681</a>	\$11.40	\$10.83	\$10.26	\$9.80	34
					PE-SR401AL, PE-SR401FL, RG401 with .235 inch D Hole	<a href="#">PE4931</a>	\$65.11	\$61.85	\$58.60	\$55.99	35
	PE-SR402AL, PE-SR402FL, PE-SR402FLJ, PE-SR402TN, RG402	<a href="#">PE44697</a>			\$12.81	\$12.17	\$11.53	\$11.02	36		
	PE-SR402AL, PE-SR402FL, PE-SR402FLJ, PE-SR402TN, RG402 with .235 inch D Hole	<a href="#">PE45554</a>			\$18.94	\$17.99	\$17.05	\$16.29	37		
	PE-SR405AL, PE-SR405FL, PE-SR405FLJ, PE-SR405TN, RG405 with .235 inch D Hole	<a href="#">PE44696</a>			\$14.25	\$13.54	\$12.83	\$12.26	38		
	PE-SR405AL, PE-SR405FL, RG405 with .235 inch D Hole	<a href="#">PE4119</a>			\$17.29	\$16.43	\$15.56	\$14.87	39		
	RG178, RG196 with .235 inch D Hole	<a href="#">PE4423</a>			\$27.76	\$26.37	\$24.98	\$23.87	40		
	RG188-DS, RG316-DS with .235 inch D Hole	<a href="#">PE4426</a>			\$23.40	\$22.23	\$21.06	\$20.12	41		
	PCB Mount		Solder	.042 inch End Launch with .250 inch Diameter	<a href="#">PE44213</a>	\$27.90	\$26.51	\$25.11	\$23.99	44	
				.042 inch End Launch with .250 inch Diameter	<a href="#">PE44211</a>	\$30.62	\$29.09	\$27.56	\$26.33	45	
				.062 inch End Launch with .250 inch Diameter	<a href="#">PE44212</a>	\$27.83	\$26.44	\$25.05	\$23.93	46	
				.062 inch End Launch with .250 inch Diameter	<a href="#">PE44214</a>	\$29.51	\$28.03	\$26.56	\$25.38	47	
End Launch				<a href="#">PE45134</a>	\$28.99	\$27.54	\$26.09	\$24.93	48		
Terminal			Thru Hole with .235 inch D Hole	<a href="#">PE4524</a>	\$22.18	\$21.07	\$19.96	\$19.07	49		
			Pin	<a href="#">PE45547</a>	\$18.24	\$17.33	\$16.42	\$15.69	50		
			Solder Cup with .235 inch D Hole	<a href="#">PE4529</a>	\$54.66	\$51.93	\$49.19	\$47.01	51		
			Solder Cup with .235 inch D Hole	<a href="#">PE4219</a>	\$17.16	\$16.30	\$15.44	\$14.76	52		

\* Fits MIL-C-17 and equivalent cable versions only

Connectors

See Our Website For Current Pricing & Real-Time Stock Availability!

# SMA Connectors

Connection Method	Product Image	Attachment Cable/Contact	Coax Type / Termination Type	Model No.	PRICE				ROW
					1-24	25-49	50-99	100 +	
<b>Female, Bulkhead Mount</b>									
Terminal		Solder	Solder Cup with .235 inch D Hole	<a href="#">PE4101</a>	\$21.14	\$20.08	\$19.03	\$18.18	53
			Solder Cup with .350 inch D Hole	<a href="#">PE4536</a>	\$50.34	\$47.82	\$45.31	\$43.29	54
			Solder Cup with .250 inch Diameter	<a href="#">PE4549</a>	\$32.85	\$31.21	\$29.57	\$28.25	55
			Stub with .235 inch D Hole	<a href="#">PE4528</a>	\$49.59	\$47.11	\$44.63	\$42.65	56
			Stub with .250 inch Diameter	<a href="#">PE4530</a>	\$34.93	\$33.18	\$31.44	\$30.04	57
			Stub with .250 inch Diameter	<a href="#">PE4532</a>	\$31.72	\$30.13	\$28.55	\$27.28	58
			Stub with .250 inch Diameter	<a href="#">PE4189</a>	\$18.84	\$17.90	\$16.96	\$16.20	59
			Stub with .250 inch Diameter	<a href="#">PE44591</a>	\$33.38	\$31.71	\$30.04	\$28.71	60
<b>Female, 2 Hole Flange Mount</b>									
Field Replaceable		Field Replaceable	0.009 inch Pin	<a href="#">PE45578</a>	\$27.19	\$25.83	\$24.47	\$23.38	61
			0.009 inch Pin	<a href="#">PE45572</a>	\$31.35	\$29.78	\$28.22	\$26.96	62
			0.009 inch Pin with .481 inch Hole Spacing	<a href="#">PE45584</a>	\$26.03	\$24.73	\$23.43	\$22.39	63
			0.012 inch Pin	<a href="#">PE45579</a>	\$21.76	\$20.67	\$19.58	\$18.71	64
			0.012 inch Pin	<a href="#">PE45573</a>	\$25.78	\$24.49	\$23.20	\$22.17	65
			.012 inch Pin	<a href="#">PE45217</a>	\$32.97	\$31.32	\$29.67	\$28.35	66
			0.012 inch Pin with .481 inch Hole Spacing	<a href="#">PE45585</a>	\$20.84	\$19.80	\$18.76	\$17.92	67
			0.015 inch Pin	<a href="#">PE45574</a>	\$27.06	\$25.71	\$24.35	\$23.27	68
			0.015 inch Pin	<a href="#">PE45580</a>	\$22.83	\$21.69	\$20.55	\$19.63	69
			.015 inch Pin	<a href="#">PE44024</a>	\$36.92	\$35.07	\$33.23	\$31.75	70
			0.015 inch Pin with .481 inch Hole Spacing	<a href="#">PE45586</a>	\$20.92	\$19.87	\$18.83	\$17.99	71
			0.018 inch Pin	<a href="#">PE45575</a>	\$27.59	\$26.21	\$24.83	\$23.73	72
			0.018 inch Pin	<a href="#">PE45581</a>	\$23.93	\$22.73	\$21.54	\$20.58	73
			0.018 inch Pin with .481 inch Hole Spacing	<a href="#">PE45587</a>	\$21.68	\$20.60	\$19.51	\$18.64	74
			0.02 inch Pin	<a href="#">PE45582</a>	\$23.93	\$22.73	\$21.54	\$20.58	75
			0.02 inch Pin	<a href="#">PE45576</a>	\$24.62	\$23.39	\$22.16	\$21.17	76
0.02 inch Pin with .481 inch Hole Spacing	<a href="#">PE45588</a>	\$22.91	\$21.76	\$20.62	\$19.70	77			
0.036 inch Pin	<a href="#">PE45583</a>	\$27.50	\$26.13	\$24.75	\$23.65	78			
0.036 inch Pin	<a href="#">PE45577</a>	\$27.56	\$26.18	\$24.80	\$23.70	79			
.036 inch Pin	<a href="#">PE45055</a>	\$32.32	\$30.70	\$29.09	\$27.80	80			
0.036 inch Pin with .481 inch Hole Spacing	<a href="#">PE45589</a>	\$20.86	\$19.82	\$18.77	\$17.94	81			
Terminal		Solder	Stub with .481 inch Hole Spacing	<a href="#">PE44340</a>	\$68.31	\$64.89	\$61.48	\$58.75	82
			Solder Cup with .481 inch Hole Spacing	<a href="#">PE4004</a>	\$19.39	\$18.42	\$17.45	\$16.68	83
			Solder Cup with .481 inch Hole Spacing	<a href="#">PE44341</a>	\$66.49	\$63.17	\$59.84	\$57.18	84
			Stub	<a href="#">PE45067</a>	\$16.11	\$15.30	\$14.50	\$13.85	85
			Stub	<a href="#">PE45039</a>	\$16.68	\$16.01	\$15.51	\$15.18	86
			Stub with .481 inch Hole Spacing	<a href="#">PE4128</a>	\$24.02	\$22.82	\$21.62	\$20.66	87
			Stub with .481 inch Hole Spacing	<a href="#">PE4128-SF</a>	\$20.49	\$19.47	\$18.44	\$17.62	88
Tab with .481 inch Hole Spacing	<a href="#">PE4370</a>	\$27.35	\$25.98	\$24.62	\$23.52	89			
Cable Connectors		Solder/Solder	PE-047SR, PE-SR047AL, PE-SR047FL with .481 inch Hole Spacing	<a href="#">PE4547</a>	\$30.59	\$29.06	\$27.53	\$26.31	90
			PE-SR402AL, PE-SR402FL, RG402 with .481 inch Hole Spacing	<a href="#">PE4196</a>	\$33.45	\$31.78	\$30.11	\$28.77	91
			PE-SR405AL, PE-SR405FL, PE-SR405FLJ, RG405 with .481 inch Hole Spacing	<a href="#">PE4197</a>	\$27.66	\$26.28	\$24.89	\$23.79	92
<b>Female, 4 Hole Flange Mount</b>									
Cable Connectors		Clamp/Solder	.100 inch, RG316, RG174, RG188, LMR-100, LMR-100A, LMR-100A-FR, PE-C100, PE-B100 with .340 inch Hole Spacing	<a href="#">PE4034</a>	\$72.32	\$68.70	\$65.09	\$62.20	93
			RG58, RG55, RG141, RG142, RG223, RG400 with .340 inch Hole Spacing	<a href="#">PE4035</a>	\$64.58	\$61.35	\$58.12	\$55.54	94
		Solder/Solder	PE-047SR, PE-SR047AL, PE-SR047FL with .340 inch Hole Spacing	<a href="#">PE4548</a>	\$87.38	\$83.01	\$78.64	\$75.15	95
			RG402, RG402 Tinned, PE-SR402FL, PE-SR402AL, PE-SR402FLJ, PE-SR402TN with .340 inch Hole Spacing	<a href="#">PE4121</a>	\$41.64	\$39.56	\$37.48	\$35.81	96
			RG405, RG405 Tinned, PE-SR405FL, PE-SR405AL, PE-SR405FLJ, PE-SR405TN	<a href="#">PE44998</a>	\$34.77	\$33.03	\$31.29	\$29.90	97
Field Replaceable		Field Replaceable	0.009 inch Pin	<a href="#">PE45566</a>	\$36.87	\$35.03	\$33.18	\$31.71	98
			0.009 inch Pin	<a href="#">PE45560</a>	\$35.06	\$33.31	\$31.55	\$30.15	99
			0.012 inch Pin	<a href="#">PE45567</a>	\$29.49	\$28.02	\$26.54	\$25.36	1
			0.012 inch Pin	<a href="#">PE45561</a>	\$28.05	\$26.65	\$25.25	\$24.12	2
			.012 inch Pin	<a href="#">PE44010</a>	\$40.63	\$38.60	\$36.57	\$34.94	3
			.012 inch Pin	<a href="#">PE44000</a>	\$42.53	\$40.40	\$38.28	\$36.58	4
			0.015 inch Pin	<a href="#">PE45562</a>	\$28.67	\$27.24	\$25.80	\$24.66	5
0.015 inch Pin	<a href="#">PE45568</a>	\$30.97	\$29.42	\$27.87	\$26.63	6			

Connectors

See Our Website For Current Pricing & Real-Time Stock Availability!

\* Fits MIL-C-17 and equivalent cable versions only













Technical Support  
+1 (949) 261-1920



Same-Day Shipping,  
Even Custom  
Cable Assemblies



## SMA Connectors

Connection Method	Product Image	Attachment Cable/Contact	Coax Type / Termination Type	Model No.	PRICE				ROW
					1-24	25-49	50-99	100 +	
<b>Female, 4 Hole Flange Mount</b>									
Field Replaceable		Field Replaceable	.015 inch Pin	<a href="#">PE44001</a>	\$39.38	\$37.41	\$35.44	\$33.87	7
			.015 inch Pin	<a href="#">PE45216</a>	\$26.52	\$25.19	\$23.87	\$22.81	8
			0.018 inch Pin	<a href="#">PE45569</a>	\$32.44	\$30.82	\$29.20	\$27.90	9
			0.018 inch Pin	<a href="#">PE45563</a>	\$30.86	\$29.32	\$27.77	\$26.54	10
			0.02 inch Pin	<a href="#">PE45570</a>	\$32.44	\$30.82	\$29.20	\$27.90	11
			0.02 inch Pin	<a href="#">PE45564</a>	\$35.44	\$33.67	\$31.90	\$30.48	12
			.020 inch Pin	<a href="#">PE45215</a>	\$23.66	\$22.48	\$21.29	\$20.35	13
			.020 inch Pin	<a href="#">PE44003</a>	\$39.78	\$37.79	\$35.80	\$34.21	14
			0.036 inch Pin	<a href="#">PE45565</a>	\$32.26	\$30.65	\$29.03	\$27.74	15
			0.036 inch Pin	<a href="#">PE45571</a>	\$33.91	\$32.21	\$30.52	\$29.16	16
			.036 inch Pin	<a href="#">PE44004</a>	\$42.53	\$40.40	\$38.28	\$36.58	17
.036 inch Pin	<a href="#">PE45053</a>	\$35.40	\$33.63	\$31.86	\$30.44	18			
Terminal		Solder	Pin with .340 inch Hole Spacing	<a href="#">PE4540</a>	\$54.67	\$51.94	\$49.20	\$47.02	19
			Pin with .340 inch Hole Spacing	<a href="#">PE4217</a>	\$28.25	\$26.84	\$25.43	\$24.30	20
			Pin with .375 inch x .500 inch Hole Spacing	<a href="#">PE4538</a>	\$46.65	\$44.32	\$41.99	\$40.12	21
			Solder Cup with .340 inch Hole Spacing	<a href="#">PE4537</a>	\$35.78	\$33.99	\$32.20	\$30.77	22
			Solder Cup with .340 inch Hole Spacing	<a href="#">PE4000</a>	\$25.56	\$24.28	\$23.00	\$21.98	23
			Solder Cup with .500 inch Hole Spacing	<a href="#">PE4527</a>	\$30.62	\$29.09	\$27.56	\$26.33	24
			Solder Cup with .718 inch Hole Spacing	<a href="#">PE4218</a>	\$31.53	\$29.95	\$28.38	\$27.12	25
			Stub	<a href="#">PE4111</a>	\$37.47	\$35.60	\$33.72	\$32.22	26
			Stub with .340 inch Hole Spacing	<a href="#">PE4099</a>	\$19.92	\$18.92	\$17.93	\$17.13	27
			Stub with .500 inch Hole Spacing	<a href="#">PE4533</a>	\$29.27	\$27.81	\$26.34	\$25.17	28
			Tab with .340 inch Hole Spacing	<a href="#">PE4186</a>	\$23.95	\$22.75	\$21.56	\$20.60	29
Tab with .375 inch x .500 inch Hole Spacing	<a href="#">PE4539</a>	\$35.78	\$33.99	\$32.20	\$30.77	30			
<b>Female, Press-In</b>									
Terminal		Solder	Tab with .200 inch Diameter	<a href="#">PE44241</a>	\$35.71	\$33.92	\$32.14	\$30.71	31
			Tab with .200 inch Diameter	<a href="#">PE44240</a>	\$31.96	\$30.36	\$28.76	\$27.49	32
<b>Female Right Angle</b>									
PCB Mount		Solder	Surface Mount	<a href="#">PE4911</a>	\$31.42	\$29.85	\$28.28	\$27.02	33
<b>Female Right Angle, Bulkhead Mount</b>									
PCB Mount		Solder	Thru Hole with .235 inch D Hole	<a href="#">PE4545</a>	\$33.66	\$31.98	\$30.29	\$28.95	34
Terminal			Solder Cup with .235 inch D Hole	<a href="#">PE4300</a>	\$59.11	\$56.15	\$53.20	\$50.83	35
<b>Female Right Angle, 2 Hole Flange Mount</b>									
Terminal		Solder	Pin with .481 inch Hole Spacing	<a href="#">PE44237</a>	\$59.50	\$56.53	\$53.55	\$51.17	36
			Pin with .481 inch Hole Spacing	<a href="#">PE44238</a>	\$54.84	\$52.10	\$49.36	\$47.16	37
			Pin with .481 inch Hole Spacing	<a href="#">PE44239</a>	\$57.15	\$54.29	\$51.44	\$49.15	38
			Pin with .481 inch Hole Spacing	<a href="#">PE44593</a>	\$55.88	\$53.09	\$50.29	\$48.06	39
<b>Female Right Angle, 4 Hole Flange Mount</b>									
Field Replaceable		Field Replaceable	.012 inch Pin	<a href="#">PE44015</a>	\$63.71	\$60.52	\$57.34	\$54.79	40
Terminal		Solder	Pin with .340 inch Hole Spacing	<a href="#">PE44236</a>	\$34.69	\$32.96	\$31.22	\$29.83	41
			Solder Cup with .340 inch Hole Spacing	<a href="#">PE4123</a>	\$42.58	\$40.45	\$38.32	\$36.62	42
<b>Reverse Polarity SMA Connectors</b>									
<b>Male</b>									
Cable Connectors		Clamp/Solder	RG174, RG316, RG188, PE-B100, PE-C100, .100 inch, LMR-100	<a href="#">PE4770</a>	\$41.00	\$38.95	\$36.90	\$35.26	43
			RG178, RG196	<a href="#">PE4773</a>	\$14.49	\$13.77	\$13.04	\$12.46	44

\* Fits MIL-C-17 and equivalent cable versions only

Connectors

See Our Website For Current Pricing & Real-Time Stock Availability!

# Reverse Polarity SMA Connectors

Connection Method	Product Image	Attachment Cable/Contact	Coax Type / Termination Type	Model No.	PRICE				ROW
					1-24	25-49	50-99	100 +	
<b>Male</b>									
Cable Connectors		Clamp/Solder	RG55, RG58, RG141, RG142, RG223, RG303, RG400, PE-C195, PE-P195, LMR-195	<a href="#">PE4766</a>	\$37.50	\$35.63	\$33.75	\$32.25	45
			PE-B150, RG180, RG195	<a href="#">PE4777</a>	\$17.11	\$16.25	\$15.40	\$14.71	46
		Crimp/Solder	PE-C240, RG8X, .240 inch, LMR-240, LMR-240-DB, LMR-240-UF, B7808A	<a href="#">PE44664</a>	\$27.95	\$26.55	\$25.16	\$24.04	47
			PE-C400, PE-B400, PE-B405, LMR-400, LMR-400-DB, LMR-400-UF, .400 inch	<a href="#">PE44666</a>	\$32.97	\$31.32	\$29.67	\$28.35	48
			RG174, RG316, RG188, PE-B100, PE-C100, .100 inch, LMR-100	<a href="#">PE4771</a>	\$23.18	\$22.02	\$20.86	\$19.93	49
			RG188-DS, RG316-DS	<a href="#">PE45183</a>	\$21.09	\$20.04	\$18.98	\$18.14	50
			RG55, RG141, RG142, RG223, RG400	<a href="#">PE4767</a>	\$24.40	\$23.18	\$21.96	\$20.98	51
			RG58	<a href="#">PE4769</a>	\$24.97	\$23.72	\$22.47	\$21.47	52
			RG178, RG196	<a href="#">PE45008</a>	\$47.80	\$45.41	\$43.02	\$41.11	53
		Solder/Solder	PE-SR402AL, PE-SR402FL, PE-SR402FLJ, PE-SR402TN, RG402	<a href="#">PE44724</a>	\$23.66	\$22.48	\$21.29	\$20.35	54
			RG174, RG316, RG188	<a href="#">PE4772</a>	\$23.07	\$21.92	\$20.76	\$19.84	55
			RG178, RG196	<a href="#">PE4775</a>	\$28.67	\$27.52	\$26.66	\$26.09	56
			RG58, RG55, RG141, RG142, RG223, RG400	<a href="#">PE4768</a>	\$24.91	\$23.66	\$22.42	\$21.42	57
<b>Male Right Angle</b>									
Cable Connectors		Clamp/Solder	RG174, RG316, RG188	<a href="#">PE4784</a>	\$62.14	\$59.03	\$55.93	\$53.44	58
			RG58, RG55, RG141, RG142, RG223, RG400	<a href="#">PE4780</a>	\$45.27	\$43.01	\$40.74	\$38.93	59
		Crimp/Solder	RG174, RG316, RG188, PE-B100, PE-C100, .100 inch, LMR-100	<a href="#">PE4785</a>	\$62.70	\$59.57	\$56.43	\$53.92	60
			RG178, RG196	<a href="#">PE4788</a>	\$41.92	\$39.82	\$37.73	\$36.05	61
			RG188-DS, RG316-DS	<a href="#">PE45185</a>	\$47.71	\$45.32	\$42.94	\$41.03	62
			RG55, RG142, RG223, RG400	<a href="#">PE44975</a>	\$43.96	\$41.76	\$39.56	\$37.81	63
			RG58, RG141, PE-C195, PE-P195	<a href="#">PE45012</a>	\$37.89	\$36.00	\$34.10	\$32.59	64
		Solder/Solder	PE-SR402AL, PE-SR402FL, RG402	<a href="#">PE4790</a>	\$50.34	\$47.82	\$45.31	\$43.29	65
			PE-SR405AL, PE-SR405FL, PE-SR405FLJ, PE-SR405TN, RG405	<a href="#">PE4791</a>	\$53.09	\$50.44	\$47.78	\$45.66	66
			RG174, RG316, RG188	<a href="#">PE4786</a>	\$42.19	\$40.08	\$37.97	\$36.28	67
RG58, RG55, RG141, RG142, RG223, RG400			<a href="#">PE4782</a>	\$42.19	\$40.08	\$37.97	\$36.28	68	
<b>Female</b>									
Cable Connectors		Clamp/Solder	RG178, RG196	<a href="#">PE4850</a>	\$13.72	\$13.17	\$12.76	\$12.49	69
			RG55, RG58, RG141, RG142, RG223, RG303, RG400, PE-C195, PE-P195, LMR-195	<a href="#">PE4792</a>	\$36.20	\$34.39	\$32.58	\$31.13	70
		Crimp/Crimp	LMR-400, PE-C400, PE-B400, PE-B405	<a href="#">PE45397</a>	\$7.10	\$6.75	\$6.39	\$6.11	71
			PE-C240, RG8X, .240 inch, LMR-240, LMR-240-DB, LMR-240-UF, B7808A	<a href="#">PE44665</a>	\$29.74	\$28.25	\$26.77	\$25.58	72
		Crimp/Solder	RG174, RG316, RG188, PE-B100, PE-C100, .100 inch, LMR-100, RG179	<a href="#">PE4797</a>	\$34.54	\$32.81	\$31.09	\$29.70	73
			RG178, RG196	<a href="#">PE4799</a>	\$33.79	\$32.10	\$30.41	\$29.06	74
			RG188-DS, RG316-DS	<a href="#">PE45186</a>	\$31.20	\$29.64	\$28.08	\$26.83	75
			RG55, RG141, RG142, RG223, RG400	<a href="#">PE4793</a>	\$37.18	\$35.32	\$33.46	\$31.97	76
			RG58	<a href="#">PE4795</a>	\$29.28	\$27.82	\$26.35	\$25.18	77
			PE-SR402AL, PE-SR402FL, PE-SR402FLJ, PE-SR402TN, RG402	<a href="#">PE44723</a>	\$29.09	\$27.64	\$26.18	\$25.02	78
		Solder/Solder	PE-SR402AL, PE-SR402FL, RG402	<a href="#">PE4852</a>	\$34.43	\$32.71	\$30.99	\$29.61	79
			PE-SR405AL, PE-SR405FL, PE-SR405FLJ, PE-SR405TN, RG405	<a href="#">PE4853</a>	\$19.10	\$18.15	\$17.19	\$16.43	80
			RG174, RG316, RG188	<a href="#">PE4798</a>	\$29.85	\$28.36	\$26.87	\$25.67	81
RG178, RG196			<a href="#">PE4851</a>	\$26.03	\$24.73	\$23.43	\$22.39	82	
RG58, RG55, RG141, RG142, RG223, RG400			<a href="#">PE4794</a>	\$27.84	\$26.45	\$25.06	\$23.94	83	
.062 inch End Launch			<a href="#">PE4874</a>	\$31.45	\$29.88	\$28.31	\$27.05	84	
PCB Mount		Solder	Thru Hole with .200 inch x .067 inch Hole Spacing	<a href="#">PE4869</a>	\$27.34	\$25.97	\$24.61	\$23.51	85
<b>Female, Bulkhead Mount</b>									
Cable Connectors		Clamp/Solder	RG174, RG316, RG188 with .235 inch D Hole	<a href="#">PE4858</a>	\$46.60	\$44.27	\$41.94	\$40.08	86
			RG178, RG196 with .235 inch D Hole	<a href="#">PE4861</a>	\$41.92	\$39.82	\$37.73	\$36.05	87
			RG58, RG142, RG223, RG400, RG141, RG303, RG55, LMR-195, PE-C195, PE-P195 with .235 inch D Hole	<a href="#">PE4854</a>	\$41.92	\$39.82	\$37.73	\$36.05	88

Connectors

See Our Website For Current Pricing & Real-Time Stock Availability!









\* Fits MIL-C-17 and equivalent cable versions only

Technical Support  
+1 (949) 261-1920





Same-Day Shipping,  
Even Custom  
Cable Assemblies

## Reverse Polarity SMA Connectors

Connection Method	Product Image	Attachment Cable/Contact	Coax Type / Termination Type	Model No.	PRICE				ROW
					1-24	25-49	50-99	100 +	
<b>Female, Bulkhead Mount</b>									
Cable Connectors		Crimp/Solder	.100 inch, RG316, RG174, RG188, LMR-100, LMR-100A, LMR-100A-FR, PE-C100, PE-B100 with .235 inch D Hole	<a href="#">PE4859</a>	\$32.51	\$30.88	\$29.26	\$27.96	89
			RG178, RG196 with .235 inch D Hole	<a href="#">PE4862</a>	\$27.95	\$26.55	\$25.16	\$24.04	90
			RG188-DS, RG316-DS with .235 inch D Hole	<a href="#">PE45189</a>	\$29.60	\$28.12	\$26.64	\$25.46	91
			RG196, RG178	<a href="#">PE45004</a>	\$20.13	\$19.32	\$18.72	\$18.32	92
			RG55, RG141, RG142, RG223, RG400 with .235 inch D Hole	<a href="#">PE4855</a>	\$32.62	\$30.99	\$29.36	\$28.05	93
	RG58 with .235 inch D Hole	<a href="#">PE4857</a>	\$26.73	\$25.39	\$24.06	\$22.99	94		
		Solder/Solder	PE-SR402AL, PE-SR402FL, RG402 with .235 inch D Hole	<a href="#">PE4864</a>	\$39.55	\$37.57	\$35.60	\$34.01	95
			PE-SR405AL, PE-SR405FL, PE-SR405FLJ, PE-SR405TN, RG405 with .235 inch D Hole	<a href="#">PE4865</a>	\$44.69	\$42.46	\$40.22	\$38.43	96
			RG174, RG316, RG188 with .235 inch D Hole	<a href="#">PE4860</a>	\$27.84	\$26.45	\$25.06	\$23.94	97
			RG178, RG196 with .235 inch D Hole	<a href="#">PE4863</a>	\$27.47	\$26.10	\$24.72	\$23.62	98
RG58, RG55, RG141, RG142, RG223, RG400 with .235 inch D Hole			<a href="#">PE4856</a>	\$27.89	\$26.50	\$25.10	\$23.99	99	
PCB Mount		Solder	Thru Hole with .250 inch Diameter	<a href="#">PE4872</a>	\$27.59	\$26.21	\$24.83	\$23.73	1
Terminal			Solder Cup with .235 inch D Hole	<a href="#">PE4868</a>	\$27.66	\$26.28	\$24.89	\$23.79	2
			Solder Cup with .235 inch D Hole	<a href="#">PE4871</a>	\$27.42	\$26.05	\$24.68	\$23.58	3
<b>Female, 2 Hole Flange Mount</b>									
Terminal		Solder	Solder Cup with .481 inch Hole Spacing	<a href="#">PE4867</a>	\$32.55	\$30.92	\$29.30	\$27.99	4
<b>Female, 4 Hole Flange Mount</b>									
Terminal		Solder	Solder Cup with .340 inch Hole Spacing	<a href="#">PE4866</a>	\$23.17	\$22.01	\$20.85	\$19.93	5
<b>Female Right Angle</b>									
PCB Mount		Solder	Thru Hole with .200 inch x .067 inch Hole Spacing	<a href="#">PE4870</a>	\$40.63	\$38.60	\$36.57	\$34.94	6
<b>Female Right Angle, Bulkhead Mount</b>									
PCB Mount		Solder	Thru Hole with .250 inch Diameter	<a href="#">PE4875</a>	\$53.91	\$51.21	\$48.52	\$46.36	7

## Reverse Thread SMA Connectors





Connection Method	Product Image	Attachment Cable/Contact	Coax Type / Termination Type	Model No.	PRICE				ROW
					1-24	25-49	50-99	100 +	
<b>Male</b>									
Cable Connectors		Crimp/Solder	RG174, RG316, RG188, PE-B100, PE-C100, .100 inch, LMR-100	<a href="#">PE44184</a>	\$15.26	\$14.65	\$14.19	\$13.89	8
			RG178, RG196	<a href="#">PE44185</a>	\$27.84	\$26.45	\$25.06	\$23.94	9
			RG188-DS, RG316-DS	<a href="#">PE45165</a>	\$24.39	\$23.17	\$21.95	\$20.98	10
			RG55, RG141, RG142, RG223, RG400	<a href="#">PE44182</a>	\$29.27	\$27.81	\$26.34	\$25.17	11
			RG58	<a href="#">PE44183</a>	\$25.45	\$24.18	\$22.91	\$21.89	12
<b>Male Right Angle</b>									
Cable Connectors		Crimp/Solder	RG174, RG316, RG188	<a href="#">PE44188</a>	\$52.36	\$49.74	\$47.12	\$45.03	13
			RG178, RG196	<a href="#">PE44189</a>	\$52.36	\$49.74	\$47.12	\$45.03	14
			RG55, RG141, RG142, RG223, RG400	<a href="#">PE44186</a>	\$48.92	\$46.47	\$44.03	\$42.07	15
			RG58	<a href="#">PE44187</a>	\$41.37	\$39.30	\$37.23	\$35.58	16
<b>Female</b>									
Cable Connectors		Crimp/Solder	RG174, RG316, RG188	<a href="#">PE44192</a>	\$30.78	\$29.24	\$27.70	\$26.47	17
			RG178, RG196	<a href="#">PE44193</a>	\$35.26	\$33.50	\$31.73	\$30.32	18
			RG55, RG141, RG142, RG223, RG400	<a href="#">PE44190</a>	\$34.54	\$32.81	\$31.09	\$29.70	19
			RG58	<a href="#">PE44191</a>	\$28.44	\$27.02	\$25.60	\$24.46	20

\* Fits MIL-C-17 and equivalent cable versions only

Connectors

See Our Website For Current Pricing & Real-Time Stock Availability!

## Reverse Thread SMA Connectors





Connection Method	Product Image	Attachment Cable/Contact	Coax Type / Termination Type	Model No.	PRICE				ROW
					1-24	25-49	50-99	100 +	
<b>Female</b>									
PCB Mount		Solder	.062 inch End Launch	<a href="#">PE44201</a>	\$34.54	\$32.81	\$31.09	\$29.70	21
			.062 inch End Launch	<a href="#">PE44202</a>	\$34.54	\$32.81	\$31.09	\$29.70	22
			Thru Hole with .200 inch x .067 inch Hole Spacing	<a href="#">PE44198</a>	\$34.54	\$32.81	\$31.09	\$29.70	23
<b>Female, Bulkhead Mount</b>									
Cable Connectors		Crimp/Solder	.100 inch, RG316, RG174, RG188, LMR-100, LMR-100A, LMR-100A-FR, PE-C100, PE-B100 with .235 inch D Hole	<a href="#">PE44196</a>	\$28.64	\$27.21	\$25.78	\$24.63	24
			RG178, RG196 with .235 inch D Hole	<a href="#">PE44197</a>	\$34.83	\$33.09	\$31.35	\$29.95	25
			RG55, RG141, RG142, RG223, RG400 with .235 inch D Hole	<a href="#">PE44194</a>	\$32.89	\$31.25	\$29.60	\$28.29	26
			RG58 with .235 inch D Hole	<a href="#">PE44195</a>	\$29.50	\$28.03	\$26.55	\$25.37	27
<b>Female, 4 Hole Flange Mount</b>									
Terminal		Solder	Solder Cup with .340 inch Hole Spacing	<a href="#">PE44200</a>	\$38.65	\$36.72	\$34.79	\$33.24	28
<b>Female Right Angle</b>									
PCB Mount		Solder	Thru Hole with .200 inch x .067 inch Hole Spacing	<a href="#">PE44199</a>	\$38.65	\$36.72	\$34.79	\$33.24	29

## SMA, 2.92mm Torque Wrenches



Type	Bit Hex Size (in.)	Preset Torque (in.-lbs.)	Model No	1 Pc. Price	See Web for Volume Pricing		ROW
SMA, 2.92mm	5/16 inch	5 in.-lbs	<a href="#">PE5019-19</a>	\$223.35	See Web for Volume Pricing		
		8 in.-lbs	<a href="#">PE5011-1</a>	\$256.76			

## SMB Connectors

Connection Method	Product Image	Attachment Cable/Contact	Coax Type / Termination Type	Model No.	PRICE				ROW
					1-24	25-49	50-99	100 +	
<b>Plug</b>									
Cable Connectors		Clamp/Solder	PE-SR405AL, PE-SR405FL, RG405	<a href="#">PE4356</a>	\$19.47	\$18.69	\$18.11	\$17.72	30
			RG174, RG316, RG188, .100 inch, PE-B100, PE-C100, LMR-100	<a href="#">PE4200</a>	\$19.67	\$18.69	\$17.70	\$16.92	31
			RG178, RG196	<a href="#">PE4250</a>	\$24.50	\$23.28	\$22.05	\$21.07	32
		Crimp/Solder	RG174, RG316, RG188, LMR-100, PE-B100, PE-C100, .100 inch	<a href="#">PE4046</a>	\$14.50	\$13.78	\$13.05	\$12.47	33
			RG178, RG196	<a href="#">PE4080</a>	\$21.15	\$20.09	\$19.04	\$18.19	34
			RG316-DS, RG188-DS	<a href="#">PE44792</a>	\$16.52	\$15.69	\$14.87	\$14.21	35
			RG55, RG142, RG223, RG400	<a href="#">PE4593</a>	\$20.05	\$19.05	\$18.05	\$17.24	36
RG58, RG303, RG141, PE-C195, PE-P195, LMR-195, .195 inch	<a href="#">PE4523</a>	\$21.15	\$20.09	\$19.04	\$18.19	37			
PCB Mount		Solder/Solder	RG405, PE-SR405FL, PE-SR405FLJ	<a href="#">PE45119</a>	\$10.15	\$9.64	\$9.14	\$8.73	38
Terminal		Solder	Thru Hole with .200 inch x .067 inch Hole Spacing	<a href="#">PE4366</a>	\$29.00	\$27.55	\$26.10	\$24.94	39
<b>Plug, Bulkhead Mount</b>									
Terminal		Solder	Solder Cup with .177 inch D Hole	<a href="#">PE4288</a>	\$41.76	\$39.67	\$37.58	\$35.91	40

\* Fits MIL-C-17 and equivalent cable versions only



Technical Support  
+1 (949) 261-1920



Same-Day Shipping,  
Even Custom  
Cable Assemblies

Connectors

See Our Website For Current Pricing & Real-Time Stock Availability!



## SMB Connectors



Connection Method	Product Image	Attachment Cable/Contact	Coax Type / Termination Type	Model No.	PRICE				ROW
					1-24	25-49	50-99	100 +	
<b>Plug Right Angle</b>									
Cable Connectors		Clamp/Solder	PE-SR405AL, PE-SR405FL, PE-SR405FLJ, PE-SR405TN, RG405	<a href="#">PE4358</a>	\$21.56	\$20.48	\$19.40	\$18.54	41
			RG174, RG316, RG188	<a href="#">PE4260</a>	\$37.81	\$35.92	\$34.03	\$32.52	42
			RG178, RG196	<a href="#">PE4261</a>	\$42.79	\$40.65	\$38.51	\$36.80	43
		Crimp/Solder	RG174, RG316, RG188, LMR-100, PE-B100, PE-C100, .100 inch	<a href="#">PE4052</a>	\$11.38	\$10.81	\$10.24	\$9.79	44
			RG178, RG196	<a href="#">PE4159</a>	\$23.01	\$21.86	\$20.71	\$19.79	45
			RG188-DS, RG316-DS	<a href="#">PE44818</a>	\$17.82	\$16.93	\$16.04	\$15.33	46
			RG55, RG142, RG223, RG400	<a href="#">PE4595</a>	\$23.78	\$22.59	\$21.40	\$20.45	47
PCB Mount		Solder	Thru Hole with .200 inch x .067 inch Hole Spacing	<a href="#">PE4245</a>	\$24.52	\$23.29	\$22.07	\$21.09	49
			RG58, RG303, RG141, PE-C195, PE-P195, LMR-195, .195 inch	<a href="#">PE4522</a>	\$25.56	\$24.28	\$23.00	\$21.98	48
<b>Jack</b>									
Cable Connectors		Clamp/Solder	PE-SR405AL, PE-SR405FL, RG405	<a href="#">PE4360</a>	\$19.68	\$18.70	\$17.71	\$16.92	50
			RG178, RG196	<a href="#">PE4269</a>	\$29.75	\$28.26	\$26.78	\$25.59	51
		Crimp/Solder	RG174, RG316, RG188, LMR-100, PE-B100, PE-C100, .100 inch	<a href="#">PE4096</a>	\$16.74	\$15.90	\$15.07	\$14.40	52
			RG178, RG196	<a href="#">PE4926</a>	\$29.48	\$28.01	\$26.53	\$25.35	53
			RG188-DS, RG316-DS	<a href="#">PE45158</a>	\$14.61	\$13.88	\$13.15	\$12.56	54
PCB Mount		Solder	.042 inch End Launch	<a href="#">PE44132</a>	\$11.44	\$10.98	\$10.64	\$10.41	55
			.042 inch End Launch	<a href="#">PE44137</a>	\$24.07	\$22.87	\$21.66	\$20.70	56
			.062 inch End Launch	<a href="#">PE44135</a>	\$22.64	\$21.51	\$20.38	\$19.47	57
			.062 inch End Launch	<a href="#">PE44129</a>	\$25.74	\$24.45	\$23.17	\$22.14	58
			Surface Mount	<a href="#">PE44119</a>	\$11.56	\$10.98	\$10.40	\$9.94	59
			Thru Hole with .200 inch x .067 inch Hole Spacing	<a href="#">PE4174</a>	\$8.76	\$8.32	\$7.88	\$7.53	60
<b>Jack, Bulkhead Mount</b>									
Cable Connectors		Clamp/Solder	PE-SR405AL, PE-SR405FL, RG405	<a href="#">PE4362</a>	\$20.49	\$19.47	\$18.44	\$17.62	61
			RG174, RG316, RG188 with .177 inch D Hole	<a href="#">PE4276</a>	\$20.81	\$19.77	\$18.73	\$17.90	62
		Crimp/Solder	RG174, RG316, RG188, LMR-100, PE-B100, PE-C100, .100 inch	<a href="#">PE4097</a>	\$19.64	\$18.66	\$17.68	\$16.89	63
			RG178, RG196	<a href="#">PE4364</a>	\$18.64	\$17.71	\$16.78	\$16.03	64
			RG188-DS, RG316-DS	<a href="#">PE45159</a>	\$16.12	\$15.31	\$14.51	\$13.86	65
			RG55, RG141, RG142, RG223, RG400 with .177 inch D Hole	<a href="#">PE44048</a>	\$38.42	\$36.50	\$34.58	\$33.04	66
			RG58	<a href="#">PE44094</a>	\$30.96	\$29.41	\$27.86	\$26.63	67
PCB Mount		Solder	Thru Hole with .177 inch D Hole	<a href="#">PE44123</a>	\$24.10	\$23.14	\$22.41	\$21.93	68
Terminal			Solder Cup with .177 inch D Hole	<a href="#">PE4170</a>	\$17.14	\$16.28	\$15.43	\$14.74	69
			Solder Cup with .177 inch D Hole	<a href="#">PE4167</a>	\$9.17	\$8.71	\$8.25	\$7.89	70
<b>Jack, 2 Hole Flange Mount</b>									
Terminal		Solder	Solder Cup with .328 inch Hole Spacing	<a href="#">PE44139</a>	\$35.02	\$33.27	\$31.52	\$30.12	71
<b>Jack, 4 Hole Flange Mount</b>									
Terminal		Solder	Solder Cup with .232 inch Hole Spacing	<a href="#">PE44142</a>	\$30.42	\$28.90	\$27.38	\$26.16	72
<b>Jack Right Angle</b>									
PCB Mount		Solder	Surface Mount	<a href="#">PE44121</a>	\$27.16	\$25.80	\$24.44	\$23.36	73
			Thru Hole with .200 inch x .067 inch Hole Spacing	<a href="#">PE4177</a>	\$13.96	\$13.26	\$12.56	\$12.01	74

\* Fits MIL-C-17 and equivalent cable versions only











Connectors

See Our Website For Current Pricing & Real-Time Stock Availability!

## SMB Connectors

Connection Method	Product Image	Attachment Cable/Contact	Coax Type / Termination Type	Model No.	PRICE				ROW
					1-24	25-49	50-99	100 +	
<b>Jack Right Angle, Bulkhead Mount</b>									
PCB Mount		Solder	Thru Hole with .177 inch D Hole	<a href="#">PE44875</a>	\$25.29	\$24.03	\$22.76	\$21.75	75
Terminal			Solder Cup with .177 inch D Hole	<a href="#">PE4284</a>	\$31.76	\$30.17	\$28.58	\$27.31	76

## SMC Connectors

Connection Method	Product Image	Attachment Cable/Contact	Coax Type / Termination Type	Model No.	PRICE				ROW
					1-24	25-49	50-99	100 +	
<b>Plug</b>									
Cable Connectors		Clamp/Solder	RG174, RG316, RG188, LMR-100, PE-B100, PE-C100, .100 inch	<a href="#">PE4201</a>	\$16.49	\$15.67	\$14.84	\$14.18	77
			RG178, RG196	<a href="#">PE4202</a>	\$20.87	\$19.83	\$18.78	\$17.95	78
		Crimp/Solder	PE-P195, PE-C195, RG58, RG141, RG303, .195 inch, LMR-195	<a href="#">PE4558</a>	\$24.73	\$23.49	\$22.26	\$21.27	79
			RG174, RG316, RG188, LMR-100, PE-B100, PE-C100, .100 inch	<a href="#">PE4045</a>	\$14.48	\$13.76	\$13.03	\$12.45	80
			RG178, RG196	<a href="#">PE4074</a>	\$21.27	\$20.21	\$19.14	\$18.29	81
			RG188-DS, RG316-DS	<a href="#">PE45155</a>	\$14.31	\$13.59	\$12.88	\$12.31	82
			RG55, RG142, RG223, RG400	<a href="#">PE45396</a>	\$25.17	\$23.91	\$22.65	\$21.65	83
		Solder/Solder	PE-SR405AL, PE-SR405FL, PE-SR405FLJ, PE-SR405TN, RG405	<a href="#">PE44977</a>	\$29.47	\$28.00	\$26.52	\$25.34	84
PCB Mount		Solder	Thru Hole with .200 inch x .067 inch Hole Spacing	<a href="#">PE4367</a>	\$17.73	\$16.84	\$15.96	\$15.25	85
<b>Plug Right Angle</b>									
Cable Connectors		Clamp/Solder	PE-SR405AL, PE-SR405FL, RG405	<a href="#">PE4359</a>	\$47.10	\$44.75	\$42.39	\$40.51	86
			RG174, RG316, RG188, LMR-100, PE-B100, PE-C100, .100 inch	<a href="#">PE4262</a>	\$19.66	\$18.68	\$17.69	\$16.91	87
			RG178, RG196	<a href="#">PE4263</a>	\$16.87	\$16.03	\$15.18	\$14.51	88
		Crimp/Solder	RG174, RG316, RG188, LMR-100, PE-B100, PE-C100, .100 inch	<a href="#">PE4051</a>	\$19.34	\$18.37	\$17.41	\$16.63	89
			RG178, RG196	<a href="#">PE4160</a>	\$20.12	\$19.11	\$18.11	\$17.30	90
			RG316-DS, RG188-DS	<a href="#">PE44876</a>	\$18.00	\$17.10	\$16.20	\$15.48	91
			RG55, RG142, RG223, RG400	<a href="#">PE4596</a>	\$23.78	\$22.59	\$21.40	\$20.45	92
		RG58, LMR-195	<a href="#">PE45193</a>	\$22.27	\$21.16	\$20.04	\$19.15	93	
PCB Mount		Solder	Thru Hole with .200 inch x .067 inch Hole Spacing	<a href="#">PE4246</a>	\$66.18	\$63.53	\$61.55	\$60.22	94
<b>Jack</b>									
Cable Connectors		Clamp/Solder	RG174, RG316, RG188	<a href="#">PE4270</a>	\$36.52	\$34.69	\$32.87	\$31.41	95
			RG174, RG316, RG188, LMR-100, PE-B100, PE-C100, .100 inch	<a href="#">PE4094</a>	\$20.81	\$19.77	\$18.73	\$17.90	96
		Crimp/Solder	RG178, RG196	<a href="#">PE4927</a>	\$39.23	\$37.27	\$35.31	\$33.74	97
			RG188-DS, RG316-DS	<a href="#">PE45156</a>	\$18.61	\$17.68	\$16.75	\$16.00	98
PCB Mount		Solder	.042 inch End Launch	<a href="#">PE44138</a>	\$18.66	\$17.91	\$17.35	\$16.98	99
			.062 inch End Launch	<a href="#">PE44136</a>	\$29.47	\$28.00	\$26.52	\$25.34	1
			.062 inch End Launch	<a href="#">PE44130</a>	\$55.94	\$53.14	\$50.35	\$48.11	2
			Surface Mount	<a href="#">PE44120</a>	\$20.78	\$19.74	\$18.70	\$17.87	3
		Thru Hole with .200 inch x .067 inch Hole Spacing	<a href="#">PE4175</a>	\$11.41	\$10.84	\$10.27	\$9.81	4	
<b>Jack, Bulkhead Mount</b>									
Cable Connectors		Clamp/Solder	RG174, RG316, RG188 with .177 inch D Hole	<a href="#">PE4278</a>	\$34.83	\$33.09	\$31.35	\$29.95	5
			RG178, RG196 with .177 inch D Hole	<a href="#">PE4279</a>	\$34.83	\$33.09	\$31.35	\$29.95	6

\* Fits MIL-C-17 and equivalent cable versions only



Technical Support  
+1 (949) 261-1920









Same-Day Shipping,  
Even Custom  
Cable Assemblies

Connectors

See Our Website For Current Pricing & Real-Time Stock Availability!

## SMC Connectors

Connection Method	Product Image	Attachment Cable/Contact	Coax Type / Termination Type	Model No.	PRICE				ROW
					1-24	25-49	50-99	100 +	
<b>Jack, Bulkhead Mount</b>									
Cable Connectors		Crimp/Solder	RG174, RG316, RG188, LMR-100, PE-B100, PE-C100, .100 inch with .177 inch D Hole	<a href="#">PE4095</a>	\$23.12	\$21.96	\$20.81	\$19.88	7
			RG178, RG196	<a href="#">PE4365</a>	\$35.10	\$33.35	\$31.59	\$30.19	8
			RG188-DS, RG316-DS with .177 inch D Hole	<a href="#">PE45157</a>	\$17.57	\$16.69	\$15.81	\$15.11	9
			RG55, RG141, RG142, RG223, RG400	<a href="#">PE44047</a>	\$28.60	\$27.17	\$25.74	\$24.60	10
			RG58	<a href="#">PE44095</a>	\$28.06	\$26.66	\$25.25	\$24.13	11
		Solder/Solder	RG405, PE-SR405FL, PE-SR405AL with .177 inch D Hole	<a href="#">PE45210</a>	\$42.77	\$41.06	\$39.78	\$38.92	12
PCB Mount		Solder	.062 inch End Launch	<a href="#">PE44848</a>	\$33.64	\$31.96	\$30.28	\$28.93	13
			Thru Hole	<a href="#">PE45147</a>	\$27.06	\$25.71	\$24.35	\$23.27	14
			Thru Hole with .177 inch D Hole	<a href="#">PE44124</a>	\$36.07	\$34.27	\$32.46	\$31.02	15
Terminal		Solder	Solder Cup with .177 inch D Hole	<a href="#">PE4107</a>	\$16.31	\$15.49	\$14.68	\$14.03	16
			Solder Cup with .177 inch D Hole	<a href="#">PE4171</a>	\$15.94	\$15.14	\$14.35	\$13.71	17
<b>Jack, 4 Hole Flange Mount</b>									
Terminal		Solder	Solder Cup with .232 inch Hole Spacing	<a href="#">PE44143</a>	\$25.46	\$24.19	\$22.91	\$21.90	18
<b>Jack Right Angle</b>									
PCB Mount		Solder	Surface Mount	<a href="#">PE44122</a>	\$9.28	\$8.82	\$8.35	\$7.98	19
			Thru Hole with .200 inch x .067 inch Hole Spacing	<a href="#">PE4178</a>	\$17.99	\$17.09	\$16.19	\$15.47	20
<b>Jack Right Angle, Bulkhead Mount</b>									
Terminal		Solder	Solder Cup with .177 inch D Hole	<a href="#">PE4285</a>	\$34.84	\$33.10	\$31.36	\$29.96	21

## SMP Connectors











Connection Method	Product Image	Attachment Cable/Contact	Coax Type / Termination Type	Model No.	PRICE			ROW
					1 Pc.	See Web for Volume Pricing		
<b>Male</b>								
PCB Mount		Solder	.062 inch End Launch	<a href="#">PE44943</a>	\$38.81	See Web for Volume Pricing		22
			.092 inch End Launch	<a href="#">PE44942</a>	\$47.33			23
			Edge Launch	<a href="#">PE44955</a>	\$35.88			24
			End Launch	<a href="#">PE44482</a>	\$30.35			25
			End Launch	<a href="#">PE44880</a>	\$15.08			26
			End Launch	<a href="#">PE44879</a>	\$15.08			27
			End Launch	<a href="#">PE44777</a>	\$15.57			28
			Surface Mount	<a href="#">PE45278TR1500</a>	\$30,459.60			29
			Surface Mount	<a href="#">PE45278TR1</a>	\$40.02			30
			Surface Mount	<a href="#">PE44944</a>	\$58.69			31
			Surface Mount	<a href="#">PE44946</a>	\$32.86			32
			Surface Mount	<a href="#">PE44947</a>	\$90.83			33
			Surface Mount	<a href="#">PE44952</a>	\$50.19			34
			Surface Mount	<a href="#">PE44481</a>	\$40.75			35
			Thru Hole	<a href="#">PE44480</a>	\$39.19			36
			Thru Hole	<a href="#">PE44958</a>	\$54.53			37
			Thru Hole	<a href="#">PE44959</a>	\$56.87			38
			Thru Hole	<a href="#">PE44960</a>	\$32.98			39
			Thru Hole	<a href="#">PE44957</a>	\$48.42			40
			Thru Hole	<a href="#">PE44965</a>	\$34.29			41
			Thru Hole	<a href="#">PE44966</a>	\$44.65			42
			Thru Hole	<a href="#">PE44967</a>	\$35.04			43
			Thru Hole	<a href="#">PE44937</a>	\$44.52			44
Thru Hole	<a href="#">PE44940</a>	\$73.52	45					
Thru Hole	<a href="#">PE44910</a>	\$37.47	46					
Thru Hole	<a href="#">PE44936</a>	\$42.37	47					
Thru Hole	<a href="#">PE44849</a>	\$15.57	48					
Thru Hole	<a href="#">PE44840</a>	\$11.75	49					

\* Fits MIL-C-17 and equivalent cable versions only

Connectors

See Our Website For Current Pricing & Real-Time Stock Availability!

# SMP Connectors

Connection Method	Product Image	Attachment Cable/Contact	Coax Type / Termination Type	Model No.	PRICE				ROW
					1-24	25-49	50-99	100 +	
<b>Male</b>									
PCB Mount		Solder	Thru Hole	<a href="#">PE44775</a>	\$17.48	\$16.61	\$15.73	\$15.03	50
			Thru Hole	<a href="#">PE44776</a>	\$11.75	\$11.16	\$10.58	\$10.11	51
			Thru Hole with .100 inch x .031 inch Hole Spacing	<a href="#">PE44348</a>	\$37.35	\$35.48	\$33.62	\$32.12	52
Terminal		Solder	Pin	<a href="#">PE44779</a>	\$23.41	\$22.24	\$21.07	\$20.13	53
			Pin	<a href="#">PE44780</a>	\$23.85	\$22.66	\$21.47	\$20.51	54
<b>Male, Bulkhead Mount</b>									
Cable Connectors		Solder/Solder	PE-SR405AL, PE-SR405FL, PE-SR405FLJ, PE-SR405TN, RG405	<a href="#">PE44961</a>	\$40.86	\$38.82	\$36.77	\$35.14	55
			RG405, PE-SR405FL, PE-SR405FLJ	<a href="#">PE45126</a>	\$36.74	\$34.90	\$33.07	\$31.60	56
			RG405, RG405 Tinned, PE-SR405FL, PE-SR405AL, PE-SR405FLJ, PE-SR405TN with 4.83 mm Diameter	<a href="#">PE44483</a>	\$52.21	\$49.60	\$46.99	\$44.90	57
<b>Male, 2 Hole Flange Mount</b>									
Cable Connectors		Solder/Solder	RG405, PE-SR405FL, PE-SR405FLJ	<a href="#">PE45127</a>	\$39.04	\$37.09	\$35.14	\$33.57	58
Shroud		None	None	<a href="#">PE44948</a>	\$21.71	\$20.62	\$19.54	\$18.67	59
			None	<a href="#">PE44907</a>	\$20.11	\$19.10	\$18.10	\$17.29	60
			None	<a href="#">PE44949</a>	\$21.52	\$20.44	\$19.37	\$18.51	61
			None	<a href="#">PE44950</a>	\$21.92	\$20.82	\$19.73	\$18.85	62
			None	<a href="#">PE44951</a>	\$27.16	\$25.80	\$24.44	\$23.36	63
			None	<a href="#">PE44916</a>	\$21.11	\$20.27	\$19.63	\$19.21	64
Terminal		Solder	Pin	<a href="#">PE44938</a>	\$49.93	\$47.43	\$44.94	\$42.94	66
			<b>Male, Solder</b>						
Shroud		None	None	<a href="#">PE44932</a>	\$21.92	\$20.82	\$19.73	\$18.85	67
Terminal		Solder	Pin	<a href="#">PE44933</a>	\$44.54	\$42.31	\$40.09	\$38.30	68
			Pin	<a href="#">PE44945</a>	\$53.96	\$51.26	\$48.56	\$46.41	69
			Pin	<a href="#">PE44923</a>	\$34.92	\$33.17	\$31.43	\$30.03	70
			Pin	<a href="#">PE44924</a>	\$36.89	\$35.05	\$33.20	\$31.73	71
			Pin	<a href="#">PE44928</a>	\$38.29	\$36.38	\$34.46	\$32.93	72
			Pin	<a href="#">PE44921</a>	\$33.30	\$31.64	\$29.97	\$28.64	73
			Pin	<a href="#">PE44922</a>	\$38.66	\$36.73	\$34.79	\$33.25	74
			Pin	<a href="#">PE44925</a>	\$32.08	\$30.48	\$28.87	\$27.59	75
			Pin	<a href="#">PE44926</a>	\$35.69	\$33.91	\$32.12	\$30.69	76
			Pin	<a href="#">PE44927</a>	\$30.86	\$29.32	\$27.77	\$26.54	77
			Pin	<a href="#">PE44930</a>	\$30.86	\$29.32	\$27.77	\$26.54	78
			Pin	<a href="#">PE44918</a>	\$37.61	\$35.73	\$33.85	\$32.34	79
			Pin	<a href="#">PE44919</a>	\$38.66	\$36.73	\$34.79	\$33.25	80
Pin	<a href="#">PE44920</a>	\$29.11	\$27.65	\$26.20	\$25.03	81			
<b>Male, Thread-In</b>									
Shroud		None	None	<a href="#">PE44953</a>	\$27.73	\$26.34	\$24.96	\$23.85	82
Terminal		Solder	Pin	<a href="#">PE44963</a>	\$44.12	\$41.91	\$39.71	\$37.94	83
			Pin	<a href="#">PE44964</a>	\$70.99	\$67.44	\$63.89	\$61.05	84
			Pin	<a href="#">PE44909</a>	\$46.04	\$43.74	\$41.44	\$39.59	85
			Pin	<a href="#">PE44912</a>	\$35.28	\$33.52	\$31.75	\$30.34	86
			Pin	<a href="#">PE44956</a>	\$79.38	\$75.41	\$71.44	\$68.27	87
Pin	<a href="#">PE44931</a>	\$55.83	\$53.04	\$50.25	\$48.01	88			
<b>Male Right Angle</b>									
PCB Mount		Solder	Thru Hole	<a href="#">PE44934</a>	\$64.60	\$61.37	\$58.14	\$55.56	89





Connectors

See Our Website For Current Pricing & Real-Time Stock Availability!







\* Fits MIL-C-17 and equivalent cable versions only



## SMP Connectors

Connection Method	Product Image	Attachment Cable/Contact	Coax Type / Termination Type	Model No.	PRICE				ROW
					1-24	25-49	50-99	100 +	
<b>Female</b>									
Cable Connectors		Solder	PE-047SR, PE-SR047AL, PE-SR047FL	<a href="#">PE45277</a>	\$5.20	\$4.99	\$4.84	\$4.73	90
			Solder/Solder	.086 Microporous	<a href="#">PE44917</a>	\$31.93	\$30.33	\$28.74	\$27.46
	PE-047SR, PE-SR047AL, PE-SR047FL	<a href="#">PE44785</a>		\$27.21	\$25.85	\$24.49	\$23.40	92	
	PE-SR405AL, PE-SR405FL, PE-SR405FLJ, PE-SR405TN, RG405	<a href="#">PE44786</a>		\$24.89	\$23.65	\$22.40	\$21.41	93	
	RG178, RG196	<a href="#">PE44655</a>		\$56.23	\$53.42	\$50.61	\$48.36	94	
	RG178, RG196	<a href="#">PE45287</a>	\$11.54	\$10.96	\$10.39	\$9.92	95		
RG405, PE-SR405AL, PE-SR405FL, PE-SR405FLJ	<a href="#">PE45285</a>	\$11.30	\$10.74	\$10.17	\$9.72	96			
PCB Mount		Solder	Thru Hole	<a href="#">PE44939</a>	\$76.46	\$72.64	\$68.81	\$65.76	97
<b>Female Right Angle</b>									
Cable Connectors		Crimp/Solder	RG178, RG196	<a href="#">PE45290</a>	\$11.25	\$10.69	\$10.13	\$9.68	98
			RG316, RG174, LMR-100	<a href="#">PE45128</a>	\$16.41	\$15.59	\$14.77	\$14.11	99
		Solder	PE-047SR, PE-SR047AL, PE-SR047FL	<a href="#">PE45249</a>	\$14.44	\$13.72	\$13.00	\$12.42	1
			RG405, PE-SR405AL, PE-SR405FL, PE-SR405FLJ	<a href="#">PE45248</a>	\$11.90	\$11.31	\$10.71	\$10.23	2
			RG405, PE-SR405FL, PE-SR405FLJ	<a href="#">PE44915</a>	\$31.40	\$29.83	\$28.26	\$27.00	3
		Solder/Solder	PE-047SR, PE-SR047AL, PE-SR047FL	<a href="#">PE44274</a>	\$58.27	\$55.36	\$52.44	\$50.11	4
			PE-047SR, PE-SR047FL, PE-SR047AL	<a href="#">PE44911</a>	\$36.22	\$34.41	\$32.60	\$31.15	5
			PE-SR405AL, PE-SR405FL, PE-SR405FLJ, PE-SR405TN, RG405	<a href="#">PE44908</a>	\$37.46	\$35.59	\$33.71	\$32.22	6
			PE-SR405AL, PE-SR405FL, PE-SR405FLJ, PE-SR405TN, RG405	<a href="#">PE44275</a>	\$37.49	\$35.62	\$33.74	\$32.24	7
RG178, RG196			<a href="#">PE44914</a>	\$43.18	\$41.02	\$38.86	\$37.13	8	
RG405, PE-SR405FL, PE-SR405FLJ			<a href="#">PE44913</a>	\$62.95	\$59.80	\$56.66	\$54.14	9	

## SSMA Connectors















Connection Method	Product Image	Attachment Cable/Contact	Coax Type / Termination Type	Model No.	PRICE				ROW	
					1-24	25-49	50-99	100 +		
<b>Male</b>										
Cable Connectors		Crimp/Solder	RG174, RG316, RG188, LMR-100, PE-B100, PE-C100, .100 inch	<a href="#">PE44379</a>	\$27.59	\$26.21	\$24.83	\$23.73	10	
			RG178, RG196	<a href="#">PE44381</a>	\$31.72	\$30.13	\$28.55	\$27.28	11	
			RG188-DS, RG316-DS	<a href="#">PE44416</a>	\$26.85	\$25.51	\$24.17	\$23.09	12	
		Solder (Without Contact)	PE-SR405AL, PE-SR405FL, PE-SR405FLJ, RG405	<a href="#">PE44382</a>	\$28.60	\$27.17	\$25.74	\$24.60	13	
			Solder/Solder	PE-034SR	<a href="#">PE44440</a>	\$32.53	\$30.90	\$29.28	\$27.98	14
				PE-047SR, PE-SR047AL, PE-SR047FL	<a href="#">PE44441</a>	\$38.70	\$36.77	\$34.83	\$33.28	15
PE-SR405AL, PE-SR405FL, PE-SR405FLJ, RG405				<a href="#">PE44383</a>	\$39.13	\$37.17	\$35.22	\$33.65	16	
RG174, RG316, RG188	<a href="#">PE4184</a>	\$27.57		\$26.19	\$24.81	\$23.71	17			
RG178, RG196	<a href="#">PE4199</a>	\$30.07	\$28.57	\$27.06	\$25.86	18				
PCB Mount		Solder	Thru Hole with .200 inch x .067 inch Hole Spacing	<a href="#">PE44430</a>	\$29.36	\$27.89	\$26.42	\$25.25	19	
<b>Male, 4 Hole Flange Mount</b>										
Terminal		Solder	Solder Cup with .232 inch Hole Spacing	<a href="#">PE44432</a>	\$29.89	\$28.40	\$26.90	\$25.71	20	
<b>Male Right Angle</b>										
Cable Connectors		Crimp/Solder	RG174, RG316, RG188, PE-B100, PE-C100, .100 inch, LMR-100	<a href="#">PE44378</a>	\$30.69	\$29.16	\$27.62	\$26.39	21	
			RG178, RG196	<a href="#">PE44380</a>	\$62.53	\$59.40	\$56.28	\$53.78	22	
			RG188-DS, RG316-DS	<a href="#">PE44418</a>	\$38.30	\$36.39	\$34.47	\$32.94	23	
		Solder/Solder	PE-034SR	<a href="#">PE44420</a>	\$62.21	\$59.10	\$55.99	\$53.50	24	
			PE-047SR, PE-SR047AL, PE-SR047FL	<a href="#">PE44421</a>	\$65.68	\$62.40	\$59.11	\$56.48	25	
			PE-SR405AL, PE-SR405FL, PE-SR405FLJ, RG405	<a href="#">PE44384</a>	\$45.57	\$43.29	\$41.01	\$39.19	26	

\* Fits MIL-C-17 and equivalent cable versions only

Connectors

See Our Website For Current Pricing & Real-Time Stock Availability!

# SSMA Connectors









Connection Method	Product Image	Attachment Cable/Contact	Coax Type / Termination Type	Model No.	PRICE				ROW
					1-24	25-49	50-99	100 +	
<b>Male Right Angle</b>									
Cable Connectors		Solder/Solder	RG174, RG316, RG188	<a href="#">PE44401</a>	\$38.93	\$36.98	\$35.04	\$33.48	27
			RG178, RG196	<a href="#">PE44402</a>	\$37.50	\$36.00	\$34.88	\$34.13	28
			RG188-DS, RG316-DS	<a href="#">PE44419</a>	\$33.28	\$31.62	\$29.95	\$28.62	29
<b>Female</b>									
Cable Connectors		Crimp/Solder	RG174, RG316, RG188, PE-B100, PE-C100, .100 inch, LMR-100	<a href="#">PE44385</a>	\$29.52	\$28.04	\$26.57	\$25.39	30
			RG178, RG196	<a href="#">PE44386</a>	\$52.06	\$49.46	\$46.85	\$44.77	31
			RG188-DS, RG316-DS	<a href="#">PE44422</a>	\$30.85	\$29.31	\$27.77	\$26.53	32
		Solder/Solder	PE-034SR	<a href="#">PE44424</a>	\$38.23	\$36.32	\$34.41	\$32.88	33
			PE-047SR, PE-SR047AL, PE-SR047FL	<a href="#">PE44425</a>	\$36.45	\$34.63	\$32.81	\$31.35	34
			PE-SR405AL, PE-SR405FL, PE-SR405FLJ, RG405	<a href="#">PE44387</a>	\$32.65	\$31.02	\$29.39	\$28.08	35
			RG174, RG316, RG188	<a href="#">PE44403</a>	\$29.17	\$27.71	\$26.25	\$25.09	36
PCB Mount		Solder	RG178, RG196	<a href="#">PE44404</a>	\$32.42	\$30.80	\$29.18	\$27.88	37
			Thru Hole with .200 inch x .067 inch Hole Spacing	<a href="#">PE44391</a>	\$37.76	\$35.87	\$33.98	\$32.47	38
<b>Female, Bulkhead Mount</b>									
Cable Connectors		Crimp/Solder	.100 inch, RG316, RG174, RG188, LMR-100, LMR-100A, LMR-100A-FR, PE-C100, PE-B100 with .177 inch D Hole	<a href="#">PE44388</a>	\$48.56	\$46.13	\$43.70	\$41.76	39
			RG178, RG196 with .177 inch D Hole	<a href="#">PE44389</a>	\$43.49	\$41.32	\$39.14	\$37.40	40
			RG188-DS, RG316-DS with .177 inch D Hole	<a href="#">PE44426</a>	\$33.11	\$31.45	\$29.80	\$28.47	41
		Solder/Solder	PE-034SR with .177 inch D Hole	<a href="#">PE44428</a>	\$50.61	\$48.08	\$45.55	\$43.52	42
			PE-047SR, PE-SR047AL, PE-SR047FL with .177 inch D Hole	<a href="#">PE44429</a>	\$54.72	\$51.98	\$49.25	\$47.06	43
			PE-SR405AL, PE-SR405FL, RG405 with .177 inch D Hole	<a href="#">PE44390</a>	\$38.65	\$36.72	\$34.79	\$33.24	44
			RG174, RG316, RG188 with .177 inch D Hole	<a href="#">PE44405</a>	\$28.03	\$26.63	\$25.23	\$24.11	45
PCB Mount		Solder	RG178, RG196 with .177 inch D Hole	<a href="#">PE44406</a>	\$30.85	\$29.31	\$27.77	\$26.53	46
			RG188-DS, RG316-DS with .177 inch D Hole	<a href="#">PE44427</a>	\$27.47	\$26.10	\$24.72	\$23.62	47
Terminal		Solder	.042 inch End Launch	<a href="#">PE45405</a>	\$30.25	\$28.74	\$27.23	\$26.02	48
			.062 inch End Launch	<a href="#">PE45406</a>	\$30.25	\$28.74	\$27.23	\$26.02	49
Terminal		Solder	Solder Cup with .177 inch D Hole	<a href="#">PE44393</a>	\$34.98	\$33.23	\$31.48	\$30.08	50
			Turret with .177 inch D Hole	<a href="#">PE44392</a>	\$41.66	\$39.58	\$37.49	\$35.83	51
<b>Female, 2 Hole Flange Mount</b>									
Cable Connectors		Solder/Solder	PE-047SR, PE-SR047AL, PE-SR047FL with .328 inch Hole Spacing	<a href="#">PE44436</a>	\$49.10	\$46.65	\$44.19	\$42.23	52
			PE-SR405AL, PE-SR405FL, PE-SR405FLJ, RG405 with .328 inch Hole Spacing	<a href="#">PE44437</a>	\$26.62	\$25.29	\$23.96	\$22.89	53
Terminal		Solder	Pin with .328 inch Hole Spacing	<a href="#">PE44433</a>	\$53.61	\$50.93	\$48.25	\$46.10	54
			Solder Cup with .328 inch Hole Spacing	<a href="#">PE44395</a>	\$53.64	\$50.96	\$48.28	\$46.13	55
<b>Female, 4 Hole Flange Mount</b>									
Terminal		Solder	Pin with .232 inch Hole Spacing	<a href="#">PE44434</a>	\$48.73	\$46.29	\$43.86	\$41.91	56
			Solder Cup with .232 inch Hole Spacing	<a href="#">PE44394</a>	\$41.38	\$39.31	\$37.24	\$35.59	57
Cable Connectors		Solder/Solder	PE-047SR, PE-SR047AL, PE-SR047FL with .232 inch Hole Spacing	<a href="#">PE44438</a>	\$50.07	\$47.57	\$45.06	\$43.06	58
			PE-SR405AL, PE-SR405FL, RG405 with .232 inch Hole Spacing	<a href="#">PE44439</a>	\$41.92	\$39.82	\$37.73	\$36.05	59
<b>Female Right Angle</b>									
PCB Mount		Solder	Thru Hole with .200 inch x .067 inch Hole Spacing	<a href="#">PE44435</a>	\$67.86	\$64.47	\$61.07	\$58.36	60

Connectors





See Our Website For Current Pricing & Real-Time Stock Availability!

\* Fits MIL-C-17 and equivalent cable versions only

## SSMB Connectors

Connection Method	Product Image	Attachment Cable/Contact	Coax Type / Termination Type	Model No.	PRICE				ROW
					1-24	25-49	50-99	100 +	
<b>Plug</b>									
Cable Connectors		Crimp/Solder	RG174, RG316, RG188, LMR-100, PE-B100, PE-C100, .100 inch	<a href="#">PE4017</a>	\$38.59	\$36.66	\$34.73	\$33.19	61
			RG188-DS, RG316-DS	<a href="#">PE45153</a>	\$31.34	\$29.77	\$28.21	\$26.95	62
<b>Plug Right Angle</b>									
Cable Connectors		Crimp/Solder	RG174, RG179, RG316, RG188, PE-B100, PE-C100, .100 inch, LMR-100	<a href="#">PE4334</a>	\$59.29	\$56.33	\$53.36	\$50.99	63
			RG178, RG196	<a href="#">PE45195</a>	\$23.08	\$21.93	\$20.77	\$19.85	64
			RG188-DS, RG316-DS	<a href="#">PE45162</a>	\$30.85	\$29.62	\$28.69	\$28.07	65
<b>Jack</b>									
Cable Connectors		Crimp/Solder	RG178, RG196	<a href="#">PE4019</a>	\$31.89	\$30.30	\$28.70	\$27.43	66
PCB Mount		Solder	Thru Hole with .100 inch x .031 inch Hole Spacing	<a href="#">PE4340</a>	\$16.58	\$15.75	\$14.92	\$14.26	67
<b>Jack, Bulkhead Mount</b>									
Cable Connectors		Crimp/Solder	.100 inch, RG316, RG174, RG188, LMR-100, LMR-100A, LMR-100A-FR, PE-C100, PE-B100 with .126 inch D Hole	<a href="#">PE4336</a>	\$42.89	\$40.75	\$38.60	\$36.89	68
			RG178, RG196 with .126 inch D Hole	<a href="#">PE4337</a>	\$37.62	\$35.74	\$33.86	\$32.35	69
			RG316-DS, RG188-DS with .126 inch D Hole	<a href="#">PE44842</a>	\$33.20	\$31.54	\$29.88	\$28.55	70
Terminal		Solder	Turret with .126 inch D Hole	<a href="#">PE4338</a>	\$28.14	\$26.73	\$25.33	\$24.20	71
			Turret with .126 inch D Hole	<a href="#">PE4339</a>	\$29.18	\$27.72	\$26.26	\$25.09	72
<b>Jack, 4 Hole Flange Mount</b>									
Terminal		Solder	Tab with .164 inch x .067 inch Hole Spacing	<a href="#">PE44455</a>	\$28.36	\$26.94	\$25.52	\$24.39	73
<b>Jack Right Angle</b>									
PCB Mount		Solder	Thru Hole with .100 inch x .031 inch Hole Spacing	<a href="#">PE4341</a>	\$28.80	\$27.36	\$25.92	\$24.77	74

## SSMC Connectors











Connection Method	Product Image	Attachment Cable/Contact	Coax Type / Termination Type	Model No.	PRICE				ROW
					1-24	25-49	50-99	100 +	
<b>Plug</b>									
Cable Connectors		Clamp/Solder	PE-047SR, PE-SR047AL, PE-SR047FL	<a href="#">PE45366</a>	\$28.05	\$26.65	\$25.25	\$24.12	75
			PE-SR405AL, PE-SR405FL, PE-SR405FLJ, PE-SR405TN, RG405	<a href="#">PE45365</a>	\$26.81	\$25.47	\$24.13	\$23.06	76
		Crimp/Solder	LMR-100A, RG188, RG174, PE-C100-LSZH, PE-B100, LMR-100A-FR, RG316	<a href="#">PE45491</a>	\$27.57	\$26.19	\$24.81	\$23.71	77
			RG178, RG196	<a href="#">PE45490</a>	\$29.30	\$27.84	\$26.37	\$25.20	78
			RG188-DS, RG316-DS	<a href="#">PE45492</a>	\$28.63	\$26.63	\$24.62	\$22.90	79
Cable Connectors		Crimp/Solder	RG178, RG196	<a href="#">PE45496</a>	\$20.86	\$19.82	\$18.77	\$17.94	81
			RG316, RG188, RG174, PE-C100-LSZH, PE-B100, LMR-100A-FR, LMR-100A	<a href="#">PE45497</a>	\$23.79	\$22.60	\$21.41	\$20.46	82
			RG316-DS, RG188-DS	<a href="#">PE45498</a>	\$23.00	\$21.39	\$19.78	\$18.40	83
		Solder/Solder	PE-047SR, PE-SR047AL, PE-SR047FL	<a href="#">PE45385</a>	\$26.93	\$25.58	\$24.24	\$23.16	84
			PE-SR405AL, PE-SR405FL, PE-SR405FLJ, PE-SR405TN, RG405	<a href="#">PE45384</a>	\$25.72	\$24.43	\$23.15	\$22.12	85
PCB Mount		Solder	Thru Hole	<a href="#">PE45379</a>	\$32.56	\$30.93	\$29.30	\$28.00	86

\* Fits MIL-C-17 and equivalent cable versions only

Connectors

See Our Website For Current Pricing & Real-Time Stock Availability!



## SSMC Connectors

Connection Method	Product Image	Attachment Cable/Contact	Coax Type / Termination Type	Model No.	PRICE				ROW
					1 Pc.	See Web for Volume Pricing			
<b>Jack</b>									
PCB Mount		Solder	Surface Mount	<a href="#">PE45376</a>	\$22.85				87
<b>Jack, Bulkhead Mount</b>									
Cable Connectors		Clamp/Solder	PE-047SR, PE-SR047AL, PE-SR047FL	<a href="#">PE45371</a>	\$26.77	See Web for Volume Pricing			88
			PE-SR405AL, PE-SR405FL, PE-SR405FLJ, PE-SR405TN, RG405	<a href="#">PE45370</a>	\$19.32				89
		Crimp/Solder	RG-178, RG-196	<a href="#">PE45493</a>	\$25.73				90
			RG316, RG188	<a href="#">PE45494</a>	\$25.43				91
Terminal		Solder	Turret	<a href="#">PE45375</a>	\$21.02				92
			Turret	<a href="#">PE45390</a>	\$19.41				93
<b>Jack, 2 Hole Flange Mount</b>									
Terminal		Solder	Solder Cup	<a href="#">PE45380</a>	\$116.78				94
<b>Jack, 4 Hole Flange Mount</b>									
Terminal		Solder	Solder Cup	<a href="#">PE45391</a>	\$69.16				95
<b>Jack Right Angle</b>									
PCB Mount		Solder	Surface Mount	<a href="#">PE45377</a>	\$30.76				96
<b>Jack Right Angle, Bulkhead Mount</b>									
Cable Connectors		Crimp/Solder	PE-SR405AL, PE-SR405FL, PE-SR405FLJ, PE-SR405TN, RG405	<a href="#">PE45387</a>	\$35.82	See Web for Volume Pricing			97
			RG178, RG196	<a href="#">PE45499</a>	\$23.05				98
		Solder/Solder	PE-047SR, PE-SR047AL, PE-SR047FL	<a href="#">PE45388</a>	\$39.84				99
PCB Mount		Solder	Turret	<a href="#">PE45389</a>	\$45.59				1
Terminal			Turret	<a href="#">PE45378</a>	\$42.30				2

Connectors

See Our Website For Current Pricing & Real-Time Stock Availability!

## TNC Connectors

Connection Method	Product Image	Attachment Cable/Contact	Coax Type / Termination Type	Model No.	PRICE				ROW
					1-24	25-49	50-99	100 +	
<b>Sexless</b>									
Cable Connectors		Accessories	RG58, RG303, RG141, PE-C195, PE-P195, LMR-195, .195 inch	<a href="#">PE4022</a>	\$2.38	\$2.26	\$2.14	\$2.05	3
<b>Male</b>									
Cable Connectors		Clamp/Solder	PE-C200	<a href="#">PE44061</a>	\$18.23	\$17.32	\$16.41	\$15.68	4
			PE-C400, PE-B400, PE-B405, LMR-400, LMR-400-DB, LMR-400-UF, .400 inch	<a href="#">PE4449</a>	\$22.43	\$21.53	\$20.86	\$20.41	5
			PE-P142LL	<a href="#">PE44815</a>	\$71.38	\$67.81	\$64.24	\$61.39	6
			PE-P160LL	<a href="#">PE45443</a>	\$80.44	\$76.42	\$72.40	\$69.18	7
			PE-P300LL	<a href="#">PE44810</a>	\$108.89	\$103.45	\$98.00	\$93.65	8

\* Fits MIL-C-17 and equivalent cable versions only









Technical Support  
+1 (949) 261-1920



Same-Day Shipping,  
Even Custom  
Cable Assemblies













# TNC Connectors

Connection Method	Product Image	Attachment Cable/Contact	Coax Type / Termination Type	Model No.	PRICE		R O W
					1 Pc.	See Web for Volume Pricing	
<b>Male</b>							
Cable Connectors		Clamp/Solder	PE-SR402AL, PE-SR402FL, RG402	<a href="#">PE4143</a>	\$25.07	See Web for Volume Pricing	9
			PE-SR405AL, PE-SR405FL, RG405	<a href="#">PE4142</a>	\$22.79		10
			RG174, RG316, RG188	<a href="#">PE4303</a>	\$17.36		11
			RG178, RG196	<a href="#">PE4448</a>	\$21.89		12
			RG213, RG214, RG8, RG9, RG11*, RG225, RG393, RG144*, RG215, RG216*	<a href="#">PE4088</a>	\$22.21		13
			RG58, RG55, RG141, RG142, RG223, RG400, RG303, PE-C195, PE-P195, LMR-195	<a href="#">PE4067</a>	\$28.23		14
			RG59*, RG62*, RG71	<a href="#">PE4154</a>	\$18.29		15
			RG8X, PE-C240, .240 inch, B7808A, LMR-240	<a href="#">PE45437</a>	\$23.74		16
			PE-C200, LMR-200	<a href="#">PE44804</a>	\$11.33		17
			RG174, RG316, RG188, LMR-100, PE-B100, PE-C100, .100 inch	<a href="#">PE4302</a>	\$23.32		18
	RG188-DS, RG316-DS	<a href="#">PE45161</a>	\$22.80	19			
	RG55, RG142, RG223, RG400	<a href="#">PE4047</a>	\$14.70	20			
	Crimp/Crimp	Crimp/Non-Solder Contact	LMR-200, PE-C200	<a href="#">EZ-200-TM-X</a>	\$20.75		21
			LMR-240, PE-C240	<a href="#">EZ-240-TM-X</a>	\$14.78		22
			LMR-400, PE-C400, PE-B400, PE-B405	<a href="#">EZ-400-TM-X</a>	\$13.55		23
		Crimp/Solder	LMR-600, PE-C600	<a href="#">EZ-600-TM-X</a>	\$20.33		24
			LMR-100A-PVC, PE-C100, RG174, RG188, RG316	<a href="#">SC-100-TM-D</a>	\$18.86		25
			LMR-195, PE-C195	<a href="#">TC-195-TM-X</a>	\$15.25		26
			LMR-240, PE-C240	<a href="#">TC-240-TM-X</a>	\$12.32		27
			LMR-400, PE-C400	<a href="#">TC-400-TM-X</a>	\$12.01		28
			PE-C200	<a href="#">PE44062</a>	\$20.05		29
			PE-C240, RG8X, .240 inch, LMR-240, LMR-240-DB, LMR-240-UF, B7808A	<a href="#">PE44634</a>	\$15.36		30
			PE-C400, PE-B400, PE-B405, LMR-400, LMR-400-DB, LMR-400-UF, .400 inch	<a href="#">PE44293</a>	\$37.49		31
			RG122, RG58 Plenum, RG58-P	<a href="#">PE45065</a>	\$7.31		32
			RG213, RG8	<a href="#">PE4446</a>	\$21.49		33
	RG214, RG9, RG225, RG393	<a href="#">PE4447</a>	\$31.51	34			
	RG58, RG303, RG141, PE-C195, PE-P195, LMR-195, .195 inch	<a href="#">PE4156</a>	\$8.87	35			
	RG59*, RG62*, RG71	<a href="#">PE4071</a>	\$14.55	36			
		Solder/Solder	PE-047SR, PE-SR047AL, PE-SR047FL	<a href="#">PE4975</a>	\$31.41		37
			PE-SR401AL, PE-SR401FL, RG401	<a href="#">PE4909</a>	\$73.13		38
			PE-SR402AL, PE-SR402FL, PE-SR402FLJ, PE-SR402TN, RG402	<a href="#">PE44709</a>	\$16.94		39
			PE-SR402AL, PE-SR402FL, PE-SR402FLJ, PE-SR402TN, RG402 with .480 inch D Hole	<a href="#">PE4648</a>	\$34.32		40
			PE-SR405AL, PE-SR405FL, PE-SR405FLJ, PE-SR405TN, RG405	<a href="#">PE44708</a>	\$16.94		41
			PE-SR405AL, PE-SR405FL, RG405	<a href="#">PE4649</a>	\$31.61		42
<b>Male, 4 Hole Flange Mount</b>							
Terminal		Solder	Pin with .531 inch Hole Spacing	<a href="#">PE44654</a>	\$81.51		43
			Solder Cup with .531 inch Hole Spacing	<a href="#">PE4470</a>	\$25.60		44
<b>Male Right Angle</b>							
Cable Connectors		Clamp/Solder	PE-P142LL	<a href="#">PE44812</a>	\$158.00	See Web for Volume Pricing	45
			PE-P160LL	<a href="#">PE45445</a>	\$142.68		46
			RG174, RG316, RG188	<a href="#">PE4454</a>	\$23.20		47
			RG213, RG214, RG8, RG9, RG11*, RG225, RG393, RG144*, RG216*, RG215	<a href="#">PE4146</a>	\$39.94		48
			RG58, RG55, RG141, RG142, RG223, RG400, RG303, PE-C195, PE-P195, LMR-195	<a href="#">PE4054</a>	\$29.78		49
	RG59*, RG62*	<a href="#">PE4452</a>	\$51.79	50			
		Crimp/Crimp	RG58, RG303, RG141, PE-C195, PE-P195, LMR-195, .195 inch	<a href="#">PE4451</a>	\$31.51		51
			Crimp/Solder	LMR-400, PE-C400	<a href="#">TC-400-TM-RA-D</a>		\$25.87
	PE-C200, LMR-200	<a href="#">PE44846</a>		\$21.86	53		
	PE-C240, RG8X, .240 inch, LMR-240, LMR-240-DB, LMR-240-UF, B7808A	<a href="#">PE44635</a>		\$27.24	54		
	RG174, RG316, RG188, .100 inch, PE-B100, PE-C100, LMR-100	<a href="#">PE4455</a>		\$29.73	55		
	RG188-DS, RG316-DS	<a href="#">PE45174</a>		\$25.94	56		
	RG55, RG141, RG142, RG223, RG400	<a href="#">PE4450</a>		\$19.49	57		

\* Fits MIL-C-17 and equivalent cable versions only

# TNC Connectors

Connection Method	Product Image	Attachment Cable/Contact	Coax Type / Termination Type	Model No.	PRICE			ROW
					1 Pc.	See Web for Volume Pricing		
<b>Male Right Angle</b>								
Cable Connectors		Solder/Solder	PE-SR402AL, PE-SR402FL, PE-SR402FLJ, PE-SR402TN, RG402	<a href="#">PE44711</a>	\$17.97			58
			PE-SR405AL, PE-SR405FL, PE-SR405FLJ, PE-SR405TN, RG405	<a href="#">PE44710</a>	\$17.96			59
<b>Female</b>								
Cable Connectors		Clamp/Solder	PE-SR402AL, PE-SR402FL, RG402	<a href="#">PE4145</a>	\$25.06	See Web for Volume Pricing		60
			PE-SR405AL, PE-SR405FL, RG405	<a href="#">PE4144</a>	\$25.06			61
			RG174, RG316, RG188	<a href="#">PE4461</a>	\$17.86			62
			RG178, RG196	<a href="#">PE4463</a>	\$20.05			63
			RG213, RG214, RG8, RG9, RG11*, RG225, RG393, RG144*, RG216*, RG215	<a href="#">PE4155</a>	\$42.65			64
			RG58, RG55, RG141, RG142, RG223, RG400, RG303, PE-C195, PE-P195, LMR-195	<a href="#">PE4068</a>	\$15.95			65
			RG59*, RG62*, RG71	<a href="#">PE4460</a>	\$17.69			66
			PE-C240, RG8X, .240 inch, LMR-240, LMR-240-DB, LMR-240-UF, B7808A	<a href="#">PE44636</a>	\$21.31			67
		Crimp/Solder	RG174, RG316, RG188, PE-B100, PE-C100, .100 inch, LMR-100	<a href="#">PE4462</a>	\$23.18			68
			RG316, RG174, LMR-100	<a href="#">PE45143</a>	\$11.44			69
			RG55, RG142, RG223, RG400	<a href="#">PE4457</a>	\$17.01			70
			RG58, RG303, RG141, PE-C195, PE-P195, LMR-195, .195 inch	<a href="#">PE4458</a>	\$18.09			71
		Solder	LMR-400, LMR-400-DB, LMR-400-UF, PE-B400, PE-B405, PE-C400	<a href="#">PE45639</a>	\$6.97			73
				Solder/Solder	PE-SR402AL, PE-SR402FL, PE-SR402FLJ, PE-SR402TN, RG402			<a href="#">PE44713</a>
	PE-SR405AL, PE-SR405FL, PE-SR405FLJ, PE-SR405TN, RG405	<a href="#">PE44712</a>			\$14.53			75
	<b>Female, Bulkhead Mount</b>							
Cable Connectors		Clamp/Solder	PE-047SR, PE-SR047AL, PE-SR047FL	<a href="#">PE44897</a>	\$36.68	See Web for Volume Pricing		76
			PE-P142LL	<a href="#">PE44811</a>	\$106.68			77
			PE-P160LL	<a href="#">PE45444</a>	\$109.39			78
			PE-SR402AL, PE-SR402FL, RG402 with .480 inch D Hole	<a href="#">PE4150</a>	\$29.17			79
			PE-SR405AL, PE-SR405FL, RG405 with .480 inch D Hole	<a href="#">PE4149</a>	\$29.17			80
			RG174, RG316, RG188 with .480 inch D Hole	<a href="#">PE4304</a>	\$24.61			81
			RG178, RG196 with .480 inch D Hole	<a href="#">PE4467</a>	\$23.20			82
			RG58, RG142, RG223, RG400, RG141, RG303, RG55, PE-C195, PE-P195 with .480 inch D Hole	<a href="#">PE4152</a>	\$20.79			83
		Crimp/Solder	RG59*, RG62*, RG71 with .480 inch D Hole	<a href="#">PE4464</a>	\$35.16			84
			RG174, RG316, RG188, .100 inch, PE-B100, PE-C100, LMR-100	<a href="#">PE44899</a>	\$65.62			85
			RG174, RG316, RG188, .100 inch, PE-B100, PE-C100, LMR-100	<a href="#">PE44900</a>	\$66.88			86
			RG174, RG316, RG188, LMR-100, PE-B100, PE-C100, .100 inch with .480 inch D Hole	<a href="#">PE4466</a>	\$28.02			87
			RG188-DS, RG316-DS with .480 inch D Hole	<a href="#">PE45177</a>	\$25.44			88
			RG55, RG142, RG223, RG400 with .480 inch D Hole	<a href="#">PE4153</a>	\$21.88			89
			RG58, RG303, RG141, PE-C195, PE-P195, LMR-195, .195 inch with .480 inch D Hole	<a href="#">PE4151</a>	\$23.72			90
			RG59*, RG62* with .480 inch D Hole	<a href="#">PE4465</a>	\$27.29			91
	Solder	RG178, RG196	<a href="#">PE45132</a>	\$25.41	92			
			Solder/Solder	PE-SR402AL, PE-SR402FL, PE-SR402FLJ, PE-SR402TN, RG402	<a href="#">PE44715</a>	\$20.14	93	
PE-SR402AL, PE-SR402FL, RG402 with .480 inch D Hole	<a href="#">PE4148</a>			\$77.94	94			
PE-SR405AL, PE-SR405FL, PE-SR405FLJ, PE-SR405TN, RG405	<a href="#">PE44714</a>			\$20.71	95			
PE-SR405AL, PE-SR405FL, PE-SR405FLJ, PE-SR405TN, RG405	<a href="#">PE44898</a>			\$54.50	96			
PCB Mount		Solder	Edge Mount	<a href="#">PE44894</a>	\$74.48			97

**Connectors**

See Our Website For Current Pricing & Real-Time Stock Availability!

\* Fits MIL-C-17 and equivalent cable versions only









Technical Support  
+1 (949) 261-1920







Same-Day Shipping,  
Even Custom  
Cable Assemblies

## TNC Connectors











Connection Method	Product Image	Attachment Cable/Contact	Coax Type / Termination Type	Model No.	PRICE				ROW
					1-24	25-49	50-99	100 +	
<b>Female, Bulkhead Mount</b>									
Terminal		Solder	Eyelet with .350 inch D Hole	<a href="#">PE4305</a>	\$37.45	\$35.58	\$33.71	\$32.21	98
			Eyelet with .480 inch D Hole	<a href="#">PE4469</a>	\$48.72	\$46.28	\$43.85	\$41.90	99
			None	<a href="#">PE45130</a>	\$14.61	\$13.88	\$13.15	\$12.56	1
			Solder Cup with .350 inch D Hole	<a href="#">PE4065</a>	\$17.14	\$16.28	\$15.43	\$14.74	2
			Solder Cup with .350 inch D Hole	<a href="#">PE4306</a>	\$14.96	\$14.21	\$13.46	\$12.87	3
			Solder Cup with .410 inch D Hole	<a href="#">PE4063</a>	\$27.34	\$25.97	\$24.61	\$23.51	4
			Solder Cup with .480 inch D Hole	<a href="#">PE4468</a>	\$21.30	\$20.24	\$19.17	\$18.32	5
<b>Female, 4 Hole Flange Mount</b>									
Cable Connectors		Clamp/Solder	RG316-DS, RG188-DS	<a href="#">PE44901</a>	\$39.62	\$37.64	\$35.66	\$34.07	6
Terminal		Solder	Solder Cup with .500 inch Hole Spacing	<a href="#">PE4064SP</a>	\$24.88	\$23.64	\$22.39	\$21.40	7
			Solder Cup with .500 inch Threaded Hole Spacing	<a href="#">PE4064</a>	\$16.87	\$16.03	\$15.18	\$14.51	8
<b>Female Right Angle</b>									
PCB Mount		Solder/Solder	Thru Hole with .380 inch x .083 inch Hole Spacing	<a href="#">PE44659</a>	\$19.44	\$18.47	\$17.50	\$16.72	9
<b>Female Right Angle, Bulkhead Mount</b>									
Cable Connectors		Crimp/Solder	PE-C200, LMR-200 with .480 inch D Hole	<a href="#">PE44847</a>	\$24.97	\$23.72	\$22.47	\$21.47	10
PCB Mount		Solder	Surface Mount	<a href="#">PE44892</a>	\$76.22	\$72.41	\$68.60	\$65.55	11
Terminal			Solder Cup with .361 inch D Hole	<a href="#">PE4471</a>	\$35.78	\$33.99	\$32.20	\$30.77	12

## Reverse Polarity TNC Connectors

Connection Method	Product Image	Attachment Cable/Contact	Coax Type / Termination Type	Model No.	PRICE				ROW		
					1-24	25-49	50-99	100 +			
<b>Male</b>											
Cable Connectors		Clamp/Solder	PE-B400, PE-B405	<a href="#">PE4674</a>	\$24.99	\$23.74	\$22.49	\$21.49	13		
			PE-SR402AL, PE-SR402FL, RG402	<a href="#">PE4670</a>	\$26.04	\$24.74	\$23.44	\$22.39	14		
			PE-SR405AL, PE-SR405FL, RG405	<a href="#">PE4672</a>	\$26.81	\$25.47	\$24.13	\$23.06	15		
			RG174, RG316, RG188	<a href="#">PE4667</a>	\$24.73	\$23.49	\$22.26	\$21.27	16		
			RG178, RG196	<a href="#">PE4669</a>	\$22.11	\$21.00	\$19.90	\$19.01	17		
			RG213, RG55, RG141, RG142, RG223, RG400, RG303, PE-C195, PE-P195, LMR-195	<a href="#">PE4659</a>	\$27.30	\$25.94	\$24.57	\$23.48	18		
			RG58, RG55, RG141, RG142, RG223, RG400, RG303, PE-C195, PE-P195, LMR-195	<a href="#">PE4662</a>	\$16.83	\$15.99	\$15.15	\$14.47	19		
			RG59*, RG62*, RG71	<a href="#">PE4665</a>	\$16.95	\$16.10	\$15.26	\$14.58	20		
				Crimp/Crimp	LMR-200, PE-C200	<a href="#">PE45283</a>	\$22.07	\$20.97	\$19.86	\$18.98	21
				Crimp/Solder	PE-C240, RG8X, .240 inch, LMR-240, LMR-240-DB, LMR-240-UF, B7808A	<a href="#">PE44670</a>	\$14.36	\$13.64	\$12.92	\$12.35	22
	PE-C400, PE-B400, PE-B405, LMR-400, LMR-400-DB, LMR-400-UF, .400 inch	<a href="#">PE44672</a>			\$27.78	\$26.39	\$25.00	\$23.89	23		
	RG174, RG316, RG188, LMR-100, PE-B100, PE-C100, .100 inch	<a href="#">PE4668</a>			\$27.52	\$26.42	\$25.59	\$25.04	24		
	RG188-DS, RG316-DS	<a href="#">PE45180</a>			\$25.32	\$24.31	\$23.55	\$23.04	25		
	RG213, RG8	<a href="#">PE4660</a>			\$24.86	\$23.62	\$22.37	\$21.38	26		
	RG214, RG9, RG225, RG393	<a href="#">PE4661</a>			\$28.26	\$26.85	\$25.43	\$24.30	27		
	RG55, RG141, RG142, RG223, RG400	<a href="#">PE4663</a>			\$17.25	\$16.39	\$15.53	\$14.84	28		
	RG58	<a href="#">PE4664</a>			\$14.79	\$14.05	\$13.31	\$12.72	29		
	RG59*, RG62*, RG71	<a href="#">PE4666</a>			\$17.35	\$16.48	\$15.62	\$14.92	30		
		Solder/Solder			PE-SR402AL, PE-SR402FL, RG402	<a href="#">PE4671</a>	\$35.99	\$34.19	\$32.39	\$30.95	31
	PE-SR405AL, PE-SR405FL, RG405		<a href="#">PE4673</a>	\$53.36	\$50.69	\$48.02	\$45.89	32			

\* Fits MIL-C-17 and equivalent cable versions only

# Reverse Polarity TNC Connectors

Connection Method	Product Image	Attachment Cable/Contact	Coax Type / Termination Type	Model No.	PRICE				ROW		
					1-24	25-49	50-99	100 +			
<b>Male, 4 Hole Flange Mount</b>											
Terminal		Solder	Solder Cup with .531 inch Hole Spacing	<a href="#">PE4708</a>	\$28.14	\$26.73	\$25.33	\$24.20	33		
<b>Male Right Angle</b>											
Cable Connectors		Clamp/Solder	RG178, RG196	<a href="#">PE4682</a>	\$29.50	\$28.03	\$26.55	\$25.37	34		
			RG316, RG174, RG188	<a href="#">PE4680</a>	\$27.37	\$26.00	\$24.63	\$23.54	35		
			RG58, RG55, RG141, RG142, RG223, RG400	<a href="#">PE4676</a>	\$38.23	\$36.32	\$34.41	\$32.88	36		
			RG59*, RG62*	<a href="#">PE4679</a>	\$32.99	\$31.34	\$29.69	\$28.37	37		
		Crimp/Solder	RG316, RG174, RG188, LMR-100, PE-B100, PE-C100, .100 inch	<a href="#">PE4681</a>	\$32.18	\$30.57	\$28.96	\$27.67	38		
			RG55, RG141, RG142, RG223, RG400	<a href="#">PE4677</a>	\$27.30	\$25.94	\$24.57	\$23.48	39		
			RG58, RG303, RG141, PE-C195, PE-P195, LMR-195, .195 inch	<a href="#">PE4678</a>	\$29.78	\$28.29	\$26.80	\$25.61	40		
			<b>Female</b>								
Cable Connectors		Clamp/Solder	PE-SR402AL, PE-SR402FL, RG402	<a href="#">PE4692</a>	\$24.73	\$23.49	\$22.26	\$21.27	41		
			PE-SR405AL, PE-SR405FL, RG405	<a href="#">PE4693</a>	\$25.55	\$24.27	\$23.00	\$21.97	42		
			RG178, RG196	<a href="#">PE4691</a>	\$19.88	\$18.89	\$17.89	\$17.10	43		
			RG213, RG8, RG215, RG225, RG214, RG393	<a href="#">PE4683</a>	\$48.88	\$46.44	\$43.99	\$42.04	44		
			RG316, RG174, RG188	<a href="#">PE4689</a>	\$19.16	\$18.20	\$17.24	\$16.48	45		
			RG58, RG55, RG141, RG142, RG223, RG400	<a href="#">PE4684</a>	\$21.76	\$20.67	\$19.58	\$18.71	46		
			RG59*, RG62*	<a href="#">PE4688</a>	\$25.82	\$24.53	\$23.24	\$22.21	47		
		Crimp/Non-Solder Contact	LMR-200, PE-C200	<a href="#">EZ-200-TF-RP</a>	\$18.21	\$18.21	\$18.21	\$18.21	48		
				Crimp/Solder	PE-C240, RG8X, .240 inch, LMR-240, LMR-240-DB, LMR-240-UF, B7808A	<a href="#">PE44671</a>	\$21.71	\$20.62	\$19.54	\$18.67	49
					PE-C400, PE-B400, PE-B405, LMR-400, LMR-400-DB, LMR-400-UF, .400 inch	<a href="#">PE44673</a>	\$19.34	\$18.37	\$17.41	\$16.63	50
					RG316, RG174, RG188, LMR-100, PE-B100, PE-C100, .100 inch	<a href="#">PE4690</a>	\$25.69	\$24.41	\$23.12	\$22.09	51
					RG55, RG142, RG223, RG400	<a href="#">PE4685</a>	\$17.82	\$16.93	\$16.04	\$15.33	52
					RG58, RG303, RG141, PE-C195, PE-P195, LMR-195, .195 inch	<a href="#">PE4686</a>	\$20.12	\$19.11	\$18.11	\$17.30	53
					RG59*, RG62*	<a href="#">PE4687</a>	\$21.71	\$20.62	\$19.54	\$18.67	54
<b>Female, Bulkhead Mount</b>											
Cable Connectors		Clamp/Solder	PE-SR402AL, PE-SR402FL, RG402 with .480 inch D Hole	<a href="#">PE4702</a>	\$29.76	\$28.27	\$26.78	\$25.59	55		
			PE-SR405AL, PE-SR405FL, RG405 with .480 inch D Hole	<a href="#">PE4703</a>	\$29.50	\$28.03	\$26.55	\$25.37	56		
			RG178, RG196 with .480 inch D Hole	<a href="#">PE4701</a>	\$26.46	\$25.14	\$23.81	\$22.76	57		
			RG316, RG174, RG188 with .480 inch D Hole	<a href="#">PE4699</a>	\$27.37	\$26.00	\$24.63	\$23.54	58		
			RG58, RG142, RG223, RG400, RG141, RG303, RG55, PE-C195, PE-P195 with .480 inch D Hole	<a href="#">PE4694</a>	\$25.50	\$24.23	\$22.95	\$21.93	59		
		Crimp/Solder	.100 inch, RG316, RG174, RG188, LMR-100, LMR-100A, LMR-100A-FR, PE-C100, PE-B100 with .480 inch D Hole	<a href="#">PE4700</a>	\$30.64	\$29.11	\$27.58	\$26.35	60		
			.195 inch, RG58, RG141, RG303, LMR-195, LMR-195-FR, PE-C195, PE-P195 with .480 inch D Hole	<a href="#">PE4696</a>	\$30.25	\$28.74	\$27.23	\$26.02	61		
			RG174, RG316, RG188, .100 inch, PE-B100, PE-C100, LMR-100	<a href="#">PE44902</a>	\$55.73	\$52.94	\$50.16	\$47.93	62		
			RG174, RG316, RG188, .100 inch, PE-B100, PE-C100, LMR-100	<a href="#">PE44903</a>	\$63.69	\$60.51	\$57.32	\$54.77	63		
			RG188-DS, RG316-DS with .480 inch D Hole	<a href="#">PE45181</a>	\$26.78	\$25.44	\$24.10	\$23.03	64		
			RG55, RG141, RG142, RG223, RG400 with .480 inch D Hole	<a href="#">PE4695</a>	\$23.35	\$22.18	\$21.02	\$20.08	65		
			<b>Terminal</b>								
				Solder	Solder Cup with .350 inch D Hole	<a href="#">PE4706</a>	\$22.60	\$21.47	\$20.34	\$19.44	66
Solder Cup with .410 inch D Hole	<a href="#">PE4704</a>	\$22.60			\$21.47	\$20.34	\$19.44	67			
<b>Female, 4 Hole Flange Mount</b>											
Terminal		Solder	Solder Cup with .500 inch Threaded Hole Spacing	<a href="#">PE4705</a>	\$28.57	\$27.14	\$25.71	\$24.57	68		

Connectors

See Our Website For Current Pricing & Real-Time Stock Availability!

\* Fits MIL-C-17 and equivalent cable versions only



## TNC Torque Wrenches



Type	Bit Hex Size (in.)	Preset Torque (in.-lbs.)	Model No	1-9	10-24	25-49	50+	ROW
TNC	5/8 inch	14 in-lbs	<a href="#">PE5011-4</a>	\$360.10	\$342.10	\$324.09	\$309.69	
	9/16 inch	13 in-lbs	<a href="#">PE5011-8</a>	\$339.73	\$322.74	\$305.76	\$292.17	
	5/8 inch	12 in-lbs	<a href="#">PE5019-10</a>	\$240.14	\$228.13	\$216.13	\$206.52	

## UHF Connectors

Connection Method	Product Image	Attachment Cable/Contact	Coax Type / Termination Type	Model No.	PRICE				ROW
					1-24	25-49	50-99	100 +	
<b>Sexless</b>									
Cable Connectors		Accessories	RG59*, RG62*, RG71	<a href="#">PE4021</a>	\$2.19	\$2.08	\$1.97	\$1.88	69
<b>Male</b>									
Cable Connectors		Clamp/Solder	RG213, RG214, RG8, RG9, RG11*, RG225, RG393, RG144*, RG215, RG216*	<a href="#">PE44050</a>	\$14.77	\$14.03	\$13.29	\$12.70	70
			RG58, RG55, RG141, RG142, RG223, RG400, RG303, PE-C195, PE-P195, LMR-195	<a href="#">PE44052</a>	\$13.86	\$13.17	\$12.47	\$11.92	71
		Crimp/Solder	PE-B400, PE-B405, PE-C400, LMR-400, .400 inch	<a href="#">PE44054</a>	\$15.38	\$14.61	\$13.84	\$13.23	72
			RG213, RG215, RG8	<a href="#">PE4295</a>	\$18.83	\$17.89	\$16.95	\$16.19	73
			RG214, RG9, RG225, RG393	<a href="#">PE44051</a>	\$16.63	\$15.80	\$14.97	\$14.30	74
			RG55, RG141, RG142, RG223, RG400	<a href="#">PE44053</a>	\$11.27	\$10.71	\$10.14	\$9.69	75
			RG58, RG303, RG141, PE-C195, PE-P195, LMR-195, .195 inch	<a href="#">PE4069</a>	\$12.28	\$11.67	\$11.05	\$10.56	76
	RG59*, RG62*, RG71	<a href="#">PE4073</a>	\$10.04	\$9.54	\$9.04	\$8.63	77		
	Solder	RG213, RG55, RG141, RG142, RG223, RG400, RG303, PE-C195, PE-P195, LMR-195	<a href="#">PE4020</a>	\$17.71	\$16.82	\$15.94	\$15.23	78	
		RG59*, RG62*, RG71	<a href="#">PE44828</a>	\$16.04	\$15.24	\$14.44	\$13.79	79	
<b>Female</b>									
Cable Connectors		Clamp/Solder	RG213, RG214, RG8, RG9, RG11*, RG225, RG393, RG144*, RG216*, RG215	<a href="#">PE44055</a>	\$18.46	\$17.54	\$16.61	\$15.88	80
			RG58, RG55, RG141, RG142, RG223, RG400, RG303, PE-C195, PE-P195, LMR-195	<a href="#">PE44056</a>	\$19.47	\$18.50	\$17.52	\$16.74	81
		Crimp/Solder	RG55, RG141, RG142, RG223, RG400	<a href="#">PE44057</a>	\$15.12	\$14.36	\$13.61	\$13.00	82
			RG58, RG303, RG141, PE-C195, PE-P195, LMR-195, .195 inch	<a href="#">PE44058</a>	\$19.47	\$18.50	\$17.52	\$16.74	83
<b>Female, Bulkhead Mount</b>									
Terminal		Solder	Solder Cup with .575 inch D Hole	<a href="#">PE44059</a>	\$14.69	\$13.96	\$13.22	\$12.63	84
			Solder Cup with .575 inch D Hole	<a href="#">PE44060</a>	\$12.64	\$12.01	\$11.38	\$10.87	85
<b>Female, 4 Hole Flange Mount</b>									
Terminal		Field Replaceable	Slotted Contact	<a href="#">PE44719</a>	\$59.56	\$56.58	\$53.60	\$51.22	86
		Solder	Solder Cup with .718 inch Hole Spacing	<a href="#">PE45478</a>	\$10.69	\$9.94	\$9.19	\$8.55	87

## UMCX Connectors



Connection Method	Product Image	Attachment Cable/Contact	Coax Type / Termination Type	Model No.	PRICE				ROW
					1-24	25-49	50-99	100 +	
<b>Jack</b>									
PCB Mount		Solder	Surface Mount	<a href="#">PE44594</a>	\$2.06	\$1.96	\$1.85	\$1.77	88

\* Fits MIL-C-17 and equivalent cable versions only





Connectors

See Our Website For Current Pricing & Real-Time Stock Availability!





## 75 Ohm 1.0/2.3 Connectors

Connection Method	Product Image	Attachment Cable/Contact	Coax Type / Termination Type	Model No.	PRICE				ROW
					1-24	25-49	50-99	100 +	
<b>Plug</b>									
Cable Connectors		Crimp/Crimp	BELDEN 1855A	<a href="#">PE45228</a>	\$12.49	\$11.87	\$11.24	\$10.74	89
			BELDEN 735A1	<a href="#">PE45227</a>	\$12.86	\$12.22	\$11.57	\$11.06	90
			RG179-DS	<a href="#">PE45233</a>	\$12.86	\$12.22	\$11.57	\$11.06	91
			RG59*	<a href="#">PE45234</a>	\$12.86	\$12.22	\$11.57	\$11.06	92
			RG6-CATV	<a href="#">PE45235</a>	\$19.11	\$18.15	\$17.20	\$16.43	93
<b>Jack, Bulkhead Mount</b>									
PCB Mount		Solder	End Launch	<a href="#">PE45232</a>	\$21.25	\$20.19	\$19.13	\$18.28	94
			Thru Hole	<a href="#">PE45231</a>	\$19.07	\$18.12	\$17.16	\$16.40	95
			Thru Hole	<a href="#">PE45229</a>	\$17.39	\$16.52	\$15.65	\$14.96	96
<b>Jack Right Angle, Bulkhead Mount</b>									
PCB Mount		Solder	Thru Hole	<a href="#">PE45230</a>	\$16.42	\$15.60	\$14.78	\$14.12	97
			Thru Hole	<a href="#">PE45237</a>	\$19.41	\$18.44	\$17.47	\$16.69	98

## 75 Ohm 1.6/5.6 Connectors

Connection Method	Product Image	Attachment Cable/Contact	Coax Type / Termination Type	Model No.	PRICE				ROW
					1-24	25-49	50-99	100 +	
<b>Plug</b>									
Cable Connectors		Crimp/Solder	RG179, RG187	<a href="#">PE44262</a>	\$19.47	\$18.50	\$17.52	\$16.74	99
			RG59*, RG62*, RG71	<a href="#">PE44263</a>	\$18.46	\$17.54	\$16.61	\$15.88	1
<b>Plug Right Angle</b>									
Cable Connectors		Clamp/Solder	RG179, RG187	<a href="#">PE44264</a>	\$19.73	\$18.74	\$17.76	\$16.97	2
<b>Jack, Bulkhead Mount</b>									
PCB Mount		Solder	Thru Hole with .362 inch Diameter	<a href="#">PE44270</a>	\$17.14	\$16.28	\$15.43	\$14.74	3
<b>Jack Right Angle</b>									
PCB Mount		Solder	Thru Hole with .200 inch x .052 inch Hole Spacing	<a href="#">PE44271</a>	\$19.73	\$18.74	\$17.76	\$16.97	4
<b>Jack Right Angle, Bulkhead Mount</b>									
Cable Connectors		Crimp/Solder	RG179, RG187 with .362 inch DD Hole	<a href="#">PE44268</a>	\$19.73	\$18.74	\$17.76	\$16.97	5

## 75 Ohm BNC Connectors

Connection Method	Product Image	Attachment Cable/Contact	Coax Type / Termination Type	Model No.	PRICE				ROW		
					1-24	25-49	50-99	100 +			
<b>Male</b>											
Cable Connectors		Clamp/Solder	RG11*, RG144*, RG216*	<a href="#">PE4599</a>	\$38.60	\$36.67	\$34.74	\$33.20	6		
			RG179, RG187	<a href="#">PE4603</a>	\$17.48	\$16.61	\$15.73	\$15.03	7		
			RG59*, RG62*, RG71	<a href="#">PE4601</a>	\$18.93	\$17.98	\$17.04	\$16.28	8		
			Mini 59, PE-B159	<a href="#">PE44578</a>	\$18.09	\$17.19	\$16.28	\$15.56	9		
		Compression	PE-B159, 1855A, Mini 59	<a href="#">PE44577</a>	\$15.76	\$14.97	\$14.18	\$13.55	10		
				Crimp/Crimp	RG59*, RG62*, RG71	<a href="#">PE4602</a>	\$12.49	\$11.87	\$11.24	\$10.74	11
		Crimp/Solder			1505A	<a href="#">PE44631</a>	\$6.62	\$6.29	\$5.96	\$5.69	12
					1505A	<a href="#">PE44626</a>	\$12.96	\$12.31	\$11.66	\$11.15	13
			1694A	<a href="#">PE44627</a>	\$6.24	\$5.93	\$5.62	\$5.37	14		

\* Fits MIL-C-17 and equivalent cable versions only



Technical Support  
+1 (949) 261-1920















Same-Day Shipping,  
Even Custom  
Cable Assemblies

Connectors

See Our Website For Current Pricing & Real-Time Stock Availability!

# 75 Ohm BNC Connectors



Connection Method	Product Image	Attachment Cable/Contact	Coax Type / Termination Type	Model No.	PRICE				ROW
					1-24	25-49	50-99	100 +	
<b>Male</b>									
Cable Connectors		Crimp/Solder	1694A	<a href="#">PE44632</a>	\$17.44	\$16.57	\$15.70	\$15.00	15
			735A	<a href="#">PE44686</a>	\$30.52	\$28.99	\$27.47	\$26.25	16
			7731A	<a href="#">PE44628</a>	\$11.10	\$10.55	\$9.99	\$9.55	17
			Belden 150A	<a href="#">PE45117</a>	\$10.49	\$9.97	\$9.44	\$9.02	18
			Belden 1694A	<a href="#">PE45116</a>	\$13.65	\$12.97	\$12.29	\$11.74	19
			PE-B150, RG180, RG195	<a href="#">PE4633</a>	\$16.55	\$15.72	\$14.90	\$14.23	20
			PE-B159, 1855A, Mini 59	<a href="#">PE44625</a>	\$13.65	\$12.97	\$12.29	\$11.74	21
			PE-B159, 1855A, Mini 59	<a href="#">PE44584</a>	\$17.25	\$16.39	\$15.53	\$14.84	22
			PE-B305	<a href="#">PE4634</a>	\$17.70	\$16.82	\$15.93	\$15.22	23
			RG11*, RG216*, RG144*	<a href="#">PE4600</a>	\$24.17	\$22.96	\$21.75	\$20.79	24
RG179, RG187	<a href="#">PE4604</a>	\$15.06	\$14.31	\$13.55	\$12.95	25			
RG6	<a href="#">PE4598</a>	\$8.03	\$7.63	\$7.23	\$6.91	26			
<b>Male, Bulkhead Mount</b>									
Terminal		Solder	Solder Cup with .350 inch D Hole	<a href="#">PE4627</a>	\$24.71	\$23.47	\$22.24	\$21.25	27
<b>Male, 4 Hole Flange Mount</b>									
Terminal		Solder	Solder Cup with .531 inch Hole Spacing	<a href="#">PE4625</a>	\$22.99	\$21.84	\$20.69	\$19.77	28
<b>Male Right Angle</b>									
Cable Connectors		Clamp/Solder	RG179, RG187	<a href="#">PE4609</a>	\$56.39	\$53.57	\$50.75	\$48.50	29
			RG59*, RG62*, RG71	<a href="#">PE4607</a>	\$50.45	\$47.93	\$45.41	\$43.39	30
			RG6	<a href="#">PE4605</a>	\$40.32	\$38.30	\$36.29	\$34.68	31
		Crimp/Solder	RG179, RG187	<a href="#">PE4610</a>	\$27.40	\$26.03	\$24.66	\$23.56	32
			RG59*, RG62*, RG71	<a href="#">PE4608</a>	\$36.71	\$34.87	\$33.04	\$31.57	33
<b>Female</b>									
Cable Connectors		Clamp/Solder	RG179, RG187	<a href="#">PE4615</a>	\$30.76	\$29.53	\$28.61	\$27.99	34
			RG59*	<a href="#">PE4613</a>	\$23.60	\$22.42	\$21.24	\$20.30	35
			RG6	<a href="#">PE4611</a>	\$46.71	\$44.37	\$42.04	\$40.17	36
		Crimp/Solder	735A	<a href="#">PE44688</a>	\$29.38	\$27.91	\$26.44	\$25.27	37
			RG179, RG187	<a href="#">PE4616</a>	\$21.18	\$20.12	\$19.06	\$18.21	38
PCB Mount		Solder	End Launch	<a href="#">PE44619</a>	\$11.89	\$11.30	\$10.70	\$10.23	39
<b>Female, Bulkhead Mount</b>									
Cable Connectors		Clamp/Solder	RG179, RG187 with .480 inch D Hole	<a href="#">PE4639</a>	\$37.50	\$36.00	\$34.88	\$34.13	40
			RG59*, RG62*, RG71 with .480 inch D Hole	<a href="#">PE4637</a>	\$39.31	\$37.34	\$35.38	\$33.81	41
		Crimp/Solder	735A with .480 inch D Hole	<a href="#">PE44687</a>	\$31.41	\$29.84	\$28.27	\$27.01	42
			PE-B150, RG180, RG195 with .480 inch D Hole	<a href="#">PE4641</a>	\$30.52	\$28.99	\$27.47	\$26.25	43
			PE-B159, 1855A, Mini 59 with .480 inch D Hole	<a href="#">PE44587</a>	\$25.45	\$24.18	\$22.91	\$21.89	44
			PE-B305 with .480 inch D Hole	<a href="#">PE4642</a>	\$34.95	\$33.20	\$31.46	\$30.06	45
			RG179, RG187 with .480 inch D Hole	<a href="#">PE4640</a>	\$25.73	\$24.44	\$23.16	\$22.13	46
RG59*, RG62*, RG71 with .480 inch D Hole	<a href="#">PE4638</a>	\$32.74	\$31.10	\$29.47	\$28.16	47			
PCB Mount		Solder	End Launch with .500 inch Diameter	<a href="#">PE44620</a>	\$19.29	\$18.33	\$17.36	\$16.59	48
Terminal		Solder	Solder Cup with .350 inch D Hole	<a href="#">PE4626</a>	\$14.81	\$14.07	\$13.33	\$12.74	49
			Solder Cup with .350 inch D Hole	<a href="#">PE4620</a>	\$16.58	\$15.75	\$14.92	\$14.26	50
			Solder Cup with .410 inch D Hole	<a href="#">PE4619</a>	\$12.19	\$11.58	\$10.97	\$10.48	51
			Turret with .350 inch D Hole	<a href="#">PE4624</a>	\$40.29	\$38.28	\$36.26	\$34.65	52
			Turret with .480 inch D Hole	<a href="#">PE4621</a>	\$49.59	\$47.11	\$44.63	\$42.65	53
<b>Female, 4 Hole Flange Mount</b>									
Cable Connectors		Clamp/Solder	RG179, RG187 with .500 inch Threaded Hole Spacing	<a href="#">PE44652</a>	\$38.55	\$36.62	\$34.70	\$33.15	54
			RG59*, RG62*, RG71 with .500 inch Threaded Hole Spacing	<a href="#">PE4623</a>	\$40.22	\$38.21	\$36.20	\$34.59	55

\* Fits MIL-C-17 and equivalent cable versions only

Connectors

See Our Website For Current Pricing & Real-Time Stock Availability!

## 75 Ohm BNC Connectors

Connection Method	Product Image	Attachment Cable/Contact	Coax Type / Termination Type	Model No.	PRICE				ROW
					1-24	25-49	50-99	100 +	
<b>Female, 4 Hole Flange Mount</b>									
Terminal		Solder	Solder Cup with .500 inch Threaded Hole Spacing	<a href="#">PE4617</a>	\$18.04	\$17.14	\$16.24	\$15.51	56
			Solder Cup with .500 inch Hole Spacing	<a href="#">PE4630</a>	\$22.60	\$21.47	\$20.34	\$19.44	57
			Solder Cup with .718 inch Hole Spacing	<a href="#">PE4631</a>	\$30.38	\$28.86	\$27.34	\$26.13	58
			Turret with .531 inch Hole Spacing	<a href="#">PE4618</a>	\$49.00	\$46.55	\$44.10	\$42.14	59
<b>Female Right Angle, Bulkhead Mount</b>									
Terminal		Solder	Solder Cup with .361 inch D Hole	<a href="#">PE4622</a>	\$60.53	\$57.50	\$54.48	\$52.06	60
<b>Female Right Angle, 4 Hole Flange Mount</b>									
Terminal		Solder	Solder Cup with .531 inch Hole Spacing	<a href="#">PE4628</a>	\$28.66	\$27.23	\$25.79	\$24.65	61

## 75 Ohm F Connectors

Connection Method	Product Image	Attachment Cable/Contact	Coax Type / Termination Type	Model No.	PRICE				ROW
					1-24	25-49	50-99	100 +	
<b>Male</b>									
Cable Connectors		Compression	PE-B159, 1855A, Mini 59	<a href="#">PE44572</a>	\$7.35	\$6.98	\$6.62	\$6.32	62
			PE-B159, 1855A, Mini 59	<a href="#">PE44573</a>	\$6.39	\$6.07	\$5.75	\$5.50	63
		Crimp/Crimp	RG59*, RG62*, RG71	<a href="#">PE44317</a>	\$6.21	\$5.90	\$5.59	\$5.34	64
			RG6	<a href="#">PE44312</a>	\$2.64	\$2.51	\$2.38	\$2.27	65
		Crimp/Non-Solder Contact	LMR-400-75	<a href="#">EZ-400-FM-75</a>	\$29.38	\$29.38	\$29.38	\$29.38	66
				Crimp/Solder	PE-B159, 1855A, Mini 59	<a href="#">PE44582</a>	\$6.59	\$6.26	\$5.93
	RG11*, RG216*, RG144*	<a href="#">PE44315</a>			\$7.65	\$7.27	\$6.89	\$6.58	68
	RG179, RG187	<a href="#">PE45520</a>			\$4.53	\$4.30	\$4.08	\$3.90	69
	RG59*, RG62*, RG71	<a href="#">PE44316</a>			\$1.60	\$1.52	\$1.44	\$1.38	70
	RG6-CATV	<a href="#">PE44313</a>			\$6.24	\$5.93	\$5.62	\$5.37	71
	Twist	RG59*, RG62*, RG71	<a href="#">PE44452</a>	\$3.44	\$3.27	\$3.10	\$2.96	72	
		RG6	<a href="#">PE44318</a>	\$1.85	\$1.76	\$1.67	\$1.59	73	
	Twist	RG6	<a href="#">PE44314</a>	\$2.90	\$2.76	\$2.61	\$2.49	74	
		<b>Male Right Angle</b>							
Cable Connectors		Compression	PE-B159, 1855A, Mini 59	<a href="#">PE44579</a>	\$14.86	\$14.12	\$13.37	\$12.78	75
		Crimp/Solder	RG59*, RG62*, RG71	<a href="#">PE44322</a>	\$8.93	\$8.48	\$8.04	\$7.68	76
			RG6-CATV	<a href="#">PE44320</a>	\$10.65	\$10.12	\$9.59	\$9.16	77
	Twist	RG59*, RG62*, RG71	<a href="#">PE44323</a>	\$6.81	\$6.47	\$6.13	\$5.86	78	
		<b>Female</b>							
PCB Mount		Solder	Thru Hole with .320 inch x .091 inch Hole Spacing	<a href="#">PE44331</a>	\$2.54	\$2.41	\$2.29	\$2.18	79
<b>Female, Bulkhead Mount</b>									
Cable Connectors		Crimp/Solder	PE-B159, 1855A, Mini 59 with .480 inch D Hole	<a href="#">PE44585</a>	\$8.16	\$7.75	\$7.34	\$7.02	80
			RG179, RG187 with .380 inch DD Hole	<a href="#">PE45504</a>	\$7.62	\$7.32	\$7.09	\$6.93	81
			RG59*, RG62*, RG71	<a href="#">PE45552</a>	\$5.92	\$5.62	\$5.33	\$5.09	82
			RG6-CATV	<a href="#">PE44324</a>	\$9.89	\$9.40	\$8.90	\$8.51	83

\* Fits MIL-C-17 and equivalent cable versions only



Technical Support  
+1 (949) 261-1920









Same-Day Shipping,  
Even Custom  
Cable Assemblies

Connectors





See Our Website For Current Pricing & Real-Time Stock Availability!



## 75 Ohm F Connectors

Connection Method	Product Image	Attachment Cable/Contact	Coax Type / Termination Type	Model No.	PRICE				ROW
					1-24	25-49	50-99	100 +	
PCB Mount		Solder	Thru Hole with .340 inch x .091 inch Hole Spacing	<a href="#">PE44332</a>	\$6.56	\$6.23	\$5.90	\$5.64	84
Terminal			Tab with .380 inch DD Hole	<a href="#">PE44327</a>	\$1.92	\$1.82	\$1.73	\$1.65	85
<b>Female, 4 Hole Flange Mount</b>									
Terminal		Solder	Pin with .500 inch Hole Spacing	<a href="#">PE44329</a>	\$11.04	\$10.49	\$9.94	\$9.49	86
<b>Female, Thread-In</b>									
Terminal		Solder	Pin with .380 inch Diameter	<a href="#">PE44330</a>	\$3.04	\$2.89	\$2.74	\$2.61	87
<b>Female Right Angle</b>									
PCB Mount		Solder	Thru Hole with .320 inch x .091 inch Hole Spacing	<a href="#">PE44333</a>	\$7.85	\$7.46	\$7.07	\$6.75	88
<b>Female Right Angle, Bulkhead Mount</b>									
PCB Mount		Solder	Surface Mount	<a href="#">PE44895</a>	\$16.94	\$16.09	\$15.25	\$14.57	89
			Thru Hole with .350 inch D Hole	<a href="#">PE44334</a>	\$9.59	\$9.11	\$8.63	\$8.25	90

## 75 Ohm MCX Connectors

Connection Method	Product Image	Attachment Cable/Contact	Coax Type / Termination Type	Model No.	PRICE				ROW
					1-24	25-49	50-99	100 +	
<b>Plug</b>									
Cable Connectors		Crimp/Solder	RG179, RG187	<a href="#">PE44298</a>	\$16.17	\$15.36	\$14.55	\$13.91	91
<b>Plug Right Angle</b>									
Cable Connectors		Crimp/Solder	RG179, RG187	<a href="#">PE45086</a>	\$19.56	\$18.58	\$17.60	\$16.82	92
<b>Jack</b>									
Cable Connectors		Crimp/Solder	RG179, RG187	<a href="#">PE44300</a>	\$31.61	\$30.03	\$28.45	\$27.18	93
PCB Mount		Solder	.072 inch End Launch	<a href="#">PE45211</a>	\$14.69	\$13.96	\$13.22	\$12.63	94
<b>Jack Right Angle</b>									
PCB Mount		Solder	Thru Hole with .200 inch x .055 inch Hole Spacing	<a href="#">PE44304</a>	\$19.74	\$18.75	\$17.77	\$16.98	95

## 75 Ohm Mini SMB Connectors







Connection Method	Product Image	Attachment Cable/Contact	Coax Type / Termination Type	Model No.	PRICE				ROW
					1-24	25-49	50-99	100 +	
<b>Plug</b>									
Cable Connectors		Crimp/Solder	PE-B159, 1855A, Mini 59	<a href="#">PE44588</a>	\$24.85	\$23.61	\$22.37	\$21.37	96
			RG179, RG187	<a href="#">PE4993</a>	\$20.13	\$19.12	\$18.12	\$17.31	97
			RG59*, RG62*, RG71	<a href="#">PE4994</a>	\$32.00	\$30.72	\$29.76	\$29.12	98

\* Fits MIL-C-17 and equivalent cable versions only



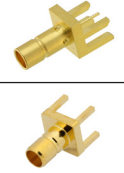



Connectors

See Our Website For Current Pricing & Real-Time Stock Availability!

## 75 Ohm Mini SMB Connectors

Connection Method	Product Image	Attachment Cable/Contact	Coax Type / Termination Type	Model No.	PRICE				ROW
					1-24	25-49	50-99	100 +	
<b>Plug Right Angle</b>									
Cable Connectors		Crimp/Solder	RG179, RG187	<a href="#">PE4995</a>	\$23.35	\$22.18	\$21.02	\$20.08	99
			RG59*, RG62*, RG71	<a href="#">PE4996</a>	\$27.95	\$26.55	\$25.16	\$24.04	1
<b>Jack</b>									
Cable Connectors		Crimp/Solder	Mini 59, PE-B159	<a href="#">PE44590</a>	\$29.52	\$28.04	\$26.57	\$25.39	2
PCB Mount		Solder	.062 inch End Launch	<a href="#">PE44131</a>	\$27.80	\$26.41	\$25.02	\$23.91	3
			Thru Hole with .200 inch x .055 inch Hole Spacing	<a href="#">PE4997</a>	\$19.39	\$18.42	\$17.45	\$16.68	4
<b>Jack, 2 Hole Flange Mount</b>									
Terminal		Solder	Solder Cup with .328 inch Hole Spacing	<a href="#">PE44141</a>	\$27.16	\$25.80	\$24.44	\$23.36	5
<b>Jack Right Angle</b>									
PCB Mount		Solder	Thru Hole with .200 inch x .055 inch Hole Spacing	<a href="#">PE4998</a>	\$27.30	\$25.94	\$24.57	\$23.48	6
<b>Jack Right Angle, Bulkhead Mount</b>									
PCB Mount		Solder	Thru Hole with .177 inch D Hole	<a href="#">PE44128</a>	\$27.95	\$26.55	\$25.16	\$24.04	7

## 75 Ohm N Connectors

Connection Method	Product Image	Attachment Cable/Contact	Coax Type / Termination Type	Model No.	PRICE				ROW
					1-24	25-49	50-99	100 +	
<b>Male</b>									
Cable Connectors		Clamp/Solder	RG11*, RG144*, RG216*	<a href="#">PE4509</a>	\$39.01	\$37.45	\$36.28	\$35.50	8
			RG179, RG187	<a href="#">PE4513</a>	\$23.40	\$22.23	\$21.06	\$20.12	9
			RG59*, RG62*, RG71	<a href="#">PE4511</a>	\$26.27	\$24.96	\$23.64	\$22.59	10
			RG6	<a href="#">PE4507</a>	\$25.80	\$24.51	\$23.22	\$22.19	11
		Crimp/Non-Solder Contact	LMR-400-75	<a href="#">EZ-400-NMH-75-X</a>	\$36.99	\$36.99	\$36.99	\$36.99	12
		Crimp/Solder	RG11*, RG144*, RG216*	<a href="#">PE4510</a>	\$27.79	\$26.40	\$25.01	\$23.90	13
			RG179, RG187	<a href="#">PE4656</a>	\$40.69	\$38.66	\$36.62	\$34.99	14
RG59*, RG62*, RG71			<a href="#">PE4512</a>	\$27.00	\$25.65	\$24.30	\$23.22	15	
RG6			<a href="#">PE4508</a>	\$27.28	\$25.92	\$24.55	\$23.46	16	
<b>Male, 4 Hole Flange Mount</b>									
Terminal		Solder	Solder Cup with .718 inch Hole Spacing	<a href="#">PE4504</a>	\$46.66	\$44.33	\$41.99	\$40.13	17
<b>Male Right Angle</b>									
Cable Connectors		Clamp/Solder	RG11*, RG144*, RG216*	<a href="#">PE4502</a>	\$58.01	\$55.69	\$53.95	\$52.79	18
<b>Female</b>									
Cable Connectors		Clamp/Solder	RG59*, RG62*, RG71	<a href="#">PE4516</a>	\$44.23	\$42.02	\$39.81	\$38.04	19
			RG6	<a href="#">PE4514</a>	\$54.32	\$52.15	\$50.52	\$49.43	20

\* Fits MIL-C-17 and equivalent cable versions only



Technical Support  
+1 (949) 261-1920





Same-Day Shipping,  
Even Custom  
Cable Assemblies





Connectors

See Our Website For Current Pricing & Real-Time Stock Availability!







## 75 Ohm N Connectors

Connection Method	Product Image	Attachment Cable/Contact	Coax Type / Termination Type	Model No.	PRICE				ROW
					1-24	25-49	50-99	100 +	
<b>Female, Bulkhead Mount</b>									
Terminal		Solder	Solder Cup with .380 inch Diameter	<a href="#">PE4506</a>	\$20.70	\$19.67	\$18.63	\$17.80	21
			Solder Cup with .640 inch DD Hole	<a href="#">PE4505</a>	\$31.30	\$29.74	\$28.17	\$26.92	22
<b>Female, 4 Hole Flange Mount</b>									
Terminal		Solder	Solder Cup with .718 inch Hole Spacing	<a href="#">PE4503</a>	\$19.39	\$18.42	\$17.45	\$16.68	23

## 75 Ohm RCA Connectors







Connection Method	Product Image	Attachment Cable/Contact	Coax Type / Termination Type	Model No.	PRICE				ROW
					1-24	25-49	50-99	100 +	
<b>Male</b>									
Cable Connectors		Compression	Mini 59, PE-B159	<a href="#">PE44576</a>	\$7.85	\$7.46	\$7.07	\$6.75	24
			PE-B159, 1855A, Mini 59	<a href="#">PE44574</a>	\$14.61	\$13.88	\$13.15	\$12.56	25
		Crimp/Solder	1505A	<a href="#">PE44624</a>	\$16.55	\$15.72	\$14.90	\$14.23	26
			1694A	<a href="#">PE44623</a>	\$13.50	\$12.83	\$12.15	\$11.61	27
			Mini 59, PE-B159	<a href="#">PE44622</a>	\$16.55	\$15.72	\$14.90	\$14.23	28
PE-B159	<a href="#">PE44583</a>	\$15.64	\$14.86	\$14.08	\$13.45	29			
<b>Male Right Angle</b>									
Cable Connectors		Compression	Mini 59, PE-B159	<a href="#">PE44580</a>	\$19.73	\$18.74	\$17.76	\$16.97	30
<b>Female, Bulkhead Mount</b>									
Cable Connectors		Crimp/Solder	PE-B159, 1855A, Mini 59 with .480 inch D Hole	<a href="#">PE44586</a>	\$19.91	\$18.91	\$17.92	\$17.12	31

## 75 Ohm SMB Connectors



Connection Method	Product Image	Attachment Cable/Contact	Coax Type / Termination Type	Model No.	PRICE				ROW
					1-24	25-49	50-99	100 +	
<b>Plug</b>									
Cable Connectors		Clamp/Solder	RG179, RG187	<a href="#">PE4257</a>	\$27.75	\$26.36	\$24.98	\$23.87	32
			RG59*, RG62*, RG71	<a href="#">PE4203</a>	\$21.62	\$20.54	\$19.46	\$18.59	33
		Crimp/Solder	RG179, RG187	<a href="#">PE4248</a>	\$22.54	\$21.41	\$20.29	\$19.38	34
			RG59*, RG62*, RG71	<a href="#">PE4472</a>	\$27.77	\$26.38	\$24.99	\$23.88	35
PCB Mount		Solder	Thru Hole with .200 inch x .067 inch Hole Spacing	<a href="#">PE4368</a>	\$21.35	\$20.50	\$19.86	\$19.43	36
<b>Plug, Bulkhead Mount</b>									
Terminal		Solder	Solder Cup with .295 inch D Hole	<a href="#">PE4290</a>	\$68.46	\$65.04	\$61.61	\$58.88	37
<b>Plug Right Angle</b>									
Cable Connectors		Clamp/Solder	RG59*, RG62*	<a href="#">PE4264</a>	\$43.60	\$41.42	\$39.24	\$37.50	38
			PE-B150, RG180, RG195	<a href="#">PE4161</a>	\$48.78	\$46.83	\$45.37	\$44.39	39
		Crimp/Solder	RG179, RG187	<a href="#">PE4251</a>	\$30.27	\$28.76	\$27.24	\$26.03	40

\* Fits MIL-C-17 and equivalent cable versions only



## 75 Ohm SMB Connectors

Connection Method	Product Image	Attachment Cable/Contact	Coax Type / Termination Type	Model No.	PRICE				ROW
					1-24	25-49	50-99	100 +	
<b>Jack</b>									
Cable Connectors		Clamp/Solder	RG179, RG187	<a href="#">PE4928</a>	\$48.92	\$46.47	\$44.03	\$42.07	41
			RG59*, RG62*	<a href="#">PE4272</a>	\$37.62	\$35.74	\$33.86	\$32.35	42
		Crimp/Solder	PE-B150, RG180, RG195	<a href="#">PE4163</a>	\$22.92	\$21.77	\$20.63	\$19.71	43
			RG179, RG187	<a href="#">PE44872</a>	\$39.20	\$37.24	\$35.28	\$33.71	44
PCB Mount		Solder	Thru Hole with .200 inch x .067 inch Hole Spacing	<a href="#">PE4110</a>	\$24.71	\$23.47	\$22.24	\$21.25	45
<b>Jack, Bulkhead Mount</b>									
Cable Connectors		Clamp/Solder	RG180, RG195 with .285 inch D Hole	<a href="#">PE4281</a>	\$29.23	\$27.77	\$26.31	\$25.14	46
		Crimp/Solder	RG179, RG187 with .285 inch D Hole	<a href="#">PE4255</a>	\$52.36	\$49.74	\$47.12	\$45.03	47
Terminal		Solder	Solder Cup with .295 inch D Hole	<a href="#">PE4172</a>	\$19.59	\$18.61	\$17.63	\$16.85	48
			Solder Cup with .317 inch Diameter	<a href="#">PE4168</a>	\$18.68	\$17.75	\$16.81	\$16.06	49
<b>Jack Right Angle</b>									
PCB Mount		Solder	Thru Hole with .200 inch x .067 inch Hole Spacing	<a href="#">PE4179</a>	\$26.06	\$24.76	\$23.45	\$22.41	50

## 75 Ohm SMB Positive Snap Connectors

Connection Method	Product Image	Attachment Cable/Contact	Coax Type / Termination Type	Model No.	PRICE				ROW
					1-24	25-49	50-99	100 +	
<b>Plug</b>									
Cable Connectors		Crimp/Solder	RG179, RG187	<a href="#">PE44443</a>	\$34.83	\$33.09	\$31.35	\$29.95	51
			RG59*, RG62*	<a href="#">PE44442</a>	\$24.62	\$23.39	\$22.16	\$21.17	52
<b>Plug Right Angle</b>									
Cable Connectors		Crimp/Solder	RG179, RG187	<a href="#">PE44445</a>	\$38.31	\$36.39	\$34.48	\$32.95	53
			RG180, RG195	<a href="#">PE44446</a>	\$51.70	\$49.12	\$46.53	\$44.46	54

## 75 Ohm SMC Connectors

Connection Method	Product Image	Attachment Cable/Contact	Coax Type / Termination Type	Model No.	PRICE				ROW
					1-24	25-49	50-99	100 +	
<b>Plug</b>									
Cable Connectors		Clamp/Solder	RG179, RG187	<a href="#">PE4259</a>	\$48.92	\$46.47	\$44.03	\$42.07	55
			RG59*, RG62*, RG71	<a href="#">PE4258</a>	\$52.09	\$49.49	\$46.88	\$44.80	56
		Crimp/Solder	PE-B150, RG180, RG195	<a href="#">PE4158</a>	\$29.29	\$27.83	\$26.36	\$25.19	57
			RG179, RG187	<a href="#">PE4249</a>	\$24.28	\$23.07	\$21.85	\$20.88	58
			RG59*, RG62*, RG71	<a href="#">PE4658</a>	\$30.45	\$28.93	\$27.41	\$26.19	59
<b>Plug, Bulkhead Mount</b>									
Terminal		Solder	Solder Cup with .295 inch D Hole	<a href="#">PE4291</a>	\$50.40	\$47.88	\$45.36	\$43.34	60

\* Fits MIL-C-17 and equivalent cable versions only



Technical Support  
+1 (949) 261-1920















Same-Day Shipping,  
Even Custom  
Cable Assemblies

Connectors







See Our Website For Current Pricing & Real-Time Stock Availability!



## 75 Ohm SMC Connectors

Connection Method	Product Image	Attachment Cable/Contact	Coax Type / Termination Type	Model No.	PRICE				ROW
					1-24	25-49	50-99	100 +	
<b>Plug Right Angle</b>									
Cable Connectors		Clamp/Solder	RG59*, RG62*	<a href="#">PE4266</a>	\$32.89	\$31.25	\$29.60	\$28.29	61
		Crimp/Solder	RG180, RG195	<a href="#">PE4162</a>	\$40.63	\$38.60	\$36.57	\$34.94	62
PCB Mount		Solder	Thru Hole with .200 inch x .067 inch Hole Spacing	<a href="#">PE4293</a>	\$49.99	\$47.49	\$44.99	\$42.99	63
<b>Jack</b>									
Cable Connectors		Clamp/Solder	RG180, RG195	<a href="#">PE4275</a>	\$35.78	\$33.99	\$32.20	\$30.77	64
			RG59*, RG62*	<a href="#">PE4274</a>	\$42.62	\$40.49	\$38.36	\$36.65	65
		Crimp/Solder	RG179, RG187	<a href="#">PE4254</a>	\$38.64	\$37.09	\$35.94	\$35.16	66
	RG180, RG195		<a href="#">PE4164</a>	\$32.82	\$31.51	\$30.52	\$29.87	67	
PCB Mount		Solder	Thru Hole with .200 inch x .067 inch Hole Spacing	<a href="#">PE4176</a>	\$23.17	\$22.24	\$21.55	\$21.08	68
<b>Jack, Bulkhead Mount</b>									
Cable Connectors		Clamp/Solder	RG179, RG187	<a href="#">PE4906</a>	\$48.12	\$45.71	\$43.31	\$41.38	69
			RG180, RG195 with .285 inch D Hole	<a href="#">PE4283</a>	\$31.88	\$30.29	\$28.69	\$27.42	70
		Crimp/Solder	RG179, RG187 with .285 inch D Hole	<a href="#">PE4256</a>	\$37.93	\$36.03	\$34.14	\$32.62	71
	RG180, RG195 with .177 inch D Hole		<a href="#">PE45205</a>	\$37.54	\$34.91	\$32.28	\$30.03	72	
Terminal		Solder	Solder Cup with .295 inch D Hole	<a href="#">PE4169</a>	\$50.05	\$47.55	\$45.05	\$43.04	73
			Solder Cup with .295 inch D Hole	<a href="#">PE4173</a>	\$34.96	\$33.21	\$31.46	\$30.07	74
<b>Jack Right Angle</b>									
PCB Mount		Solder	Thru Hole with .200 inch x .067 inch Hole Spacing	<a href="#">PE4180</a>	\$44.20	\$41.99	\$39.78	\$38.01	75

## 75 Ohm TNC Connectors

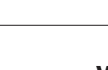
Connection Method	Product Image	Attachment Cable/Contact	Coax Type / Termination Type	Model No.	PRICE				ROW
					1-24	25-49	50-99	100 +	
<b>Male</b>									
Cable Connectors		Clamp/Solder	RG11*, RG144*, RG216*	<a href="#">PE44163</a>	\$64.46	\$61.24	\$58.01	\$55.44	76
			RG179, RG187	<a href="#">PE44167</a>	\$20.42	\$19.40	\$18.38	\$17.56	77
			RG59*	<a href="#">PE44165</a>	\$20.42	\$19.40	\$18.38	\$17.56	78
		Crimp/Solder	RG6	<a href="#">PE44161</a>	\$28.89	\$27.73	\$26.87	\$26.29	79
			RG11*, RG144*	<a href="#">PE44164</a>	\$46.82	\$44.48	\$42.14	\$40.27	80
			RG179, RG187	<a href="#">PE44168</a>	\$20.80	\$19.76	\$18.72	\$17.89	81
		RG59*, RG62*	<a href="#">PE44166</a>	\$20.42	\$19.40	\$18.38	\$17.56	82	
		RG6	<a href="#">PE44162</a>	\$23.60	\$22.42	\$21.24	\$20.30	83	
<b>Male Right Angle</b>									
Cable Connectors		Clamp/Solder	RG179, RG187	<a href="#">PE44172</a>	\$60.47	\$57.45	\$54.42	\$52.00	84
			RG59*, RG62*, RG71	<a href="#">PE44171</a>	\$63.50	\$60.33	\$57.15	\$54.61	85
<b>Female, Bulkhead Mount</b>									
Cable Connectors		Clamp/Solder	RG11*, RG216* with .480 inch D Hole	<a href="#">PE44174</a>	\$50.61	\$48.08	\$45.55	\$43.52	86
			RG179, RG187 with .480 inch D Hole	<a href="#">PE44176</a>	\$51.78	\$49.19	\$46.60	\$44.53	87
			RG6 with .480 inch D Hole	<a href="#">PE44173</a>	\$48.36	\$45.94	\$43.52	\$41.59	88
Terminal		Solder	Solder Cup with .410 inch D Hole	<a href="#">PE44177</a>	\$24.28	\$23.07	\$21.85	\$20.88	89
			Solder Cup with .480 inch D Hole	<a href="#">PE44181</a>	\$30.42	\$28.90	\$27.38	\$26.16	90

\* Fits MIL-C-17 and equivalent cable versions only









Connectors

See Our Website For Current Pricing & Real-Time Stock Availability!



## 75 Ohm TNC Connectors

Connection Method	Product Image	Attachment Cable/Contact	Coax Type / Termination Type	Model No.	PRICE				ROW
					1-24	25-49	50-99	100 +	
<b>Female, 4 Hole Flange Mount</b>									
Terminal		Solder	Solder Cup with .500 inch Threaded Hole Spacing	<a href="#">PE44178</a>	\$22.60	\$21.47	\$20.34	\$19.44	91

## BNC Twinax Connectors

Connection Method	Product Image	Attachment Cable/Contact	Coax Type / Termination Type	Model No.	PRICE				ROW
					1-24	25-49	50-99	100 +	
<b>Plug</b>									
Cable Connectors		Clamp/Solder	RG108, 78 Ohm Twinax	<a href="#">PE4236</a>	\$31.29	\$29.73	\$28.16	\$26.91	92
		Crimp/Solder	RG108, 78 Ohm Twinax	<a href="#">PE4234</a>	\$23.86	\$22.67	\$21.47	\$20.52	93
<b>Jack</b>									
Cable Connectors		Clamp/Solder	RG108, 78 Ohm Twinax	<a href="#">PE4237</a>	\$39.15	\$37.19	\$35.24	\$33.67	94
		Crimp/Solder	RG108, 78 Ohm Twinax	<a href="#">PE4235</a>	\$45.15	\$42.89	\$40.64	\$38.83	95
PCB Mount		Solder	Thru Hole with .687 inch x .500 inch Hole Spacing	<a href="#">PE44115</a>	\$35.26	\$33.85	\$32.79	\$32.09	96
<b>Jack, Bulkhead Mount</b>									
Cable Connectors		Clamp/Solder	RG108, 78 Ohm Twinax with .480 inch D Hole	<a href="#">PE44114</a>	\$54.40	\$51.68	\$48.96	\$46.78	97
Terminal		Solder	Solder Cup with .350 inch D Hole	<a href="#">PE4238</a>	\$25.29	\$24.03	\$22.76	\$21.75	98
<b>Jack, 4 Hole Flange Mount</b>									
Terminal		Solder	Solder Cup with .500 inch Threaded Hole Spacing	<a href="#">PE4324</a>	\$49.09	\$46.64	\$44.18	\$42.22	99
<b>Jack Right Angle</b>									
PCB Mount		Solder	Thru Hole with .687 inch x .500 inch Hole Spacing	<a href="#">PE44116</a>	\$54.16	\$51.45	\$48.74	\$46.58	1

## 3/4"-20 Twinax Connectors

Connection Method	Product Image	Attachment Cable/Contact	Coax Type / Termination Type	Model No.	PRICE				ROW
					1-24	25-49	50-99	100 +	
<b>Male</b>									
Cable Connectors		Clamp/Solder	PE-S330	<a href="#">PE4104</a>	\$32.50	\$30.88	\$29.25	\$27.95	2
<b>Female</b>									
Cable Connectors		Clamp/Solder	PE-S330	<a href="#">PE4346</a>	\$28.69	\$27.26	\$25.82	\$24.67	3

\* Fits MIL-C-17 and equivalent cable versions only



Technical Support  
+1 (949) 261-1920





Same-Day Shipping,  
Even Custom  
Cable Assemblies

Connectors

See Our Website For Current Pricing & Real-Time Stock Availability!

### 3/4"-20 Twinax Connectors

Connection Method	Product Image	Attachment Cable/Contact	Coax Type / Termination Type	Model No.	PRICE				ROW
					1-24	25-49	50-99	100 +	
<b>Female, Bulkhead Mount</b>									
Terminal		Solder	Solder Cup with .720 inch D Hole	<a href="#">PE4105</a>	\$29.81	\$28.32	\$26.83	\$25.64	4
<b>Female, 4 Hole Flange Mount</b>									
Terminal		Solder	Solder Cup with .718 inch Hole Spacing	<a href="#">PE4347</a>	\$35.44	\$33.67	\$31.90	\$30.48	5

### Banana Connectors

Connection Method	Product Image	Attachment Cable/Contact	Coax Type / Termination Type	Model No.	PRICE				ROW
					1-24	25-49	50-99	100 +	
<b>Plug</b>									
Cable Connectors		Crimp/Solder	RG55, RG142, RG223, RG400	<a href="#">PE4089</a>	\$11.48	\$10.91	\$10.33	\$9.87	6
			RG188-DS, RG316-DS	<a href="#">PE45164</a>	\$16.95	\$16.10	\$15.26	\$14.58	7

### Double Banana Connectors

Connection Method	Product Image	Attachment Cable/Contact	Coax Type / Termination Type	Model No.	PRICE				ROW
					1-24	25-49	50-99	100 +	
<b>Plug</b>									
Cable Connectors		Crimp/Solder	PE-C195, PE-P195, RG58, RG141, RG303, LMR-195, .195 inch	<a href="#">PE4301</a>	\$12.04	\$11.44	\$10.84	\$10.35	8
			RG174, RG316, RG188, .100 inch, PE-B100, PE-C100, LMR-100	<a href="#">PE44145</a>	\$15.67	\$14.89	\$14.10	\$13.48	9

### CONNECTOR DUST CAPS

#### Non-Shorting Caps

									
Connector	Gender	Compatible With	Chain	Model No	1-24	25-49	50-99	100+	ROW
7/16 DIN	Male	50 Ohm	Yes	<a href="#">PE6057</a>	\$49.22	\$46.76	\$44.30	\$42.33	10
	Female		Yes	<a href="#">PE6058</a>	\$58.56	\$55.63	\$52.70	\$50.36	11
BNC	Male		Yes	<a href="#">PE6013</a>	\$10.45	\$9.93	\$9.41	\$8.99	12
			No	<a href="#">PE6014</a>	\$5.85	\$5.56	\$5.27	\$5.03	13
	Female		Yes	<a href="#">PE6015</a>	\$8.53	\$8.10	\$7.68	\$7.34	14
			No	<a href="#">PE6108</a>	\$15.55	\$14.77	\$14.00	\$13.37	15
C	Male		Yes	<a href="#">PE6046</a>	\$31.72	\$30.13	\$28.55	\$27.28	16
			No	<a href="#">PE6109</a>	\$34.67	\$32.94	\$31.20	\$29.82	17
	Female		Yes	<a href="#">PE6110</a>	\$32.14	\$30.53	\$28.93	\$27.64	18
F	Male		No	<a href="#">PE6111</a>	\$24.30	\$23.09	\$21.87	\$20.90	19
			Yes	<a href="#">PE6240</a>	\$4.25	\$4.04	\$3.83	\$3.66	20
HN	Male		Yes	<a href="#">PE6059</a>	\$32.65	\$31.02	\$29.39	\$28.08	21
		No	<a href="#">PE6113</a>	\$24.08	\$22.88	\$21.67	\$20.71	22	
	Female	Yes	<a href="#">PE6114</a>	\$31.97	\$30.37	\$28.77	\$27.49	23	
		No	<a href="#">PE6115</a>	\$32.62	\$30.99	\$29.36	\$28.05	24	
N	Male	Yes	<a href="#">PE6016</a>	\$8.65	\$8.22	\$7.79	\$7.44	25	
		No	<a href="#">PE6017</a>	\$9.54	\$9.06	\$8.59	\$8.20	26	
	Female	Yes	<a href="#">PE6018</a>	\$13.03	\$12.38	\$11.73	\$11.21	27	
		No	<a href="#">PE6116</a>	\$11.27	\$10.71	\$10.14	\$9.69	28	

\* Fits MIL-C-17 and equivalent cable versions only

Connectors

See Our Website For Current Pricing & Real-Time Stock Availability!

## Non-Shorting Caps

Non-Shorting Caps										
Connector	Gender	Compatible With	Chain	Model No	1-24	25-49	50-99	100+	R O W	
SC	Male	50 Ohm	Yes	<a href="#">PE6117</a>	\$46.82	\$44.48	\$42.14	\$40.27	29	
	Female		Yes	<a href="#">PE6118</a>	\$39.67	\$37.69	\$35.70	\$34.12	30	
SMA	Male		Yes	<a href="#">PE6019</a>	\$20.50	\$19.48	\$18.45	\$17.63	31	
			No	<a href="#">PE6024</a>	\$4.51	\$4.28	\$4.06	\$3.88	32	
	Female		Yes	<a href="#">PE6119</a>	\$26.74	\$25.40	\$24.07	\$23.00	33	
			No	<a href="#">PE6120</a>	\$10.53	\$10.00	\$9.48	\$9.06	34	
SMB	Plug		75 Ohm	Yes	<a href="#">PE6121</a>	\$27.67	\$26.29	\$24.90	\$23.80	35
	Jack		50 Ohm	Yes	<a href="#">PE6122</a>	\$23.77	\$22.58	\$21.39	\$20.44	37
SMC	Plug		75 Ohm	Yes	<a href="#">PE6126</a>	\$40.02	\$38.02	\$36.02	\$34.42	38
	Jack		50 Ohm	Yes	<a href="#">PE6124</a>	\$18.54	\$17.61	\$16.69	\$15.94	39
SSMA	Male	No		<a href="#">PE6020</a>	\$21.26	\$20.20	\$19.13	\$18.28	40	
		Yes		<a href="#">PE6023</a>	\$11.84	\$11.25	\$10.66	\$10.18	41	
TNC	Female	No		<a href="#">PE6144</a>	\$11.04	\$10.49	\$9.94	\$9.49	42	
		Yes	<a href="#">PE6021</a>	\$14.56	\$13.83	\$13.10	\$12.52	43		

## Shorting Caps

Shorting Caps									
Connector	Gender	Compatible With	Chain	Model No	1-24	25-49	50-99	100+	R O W
2.4mm	Male	50 Ohm	Yes	<a href="#">PE6194</a>	\$69.19	\$66.42	\$64.35	\$62.96	44
	Female		Yes	<a href="#">PE6195</a>	\$83.32	\$79.15	\$74.99	\$71.66	45
			No	<a href="#">PE6193</a>	\$75.55	\$71.77	\$68.00	\$64.97	46
BNC	Male		Yes	<a href="#">PE6127</a>	\$27.02	\$25.67	\$24.32	\$23.24	47
			No	<a href="#">PE6012</a>	\$9.25	\$8.79	\$8.33	\$7.96	48
	Female		Yes	<a href="#">PE6128</a>	\$30.82	\$29.28	\$27.74	\$26.51	49
			No	<a href="#">PE6030</a>	\$17.30	\$16.44	\$15.57	\$14.88	50
N	Male		Yes	<a href="#">PE6129</a>	\$33.68	\$32.00	\$30.31	\$28.96	51
			No	<a href="#">PE6022</a>	\$25.04	\$23.79	\$22.54	\$21.53	52
	Female		Yes	<a href="#">PE6130</a>	\$54.39	\$51.67	\$48.95	\$46.78	53
		No	<a href="#">PE6031</a>	\$12.08	\$11.48	\$10.87	\$10.39	54	
SMA	Male	Yes	<a href="#">PE6131</a>	\$32.91	\$31.26	\$29.62	\$28.30	55	
		No	<a href="#">PE6006</a>	\$25.83	\$24.54	\$23.25	\$22.21	56	
	Female	Yes	<a href="#">PE6132</a>	\$37.81	\$35.92	\$34.03	\$32.52	57	
		Yes	<a href="#">PE6251</a>	\$27.86	\$26.75	\$25.91	\$25.35	58	
		No	<a href="#">PE6007</a>	\$27.31	\$25.94	\$24.58	\$23.49	59	
TNC	Male	Yes	<a href="#">PE6134</a>	\$30.81	\$29.27	\$27.73	\$26.50	60	
		No	<a href="#">PE6133</a>	\$27.25	\$25.89	\$24.53	\$23.44	61	
	Female	Yes	<a href="#">PE6136</a>	\$34.03	\$32.33	\$30.63	\$29.27	62	
		No	<a href="#">PE6135</a>	\$25.74	\$24.45	\$23.17	\$22.14	63	





## COUPLERS AND HYBRIDS

### Single Directional

#### 1.85mm Connectors



Frequency Range (MHz.)	Coupling (dB)	Maximum Power	Directivity (dB)	Model No	1	2-4	5-9	10+	ROW
1,000-67,000	10	20 Watt	8	<a href="#">PE2CP1127-10</a>	\$6,448.93	\$6,190.97	\$5,933.02	\$5,675.06	1
	20			<a href="#">PE2CP1127-20</a>	\$6,545.46	\$6,283.64	\$6,021.82	\$5,760.00	

#### 2.4mm Connectors



Frequency Range (MHz.)	Coupling (dB)	Maximum Power	Directivity (dB)	Model No	1	2-4	5-9	10+	ROW
2,000-52,000	10	20 Watt	10	<a href="#">PE2CP1134-10</a>	\$3,440.00	\$3,302.40	\$3,164.80	\$3,027.20	2
18,000-50,000	20		8	<a href="#">PE2CP1135-20</a>	\$3,363.15	\$3,228.62	\$3,094.10	\$2,959.57	3

#### 2.92mm Connectors



Frequency Range (MHz.)	Coupling (dB)	Maximum Power	Directivity (dB)	Model No	1	2-4	5-9	10+	ROW
1,000-40,000	10	20 Watt		<a href="#">PE2CP1122-10</a>	\$2,266.17	\$2,175.52	\$2,084.88	\$1,994.23	4
	20			<a href="#">PE2CP1122-20</a>	\$2,076.96	\$1,993.88	\$1,910.80	\$1,827.72	
	30			<a href="#">PE2CP1122-30</a>	\$2,224.18	\$2,135.21	\$2,046.25	\$1,957.28	
2,000-40,000	10		10	<a href="#">PE2CP1133-10</a>	\$1,926.07	\$1,849.03	\$1,771.98	\$1,694.94	5
	20			<a href="#">PE2CP1133-20</a>	\$1,699.00	\$1,631.04	\$1,563.08	\$1,495.12	
	30			<a href="#">PE2CP1133-30</a>	\$1,926.07	\$1,849.03	\$1,771.98	\$1,694.94	
6,000-26,500	10		12	<a href="#">PE2CP1129-10</a>	\$1,505.00	\$1,444.80	\$1,384.60	\$1,324.40	6
6,000-40,000				20	<a href="#">PE2CP1124-10</a>	\$1,812.70	\$1,740.19	\$1,667.68	\$1,595.18
8,000-40,000	10	30 Watt	10	<a href="#">PE2CP1124-20</a>	\$1,744.67	\$1,674.88	\$1,605.10	\$1,535.31	7
	20			<a href="#">PE2CP1125-10</a>	\$1,684.18	\$1,616.81	\$1,549.45	\$1,482.08	
	30			<a href="#">PE2CP1125-20</a>	\$1,709.39	\$1,641.01	\$1,572.64	\$1,504.26	
8,000-43,500	10		10	<a href="#">PE2CP1125-30</a>	\$1,709.39	\$1,641.01	\$1,572.64	\$1,504.26	8
	15			<a href="#">PE2CP1125-15</a>	\$1,684.18	\$1,616.81	\$1,549.45	\$1,482.08	
18,000-40,000	6		10	<a href="#">PE2CP1126-6</a>	\$1,503.93	\$1,443.77	\$1,383.62	\$1,323.46	9
	10			<a href="#">PE2CP1126-10</a>	\$1,526.45	\$1,465.39	\$1,404.33	\$1,343.28	
	20			<a href="#">PE2CP1126-20</a>	\$1,585.97	\$1,522.53	\$1,459.09	\$1,395.65	

#### 4.1/9.5 Mini DIN Connectors



Frequency Range (MHz.)	Coupling (dB)	Maximum Power	Directivity (dB)	Model No	1 Pc. Price	See Web for Volume Pricing	ROW	
698-2,700	6	200 Watt	20	<a href="#">PE2CP1059</a>	\$515.27	See Web for Volume Pricing	10	
	10			<a href="#">PE2CP1063</a>	\$511.53			11
	15			<a href="#">PE2CP1067</a>	\$590.56			12
	20			<a href="#">PE2CP1071</a>	\$511.53			13
	30			<a href="#">PE2CP1075</a>	\$511.53			14

#### 4.3-10 Connectors



Frequency Range (MHz.)	Coupling (dB)	Maximum Power	Directivity (dB)	Model No	1-4	5-9	10-24	25+	ROW
380-2,700	30	200 Watt	20	<a href="#">PE2CP1076</a>	\$560.08	\$532.08	\$504.07	\$481.67	15
698-2,700	6			<a href="#">PE2CP1060</a>	\$560.08	\$532.08	\$504.07	\$481.67	16
	10			<a href="#">PE2CP1064</a>	\$560.08	\$532.08	\$504.07	\$481.67	17

Couplers & Hybrids

### 4.3-10 Connectors



Frequency Range (MHz.)	Coupling (dB)	Maximum Power	Directivity (dB)	Model No	1-4	5-9	10-24	25+	ROW
698-2,700	15	200 Watt	20	<a href="#">PE2CP1068</a>	\$560.08	\$532.08	\$504.07	\$481.67	18
	20			<a href="#">PE2CP1072</a>	\$560.08	\$532.08	\$504.07	\$481.67	19

### 7/16 DIN Connectors



Frequency Range (MHz.)	Coupling (dB)	Maximum Power	Directivity (dB)	Model No	1-4	5-9	10-24	25+	ROW
698-2,700	6	200 Watt	20	<a href="#">PE2CP1058</a>	\$541.41	\$514.34	\$487.27	\$465.61	20
	10			<a href="#">PE2CP1062</a>	\$634.39	\$602.67	\$570.95	\$545.58	21
	15			<a href="#">PE2CP1066</a>	\$634.39	\$602.67	\$570.95	\$545.58	22
	20			<a href="#">PE2CP1070</a>	\$570.95	\$542.40	\$513.86	\$491.02	23
	30			<a href="#">PE2CP1074</a>	\$570.95	\$542.40	\$513.86	\$491.02	24

### N Connectors



Frequency Range (MHz.)	Coupling (dB)	Maximum Power	Directivity (dB)	Model No	1 Pc. Price	See Web for Volume Pricing			ROW
500-2,000	30	600 Watt	18	<a href="#">PE2240-30</a>	\$1,272.96				25
698-2,700	6	200 Watt	20	<a href="#">PE2CP1057</a>	\$511.89				26
	10			<a href="#">PE2CP1061</a>	\$568.79				27
	15			<a href="#">PE2CP1065</a>	\$568.79				28
	20			<a href="#">PE2CP1069</a>	\$589.50				29
	30			<a href="#">PE2CP1073</a>	\$589.50				30
800-2,500	6	60 Watt	20	<a href="#">PE2CP1023-6</a>	\$554.03				31
	10			<a href="#">PE2CP1023-10</a>	\$568.68				
	20			<a href="#">PE2CP1023-20</a>	\$555.20				
1,000-2,000	30	600 Watt	28	<a href="#">PE2CP1023-30</a>	\$555.66				32
1,000-4,000				<a href="#">PE2226-30</a>	\$1,375.05				
1,000-8,000				<a href="#">PE2228A-30</a>	\$1,919.27				
1,000-11,000				<a href="#">PE2239-30</a>	\$2,071.28				
4,000-8,000				<a href="#">PE2236-35</a>	\$2,768.59				
4,000-12,000	30	600 Watt	15	<a href="#">PE2230-30</a>	\$1,424.39				33
4,000-18,000	35			<a href="#">PE2235-30</a>	\$1,775.50				34
10	<a href="#">PE2230-30</a>			\$1,424.39				35	
4,000-18,000	20	50 Watt	12	<a href="#">PE2235-30</a>	\$1,775.50				36
	30			<a href="#">PE2CP1114-10</a>	\$633.72				37
	20			<a href="#">PE2CP1114-20</a>	\$624.36				38

### SMA Connectors



Frequency Range (MHz.)	Coupling (dB)	Maximum Power	Directivity (dB)	Model No	1 Pc. Price	See Web for Volume Pricing			ROW	
500-1,000	10		25	<a href="#">PE2200-10</a>	\$432.67				39	
	20			<a href="#">PE2200-20</a>	\$481.30					
	30			<a href="#">PE2200-30</a>	\$484.36					
500-2,000	6	50 Watt	20	<a href="#">PE2CP003-6</a>	\$426.06				40	
				23	<a href="#">PE2208-6</a>	\$553.89				41
	10			20	<a href="#">PE2CP003-10</a>	\$299.56				42
				23	<a href="#">PE2208-10</a>	\$567.06				43
				20	<a href="#">PE2CP003-20</a>	\$318.05				44
500-3,000	10	30 Watt	18	23	<a href="#">PE2208-20</a>	\$583.41			45	
				20	<a href="#">PE2242-10</a>	\$304.42				
	20			<a href="#">PE2242-20</a>	\$304.42					
				30	<a href="#">PE2242A-20</a>	\$304.42				
500-18,000	10	30 Watt	18	<a href="#">PE2242-30</a>	\$304.42				46	
	16			<a href="#">PE2243-10</a>	\$1,556.56				47	
	20			<a href="#">PE2243-16</a>	\$1,533.55				48	
	30			<a href="#">PE2243-20</a>	\$1,618.09				49	
	30			<a href="#">PE2243-30</a>	\$1,556.56				49	

Couplers & Hybrids

## SMA Connectors



**Couplers & Hybrids**

Frequency Range (MHz.)	Coupling (dB)	Maximum Power	Directivity (dB)	Model No	1 Pc. Price	See Web for Volume Pricing	R O W		
600-4,000	10	50 Watt	18	<a href="#">PE2213-10</a>	\$815.06	See Web for Volume Pricing	50		
700-2,700	6		<a href="#">PE2CP002-6</a>	20	<a href="#">PE2CP002-10</a>		\$282.77	51	
	10		<a href="#">PE2CP002-20</a>		<a href="#">PE2CP025-10</a>		\$278.60	52	
800-2,200	20		<a href="#">PE2CP1024-6</a>		<a href="#">PE2CP1025-20</a>		\$273.39	53	
	10		<a href="#">PE2CP1024-30</a>		<a href="#">PE2201-10</a>		\$236.02	54	
800-2,500	6		<a href="#">PE2201-30</a>		25		<a href="#">PE2CP1025-10</a>	\$542.20	55
	10		<a href="#">PE2CP1108</a>				<a href="#">PE2201-10</a>	\$568.79	56
	20		<a href="#">PE2201-30</a>				<a href="#">PE2201-10</a>	\$507.94	57
1,000-2,000	30		<a href="#">PE2CP005-6</a>		20		<a href="#">PE2209-6</a>	\$403.58	58
	10		<a href="#">PE2209-6</a>				<a href="#">PE2CP005-10</a>	\$235.09	59
	20		<a href="#">PE2209-6</a>	<a href="#">PE2209-6</a>			\$555.59	60	
1,000-4,000	6		4 Watt	12	<a href="#">PE2CP005-10</a>		\$227.16	61	
	10				<a href="#">PE2CP1102</a>		\$202.32	62	
	20				<a href="#">PE2CP005-20</a>		\$241.22	63	
	20				<a href="#">PE2209-20</a>		\$605.44	64	
2,000-4,000	6		50 Watt	22	<a href="#">PE2202-6</a>		\$396.79	65	
	30				<a href="#">PE2202-30</a>		\$416.48	66	
2,000-8,000	6		50 Watt	20	<a href="#">PE2CP004-6</a>		\$305.25	67	
	10	<a href="#">PE2210-6</a>			\$528.94		68		
	20	<a href="#">PE2CP004-10</a>			\$328.21		69		
	20	<a href="#">PE2210-10</a>			\$501.88		70		
	20	<a href="#">PE2CP004-20</a>			\$321.90		71		
	20	<a href="#">PE2210-20</a>			\$554.23		72		
2,000-18,000	6	50 Watt	10	<a href="#">PE2215-6</a>	\$1,962.88		73		
	10	25 Watt		<a href="#">PE2CP000-10</a>	\$674.65		74		
	20	50 Watt		<a href="#">PE2CP1103</a>	\$483.70		75		
	30			<a href="#">PE2215-10</a>	\$2,214.16		76		
	30			<a href="#">PE2CP000-20</a>	\$711.20		77		
2,000-18,400	20	25 Watt	<a href="#">PE2CP000-30</a>	\$691.26	78				
2,600-5,200	10	50 Watt	20	<a href="#">PE2215-20</a>	\$1,892.04		79		
	20			<a href="#">PE2203-10</a>	\$569.83		80		
	30			<a href="#">PE2CP1109</a>	\$196.50		81		
	30			<a href="#">PE2203-20</a>	\$581.57		82		
4,000-8,000	6	50 Watt	17	<a href="#">PE2203-30</a>	\$596.52		83		
	10			<a href="#">PE2204-6</a>	\$379.97		84		
	20			<a href="#">PE2204-10</a>	\$303.48		85		
	30			<a href="#">PE2204-20</a>	\$380.97		86		
	30			<a href="#">PE2204-30</a>	\$416.07		87		
4,000-12,400	6	30 Watt	13	<a href="#">PE2211-6</a>	\$589.50		88		
	10			<a href="#">PE2211-10</a>	\$539.32		89		
	20			<a href="#">PE2211-20</a>	\$568.53		90		
4,000-18,000	6	50 Watt	12	<a href="#">PE2CP1100</a>	\$415.69		91		
	10			<a href="#">PE2CP1104</a>	\$415.69		92		
	20			<a href="#">PE2CP1110</a>	\$409.55		93		
6,000-18,000	10	30 Watt	10	<a href="#">PE2CP001-10</a>	\$522.57		94		
	20			<a href="#">PE2CP001-20</a>	\$522.57		95		
6,000-26,500	10	50 Watt	12	<a href="#">PE2CP1120-10</a>	\$1,132.52		96		
	30			<a href="#">PE2CP1120-30</a>	\$1,073.93		97		
6,000-26,600	20	30 Watt	13	<a href="#">PE2CP1120-20</a>	\$1,132.52		98		
7,000-12,400	6	50 Watt	17	<a href="#">PE2CP1101</a>	\$327.63		99		
	10			<a href="#">PE2CP1105</a>	\$332.55		100		
	20			<a href="#">PE2205-20</a>	\$534.52		101		
	30			<a href="#">PE2205-30</a>	\$533.55		102		
7,000-16,000	10	4 Watt	15	<a href="#">PE2CP1112</a>	\$374.12		103		
7,000-18,000	10			<a href="#">PE2CP1106</a>	\$340.10		104		
7,500-16,000	6	50 Watt	12	<a href="#">PE2206-6</a>	\$513.94		105		
	10			<a href="#">PE2CP1107</a>	\$320.06		106		
12,400-18,000	6	4 Watt	15	<a href="#">PE2207-6</a>	\$608.13		107		
	10	50 Watt		<a href="#">PE2207-10</a>	\$526.36		108		
	20			<a href="#">PE2CP1111</a>	\$370.34		109		
18,000-26,000	30	30 Watt	13	<a href="#">PE2207-30</a>	\$544.16		110		
	30	<a href="#">PE2CP1121-30</a>		\$937.16	111				

## Dual Directional

### N Connectors



Frequency Range (MHz.)	Coupling (dB)	Maximum Power	Directivity (dB)	Model No	1	2-4	5-9	10+	ROW	
2-30	50	2500 Watt	22	<a href="#">PE2CP1000</a>	\$3,299.00	\$3,167.04	\$3,035.08	\$2,903.12	99	
20-500		500 Watt		<a href="#">PE2CP1002</a>	\$1,911.77	\$1,835.30	\$1,758.83	\$1,682.36	1	
20-1,000		1000 Watt		<a href="#">PE2CP1003</a>	\$2,554.72	\$2,452.53	\$2,350.34	\$2,248.15	2	
80-1,000	50	500 Watt	20	<a href="#">PE2CP1005</a>	\$1,898.81	\$1,822.86	\$1,746.91	\$1,670.95	3	
		1000 Watt		<a href="#">PE2CP1007</a>	\$1,860.06	\$1,785.66	\$1,711.26	\$1,636.85	4	
		200 Watt		<a href="#">PE2CP1008</a>	\$2,652.21	\$2,546.12	\$2,440.03	\$2,333.94	5	
100-500	40	500 Watt	20	<a href="#">PE2CP1021</a>	\$1,554.52	\$1,492.34	\$1,430.16	\$1,367.98	6	
		1000 Watt		<a href="#">PE2CP1010</a>	\$1,743.84	\$1,674.09	\$1,604.33	\$1,534.58	7	
		200 Watt		<a href="#">PE2CP1020</a>	\$2,449.78	\$2,351.79	\$2,253.80	\$2,155.81	8	
500-2,500	40	200 Watt	18	<a href="#">PE2CP1011</a>	\$1,118.66	\$1,073.91	\$1,029.17	\$984.42	9	
500 Watt		<a href="#">PE2CP1012</a>		\$1,800.16	\$1,728.15	\$1,656.15	\$1,584.14	10		
200 Watt		<a href="#">PE2CP1013</a>		\$1,937.61	\$1,860.11	\$1,782.60	\$1,705.10	11		
500-3,000	20	500 Watt	18	<a href="#">PE2CP1015</a>	\$1,899.00	\$1,823.04	\$1,747.08	\$1,671.12	12	
800-2,500		200 Watt		20	<a href="#">PE2CP1016</a>	\$2,220.63	\$2,131.80	\$2,042.98	\$1,954.15	13
800-4,200		500 Watt			<a href="#">PE2CP1019</a>	\$1,543.00	\$1,481.28	\$1,419.56	\$1,357.84	14
2,000-6,000	20	200 Watt	15							

### SC Connectors



Frequency Range (MHz.)	Coupling (dB)	Maximum Power	Directivity (dB)	Model No	1	2-4	5-9	10+	ROW
20-1,000	50	1000 Watt	20	<a href="#">PE2CP1006</a>	\$2,955.39	\$2,837.17	\$2,718.96	\$2,600.74	15
800-4,200	40	600 Watt	18	<a href="#">PE2CP1017</a>	\$3,039.00	\$2,917.44	\$2,795.88	\$2,674.32	16

### SMA Connectors



Frequency Range (MHz.)	Coupling (dB)	Maximum Power	Directivity (dB)	Model No	1 Pc. Price	See Web for Volume Pricing			ROW	
20-520	50	200 Watt	20	<a href="#">PE2CP1001</a>	\$1,222.63				17	
20-1,000				<a href="#">PE2CP1004</a>	\$1,533.92				18	
100-500				<a href="#">PE2CP1009</a>	\$1,403.83				19	
500-1,000	10	50 Watt	22	<a href="#">PE2217-10</a>	\$821.89				20	
	20			<a href="#">PE2217-20</a>	\$835.13				21	
	30			<a href="#">PE2217-30</a>	\$803.00				22	
800-2,500	40	200 Watt	20	<a href="#">PE2CP1014</a>	\$1,166.92				23	
	10	10 Watt		22	<a href="#">PE2218-10</a>				\$803.00	24
	20	50 Watt			<a href="#">PE2218-20</a>				\$803.00	25
1,000-2,000	30		50 Watt	20	<a href="#">PE2218-30</a>	\$813.90				26
	40	20			<a href="#">PE2219-20</a>	\$924.81				27
	2,000-4,000				20	<a href="#">PE2CP1018</a>				\$1,155.09
2,000-6,000	20	100 Watt	16	<a href="#">PE2CP1113</a>	\$672.63				29	
2,000-8,000		50 Watt		18	<a href="#">PE2220-10</a>				\$842.15	30
2,600-5,200		10			50 Watt				<a href="#">PE2220-20</a>	\$743.13
	20	<a href="#">PE2220-30</a>	\$757.13	32						
	30	16	<a href="#">PE2221-10</a>	\$818.14		33				
4,000-8,000	10 Watt		<a href="#">PE2222-30</a>	\$803.00	34					
7,000-12,400	30	50 Watt	15	<a href="#">PE2223-10</a>	\$803.00				35	
8,000-16,000	10	10 Watt		<a href="#">PE2223-20</a>	\$835.13				36	
	20			<a href="#">PE2223-30</a>	\$834.18				37	
	30		50 Watt	<a href="#">PE2224-20</a>	\$827.81	38				
12,400-18,000	20									





## 90 Degree Hybrids

### 2.92mm Connectors



Frequency Range (MHz.)	Coupling (dB)	Maximum Power	Minimum Isolation (dB)	Model No	1-4	5-9	10-24	25+	ROW
2,000-40,000		20 Watt	10	<a href="#">PE2CP1150</a>	\$1,998.76	\$1,898.82	\$1,798.88	\$1,718.93	39
5,000-26,500			14	<a href="#">PE2CP1147</a>	\$999.38	\$949.41	\$899.44	\$859.47	40
8,000-43,500			12	<a href="#">PE2CP1149</a>	\$1,499.07	\$1,424.12	\$1,349.16	\$1,289.20	41
10,000-26,500			15	<a href="#">PE2CP1146</a>	\$999.38	\$949.41	\$899.44	\$859.47	42
20,000-40,000			12	<a href="#">PE2CP1148</a>	\$1,499.07	\$1,424.12	\$1,349.16	\$1,289.20	43

### Pin Connectors

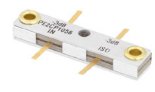

Frequency Range (MHz.)	Coupling (dB)	Maximum Power	Minimum Isolation (dB)	Model No	1 Pc. Price	See Web for Volume Pricing	ROW
20-1,000		50 Watt	16	<a href="#">PE2CP1026</a>	\$852.74	See Web for Volume Pricing	64
		150 Watt		<a href="#">PE2CP1027</a>	\$950.99		65
80-1,000		250 Watt	16	<a href="#">PE2CP1028</a>	\$667.47		66
		150 Watt		<a href="#">PE2CP1029</a>	\$312.04		67
130-180		200 Watt	20	<a href="#">PE2CP1032</a>	\$98.45		68
		800 Watt	18	<a href="#">PE2CP1033</a>	\$411.15		69
225-400		250 Watt	18	<a href="#">PE2CP1034</a>	\$115.38		70
		400 Watt		20	<a href="#">PE2CP1035</a>		\$160.89
225-450		800 Watt	20	<a href="#">PE2CP1036</a>	\$411.15		72
		200 Watt		19	<a href="#">PE2CP1037</a>		\$82.94
400-1,000		400 Watt	20	<a href="#">PE2CP1038</a>	\$122.42		74
		800 Watt		<a href="#">PE2CP1039</a>	\$478.85		75
500-2,500		150 Watt	18	<a href="#">PE2CP1040</a>	\$192.27		76
		200 Watt	17	<a href="#">PE2CP1041</a>	\$292.60		77
500-3,000		300 Watt	17	<a href="#">PE2CP1042</a>	\$422.76		78
		125 Watt		18	<a href="#">PE2CP1043</a>		\$195.15
800-1,600		200 Watt	17	<a href="#">PE2CP1044</a>	\$354.56		80
			20	<a href="#">PE2CP1045</a>	\$95.17		81
800-2,500		200 Watt	18	<a href="#">PE2CP1046</a>	\$150.22		82
			17	<a href="#">PE2CP1047</a>	\$705.80		83
800-2,700		400 Watt	17	<a href="#">PE2CP1048</a>	\$87.09	84	
				125 Watt	20	<a href="#">PE2CP1049</a>	\$85.46
960-1,220		200 Watt	20	<a href="#">PE2CP1050</a>	\$112.80	86	
				400 Watt	<a href="#">PE2CP1051</a>	\$478.85	87
1,000-2,000		1000 Watt	18	<a href="#">PE2CP1052</a>	\$102.03	88	
				150 Watt	<a href="#">PE2CP1053</a>	\$181.39	89
1,000-3,000		450 Watt	16	<a href="#">PE2CP1054</a>	\$165.44	90	
				80 Watt	<a href="#">PE2CP1055</a>	\$87.09	91
1,000-4,200		80 Watt	18	<a href="#">PE2CP1056</a>	\$85.54	92	
2,000-4,000							
2,000-6,000							

### SMA Connectors



Frequency Range (MHz.)	Coupling (dB)	Maximum Power	Minimum Isolation (dB)	Model No	1 Pc. Price	See Web for Volume Pricing	ROW
500-1,000		50 Watt	22	<a href="#">PE2CP011</a>	\$261.79	See Web for Volume Pricing	44
		100 Watt	28	<a href="#">PE2CP1140</a>	\$499.69		45
800-3,000		100 Watt	20	<a href="#">PE2050</a>	\$551.97		46
			22	<a href="#">PE2CP021</a>	\$388.25		47
1,000-2,000		50 Watt	22	<a href="#">PE2CP013</a>	\$261.79		48
			15	<a href="#">PE2CP1144</a>	\$636.28		49
1,000-18,000		50 Watt	23	<a href="#">PE2CP1145</a>	\$556.33		50
			22	<a href="#">PE2CP017</a>	\$261.79		51
2,000-4,000		30 Watt	22	<a href="#">PE2052</a>	\$478.74		52
			17	<a href="#">PE2058</a>	\$543.95		53
2,000-8,000		30 Watt	15	<a href="#">PE2CP023</a>	\$1,070.38		54
			18	<a href="#">PE2CP019</a>	\$261.79		55
2,000-18,000		50 Watt	18	<a href="#">PE2CP019</a>	\$261.79		55
				100 Watt	<a href="#">PE2059</a>		\$813.41
4,000-8,000	4	100 Watt	16	<a href="#">PE2CP1143</a>	\$556.33		57
				50 Watt	20		<a href="#">PE2CP1141</a>

Couplers & Hybrids

## SMA Connectors



Frequency Range (MHz.)	Coupling (dB)	Maximum Power	Minimum Isolation (dB)	Model No	1 Pc. Price	See Web for Volume Pricing			ROW
6,000-12,400	3	100 Watt	17	<a href="#">PE2055</a>	\$601.31	See Web for Volume Pricing			59
6,000-18,000	3	30 Watt	16	<a href="#">PE2CP1142</a>	\$586.30				60
7,000-18,000			18	<a href="#">PE2CP1022</a>	\$691.33				61
7,500-16,000	100 Watt		<a href="#">PE2056A</a>	\$584.58	62				
12,000-18,000	40 Watt	15	<a href="#">PE2057</a>	\$527.79	63				

## 180 Degree Hybrids

### 2.92mm Connectors



Frequency Range (MHz.)	Coupling (dB)	Maximum Power	Minimum Isolation (dB)	Model No	1-4	5-9	10-24	25+	ROW
26,500-40,000		20 Watt	15	<a href="#">PE2CP1161</a>	\$2,085.37	\$1,981.10	\$1,876.83	\$1,793.42	93

## SMA Connectors



Frequency Range (MHz.)	Coupling (dB)	Maximum Power	Minimum Isolation (dB)	Model No	1-4	5-9	10-24	25+	ROW
500-1,000		50 Watt	22	<a href="#">PE2CP1151</a>	\$689.58	\$655.10	\$620.62	\$593.04	94
1,000-2,000				<a href="#">PE2CP1152</a>	\$689.58	\$655.10	\$620.62	\$593.04	95
1,300-2,600		100 Watt	20	<a href="#">PE2CP1153</a>	\$689.58	\$655.10	\$620.62	\$593.04	96
1,400-6,000		30 Watt	22	<a href="#">PE2CP1154</a>	\$1,345.84	\$1,278.55	\$1,211.26	\$1,157.42	97
2,000-4,000		50 Watt	20	<a href="#">PE2CP1155</a>	\$689.58	\$655.10	\$620.62	\$593.04	98
2,000-8,000		30 Watt		<a href="#">PE2CP1157</a>	\$899.45	\$854.48	\$809.51	\$773.53	99
2,000-18,000		50 Watt	16	<a href="#">PE2CP1158</a>	\$1,399.14	\$1,329.18	\$1,259.23	\$1,203.26	1
4,000-8,000		80 Watt	18	<a href="#">PE2CP1159</a>	\$766.19	\$727.88	\$689.57	\$658.92	2
4,000-18,000		50 Watt		<a href="#">PE2CP1160</a>	\$1,042.69	\$990.56	\$938.42	\$896.71	3

## RF DIPLEXERS

75 Ohm Diplexer F Female with 5 MHz to 390 MHz Low Pass and 650 MHz to 1,000 MHz High Pass

[PE8DP1001](#)

- 5 - 1000 MHz
- 75 Ohms Impedance
- Typical Return loss 18 dB

- Bidirectional design
- EN 50083-2 Class A Standard



In-stock and available to ship today!



Technical Support  
+1 (949) 261-1920



Same-Day Shipping,  
Even Custom  
Cable Assemblies

## FILTERS

**NEW**

Low Pass Harmonic Filters: [PEHFL0000](#) - [PEHFL0001](#)

- Passband frequency: DC - 6000Hz
- 50 Ohms impedance
- Broadband design: C, L & S Band
- RF input power passband: 50 W
- VSWR: 1.5:1



**In-stock and available to ship today!**

## FILTERS

### SMA Connectors

#### Bandpass Filters



Bandpass Frequency (MHz)	Application	Rejection (MHz)	Max. Insertion Loss (dB)	Model No	1 Pc. Price	See Web for Volume Pricing	ROW
824 - 849	GSM	50 dB at 736.5 50 dB at 936.5	2	<a href="#">PE8705</a>	\$512.83	See Web for Volume Pricing	4
869 - 894	GSM	50 dB at 781.5 50 dB at 981.5		<a href="#">PE8706</a>	\$527.62		5
902 - 928	ISM, RFID	50 dB at 815 50 dB at 1,015		<a href="#">PE8700</a>	\$532.82		6
1,000 - 2,000		55 dB at 650 55 dB at 3,000	1	<a href="#">PE87FL1012</a>	\$457.99		7
1,217 - 1,237	GPS L2	50 dB at 1,127 50 dB at 1,327		<a href="#">PE8704</a>	\$573.83		8
1,565 - 1,585	GPS L1	50 dB at 1,475 50 dB at 1,675	2	<a href="#">PE8703</a>	\$532.82		9
1,710 - 1,770	UMTS/AWS	50 dB at 1,490 50 dB at 1,990		<a href="#">PE8710</a>	\$527.62		10
1,850 - 1,910	PCS	50 dB at 1,630 50 dB at 2,130		<a href="#">PE8707</a>	\$533.35		11
1,920 - 1,980	UMTS	50 dB at 1,700 50 dB at 2,200	1	<a href="#">PE8709</a>	\$560.44		12
1,930 - 1,990	PCS	50 dB at 1,710 50 dB at 2,210		<a href="#">PE8708</a>	\$633.14		13
2,000 - 4,000		55 dB at 1,300 55 dB at 6,000		<a href="#">PE87FL1013</a>	\$475.84		14
2,110 - 2,170	UMTS/AWS	50 dB at 1,890 50 dB at 2,390	1	<a href="#">PE8711</a>	\$785.12		15
2,400 - 2,500	ISM, WiFi, Bluetooth, Zigbee	50 dB at 2,050 50 dB at 2,850		<a href="#">PE8701</a>	\$531.76		16
2,500 - 2,700	WiMAX	50 dB at 1,700 50 dB at 3,500		<a href="#">PE8712</a>	\$608.36		17
3,300 - 3,700	WiMAX	50 dB at 1,600 50 dB at 5,400	1	<a href="#">PE8713</a>	\$559.17		18
4,400 - 4,950	P2P, Public Safety	30 dB at 5,250 30 dB at 5,850		<a href="#">PE8739</a>	\$394.23		19
4,900 - 5,900	WiMAX	50 dB at 400 50 dB at 10,400		<a href="#">PE8714</a>	\$502.96		20
5,250 - 5,850	P2P, Public Safety	30 dB at 4,400 30 dB at 4,950	1	<a href="#">PE8740</a>	\$367.45		21
5,725 - 5,875	ISM, WiFi	50 dB at 5,200 50 dB at 6,400		<a href="#">PE8702</a>	\$509.82		22
7,250 - 7,750	VSAT	30 dB at 7,900 30 dB at 8,400		<a href="#">PE8741</a>	\$423.26		23
7,900 - 8,400	VSAT	30 dB at 7,250 30 dB at 7,750	1	<a href="#">PE8742</a>	\$423.26		24
9,900 - 10,800		50 dB at 8,350 50 dB at 12,350		<a href="#">PE87FL1000</a>	\$543.60		25
10,550 - 11,800		50 dB at 8,425 50 dB at 13,925		<a href="#">PE87FL1001</a>	\$540.93		26
10,700 - 12,200		50 dB at 8,450 50 dB at 14,450	<a href="#">PE87FL1003</a>	\$540.93	27		

## SMA Connectors

### Bandpass Filters



Bandpass Frequency (MHz)	Application	Rejection (MHz)	Max. Insertion Loss (dB)	Model No	1-9	10-24	25-49	50+	R O W
11,700 - 12,800		50 dB at 9,750 50 dB at 14,750	1	<a href="#">PE87FL1002</a>	\$540.93	\$513.88	\$486.84	\$465.20	28
12,200 - 12,700		50 dB at 11,450 50 dB at 13,450	2	<a href="#">PE87FL1004</a>	\$532.94	\$506.29	\$479.65	\$458.33	29
14,000 - 14,800		50 dB at 12,850 50 dB at 15,950		<a href="#">PE87FL1005</a>	\$505.54	\$480.26	\$454.99	\$434.76	30
17,200 - 18,200		35 dB at 16,200 35 dB at 19,200	1	<a href="#">PE87FL1008</a>	\$505.54	\$480.26	\$454.99	\$434.76	31
17,200 - 21,200		50 dB at 13,450 50 dB at 24,950		<a href="#">PE87FL1007</a>	\$486.56	\$462.23	\$437.90	\$418.44	32
17,300 - 18,100		50 dB at 16,200 50 dB at 19,200	2	<a href="#">PE87FL1006</a>	\$540.93	\$513.88	\$486.84	\$465.20	33
17,700 - 21,200	VSAT	50 dB at 16,000 50 dB at 24,000		<a href="#">PE8743</a>	\$516.42	\$490.60	\$464.78	\$444.12	34
18,200 - 19,200		35 dB at 17,200 35 dB at 20,200	2	<a href="#">PE87FL1009</a>	\$505.54	\$480.26	\$454.99	\$434.76	35
19,200 - 20,200		35 dB at 18,200 35 dB at 21,200		<a href="#">PE87FL1010</a>	\$510.14	\$484.63	\$459.13	\$438.72	36
20,200 - 21,200		35 dB at 19,200 35 dB at 22,200	3	<a href="#">PE87FL1011</a>	\$486.56	\$462.23	\$437.90	\$418.44	37
27,500 - 31,000	VSAT	50 dB at 25,000 50 dB at 32,750		<a href="#">PE8747</a>	\$469.25	\$445.79	\$422.33	\$403.56	38

### Highpass Filters



Bandpass Frequency (MHz)	Application	Rejection (MHz)	Max. Insertion Loss (dB)	Model No	1 Pc. Price	See Web for Volume Pricing			R O W
100 - 300		60 dB at 15	1	<a href="#">PE8717</a>	\$413.85	See Web for Volume Pricing			39
100 - 750		60 dB at 50		<a href="#">PE8716</a>	\$660.01				40
100 - 2,500		60 dB at 500		<a href="#">PE8715</a>	\$413.85				41
300 - 1,000		60 dB at 150	2	<a href="#">PE8718</a>	\$394.54	See Web for Volume Pricing			42
1,000 - 13,000		40 dB at 0		<a href="#">PE87FL1018</a>	\$848.67				43
2,000 - 18,000				<a href="#">PE87FL1019</a>	\$832.35				44

### Lowpass Filters



Bandpass Frequency (MHz)	Application	Rejection (MHz)	Max. Insertion Loss (dB)	Model No	1 Pc. Price	See Web for Volume Pricing			R O W
DC - 30		60 dB at 60	1	<a href="#">PE8723</a>	\$375.88	See Web for Volume Pricing			45
DC - 100		60 dB at 200		<a href="#">PE8719</a>	\$368.98				46
DC - 225		60 dB at 450		<a href="#">PE8722</a>	\$355.14				47
DC - 300		60 dB at 600		<a href="#">PE8724</a>	\$592.63				48
DC - 400		60 dB at 800		<a href="#">PE8726</a>	\$271.46				49
DC - 700		60 dB at 1,400		<a href="#">PE8727</a>	\$393.08				50
DC - 1,000		60 dB at 2,000		<a href="#">PE8720</a>	\$358.64				51
DC - 2,000		60 dB at 4,000		<a href="#">PE8721</a>	\$353.35				52
DC - 3,000		60 dB at 6,000		<a href="#">PE8725</a>	\$419.01				53
DC - 4,400		50 dB at 12,000		2	<a href="#">PE87FL1014</a>				\$475.84
DC - 7,000		50 dB at 15,000	<a href="#">PE87FL1015</a>		\$475.84	55			
DC - 9,500		50 dB at 18,000	<a href="#">PE87FL1016</a>		\$475.84	56			
DC - 11,000			<a href="#">PE87FL1017</a>	\$475.84	57				



**N**

**Band Pass**



Bandpass Frequency (MHz)	Application	Rejection (MHz)	Max. Insertion Loss (dB)	Model No	1	2-4	5-9	10+	ROW
250 - 500				<a href="#">PE8729</a>	\$2,464.45	\$2,378.19	\$2,291.94	\$2,218.01	58
500 - 1 GHz				<a href="#">PE8730</a>	\$2,648.30	\$2,555.61	\$2,462.92	\$2,383.47	59
750 - 1.5 GHz				<a href="#">PE8731</a>	\$2,609.98	\$2,518.63	\$2,427.28	\$2,348.98	60
1 GHz - 2 GHz				<a href="#">PE8732</a>	\$2,448.44	\$2,362.74	\$2,277.05	\$2,203.60	61
1.5 GHz - 3 GHz				<a href="#">PE8733</a>	\$2,617.27	\$2,525.67	\$2,434.06	\$2,355.54	62

**Band Reject**



Bandpass Frequency (MHz)	Application	Rejection (MHz)	Max. Insertion Loss (dB)	Model No	1	2-4	5-9	10+	ROW
100 - 200				<a href="#">PE8734</a>	\$2,679.26	\$2,585.49	\$2,491.71	\$2,411.33	63
200 - 400				<a href="#">PE8735</a>	\$2,416.65	\$2,332.07	\$2,247.48	\$2,174.99	64
250 - 500				<a href="#">PE8736</a>	\$2,857.88	\$2,757.85	\$2,657.83	\$2,572.09	65
1 GHz - 2 GHz				<a href="#">PE8738</a>	\$2,583.56	\$2,493.14	\$2,402.71	\$2,325.20	66

**FREQUENCY DIVIDERS**



Input Frequency (GHz)	Divide-By Prescaler	CW Input Power (CW) (dBm)	Typ Power Out (dBm)	Phase Noise @100 kHz (dBc/Hz)	DC Bias (Volts/mA)	Model No	1	2-4	5-9	10+	ROW
0.1 - 7	3	-12	-1	-150	+12 / 70	<a href="#">PE88D3000</a>	\$1,027.86	\$966.19	\$914.80	\$873.68	67
	5					<a href="#">PE88D2500Q</a>	\$974.68	\$916.20	\$867.47	\$828.48	68
	15					<a href="#">PE88D1500Q</a>	\$1,075.00	\$1,010.50	\$956.75	\$913.75	69
0.1 - 12	8				+12 / 75	<a href="#">PE88D8003</a>	\$1,078.58	\$1,013.87	\$959.94	\$916.79	70
	24					<a href="#">PE88D2400Q</a>	\$1,247.00	\$1,172.18	\$1,109.83	\$1,059.95	71
	40					<a href="#">PE88D4000Q</a>	\$1,265.68	\$1,189.74	\$1,126.46	\$1,075.83	72
0.1 - 12.5	10			-144	+12 / 200	<a href="#">PE88D1001</a>	\$1,315.04	\$1,236.14	\$1,170.39	\$1,117.78	73
0.1 - 13	4		5	-151	+12 / 120	<a href="#">PE88D4003</a>	\$1,171.44	\$1,101.15	\$1,042.58	\$995.72	74
	12					<a href="#">PE88D1200Q</a>	\$1,265.68	\$1,189.74	\$1,126.46	\$1,075.83	75
	20					<a href="#">PE88D2000Q</a>	\$1,247.00	\$1,172.18	\$1,109.83	\$1,059.95	76
0.1 - 15	5		5	-153	+5 / 205	<a href="#">PE88D5001</a>	\$1,640.28	\$1,541.86	\$1,459.85	\$1,394.24	77
	6					<a href="#">PE88D6000</a>	\$1,616.08	\$1,519.12	\$1,438.31	\$1,373.67	78
	7					<a href="#">PE88D7000</a>	\$1,616.08	\$1,519.12	\$1,438.31	\$1,373.67	79
	9					<a href="#">PE88D9000</a>	\$1,616.08	\$1,519.12	\$1,438.31	\$1,373.67	80
0.1 - 20	2				+5 / 160	<a href="#">PE88D2002</a>	\$1,704.26	\$1,602.00	\$1,516.79	\$1,448.62	81
	4					<a href="#">PE88D4002</a>	\$1,640.28	\$1,541.86	\$1,459.85	\$1,394.24	82
	8					<a href="#">PE88D8002</a>	\$1,616.08	\$1,519.12	\$1,438.31	\$1,373.67	83
0.2 - 6	10		-2	-144	+12 / 100	<a href="#">PE88D1002</a>	\$887.43	\$834.18	\$789.81	\$754.32	84
	20					<a href="#">PE88D20001</a>	\$887.43	\$834.18	\$789.81	\$754.32	85
0.4 - 4	16				+12 / 95	<a href="#">PE88D1600Q</a>	\$774.00	\$727.56	\$688.86	\$657.90	86
	32					<a href="#">PE88D3200Q</a>	\$785.59	\$738.45	\$699.18	\$667.75	87
0.5 - 8	5	-20	-1		+5 / 80	<a href="#">PE88D5000</a>	\$2,957.41	\$2,839.11	\$2,720.82	\$2,602.52	88
0.5 - 18	2	-15	-4	-147	+12 / 85	<a href="#">PE88D2001</a>	\$1,479.93	\$1,391.13	\$1,317.14	\$1,257.94	89
	4	-20				<a href="#">PE88D4000</a>	\$4,217.06	\$4,048.38	\$3,879.70	\$3,711.01	90
	8	-15	<a href="#">PE88D4001</a>	\$1,479.93	\$1,391.13	\$1,317.14	\$1,257.94	91			
		<a href="#">PE88D8001</a>	\$1,560.67	\$1,467.03	\$1,389.00	\$1,326.57	92				
	10	-20	-1	+5 / 152	<a href="#">PE88D1000</a>	\$4,605.22	\$4,328.91	\$4,098.65	\$3,914.44	93	

# MIXERS

## Double Balanced



RF Range (GHz)	LO Range (GHz)	IF Range (GHz)	LO Power (dBm)	Conv. Loss (dB)	Connector	Model No	1 Pc. Price	See Web for Volume Pricing				ROW
0.5 MHz- 500 MHz	0.5 MHz- 500 MHz	DC - 500 MHz	10	6.8	SMA	<a href="#">PE86X1013</a>	\$340.79	See Web for Volume Pricing				94
1 MHz- 2.7	1 MHz- 2.7	1 MHz - 2	10	7	SMA	<a href="#">PE86X1020</a>	\$434.79					95
			17			<a href="#">PE86X1021</a>	\$532.71					96
5 MHz- 1	5 MHz- 1	DC - 1	7	7	SMA	<a href="#">PE86X1014</a>	\$340.79					97
			13			<a href="#">PE86X1016</a>	\$323.15					98
5 MHz- 1.5	5 MHz- 1.5	DC - 1	7	7.5	SMA	<a href="#">PE86X1018</a>	\$340.79					99
5 MHz- 3.5	5 MHz- 3.5	5 MHz - 2.5	13	8	SMA	<a href="#">PE86X1022</a>	\$393.73					1
5 MHz- 4.2	5 MHz- 4.2	5 MHz - 3.5	13	9.8	SMA	<a href="#">PE86X1023</a>	\$434.79					2
10 MHz- 1	10 MHz- 1	DC - 800 MHz	4	7.2	SMA	<a href="#">PE86X1015</a>	\$340.79					3
10 MHz- 1.2	10 MHz- 1.2	DC - 1.2	13	8	SMA	<a href="#">PE86X1017</a>	\$341.73					4
40 MHz- 2.5	40 MHz- 2.5	DC - 1	13	8	SMA	<a href="#">PE86X1019</a>	\$473.96					5
800 MHz- 4.2	800 MHz- 4.2	DC - 800 MHz	13	9	SMA	<a href="#">PE86X1024</a>	\$379.95					6
2 - 8	2 - 8	DC - 1.5	10	5.5	SMA	<a href="#">PE8650</a>	\$739.96					7
2 - 18	2 - 18	DC - 600 MHz	10	6.5	SMA	<a href="#">PE8652</a>	\$959.44					8
2.25 - 18	2.25 - 18	DC - 3	13	11	SMA	<a href="#">PE86X1026</a>	\$1,214.26					9
2.5 - 6	2.5 - 6	DC - 1.5	17	8.7	SMA	<a href="#">PE86X1025</a>	\$493.54					10
3 - 10	3 - 10	DC - 4	17	9	SMA	<a href="#">PE86X1027</a>	\$1,214.26					11
5 - 18	5 - 18	DC - 4	10	6.2	SMA	<a href="#">PE8653</a>	\$1,054.98					12
						<a href="#">PE86X1006</a>	\$1,481.05					13
5 - 20	5 - 20	DC - 3	20	10	SMA	<a href="#">PE86X1008</a>	\$1,477.42					14
						<a href="#">PE86X1007</a>	\$1,558.22					15
6 - 18	6 - 18	DC - 3	6	7.5	SMA	<a href="#">PE86X1007</a>	\$1,558.22					15
6 - 26	6 - 26	DC - 8	13	10	SMA	<a href="#">PE86X1028</a>	\$1,327.86					16
7 - 14	7 - 14	DC - 5	13		SMA	<a href="#">PE86X1003</a>	\$4,857.06					17
7 - 34	7 - 34	DC - 8	13	11	2.92mm	<a href="#">PE86X1029</a>	\$1,404.00					18
7 - 43	7 - 43	DC - 10	13	9	2.92mm	<a href="#">PE86X1009</a>	\$3,047.20					19
11 - 20	11 - 20	DC - 6	13		2.92mm	<a href="#">PE86X1004</a>	\$3,018.58	20				
16 - 30	16 - 30	DC - 8	13	9	2.92mm	<a href="#">PE86X1030</a>	\$1,480.60	21				
16 - 32	16 - 32	DC - 8	13		2.92mm	<a href="#">PE86X1000</a>	\$3,591.05	22				
23 - 37	23 - 37	DC - 13	13	9	2.92mm	<a href="#">PE86X1002</a>	\$4,435.60	23				
24 - 32	24 - 32	DC - 8	13	10.5	2.92mm	<a href="#">PE86X1031</a>	\$1,425.02	24				
24 - 38	24 - 38	DC - 8	13	9	2.92mm	<a href="#">PE86X1001</a>	\$4,836.61	25				
24 - 40	24 - 40	DC - 18	13	8	2.92mm	<a href="#">PE86X1010</a>	\$2,842.67	26				

## IQ



RF Range (GHz)	LO Range (GHz)	IF Range (GHz)	LO Power (dBm)	Conv. Loss (dB)	Connector	Model No	1	2-4	5-9	10+	ROW
4 - 8.5	4 - 8.5	DC - 3.5	15		SMA	<a href="#">PE86X9000</a>	\$3,287.88	\$3,172.80	\$3,057.73	\$2,959.09	27

See Our Website For Current Pricing & Real-Time Stock Availability!

Frequency Conversion Components



Technical Support  
+1 (949) 261-1920



Same-Day Shipping,  
Even Custom Cable Assemblies

**IQ**



RF Range (GHz)	LO Range (GHz)	IF Range (GHz)	LO Power (dBm)	Conv. Loss (dB)	Connector	Model No	1	2-4	5-9	10+	ROW
6 - 10	6 - 10	DC - 3.5	19	7.5	SMA	<a href="#">PE86X9001</a>	\$3,287.88	\$3,156.36	\$3,024.85	\$2,893.33	28
8.5 - 13.5	8.5 - 13.5	DC - 2	19	8	SMA	<a href="#">PE86X9002</a>	\$3,609.10	\$3,464.74	\$3,320.37	\$3,176.01	29
11 - 16	11 - 16	DC - 3.5	19	9	SMA	<a href="#">PE86X9003</a>	\$3,944.71	\$3,786.92	\$3,629.13	\$3,471.34	30
15 - 23	15 - 23	DC - 3.5	17	8	SMA	<a href="#">PE86X9004</a>	\$4,276.76	\$4,105.69	\$3,934.62	\$3,763.55	31
20 - 31	20 - 31	DC - 4.5	17	10	2.92mm	<a href="#">PE86X9005</a>	\$5,433.85	\$5,216.50	\$4,999.14	\$4,781.79	32
30 - 38	30 - 38	DC - 3.5	17	10.5	2.92mm	<a href="#">PE86X9006</a>	\$5,467.07	\$5,248.39	\$5,029.70	\$4,811.02	33

**Triple Balanced**



RF Range (GHz)	LO Range (GHz)	IF Range (GHz)	LO Power (dBm)	Conv. Loss (dB)	Connector	Model No	1 Pc. Price	See Web for Volume Pricing			ROW
2 - 18	2 - 18	1 - 6	13	8	SMA	<a href="#">PE86X1032</a>	\$2,195.96		See Web for Volume Pricing		34
6 - 18	6 - 18	1.5 - 8	10	7	SMA	<a href="#">PE8654</a>	\$1,054.98		See Web for Volume Pricing		35

**MODULATOR**

**BiPhase**



Freq. Band (GHz)	Insertion Loss (dB)	Switching Speed (nsec)	Phase State (On/Off)	VSWR	RF Input Power (CW) (dBm)	Max Peak RF Input Power (1usec) (dBm)	RF Conn.	Model No	1	2-4	5-9	10+	ROW
0.5 MHz to 1	1.5	50	0°/180°	1.5:1	+20	0.5	SMA Female	<a href="#">PE86GM2000</a>	\$3,677.54	\$3,548.83	\$3,420.11	\$3,309.79	36
1 to 2	3	30						<a href="#">PE86GM2001</a>	\$3,923.88	\$3,786.54	\$3,649.21	\$3,531.49	37
2 to 4	2.5	75						<a href="#">PE86GM2002</a>	\$4,170.22	\$4,024.26	\$3,878.30	\$3,753.20	38
2 to 6	1.7	50		1.6:1	+27			<a href="#">PE86GM2003</a>	\$4,416.56	\$4,261.98	\$4,107.40	\$3,974.90	39
4 to 8	2.5	30		2.0:1	+20			<a href="#">PE86GM2004</a>	\$4,662.91	\$4,499.71	\$4,336.51	\$4,196.62	40
6 to 12		15						<a href="#">PE86GM2005</a>	\$4,909.24	\$4,737.42	\$4,565.59	\$4,418.32	41
8 to 18	3	75		1.9:1	+20			<a href="#">PE86GM2006</a>	\$5,155.59	\$4,975.14	\$4,794.70	\$4,640.03	42
2 to 18	3.5	35						<a href="#">PE86GM2007</a>	\$6,140.96	\$5,926.03	\$5,711.09	\$5,526.86	43
26.5 to 40	5.5	50		2.0:1				2.92mm Female	<a href="#">PE86GM2008</a>	\$7,372.66	\$7,114.62	\$6,856.57	\$6,635.39

# FREQUENCY MULTIPLIERS

## Active



Type	Input Freq. (GHz)	Output Freq. (GHz)	CW Input Power (dBm)	Fund. Iso. Typ (dB)	Conversion Gain (dB)	DC Voltage	Female In/Out Conn.	Model No	1	2-4	5-9	10+	R O W
Triplers	250 MHz - 350 MHz	750 MHz - 1.05	-3	40	7	12	SMA	<a href="#">PE88X2015</a>	\$695.18	\$667.37	\$639.57	\$611.76	45
	320 MHz - 450 MHz	960 MHz - 1.35	-3	30	6			<a href="#">PE88X2016</a>	\$695.18	\$667.37	\$639.57	\$611.76	46
	450 MHz - 600 MHz	1.35 - 1.8	-3	35	9			<a href="#">PE88X2017</a>	\$695.18	\$667.37	\$639.57	\$611.76	47
	600 MHz - 750 MHz	1.8 - 2.25	-3	30	4			<a href="#">PE88X2018</a>	\$695.18	\$667.37	\$639.57	\$611.76	48
	700 MHz - 1000 MHz	2.1 - 3	0	25	12			<a href="#">PE88X2019</a>	\$695.18	\$667.37	\$639.57	\$611.76	49
	950 MHz - 1.5	2.85 - 4.5	0	20	9			<a href="#">PE88X2020</a>	\$695.18	\$667.37	\$639.57	\$611.76	50
Doublers	4 - 10.5	8 - 21	6		8	5	SMA	<a href="#">PE88X2003*</a>	\$5,110.83	\$4,906.40	\$4,701.96	\$4,497.53	51
	9 - 14.5	18 - 29	3	20	13		2.92mm	<a href="#">PE88X2000*</a>	\$4,919.16	\$4,722.39	\$4,525.63	\$4,328.86	52
	12 - 16.5	24 - 33	3	20	14		<a href="#">PE88X2001*</a>	\$4,837.09	\$4,643.61	\$4,450.12	\$4,256.64	53	
	16 - 23	32 - 46	3	20	10		<a href="#">PE88X2002*</a>	\$5,397.13	\$5,181.24	\$4,965.36	\$4,749.47	54	

\*Field Replaceable Connectors

## Passive Doublers



Input Freq. (GHz)	Output Freq. (GHz)	Input Drive Power (dBm)	Conversion Loss (dB)	Fund. Iso. Typ (dB)	Female In/Out Conn.	Model No	1 Pc. Price	See Web for Volume Pricing			R O W
10 MHz - 1000 MHz	20 MHz - 2	12	12	35	SMA	<a href="#">PE88X2010</a>	\$519.58	See Web for Volume Pricing			55
900 MHz - 1.8	1.8 - 4	12	14			<a href="#">PE88X2011</a>	\$519.58				56
1.25 - 3	2.5 - 6		15	25		<a href="#">PE88X2012</a>	\$519.58				57
1.5 - 5	3 - 10	13	8.5	25		<a href="#">PE8600</a>	\$746.50				58
2 - 4	4 - 8	12	14	25		<a href="#">PE88X2013</a>	\$519.58				59
2 - 6	4 - 12	13	11	25		<a href="#">PE8601</a>	\$785.69				60
4 - 8	8 - 16	12	17	25		<a href="#">PE88X2014</a>	\$519.58				61
4 - 9	8 - 18	13	10	25		<a href="#">PE8602</a>	\$795.01				62
9 - 13	18 - 26					<a href="#">PE8603</a>	\$795.09				63

\*Field Replaceable Connectors

See Our Website For Current Pricing & Real-Time Stock Availability!

Frequency Conversion Components



Technical Support  
+1 (949) 261-1920



Same-Day Shipping,  
Even Custom Cable Assemblies



## LIMITERS

### High Rel



Frequency Range (GHz.)	Insertion Loss Max. (dB)	Input VSWR Typ.	Leakage Power Max. (dBm)	Recovery Time Typ. (ns)	Input Power (CW) Max. (W)	Peak Power Max. (W)	Limiting Threshold Typ. (dBm)	Model No	1	2-4	5-9	10+	ROW
20 MHz - 4	0.8	1.8:1	13	15,000	2	100	10	<a href="#">PE80L2003</a>	\$1,321.87	\$1,269.00	\$1,216.12	\$1,163.25	64
500 MHz - 18	1.5	1.5:1	10	10	1		14	<a href="#">PE80L1000</a>	\$4,267.93	\$4,097.21	\$3,926.50	\$3,755.78	65
	2	1.8:1	18	15,000	5		<a href="#">PE80L2005</a>	\$1,836.11	\$1,762.67	\$1,689.22	\$1,615.78	66	
2 - 8	1	2:1	13	40	200	6	<a href="#">PE80L1001</a>	\$5,067.97	\$4,865.25	\$4,662.53	\$4,459.81	67	
2 - 18	2	2:1	14	100			1	<a href="#">PE80L2001</a>	\$4,985.71	\$4,786.28	\$4,586.85	\$4,387.42	68
	2.5	2:1		15,000			5	100	<a href="#">PE80L2006</a>	\$1,611.99	\$1,547.51	\$1,483.03	\$1,418.55
6 - 18	2.5		15	12	10	<a href="#">PE80L3000</a>	\$4,910.33	\$4,713.92	\$4,517.50	\$4,321.09	70		
8 - 12	1.2	1.8:1	18	15,000	3	100	15	<a href="#">PE80L2004</a>	\$1,521.54	\$1,460.68	\$1,399.82	\$1,338.96	72
12 - 18	1.5	1.5:1	10	10	1		<a href="#">PE80L4000</a>	\$5,271.43	\$5,060.57	\$4,849.72	\$4,638.86	73	
18 - 40	4	2.1:1	12	10	1	20	5	<a href="#">PE80L2002</a>	\$5,328.34	\$5,115.21	\$4,902.07	\$4,688.94	74
	4.5	3:1	13	15,000			<a href="#">PE80L2007</a>	\$2,232.27	\$2,142.98	\$2,053.69	\$1,964.40	75	
26.5 - 40	3	2:1			15,000		100	6	<a href="#">PE80L2008</a>	\$1,899.19	\$1,823.22	\$1,747.25	\$1,671.29

### PIN-PIN



Frequency Range (GHz.)	Limiting Threshold Typ. (dBm)	Leakage @1W CW Input Max. (dBm)	Insertion Loss Max. (dBm)	Input VSWR Typ.	In Power (CW) Max. (W)	In Peak Power Max. (W)	Model No	1 Pc. Price	See Web for Volume Pricing	ROW
500 MHz - 1	12	20	0.4	1.4:1	1	100	<a href="#">PE8017</a>	\$508.43	See Web for Volume Pricing	77
500 MHz - 2		19	0.5	1.4:1			<a href="#">PE8018</a>	\$531.83		78
1 - 2	9	19	0.2	1.2:1			<a href="#">PE8019</a>	\$561.02		79
2 - 4	12	19	0.8	1.5:1			<a href="#">PE8020</a>	\$495.84		80
2 - 8	9	16	1.2	1.6:1			<a href="#">PE8021</a>	\$636.93		81
2 - 18	12	18	2.5	2.2:1			<a href="#">PE8022</a>	\$642.23		82
4 - 8	9	16	1	1.3:1			<a href="#">PE8023</a>	\$594.70		83
6 - 18	12	16	2.2	2:1			<a href="#">PE8024</a>	\$619.55		84
7 - 12		16	1.8	1.8:1			<a href="#">PE8025</a>	\$591.50		85
8 - 16		16	2	2:1			<a href="#">PE8026</a>	\$563.33		86
11 - 18		9		16			2:1	<a href="#">PE8027</a>		\$676.04

### PIN-Schottky



Frequency Range (GHz.)	Limiting Threshold Typ. (dBm)	Leakage @1W CW Input Max. (dBm)	Insertion Loss Max. (dBm)	Input VSWR Typ.	In Power (CW) Max. (W)	In Peak Power Max. (W)	Model No	1 Pc. Price	See Web for Volume Pricing	ROW
500 MHz - 1	12	14	0.5	1.4:1	1	100	<a href="#">PE8028</a>	\$489.35	See Web for Volume Pricing	88
500 MHz - 2	9	14	0.4	1.25:1		200	<a href="#">PE8029</a>	\$540.84		89
1 - 2	4	14	0.6	1.4:1		100	<a href="#">PE8030</a>	\$663.84		90
2 - 4		14	0.8	1.5:1		200	<a href="#">PE8031</a>	\$623.43		91
2 - 8	9	14	1.2	1.4:1			<a href="#">PE8032</a>	\$565.55		92
2 - 18	4	18	2.5	2.2:1		100	<a href="#">PE8033</a>	\$630.33		93
4 - 8		13	1.4	1.5:1			<a href="#">PE8034</a>	\$646.51		94
6 - 18		13	2.5	2.2:1			<a href="#">PE8035</a>	\$343.64		95
7 - 12		16	1.6	1.6:1			<a href="#">PE8036</a>	\$625.36		96
8 - 16	9	12	2	1.5:1		200	<a href="#">PE8037</a>	\$779.28		97

## DETECTORS

### Biased Detectors

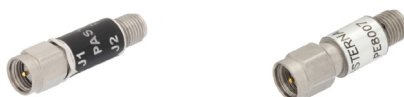

Frequency Range (GHz.)	Polarity	Voltage Sensitivity (mV/mW)	Flatness (dB)	Input Power (dBm)	TSS (dBm)	Model No	1 Pc. Price	See Web for Volume Pricing		ROW
500 MHz - 1	Negative	1,800	0.25	23	-54	<a href="#">PE8001</a>	\$681.57	See Web for Volume Pricing		1
	Positive		0.5			<a href="#">PE8001-P</a>	\$672.29			2
1 - 2	Negative	2,000	0.25			<a href="#">PE8002</a>	\$516.04			3
	Positive		<a href="#">PE8002-P</a>			\$846.07	4			
2 - 4	Negative	2,000	0.5			<a href="#">PE8003</a>	\$812.18			5
	Positive					<a href="#">PE8003-P</a>	\$752.06			6
4 - 8	Negative	2,000	0.5			<a href="#">PE8004</a>	\$582.66			7
	Positive					<a href="#">PE8004-P</a>	\$577.25			8
6 - 18	Negative	1,600	0.8			<a href="#">PE8005</a>	\$724.44			9
	Positive		<a href="#">PE8005-P</a>			\$634.97	10			
8 - 12	Negative	1,800	0.5			<a href="#">PE8006</a>	\$786.60			11
	Positive		<a href="#">PE8006-P</a>			\$751.03	12			
8 - 16	Negative	1,800	0.6			<a href="#">PE8007</a>	\$549.06			13
	Positive					<a href="#">PE8007-P</a>	\$714.72			14
8 - 18	Negative	1,600	0.7			<a href="#">PE8008</a>	\$663.84			15
	Positive					<a href="#">PE8008-P</a>	\$666.72			16
18 - 26	Negative	1,500	1			<a href="#">PE8009</a>	\$625.96			17
	Positive					<a href="#">PE8009-P</a>	\$806.78			18

### Finline Detectors



Frequency Range (GHz.)	Output Polarity	Input Power (dBm)	Video Output Typ. (V)	Voltage Sensitivity (mV/mW)	Model No	1	2-4	5-9	10+	ROW
100 MHz - 12.4		27		800	<a href="#">PE80T1004</a>	\$1,135.19	\$1,089.78	\$1,044.37	\$998.97	19
100 MHz - 18					<a href="#">PE80T1005</a>	\$1,348.82	\$1,294.87	\$1,240.91	\$1,186.96	20

### Log Detectors



Frequency Range (GHz.)	Imp. (Ohm)	Slope (mV/dB)	Input Power Max. (dBm)	Output Voltage Max. (dB)	Slew Rate (V/us)	Model No	1-4	5-9	10-24	25+	ROW
10 MHz - 3	50	40	10	2	1	<a href="#">PE8040</a>	\$585.03	\$555.78	\$526.53	\$503.13	21

### Phase Detectors



Frequency Range (GHz.)	Input Power Max. (dBm)	VSWR Max.	DC Voltage	Model No	1	2-4	5-9	10+	ROW
3 MHz - 300 MHz	17	17	15	<a href="#">PE80T4000</a>	\$1,389.43	\$1,333.85	\$1,278.28	\$1,222.70	22
5 MHz - 25 MHz				<a href="#">PE80T4002</a>	\$1,161.10	\$1,114.66	\$1,068.21	\$1,021.77	23
200 MHz - 800 MHz	10	10		<a href="#">PE80T4001</a>	\$1,542.78	\$1,481.07	\$1,419.36	\$1,357.65	24



Technical Support  
+1 (949) 261-1920



Same-Day Shipping,  
Even Custom  
Cable Assemblies

## Power Detectors

Frequency Range (GHz.)	Dynamic Range (dB)	True RMS Output Voltage Typ (V)	Output Slope	VSWR	Max RF Input Power (dBm)	RF Connectors	Model No	1	2-4	5-9	10+	ROW
30 MHz - 4	80	0.62 - 1.89	Positive	1.5:1	20	SMA Female	<a href="#">PE80P1001</a>	\$760.01	\$714.41	\$676.41	\$646.01	25
50 MHz - 3	60	0.12 - 2.1		1.3:1	10		<a href="#">PE80P1002</a>	\$712.13	\$669.40	\$633.80	\$605.31	26
50 MHz - 5	30	0.15 - 4.95		1.4:1	15		<a href="#">PE80P1000</a>	\$712.13	\$669.40	\$633.80	\$605.31	27

## Schottky Zero Bias Detectors

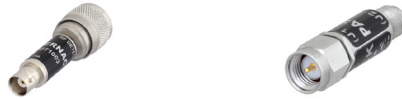

Frequency Range (GHz.)	Imp. (Ohm)	Polarity	Voltage Sensitivity (mV/mW)	VSWR Max	Video Capacitance (pF)	Signal Level & Level Min Input (dBm)	Model No	1 Pc. Price	See Web for Volume Pricing			ROW
10 MHz - 2	50	Negative	500	1.2:1	470	-30	<a href="#">PE8010</a>	\$652.27	See Web for Volume Pricing			28
10 MHz - 12.4		Positive		1.6:1			<a href="#">PE8012</a>	\$569.22				29
10 MHz - 18		Negative		1.7:1			<a href="#">PE8012P</a>	\$586.73				30
10 MHz - 18.5			450	<a href="#">PE80T1003</a>	\$905.61		31					
10 MHz - 26.5			100	<a href="#">PE8013</a>	\$691.55		32					
2 - 4		500	1.45:1	20	<a href="#">PE8014</a>		\$754.28	33				
2 - 8	1.5:1	<a href="#">PE8015</a>	\$654.87	34								
				<a href="#">PE8016</a>	\$663.84	35						

## Threshold Detectors



Frequency Range (GHz.)	Imp. (Ohm)	Signal Level & Input Level Min. (dBm)	Input Power Max. (dBm)	Propagation Delay Typ. (ns)	DC Voltage	Model No	1	2-4	5-9	10+	ROW
2 - 18	50	-20	10	15	15	<a href="#">PE80T1000</a>	\$4,626.32	\$4,441.27	\$4,256.21	\$4,071.16	36
		-45		20	12	<a href="#">PE80T1001</a>	\$7,560.21	\$7,257.80	\$6,955.39	\$6,652.98	37
16 - 40		-20	17		15	<a href="#">PE80T1002</a>	\$5,897.15	\$5,661.26	\$5,425.38	\$5,189.49	38

## Tunnel Diode Zero Bias Detectors



Frequency Range (GHz.)	Output Polarity	VSWR Max	Pulse Video Response Risetime Typ. (ns)	Voltage Sensitivity Typ. (mV/mW)	Flatness Max. (dB)	Input Power Max. (dBm)	Video Capacitance Typ. (pF)	Model No	1 Pc. Price	See Web for Volume Pricing			ROW								
100 MHz - 2	Negative	2:1	5	800	0.75	17	470	<a href="#">PE80T6000</a>	\$508.16	See Web for Volume Pricing			39								
	Positive							<a href="#">PE80T6001</a>	\$508.16					40							
100 MHz - 4	Negative	2.2:1						17	17						17	100	<a href="#">PE80T6002</a>	\$530.40	41		
	Positive																<a href="#">PE80T6003</a>	\$530.40		42	
500 MHz - 1	Negative	2:1						1,000	0.5						17	100	<a href="#">PE80T6010</a>	\$398.67			43
Positive	<a href="#">PE80T6011</a>																\$398.67	44			
500 MHz - 18	Negative	3.5:1	400	1	17	100	<a href="#">PE80T6004</a>	\$1,227.98	45												
	Positive						<a href="#">PE80T6005</a>	\$1,227.98		46											
1 - 2	Negative	2:1	1,000	0.5	17	50	<a href="#">PE80T6012</a>	\$495.74			47										
	Positive						<a href="#">PE80T6013</a>	\$495.74				48									
2 - 4	Negative						17	17					17	20	20	<a href="#">PE80T6014</a>	\$517.24		49		
	Positive															<a href="#">PE80T6015</a>	\$509.60	50			

See Our Website For Current Pricing & Real-Time Stock Availability!

Limiters & Detectors

## Tunnel Diode Zero Bias Detectors

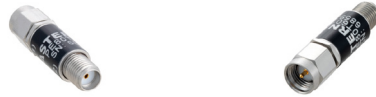

Frequency Range (GHz.)	Output Polarity	VSWR Max	Pulse Video Response Risettime Typ. (ns)	Voltage Sensitivity Typ. (mV/mW)	Flatness Max. (dB)	Input Power Max. (dBm)	Video Capacitance Typ. (pF)	Model No	1-4	5-9	10-24	25+	ROW				
2 - 6	Negative	2.5:1	5	1,000	0.5	17	20	<a href="#">PE80T6016</a>	\$527.79	\$501.40	\$475.01	\$453.90	51				
	Positive							<a href="#">PE80T6017</a>	\$527.79	\$501.40	\$475.01	\$453.90	52				
2 - 18	Negative	3.5:1						500	1	17	10	<a href="#">PE80T6006</a>	\$743.52	\$706.34	\$669.17	\$639.43	53
	Positive											<a href="#">PE80T6007</a>	\$742.14	\$705.03	\$667.93	\$638.24	54
4 - 8	Negative	2.5:1						900	0.7	17	5	<a href="#">PE80T6018</a>	\$559.35	\$531.38	\$503.42	\$481.04	55
	Positive											<a href="#">PE80T6019</a>	\$559.35	\$531.38	\$503.42	\$481.04	56
6 - 12	Negative	2.7:1		800	0.6	17	10	<a href="#">PE80T6020</a>	\$613.60	\$582.92	\$552.24	\$527.70	57				
	Positive							<a href="#">PE80T6021</a>	\$647.08	\$614.73	\$582.37	\$556.49	58				
6 - 18	Negative	3:1		700	0.75	17	5	<a href="#">PE80T6008</a>	\$682.94	\$648.79	\$614.65	\$587.33	59				
	Positive							<a href="#">PE80T6009</a>	\$720.20	\$684.19	\$648.18	\$619.37	60				
12 - 18	Negative	3:1		700	0.7	17	5	<a href="#">PE80T6022</a>	\$721.31	\$685.24	\$649.18	\$620.33	61				
	Positive							<a href="#">PE80T6023</a>	\$749.44	\$711.97	\$674.50	\$644.52	62				
18 - 26	Negative	4:1	400	1	17	5	<a href="#">PE80T6024</a>	\$837.42	\$795.55	\$753.68	\$720.18	63					
	Positive						<a href="#">PE80T6025</a>	\$837.42	\$795.55	\$753.68	\$720.18	64					

## NOISE SOURCES



Frequency Range (MHz.)	Design	Noise Output (ENR dB)	Connector	Model No	1	2-4	5-9	10+	ROW	
0.01 - 2,000	Calibrated	30	SMA Female	<a href="#">PE85N1001</a>	\$2,750.14	\$2,640.13	\$2,530.13	\$2,420.12	65	
		15		<a href="#">PE85N1019</a>	\$2,613.61	\$2,509.07	\$2,404.52	\$2,299.98	66	
		30		<a href="#">PE85N1020</a>	\$2,646.91	\$2,541.03	\$2,435.16	\$2,329.28	67	
		15		<a href="#">PE85N1000</a>	\$2,711.12	\$2,602.68	\$2,494.23	\$2,385.79	68	
0.1 - 500	Calibrated, Amplified	31	SMT Pin Packaged	<a href="#">PE85N1010</a>	\$3,635.69	\$3,490.26	\$3,344.83	\$3,199.41	69	
0.2 - 500	<a href="#">PE85NS4000</a>			\$189.22	\$181.65	\$174.08	\$166.51	70		
0.2 - 2,000	SMT Pin Packaged			<a href="#">PE85NS4001</a>	\$207.41	\$199.11	\$190.82	\$182.52	71	
0.2 - 3,000	<a href="#">PE85NS4003</a>			\$298.39	\$286.45	\$274.52	\$262.58	72		
1 - 2,000	Calibrated, Amplified, Bench Top	51	SMA Female	<a href="#">PE85NS4002</a>	\$225.61	\$216.59	\$207.56	\$198.54	73	
	Calibrated, Amplified			<a href="#">PE85NS4004</a>	\$371.16	\$356.31	\$341.47	\$326.62	74	
	10 - 2,000			Calibrated, Amplified, Bench Top	<a href="#">PE85N1017</a>	\$17,905.13	\$17,188.92	\$16,472.72	\$15,756.51	75
	10 - 2,000			Calibrated, Amplified	<a href="#">PE85N1011</a>	\$3,549.82	\$3,407.83	\$3,265.83	\$3,123.84	76
10 - 3,000	DIP Packaged	30	SMA Female	<a href="#">PE85NS5000</a>	\$1,146.21	\$1,100.36	\$1,054.51	\$1,008.66	77	
	Calibrated, Amplified			<a href="#">PE85NS5002</a>	\$1,218.99	\$1,170.23	\$1,121.47	\$1,072.71	78	
	Calibrated, Amplified, Bench Top			<a href="#">PE85N1012</a>	\$4,166.66	\$3,999.99	\$3,833.33	\$3,666.66	79	
	DIP Packaged			<a href="#">PE85N1018</a>	\$19,605.61	\$18,821.39	\$18,037.16	\$17,252.94	80	
10 - 6,000	Calibrated	15	SMA Female	<a href="#">PE85NS5001</a>	\$1,510.09	\$1,449.69	\$1,389.28	\$1,328.88	81	
				<a href="#">PE85NS5003</a>	\$1,582.86	\$1,519.55	\$1,456.23	\$1,392.92	82	
				<a href="#">PE85N1002</a>	\$3,276.77	\$3,145.70	\$3,014.63	\$2,883.56	83	
				<a href="#">PE85N1003</a>	\$3,706.26	\$3,558.01	\$3,409.76	\$3,261.51	84	
10 - 18,000	Calibrated, Amplified	26	SMA Female	<a href="#">PE85N1021</a>	\$3,276.77	\$3,145.70	\$3,014.63	\$2,883.56	85	
				<a href="#">PE85N1013</a>	\$5,357.19	\$5,142.90	\$4,928.61	\$4,714.33	86	
				<a href="#">PE85N1006</a>	\$4,076.45	\$3,913.39	\$3,750.33	\$3,587.28	87	
				<a href="#">PE85N1007</a>	\$5,636.36	\$5,410.91	\$5,185.45	\$4,960.00	88	
100 - 40,000	Calibrated	10	SMA Male	<a href="#">PE85N1008</a>	\$9,011.08	\$8,650.64	\$8,290.19	\$7,929.75	89	
100 - 60,000		7	3.5mm Male	<a href="#">PE85N1009</a>	\$18,865.41	\$18,110.79	\$17,356.18	\$16,601.56	90	
1,000 - 2,000		30	2.92mm Male	<a href="#">PE8505</a>	\$1,502.65	\$1,442.54	\$1,382.44	\$1,322.33	91	
1,000 - 18,000		15	1.85mm Male	<a href="#">PE85N1022</a>	\$3,736.47	\$3,587.01	\$3,437.55	\$3,288.09	92	
2,000 - 4,000	Calibrated	23	SMA Female	<a href="#">PE85N1004</a>	\$3,940.31	\$3,782.70	\$3,625.09	\$3,467.47	93	
				<a href="#">PE85N1005</a>	\$4,095.95	\$3,932.11	\$3,768.27	\$3,604.44	94	
				<a href="#">PE8501</a>	\$1,847.68	\$1,773.77	\$1,699.87	\$1,625.96	95	
				<a href="#">PE8506</a>	\$1,901.79	\$1,825.72	\$1,749.65	\$1,673.58	96	
3,700 - 4,200	Calibrated, Integral Isolator	30	SMA Female	<a href="#">PE85N1014</a>	\$3,736.47	\$3,587.01	\$3,437.55	\$3,288.09	97	
4,000 - 8,000	Calibrated	30	SMA Male	<a href="#">PE8507</a>	\$1,851.08	\$1,777.04	\$1,702.99	\$1,628.95	98	





Frequency Range (MHz.)	Design	Noise Output (ENR dB)	Connector	Model No	1	2-4	5-9	10+	ROW
7,200 - 8,400	Calibrated, Integral Isolator	15.5	SMA Female	<a href="#">PE85N1015</a>	\$3,865.56	\$3,710.94	\$3,556.32	\$3,401.69	99
8,000 - 12,000	Calibrated		SMA Male	<a href="#">PE8503</a>	\$1,937.84	\$1,860.33	\$1,782.81	\$1,705.30	1
				<a href="#">PE8508</a>	\$2,145.32	\$2,059.51	\$1,973.69	\$1,887.88	2
10,700 - 12,700	Calibrated, Integral Isolator	15.5	SMA Female	<a href="#">PE85N1016</a>	\$4,383.44	\$4,208.10	\$4,032.76	\$3,857.43	3
12,000 - 18,000			SMA Male	<a href="#">PE8504</a>	\$2,269.45	\$2,178.67	\$2,087.89	\$1,997.12	4
				<a href="#">PE8509</a>	\$1,894.77	\$1,818.98	\$1,743.19	\$1,667.40	5
26,500 - 40,000	Calibrated		BNC Female	<a href="#">PEWNS2000</a>	\$10,916.25	\$10,479.60	\$10,042.95	\$9,606.30	6
33,000 - 50,000				<a href="#">PEWNS2001</a>	\$14,035.18	\$13,473.77	\$12,912.37	\$12,350.96	7
40,000 - 60,000				<a href="#">PEWNS2002</a>	\$17,154.12	\$16,467.96	\$15,781.79	\$15,095.63	8
50,000 - 75,000				<a href="#">PEWNS2003</a>	\$20,273.05	\$19,462.13	\$18,651.21	\$17,840.28	9

## PHASE SHIFTERS AND TRIMMERS

### Adjustable Phase Trimmers



Connector	Gender	Frequency Range (MHz.)	Deg. Phase Adjustment per GHz	Max. Insertion Loss (dB)	Model No	1-9	10-24	25-49	50+	ROW
SMA	Male	DC - 18,000	10	3.4	<a href="#">PE8203</a>	\$207.23	\$196.87	\$186.51	\$178.22	10

### 8 Bit Programmable Phase Shifter



Connector	Gender	Frequency Range (MHz.)	Deg. Phase Adjustment per GHz	Max. Insertion Loss (dB)	Model No	1	2-4	5-9	10+	ROW
2.92mm	Female	32,000 - 37,000			<a href="#">PE82P5003</a>	\$15,282.14	\$14,670.85	\$14,059.57	\$13,448.28	11
SMA	Female	500 - 2,000		13	<a href="#">PE82P5000</a>	\$9,343.03	\$8,969.31	\$8,595.59	\$8,221.87	12
		6,000 - 18,000		12	<a href="#">PE82P5002</a>	\$16,064.89	\$15,422.29	\$14,779.70	\$14,137.10	13

### Adjustable Phase Shifter



Connector	Gender	Frequency Range (MHz.)	Deg. Phase Adjustment per GHz	Max. Insertion Loss (dB)	Model No	1 Pc. Price	See Web for Volume Pricing			ROW
2.92mm	Female	18,000 - 40,000		2.5	<a href="#">PE82P1000</a>	\$3,056.00				14
SMA	Female	DC - 2,300		0.5	<a href="#">PE8243</a>	\$1,073.93	See Web for Volume Pricing			15
		DC - 4,300			<a href="#">PE8244</a>	\$1,165.94				16
		DC - 8,200		0.6	<a href="#">PE8245</a>	\$1,130.20				17
		DC - 12,700		0.7	<a href="#">PE8246</a>	\$1,266.36				18
		DC - 18,000		1	<a href="#">PE8247</a>	\$1,272.69				19
		18,000 - 26,500			<a href="#">PE8255</a>	\$1,746.88				20
				1.5	<a href="#">PE8253</a>	\$1,396.16			21	

### Analog Phase Shifter



Connector	Gender	Frequency Range (MHz.)	Deg. Phase Adjustment per GHz	Max. Insertion Loss (dB)	Model No	1	2-4	5-9	10+	ROW
SMA	Female	5,000 - 18,000	40	12	<a href="#">PE82P2000</a>	\$6,482.18	\$6,222.89	\$5,963.61	\$5,704.32	22
		6,000 - 15,000	120	10	<a href="#">PE82P2001</a>	\$5,991.26	\$5,751.61	\$5,511.96	\$5,272.31	23

### POWER DIVIDERS

#### 50 Ohm



Ports	Freq. Range (MHz.)	Connector	Gender	Maximum Power	Model No	1 Pc. Price	See Web for Volume Pricing			ROW
2 WAY	0-67,000	1.85mm	Female	0.5 Watt	<a href="#">PE20DV1057</a>	\$3,532.26	See Web for Volume Pricing			24
	350-6,000	SMA			<a href="#">PE20DV1053</a>	\$299.50				25
	2,000-18,000	N		<a href="#">PE20DV1049</a>	\$670.12	26				
		SMA		<a href="#">PE20DV1044</a>	\$359.40	27				
				<a href="#">PE20DV1045</a>	\$140.17	28				
4,000-8,000	1.85mm	<a href="#">PE20DV1073</a>		\$2,618.82	29					
10,000-65,000		<a href="#">PE20DV1050</a>		\$471.71	30					
4 WAY	375-6,000	N		<a href="#">PE20DV1051</a>	\$326.61	31				
	1,000-4,000	SMA		<a href="#">PE20DV1046</a>	\$209.66	32				
	2,000-4,000			<a href="#">PE20DV1047</a>	\$218.22	33				
	4,000-8,000		<a href="#">PE20DV1048</a>	\$479.20	34					
6,000-18,000	<a href="#">PE20DV1052</a>		\$627.29	35						
8 WAY	5-500	N								

#### Reactive



Ports	Freq. Range (MHz.)	Connector	Gender	Maximum Power	Model No	1 Pc. Price	See Web for Volume Pricing			ROW
2 WAY	2-500	BNC	Female	1 Watt	<a href="#">PE2000</a>	\$260.84	See Web for Volume Pricing			36
		N			<a href="#">PE2044</a>	\$566.29				37
		SMA			<a href="#">PE2070</a>	\$553.04				38
	10-1,000	N			<a href="#">PE2047</a>	\$560.44				39
		7/16 DIN		N	<a href="#">PE20DV1041</a>	\$211.44				40
	SMA				N	10 Watt				<a href="#">PE2032</a>
		30 Watt		<a href="#">PE20DV019</a>		\$131.73				42
		20 Watt		<a href="#">PE20DV009</a>		\$235.33				43
		10 Watt		<a href="#">PE20DV007</a>		\$129.03				44
		20 Watt		<a href="#">PE20DV008</a>		\$119.99				45
		30 Watt	<a href="#">PE20DV014</a>	\$131.73		46				
		20 Watt	<a href="#">PE20DV013</a>	\$235.33		47				
		20 Watt	<a href="#">PE20DV016</a>	\$131.73		48				
		30 Watt	<a href="#">PE20DV000</a>	\$290.13		49				
		2,000-8,000	N	20 Watt		<a href="#">PE20DV005</a>				\$409.43
	30 Watt	<a href="#">PE2028</a>		\$634.23	51					
	2,000-18,000	N	Male	10 Watt	<a href="#">PE2081</a>	\$425.26				52
	7,000-12,400				<a href="#">PE2036</a>	\$736.65				53
	8,000-12,400	2.92mm	Female	12 Watt	<a href="#">PE2078</a>	\$2,127.32				54
	10,000-40,000				<a href="#">PE2077</a>	\$1,886.44				55
10,000-50,000	2.4mm	Female	10 Watt	<a href="#">PE2079A</a>	\$2,340.31	56				
12,000-18,000				<a href="#">PE2037</a>	\$1,041.36	57				
3 WAY	376-2,200	N	500 Watt	<a href="#">PE20DV1040</a>	\$289.43	58				
				<a href="#">PE20DV017</a>	\$215.99	59				
	2,000-4,000	SMA	30 Watt	<a href="#">PE20DV001</a>	\$363.06	60				
2,000-8,000										

**Reactive**

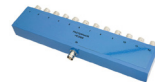

Ports	Freq. Range (MHz.)	Connector	Gender	Maximum Power	Model No	1 Pc. Price	See Web for Volume Pricing	R O W
4 WAY	2-500	BNC	Female	1 Watt	<a href="#">PE2001</a>	\$466.91	See Web for Volume Pricing	61
	10-1,000	N		10 Watt	<a href="#">PE2004</a>	\$744.17		62
	500-1,000	SMA		30 Watt	<a href="#">PE2038</a>	\$1,036.35		63
	500-2,000			20 Watt	<a href="#">PE20DV020</a>	\$209.35		64
	800-2,500	N		10 Watt	<a href="#">PE20DV010</a>	\$251.49		65
	1,000-2,000	SMA		30 Watt	<a href="#">PE20DV012</a>	\$149.39		66
	2,000-4,000	N		10 Watt	<a href="#">PE2039</a>	\$1,083.18		67
		N		30 Watt	<a href="#">PE20DV015</a>	\$209.35		68
	2,000-8,000	SMA		30 Watt	<a href="#">PE2040</a>	\$1,039.74		69
	2,000-18,000			30 Watt	<a href="#">PE20DV018</a>	\$201.50		70
2,000-18,000	30 Watt		<a href="#">PE20DV002</a>	\$368.68	71			
6 WAY	1-175	BNC	1 Watt	<a href="#">PE2006</a>	\$665.52	73		
	2,000-8,000	SMA	30 Watt	<a href="#">PE20DV003</a>	\$496.86	74		
8 WAY	500-2,000		30 Watt	<a href="#">PE20DV011</a>	\$310.67	75		
	2,000-8,000	30 Watt	<a href="#">PE20DV004</a>	\$683.98	76			
12 WAY	2-500	BNC	1 Watt	<a href="#">PE2005</a>	\$894.99	77		

**Resistive**



Ports	Freq. Range (MHz.)	Connector	Gender	Maximum Power	Model No	1 Pc. Price	See Web for Volume Pricing	R O W
2 WAY	0-6,000	SMA	Male	2 Watt	<a href="#">PE2082</a>	\$335.55	See Web for Volume Pricing	78
	0-12,400	2.92mm		1 Watt	<a href="#">PE2063</a>	\$514.26		79
		SMA		1 Watt	<a href="#">PE2067</a>	\$496.42		80
		2.92mm		1 Watt	<a href="#">PE2064</a>	\$595.90		81
	0-18,000	N		1 Watt	<a href="#">PE2066</a>	\$554.40		82
		SMA	Female	1 Watt	<a href="#">PE2084</a>	\$368.04		83
	0-26,500	2.92mm	Female	1 Watt	<a href="#">PE2068</a>	\$544.82		84
			Male	1 Watt	<a href="#">PE2083</a>	\$750.05		85
			Male	1 Watt	<a href="#">PE2065</a>	\$784.16		86
	0-50,000	2.4mm	Female	0.5 Watt	<a href="#">PE20DV1056</a>	\$2,020.46		87

**Wilkinson**



Ports	Freq. Range (MHz.)	Connector	Gender	Maximum Power	Model No	1 Pc. Price	See Web for Volume Pricing	R O W
2 WAY	10-1,000	BNC	Female	1 Watt	<a href="#">PE2003</a>	\$493.05	See Web for Volume Pricing	88
	500-1,000	SMA		10 Watt	<a href="#">PE2008</a>	\$411.17		89
	500-2,000			30 Watt	<a href="#">PE20S0022</a>	\$442.24		90
	617-2,700	4.1/9.5 Mini DIN		30 Watt	<a href="#">PE20DV1033A</a>	\$314.42		91
		N		30 Watt	<a href="#">PE20DV1032A</a>	\$276.40		92
	690-2,700	SMA		10 Watt	<a href="#">PE2092</a>	\$146.88		93
				10 Watt	<a href="#">PE2088</a>	\$125.42		94
	800-2,500	N		50 Watt	<a href="#">PE20S0025</a>	\$474.68		95
		SMA		10 Watt	<a href="#">PE2074</a>	\$298.34		96
	1,000-2,000	N		50 Watt	<a href="#">PE2033</a>	\$681.02		97
		SMA		10 Watt	<a href="#">PE2011</a>	\$377.65		98
	1,000-26,500	2.92mm		20 Watt	<a href="#">PE20DV1058</a>	\$1,009.68		99
	1,000-40,000			20 Watt	<a href="#">PE20DV1059</a>	\$1,620.34		1
	2,000-4,000	N		10 Watt	<a href="#">PE2034</a>	\$607.07		2
		SMA		10 Watt	<a href="#">PE2014</a>	\$317.40		3
	2,000-8,000	2.92mm		20 Watt	<a href="#">PE2026</a>	\$431.94		4
	2,000-40,000			20 Watt	<a href="#">PE20DV1060</a>	\$1,346.60		5

**Wilkinson**



Ports	Freq. Range (MHz.)	Connector	Gender	Maximum Power	Model No	1 Pc. Price	See Web for Volume Pricing		ROW		
2 WAY	4,000-8,000	N	Female	30 Watt	<a href="#">PE2035</a>	\$712.78	See Web for Volume Pricing		6		
		SMA	Male	10 Watt	<a href="#">PE2080</a>	\$436.56			7		
	6,000-40,000	2.92mm	SMA		20 Watt	<a href="#">PE20DV1061</a>			\$1,234.30	8	
					10 Watt	<a href="#">PE2020</a>			\$417.44	9	
	8,000-18,000	2.92mm	SMA		10 Watt	<a href="#">PE2027</a>			\$717.36	10	
					20 Watt	<a href="#">PE20DV1062</a>			\$1,121.98	11	
	12,000-18,000	SMA			10 Watt	<a href="#">PE2023</a>			\$456.66	12	
					20 Watt	<a href="#">PE20DV1063</a>			\$672.74	13	
	15,000-26,500	2.92mm			20 Watt	<a href="#">PE20DV1064</a>			\$1,187.97	14	
					20 Watt	<a href="#">PE20DV1065</a>			\$897.36	15	
3 WAY	690-2,700	N	Female	10 Watt	<a href="#">PE2093</a>	\$235.95	See Web for Volume Pricing		16		
		SMA			<a href="#">PE2090</a>	\$222.58			17		
	698-2,700	N			<a href="#">PE20DV1034A</a>	\$319.88			18		
4 WAY	800-2,500	SMA	Female	30 Watt	<a href="#">PE20S0019</a>	\$530.12	See Web for Volume Pricing		19		
	500-1,000				<a href="#">PE2009</a>	\$546.03			20		
	500-2,000	<a href="#">PE20S0024</a>		\$526.11	21						
	690-2,700	N		10 Watt	<a href="#">PE2094</a>	\$276.13			22		
		SMA			<a href="#">PE2089</a>	\$245.30			23		
	698-2,700	N		30 Watt	<a href="#">PE20DV1036A</a>	\$506.65			24		
	800-2,500	<a href="#">PE20S0020</a>			\$446.63	25					
	1,000-2,000	SMA			10 Watt	<a href="#">PE2012</a>			\$561.56	26	
	2,000-8,000				30 Watt	<a href="#">PE2031</a>			\$645.78	27	
	2,000-18,000				10 Watt	<a href="#">PE2029</a>			\$1,204.55	28	
	2,000-26,500				20 Watt	<a href="#">PE20DV1067</a>			\$1,121.98	29	
	4,000-8,000				N	10 Watt			<a href="#">PE2041</a>	\$931.64	30
	6,000-40,000				2.92mm	20 Watt			<a href="#">PE20DV1068</a>	\$1,458.92	31
	7,000-12,400	SMA		10 Watt	<a href="#">PE2021</a>	\$561.77			32		
18,000-40,000	2.92mm	20 Watt	<a href="#">PE20DV1069</a>	\$1,346.60	33						
8 WAY	500-2,000	SMA	Female	30 Watt	<a href="#">PE20S0023</a>	\$613.59	See Web for Volume Pricing		34		
	690-2,700	N			<a href="#">PE2095</a>	\$453.58			35		
		SMA		<a href="#">PE2091</a>	\$310.74	36					
	698-2,700	4.1/9.5 Mini DIN		10 Watt	<a href="#">PE20DV1039A</a>	\$869.29			37		
		N			<a href="#">PE20DV1038A</a>	\$741.18			38		
800-2,500	SMA	30 Watt	<a href="#">PE20S0021</a>	\$701.98	39						

**75 Ohm**

**Reactive**

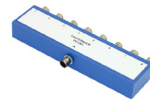

Ports	Freq. Range (MHz.)	Connector	Gender	Maximum Power	Model No	1 Pc. Price	See Web for Volume Pricing		ROW
2 WAY	2-500	BNC	Female	1 Watt	<a href="#">PE2048</a>	\$528.95	See Web for Volume Pricing		40
	10-1,000				<a href="#">PE2062</a>	\$261.60			41
4 WAY	<a href="#">PE2049</a>				\$474.62	42			
8 WAY	2-500				<a href="#">PE2061</a>	\$783.79			43

See Our Website For Current Pricing & Real-Time Stock Availability!

Power Dividers & RF Combiners



Technical Support  
+1 (949) 261-1920



Same-Day Shipping,  
Even Custom Cable Assemblies



## RF COMBINERS

### Broadband



See Our Website For Current Pricing & Real-Time Stock Availability!

Frequency Range (GHz)	Ports	Connector 1	Connector 2	Power Rating	Isolation (dB)	Model No	1 Pc. Price	See Web for Volume Pricing	ROW
20 MHz - 1	2	N Female	N Female	500 W	10	<a href="#">PE20S0004</a>	\$2,539.19	See Web for Volume Pricing	44
		SMA Female	SMA Female	100 W	15	<a href="#">PE20S0001</a>	\$1,272.16		45
80 MHz - 1	4	N Female	N Female	300 W	12	<a href="#">PE20S0003</a>	\$2,643.43		46
		SMA Female	SMA Female	200 W		<a href="#">PE20S0002</a>	\$1,786.72		47
500 MHz - 2.5	2	N Female	N Female	500 W	-12	<a href="#">PE20S0006</a>	\$2,653.59		48
		SMA Female	SMA Female	200 W		<a href="#">PE20S0005</a>	\$1,786.72		49
800 MHz - 2.5	2	N Female	N Female	600 W	13	<a href="#">PE20S0007</a>	\$1,837.63		50
		SMA Female	SC Female	800 W	8	<a href="#">PE20S0011</a>	\$2,388.24		51
800 MHz - 4.2	4	N Female	N Female	800 W	10	<a href="#">PE20S0010</a>	\$2,459.00		52
800 MHz - 2.5		SMA Female	N Female	200 W	6	<a href="#">PE20S0012</a>	\$2,420.41		53
800 MHz - 4.2	4	N Female	N Female	600 W	6	<a href="#">PE20S0009</a>	\$2,564.17		54
800 MHz - 2.5		SMA Female	N Female	200 W	8	<a href="#">PE20S0013</a>	\$2,379.01		55
1 - 6	2	SMA Female	SMA Female	200 W	12	<a href="#">PE20S0008</a>	\$2,103.00		56
		SMA Female	SMA Female	100 W	6	<a href="#">PE20S0014</a>	\$1,992.08		57
2 - 6	4	N Female	N Female	100 W	12	<a href="#">PE20S0015</a>	\$844.54		58
		SMA Female	SMA Female	400 W	10	<a href="#">PE20S0017</a>	\$2,667.62		59
						<a href="#">PE20S0016</a>	\$1,085.59	60	

## ROTARY JOINTS



Rotary Joints

Connector A	Connector B	Max. Frequency (MHz.)	Input Power	VSWR	Model No	1-9	10-24	25-49	50+	ROW
SMA	PCB	DC - 6,000	30 WATT	1.15:1	<a href="#">PE1401</a>	\$158.08	\$150.18	\$142.27	\$135.95	61
2.92mm	2.92mm	DC - 18,000		1.4:1	<a href="#">PE1400</a>	\$189.70	\$180.22	\$170.73	\$163.14	62
SMA	SMA			<a href="#">PE1402</a>	\$174.44	\$167.46	\$162.23	\$158.74	63	
					<a href="#">PE1406</a>	\$285.01	Call	Call	Call	64

## SURGE PROTECTORS

### In-Line Surge Protectors



Surge Protectors

Impedance	Connector	Gender	Frequency Range (MHz.)	Mount Type	Maximum Power	Model No	1 Pc. Price	See Web for Volume Pricing	ROW
50 Ohm	4.3-10	Female to Female	698 - 2,700	Bulkhead	500 Watt	<a href="#">PE73SP1051</a>	\$158.39	See Web for Volume Pricing	65
		Female to Male				<a href="#">PE73SP1061</a>	\$190.49		66
		Male to Female	555 - 4,000	Bulkhead	200 Watt	<a href="#">PE73SP1062</a>	\$193.35		67
			698 - 2,700			<a href="#">PE73SP1070</a>	\$136.54		68
50 Ohm	7/16 DIN	Female to Female	100 - 512	None	750 Watt	<a href="#">PE73SP1037</a>	\$175.97		69
			698 - 2,700	Bulkhead	1000 Watt	<a href="#">PE73SP1004</a>	\$154.59		70
		Female to Male	800 - 2,250	Bulkhead	500 Watt	<a href="#">PE73SP1063</a>	\$117.74		71
			698 - 2,160			<a href="#">PE73SP1008</a>	\$163.84		72
			698 - 2,700			<a href="#">PE73SP1005</a>	\$154.59		73
			500 Watt			<a href="#">PE73SP1006</a>	\$153.98		74
		Male to Female	100 - 512	None	750 Watt	<a href="#">PE73SP1034</a>	\$173.37	75	
			800 - 2,250	Watt	<a href="#">PE73SP1064</a>	\$117.74	76		
			800 - 2,500	None	300 Watt	<a href="#">PE73SP1017</a>	\$157.71	77	
			DC - 2,400	Bulkhead	50 Watt	<a href="#">PE73SP1040</a>	\$87.52	78	
DC - 2,500	<a href="#">PE7301-4</a>	\$197.11	79						
50 Ohm	N	Female to Female						80	
									81

## In-Line Surge Protectors



Impedance	Connector	Gender	Frequency Range (MHz.)	Mount Type	Maximum Power	Model No	1 Pc. Price	See Web for Volume Pricing	ROW
50 Ohm	N	Female to Female	DC - 3,000	Bulkhead	200 Watt	<a href="#">PE7301-3</a>	\$189.69	See Web for Volume Pricing	82
				None	40 Watt	<a href="#">PE73SP1039</a>	\$68.03		83
			DC - 7,000	None	200 Watt	<a href="#">PE7301-1</a>	\$175.88		84
					2000 Watt	<a href="#">PE7301-2</a>	\$182.89		85
			1.5 - 700	Bulkhead	90 Watt	<a href="#">PE73SP1038</a>	\$52.03		86
					500 Watt	<a href="#">PE73SP1027</a>	\$119.72		87
			10 - 1,000	None	3000 Watt	<a href="#">PE73SP1030</a>	\$89.16		88
					2000 Watt	<a href="#">PE73SP1025</a>	\$73.71		89
			40 - 400	Bulkhead	1500 Watt	<a href="#">PE73SP1024</a>	\$81.28		90
					100 Watt	<a href="#">PE73SP1015</a>	\$168.76		91
			100 - 512	None	750 Watt	<a href="#">PE73SP1018</a>	\$168.76		92
					750 Watt	<a href="#">PE73SP1033</a>	\$123.18		93
		125 - 1,000	Bulkhead	750 Watt	<a href="#">PE73SP1035</a>	\$123.18	94		
				500 Watt	<a href="#">PE73SP1022</a>	\$89.16	95		
		400 - 1,200	None	200 Watt	<a href="#">PE73SP1029</a>	\$119.72	96		
				375 Watt	<a href="#">PE73SP1021</a>	\$73.71	97		
		698 - 2,700	Bulkhead	300 Watt	<a href="#">PE73SP1019</a>	\$145.64	98		
		800 - 2,250	Bulkhead	500 Watt	<a href="#">PE73SP1000</a>	\$110.42	99		
		800 - 2,500	None	Watt	<a href="#">PE73SP1065</a>	\$100.70	1		
				300 Watt	<a href="#">PE73SP1010</a>	\$147.82	2		
		1,800 - 6,000	None	300 Watt	<a href="#">PE73SP1013</a>	\$147.82	3		
				10 Watt	<a href="#">PE73SP1014</a>	\$147.82	4		
		2,000 - 6,000	Bulkhead	10 Watt	<a href="#">PE73SP1050</a>	\$112.49	5		
		DC - 2,400	Bulkhead	50 Watt	<a href="#">PE73SP1048</a>	\$64.26	6		
90 Watt	<a href="#">PE73SP1042</a>			\$87.52	7				
DC - 7,000	Bulkhead	90 Watt	<a href="#">PE73SP1041</a>	\$52.03	8				
		500 Watt	<a href="#">PE73SP1001</a>	\$110.42	9				
698 - 2,700	Bulkhead	500 Watt	<a href="#">PE73SP1002</a>	\$122.04	10				
		500 Watt	<a href="#">PE73SP1003</a>	\$126.95	11				
2,000 - 6,000	Bulkhead	10 Watt	<a href="#">PE73SP1049</a>	\$64.26	12				
10 - 1,000	None	1500 Watt	<a href="#">PE73SP1028</a>	\$81.28	13				
100 - 512	None	750 Watt	<a href="#">PE73SP1036</a>	\$121.36	14				
		500 Watt	<a href="#">PE73SP1031</a>	\$89.16	15				
125 - 1,000	None	375 Watt	<a href="#">PE73SP1023</a>	\$73.71	16				
		Watt	<a href="#">PE73SP1066</a>	\$100.70	17				
800 - 2,250	None	300 Watt	<a href="#">PE73SP1011</a>	\$147.82	18				
800 - 2,500	None	300 Watt	<a href="#">PE73SP1068</a>	\$46.53	19				
		200 Watt	<a href="#">PE73SP1067</a>	\$46.53	20				
DC - 5,800	Bulkhead	200 Watt	<a href="#">PE73SP1069</a>	\$46.53	21				
		300 Watt	<a href="#">PE73SP1016</a>	\$147.82	22				
800 - 2,500	None	300 Watt	<a href="#">PE73SP1032</a>	\$86.12	23				
		2000 Watt	<a href="#">PE73SP1026</a>	\$78.47	24				

## Surge Protector Replacement Cartridges



Cartridge For	Maximum Power	Model No	1-24	25-49	50-99	100+	ROW
PE7301	200 Watt	<a href="#">PE7301-200CART</a>	\$35.11	\$33.35	\$31.60	\$30.19	25
	2,000 Watt	<a href="#">PE7301-2000CART</a>	\$31.60	\$30.02	\$28.44	\$27.18	26
PE7139 & PE7140	1,500 Watt	<a href="#">PE7139-CART</a>	\$21.60	\$20.74	\$20.09	\$19.66	27

See Our Website For Current Pricing & Real-Time Stock Availability!

Surge Protectors



Technical Support  
+1 (949) 261-1920



Same-Day Shipping,  
Even Custom Cable Assemblies

# INDEX GUIDE TO SWITCHES

<b>SWITCHES.....</b>	<b>324</b>
<b>ELECTROMECHANICAL RELAY SWITCHES.....</b>	<b>324</b>
1M Life Cycles.....	324
2M Life Cycles.....	326
2.5M Life Cycles.....	328
5M Life Cycles.....	328
10M Life Cycles.....	329
Special Applications.....	330
<b>GaN HIGH POWER SWITCHES.....</b>	<b>335</b>
<b>HIGH ISOLATION SWITCHES.....</b>	<b>335</b>
<b>HIGH ISOLATION USB SWITCHES.....</b>	<b>335</b>
<b>MANUAL SWITCHES.....</b>	<b>331</b>
<b>PIN DIODE SWITCHES.....</b>	<b>331</b>
SPST.....	331
SPDT.....	332
SP3T.....	333
SP4T.....	333
SP5T.....	334
SP6T.....	334
SP8T.....	334
SP12T.....	334
Transfer.....	334
<b>SMT PACKAGED ELECTROMECHANICAL SWITCHES.....</b>	<b>330</b>

## Electromechanical Relay Switches

### 1M Life Cycles



**Features:**  
A: Absorptive  
AR: Auto Reset  
F: Failsafe  
D: Diode  
GR: Global Reset  
H: Hot Switches  
I: Indicators  
L: Latching  
NO: Normally Open  
NT: Non-Terminated  
P: Pulse  
Latching  
R: Reflective  
RS: Reset  
S: Self Cut Off  
T: Terminated  
TTL: TTL Logic

Max Frequency (GHz)	Switch Type	Connector Type	Features	Min Isolation (dB)	Max IL (dB)	Voltage (V)	RF Power (W CW)	Model No	1 Pc. Price	See Web for Volume Pricing	R O W
8 GHz	SP6T	TNC Female	NO/Non-T	70	0.6	12	50	<a href="#">PE71S6206</a>	\$1,960.27	See Web for Volume Pricing	1
						28		<a href="#">PE71S6207</a>	\$1,960.27		2
10 GHz	SPDT	TNC Female	F/I, TTL, D, Non-T	60	0.6	12	50	<a href="#">PE71S6200</a>	\$1,176.16		3
								<a href="#">PE71S6201</a>	\$1,193.77		4
								<a href="#">PE71S6199</a>	\$1,486.77		5
								<a href="#">PE71S6184</a>	\$1,866.18		6
	SP4T	N Female	NO/I, TTL, D, Non-T			12	160	<a href="#">PE71S6185</a>	\$1,866.18		7
								<a href="#">PE71S6192</a>	\$2,146.22		8
						28	50	<a href="#">PE71S6183</a>	\$1,437.16		9
								<a href="#">PE71S6191</a>	\$1,869.95		10
	SP6T	N Female	NO/I, TTL, D, Non-T			12	160	<a href="#">PE71S6189</a>	\$2,053.24		11
								<a href="#">PE71S6196</a>	\$2,520.34		12
						28	160	<a href="#">PE71S6197</a>	\$2,657.85		13
								<a href="#">PE71S6186</a>	\$1,723.58		14
12				50	<a href="#">PE71S6187</a>	\$1,698.16	15				
					<a href="#">PE71S6194</a>	\$2,016.27	16				
12.4 GHz	SPDT	N Female	F/I, TTL, D, Non-T	60	0.6	12	160	<a href="#">PE71S6160</a>	\$1,397.44		17
								<a href="#">PE71S6161</a>	\$1,397.44		18
						28	200	<a href="#">PE71S6058</a>	\$904.23		19
			<a href="#">PE71S6059</a>		\$674.65			20			
			12		50			<a href="#">PE71S6150</a>	\$767.82		21
						160	<a href="#">PE71S6158</a>	\$1,063.14	22		

Switches

1M Life Cycles

See Our Website For Current Pricing & Real-Time Stock Availability!

Switches



**Features:**  
 A: Absorptive  
 AR: Auto Reset  
 F: Failsafe  
 D: Diode  
 GR: Global Reset  
 H: Hot Switches  
 I: Indicators  
 L: Latching  
 NO: Normally Open  
 NT: Non-Terminated  
 P: Pulse  
 Latching  
 R: Reflective  
 RS: Reset  
 S: Self Cut Off  
 T: Terminated  
 TTL: TTL Logic

Max Frequency (GHz)	Switch Type	Connector Type	Features	Min Isolation (dB)	Max IL (dB)	Voltage (V)	RF Power (W CW)	Model No	1 Pc. Price	See Web for Volume Pricing	Row		
12.4 GHz	SPDT	N Female	F/Non-T	60	0.6	28	160	<a href="#">PE71S6159</a>	\$1,063.14	See Web for Volume Pricing	23		
			L/I, TTL, D, S, Non-T		0.5	12	50	<a href="#">PE71S6156</a>	\$1,476.58		24		
			L/S, D, Non-T		0.6	28	160	<a href="#">PE71S6157</a>	\$1,400.19		25		
						12	160	<a href="#">PE71S6164</a>	\$1,653.76		26		
						28	50	<a href="#">PE71S6155</a>	\$1,213.13		27		
						12	160	<a href="#">PE71S6162</a>	\$1,466.43		28		
						28	160	<a href="#">PE71S6163</a>	\$1,411.39		29		
						12	50	<a href="#">PE71S6168</a>	\$1,697.03		30		
			Transfer		TNC Female	F/I, TTL, D, Non-T	0.4	28	160		<a href="#">PE71S6169</a>	\$1,791.99	31
								12	50		<a href="#">PE71S6177</a>	\$1,904.26	32
	12	160		<a href="#">PE71S6204</a>				\$1,643.27	33				
	28	50		<a href="#">PE71S6205</a>				\$1,822.58	34				
	28	50		<a href="#">PE71S6166</a>				\$1,372.19	35				
	N Female	F/Non-T		0.4	28	160	<a href="#">PE71S6167</a>	\$1,448.23	36				
						160	<a href="#">PE71S6175</a>	\$1,628.08	37				
						12	50	<a href="#">PE71S6202</a>	\$1,456.20		38		
						28	50	<a href="#">PE71S6203</a>	\$1,535.64		39		
						12	160	<a href="#">PE71S6172</a>	\$2,144.00		40		
	N Female	L/I, TTL, S, D, Non-T	0.4	12	160	<a href="#">PE71S6180</a>	\$2,392.86	41					
					28	160	<a href="#">PE71S6181</a>	\$2,303.04	42				
12					50	<a href="#">PE71S6170</a>	\$1,779.93	43					
28					50	<a href="#">PE71S6171</a>	\$1,877.03	44					
12					160	<a href="#">PE71S6178</a>	\$2,033.08	45					
28					160	<a href="#">PE71S6179</a>	\$2,113.54	46					
18 GHz	SPDT	SMA Female	F/Non-T	70	0.4	12	20	<a href="#">PE71S6326</a>	\$352.09	47			
22 GHz	SPDT	SMA Female	F/T	60	0.6	12	20	<a href="#">PE71S6293</a>	\$1,329.93	48			
			L/S, D, TTL, I, T					<a href="#">PE71S6300</a>	\$1,586.88	49			
			L/S, D, TTL, T					<a href="#">PE71S6298</a>	\$1,493.53	50			
			L/S, D, T					<a href="#">PE71S6306</a>	\$2,475.54	51			
	SP4T		NO/I, T					<a href="#">PE71S6302</a>	\$2,102.65	52			
								NO/I, TTL, D, T	<a href="#">PE71S6304</a>	\$2,649.03	53		
								NO/T	<a href="#">PE71S6301</a>	\$2,102.65	54		
								L/I, TTL, S, D, T	<a href="#">PE71S6315</a>	\$3,277.82	55		
	SP6T		L/S, D, T					28	<a href="#">PE71S6316</a>	\$3,277.82	56		
								12	<a href="#">PE71S6313</a>	\$2,968.40	57		
								28	<a href="#">PE71S6314</a>	\$2,968.40	58		
								12	<a href="#">PE71S6130</a>	\$1,685.30	59		
		28		<a href="#">PE71S6131</a>	\$1,575.03	60							
		12		<a href="#">PE71S6309</a>	\$2,475.49	61							
		28		<a href="#">PE71S6310</a>	\$2,418.24	62							
		NO/T		<a href="#">PE71S6098</a>	\$612.21	63							
26.5 GHz	SPDT	SMA Female	L/S, D, Non-T	50	0.5	12	20	<a href="#">PE71S6098</a>	\$612.21	63			
Transfer	F/Non-T	60	<a href="#">PE71S6110</a>	\$1,017.36				64					
40 GHz	SPDT	2.92mm Female	F/Non-T	50	0.8	28	10	<a href="#">PE71S6103</a>	\$2,280.34	65			
			L/I, TTL, S, D, Non-T	55				<a href="#">PE71S6109</a>	\$4,280.46	66			
			L/S, D, Non-T	50				0.9	12	5	<a href="#">PE71S6106</a>	\$3,367.71	67
	L/I, TTL, S, D, Non-T		<a href="#">PE71S6140</a>		\$7,546.95	68							
	L/I, TTL, S, D, T		1		28	3	<a href="#">PE71S6319</a>				\$8,557.95	69	
	L/S, D, RS, T			<a href="#">PE71S6320</a>			\$8,557.95	70					
								<a href="#">PE71S6318</a>	\$7,766.37	71			



**1M Life Cycles**



**Features:**  
 A: Absorptive  
 AR: Auto Reset  
 F: Failsafe  
 D: Diode  
 GR: Global Reset  
 H: Hot Switches  
 I: Indicators  
 L: Latching  
 NO: Normally Open  
 NT: Non-Terminated  
 P: Pulse  
 Latching  
 R: Reflective  
 RS: Reset  
 S: Self Cut Off  
 T: Terminated  
 TTL: TTL Logic

Max Frequency (GHz)	Switch Type	Connector Type	Features	Min Isolation (dB)	Max IL (dB)	Voltage (V)	RF Power (W CW)	Model No	1	2-4	5-9	10+	R O W
40 GHz	SP4T	2.92mm Female	L/S, D, T	50	1	12	3	<a href="#">PE71S6317</a>	\$7,766.37	\$7,455.72	\$7,145.06	\$6,834.41	72
			NO/I, TTL, D, Non-T					0.9	28	<a href="#">PE71S6137</a>	\$4,663.95	\$4,477.39	\$4,290.83
	SP6T		L/S, I, RS, T	60	12	<a href="#">PE71S6321</a>		\$8,613.96	\$8,269.40	\$7,924.84	\$7,580.28	74	
			L/S, TTL, I, RS, T		28	<a href="#">PE71S6322</a>		\$8,613.96	\$8,269.40	\$7,924.84	\$7,580.28	75	
			NO/Non-T	50	12	<a href="#">PE71S6323</a>		\$9,427.95	\$9,050.83	\$8,673.71	\$8,296.60	76	
					28	<a href="#">PE71S6324</a>		\$6,593.97	\$6,363.18	\$6,132.39	\$5,934.57	77	
			Transfer	50	L/S, D, Non-T	12		<a href="#">PE71S6122</a>	\$3,538.70	\$3,397.15	\$3,255.60	\$3,114.06	79
						28		<a href="#">PE71S6123</a>	\$3,405.87	\$3,269.64	\$3,133.40	\$2,997.17	80

**2M Life Cycles**

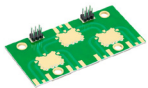

**Features:**  
 A: Absorptive  
 AR: Auto Reset  
 F: Failsafe  
 D: Diode  
 GR: Global Reset  
 H: Hot Switches  
 I: Indicators  
 L: Latching  
 NO: Normally Open  
 NT: Non-Terminated  
 P: Pulse  
 Latching  
 R: Reflective  
 RS: Reset  
 S: Self Cut Off  
 T: Terminated  
 TTL: TTL Logic

Max Frequency (GHz)	Switch Type	Connector Type	Features	Min Isolation (dB)	Max IL (dB)	Voltage (V)	RF Power (W CW)	Model No	1 Pc. Price	See Web for Volume Pricing	R O W		
3 GHz	SPDT	SMA Female	L/Non-T	30		12		<a href="#">PE71S8001</a>	\$507.85			81	
	SP4T							<a href="#">PE71S8002</a>	\$640.47			82	
10 GHz	SPDT	N Female	F	70	0.5	12	600	<a href="#">PE71S6426</a>	\$777.38	See Web for Volume Pricing	83		
12 GHz	SPDT	N Female	F	70	0.5	12	600	<a href="#">PE71S6435</a>	\$984.35		84		
			28			600	<a href="#">PE71S6438</a>	\$777.38	85				
			F/I, TTL, Non-T	12	1000	<a href="#">PE71S6460</a>	\$1,335.69	86					
				28	200	<a href="#">PE71S6348</a>	\$749.02	87					
			F/Non-T	60	0.7	12	1000	<a href="#">PE71S6397</a>	\$458.37		88		
						28	200	<a href="#">PE71S6398</a>	\$458.37		89		
	DPDT		N Female	F/I, TTL, Non-T	60	0.7	12	1000	<a href="#">PE71S6463</a>		\$2,049.68	90	
				F/Non-T					<a href="#">PE71S6462</a>		\$1,763.00	91	
	SP4T		N Female	NO	70	0.5	12	600	<a href="#">PE71S6434</a>		\$2,249.79	92	
				NO/I, Solder Pins, TTL, Non-T					28			<a href="#">PE71S6466</a>	\$3,225.00
NO/Solder Pins, Non-T		60		12					1000		<a href="#">PE71S6464</a>	\$2,773.50	94
NO/I, Solder Pins, TTL, Non-T											<a href="#">PE71S6465</a>	\$3,411.33	95
Transfer	N Female	F/Non-T	60	0.7	28	200	<a href="#">PE71S6385</a>	\$1,122.07	96				
		F/TTL, Non-T					<a href="#">PE71S6403</a>	\$821.38	97				
		F/TTL, Non-T					<a href="#">PE71S6386</a>	\$1,242.55	98				
12.4 GHz	SP6T	N Female	L/I, RS, Non-T	60	0.5	12	200	<a href="#">PE71S6072</a>	\$3,839.68	99			
	SP12T	SMA Female	L/S, AR, I, D, T			0.6	28	120	<a href="#">PE71S6073</a>	\$3,524.92	1		
18 GHz	SPDT	SMA Female	F	65	0.35	12	90	<a href="#">PE71S6429</a>	\$368.73	3			
			F/I, Non-T					<a href="#">PE71S6436</a>	\$272.07	4			
			F/Non-T					28	<a href="#">PE71S6351</a>	\$367.50	5		
								60	<a href="#">PE71S6347</a>	\$291.22	6		
			F/T	65	0.35	12	<a href="#">PE71S6391</a>	\$291.66	7				
						28	<a href="#">PE71S6392</a>	\$293.10	8				
						60	<a href="#">PE71S6060</a>	\$1,228.16	9				
						28	<a href="#">PE71S6354</a>	\$1,226.35	10				
							<a href="#">PE71S6355</a>	\$1,293.26	11				

2M Life Cycles



**Features:**  
 A: Absorptive  
 AR: Auto Reset  
 F: Failsafe  
 D: Diode  
 GR: Global Reset

H: Hot Switches  
 I: Indicators  
 L: Latching  
 NO: Normally Open  
 NT: Non-Terminated  
 P: Pulse  
 Latching  
 R: Reflective  
 RS: Reset  
 S: Self Cut Off  
 T: Terminated  
 TTL: TTL Logic

Max Frequency (GHz)	Switch Type	Connector Type	Features	Min Isolation (dB)	Max IL (dB)	Voltage (V)	RF Power (W CW)	Model No	1 Pc. Price	See Web for Volume Pricing	ROW
18 GHz	SPDT	SMA Female	F/T	65	0.35	28	60	<a href="#">PE71S6404</a>	\$1,168.18	See Web for Volume Pricing	12
			F/TTL, Non-T					<a href="#">PE71S6350</a>	\$445.83		13
			L/TTL, T	60	0.5	28	100	<a href="#">PE71S6063</a>	\$1,536.57		14
	NO/Non-T		<a href="#">PE71S6363</a>					\$1,230.00	15		
	SP4T		NO/Non-T	80	0.4	28	60	<a href="#">PE71S6408</a>	\$879.11		16
			NO/T					<a href="#">PE71S6368</a>	\$2,560.92		17
	SP6T		NO/Non-T					<a href="#">PE71S6369</a>	\$2,660.80		18
			NO/T					<a href="#">PE71S6373</a>	\$1,366.22		19
			NO/TTL, Non-T					<a href="#">PE71S6409</a>	\$1,118.08		20
			NO/T					<a href="#">PE71S6380</a>	\$3,069.67		21
	SP8T		L/I, RS, T	<a href="#">PE71S6381</a>	\$3,069.67	22					
			NO/TTL, Non-T	<a href="#">PE71S6374</a>	\$1,505.46	23					
	SP10T		L/I, RS, T	<a href="#">PE71S6375</a>	\$1,505.46	24					
			NO/Non-T	<a href="#">PE71S6080</a>	\$8,051.13	25					
	SP12T		L/I, RS, T	<a href="#">PE71S6384</a>	\$2,436.56	26					
			F	<a href="#">PE71S6076</a>	\$4,403.10	27					
Transfer	F	60	0.5	28	100	<a href="#">PE71S6083</a>	\$8,921.82	28			
						<a href="#">PE71S6433</a>	\$672.89	29			
	F/Non-T			<a href="#">PE71S6388</a>	\$858.30	30					
				<a href="#">PE71S6389</a>	\$823.93	31					
20 GHz	SP10T	SMA Female	NO/Non-T	70	0.7	28	60	<a href="#">PE71S6400</a>	\$721.37	32	
								<a href="#">PE71S6410</a>	\$3,219.77	33	
26.5 GHz	SPDT	SMA Female	F	50	0.6	28	90	<a href="#">PE71S6419</a>	\$529.84	34	
								<a href="#">PE71S6420</a>	\$454.40	35	
								<a href="#">PE71S6421</a>	\$452.55	36	
								<a href="#">PE71S6430</a>	\$452.55	37	
			F/I, TTL, T			<a href="#">PE71S6468</a>	\$1,467.38	38			
						<a href="#">PE71S6469</a>	\$1,327.63	39			
			F/T			50	<a href="#">PE71S6356</a>	\$1,329.76	40		
							<a href="#">PE71S6357</a>	\$1,310.14	41		
			F/TTL, T			28	<a href="#">PE71S6467</a>	\$1,164.23	42		
							<a href="#">PE71S6422</a>	\$609.37	43		
	DPDT		12	<a href="#">PE71S6437</a>	\$558.30	44					
				<a href="#">PE71S6446</a>	\$1,091.13	45					
	SP4T		F/I, TTL, Non-T	<a href="#">PE71S6447</a>	\$1,091.13	46					
				<a href="#">PE71S6472</a>	\$3,250.80	47					
			NO/Solder Pins, Non-T	<a href="#">PE71S6452</a>	\$1,505.00	48					
				<a href="#">PE71S6453</a>	\$1,580.25	49					
NO/T		70	0.7	28	50	<a href="#">PE71S6370</a>	\$3,003.87	50			
						<a href="#">PE71S6371</a>	\$2,891.11	51			
NO/TTL, T		12	<a href="#">PE71S6423</a>	\$1,679.88	52						
			<a href="#">PE71S6424</a>	\$1,569.96	53						
SP6T	F/TTL, T	70	0.6	28	90	<a href="#">PE71S6427</a>	\$2,691.48	54			
						<a href="#">PE71S6428</a>	\$1,870.52	55			
	L/S, RS, D, T			50	<a href="#">PE71S6079</a>	\$4,796.40	56				
					<a href="#">PE71S6454</a>	\$2,342.89	57				
26.5 GHz	SP6T	NO/I, Solder Pins, TTL, Non-T	NO/T	70	0.7	12	50	<a href="#">PE71S6455</a>	\$2,342.18	58	
								<a href="#">PE71S6382</a>	\$3,209.95	59	
40 GHz	SPDT	2.92mm Female	F/I, TTL, Non-T	60	0.7	12		<a href="#">PE71S6383</a>	\$3,209.95	60	
								<a href="#">PE71S6444</a>	\$1,379.58	61	

See Our Website For Current Pricing & Real-Time Stock Availability!

Switches



Technical Support  
 +1 (949) 261-1920



Same-Day Shipping,  
 Even Custom Cable Assemblies

### 2M Life Cycles



**Features:**  
 A: Absorptive  
 AR: Auto Reset  
 F: Failsafe  
 D: Diode  
 GR: Global Reset  
 H: Hot Switches  
 I: Indicators  
 L: Latching  
 NO: Normally Open  
 NT: Non-Terminated  
 P: Pulse  
 Latching  
 R: Reflective  
 RS: Reset  
 S: Self Cut Off  
 T: Terminated  
 TTL: TTL Logic

Max Frequency (GHz)	Switch Type	Connector Type	Features	Min Isolation (dB)	Max IL (dB)	Voltage (V)	RF Power (W CW)	Model No	1 Pc. Price	See Web for Volume Pricing	ROW
40 GHz	SPDT	2.92mm Female	F/Non-T	60	0.7	12	10	<a href="#">PE71S6443</a>	\$1,222.82	See Web for Volume Pricing	62
			L/I, TTL, S, T		0.8	28		<a href="#">PE71S6064</a>	\$3,259.23		63
	DPDT		F/I, TTL, Non-T	50	1	12	5	<a href="#">PE71S6451</a>	\$3,655.00		64
			F/Non-T		28	<a href="#">PE71S6450</a>		\$3,296.68	65		
					12	<a href="#">PE71S6476</a>		\$2,688.93	66		
	SP4T		NO	0.6	90	<a href="#">PE71S6431</a>	\$3,380.00	67			
			NO/I, TTL, + COM, Non-T	1.1	28	<a href="#">PE71S6457</a>	\$5,210.16	68			
				1.3	12	<a href="#">PE71S6456</a>	\$4,429.00	69			
			SP6T	L/I, RS, T	50	1.1	28	<a href="#">PE71S6084</a>	\$5,342.71		70
	L/S, RS, D, Non-T			<a href="#">PE71S6078</a>				\$3,248.60	71		
NO/+ COM, Non-T	60	<a href="#">PE71S6459</a>		\$6,443.31	72						
NO/I, TTL, Non-T	50	1.3		12	<a href="#">PE71S6458</a>	\$4,740.75	73				
Transfer	F	0.6	90	<a href="#">PE71S6432</a>	\$2,629.30	74					
		0.3	28	80	<a href="#">PE71S6329</a>	\$1,973.09	75				
50 GHz	SPDT	2.4mm Female	L/Non-T	60	1.1	28	80	<a href="#">PE71S6330</a>	\$1,576.98	76	

### 2.5M Life Cycles



**Features:**  
 A: Absorptive  
 AR: Auto Reset  
 F: Failsafe  
 D: Diode  
 GR: Global Reset  
 H: Hot Switches  
 I: Indicators  
 L: Latching  
 NO: Normally Open  
 NT: Non-Terminated  
 P: Pulse  
 Latching  
 R: Reflective  
 RS: Reset  
 S: Self Cut Off  
 T: Terminated  
 TTL: TTL Logic

Max Frequency (GHz)	Switch Type	Connector Type	Features	Min Isolation (dB)	Max IL (dB)	Voltage (V)	RF Power (W CW)	Model No	1 Pc. Price	See Web for Volume Pricing	ROW
12.4 GHz	Transfer	N Female	F/I, Non-T	60	0.5	28	200	<a href="#">PE71S6070</a>	\$1,086.30	See Web for Volume Pricing	77
18 GHz	Transfer	SMA Female	F/Non-T	60	0.5	28	100	<a href="#">PE71S6065</a>	\$958.75		78
			L/I, Non-T			12		<a href="#">PE71S6066</a>	\$1,039.88		79
			L/I, S, Non-T			28		<a href="#">PE71S6069</a>	\$1,466.36		80
			L/I, TTL, S, Non-T					<a href="#">PE71S6067</a>	\$1,184.55		81
			<a href="#">PE71S6068</a>					\$1,356.89	82		
40 GHz	Transfer	2.92mm Female	L/I, S, Non-T	50	0.8	28	10	<a href="#">PE71S6071</a>	\$2,002.01	83	

### 5M Life Cycles



**Features:**  
 A: Absorptive  
 AR: Auto Reset  
 F: Failsafe  
 D: Diode  
 GR: Global Reset  
 H: Hot Switches  
 I: Indicators  
 L: Latching  
 NO: Normally Open  
 NT: Non-Terminated  
 P: Pulse  
 Latching  
 R: Reflective  
 RS: Reset  
 S: Self Cut Off  
 T: Terminated  
 TTL: TTL Logic

Max Frequency (GHz)	Switch Type	Connector Type	Features	Min Isolation (dB)	Max IL (dB)	Voltage (V)	RF Power (W CW)	Model No	1 Pc. Price	See Web for Volume Pricing	ROW
12 GHz	SPDT	N Female	L/I, Non-T	70	0.5	28	200	<a href="#">PE71S6399</a>	\$907.85	See Web for Volume Pricing	84
			L/Non-T			12		<a href="#">PE71S6349</a>	\$823.35		85
			L/TTL			600		<a href="#">PE71S6425</a>	\$1,210.12		86
	DPDT		L/I, S, TTL, Non-T	60	0.7	28	1000	<a href="#">PE71S6461</a>	\$1,990.77		87
			L/Non-T			12	200	<a href="#">PE71S6387</a>	\$1,106.87		88
						75	<a href="#">PE71S6390</a>	\$858.83	89		
Transfer	SMA Female	N Female	L/TTL	60	0.3	28	600	<a href="#">PE71S6439</a>	\$1,362.66	90	
			L/Non-T			12	60	<a href="#">PE71S6353</a>	\$358.17	91	
						28	60	<a href="#">PE71S6395</a>	\$478.19	92	
18 GHz	SPDT	SMA Female	L/I, Non-T	65	0.35	12	60	<a href="#">PE71S6396</a>	\$546.42	93	

5M Life Cycles



**Features:**  
 A: Absorptive  
 AR: Auto Reset  
 F: Failsafe  
 D: Diode  
 GR: Global Reset  
 H: Hot Switches  
 I: Indicators  
 L: Latching  
 NO: Normally Open  
 NT: Non-Terminated  
 P: Pulse  
 Latching  
 R: Reflective  
 RS: Reset  
 S: Self Cut Off  
 T: Terminated  
 TTL: TTL Logic

Max Frequency (GHz)	Switch Type	Connector Type	Features	Min Isolation (dB)	Max IL (dB)	Voltage (V)	RF Power (W CW)	Model No	1 Pc. Price	See Web for Volume Pricing				ROW	
18 GHz	SPDT	SMA Female	L/I, T	65	0.35	24	60	<a href="#">PE71S6406</a>	\$1,151.64	See Web for Volume Pricing				94	
			L/I, TTL, T					28	<a href="#">PE71S6407</a>					\$1,334.69	95
			L/Non-T					12	<a href="#">PE71S6352</a>					\$328.77	96
			L/S, I, Non-T					28	<a href="#">PE71S6393</a>					\$625.11	97
			L/T					12	<a href="#">PE71S6394</a>					\$458.42	98
			L/T					12	<a href="#">PE71S6358</a>					\$1,320.20	99
	SP3T		L/Non-T	80	0.4	28	<a href="#">PE71S6362</a>	\$2,026.01	1						
			DP3T	L/I, Non-T	65	0.35	<a href="#">PE71S6405</a>	\$1,528.10	2						
	SP4T		L/T	80	0.4	12	<a href="#">PE71S6364</a>	\$2,345.52	3						
			NO/Non-T	60	0.5	28	<a href="#">PE71S6365</a>	\$2,345.52	4						
	SP6T		L/I, S, AR, D, Non-T	60	0.5	28	<a href="#">PE71S6074</a>	\$1,981.13	5						
			L/Non-T	80	0.4	12	<a href="#">PE71S6077</a>	\$3,125.71	6						
			L/T	80	0.4	60	<a href="#">PE71S6372</a>	\$2,610.59	7						
			NO/Non-T	60	0.5	28	<a href="#">PE71S6376</a>	\$3,237.13	8						
Transfer	L/I, Non-T	60	0.5	28	<a href="#">PE71S6377</a>	\$3,069.67	9								
	L/S, I, Non-T	60	0.5	28	<a href="#">PE71S6075</a>	\$2,193.30	10								
	L/I, Non-T	60	0.5	28	<a href="#">PE71S6402</a>	\$779.15	11								
	L/S, I, Non-T	60	0.5	60	<a href="#">PE71S6401</a>	\$964.84	12								
26.5 GHz	SPDT	SMA Female	L/S, D, Non-T	50	0.6	28	50	<a href="#">PE71S6440</a>	\$658.44	See Web for Volume Pricing				14	
			L/S, I, TTL, Non-T					12	<a href="#">PE71S6441</a>					\$815.21	15
			L/S, I, TTL, T					28	<a href="#">PE71S6442</a>					\$856.00	16
			L/S, I, TTL, T					40	0.5					12	<a href="#">PE71S6471</a>
	DPDT		L/T	50	0.6	28	<a href="#">PE71S6470</a>	\$1,834.25	18						
			L/S, D, Non-T	60	0.8	12	<a href="#">PE71S6360</a>	\$1,337.43	19						
			L/S, I, TTL, Non-T	60	0.8	28	<a href="#">PE71S6361</a>	\$1,337.43	20						
			L/S, I, TTL, Solder Pins, T	12	<a href="#">PE71S6448</a>	\$1,316.88	21								
			L/T	70	0.7	28	<a href="#">PE71S6449</a>	\$1,514.43	22						
			L/T	70	0.7	28	<a href="#">PE71S6473</a>	\$3,896.16	23						
	SP4T		L/I, TTL, Solder Pins, T	12	<a href="#">PE71S6474</a>	\$3,896.27	24								
			L/T	12	<a href="#">PE71S6366</a>	\$2,791.49	25								
			L/I, TTL, Solder Pins, T	28	<a href="#">PE71S6367</a>	\$3,003.87	26								
			L/T	12	<a href="#">PE71S6475</a>	\$3,559.33	27								
SP6T	L/T	12	50	<a href="#">PE71S6378</a>	\$3,209.95	28									
	L/T	28	50	<a href="#">PE71S6379</a>	\$3,209.95	29									
	L/S, I, TTL, Non-T	60	0.7	12	<a href="#">PE71S6445</a>	\$1,552.06	30								
	L/S, I, TTL, RS, T 0.05	80	0.5	24	5	<a href="#">PE71S6334</a>	\$7,331.31	31							
40 GHz	SP4T	2.92mm Female	L/I, S, RS, T 0.05	80	0.5	24	5	<a href="#">PE71S6342</a>	\$7,771.24					32	
			L/I, S, TTL, RS, T 0.05					<a href="#">PE71S6332</a>	\$7,820.08					33	
	L/I, S, RS, T 0.05		<a href="#">PE71S6340</a>					\$8,195.19	34						

10M Life Cycles



**Features:**  
 A: Absorptive  
 AR: Auto Reset  
 F: Failsafe  
 D: Diode  
 GR: Global Reset  
 H: Hot Switches  
 I: Indicators  
 L: Latching  
 NO: Normally Open  
 NT: Non-Terminated  
 P: Pulse  
 Latching  
 R: Reflective  
 RS: Reset  
 S: Self Cut Off  
 T: Terminated  
 TTL: TTL Logic

Max Frequency (GHz)	Switch Type	Connector Type	Features	Min Isolation (dB)	Max IL (dB)	Voltage (V)	RF Power (W CW)	Model No	1	2-4	5-9	10+	ROW
6 GHz	SP6T	SMA Female	NO/Non-T	70	0.3	28	70	<a href="#">PE71S6085</a>	\$1,854.08	\$1,779.92	\$1,705.75	\$1,631.59	35

See Our Website For Current Pricing & Real-Time Stock Availability!

Switches



Technical Support  
 +1 (949) 261-1920



Same-Day Shipping,  
 Even Custom Cable Assemblies



### 10M Life Cycles



**Features:**  
 A: Absorptive  
 AR: Auto Reset  
 F: Failsafe  
 D: Diode  
 GR: Global Reset  
 H: Hot Switches  
 I: Indicators  
 L: Latching  
 NO: Normally Open  
 NT: Non-Terminated  
 P: Pulse  
 Latching Reflective  
 RS: Reset  
 S: Self Cut Off  
 T: Terminated  
 TTL: TTL Logic

Max Frequency (GHz)	Switch Type	Connector Type	Features	Min Isolation (dB)	Max IL (dB)	Voltage (V)	RF Power (W CW)	Model No	1 Pc. Price	See Web for Volume Pricing	ROW
18 GHz	SPDT	SMA Female	F/Non-T	60	0.35	28	100	<a href="#">PE71S6052</a>	\$369.29	See Web for Volume Pricing	36
								<a href="#">PE71S6053</a>	\$366.74		37
			L/I, S, Non-T					<a href="#">PE71S6054</a>	\$562.85		38
								<a href="#">PE71S6055</a>	\$503.81		39
20 GHz	SPDT	SMA Female	L/I, S, Non-T 0.03	65	0.5	24	1	<a href="#">PE71S6335</a>	\$1,561.01	See Web for Volume Pricing	40
								<a href="#">PE71S6337</a>	\$2,263.86		41
			L/I, S, TTL, Non-T 0.03					<a href="#">PE71S6336</a>	\$1,931.33		42
			L/I, S, TTL, T 0.03					<a href="#">PE71S6338</a>	\$2,516.05		43
	SP4T	SMA Female	L/I, S, RS, T 0.03	80	0.6	70		<a href="#">PE71S6333</a>	\$5,223.57		44
			L/I, S, TTL, RS, T 0.03					<a href="#">PE71S6341</a>	\$5,536.99		45
	SP6T	SMA Female	L/I, S, RS, T 0.03	80	0.6	70		<a href="#">PE71S6331</a>	\$5,803.95		46
			L/I, S, TTL, RS, T 0.03					<a href="#">PE71S6339</a>	\$6,152.18		47
26.5 GHz	SP6T	SMA Female	L/GR, Non-T	55	0.6	28	40	<a href="#">PE71S6087</a>	\$2,530.74	See Web for Volume Pricing	48
			NO/TTL, Non-T					<a href="#">PE71S6088</a>	\$2,624.22		49
40 GHz	SPDT	2.92mm Female	F/I, Non-T	50	0.8	28	10	<a href="#">PE71S6056</a>	\$1,343.77	See Web for Volume Pricing	50
			L/I, S, Non-T					<a href="#">PE71S6057</a>	\$995.66		51

### Special Applications



**Features:**  
 A: Absorptive  
 AR: Auto Reset  
 F: Failsafe  
 D: Diode  
 GR: Global Reset  
 H: Hot Switches  
 I: Indicators  
 L: Latching  
 NO: Normally Open  
 NT: Non-Terminated  
 P: Pulse  
 Latching Reflective  
 RS: Reset  
 S: Self Cut Off  
 T: Terminated  
 TTL: TTL Logic

Max Frequency (GHz)	Switch Type	Connector Type	Features	Min Isolation (dB)	Max IL (dB)	Voltage (V)	RF Power (W CW)	Model No	1 Pc. Price	See Web for Volume Pricing	ROW
1 GHz	A/B Coaxial	BNC Female		50	0.7	12	5	<a href="#">PE7100</a>	\$621.38	See Web for Volume Pricing	52
		N Female						<a href="#">PE7102</a>	\$476.47		53
	A/B Coaxial 75 Ohm	BNC Female						<a href="#">PE7103</a>	\$424.67		54
								<a href="#">PE7176</a>	\$824.33		55

### SMT Packaged Electromechanical Switches



**Features:**  
 A: Absorptive  
 AR: Auto Reset  
 F: Failsafe  
 D: Diode  
 GR: Global Reset  
 H: Hot Switches  
 I: Indicators  
 L: Latching  
 NO: Normally Open  
 NT: Non-Terminated  
 P: Pulse  
 Latching Reflective  
 RS: Reset  
 S: Self Cut Off  
 T: Terminated  
 TTL: TTL Logic

Max Frequency (GHz)	Switch Type	Connector Type	Features	Min Isolation (dB)	Max IL (dB)	Voltage (V)	RF Power (W CW)	Model No	1 Pc. Price	See Web for Volume Pricing	ROW	
8 GHz	SPDT	SMT	F/H, Non-T	30	0.8	24	35	<a href="#">PE71S6092</a>	\$318.01	See Web for Volume Pricing	56	
								5	<a href="#">PE71S6413</a>		\$326.22	57
									<a href="#">PE71S6414</a>		\$326.22	58
18 GHz	SPDT	SMT	L/H, Non-T	40	1	12	3	<a href="#">PE71S6415</a>	\$429.78	See Web for Volume Pricing	59	
									<a href="#">PE71S6416</a>		\$429.78	60
26.5 GHz	SPDT	SMT	L/H, Non-T	40	1.6	12	1	<a href="#">PE71S6418</a>	\$542.88	See Web for Volume Pricing	61	
									<a href="#">PE71S6417</a>		\$542.88	62

\*Available SMA Connectorized Application PWB Option. Model PE71S8001 PWB supports connectorized SPDT. Model PE71S8002 PWB supports Connectorized SP4T.

## Waveguide Electromechanical Relay Switches, See Page [377](#)

# MANUAL SWITCHES

## Manual Switches



Impedance	Connector	Gender	Number of Output Ports	Frequency Range (MHz.)	Maximum Power	Model No	1 Pc. Price	See Web for Volume Pricing		ROW
50 Ohm	N	Female to		DC - 1,300	500 Watt	<a href="#">PE7139</a>	\$261.10	See Web for Volume Pricing		63
						<a href="#">PE7140</a>	\$415.15			64
	SMA			DC - 22,000	50 Watt	<a href="#">PE7SM1000A</a>	\$897.36			65

## PIN Diode Switches

### SPST



Switch Design	Freq. (GHz.)	Typ Iso (dB)	Typ IL (dB)	Switch Time (ns)	Max Input Power (dB)	TTL Control	Conn. Type	Model No	1	2-4	5-9	10+	ROW	
Absorptive	10 MHz - 1	80	1.3	200	0.1	Solder Pin	SMA Female	<a href="#">PE71S6230</a>	\$1,830.96	\$1,757.72	\$1,684.48	\$1,611.24	66	
	50 MHz - 26.5	30	5	150	0.5			<a href="#">PE71S2008</a>	\$5,973.77	\$5,734.82	\$5,495.87	\$5,256.92	67	
	50 MHz - 40	25	7.5		1		2.92mm Female	<a href="#">PE71S2012</a>	\$6,347.90	\$6,093.98	\$5,840.07	\$5,586.15	68	
	50 MHz - 67		9.5	0.5	1.85mm Female		<a href="#">PE71S2024</a>	\$8,028.13	\$7,707.00	\$7,385.88	\$7,064.75	69		
	500 MHz - 18	55	3.5	100	0.1		SMA Female	<a href="#">PE71S6209</a>	\$2,996.48	\$2,876.62	\$2,756.76	\$2,636.90	70	
	500 MHz - 40		5.5				2.92mm Female	<a href="#">PE71S6214</a>	\$4,343.49	\$4,169.75	\$3,996.01	\$3,822.27	71	
	1 - 2	80	0.9	50	0.1		SMA Female	<a href="#">PE71S6231</a>	\$2,752.66	\$2,642.55	\$2,532.45	\$2,422.34	72	
	1 - 18	65	3					<a href="#">PE71S6236</a>	\$4,511.17	\$4,330.72	\$4,150.28	\$3,969.83	73	
	2 - 4	75	1.1	150	1		SMA Female	<a href="#">PE71S6232</a>	\$2,109.62	\$2,025.24	\$1,940.85	\$1,856.47	74	
	2 - 26.5	25	4.5					<a href="#">PE71S2016</a>	\$5,808.26	\$5,575.93	\$5,343.60	\$5,111.27	75	
	2 - 40	30	5	50	0.1		SMA Female	2.92mm Female	<a href="#">PE71S2020</a>	\$5,874.47	\$5,639.49	\$5,404.51	\$5,169.53	76
	4 - 8	75	1.8					<a href="#">PE71S6233</a>	\$2,801.33	\$2,689.28	\$2,577.22	\$2,465.17	77	
	8 - 12	70	1.8	50	0.1		SMA Female	<a href="#">PE71S6234</a>	\$2,539.71	\$2,438.12	\$2,336.53	\$2,234.94	78	
	12 - 18	65	2.8					<a href="#">PE71S6235</a>	\$2,618.48	\$2,513.74	\$2,409.00	\$2,304.26	79	
	Reflective	10 MHz - 1	80	1	200		0.1	Solder Pin	SMA Female	<a href="#">PE71S6258</a>	\$1,752.20	\$1,682.11	\$1,612.02	\$1,541.94
50 MHz - 26.5		20	5	150	1	<a href="#">PE71S2007</a>	\$5,152.69			\$4,946.58	\$4,740.47	\$4,534.37	81	
50 MHz - 40		25	6.5		0.5	2.92mm Female	<a href="#">PE71S2011</a>		\$5,525.71	\$5,304.68	\$5,083.65	\$4,862.62	82	
50 MHz - 67		20	8.5	0.5	1.85mm Female	<a href="#">PE71S2023</a>	\$6,815.00		\$6,542.40	\$6,269.80	\$5,997.20	83		
500 MHz - 18		55	3	100	0.1	SMA Female	<a href="#">PE71S6220</a>		\$2,766.78	\$2,656.11	\$2,545.44	\$2,434.77	84	
500 MHz - 40			5			2.92mm Female	<a href="#">PE71S6225</a>		\$3,229.77	\$3,100.58	\$2,971.39	\$2,842.20	85	
1 - 2		80	0.75	50	0.1	SMA Female	<a href="#">PE71S6259</a>		\$1,870.66	\$1,795.83	\$1,721.01	\$1,646.18	86	
1 - 18		65	2.5				<a href="#">PE71S6264</a>		\$2,760.23	\$2,649.82	\$2,539.41	\$2,429.00	87	
2 - 4		75	0.85	150	1	SMA Female	<a href="#">PE71S6260</a>		\$2,034.96	\$1,953.56	\$1,872.16	\$1,790.76	88	
2 - 26.5		20	4.5				<a href="#">PE71S2015</a>		\$4,849.72	\$4,655.73	\$4,461.74	\$4,267.75	89	
2 - 40		30	4	50	0.1	SMA Female	2.92mm Female		<a href="#">PE71S2019</a>	\$5,040.68	\$4,839.05	\$4,637.43	\$4,435.80	90
4 - 8		75	1.5				<a href="#">PE71S6261</a>		\$2,277.63	\$2,186.52	\$2,095.42	\$2,004.31	91	
8 - 12		70	1.8	50	0.1	SMA Female	<a href="#">PE71S6262</a>		\$2,333.65	\$2,240.30	\$2,146.96	\$2,053.61	92	
12 - 18		65	2.5				<a href="#">PE71S6263</a>		\$2,408.33	\$2,312.00	\$2,215.66	\$2,119.33	93	

See Our Website For Current Pricing & Real-Time Stock Availability!

Switches



Technical Support  
+1 (949) 261-1920



Same-Day Shipping,  
Even Custom  
Cable Assemblies

SPDT

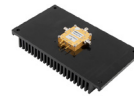

See Our Website For Current Pricing & Real-Time Stock Availability!

Switches

Switch Design	Freq. (GHz.)	Typ Iso (dB)	Typ IL (dB)	Switch Time (ns)	Max Input Power (dB)	TTL Control	Conn. Type	Model No	1	2-4	5-9	10+	ROW
Absorptive	5 MHz - 2.15	70	2.5	100,000	0.1	D-Sub	F Female	<a href="#">PE71S2043</a>	\$1,432.15	\$1,374.86	\$1,317.58	\$1,260.29	94
	5 MHz - 3	80	3.5	10,000	1			<a href="#">PE71S2036</a>	\$1,222.80	\$1,173.89	\$1,124.98	\$1,076.06	95
	10 MHz - 1		1.3	200	0.1	Solder Pin	SMA Female	<a href="#">PE71S6237</a>	\$2,130.20	\$2,044.99	\$1,959.78	\$1,874.58	96
	20 MHz - 4.3	3	10,000	1	D-Sub	<a href="#">PE71S2035</a>		\$1,222.80	\$1,173.89	\$1,124.98	\$1,076.06	97	
	70 MHz - 26.5	55	5	100	0.5	SMA Female	2.92mm Female	<a href="#">PE71S2010</a>	\$9,473.95	\$9,094.99	\$8,716.03	\$8,337.08	98
	70 MHz - 40		7					<a href="#">PE71S2014</a>	\$9,758.18	\$9,367.85	\$8,977.53	\$8,587.20	99
	100 MHz - 67	40	10.5					SMA Female	1.85mm Female	<a href="#">PE71S2050</a>	\$8,233.11	\$7,739.12	\$7,327.47
	500 MHz - 18	55	3.75	50	0.1	Solder Pin	SMA Female	<a href="#">PE71S6210</a>	\$3,405.96	\$3,269.72	\$3,133.48	\$2,997.24	2
	500 MHz - 40	60	6					<a href="#">PE71S6215</a>	\$5,897.28	\$5,661.39	\$5,425.50	\$5,189.61	3
	800 MHz - 2.7	75	0.8	10,000	100	0.1	SMA Female	<a href="#">PE71S2041</a>	\$3,837.67	\$3,684.16	\$3,530.66	\$3,377.15	4
	1 - 18	65	3.5	100	0.5			Pin	SMA Female	<a href="#">PE71S6241</a>	\$3,130.34	\$3,005.13	\$2,879.91
	2 - 4	75	1.2			<a href="#">PE71S6208</a>	\$2,441.30			\$2,343.65	\$2,246.00	\$2,148.34	6
	2 - 26.5	60	4	100	0.5	SMA Female	2.92mm Female	<a href="#">PE71S2018</a>	\$8,599.40	\$8,255.42	\$7,911.45	\$7,567.47	7
	2 - 40	55	5.5					<a href="#">PE71S2022</a>	\$8,961.20	\$8,602.75	\$8,244.30	\$7,885.86	8
	4 - 8	70	1.9	100	0.1	Solder Pin	SMA Female	<a href="#">PE71S6238</a>	\$2,910.54	\$2,794.12	\$2,677.70	\$2,561.28	9
	8 - 12		2.2					<a href="#">PE71S6239</a>	\$4,557.14	\$4,374.85	\$4,192.57	\$4,010.28	10
12 - 18	3.5		<a href="#">PE71S6240</a>					\$2,917.72	\$2,801.01	\$2,684.30	\$2,567.59	11	
Reflective	DC - 6	25	1.3	100	40	SMA Female	SMA Female	<a href="#">PE71S1100</a>	\$3,027.93	\$2,906.81	\$2,785.70	\$2,664.58	12
	DC - 12		2	150	25			<a href="#">PE71S1105</a>	\$3,190.80	\$3,063.17	\$2,935.54	\$2,807.90	13
	DC - 18	23	2.3	100	10	SMA Female	SMA Female	<a href="#">PE71S1101</a>	\$2,912.28	\$2,795.79	\$2,679.30	\$2,562.81	14
								<a href="#">PE71S1106</a>	\$3,075.16	\$2,952.15	\$2,829.15	\$2,706.14	15
								<a href="#">PE71S1102</a>	\$3,080.04	\$2,956.84	\$2,833.64	\$2,710.44	16
	10 MHz - 1	80	1.1	200	0.1	Solder Pin	SMA Female	<a href="#">PE71S1107</a>	\$3,242.93	\$3,113.21	\$2,983.50	\$2,853.78	17
	20 MHz - 500 MHz	50	0.5	40,000	150			<a href="#">PE71S6265</a>	\$1,945.35	\$1,867.54	\$1,789.72	\$1,711.91	18
	20 MHz - 1	40	0.75	10,000	25	Solder Pin	SMA Female	<a href="#">PE71S2039</a>	\$3,465.74	\$3,327.11	\$3,188.48	\$3,049.85	19
	20 MHz - 2.5	50	1					<a href="#">PE71S2040</a>	\$3,465.74	\$3,327.11	\$3,188.48	\$3,049.85	20
	30 MHz - 530 MHz	60	1	200	5	Solder Pin	SMA Female	<a href="#">PE71S2042</a>	\$3,113.43	\$2,988.89	\$2,864.36	\$2,739.82	21
	50 MHz - 1.5							4	<a href="#">PE71S2047</a>	\$791.20	Call	Call	Call
	70 MHz - 26.5	30	3.5	100	0.5	SMA Female	2.92mm Female	<a href="#">PE71S2048</a>	\$776.25	Call	Call	Call	23
	70 MHz - 40		5.5					<a href="#">PE71S2009</a>	\$7,280.98	\$6,989.74	\$6,698.50	\$6,407.26	24
	100 MHz - 500 MHz	55	0.5	40,000	250	Solder Pin	SMA Female	<a href="#">PE71S2013</a>	\$7,653.99	\$7,347.83	\$7,041.67	\$6,735.51	25
	500 MHz - 6	35	1.5	250	100	N Female	SMA Female	<a href="#">PE71S2038</a>	\$3,286.45	\$3,154.99	\$3,023.53	\$2,892.08	26
								<a href="#">PE71S1103</a>	\$3,583.33	\$3,440.00	\$3,296.66	\$3,153.33	27
	500 MHz - 18	55	3.2	100	0.1	Solder Pin	SMA Female	<a href="#">PE71S1108</a>	\$3,746.22	\$3,596.37	\$3,446.52	\$3,296.67	28
	500 MHz - 40		5.5	50				<a href="#">PE71S6221</a>	\$3,155.11	\$3,028.91	\$2,902.70	\$2,776.50	29
	1 - 18	65	2.5	100	1	Solder Pin	SMA Female	<a href="#">PE71S6226</a>	\$3,543.42	\$3,419.40	\$3,295.38	\$3,189.08	30
2 - 4	0.9		<a href="#">PE71S6269</a>					\$3,006.58	\$2,886.32	\$2,766.05	\$2,645.79	31	
2 - 26.5	30	3	100	0.5	SMA Female	2.92mm Female	<a href="#">PE71S6219</a>	\$2,240.30	\$2,150.69	\$2,061.08	\$1,971.46	32	
2 - 40		4					<a href="#">PE71S2017</a>	\$8,162.23	\$7,835.74	\$7,509.25	\$7,182.76	33	
4 - 8	70	1.6	100	0.1	Solder Pin	SMA Female	<a href="#">PE71S2021</a>	\$8,409.19	\$8,072.82	\$7,736.45	\$7,400.09	34	
8 - 12		1.9					<a href="#">PE71S6266</a>	\$2,520.34	\$2,419.53	\$2,318.71	\$2,217.90	35	
12 - 18		2.5					<a href="#">PE71S6267</a>	\$2,719.52	\$2,610.74	\$2,501.96	\$2,393.18	36	
							<a href="#">PE71S6268</a>	\$2,692.10	\$2,584.42	\$2,476.73	\$2,369.05	37	

SP3T



Switch Design	Freq. (GHz.)	Typ Iso (dB)	Typ IL (dB)	Switch Time (ns)	Max Input Power (dB)	TTL Control	Conn. Type	Model No	1	2-4	5-9	10+	ROW
Absorptive	10 MHz - 1	60	1.4	200	0.1	Solder Pin	SMA Female	<a href="#">PE71S6242</a>	\$2,296.31	\$2,204.46	\$2,112.61	\$2,020.75	38
	500 MHz - 18	55	3.8	100				<a href="#">PE71S6211</a>	\$4,210.43	\$4,042.01	\$3,873.60	\$3,705.18	39
	500 MHz - 40	60	6	50			2.92mm Female	<a href="#">PE71S6216</a>	\$6,031.13	\$5,789.88	\$5,548.64	\$5,307.39	40
	1 - 2		1.25					<a href="#">PE71S6243</a>	\$2,505.42	\$2,405.20	\$2,304.99	\$2,204.77	41
	1 - 18	65	3.75	100			SMA Female	<a href="#">PE71S6248</a>	\$3,278.12	\$3,147.00	\$3,015.87	\$2,884.75	42
	2 - 4	75	1.5					<a href="#">PE71S6244</a>	\$2,669.69	\$2,562.90	\$2,456.11	\$2,349.33	43
	4 - 8		2.5					<a href="#">PE71S6245</a>	\$3,035.84	\$2,914.41	\$2,792.97	\$2,671.54	44
	8 - 12	70	2.8					<a href="#">PE71S6246</a>	\$3,619.53	\$3,474.75	\$3,329.97	\$3,185.19	45
12 - 18	3.75		<a href="#">PE71S6247</a>		\$3,088.65	\$2,965.10		\$2,841.56	\$2,718.01	46			
Reflective	10 MHz - 1	60	1		200	0.1		Solder Pin	SMA Female	<a href="#">PE71S6270</a>	\$2,342.84	\$2,249.13	\$2,155.41
	500 MHz - 18	55	3.2	100	<a href="#">PE71S6222</a>		\$3,528.48			\$3,387.34	\$3,246.20	\$3,105.06	48
	500 MHz - 40		5.5	50	2.92mm Female		<a href="#">PE71S6227</a>		\$5,610.98	\$5,386.54	\$5,162.10	\$4,937.66	49
	1 - 2	60	1	SMA Female			<a href="#">PE71S6271</a>		\$2,430.73	\$2,333.50	\$2,236.27	\$2,139.04	50
	1 - 18	65	2.75		<a href="#">PE71S6276</a>		\$3,155.47		\$3,029.25	\$2,903.03	\$2,776.81	51	
	2 - 4	75	1.2		<a href="#">PE71S6272</a>		\$2,595.03		\$2,491.23	\$2,387.43	\$2,283.63	52	
	4 - 8		2		<a href="#">PE71S6273</a>		\$2,804.11		\$2,691.95	\$2,579.78	\$2,467.62	53	
	8 - 12	70	2.4		<a href="#">PE71S6274</a>		\$3,830.08		\$3,676.88	\$3,523.67	\$3,370.47	54	
	12 - 18		2.75		<a href="#">PE71S6275</a>		\$2,968.40		\$2,849.66	\$2,730.93	\$2,612.19	55	

SP4T



Switch Design	Freq. (GHz.)	Typ Iso (dB)	Typ IL (dB)	Switch Time (ns)	Max Input Power (dB)	TTL Control	Conn. Type	Model No	1	2-4	5-9	10+	ROW	
Absorptive	5 MHz - 2.15	70	2.5	100,000	0.1	D-Sub	F Female	<a href="#">PE71S2044</a>	\$1,959.79	\$1,881.40	\$1,803.01	\$1,724.62	56	
	5 MHz - 3		3.5	10,000	1		SMA Female	<a href="#">PE71S2037</a>	\$1,702.13	\$1,634.04	\$1,565.96	\$1,497.87	57	
	10 MHz - 1	60	1.5	200	SMA Female		<a href="#">PE71S6249</a>	\$2,580.08	\$2,476.88	\$2,373.67	\$2,270.47	58		
	500 MHz - 18	55	3.8	100			<a href="#">PE71S6212</a>	\$5,453.13	\$5,235.00	\$5,016.88	\$4,798.75	59		
	500 MHz - 40		60	8	50		2.92mm Female	<a href="#">PE71S6217</a>	\$8,940.43	\$8,582.81	\$8,225.20	\$7,867.58	60	
	1 - 2	70	1.2	100	SMA Female			<a href="#">PE71S6250</a>	\$2,823.35	\$2,710.42	\$2,597.48	\$2,484.55	61	
	1 - 18		3.75				<a href="#">PE71S6255</a>	\$3,566.16	\$3,423.51	\$3,280.87	\$3,138.22	62		
	2 - 4		1.5				<a href="#">PE71S6251</a>	\$2,953.48	\$2,835.34	\$2,717.20	\$2,599.06	63		
	4 - 8		2.2				<a href="#">PE71S6252</a>	\$3,155.11	\$3,028.91	\$2,902.70	\$2,776.50	64		
	8 - 12		2.6				<a href="#">PE71S6253</a>	\$3,929.08	\$3,771.92	\$3,614.75	\$3,457.59	65		
12 - 18	3.75		<a href="#">PE71S6254</a>			\$3,326.85	\$3,193.78	\$3,060.70	\$2,927.63	66				
Reflective	DC - 6	25	2	100	40	Solder Pin	SMA Female	<a href="#">PE71S1104</a>	\$4,844.02	\$4,650.26	\$4,456.50	\$4,262.74	67	
	10 MHz - 1		60	1.2	200			<a href="#">PE71S1109</a>	\$5,006.90	\$4,806.62	\$4,606.35	\$4,406.07	68	
	500 MHz - 18	55	3.2	100	SMA Female		<a href="#">PE71S6277</a>	\$2,505.79	\$2,405.56	\$2,305.33	\$2,205.10	69		
	500 MHz - 40		7.5	50			<a href="#">PE71S6223</a>	\$4,947.35	\$4,749.46	\$4,551.56	\$4,353.67	70		
	1 - 2	60	1	100	2.92mm Female		<a href="#">PE71S6228</a>	\$7,379.92	\$7,084.72	\$6,789.53	\$6,494.33	71		
	1 - 18	70	3				<a href="#">PE71S6278</a>	\$2,707.41	\$2,599.11	\$2,490.82	\$2,382.52	72		
	2 - 4	75	1.1				<a href="#">PE71S6283</a>	\$3,438.87	\$3,301.32	\$3,163.76	\$3,026.21	73		
	2 - 6		2				50	<a href="#">PE71S6279</a>	\$2,878.79	\$2,763.64	\$2,648.49	\$2,533.34	74	
	4 - 8	70	1.8				100	SMA Female	<a href="#">PE71S6284</a>	\$2,781.71	\$2,670.44	\$2,559.17	\$2,447.90	75
	6 - 12		2.5				50		<a href="#">PE71S6280</a>	\$3,080.42	\$2,957.20	\$2,833.99	\$2,710.77	76
	8 - 12	70	2.2	100	<a href="#">PE71S6285</a>		\$2,856.39	\$2,742.13	\$2,627.88	\$2,513.62	77			
	12 - 18		3		<a href="#">PE71S6281</a>		\$3,177.51	\$3,050.41	\$2,923.31	\$2,796.21	78			
									<a href="#">PE71S6282</a>	\$3,252.17	\$3,122.08	\$2,992.00	\$2,861.91	79

See Our Website For Current Pricing & Real-Time Stock Availability!

Switches



Technical Support  
+1 (949) 261-1920



Same-Day Shipping,  
Even Custom  
Cable Assemblies



**SP5T**



Switch Design	Freq. (GHz.)	Typ Iso (dB)	Typ IL (dB)	Switch Time (ns)	Max Input Power (dB)	TTL Control	Conn. Type	Model No	1	2-4	5-9	10+	ROW
Absorptive	100 MHz - 20	65	3.9	75	0.5	Solder Pin	SMA Female	<a href="#">PE71S2045</a>	\$4,680.34	\$4,493.13	\$4,305.91	\$4,118.70	80

**SP6T**



Switch Design	Freq. (GHz.)	Typ Iso (dB)	Typ IL (dB)	Switch Time (ns)	Max Input Power (dB)	TTL Control	Conn. Type	Model No	1	2-4	5-9	10+	ROW
Absorptive	100 MHz - 20	65	4.2	75	0.5	Solder Pin	SMA Female	<a href="#">PE71S2046</a>	\$5,195.73	\$4,987.90	\$4,780.07	\$4,572.24	81

**SP8T**



Switch Design	Freq. (GHz.)	Typ Iso (dB)	Typ IL (dB)	Switch Time (ns)	Max Input Power (dB)	TTL Control	Conn. Type	Model No	1	2-4	5-9	10+	ROW
Absorptive	100 MHz - 20	65	6	100	0.5	Solder Pin	SMA Female	<a href="#">PE71S2033</a>	\$8,682.25	\$8,334.96	\$7,987.67	\$7,640.38	82
	500 MHz - 18	55	4.5	50	0.1		SMA Female	<a href="#">PE71S6213</a>	\$8,669.76	\$8,322.97	\$7,976.18	\$7,629.39	83
	500 MHz - 40	50	10				2.92mm Female	<a href="#">PE71S6218</a>	\$10,611.63	\$10,187.16	\$9,762.70	\$9,338.23	84
Reflective	500 MHz - 18	55	4	100	0.1	Solder Pin	SMA Female	<a href="#">PE71S6224</a>	\$8,367.25	\$8,032.56	\$7,697.87	\$7,363.18	85
	500 MHz - 40	45	9	50			2.92mm Female	<a href="#">PE71S6229</a>	\$10,377.56	\$9,962.46	\$9,547.36	\$9,132.25	86

**SP12T**



Switch Design	Freq. (GHz.)	Typ Iso (dB)	Typ IL (dB)	Switch Time (ns)	Max Input Power (dB)	TTL Control	Conn. Type	Model No	1	2-4	5-9	10+	ROW
Absorptive	100 MHz - 20	65	6	100	0.5	Solder Pin	SMA Female	<a href="#">PE71S2034</a>	\$11,410.95	\$10,954.51	\$10,498.07	\$10,041.64	87

**Transfer**



Switch Design	Freq. (GHz.)	Typ Iso (dB)	Typ IL (dB)	Switch Time (ns)	Max Input Power (dB)	TTL Control	Conn. Type	Model No	1	2-4	5-9	10+	ROW
Absorptive	10 MHz - 1	80	1.3	100	2	Solder Pin	SMA Female	<a href="#">PE71S6286</a>	\$3,232.73	\$3,103.42	\$2,974.11	\$2,844.80	88
	1 - 2		1		1			<a href="#">PE71S6287</a>	\$3,901.25	\$3,745.20	\$3,589.15	\$3,433.10	89
	1 - 18	65	3.1		0.5			<a href="#">PE71S6292</a>	\$5,870.86	\$5,636.03	\$5,401.19	\$5,166.36	90
	2 - 4	75	1.2		1			<a href="#">PE71S6288</a>	\$3,626.47	\$3,481.41	\$3,336.35	\$3,191.29	91
	4 - 8		1.9		0.5			<a href="#">PE71S6289</a>	\$3,603.17	\$3,459.04	\$3,314.92	\$3,170.79	92
	8 - 12	70	2.2		0.5			<a href="#">PE71S6290</a>	\$3,812.25	\$3,659.76	\$3,507.27	\$3,354.78	93
	12 - 18	65	3					<a href="#">PE71S6291</a>	\$4,349.92	\$4,175.92	\$4,001.93	\$3,827.93	94

### High Isolation PIN Diode Switches



Switch Design	Freq. (GHz.)	Typ Iso (dB)	Typ IL (dB)	Switch Time (ns)	TTL Control	Conn. Type	Model No	1	2-4	5-9	10+	ROW
SPST	0 - 20	65	6	8.5	Solder Pin	SMA Female	<a href="#">PE71S5001</a>	\$6,916.43	\$6,639.77	\$6,363.12	\$6,086.46	95
SPDT	0 - 18		3	12			<a href="#">PE71S5005</a>	\$7,188.18	\$6,900.65	\$6,613.13	\$6,325.60	96
	0 - 20	35	4	5	Solder Terminals	SMA Female	<a href="#">PE71S5000</a>	\$4,610.96	\$4,426.52	\$4,242.08	\$4,057.64	97
1 - 2	90	1	75	<a href="#">PE71S5002</a>			\$2,032.59	\$1,951.29	\$1,869.98	\$1,788.68	98	
SP4T	0 - 20	38	3.8	Solder Pin	Solder Terminals	<a href="#">PE71S5006</a>	\$7,793.23	\$7,481.50	\$7,169.77	\$6,858.04	99	
	2 - 6	80	1.8			35	<a href="#">PE71S5003</a>	\$2,657.85	\$2,551.54	\$2,445.22	\$2,338.91	1
	6 - 12	75	2.5			40	<a href="#">PE71S5004</a>	\$2,862.58	\$2,748.08	\$2,633.57	\$2,519.07	2

### High Isolation USB PIN Diode Switches



Switch Type	Frequency Band (GHz.)	Insertion Loss (dB)	Isolation (dB)	Switching Speed (µs)	Model No	1	2-4	5-9	10+	ROW
USB	0.5 - 18.0	6	60	6,000	<a href="#">PE71S3900</a>	\$3,700.31	\$3,552.30	\$3,404.29	\$3,256.27	3
	0.5 - 40.0			<a href="#">PE71S3901</a>	\$5,047.40	\$4,845.50	\$4,643.61	\$4,441.71	4	

### GaN High Power Switches



Switch Design	Freq. (GHz.)	Typ Iso (dB)	Typ IL (dB)	Switch Time (ns)	Max Input Power (dB)	TTL Control	Conn. Type	Model No	1	2-4	5-9	10+	ROW
Reflective	DC - 6	33	0.9	100	46	Solder Pin	SMA	<a href="#">PE71S1100</a>	\$3,027.93	\$2,906.81	\$2,785.70	\$2,664.58	5
			<a href="#">PE71S1105</a>					\$3,190.80	\$3,063.17	\$2,935.54	\$2,807.90	6	
		36	1.3	<a href="#">PE71S1104</a>	\$4,844.02	\$4,650.26	\$4,456.50	\$4,262.74	7				
			1.5	<a href="#">PE71S1109</a>	\$5,006.90	\$4,806.62	\$4,606.35	\$4,406.07	8				
	DC - 12	32	1.5	44	Solder Pin	SMA	<a href="#">PE71S1106</a>	\$3,075.16	\$2,952.15	\$2,829.15	\$2,706.14	9	
							<a href="#">PE71S1101</a>	\$2,912.28	\$2,795.79	\$2,679.30	\$2,562.81	10	
	DC - 18	30	1.3	50	40	Solder Pin	SMA	<a href="#">PE71S1102</a>	\$3,080.04	\$2,956.84	\$2,833.64	\$2,710.44	11
								<a href="#">PE71S1107</a>	\$3,242.93	\$3,113.21	\$2,983.50	\$2,853.78	12
	0.5 - 6	43	1.2	100	50	Solder Pin	N Type	<a href="#">PE71S1103</a>	\$3,583.33	\$3,440.00	\$3,296.66	\$3,153.33	13
								<a href="#">PE71S1108</a>	\$3,746.22	\$3,596.37	\$3,446.52	\$3,296.67	14



Technical Support  
+1 (949) 261-1920



Same-Day Shipping,  
Even Custom  
Cable Assemblies

# INDEX GUIDE TO SYNTHESIZERS AND OSCILLATORS

<b>SYNTHESIZERS.....</b>	<b>336</b>
<b>VOLTAGE CONTROLLED OSCILLATORS.....</b>	<b>337</b>
<i>0.175" Ultra Small Commercial Surface Mount Packaged VCO.....</i>	<i><a href="#">337</a></i>
<i>0.5" Commercial Surface Mount Packaged VCO.....</i>	<i><a href="#">337</a></i>
<i>0.5" Commercial Surface Mount Packaged VCO w/ Integrated Buffer Amps.....</i>	<i><a href="#">338</a></i>
<i>0.5" Commercial Surface Mount Packaged VCO w/ Low Noise.....</i>	<i><a href="#">338</a></i>
<i>0.5" Commercial Surface Mount Packaged VCO w/ Modulation Input Port.....</i>	<i><a href="#">339</a></i>
<i>0.5" Hermatically Sealed MIL Grade Surface Mount Packaged VCO.....</i>	<i><a href="#">339</a></i>
<i>Connectorized Packaged VCO w/ Field Replaceable Connectors.....</i>	<i><a href="#">339</a></i>
Hi Rel Hermatic Buffer Amp.....	<a href="#">340</a>
Coaxial Packaged Commercial Standard.....	<a href="#">339</a>
<i>Phase Locked Orscillators.....</i>	<i><a href="#">341</a></i>
<i>Phase Locked Crystal Oscillators.....</i>	<i><a href="#">341</a></i>
<i>Reference Oscillators.....</i>	<i><a href="#">340</a></i>
<i>TCXO Oscillators.....</i>	<i><a href="#">340</a></i>

## SYNTHESIZERS



Type	Freq. Band (MHz.)	Typ Ref. Freq. (MHz.)	Ph. Noise @100kHz Offset (dBc/Hz)	Output Power (dBm)	2nd Harmonic	Output Connector	Model No	1	2-4	5-9	10+	R O W
Serial, TTL	2,000 - 6,000	10	-94	14 to 17	-22	SMA Female	<a href="#">PE11S1002</a>	\$10,245.68	\$9,835.85	\$9,426.03	\$9,016.20	1
USB	25 - 6,000	50	-86	-40 to 20	-25		<a href="#">PE11S3901</a>	\$6,584.09	\$6,320.73	\$6,057.36	\$5,794.00	2
	35 - 4,400		-103	-20 to 10	-30		<a href="#">PE11S3900</a>	\$1,910.11	\$1,833.71	\$1,757.30	\$1,680.90	3
	5,000 - 10,000		-72	-15 to 18	-25		<a href="#">PE11S3902</a>	\$7,784.34	\$7,472.97	\$7,161.59	\$6,850.22	4
	10,000 - 20,000		-80	-19 to 18	-15		<a href="#">PE11S3903</a>	\$8,284.00	\$7,994.06	\$7,704.12	\$7,455.60	5
	21,000 - 24,000		-88	-17 to 17	-22		<a href="#">PE11S3904</a>	\$6,173.89	\$5,926.93	\$5,679.98	\$5,433.02	6
	24,000 - 27,000		-75	14 to 17			<a href="#">PE11S3905</a>	\$6,642.30	\$6,376.61	\$6,110.92	\$5,845.22	7

**Synthesizers & Oscillators**

## OSCILLATORS

### 0.175" Ultra Small Commercial Surface Mount Packaged VCO



Frequency (MHz.)	Tuning Voltage (Vdc)	Output Power Typ (dBm)	Supply Voltage (Vdc)	Phase Noise* (dBc/Hz)	2nd Harmonics Typ (dBc)	Pushing Typ (MHz.)	Pulling Typ (MHz.)	Model No	1-24	25-49	50-99	100+	ROW
125 - 250	DC - 18	8	5	-107	-10	0.5	3	<a href="#">PE1V21000</a>	Call	Call	Call	Call	8
								<a href="#">PE2V000</a>	\$107.29	\$101.93	\$96.56	\$92.27	9
200 - 400	DC - 5	6	3	-95	-14	4	7	<a href="#">PE1V21001</a>	Call	Call	Call	Call	10
								<a href="#">PE2V001</a>	\$111.57	\$105.99	\$100.41	\$95.95	11
250 - 500	DC - 20	8	5	-107	-8	1	3	<a href="#">PE1V21002</a>	Call	Call	Call	Call	12
								<a href="#">PE2V002</a>	\$107.29	\$101.93	\$96.56	\$92.27	13
500 - 1,000	DC - 19	6	10	-97	-10	4	10	<a href="#">PE1V21003</a>	Call	Call	Call	Call	14
								<a href="#">PE2V003</a>	\$111.57	\$105.99	\$100.41	\$95.95	15
800 - 1,600	DC - 18	11	5	-93	-17	4	20	<a href="#">PE1V21004</a>	Call	Call	Call	Call	16
								<a href="#">PE2V004</a>	\$142.83	\$135.69	\$128.55	\$122.83	17
1,000 - 2,000	DC - 20	10	12	-90	-7	2	20	<a href="#">PE1V21005</a>	Call	Call	Call	Call	18
								<a href="#">PE2V005</a>	\$107.29	\$101.93	\$96.56	\$92.27	19
2,000 - 2,750	DC - 10	11	11	-86	-17	6	22	<a href="#">PE1V21006</a>	Call	Call	Call	Call	20
								<a href="#">PE2V006</a>	\$107.29	\$101.93	\$96.56	\$92.27	21
2,000 - 3,000	DC - 20	9	12	-87	-14	2	24	<a href="#">PE1V21007</a>	Call	Call	Call	Call	22
								<a href="#">PE2V007</a>	\$111.57	\$105.99	\$100.41	\$95.95	23
3,120 - 3,920	DC - 11	8	10	-87	-22	10	22	<a href="#">PE1V21008</a>	Call	Call	Call	Call	24
								<a href="#">PE2V008</a>	\$107.29	\$101.93	\$96.56	\$92.27	25
3,570 - 4,580	DC - 11.5	8	12	-83	-17	4	15	<a href="#">PE1V21009</a>	Call	Call	Call	Call	26
								<a href="#">PE2V009</a>	\$109.92	\$104.42	\$98.93	\$94.53	27
4,400 - 5,000	DC - 4.5	1	5	-85	-17	5	18	<a href="#">PE1V21010</a>	Call	Call	Call	Call	28
								<a href="#">PE2V010</a>	\$107.81	\$102.42	\$97.03	\$92.72	29
4,800 - 5,200	DC - 3	1	3.3	-80	-20	4	25	<a href="#">PE1V21011</a>	Call	Call	Call	Call	30
								<a href="#">PE2V011</a>	\$107.81	\$102.42	\$97.03	\$92.72	31
4,800 - 5,700	DC - 11	8	12	-84	-20	2	20	<a href="#">PE1V21012</a>	Call	Call	Call	Call	32
								<a href="#">PE2V012</a>	\$111.57	\$105.99	\$100.41	\$95.95	33
5,180 - 5,805	DC - 10	6	11	-83	-20	5	25	<a href="#">PE1V21013</a>	Call	Call	Call	Call	34
								<a href="#">PE2V013</a>	\$111.57	\$105.99	\$100.41	\$95.95	35
5,400 - 5,900	DC - 10	8.5	11	-84	-25	5	25	<a href="#">PE1V21014</a>	Call	Call	Call	Call	36
								<a href="#">PE2V014</a>	\$112.62	\$106.99	\$101.36	\$96.85	37
6,100 - 7,000	DC - 10	5.5	5	-76	-30	5	15	<a href="#">PE1V21015</a>	Call	Call	Call	Call	38
								<a href="#">PE2V015</a>	\$109.92	\$104.42	\$98.93	\$94.53	39
7,390 - 8,060	DC - 9	4	5	-75	-22	10	40	<a href="#">PE1V21016</a>	Call	Call	Call	Call	40
								<a href="#">PE2V016</a>	\$111.57	\$105.99	\$100.41	\$95.95	41
8,300 - 9,100	DC - 10	1	5	-73	-25	5	20	<a href="#">PE1V21017</a>	Call	Call	Call	Call	42
								<a href="#">PE2V017</a>	\$111.57	\$105.99	\$100.41	\$95.95	43
9,000 - 10,000	DC - 11	7	12	-78	-30	15	50	<a href="#">PE1V21018</a>	Call	Call	Call	Call	44
								<a href="#">PE2V018</a>	\$111.57	\$105.99	\$100.41	\$95.95	45
10,000 - 11,000	DC - 11	4	12	-72	-40	15	70	<a href="#">PE1V21019</a>	Call	Call	Call	Call	46
								<a href="#">PE2V019</a>	\$111.57	\$105.99	\$100.41	\$95.95	47

### 0.5" Commercial Surface Mount Packaged VCO



Frequency (MHz.)	Tuning Voltage (Vdc)	Output Power Typ (dBm)	Supply Voltage (Vdc)	Phase Noise* (dBc/Hz)	2nd Harmonics Typ (dBc)	Pushing Typ (MHz.)	Pulling Typ (MHz.)	Model No	1-24	25-49	50-99	100+	ROW
10 - 20	DC - 20	10	15	-120	-11	0.02	0.05	<a href="#">PE1V11000</a>	\$107.63	\$102.25	\$96.87	\$92.56	48
18 - 30	DC - 12	12	12	-120	-13	0.03	0.07	<a href="#">PE1V11001</a>	\$107.63	\$102.25	\$96.87	\$92.56	49
25 - 50	DC - 15	11.5	15	-120	-12	0.05	0.03	<a href="#">PE1V11002</a>	\$105.06	\$99.81	\$94.55	\$90.35	50
30 - 60	DC - 15	11	15	-119	-14	0.05	0.05	<a href="#">PE1V11003</a>	\$103.09	\$97.94	\$92.78	\$88.66	51
40 - 80	DC - 20	12	15	-117	-14	0.05	0.05	<a href="#">PE1V11004</a>	\$107.63	\$102.25	\$96.87	\$92.56	52
40 - 100	DC - 20	11.5	15	-118	-14	0.2	0.1	<a href="#">PE1V11005</a>	\$103.09	\$97.94	\$92.78	\$88.66	53
50 - 100	DC - 20	12	15	-115	-12	0.05	0.1	<a href="#">PE1V11006</a>	\$105.06	\$99.81	\$94.55	\$90.35	54
60 - 120	DC - 18.5	11	15	-114	-20	0.2	0.1	<a href="#">PE1V11007</a>	\$103.09	\$97.94	\$92.78	\$88.66	55

\* Phase Noise measured at 10 KHz offset frequency



Technical Support  
+1 (949) 261-1920



Same-Day Shipping,  
Even Custom  
Cable Assemblies

See Our Website For Current Pricing & Real-Time Stock Availability!

Synthesizers & Oscillators



### 0.5" Commercial Surface Mount Packaged VCO



Frequency (MHz.)	Tuning Voltage (Vdc)	Output Power Typ (dBm)	Supply Voltage (Vdc)	Phase Noise* (dBc/Hz)	2nd Harmonics Typ (dBc)	Pushing Typ (MHz.)	Pulling Typ (MHz.)	Model No	1-24	25-49	50-99	100+	R O W
75 - 150	DC - 18	11	15	-110	-20	0.2	0.4	<a href="#">PE1V11008</a>	\$105.06	\$99.81	\$94.55	\$90.35	56
100 - 200	DC - 18	11	15	-113	-12	0.2	0.1	<a href="#">PE1V11009</a>	\$103.09	\$97.94	\$92.78	\$88.66	57
150 - 300	DC - 20	11	15	-108	-14	1	2	<a href="#">PE1V11010</a>	\$107.63	\$102.25	\$96.87	\$92.56	58
200 - 400	DC - 20	11	15	-106	-14	0.4	0.2	<a href="#">PE1V11011</a>	\$185.76	\$176.47	\$167.18	\$159.75	59
300 - 400	DC - 9	11	15	-102	-18	0.6	0.5	<a href="#">PE1V11012</a>	\$107.63	\$102.25	\$96.87	\$92.56	60
400 - 600	DC - 15	11	15	-102	-15	1	1.5	<a href="#">PE1V11013</a>	\$103.09	\$97.94	\$92.78	\$88.66	61
400 - 800	DC - 9	8	5	-96	-14	3	1.3	<a href="#">PE1V11014</a>	\$103.09	\$97.94	\$92.78	\$88.66	62
500 - 900	DC - 11.5	12	12	-95	-14	1.5	1.5	<a href="#">PE1V11015</a>	\$103.09	\$97.94	\$92.78	\$88.66	63
600 - 1,000	DC - 20	12.5	15	-96	-15	0.8	0.7	<a href="#">PE1V11016</a>	\$107.11	\$101.75	\$96.40	\$92.11	64
800 - 1,200	DC - 20	11.5	15	-95	-12	0.8	2.5	<a href="#">PE1V11017</a>	\$107.63	\$102.25	\$96.87	\$92.56	65
1,200 - 1,800	DC - 20	11	15	-89	-12	0.5	3	<a href="#">PE1V11018</a>	\$107.63	\$102.25	\$96.87	\$92.56	66
1,350 - 1,650	DC - 18	10	15		-12	1.5		<a href="#">PE1V11019</a>	\$103.09	\$97.94	\$92.78	\$88.66	67
1,500 - 2,100	DC - 18	10	15		-12			<a href="#">PE1V11020</a>	\$103.09	\$97.94	\$92.78	\$88.66	68
1,500 - 2,500	DC - 16	10	15		-12			<a href="#">PE1V11021</a>	\$107.63	\$102.25	\$96.87	\$92.56	69
2,000 - 2,750	DC - 10	7	11		-12			<a href="#">PE1V11022</a>	\$107.63	\$102.25	\$96.87	\$92.56	70
2,570 - 3,300	DC - 10	5	11		-15			<a href="#">PE1V11023</a>	\$107.63	\$102.25	\$96.87	\$92.56	71
3,000 - 3,500	DC - 10	10	11	-81	-16	2.5	12	<a href="#">PE1V11024</a>	\$103.09	\$97.94	\$92.78	\$88.66	72
3,120 - 3,870	DC - 10	5	11		-15			<a href="#">PE1V11025</a>	\$107.63	\$102.25	\$96.87	\$92.56	73
4,000 - 5,000	DC - 15	8	15		-18			<a href="#">PE1V11026</a>	\$107.63	\$102.25	\$96.87	\$92.56	74
4,260 - 5,000	DC - 10	7	11		-18			<a href="#">PE1V11027</a>	\$105.06	\$99.81	\$94.55	\$90.35	75

### 0.5" Commercial Surface Mount Packaged VCO w/ Integrated Buffer Amps



Frequency (MHz.)	Tuning Voltage (Vdc)	Output Power Typ (dBm)	Supply Voltage (Vdc)	Phase Noise* (dBc/Hz)	2nd Harmonics Typ (dBc)	Pushing Typ (MHz.)	Pulling Typ (MHz.)	Model No	1-24	25-49	50-99	100+	R O W
510 - 550	DC - 3.5	6.5	5	-106	-22	1.5	0.8	<a href="#">PE1V14000</a>	\$103.09	\$97.94	\$92.78	\$88.66	76
950 - 1,100	DC - 4.5	9	5	-104	-18	0.8	0.3	<a href="#">PE1V14001</a>	\$103.09	\$97.94	\$92.78	\$88.66	77
1,570 - 1,850	DC - 4.5	5	5	-101	-18	1.8	0.2	<a href="#">PE1V14002</a>	\$107.63	\$102.25	\$96.87	\$92.56	78
1,600 - 3,200	DC - 20	6	5	-89	-14	4	10	<a href="#">PE1V14003</a>	\$107.11	\$101.75	\$96.40	\$92.11	79
1,700 - 1,850	DC - 4.5	3.5	5	-100	-40	0.8	0.2	<a href="#">PE1V14004</a>	\$103.09	\$97.94	\$92.78	\$88.66	80
1,800 - 2,000	DC - 4.5	4.5	5	-100	-20	1.5	0.6	<a href="#">PE1V14005</a>	\$103.09	\$97.94	\$92.78	\$88.66	81
1,900 - 2,100	DC - 4.5	4.5	5	-102	-40	3	0.3	<a href="#">PE1V14006</a>	\$103.09	\$97.94	\$92.78	\$88.66	82
2,100 - 2,300	DC - 4.5	4.5	5	-101	-35	2.5	0.3	<a href="#">PE1V14007</a>	\$107.63	\$102.25	\$96.87	\$92.56	83
2,800 - 3,000	DC - 4.5	-2	5	-93	-25	2	0.8	<a href="#">PE1V14008</a>	\$103.09	\$97.94	\$92.78	\$88.66	84
4,130 - 4,350	DC - 8	7.5	8	-98	-30	4	6	<a href="#">PE1V14009</a>	\$103.09	\$97.94	\$92.78	\$88.66	85
4,770 - 5,010	DC - 7.5	5	8	-98	-20	4	4	<a href="#">PE1V14010</a>	\$103.09	\$97.94	\$92.78	\$88.66	86

### 0.5" Commercial Surface Mount Packaged VCO w/ Low Noise



Frequency (MHz.)	Tuning Voltage (Vdc)	Output Power Typ (dBm)	Supply Voltage (Vdc)	Phase Noise* (dBc/Hz)	2nd Harmonics Typ (dBc)	Pushing Typ (MHz.)	Pulling Typ (MHz.)	Model No	1-24	25-49	50-99	100+	R O W
305 - 425	DC - 19.5	8	5	-117	-40	1.5	4	<a href="#">PE1V15000</a>	\$103.09	\$97.94	\$92.78	\$88.66	87
850 - 900	DC - 4.5	1.5	5	-113	-45	0.3	0.2	<a href="#">PE1V15001</a>	\$107.11	\$101.75	\$96.40	\$92.11	88

\* Phase Noise measured at 10 KHz offset frequency

### 0.5" Commercial Surface Mount Packaged VCO w/ Modulation Input Port



Frequency (MHz.)	Tuning Voltage (Vdc)	Output Power Typ (dBm)	Supply Voltage (Vdc)	Phase Noise* (dBc/Hz)	2nd Harmonics Typ (dBc)	Pushing Typ (MHz.)	Pulling Typ (MHz.)	Model No	1-9	10-24	25-49	50+	ROW
130 - 175	DC - 15	6.5	5	-125	-25	0.1	0.2	<a href="#">PE1V12000</a>	\$122.00	\$115.90	\$109.80	\$104.92	89
195 - 240	DC - 15	8.5	5	-125	-15	0.2	0.05	<a href="#">PE1V12001</a>	\$122.00	\$115.90	\$109.80	\$104.92	90
243 - 270	DC - 9.5	10	8	-120	-38	0.05	0.2	<a href="#">PE1V12002</a>	\$126.76	\$120.42	\$114.08	\$109.01	91
260 - 280	DC - 10	8	5	-123	-15	0.1	0.1	<a href="#">PE1V12003</a>	\$122.00	\$115.90	\$109.80	\$104.92	92
380 - 400	DC - 10	4.5	5	-124	-20	0.2	0.1	<a href="#">PE1V12004</a>	\$122.00	\$115.90	\$109.80	\$104.92	93
400 - 430	DC - 10	3.5	5	-123	-25	0.1	0.05	<a href="#">PE1V12005</a>	\$122.00	\$115.90	\$109.80	\$104.92	94
430 - 470	DC - 10	3.5	5	-122	-25	0.2	0.05	<a href="#">PE1V12006</a>	\$122.00	\$115.90	\$109.80	\$104.92	95
465 - 525	DC - 15	3.5	5	-122	-18	0.1	0.2	<a href="#">PE1V12007</a>	\$126.76	\$120.42	\$114.08	\$109.01	96
650 - 700	DC - 10	7.5	8	-121	-25	0.2	0.1	<a href="#">PE1V12008</a>	\$122.00	\$115.90	\$109.80	\$104.92	97

### 0.5" Hermetically Sealed MIL Grade Surface Mount Packaged VCO



Frequency (MHz.)	Tuning Voltage (Vdc)	Output Power Typ (dBm)	Supply Voltage (Vdc)	Phase Noise* (dBc/Hz)	2nd Harmonics Typ (dBc)	Pushing Typ (MHz.)	Pulling Typ (MHz.)	Model No	1-9	10-24	25-49	50+	ROW
10 - 20	DC - 20	10	15	-120	-11	0.02	0.05	<a href="#">PE1V13000</a>	\$454.63	\$431.90	\$409.17	\$390.98	98
18 - 30	DC - 12	12	12	-120	-13	0.03	0.07	<a href="#">PE1V13001</a>	\$454.63	\$431.90	\$409.17	\$390.98	99
25 - 50	0.5 - 20	11.5	15	-114	-10	0.1	0.1	<a href="#">PE1V13002</a>	\$454.63	\$431.90	\$409.17	\$390.98	1
30 - 60	DC - 15	11	15	-119	-14	0.05	0.05	<a href="#">PE1V13003</a>	\$454.63	\$431.90	\$409.17	\$390.98	2
40 - 80	DC - 20	12	15	-117	-14	0.05	0.05	<a href="#">PE1V13004</a>	\$454.63	\$431.90	\$409.17	\$390.98	3
40 - 100	DC - 20	11.5	15	-118	-14	0.2	0.1	<a href="#">PE1V13005</a>	\$454.63	\$431.90	\$409.17	\$390.98	4
50 - 100	DC - 20	12	15	-115	-12	0.05	0.1	<a href="#">PE1V13006</a>	\$454.63	\$431.90	\$409.17	\$390.98	5
60 - 120	DC - 18.5	11	15	-114	-20	0.2	0.1	<a href="#">PE1V13007</a>	\$454.63	\$431.90	\$409.17	\$390.98	6
75 - 150	DC - 18	11	15	-110	-20	0.2	0.4	<a href="#">PE1V13008</a>	\$454.63	\$431.90	\$409.17	\$390.98	7
100 - 200	DC - 18	11	15	-113	-12	0.2	0.1	<a href="#">PE1V13009</a>	\$454.63	\$431.90	\$409.17	\$390.98	8
150 - 300	DC - 20	11	15	-108	-14	1	2	<a href="#">PE1V13010</a>	\$454.63	\$431.90	\$409.17	\$390.98	9
200 - 400	DC - 20	11	15	-106	-14	0.4	0.2	<a href="#">PE1V13011</a>	\$479.44	\$455.47	\$431.50	\$412.32	10
400 - 800	DC - 9	8	5	-96	-14	3	1.3	<a href="#">PE1V13012</a>	\$454.63	\$431.90	\$409.17	\$390.98	11
1,200 - 1,800	DC - 20	11	15	-89	-12	0.5	3	<a href="#">PE1V13013</a>	\$454.63	\$431.90	\$409.17	\$390.98	12
3,000 - 3,500	DC - 10	10	11	-81	-16	2.5	12	<a href="#">PE1V13014</a>	\$479.44	\$455.47	\$431.50	\$412.32	13
3,700 - 4,350	DC - 7.5	4	8	-83	-25	6	15	<a href="#">PE1V13015</a>	\$479.44	\$455.47	\$431.50	\$412.32	14

### Connectorized Packaged VCO w/ Field Replaceable Connectors

#### Coaxial Packaged Commercial Standard



Frequency (MHz.)	Tuning Voltage (Vdc)	Output Power Typ (dBm)	Supply Voltage (Vdc)	Phase Noise* (dBc/Hz)	2nd Harmonics Typ (dBc)	Pushing Typ (MHz.)	Pulling Typ (MHz.)	Model No	1-9	10-24	25-49	50+	ROW
18 - 30	0.5 - 12	12	12	-120	-13	0.03	0.07	<a href="#">PE1V31000</a>	\$395.59	\$375.81	\$356.03	\$340.21	15
25 - 50	0.5 - 15	11.5	15	-120	-12	0.05	0.03	<a href="#">PE1V31001</a>	\$424.09	\$402.89	\$381.68	\$364.72	16
30 - 60	0.5 - 15	11	15	-119	-14	0.05	0.05	<a href="#">PE1V31002</a>	\$424.09	\$402.89	\$381.68	\$364.72	17
40 - 80	0.5 - 20	12	15	-117	-14	0.05	0.05	<a href="#">PE1V31003</a>	\$424.09	\$402.89	\$381.68	\$364.72	18
40 - 100	0.5 - 20	11.5	15	-118	-14	0.2	0.1	<a href="#">PE1V31004</a>	\$408.17	\$387.76	\$367.35	\$351.03	19
50 - 100	0.5 - 20	12	15	-115	-12	0.05	0.1	<a href="#">PE1V31005</a>	\$424.09	\$402.89	\$381.68	\$364.72	20
75 - 150	0.5 - 18	11	15	-110	-20	0.2	0.4	<a href="#">PE1V31007</a>	Call	Call	Call	Call	21
200 - 400	0.5 - 20	11	15	-106	-14	0.4	0.2	<a href="#">PE1V31009</a>	Call	Call	Call	Call	22
400 - 800	0.5 - 13	12	10	-94	-20	0.6	0.7	<a href="#">PE1V31010</a>	Call	Call	Call	Call	23

\* Phase Noise measured at 10 KHz offset frequency



Technical Support  
+1 (949) 261-1920



Same-Day Shipping,  
Even Custom  
Cable Assemblies

**Coaxial Packaged Commercial Standard**



Frequency (MHz.)	Tuning Voltage (Vdc)	Output Power Typ (dBm)	Supply Voltage (Vdc)	Phase Noise* (dBc/Hz)	2nd Harmonics Typ (dBc)	Pushing Typ (MHz.)	Pulling Typ (MHz.)	Model No	1-9	10-24	25-49	50+	ROW
1,200 - 1,800	0.5 - 20	11	15	-89	-12	0.5	3	<a href="#">PE1V31011</a>	Call	Call	Call	Call	24
230 - 290	0.5 - 4.5	2	12	-107	-8.5			<a href="#">PE1V31015</a>	\$518.30	\$492.39	\$466.47	\$445.74	25
500 - 600	0.5 - 4.5	-2	12	-105	-20			<a href="#">PE1V31016</a>	\$518.30	\$492.39	\$466.47	\$445.74	26
850 - 890	DC - 5	8	12	-99	-5		5	<a href="#">PE1V31018</a>	\$518.30	\$492.39	\$466.47	\$445.74	27
900 - 960	0.5 - 4	5.5	12	-110	-15		5	<a href="#">PE1V31019</a>	\$518.30	\$492.39	\$466.47	\$445.74	28
1,700 - 1,850	0.5 - 4.5	0	12	-96	-15		13	<a href="#">PE1V31023</a>	\$518.30	\$492.39	\$466.47	\$445.74	29
2,300 - 2,450	0.5 - 4.5	3	12	-101	-15		2	<a href="#">PE1V31025</a>	\$518.30	\$492.39	\$466.47	\$445.74	30
2,400 - 2,800	1 - 11	9	12	-92	-10		50	<a href="#">PE1V31026</a>	\$518.30	\$492.39	\$466.47	\$445.74	31
3,200 - 3,400	0.5 - 4.5	5	12	-88	-15		25	<a href="#">PE1V31027</a>	\$518.30	\$492.39	\$466.47	\$445.74	32
1,435 - 1,650	0.5 - 5	7	12	-90	-7		35	<a href="#">PE1V31021</a>	\$518.30	\$492.39	\$466.47	\$445.74	33
1,550 - 1,850	0.25 - 4.75	1.5	12	-99	-20		2	<a href="#">PE1V31022</a>	\$518.30	\$492.39	\$466.47	\$445.74	34
620 - 660	0.5 - 4.5	0	12	-110	-13		2	<a href="#">PE1V31017</a>	\$518.30	\$492.39	\$466.47	\$445.74	35
1,070 - 1,210	0.5 - 4.5	1.5	12	-109	-16		1	<a href="#">PE1V31020</a>	\$518.30	\$492.39	\$466.47	\$445.74	36
2,165 - 2,360	0.5 - 10	5	12	-99	-10		10	<a href="#">PE1V31024</a>	\$518.30	\$492.39	\$466.47	\$445.74	37
4,245 - 4,335	0.5 - 8	0.5	12	-87	-13		10	<a href="#">PE1V31028</a>	\$518.30	\$492.39	\$466.47	\$445.74	38
5,220 - 5,420	0.5 - 4.5	-1	12	-83	-25		10	<a href="#">PE1V31029</a>	\$518.30	\$492.39	\$466.47	\$445.74	39

**Hi-REL Hermetic Buffer Amp**



Frequency (MHz.)	Tuning Voltage (Vdc)	Output Power Typ (dBm)	Supply Voltage (Vdc)	Phase Noise* (dBc/Hz)	2nd Harmonics Typ (dBc)	Pushing Typ (MHz.)	Pulling Typ (MHz.)	Model No	1	2-4	5-9	10+	ROW
4,000 - 8,000	DC - 18	20	12	-75	-10	0.2	1	<a href="#">PE1V34000</a>	\$5,282.63	\$5,097.74	\$4,912.85	\$4,754.37	40
5,000 - 10,000	DC - 20	20	12	-64	-15	0.2	1	<a href="#">PE1V34001</a>	\$6,095.16	\$5,851.35	\$5,607.55	\$5,363.74	41
38,400 - 43,200	DC - 13	13	5	-74	-30	40	0.01	<a href="#">PE1V34003</a>	\$10,620.59	\$10,195.77	\$9,770.94	\$9,346.12	42

**Reference Oscillators**



Loop Type	Out Freq (MHz)	Ref. Type	Out Power Typ (dBm)	2nd Harmonics Typ (dBc)	Spurious Typ (dBc)	Ph Noise @100kHz Offset (dBc/Hz)	Package Type	Model No	1 Pc. Price	See Web for Volume Pricing			ROW
Free Running	10	Internal	+7	-20	-70	-145	Surface Mount	<a href="#">PE19XR1000</a>	\$412.99	See Web for Volume Pricing			43
				-25		Connectorized	<a href="#">PE19XR1003</a>	\$2,128.44	44				
	50			-20		Surface Mount	<a href="#">PE19XR1001</a>	\$427.19	45				
				-25		Connectorized	<a href="#">PE19XR1004</a>	\$2,173.29	46				
	100			-20		Surface Mount	<a href="#">PE19XR1002</a>	\$501.18	47				
				-25		Connectorized	<a href="#">PE19XR1005</a>	\$2,338.84	48				

**TCXO Oscillators**

**CMOS**



Output Freq. (GHz)	High Level Out Voltage (V min)	Low Level Out Voltage (V max)	Temp Stability (+/- ppm)	Ph Noise @10kHz Offset (dBc/Hz)	Dimensions (in)	Model No	1-4	5-9	10-24	25+	ROW
10	4.9	0.1	2.5	-145	1.25x1.25x 0.563	<a href="#">PE19XL6000</a>	\$769.03	\$730.58	\$692.13	\$661.37	49
20						<a href="#">PE19XL6001</a>	\$729.25	\$692.79	\$656.33	\$627.16	50

## Phase Locked Oscillators



Loop Type	Out Freq (MHz)	Ref. Type	Ref. Input Freq. (MHz.)	Out Power Typ (dBm)	2nd Harmonics Typ (dBc)	Spurious Typ (dBc)	Package Type	Model No	1 Pc. Price	See Web for Volume Pricing	ROW
Phase Locked	500	External	10	7	-35	-70	Connectorized	<a href="#">PE19XC7000</a>	\$1,690.59	See Web for Volume Pricing	51
							Surface Mount	<a href="#">PE19XP5004</a>	\$475.25		52
							Connectorized	<a href="#">PE19XC7005</a>	\$1,603.12		53
							Surface Mount	<a href="#">PE19XP5009</a>	\$475.25		54
							Connectorized	<a href="#">PE19XC7001</a>	\$1,690.59		55
							Surface Mount	<a href="#">PE19XP5005</a>	\$475.25		56
	Connectorized		<a href="#">PE19XC7006</a>				\$1,627.12	57			
	Surface Mount		<a href="#">PE19XP5010</a>				\$475.25	58			
	Connectorized		<a href="#">PE19XC7002</a>				\$1,936.29	59			
	Surface Mount		<a href="#">PE19XP5006</a>				\$676.17	60			
	Connectorized		<a href="#">PE19XC7007</a>				\$1,936.29	61			
	Surface Mount		<a href="#">PE19XP5011</a>				\$641.19	62			
	Connectorized	<a href="#">PE19XC7003</a>	\$2,218.56	63							
	Surface Mount	<a href="#">PE19XP5007</a>	\$741.09	64							
	Connectorized	<a href="#">PE19XC7008</a>	\$2,103.78	65							
	Surface Mount	<a href="#">PE19XP5012</a>	\$702.73	66							
	Connectorized	<a href="#">PE19XC7004</a>	\$2,411.20	67							
	Surface Mount	<a href="#">PE19XP5008</a>	\$771.95	68							
Connectorized	<a href="#">PE19XC7009</a>	\$2,411.20	69								
Surface Mount	<a href="#">PE19XP5013</a>	\$771.95	70								

## Phase Locked Crystal Oscillators



Loop Type	Out Freq (MHz)	Ref. Type	Ref. Input Freq. (MHz)	Out Power Typ (dBm)	2nd Harmonics Typ (dBc)	Spurious Typ (dBc)	Package Type	Model No	1 Pc. Price	See Web for Volume Pricing	ROW
Phase-Locked Crystal	50	External	10	+7	-20	-70	Surface Mount	<a href="#">PE19XP5000</a>	\$720.05	See Web for Volume Pricing	71
							Connectorized	<a href="#">PE19XP5002</a>	\$2,615.93		72
	Surface Mount						<a href="#">PE19XP5001</a>	\$864.74	73		
	Connectorized						<a href="#">PE19XP5003</a>	\$2,872.10	74		

## TAPPERS

### Equal Split



Frequency Range (MHz.)	Number of Ports	Maximum Power	Directivity (dB)	Model No	1-9	10-24	25-49	50+	ROW
376-2,200	2	500 Watt	-1	<a href="#">PE-T1009</a>	\$229.32	\$217.85	\$206.39	\$197.22	75
380-2,500				<a href="#">PE-T1000</a>	\$214.26	\$205.69	\$199.26	\$194.98	76
				<a href="#">PE20DV1026</a>	\$224.03	\$212.83	\$201.63	\$192.67	77
600-2,700				<a href="#">PE20DV1027</a>	\$284.23	\$270.02	\$255.81	\$244.44	78
				<a href="#">PE20DV1028</a>	\$253.92	\$241.22	\$228.53	\$218.37	79
				<a href="#">PE20DV1029</a>	\$322.88	\$306.74	\$290.59	\$277.68	80
		<a href="#">PE20DV1030</a>		\$276.32	\$262.50	\$248.69	\$237.64	81	
		<a href="#">PE20DV1031</a>		\$336.05	\$319.25	\$302.45	\$289.00	82	
		<a href="#">PE-T1012</a>		\$214.26	\$205.69	\$199.26	\$194.98	83	
700-2,700		<a href="#">PE-T1003</a>		\$192.49	\$182.87	\$173.24	\$165.54	84	
		<a href="#">PE-T1010</a>		\$220.07	\$209.07	\$198.06	\$189.26	85	



Technical Support  
+1 (949) 261-1920



Same-Day Shipping,  
Even Custom  
Cable Assemblies



## Unequal Split



Frequency Range (MHz.)	Coupling (dB)	Maximum Power	Directivity (dB)	Model No	1-9	10-24	25-49	50+	R O W
350-5,850	5	300 Watt	2	<a href="#">PETP1001</a>	\$261.37	\$248.30	\$235.23	\$224.78	86
	6		3	<a href="#">PETP1002</a>	\$216.56	\$205.73	\$194.90	\$186.24	87
	7		<a href="#">PETP1003</a>	\$261.37	\$248.30	\$235.23	\$224.78	88	
			<a href="#">PE-T2006</a>	\$190.57	\$182.95	\$177.23	\$173.42	89	
			<a href="#">PETP1004</a>	\$228.39	\$216.97	\$205.55	\$196.42	90	
	8		<a href="#">PETP1005</a>	\$261.37	\$248.30	\$235.23	\$224.78	91	
			<a href="#">PE-T2003</a>	\$190.57	\$182.95	\$177.23	\$173.42	92	
			<a href="#">PETP1006</a>	\$216.56	\$205.73	\$194.90	\$186.24	93	
	9		<a href="#">PETP1007</a>	\$261.37	\$248.30	\$235.23	\$224.78	94	
			<a href="#">PETP1008</a>	\$216.56	\$205.73	\$194.90	\$186.24	95	
	10		<a href="#">PETP1009</a>	\$265.28	\$252.02	\$238.75	\$228.14	96	
			<a href="#">PE-T2007</a>	\$277.49	\$263.62	\$249.74	\$238.64	97	
	13		<a href="#">PETP1010</a>	\$216.56	\$205.73	\$194.90	\$186.24	98	
			<a href="#">PE-T2018</a>	\$165.16	\$156.90	\$148.64	\$142.04	99	
	15		<a href="#">PE-T2001</a>	\$183.41	\$176.07	\$170.57	\$166.90	1	
			<a href="#">PE-T2015</a>	\$190.75	\$183.12	\$177.40	\$173.58	2	
			<a href="#">PETP1012</a>	\$216.56	\$205.73	\$194.90	\$186.24	3	
<a href="#">PETP1013</a>		\$261.37	\$248.30	\$235.23	\$224.78	4			
<a href="#">PE-T2000</a>		\$180.70	\$173.47	\$168.05	\$164.44	5			
<a href="#">PETP1014</a>		\$216.56	\$205.73	\$194.90	\$186.24	6			
<a href="#">PETP1015</a>		\$261.37	\$248.30	\$235.23	\$224.78	7			
20	<a href="#">PE-T2004</a>	\$180.70	\$173.47	\$168.05	\$164.44	8			
	<a href="#">PETP1016</a>	\$216.56	\$205.73	\$194.90	\$186.24	9			
	<a href="#">PETP1017</a>	\$261.37	\$248.30	\$235.23	\$224.78	10			
30	<a href="#">PE-T2014</a>	\$165.16	\$156.90	\$148.64	\$142.04	11			
	<a href="#">PE-T2011</a>	\$165.16	\$156.90	\$148.64	\$142.04	12			
	<a href="#">PE-T2012</a>	\$165.16	\$156.90	\$148.64	\$142.04	13			
	<a href="#">PE-T2010</a>	\$165.16	\$156.90	\$148.64	\$142.04	14			
	<a href="#">PE-T2025</a>	\$165.16	\$156.90	\$148.64	\$142.04	15			
	<a href="#">PE-T2017</a>	\$233.49	\$221.82	\$210.14	\$200.80	16			
100	<a href="#">PE-T2016A</a>	\$244.64	\$232.41	\$220.18	\$210.39	17			
	<a href="#">PE-T2023</a>	\$257.99	\$245.09	\$232.19	\$221.87	18			
1000	<a href="#">PE-T2013</a>	\$209.75	\$199.26	\$188.78	\$180.39	19			
380-6,000	6		3	<a href="#">PE-T2014</a>	\$165.16	\$156.90	\$148.64	\$142.04	11
	7		4	<a href="#">PE-T2011</a>	\$165.16	\$156.90	\$148.64	\$142.04	12
	8		5	<a href="#">PE-T2012</a>	\$165.16	\$156.90	\$148.64	\$142.04	13
	9		7	<a href="#">PE-T2010</a>	\$165.16	\$156.90	\$148.64	\$142.04	14
	11		12	<a href="#">PE-T2025</a>	\$165.16	\$156.90	\$148.64	\$142.04	15
698-2,700	20		100	<a href="#">PE-T2017</a>	\$233.49	\$221.82	\$210.14	\$200.80	16
	10		9	<a href="#">PE-T2016A</a>	\$244.64	\$232.41	\$220.18	\$210.39	17
	30		1000	<a href="#">PE-T2023</a>	\$257.99	\$245.09	\$232.19	\$221.87	18
700-2,700	5		2	<a href="#">PE-T2013</a>	\$209.75	\$199.26	\$188.78	\$180.39	19

## INDEX GUIDE TO TERMINATIONS AND MATCHING PADS

### TERMINATIONS AND MATCHING PADS.....342

#### MATCHING PADS.....347



Matching pads designed to mate with 50 ohm connectors on one end and 75 ohm connectors on the opposite end are available in a range of connector options.

Resistive Impedance Transformers.....347

#### TERMINATIONS.....343



RF Coaxial Terminations are available in a number of connector options and frequency ranges. Power ratings for these terminations range from 1/2 watt to 500 watts of continuous power. 50 ohm and 75 ohm options are available as well.

RF Load.....343 Feed-Thru Load.....347

# TERMINATIONS

## RF Load

50 Ohm



Max. Power (Watts)	Connector	Maximum Frequency.	Construction Material	VSWR Max.	Chain	Model No	1 Pc. Price	See Web for Volume Pricing	ROW	
0.25 W	Mini SMP Female	18 GHz	Gold Plated Beryllium Copper	1.35:1	No	<a href="#">PE6184</a>	\$55.38	See Web for Volume Pricing	1	
		40 GHz		1.45:1	No	<a href="#">PE6182</a>	\$161.58		2	
0.5 W	2.92mm Male	40 GHz	Passivated Stainless Steel	1.2:1	Yes	<a href="#">PE6086</a>	\$415.02		3	
	No				<a href="#">PE6085</a>	\$298.64	4			
	2.92mm Female	Yes	<a href="#">PE6088</a>	\$454.25	5					
	No	<a href="#">PE6087</a>	\$454.69	6						
	7/16 DIN Male	1,000 MHz	Tri-Metal Plated Brass		No	<a href="#">PE6146</a>	\$135.55		7	
	Mini SMP Male	40 GHz	Gold Plated Beryllium Copper	1.35:1	No	<a href="#">PE6163</a>	\$262.55		8	
	Mini SMP Female		Gold over Nickel Plated Beryllium Copper		No	<a href="#">PE6162</a>	\$298.48		9	
	SMA Male	12.4 GHz	Passivated Stainless Steel	1.17:1	No	<a href="#">PE6002</a>	\$40.56		10	
	SMA Female				Yes	<a href="#">PE6070</a>	\$88.71		11	
	SMP Female		18 GHz	Gold Plated Beryllium Copper	1.35:1	No	<a href="#">PE6183</a>		\$40.62	12
			26.5 GHz		1.3:1	No	<a href="#">PE6181</a>		\$109.47	13
	1 W	1.85mm Male	65 GHz	Passivated Stainless Steel	1.6:1	Yes	<a href="#">PE6236</a>		\$613.86	14
			No			<a href="#">PE6235</a>	\$539.79		15	
		67 GHz	Yes	<a href="#">PE6TR1101</a>	\$400.67	16				
			No	<a href="#">PE6TR1100</a>	\$380.07	17				
		1.85mm Female		No	<a href="#">PE6TR1102</a>	\$380.07	18			
				Passivated Stainless Steel	1.45:1	Yes	<a href="#">PE6179</a>		\$577.87	19
		2.4mm Male	50 GHz	Passivated Stainless Steel	1.2:1	Yes	<a href="#">PE6TR1104</a>		\$390.37	20
1.45:1					No	<a href="#">PE6178</a>	\$522.30		21	
2.4mm Female				1.2:1	No	<a href="#">PE6TR1103</a>	\$380.07		22	
				No	<a href="#">PE6TR1105</a>	\$380.07	23			
2.92mm Male		40 GHz	Passivated Stainless Steel	1.25:1	Yes	<a href="#">PE6174</a>	\$313.17		24	
				1.15:1	Yes	<a href="#">PE6TR1107</a>	\$256.47		25	
				1.25:1	No	<a href="#">PE6173</a>	\$276.03		26	
				1.15:1	No	<a href="#">PE6TR1106</a>	\$246.17		27	
2.92mm Female			Passivated Stainless Steel	1.25:1	No	<a href="#">PE6175</a>	\$347.20		28	
				No	<a href="#">PE6TR1108</a>	\$266.77	29			
3.5mm Male		34.5 GHz		1.15:1	No	<a href="#">PE6TR1109</a>	\$277.07		30	
				1.25:1	No	<a href="#">PE6TR1110</a>	\$256.47		31	
3.5mm Female			1.15:1	No	<a href="#">PE6TR1111</a>	\$277.07	32			
			1.25:1	No	<a href="#">PE6TR1112</a>	\$256.47	33			
BMA Plug			1.2:1		<a href="#">PE6TR1041</a>	\$178.08	34			
			1.3:1		<a href="#">PE6TR1042</a>	\$191.26	35			
BMA Jack	18 GHz		1.2:1		<a href="#">PE6TR1044</a>	\$58.73	36			
			1.15:1	No	<a href="#">PE6TR1117</a>	\$55.52	37			
Mini SMP Female	27 GHz		1.2:1	No	<a href="#">PE6TR1118</a>	\$101.97	38			
			40 GHz	No	<a href="#">PE6TR1119</a>	\$163.77	39			
			50 GHz	No	<a href="#">PE6TR1120</a>	\$256.47	40			
MMCX Male	6 GHz	Gold Plated Brass	1.35:1	No	<a href="#">PE6199</a>	\$29.83	41			
					<a href="#">PE6TR1050</a>	\$16.64	42			
QMA Male	4 GHz		1.2:1	Yes	<a href="#">PE6TR1051</a>	\$23.53	43			
QN Male				No	<a href="#">PE6TR1038</a>	\$53.05	44			
				Gold Plated Brass	1.1:1	No	<a href="#">PE6150</a>		\$7.10	45
SMA Male	6 GHz	Tri-Metal Plated Brass	1.2:1	No	<a href="#">PE6241</a>	\$16.16	46			
				No	<a href="#">PE6TR1014</a>	\$9.32	47			
				Yes	<a href="#">PE6069</a>	\$64.72	48			
	18 GHz	Passivated Stainless Steel	1.25:1	Yes	<a href="#">PE6072</a>	\$96.45	49			
				No	<a href="#">PE6071</a>	\$59.07	50			
				Yes	<a href="#">PE6078</a>	\$119.95	51			
SMA Female	26.5 GHz		1.35:1	No	<a href="#">PE6077</a>	\$119.17	52			
				Yes	<a href="#">PE6078</a>	\$119.95	51			
SMB Plug	4 GHz	Gold Plated Brass	1.2:1	No	<a href="#">PE6TR1037</a>	\$26.55	56			
				No	<a href="#">PE6TR002</a>	\$12.36	57			
SMC Jack	10 GHz		1.35:1	No	<a href="#">PE6TR005</a>	\$9.97	58			

Terminations & Matching Pads



Technical Support  
+1 (949) 261-1920



Same-Day Shipping,  
Even Custom Cable Assemblies

## RF Load

50 Ohm



Max. Power (Watts)	Connector	Maximum Frequency.	Construction Material	VSWR Max.	Chain	Model No	1 Pc. Price	See Web for Volume Pricing	ROW	
1 W	SMP Male	18 GHz	Gold over Nickel Plated Brass	1.2:1	No	<a href="#">PE6TR1039</a>	\$124.63	See Web for Volume Pricing	59	
	SMP Female		Gold Plated Brass	1.2:1	No	<a href="#">PE6161</a>	\$225.86		60	
		27 GHz	Passivated Stainless Steel	1.15:1	No	<a href="#">PE6TR1040</a>	\$58.73		61	
				1.2:1	No	<a href="#">PE6160</a>	\$173.76		62	
		40 GHz	Gold Plated Brass	1.15:1	No	<a href="#">PE6TR1113</a>	\$50.47		63	
				1.2:1	No	<a href="#">PE6TR1114</a>	\$112.27		64	
		SSMC Plug	10 GHz	Gold Plated Brass	1.2:1	No	<a href="#">PE6TR1115</a>		\$163.77	65
					1.3:1	No	<a href="#">PE6TR1116</a>		\$153.47	66
		2 W	2.4mm Male	50 GHz	Passivated Stainless Steel	1.3:1	No		<a href="#">PE6243</a>	\$28.45
	2.4mm Female		1.3:1			No	<a href="#">PE6227</a>		\$338.91	68
2.92mm Male	40 GHz		Passivated Stainless Steel	1.45:1	No	<a href="#">PE6242</a>	\$549.20	69		
				1.25:1	No	<a href="#">PE6180</a>	\$610.10	70		
4.3-10 Male	6 GHz		Passivated Stainless Steel	1.25:1	Yes	<a href="#">PE6177</a>	\$421.20	71		
				1.15:1	No	<a href="#">PE6176</a>	\$371.36	72		
7/16 DIN Male	3 GHz		Silver Plated Brass	1.15:1	Yes	<a href="#">PE6TR1045</a>	\$49.26	73		
				1.1:1	Yes	<a href="#">PE6TR1046</a>	\$46.52	74		
BNC Male	3 GHz		Tri-Metal Plated Brass	1.1:1	Yes	<a href="#">PE6TR1047</a>	\$53.67	75		
				1.15:1	Yes	<a href="#">PE6TR1048</a>	\$54.69	76		
N Male	6 GHz		Tri-Metal Plated Brass	1.1:1	No	<a href="#">PE6190</a>	\$69.64	77		
				1.1:1	No	<a href="#">PE6TR1013</a>	\$72.40	78		
N Female	6 GHz		Tri-Metal Plated Brass	1.2:1	No	<a href="#">PE6196</a>	\$38.00	79		
				1.15:1	No	<a href="#">PE6TR007</a>	\$23.15	80		
QMA Male	3 GHz		Nickel Plated Brass	1.15:1	Yes	<a href="#">PE6TR008</a>	\$25.60	81		
				1.2:1	No	<a href="#">PE6156</a>	\$28.27	82		
SMA Male	18 GHz		Passivated Stainless Steel	1.2:1	No	<a href="#">PE6TR010</a>	\$28.44	83		
				1.1:1	No	<a href="#">PE6154</a>	\$39.92	84		
SMA Female	18 GHz		Passivated Stainless Steel	1.2:1	No	<a href="#">PE6248</a>	\$29.60	85		
				1.3:1	No	<a href="#">PE6249</a>	\$20.95	86		
TNC Male	6 GHz	Tri-Metal Plated Brass	1.2:1	No	<a href="#">PE6TR009</a>	\$19.62	87			
			1.3:1	No	<a href="#">PE6TR012</a>	\$24.61	88			
TNC Female	6 GHz	Tri-Metal Plated Brass	1.3:1	Yes	<a href="#">PE6075</a>	\$94.56	89			
			1.2:1	No	<a href="#">PE6009</a>	\$58.59	90			
SMA Male	26.5 GHz	Gold Plated Stainless Steel	1.2:1	No	<a href="#">PE6TR011</a>	\$27.94	91			
			1.3:1	Yes	<a href="#">PE6076</a>	\$153.34	92			
SMA Female	18 GHz	Passivated Stainless Steel	1.3:1	No	<a href="#">PE6032</a>	\$85.98	93			
			1.1:1	No	<a href="#">PE6TR1052</a>	\$16.97	94			
TNC Male	6 GHz	Tri-Metal Plated Brass	1.15:1	No	<a href="#">PE6TR1036</a>	\$37.91	95			
			1.3:1	Yes	<a href="#">PE6082</a>	\$78.42	96			
TNC Female	6 GHz	Tri-Metal Plated Brass	1.3:1	No	<a href="#">PE6081</a>	\$57.98	97			
			1.35:1	Yes	<a href="#">PE6TR675</a>	\$97.14	98			
SMA Male	18 GHz	Passivated Stainless Steel	1.35:1	Yes	<a href="#">PE6TR677</a>	\$93.51	99			
			1.35:1	No	<a href="#">PE6TR671</a>	\$76.50	1			
SMA Female	18 GHz	Passivated Stainless Steel	1.35:1	No	<a href="#">PE6TR673</a>	\$87.97	2			
			1.3:1	Yes	<a href="#">PE6084</a>	\$107.54	3			
TNC Male	6 GHz	Tri-Metal Plated Brass	1.3:1	No	<a href="#">PE6083</a>	\$78.33	4			
			1.2:1	Yes	<a href="#">PE6TR014</a>	\$19.99	5			
TNC Female	6 GHz	Tri-Metal Plated Brass	1.35:1	No	<a href="#">PE6172</a>	\$20.57	6			
			1.35:1	No	<a href="#">PE6TR016</a>	\$14.76	7			
SMA Male	40 GHz	Black Anodized Aluminum Heatsink	1.25:1	Yes	<a href="#">PE6090</a>	\$143.94	8			
			1.25:1	No	<a href="#">PE6089</a>	\$136.24	9			
7/16 DIN Male	7 GHz	Tri-Metal Plated Brass	1.25:1	No	<a href="#">PE6229</a>	\$32.54	10			
			1.3:1	No	<a href="#">PE6TR015</a>	\$26.50	11			
5 W	2.92mm Male	40 GHz	Black Anodized Aluminum Heatsink	1.25:1	Yes	<a href="#">PE6092</a>	\$229.54	12		
				1.25:1	No	<a href="#">PE6091</a>	\$159.83	13		
5 W	7/16 DIN Male	7 GHz	Tri-Metal Plated Brass	1.35:1	No	<a href="#">PE6TR028</a>	\$787.06	14		
				1.25:1	No	<a href="#">PE6100</a>	\$224.77	15		

Terminations & Matching Pads

## RF Load

50 Ohm



Max. Power (Watts)	Connector	Maximum Frequency.	Construction Material	VSWR Max.	Chain	Model No	1 Pc. Price	See Web for Volume Pricing	ROW
5 W	7/16 DIN Female	7 GHz	Tri-Metal Plated Brass		No	<a href="#">PE6139</a>	\$223.45	See Web for Volume Pricing	16
	N Male	3 GHz	Aluminum	1.15:1		<a href="#">PE6187</a>	\$39.35		17
		6 GHz			<a href="#">PE6186</a>	\$87.43	18		
	N Female	18 GHz	Black Anodized Aluminum Heatsink	1.25:1	No	<a href="#">PE6097</a>	\$151.33		19
	SMA Male				No	<a href="#">PE6098</a>	\$183.62		20
	SMA Female				No	<a href="#">PE6095</a>	\$128.43		21
	TNC Male				No	<a href="#">PE6096</a>	\$196.97		22
TNC Female	No				<a href="#">PE6099</a>	\$186.39	23		
10 W	7/16 DIN Male	7 GHz	Black Anodized Aluminum Heatsink	1.25:1	No	<a href="#">PE6138</a>	\$212.97	24	
	7/16 DIN Female				No	<a href="#">PE6105</a>	\$349.93	25	
	BNC Male	4 GHz		No	<a href="#">PE6141</a>	\$338.93	26		
	BNC Female			No	<a href="#">PE6034</a>	\$187.63	27		
	N Male	6 GHz		1.15:1	No	<a href="#">PE6101</a>	\$251.38	28	
					No	<a href="#">PE6185</a>	\$119.10	29	
	N Female	18 GHz		1.4:1	No	<a href="#">PE6035</a>	\$273.05	30	
	SMA Male				No	<a href="#">PE6102</a>	\$307.09	31	
	SMA Female				No	<a href="#">PE6036</a>	\$211.22	32	
	TNC Male				No	<a href="#">PE6103</a>	\$283.90	33	
	TNC Female				No	<a href="#">PE6104</a>	\$284.27	34	
20 W	4.1/9.5 Mini DIN Male	2.7 GHz	Black Anodized Aluminum	1.33:1		<a href="#">PE6140</a>	\$358.97	35	
	4.3-10 Male				<a href="#">PE6TR1022</a>	\$471.59	36		
	7/16 DIN Male				<a href="#">PE6TR1023</a>	\$490.46	37		
	N Male				<a href="#">PE6TR1021</a>	\$429.31	38		
25 W	7/16 DIN Male	7 GHz	Black Anodized Aluminum Heatsink	1.25:1	No	<a href="#">PE6TR1020</a>	\$446.06	39	
	7/16 DIN Female	8 GHz		1.6:1	<a href="#">PE6107</a>	\$465.01	40		
		3 GHz		1.6:1	<a href="#">PE6209</a>	\$344.24	41		
	N Male	18 GHz		1.2:1	No	<a href="#">PE6210</a>	\$344.24	42	
				1.6:1	<a href="#">PE6228</a>	\$146.40	43		
	1.6:1			No	<a href="#">PE6205</a>	\$462.78	44		
	1.4:1			<a href="#">PE6106</a>	\$497.23	45			
	1.6:1			<a href="#">PE6206</a>	\$448.31	46			
	N Female	1.4:1		No	<a href="#">PE6037</a>	\$595.46	47		
	SMA Male	1.6:1		<a href="#">PE6203</a>	\$456.61	48			
	SMA Female	1.6:1		<a href="#">PE6204</a>	\$409.65	49			
TNC Male	1.4:1	No	<a href="#">PE6038</a>	\$538.77	50				
TNC Female	1.6:1	<a href="#">PE6207</a>	\$490.32	51					
30 W	SMA Female	4.2 GHz	Chem Film Plated Aluminum	1.25:1		<a href="#">PE6208</a>	\$446.25	52	
					<a href="#">PE6TR1000</a>	\$212.13	53		
40 W	4.1/9.5 Mini DIN Male	2.7 GHz	Black Anodized Aluminum	1.15:1		<a href="#">PE6TR1026</a>	\$656.45	54	
	4.3-10 Male				<a href="#">PE6TR1027</a>	\$670.05	55		
	7/16 DIN Male				<a href="#">PE6TR1025</a>	\$500.85	56		
	N Male				<a href="#">PE6TR1024</a>	\$500.85	57		
50 W	7/16 DIN Male	2.7 GHz	Aluminum	1.2:1	No	<a href="#">PE6238</a>	\$821.68	58	
		3 GHz	Black Anodized Aluminum Heatsink	1.15:1		<a href="#">PE6191</a>	\$379.66	59	
		4 GHz		1.25:1	No	<a href="#">PE6169</a>	\$510.98	60	
	8 GHz	1.6:1		<a href="#">PE6217</a>	\$529.20	61			
	7/16 DIN Female	3 GHz	1.1:1	<a href="#">PE6218</a>	\$605.39	62			
		4 GHz	1.2:1	<a href="#">PE6189</a>	\$254.29	63			
	N Male	8.5 GHz	1.3:1	No	<a href="#">PE6188</a>	\$371.67	64		
		18 GHz	1.6:1	<a href="#">PE6TR029</a>	\$303.37	65			
			1.6:1	<a href="#">PE6213</a>	\$533.35	66			
	N Female	3 GHz	1.45:1	No	<a href="#">PE6198</a>	\$463.73	67		
			1.25:1	<a href="#">PE6233</a>	\$291.41	68			
		18 GHz	1.1:1	<a href="#">PE6234</a>	\$202.14	69			
			1.6:1	<a href="#">PE6214</a>	\$525.58	70			
1.45:1			No	<a href="#">PE6039</a>	\$642.93	71			
SMA Male	1.6:1	<a href="#">PE6211</a>	\$541.14	72					
SMA Female	3 GHz	Nickel Plated Brass	1.25:1	<a href="#">PE6232</a>	\$219.12	73			

Terminations & Matching Pads



Technical Support  
+1 (949) 261-1920



Same-Day Shipping,  
Even Custom Cable Assemblies



## RF Load

### 50 Ohm



Max. Power (Watts)	Connector	Maximum Frequency.	Construction Material	VSWR Max.	Chain	Model No	1 Pc. Price	See Web for Volume Pricing			ROW				
50 W	SMA Female	6 GHz	Chem Film Plated Aluminum	1.25:1		<a href="#">PE6TR1001</a>	\$439.78				74				
		18 GHz	Black Anodized Aluminum Heatsink	1.6:1		<a href="#">PE6212</a>	\$511.02				75				
	1.45:1			No	<a href="#">PE6040</a>	\$716.94				76					
	1.6:1				<a href="#">PE6215</a>	\$497.63				77					
	TNC Male					<a href="#">PE6216</a>	\$539.99				78				
	TNC Female					<a href="#">PE6TR1030</a>	\$572.41				79				
60 W	4.1/9.5 Mini DIN Male	2.7 GHz	Black Anodized Aluminum	1.15:1		<a href="#">PE6TR1031A</a>	\$708.36				80				
	4.3-10 Male				<a href="#">PE6TR1029</a>	\$691.38				81					
	7/16 DIN Male				<a href="#">PE6TR1028</a>	\$554.52				82					
	N Male				<a href="#">PE6TR1035A</a>	\$943.18				83					
100 W	4.3-10 Female	2.7 GHz	Black Anodized Aluminum	1.2:1	No	<a href="#">PE6TR1035F</a>	\$943.18				84				
	7/16 DIN Male				<a href="#">PE6TR1033A</a>	\$804.95				85					
					<a href="#">PE6197</a>	\$374.98				86					
		3 GHz	Black Anodized Aluminum Heatsink	1.35:1	No	<a href="#">PE6137</a>	\$940.98				87				
		2 GHz				<a href="#">PE6TR1033F</a>	\$804.95				88				
		7/16 DIN Female	2.7 GHz	Black Anodized Aluminum	1.2:1	No	<a href="#">PE6239</a>	\$1,173.82				89			
		BNC Female				2 GHz	Black Anodized Aluminum Heatsink	No	<a href="#">PE6041</a>	\$924.98	See Web for Volume Pricing			90	
		N Male	2.7 GHz	Black Anodized Aluminum			<a href="#">PE6TR1032A</a>	\$804.95						91	
			4 GHz	Black Anodized Aluminum Heatsink	No	<a href="#">PE6168</a>	\$571.23							92	
		N Female	2.7 GHz	Black Anodized Aluminum	1.5:1		<a href="#">PE6TR1032F</a>	\$848.87						93	
						<a href="#">PE6222</a>	\$721.25							94	
		SMA Male	8 GHz	Black Anodized Aluminum Heatsink	1.3:1	No	<a href="#">PE6219</a>	\$759.32						95	
		SMA Female	2 GHz				<a href="#">PE6043</a>	\$976.50						96	
			6 GHz	Chem Film Plated Aluminum	1.25:1		<a href="#">PE6TR1002</a>	\$449.99						97	
	TNC Female	8 GHz	Black Anodized Aluminum Heatsink	1.5:1		<a href="#">PE6220</a>	\$677.96							98	
					<a href="#">PE6224</a>	\$517.64				99					
150 W	SMA Female	3 GHz	Chem Film Plated Aluminum	1.3:1		<a href="#">PE6TR1003</a>	\$442.61							1	
200 W	N Male	3 GHz	Black Anodized Aluminum Heatsink	1.25:1	No	<a href="#">PE6230</a>	\$619.78							2	
	N Female				<a href="#">PE6231</a>	\$639.15				3					
300 W	N Female	3 GHz	Chem Film Plated Aluminum	1.3:1		<a href="#">PE6TR1004</a>	\$570.99							4	
500 W	N Female	1.2 GHz	Chem Film Plated Aluminum	1.25:1		<a href="#">PE6TR1005</a>	\$555.88				5				
800 W	N Female	500 MHz	Chem Film Plated Aluminum	1.5:1		<a href="#">PE6TR1006</a>	\$702.88				6				

### 75 Ohm



Max. Power (Watts)	Connector	Maximum Frequency.	Construction Material	VSWR Max.	Chain	Model No	1-24	25-49	50-99	100+	ROW
0.25 W	F Male	3 GHz	Nickel Plated Zinc			<a href="#">PE6202-100PK</a>	\$76.04	\$72.24	\$68.44	\$65.39	7
						<a href="#">PE6202-25PK</a>	\$22.09	\$20.99	\$19.88	\$19.00	8
					No	<a href="#">PE6202</a>	\$1.28	\$1.22	\$1.15	\$1.10	9
1 W	BNC Male	1,000 MHz	Nickel Plated Brass		No	<a href="#">PE6165</a>	\$17.31	\$16.44	\$15.58	\$14.89	10
		2 GHz	Tri-Metal Plated Brass	1.35:1	No	<a href="#">PE6TR004</a>	\$64.61	\$61.38	\$58.15	\$55.56	11
2 W	BNC Male	2 GHz		1.2:1	No	<a href="#">PE6TR040</a>	\$19.55	\$18.57	\$17.60	\$16.81	12
	BNC Female				1.15:1	No	<a href="#">PE6TR003</a>	\$65.84	\$62.55	\$59.26	\$56.62

Terminations & Matching Pads

## Feed-Thru Load

### 50 Ohm



Max. Power (Watts)	Connector Input	Connector Output	Maximum Frequency.	Construction Material	VSWR Max.	Chain	Model No	1 Pc. Price	See Web for Volume Pricing			ROW
2 W	BNC Male	BNC Female	1,000 MHz	Tri-Metal Plated Brass	1.3:1	No	<a href="#">PE6TR000</a>	\$52.48	See Web for Volume Pricing			14
	N Male	N Female		Nickel Plated Brass	1.65:1	No	<a href="#">PE6033</a>	\$153.34				15
	SMA Male	SMA Female		Passivated Stainless Steel	1.25:1	No	<a href="#">PE6026</a>	\$91.81				16

### 75 Ohm



Max. Power (Watts)	Connector Input	Connector Output	Maximum Frequency.	Construction Material	VSWR Max.	Chain	Model No	1-24	25-49	50-99	100+	ROW
2 W	BNC Male	BNC Female	1,000 MHz	Tri-Metal Plated Brass	1.3:1	No	<a href="#">PE6TR001</a>	\$37.24	\$35.38	\$33.52	\$32.03	17

## Resistive Impedance Transformers



Model No	Connector A 50 Ω	Connector B 75 Ω	Max. Frequency (MHz.)	VSWR Max.	Attenuation Loss (dB)	Accuracy (dB)	1 Pc. Price	See Web for Volume Pricing			ROW
<a href="#">PE7006</a>	BNC Male	BNC Female	2,000	1.2:1		±0.5	\$65.80	See Web for Volume Pricing			18
<a href="#">PE7007</a>	BNC Male	BNC Female	2,000	1.2:1	6		\$62.84				19
<a href="#">PE7067</a>	BNC Male	F Male	3,000	1.25:1	5.7	±0.5	\$129.49				20
<a href="#">PE7066</a>	BNC Male	F Female	3,000	1.25:1		±0.5	\$147.15				21
<a href="#">PE7068</a>	BNC Female	F Male	3,000	1.25:1		±0.5	\$140.35				22
<a href="#">PE7072</a>	N Male	F Male	3,000	1.25:1		±0.5	\$151.12				23
<a href="#">PE70MP1002</a>	N Male	F Female	3,000				\$131.27				24
<a href="#">PE7071</a>	N Male	F Female	3,000	1.25:1		±0.5	\$113.68				25
<a href="#">PE7027</a>	N Male	N Female	2,000	1.2:1		±0.5	\$129.26				26
<a href="#">PE7070</a>	N Male	N Female	3,000	1.35:1		±0.5	\$129.69				27
<a href="#">PE7073</a>	N Female	F Male	3,000	1.25:1		±0.5	\$190.64				28
<a href="#">PE70MP1001</a>	N Female	F Female	3,000				\$169.34				29
<a href="#">PE7074</a>	N Female	F Female	3,000	1.25:1		±0.5	\$155.34				30
<a href="#">PE7028</a>	N Female	N Male	500	1.35:1		±0.5	\$29.40				31
<a href="#">PE7083</a>	N Female	N Male	3,000	1.35:1		±0.5	\$169.68				32
<a href="#">PE70MP1007</a>	SMA Male	F Male	3,000				\$106.82				33
<a href="#">PE7075</a>	SMA Male	F Male	3,000	1.25:1		±0.5	\$162.56				34
<a href="#">PE70MP1006</a>	SMA Male	F Female	3,000				\$116.09				35
<a href="#">PE7076</a>	SMA Male	F Female	3,000	1.25:1		±0.5	\$118.60				36
<a href="#">PE70MP1005</a>	SMA Female	F Male	3,000				\$106.82				37
<a href="#">PE7077</a>	SMA Female	F Male	3,000	1.25:1		±0.5	\$107.70				38
<a href="#">PE70MP1004</a>	SMA Female	F Female	3,000				\$126.74				39
<a href="#">PE7078</a>	SMA Female	F Female	3,000	1.25:1		±0.5	\$129.50				40
<a href="#">PE7079</a>	TNC Male	F Female	3,000	1.25:1	5.7	±0.5	\$169.34				41
<a href="#">PE7081</a>	TNC Female	F Male	3,000	1.25:1	5.7	±0.5	\$171.89				42
<a href="#">PE7082</a>	TNC Female	F Female	3,000	1.25:1	5.7	±0.5	\$117.84				43

Terminations & Matching Pads

# INDEX GUIDE TO TEST AND MEASUREMENT PRODUCTS

<b>TEST AND MEASUREMENT PRODUCTS.....</b>	<b>348</b>
<b>1.0MM FLEXIBLE VNA 110 GHZ PRECISION CABLES.....</b>	<b><a href="#">352</a></b>
<b>26.5 GHZ &amp; 40 GHZ TEST CABLES.....</b>	<b><a href="#">354</a></b>
<b>4 - IN - 1 CALIBRATION KITS.....</b>	<b><a href="#">349</a></b>
<b>40 GHZ SKEW MATCHED CABLES.....</b>	<b><a href="#">350</a></b>
<b>50 GHZ &amp; 67 GHZ TEST CABLE ASSEMBLIES.....</b>	<b><a href="#">351</a></b>
<b>75 OHM TEST CABLE ASSEMBLIES.....</b>	<b><a href="#">354</a></b>
<b>CALIBRATION KITS.....</b>	<b><a href="#">348</a></b>
<b>COAXIAL RF PROBES &amp; PROBE POSITIONING HARDWARE.....</b>	<b><a href="#">349</a></b>
<b>HANDHELD RF ANALYZER RUGGED PHASE STABLE CABLE ASSEMBLIES.....</b>	<b><a href="#">350</a></b>
<b>PE-TC151 SERIES PHASE STABLE TEST CABLE ASSEMBLIES.....</b>	<b><a href="#">353</a></b>
<b>PE-TC195 SERIES PHASE STABLE TEST CABLE ASSEMBLIES.....</b>	<b><a href="#">353</a></b>
<b>RUGGEDIZED VNA CABLE ASSEMBLIES.....</b>	<b><a href="#">351</a></b>
<b>SEMI-RIGID PIGTAIL TEST PROBES.....</b>	<b><a href="#">354</a></b>
<b>VNA TEST CABLES.....</b>	<b><a href="#">349</a></b>

## CALIBRATION KITS

### Bench Type Calibration Kits



Connector Series	Impedance (Ohms)	Frequency Range (GHz)	Cal Type	Model No	1 Pc. Price	See Web for Volume Pricing	R O W
2.4mm	50	DC to 50	SOL	<a href="#">PE5CK1015</a>	\$8,549.00	See Web for Volume Pricing	
2.92mm			SOLT	<a href="#">PE5CK1016</a>	\$11,514.07		2
		DC to 40	SOL	<a href="#">PE5CK1017</a>	\$12,346.61		3
3.5mm			DC to 8.5	SOLT	<a href="#">PE5CK1018</a>		\$14,372.11
		SOLT		<a href="#">PE5CK1001</a>	\$3,633.44		5
		DC to 26.5	SOL	<a href="#">PE5500-KIT</a>	\$4,546.17		6
			SOLT	<a href="#">PE5CK1000</a>	\$5,484.45		7
			SOL	<a href="#">PE5CK1019</a>	\$6,995.76		8
			SOLT	<a href="#">PE5CK1020</a>	\$7,743.11		9
7/16 DIN		DC to 7.5	SOL	<a href="#">PE5CK1021</a>	\$9,358.71		10
			SOLT	<a href="#">PE5CK1022</a>	\$13,820.83		11
7mm		DC to 18	SOL	<a href="#">PE5CK1023</a>	\$6,463.91		12
BNC				<a href="#">PE5CK1024</a>	\$7,772.78		13
N		DC to 18	SOLT	<a href="#">PE5501-KIT</a>	\$5,910.34		14
	<a href="#">PE5CK1025</a>			\$5,353.49	15		
	<a href="#">PE5CK1026</a>			\$7,342.75	16		
F	75	DC to 3	SOLT	<a href="#">PE5CK1002</a>	\$2,716.35	17	
				<a href="#">PE70MP5000</a>	\$4,700.78	18	

**Test & Measurement**

## VNA TEST CABLES

### For Use With Interchangeable Connectors



Impedance (Ohms)	Connector Series	Frequency Range (GHz)	Type	Model No	1	2-4	5-9	10+	R O W
50	3.5mm NMD Female	DC - 26.5	Cable for Interchangeable Connectors	<a href="#">PE310-KIT</a>	\$5,550.61	\$5,356.34	\$5,162.07	\$4,995.55	19

### Interchangeable Connectors



Impedance (Ohms)	Connector Series	Frequency Range (GHz)	Gender	Polarity	Type	Model No	1 Pc. Price	See Web for Volume Pricing	R O W
50	3.5mm	DC - 26.5	Female	Standard	Connector	<a href="#">PE44488</a>	\$661.67	See Web for Volume Pricing	20
			Male			<a href="#">PE44487</a>	\$696.53		
	N	DC - 18	Female			<a href="#">PE44486</a>	\$417.48		
			Male			<a href="#">PE44485</a>	\$467.49		

## 4 - IN - 1 CALIBRATION KITS

### Product Features

- Lightweight Portable 4-in-1 Package
- Precision 3.5mm Connectors
- Gold Plated Short Open Load Thru
- Supports 26.5 GHz SOLT Calibration
- Calibration Coefficients on Data Sheet



Connector 1	Impedance (Ohms)	Freq. Range (GHz)	Weight (lbs.)	Model No	1	2-4	5-9	10+	R O W
3.5mm Female Short Open Load Thru	50	DC to 26.5	2.752	<a href="#">PE5CK1012</a>	\$4,067.45	\$3,904.75	\$3,742.05	\$3,579.36	24
3.5mm Male Short Open Load Thru				<a href="#">PE5CK1013</a>	\$4,120.52	\$3,955.70	\$3,790.88	\$3,626.06	25

## COAXIAL RF PROBES & PROBE POSITIONING HARDWARE

### Product Features

**PCB RF Probe Positioner ([PE5TL1000](#)): \$1,269.78**

- RF PCB probe positioner holds coaxial probes
- Magnetic mounting plate
- On-Off positioner switch
- Articulated joints
- Multi-axis positioner control

**Coaxial RF Microwave GS and GSG Probe Series ([PE2PB1000-PE2PB1003](#)):**

- Max. Operating Frequency of 20 GHz
- RF probe Return Loss better than 10 dB
- GS and GSG Probes Feature Gold Plated Contacts
- Compliant coaxial GSG (or GS) pogo pins



## RF MICROWAVE PROBES

Probe Tip Config.	Number of Ground	Pitch 1 (µm)	Pitch 2 (µm)	Connector 1	Imp. (Ω)	Freq. Max (GHz)	RL Max (dB)	IL Max (dB)	Model No	1-4	5-9	10-24	25+	R O W
GS	1	800		2.92mm Female	50	40	10	0.5	<a href="#">PE2PB1006</a>	\$882.24	\$838.13	\$794.02	\$758.73	26
				3.5mm Female					<a href="#">PE2PB1002</a>	\$630.58	\$599.05	\$567.52	\$542.30	27
	2	1500	2,500	2.92mm Female					<a href="#">PE2PB1007</a>	\$908.39	\$862.97	\$817.55	\$781.22	28
				3.5mm Female					<a href="#">PE2PB1003</a>	\$649.28	\$616.82	\$584.35	\$558.38	29
GSG	2	800		2.92mm Female	50	40	10	0.5	<a href="#">PE2PB1004</a>	\$947.81	\$900.42	\$853.03	\$815.12	30
				3.5mm Female					<a href="#">PE2PB1000</a>	\$677.30	\$643.44	\$609.57	\$582.48	31
	4	1500	2,500	2.92mm Female					<a href="#">PE2PB1005</a>	\$973.96	\$925.26	\$876.56	\$837.61	32
				3.5mm Female					<a href="#">PE2PB1001</a>	\$695.99	\$661.19	\$626.39	\$598.55	33



## 40 GHZ SKEW MATCHED CABLES



### Product Features

- 1 ps Delay match
- Excellent VSWR of 1.4:1
- 100% tested up to 40 GHz
- Extremely Flexible
- Polarity indicators on cable ends

Connector 1	Connector 2	Max Frequency (GHz)	Max VSWR	Typ Insertion Loss (dB/ft)	Model No	1	2-4	5-9	10+	ROW
2.92mm Male	2.92mm Male	40	1.4:1	1.4	<a href="#">PE3C4680-12</a>	\$1,173.34	\$1,126.41	\$1,079.47	\$1,032.54	34
				2.8	<a href="#">PE3C4680-24</a>	\$1,300.04	\$1,248.04	\$1,196.04	\$1,144.04	35
				5.6	<a href="#">PE3C4680-48</a>	\$1,553.43	\$1,491.29	\$1,429.16	\$1,367.02	36

## HANDHELD RF ANALYZER RUGGED PHASE STABLE CABLE ASSEMBLIES

### Product Features

- Designed for in-field measurements with handheld or portable analyzers
- Excellent VSWR as low as 1.2:1
- Excellent Phase Stability with Flexure as low as 1.5 degrees
- Rugged Armor provides 1200 p.s.i crush resistance plus torque resistance
- UV resistance jacket
- Each assembly is serialized and includes test data



Connector 1	Connector 2	Freq. Max (GHz)	Imp (Ohm)	VSWR	IL @fmax (dB/ft)	Phase Stability with Flexure (Degrees)	Length (in)	Model No	1 Pc. Price	See Web for Volume Pricing	ROW		
N Male	7/16 DIN Male	7	50	1.2:1	2.16	1.5	60.0	<a href="#">PE3C4000-60</a>	\$657.16	See Web for Volume Pricing	37		
	7/16 DIN Female				4.92		144.0	<a href="#">PE3C4000-144</a>	\$861.72		38		
		N Male			2.16		60.0	<a href="#">PE3C4001-60</a>	\$928.81		39		
	N Male Right Angle				4.92		144.0	<a href="#">PE3C4001-144</a>	\$1,157.97				
		N Male			9		2.52	60.0	<a href="#">PE3C4002-60</a>		\$536.42	40	
	N Female						5.74	144.0	<a href="#">PE3C4002-144</a>		\$791.30		
		N Male			18		2.52	60.0	<a href="#">PE3C4003-60</a>		\$824.84	41	
	N Female						5.74	144.0	<a href="#">PE3C4003-144</a>		\$1,136.07		
		N Male			27		2.52	60.0	<a href="#">PE3C4004-60</a>		\$536.42	42	
	N Female						5.74	144.0	<a href="#">PE3C4004-144</a>		\$791.30		
		N Male			39.4		1.3:1	2.66	39.4		2.0	<a href="#">PE3C4005-100CM</a>	\$648.53
	<a href="#">PE3C4006-100CM</a>											\$871.78	
	N Male	60.0			3.89		2.0	60.0	<a href="#">PE3C4007-100CM</a>		\$690.69	44	
									<a href="#">PE3C4008-60</a>		\$747.71		
	SMA Male	SMA Female			18		1.3:1	3.89	60.0		<a href="#">PE3C4009-60</a>	\$747.71	45
											<a href="#">PE3C4010-60</a>	\$1,046.18	
TNC Male	TNC Female	18	1.3:1	3.89	60.0	<a href="#">PE3C4011-60</a>	\$1,046.18	46					
						<a href="#">PE3C4012-100CM</a>	\$945.57						
3.5mm Male	3.5mm Female	27	1.3:1	3.46	39.4	4.0	<a href="#">PE3C4013-100CM</a>	\$945.57	47				
3.5mm Female							<a href="#">PE3C4013-100CM</a>	\$945.57		48			
										49			
										50			

Test & Measurement

## RUGGEDIZED VNA TEST CABLE ASSEMBLIES

See Our Website For Current Pricing & Real-Time Stock Availability!



### Product Features

- Rugged VNA test port extenders
- Torsion resistant connector heads
- Max phase variation +/- 2° with flexure to 18 GHz
- Max phase variation +/- 3° with flexure to 26.5 GHz
- Max phase variation +/- 5° with flexure to 40 GHz
- 5,000 mating cycles minimum
- 75,000 flexure cycles minimum
- Each cable is serialized and comes with RF test data
- SMA, Type-N, 2.92mm and 2.4mm configurations available

Pasternack's ruggedized VNA test cables are designed to provide customers with repeatable accurate VNA measurements. These test cables have excellent electrical properties including low insertion loss, low VSWR and phase stability of +/- 2° to 18 GHz with flexure. Torsion resistant connector heads are directly attached to stainless steel conduit style armoring providing a rugged design for up to 5,000 mating cycles with proper care. The cable armoring enhances amplitude and phase stability by preventing stress due to over bending while maintaining the flexibility required for testing in a lab environment. When used with the appropriate calibration kit these test cables effectively extend the test port of the VNA allowing for accurate measurements of devices that cannot be directly connected to a Network Analyzer test port.

Connector 1	Connector 2	Freq. Max (GHz)	Imp (Ohm)	VSWR	IL (dB/ft)	IL (dB/m)	Phase Stability with Flexure (Degrees)	Flex Cycles	Model No	1 Pc. Price	See Web for Volume Pricing	ROW				
2.4mm Male	2.4mm Female	40	50	1.38:1	0.83	2.72	5	---	<a href="#">PE3VNA4005-24</a>	\$2,292.19	See Web for Volume Pricing	51				
	2.4mm Male								<a href="#">PE3VNA4004-24</a>	\$2,138.38		52				
2.92mm Male	2.92mm Female	26.5							1.25:1	0.64		2.1	3	<a href="#">PE3VNA2606-24</a>	\$1,649.29	53
		40							1.38:1	0.83		2.72	5	<a href="#">PE3VNA4002-24</a>	\$2,155.32	54
	2.92mm Male	26.5							1.25:1	0.64		2.1	3	<a href="#">PE3VNA2605-24</a>	\$1,616.99	55
		40							1.38:1	0.83		2.72	5	<a href="#">PE3VNA4001-24</a>	\$2,087.53	56
3.5mm Male	3.5mm Female	26.5		1.3:1	0.64	2.1	3	<a href="#">PE3VNA2604-24</a>	\$1,616.99	57						
	3.5mm Male			<a href="#">PE3VNA2603-24</a>				\$1,584.74	58							
N Male	N Female	18		1.25:1	0.52	1.71	2	<a href="#">PE3VNA1804-24</a>	\$874.60	59						
	N Male							<a href="#">PE3VNA1803-24</a>	\$858.46	60						
SMA Male	SMA Female							<a href="#">PE3VNA1802-24</a>	\$858.46	61						
	SMA Male							<a href="#">PE3VNA1801-24</a>	\$842.31	62						

See Web for other lengths

## 50 AND 67 GHZ TEST CABLE ASSEMBLIES

### Product Features

- Highly flexible VNA test cables up to 50 and 67 GHz
- Max phase variation +/- 6° to 50 GHz and +/- 8° to 67 GHz with flexure
- VSWR of 1.3:1 to 50 GHz and 1.4:1 to 67 GHz
- Rated up to 5,000 mating cycles
- Up to 100,000 flex cycles
- Swept right angle connector options available
- Highly flexible stainless steel braided armoring
- Designed for accurate and repeatable measurements



Test & Measurement

Connector 1	Connector 2	Freq. Max (GHz)	Imp (Ohm)	VSWR	IL @fmax (dB/ft)	Phase Stability with Flexure (Degrees)	Flex Cycles	Model No	1	2-4	5-9	10+	ROW
2.4mm Male	2.4mm Male	50	50	1.300	3.7	6.00	100,000	<a href="#">PE3TC0500-24</a>	\$3,024.23	\$2,903.26	\$2,782.29	\$2,661.32	63
					7			<a href="#">PE3TC0500-48</a>	\$3,179.00	\$3,051.84	\$2,924.68	\$2,797.52	

Continued on Next Page



Technical Support  
+1 (949) 261-1920



Same-Day Shipping,  
Even Custom  
Cable Assemblies

## 50 AND 67 GHZ TEST CABLE ASSEMBLIES

### Product Features

- Highly flexible VNA test cables up to 50 and 67 GHz
- Max phase variation +/- 6° to 50 GHz and +/- 8° to 67 GHz with flexure
- VSWR of 1.3:1 to 50 GHz and 1.4:1 to 67 GHz
- Rated up to 5,000 mating cycles
- Up to 100,000 flex cycles
- Swept right angle connector options available
- Highly flexible stainless steel braided armoring
- Designed for accurate and repeatable measurements



Connector 1	Connector 2	Freq. Max (GHz)	Imp (Ohm)	VSWR	IL @fmax (dB/ft)	Phase Stability with Flexure (Degrees)	Flex Cycles	Model No	1	2-4	5-9	10+	ROW
2.4mm Male	2.4mm Female	50		1.300	3.7	6.00	100,000	<a href="#">PE3TC0600-24</a>	\$3,024.23	\$2,903.26	\$2,782.29	\$2,661.32	64
					7			<a href="#">PE3TC0600-48</a>	\$3,179.00	\$3,051.84	\$2,924.68	\$2,797.52	
	2.4mm Male Right Angle				3.7			<a href="#">PE3TC0700-24</a>	\$3,537.13	\$3,395.64	\$3,254.16	\$3,112.67	65
					7			<a href="#">PE3TC0700-48</a>	\$3,688.49	\$3,540.95	\$3,393.41	\$3,245.87	
1.85mm Male	1.85mm Male	67		1.400	4.3	8.00	100,000	<a href="#">PE3TC0800-24</a>	\$3,127.53	\$3,002.43	\$2,877.33	\$2,752.23	66
					8.2			<a href="#">PE3TC0800-48</a>	\$3,279.23	\$3,148.06	\$3,016.89	\$2,885.72	
	1.85mm Female				4.3			<a href="#">PE3TC0900-24</a>	\$3,127.53	\$3,002.43	\$2,877.33	\$2,752.23	67
					8.2			<a href="#">PE3TC0900-48</a>	\$3,279.23	\$3,148.06	\$3,016.89	\$2,885.72	
	1.85mm Male				4.3			<a href="#">PE3TC0800-500CM</a>	Call	Call	Call	Call	68
					8.2			<a href="#">PE3TC1000-24</a>	\$3,637.51	\$3,492.01	\$3,346.51	\$3,201.01	
	1.85mm Male Right Angle				4.3			<a href="#">PE3TC1000-48</a>	\$3,792.44	\$3,640.74	\$3,489.04	\$3,337.35	69
					8.2								

## 1.0MM FLEXIBLE VNA 110 GHZ PRECISION CABLES

### Product Features

- Operating to 110 GHz
- Lightweight, protective armoring
- Precision 1.0mm stainless steel connectors
- Non-conductive protective Nome® outer sleeve
- Easy assembly is serialized and includes test data



Connector 1	Connector 2	Freq. Max (GHz)	Imp (Ohm)	VSWR	IL @fmax (dB/ft)	Phase Stability with Flexure (Degrees)	Length (in)	Model No	1	2-4	5-9	10+	ROW
1.0mm Male	1.0mm Male	110	50	1.5	3.12	1.5	6.0	<a href="#">PE3TC1220-6</a>	\$6,373.75	\$6,118.80	\$5,863.85	\$5,608.90	70
					5.62		<a href="#">PE3TC1220-12</a>	\$8,529.33	\$8,188.16	\$7,846.98	\$7,505.81		
	1.0mm Female				3.12		<a href="#">PE3TC1221-6</a>	\$6,373.75	\$6,150.67	\$5,927.59	\$5,736.38	71	
					5.62		<a href="#">PE3TC1221-12</a>	\$6,652.90	\$6,420.05	\$6,187.20	\$5,987.61		

## PE-TC195 SERIES PHASE STABLE TEST CABLE ASSEMBLIES

### Product Features

- Phase and amplitude stability with flexure
- Small diameter, lighter weight and lower profile for high density test applications
- Phase change with flexure +/-2° to 18 GHz
- Excellent for multi-port test equipment
- Very flexible and durable cable with a min. bend radius of 1 inch
- Excellent VSWR and insertion loss
- Extra strain relief for extended connector body with booting to enhance stability and longevity
- Each serialized assembly comes with matching test data
- 5,000 mating cycles when properly mated
- In-Stock and ready to ship



See Our Website For Current Pricing & Real-Time Stock Availability!

Connector 1	Connector 2	Freq. Max (GHz)	Imp (Ohm)	VSWR	IL (dB/ft)	IL (dB/m)	Phase Stability with Flexure (Degrees)	Flex Cycles	Model No	1 Pc. Price	See Web for Volume Pricing	ROW
N Male	N Female	18	50	1.25:1	0.68	2.23	2	75,000	<a href="#">PE3TC0104-24</a>	\$416.24	See Web for Volume Pricing	72
	N Male								<a href="#">PE3TC0103-24</a>	\$369.28		73
SMA Male	SMA Female	27	2.06	6.76	3	<a href="#">PE3TC0105-24</a>	\$357.55	74				
		18				<a href="#">PE3TC0102-24</a>	\$386.89	75				
	SMA Male	27	0.68	2.23	2	<a href="#">PE3TC0202-24</a>	\$600.12	76				
		18				<a href="#">PE3TC0101-24</a>	\$339.94	77				
	27	2.06	6.76	3	<a href="#">PE3TC0201-24</a>	\$492.52	78					

See Web for other lengths

## PE-TC151 SERIES PHASE STABLE TEST CABLE ASSEMBLIES

### Product Features

- Phase and amplitude stability with flexure
- Small diameter, lighter weight and lower profile for high density test applications
- Phase change with flexure +/-5° to 18 GHz
- Excellent for multi-port test equipment
- Very flexible and durable cable with a min. bend radius of 0.75 inches
- Excellent VSWR and insertion loss
- Extra strain relief for extended connector body with booting to enhance stability and longevity
- Each serialized assembly comes with matching test data
- 5,000 mating cycles when properly mated
- In-Stock and ready to ship



Connector 1	Connector 2	Freq. Max (GHz)	Imp (Ohm)	VSWR	IL (dB/ft)	IL (dB/m)	Phase Stability with Flexure (Degrees)	Flex Cycles	Model No	1-9	10-24	25+	ROW
N Male	N Male	18	50	1.3:1	0.85	2.79	5	75,000	<a href="#">PE3TC0302-24</a>	\$301.67	\$286.59	\$271.50	79
									<a href="#">PE3TC0303-24</a>	\$292.28	\$277.67	\$263.05	80
SMA Male	SMA Male	27	2.06	6.76	3	<a href="#">PE3TC0301-24</a>	\$250.04	\$237.54	\$225.04	81			
		18				<a href="#">PE3TC0401-24</a>	\$423.75	\$402.56	\$381.38	82			

See Web for other lengths

Test & Measurement



Technical Support  
+1 (949) 261-1920



Same-Day Shipping,  
Even Custom  
Cable Assemblies



## 75 OHM TEST CABLE ASSEMBLIES



### Product Features

- Phase and amplitude stability with flexure
- Small diameter, lighter weight and lower profile for high density test applications
- Very flexible and durable cable with a min. bend radius of 0.75 inches
- Each serialized assembly comes with matching test data

Connector 1	Connector 2	Freq. Max (GHz)	Imp (Ohm)	VSWR	IL (dB/ft)	IL (dB/m)	Phase Stability with Flexure (Degrees)	Flex Cycles	Model No	1-9	10-24	25+	ROW
N Male	F Male	3	75	1.16:1	0.193	0.63	5	100,000	<a href="#">PE3CA1031-60cm</a>	\$284.41	\$270.19	\$255.97	83
	N Male								<a href="#">PE3CA1032-60cm</a>	\$323.03	\$306.88	\$290.73	84

See Web for other lengths

## SEMI-RIGID PIGTAIL TEST PROBES

### Product Features

- Operating to 6 GHz
- SMA Female connectors
- Excellent VSWR of 1.3:1
- Straight-cut and pre-stripped probe ends available

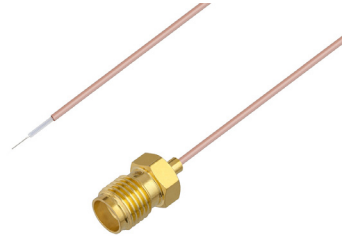

Connector 1	Cable	Lead	Freq. Max (GHz)	Imp (Ohm)	VSWR	IL @fmax (dB/ft)	Length (in)	Model No	1-24	25-49	50-99	100+	ROW
SMA Female	PE-020SR	Straight Cut Lead	6	50	1.35:1	0.43	3.0	<a href="#">PE3CA1107-3</a>	\$67.10	\$63.75	\$60.39	\$57.71	85
		Trimmed Lead						<a href="#">PE3CA1104-3</a>	\$104.73	\$99.49	\$94.26	\$90.07	86
	PE-034SR	Straight Cut Lead				0.28		<a href="#">PE3CA1102-3</a>	\$34.79	\$33.05	\$31.31	\$29.92	87
		Trimmed Lead				0.20		<a href="#">PE3CA1105-3</a>	\$39.51	\$37.53	\$35.56	\$33.98	88
	PE-047SR	Straight Cut Lead				<a href="#">PE3CA1103-3</a>		\$34.58	\$32.85	\$31.12	\$29.74	89	
		Trimmed Lead				<a href="#">PE3CA1106-3</a>		\$43.95	\$41.75	\$39.56	\$37.80	90	

See Web for other lengths

## 26.5 GHZ & 40 GHZ TEST CABLES

### Product Features



- Rugged Armored Jacket
- 1.38 Inch [3.5cm] Bend Radius
- RoHS Compliant



Connector 1	Connector 2	Freq. Max (GHz)	Imp (Ohm)	VSWR	IL @fmax (dB/ft)	Length (in)	Model No	1	2-4	5-9	10+	ROW
3.5mm Male	3.5mm Male	26.5	50	1.25	0.64	Various	<a href="#">PE3VNA2603</a>	Call	Call	Call	Call	91
3.5mm Female	3.5mm Female			1.3			<a href="#">PE3VNA2604</a>					92
2.92mm Male	2.92mm Male			1.25			<a href="#">PE3VNA2605</a>					93
		<a href="#">PE3VNA2606</a>	94									
2.92mm Female	2.92mm Female	40	1.38	0.83	<a href="#">PE3VNA4001</a>	Call	Call	Call	Call	95		
2.4mm Male	2.4mm Male				<a href="#">PE3VNA4002</a>					96		
2.4mm Female	2.4mm Female				<a href="#">PE3VNA4004</a>					97		
					<a href="#">PE3VNA4005</a>					98		

# INDEX GUIDE TO TOOLS

<b>TOOLS.....</b>	<b>355</b>
<b>CABLE CUTTER.....</b>	<b>355</b>
<b>CRIMP TOOL DIES.....</b>	<b>357</b>
<b>CRIMP TOOLS.....</b>	<b>357</b>
<b>INSERTION / EXTRACTION TOOL.....</b>	<b>355</b>
<b>TORQUE WRENCHES.....</b>	<b>356</b>

TOOLS							
Cable Cutter							
							
Type	Coax/Wire Type	Model No	1-24	25-49	50-99	100+	ROW
Cable Cutter	Coax	<a href="#">PE5200</a>	\$104.64	\$99.41	\$94.18	\$89.99	1
Insertion/Extraction Tool							
							
Type	Connector Type	Model No	1-24	25-49	50-99	100+	ROW
Insertion/Extraction Tool	BNC	<a href="#">PE5014</a>	Call	Call	Call	Call	2

Tools

## Torque Wrenches



See Our Website For Current Pricing & Real-Time Stock Availability!

Type	Bit Hex Size	Preset Torque (in.-lbs)	Design	Model No	1 Pc. Price	See Web for Volume Pricing	R O W
1.0mm	15/64 inch	4	Break-Over	<a href="#">PE5019-16</a>	\$242.40	See Web for Volume Pricing	3
3.5mm, 2.92mm	5/16 inch	8		<a href="#">PE5019-1</a>	\$210.86		
		12		<a href="#">PE5019-2</a>	\$227.60		
7mm	3/4 inch	14	Click Type	<a href="#">PE5011-3</a>	\$394.41		4
N	20 mm	8.1	Break-Over	<a href="#">PE5019-5</a>	\$242.40		3
		14	Click Type	<a href="#">PE5011-7</a>	\$318.02		4
	25/32 inch		8.1	Break-Over	<a href="#">PE5019-6</a>		\$240.14
3/4 inch	<a href="#">PE5019-3</a>	\$240.14					
	N, 7mm	14	<a href="#">PE5019-4</a>		\$240.14		
N, SC	13/16 inch	8.1	Click Type	<a href="#">PE5019-7</a>	\$240.14		4
		14		<a href="#">PE5011-6</a>	\$383.61		
SMA	5/16 inch	5	Break-Over	<a href="#">PE5019-8</a>	\$240.14		3
SMA, 2.92mm		8	Click Type	<a href="#">PE5019-19</a>	\$223.35		
SMC	1/4 inch	3		<a href="#">PE5011-1</a>	\$256.76		4
	15/64 inch		<a href="#">PE5011-2</a>	\$354.79			
SSMA	1/4 inch	5	Break-Over	<a href="#">PE5019-11</a>	\$242.40		3
		8	Click Type	<a href="#">PE5019-13</a>	\$242.40		
		8.1	<a href="#">PE5011-5</a>	\$363.11			
SSMC	5/32 inch	2	Break-Over	<a href="#">PE5019-14</a>	\$242.40		4
TNC	5/8 inch	6.1		<a href="#">PE5019-12</a>	\$240.14		
		12		<a href="#">PE5019-18</a>	\$259.38		
		14	Click Type	<a href="#">PE5019-10</a>	\$240.14		
TNC	9/16 inch	6.1	Break-Over	<a href="#">PE5011-4</a>	\$360.10	4	
		12		<a href="#">PE5019-17</a>	\$242.40		
		13		<a href="#">PE5019-9</a>	\$240.14		
		13	Click Type	<a href="#">PE5011-8</a>	\$339.73	3	
						4	

Tools

### Crimp Tools



Type	Hex Size (in.)	Compatible Dies	Cable Type	Model No	1 Pc. Price	See Web for Volume Pricing			ROW
Crimp Tools	0.068, 0.100, 0.128, 0.178	---	RG174, RG179, RG180, RG187, RG188, RG195, RG316	<a href="#">PE5006</a>	\$167.48				5
	0.068, 0.213, 0.255		RG55, RG58, RG59, RG62, RG142, RG223 RG400	<a href="#">PE5001</a>	\$149.61				6
	0.100, 0.429		RG9, RG11, RG87A, RG149, RG165, RG213, RG214, RG216, RG225, RG393	<a href="#">PE5007</a>	\$177.15				7
Crimp Tool Kit	0.042, 0.068, 0.080, 0.100, 0.128, 0.151, 0.178, 0.213, 0.255, 0.324, 0.429	---	RG5, RG6, RG8, RG9, RG11, RG21, RG55, RG58, RG59, RG62, RG87A, RG140, RG141, RG142, RG143, RG165, RG174, RG179, RG180, RG187, RG188, RG195, RG210, RG212, RG213, RG214, RG216, RG222, RG223, RG225, RG303, RG304, RG316, RG393, RG400	<a href="#">PE5004-KIT</a>	\$403.61	See Web for Volume Pricing			8
Crimp Tool, Scissor style, No Die	---	PE5010-1, PE5010-2, PE5010-3, PE5010-4, PE5010-5 and PE5010-6	---	<a href="#">PE5008</a>	\$458.07				9
Crimp Tool, Straight Style, No Die	---	PE5010-1, PE5010-2, PE5010-3, PE5010-4, PE5010-5 and PE5010-6	---	<a href="#">PE5009</a>	\$232.97				10
Crimp Tool for Compression Connectors	---	---	RG6, RG11, RG59	<a href="#">PE5012</a>	\$158.60				11

### Crimp Tool Dies



Type	Hex Size (in.)	Compatible Crimp Tools	Cable Type	Model No	1 Pc. Price	See Web for Volume Pricing			ROW
Dies, Crimp Tool	0.128, 0.100	PE5008 and PE5009	RG174, RG178, RG179, RG188, RG196, RG316	<a href="#">PE5010-2</a>	\$225.30				12
	0.213, 0.068		RG58, RG142, RG223, RG400	<a href="#">PE5010-1</a>	\$298.05				
	0.255, 0.068		RG8X, RG59, RG62, PE-C240	<a href="#">PE5010-3</a>	\$266.11				
	0.429, 0.100		RG8, RG213, RG214, PE-B400, PE-B405, PE-C400	<a href="#">PE5010-5</a>	\$234.09				





# INDEX GUIDE TO WAVEGUIDE PRODUCTS

## WAVEGUIDE ANTENNAS.....360

**WAVEGUIDE ANTENNAS.....360** | **WG ANTENNA ACCESSORIES.....365**

Pasternack offers a large selection of waveguide antennas from WR-284 to WR-15 (2.6 GHz to 75 GHz) in a variety of flanges and gain. Both UG and CPR/CMR style flanges are available. Most of the gain horn antennas can be purchased already assembled with a waveguide to coax adapter.

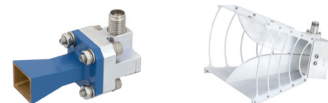

## WAVEGUIDE BENDS.....369



Pasternack offers a selection of E and H plane waveguide bends of various flanges and interfaces, covering the frequency range from 5.85 GHz to 18 GHz with VSWR as low as 1.08:1.

## WAVEGUIDE FILTERS.....369

**BANDPASS.....369**

Pasternack offers a selection of high performance waveguide bandpass filters, covering the frequency range from 20.2 GHz to 40 GHz with WR-28 and WR-42 interfaces. These filters exhibit excellent out-of-band rejection making them ideally suited to receiver front-end or transmitter applications.



## WAVEGUIDE BULKHEAD ADAPTERS.....370



The Pasternack series of rectangular waveguide bulkhead flange mount adapters are mounted to the panel of equipment with screws. Once mounted, waveguides flanges can be attached to the adapter on both sides of the bulkhead adapter to allow a signal path through the panel.

## WAVEGUIDE CONVERTERS.....371

**MIXER DOWN CONVERTERS.....371** | **MIXER UP CONVERTERS.....371**

Pasternack offers a series of Millimeter Wave Up and Down Converter Mixers that cover popular Ka, Q, U, V, E, and W Bands up to 110 GHz with an IF frequency of DC to 18 GHz. L and R ports support popular waveguide sizes from WR-28 to WR-10, and the IF port utilize Female SMA connectors.



## WAVEGUIDE COUPLERS.....371

**ASSEMBLIES.....376** | **BROADWALL.....371** | **CROSSGUIDE.....372**



Pasternack offers a brand new family of instrumentation grade directional waveguide couplers boasting accurate performance up to 110 GHz in seven popular frequency bands including K, Ka, Q, U, V, E and W bands. These waveguide couplers boast high directivity of 30 dB typical and insertion loss is as low as 0.6 dB in some models.

## WAVEGUIDE DETECTORS.....377

Waveguide detectors consists of 6 unique models covering a broad frequency range of 26.5 GHz to 110 GHz. The input ports use popular waveguide sizes ranging from WR-28 to WR-10, while the video output ports utilize SMA female connectors. The detector circuits use high performance GaAs Schottky Barrier Beam lead diodes with extremely low junction capacitance.



## WAVEGUIDE DIRECT READ ATTENUATORS.....377



These continuously variable attenuators have "direct read" capability which allows the user to dial-in the amount of attenuation needed to within 2% accuracy over most of the attenuation range. The attenuation level is stable, highly repeatable and accurate across the full frequency and attenuation range. These attenuators are ideal for precision measurements in demanding applications like instrumentation and system calibration.

## WAVEGUIDE ELECTROMECHANICAL RELAY SWITCHES.....377

Pasternack offers a series of 28 waveguide electromechanical relay switch models that offer full waveguide performance covering C, X, Ku, K and Ka frequency bands from 5.85 GHz to 40 GHz. These switches are configured for single-pole double-throw (SPDT) operation with latching self-cut-off actuators, TTL logic and position indicators with manual override.



**WAVEGUIDE FIXED ATTENUATORS.....379**

	<p>Pasternack's wide selection of waveguide fixed attenuator products offers precision attenuation levels over the operating frequency ranges.</p>
---	--



**FLEXIBLE WAVEGUIDES.....380**

<p><b>SEAMLESS.....380</b></p>	<p><b>TWISTABLE.....380</b></p>	
<p>This family of flexible, seamless waveguides or flexible, twistable waveguides that can be bent in both the E and H planes without impairing VSWR or attenuation. These waveguides are covered by a neoprene jacket which protect the waveguide and provides mechanical support.</p>		

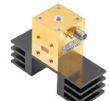
**WAVEGUIDE GUNN OSCILLATORS.....381**

<p>Waveguide Gunn Oscillators consist of 2 models that have center frequencies of 24.125 GHz and 35 GHz. Both models are tunable and supply output power levels of +10 dBm min. Compact package outlines support WR-28 and WR-42 waveguide sizes.</p>	
---	---



**WAVEGUIDE ISOLATORS..... 381 WAVEGUIDE POWER AMPLIFIERS.....383**

	<p>Pasternack Enterprises offers a wide variety of waveguide isolators from WR-10 to WR-112.</p>		<p>Waveguide Power Amplifiers consist of 2 models that cover 70.5 GHz to 86.5 GHz (E Band) and support WR-12 waveguide ports.</p>
---	--	---	---



**WG LOW NOISE AMPLIFIERS.....382 WAVEGUIDE SECTIONS..... 383**

<p>Pasternack WG Low Noise Amplifiers are ruggedly built 50 ohm designs and unconditionally stable with impressive performance across freq. bands.</p>		<p>Pasternack offers a standard product line of waveguide straight section of various length and flanges, covering the frequency range from 5.85 GHz to 12.4 GHz.</p>	
--	---	---	---



**WAVEGUIDE MAGIC TEES..... 382 WAVEGUIDE TERMINATIONS.....385**

	<p>Pasternack's magic, or hybrid tees are 4 port device that is internally tuned to optimize matching, balance, and isolation.</p>		<p>Pasternack has a large family of high performance loads from WR-112 to WR-10. These standard terminations can dissipate up to 300 Watts of power depending on the specific band.</p>
---	--	--	---



**WG ORTHOMODE TRANSDUCERS.....382 WAVEGUIDE TRANSITIONS.....386**

<p>These Orthomode Transducers are used for separating signals into two linear orthogonal signals. Pasternack's OMT line support from 8.2 to 90 GHz with 30-35 dB of isolation between ports.</p>		<p>Pasternack's family of Waveguide Transitions/Adapters are used as a means of propagating RF/Microwave energy from one waveguide size to another.</p>	
---	---	---	---



**WAVEGUIDE PHASE SHIFTERS.....382 WAVEGUIDE TWISTS.....387**

	<p>These waveguide variable phase shifters are built using low loss dielectric material, which offers minimum insertion loss..</p>		<p>Pasternack offers waveguide twists in 45 degree left and right hand waveguide versions as well at 90 degree. These twists are designed and constructed to prevent unwanted distortion to the signal's transmission.</p>
---	--	--	--

**WAVEGUIDE PIN DIODE SWITCHES.....383 WAVEGUIDE VARIABLE ATTEN..... 388**

<p>Waveguide PIN Diode Switches consist of 4 models that cover 60 GHz to 110 GHz, in both SPST and SPDT configurations.</p>		<p>The Continuously Variable attenuators are equipped with a micrometer, which enables rapid re-setting. With calibrated charts, attenuators can be used as direct reading attenuator for bench top test set use.</p>	
---	---	---	---

**WAVEGUIDE POLARIZERS.....383 WAVEGUIDE ACCESSORIES..... 388**

	<p>Pasternack's Waveguide Polarizers transform polarized signals from circular to linear and vice versa. They can operate as either right hand or left hand polarization. Waveguide Polarizers currently cover Ku, Ka, and V bands.</p>		<p>Pasternack Enterprises offers a variety of waveguide accessories from WR-10 to WR-430.</p>
---	---	--	---

Waveguides

## WAVEGUIDE ANTENNAS

### Waveguide Antennas With Coax Adapters

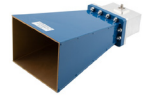

Waveguide Type	RF Frequency (GHz.)	Gain (dB)	Flange Type	ECCN	Model No	1	2-4	5-9	10+	ROW
WR-28	26.5 - 40	10	WR-28 - 2.92mm Female	EAR99	<a href="#">PE9850B/2F-10</a>	\$1,804.73	\$1,732.54	\$1,660.35	\$1,588.16	1
		15		EAR99	<a href="#">PE9850B/2F-15</a>	\$1,874.15	\$1,799.18	\$1,724.22	\$1,649.25	2
		20		EAR99	<a href="#">PE9850B/2F-20</a>	\$1,993.16	\$1,913.43	\$1,833.71	\$1,753.98	3
WR-34	22 - 33	10	WR-34 - 2.92mm Female	EAR99	<a href="#">PE9851B/2F-10</a>	\$1,859.96	\$1,785.56	\$1,711.16	\$1,636.76	4
		15		EAR99	<a href="#">PE9851B/2F-15</a>	\$2,003.80	\$1,923.65	\$1,843.50	\$1,763.34	5
		20		EAR99	<a href="#">PE9851B/2F-20</a>	\$2,140.33	\$2,054.72	\$1,969.10	\$1,883.49	6
WR-42	18 - 26.5	10	WR-42 - 2.92mm Female	EAR99	<a href="#">PE9852B/2F-10</a>	\$1,617.15	\$1,552.46	\$1,487.78	\$1,423.09	7
		15		EAR99	<a href="#">PE9852B/2F-15</a>	\$1,713.90	\$1,645.34	\$1,576.79	\$1,508.23	8
		20		EAR99	<a href="#">PE9852B/2F-20</a>	\$1,840.31	\$1,766.70	\$1,693.09	\$1,619.47	9
WR-51	15 - 22	10	WR-51 - SMA Female	EAR99	<a href="#">PE9853B/SF-10</a>	\$1,638.30	\$1,572.77	\$1,507.24	\$1,441.70	10
		15		EAR99	<a href="#">PE9853B/SF-15</a>	\$1,757.92	\$1,687.60	\$1,617.29	\$1,546.97	11
WR-62	12.4 - 18	10	WR-62 - N Female	EAR99	<a href="#">PE9854B/NF-10</a>	\$1,411.63	\$1,355.16	\$1,298.70	\$1,242.23	12
		15		EAR99	<a href="#">PE9854B/NF-15</a>	\$1,457.70	\$1,399.39	\$1,341.08	\$1,282.78	13
		20		EAR99	<a href="#">PE9854B/NF-20</a>	\$1,552.92	\$1,490.80	\$1,428.69	\$1,366.57	14
		10	WR-62 - SMA Female	EAR99	<a href="#">PE9854B/SF-10</a>	\$1,411.28	\$1,354.83	\$1,298.38	\$1,241.93	15
		15		EAR99	<a href="#">PE9854B/SF-15</a>	\$1,457.26	\$1,398.97	\$1,340.68	\$1,282.39	16
		20		EAR99	<a href="#">PE9854B/SF-20</a>	\$1,549.69	\$1,487.70	\$1,425.71	\$1,363.73	17
WR-75	10 - 15	10	WR-75 - N Female	EAR99	<a href="#">PE9855B/NF-10</a>	\$1,432.55	\$1,375.25	\$1,317.95	\$1,260.64	19
		15		EAR99	<a href="#">PE9855B/NF-15</a>	\$1,454.53	\$1,396.35	\$1,338.17	\$1,279.99	18
		20		EAR99	<a href="#">PE9855B/NF-20</a>	\$1,515.55	\$1,454.93	\$1,394.31	\$1,333.68	19
		10	WR-75 - SMA Female	EAR99	<a href="#">PE9855B/SF-10</a>	\$1,404.00	\$1,347.84	\$1,291.68	\$1,235.52	21
		15		EAR99	<a href="#">PE9855B/SF-15</a>	\$1,448.05	\$1,390.13	\$1,332.21	\$1,274.28	20
		20		EAR99	<a href="#">PE9855B/SF-20</a>	\$1,509.07	\$1,448.71	\$1,388.34	\$1,327.98	21
WR-90	8.2 - 12.4	10	WR-90 - N Female	EAR99	<a href="#">PE9856B/NF-10</a>	\$1,342.40	\$1,288.70	\$1,235.01	\$1,181.31	22
		15		EAR99	<a href="#">PE9856B/NF-15</a>	\$1,434.43	\$1,377.05	\$1,319.68	\$1,262.30	23
		20		EAR99	<a href="#">PE9856B/NF-20</a>	\$1,496.71	\$1,436.84	\$1,376.97	\$1,317.10	24
		10	WR-90 - SMA Female	EAR99	<a href="#">PE9856B/SF-10</a>	\$1,288.52	\$1,236.98	\$1,185.44	\$1,133.90	25
		15		EAR99	<a href="#">PE9856B/SF-15</a>	\$1,434.43	\$1,377.05	\$1,319.68	\$1,262.30	26
		20		EAR99	<a href="#">PE9856B/SF-20</a>	\$1,506.26	\$1,446.01	\$1,385.76	\$1,325.51	27
WR-102	7 - 11	10	WR-102 - N Female	EAR99	<a href="#">PE9857B/NF-10</a>	\$1,499.63	\$1,439.64	\$1,379.66	\$1,319.67	28
		15		EAR99	<a href="#">PE9857B/NF-15</a>	\$1,604.76	\$1,540.57	\$1,476.38	\$1,412.19	29
		20		EAR99	<a href="#">PE9857B/NF-20</a>	\$1,650.13	\$1,584.12	\$1,518.12	\$1,452.11	29
		10	WR-102 - SMA Female	EAR99	<a href="#">PE9857B/SF-10</a>	\$1,556.07	\$1,493.83	\$1,431.58	\$1,369.34	30
		10		EAR99	<a href="#">PE9857B/SF-15</a>	\$1,628.08	\$1,562.96	\$1,497.83	\$1,432.71	30
		20		EAR99	<a href="#">PE9857B/SF-20</a>	\$1,706.57	\$1,638.31	\$1,570.04	\$1,501.78	31
WR-112	7.05 - 10	10	WR-112 - N Female	EAR99	<a href="#">PE9858B/NF-10</a>	\$1,466.30	\$1,407.65	\$1,349.00	\$1,290.34	32
		15		EAR99	<a href="#">PE9858B/NF-15</a>	\$1,536.94	\$1,475.46	\$1,413.98	\$1,352.51	33
		20		EAR99	<a href="#">PE9858B/NF-20</a>	\$1,653.66	\$1,587.51	\$1,521.37	\$1,455.22	33
		10	WR-112 - SMA Female	EAR99	<a href="#">PE9858B/SF-10</a>	\$1,425.14	\$1,368.13	\$1,311.13	\$1,254.12	34
		15		EAR99	<a href="#">PE9858B/SF-15</a>	\$1,520.62	\$1,459.80	\$1,398.97	\$1,338.15	34
		20		EAR99	<a href="#">PE9858B/SF-20</a>	\$1,612.50	\$1,548.00	\$1,483.50	\$1,419.00	35
WR-137	5.85 - 8.2	10	WR-137 - N Female	EAR99	<a href="#">PE9859B/NF-10</a>	\$1,575.07	\$1,512.07	\$1,449.06	\$1,386.06	36
		15		EAR99	<a href="#">PE9859B/NF-15</a>	\$1,636.97	\$1,571.49	\$1,506.01	\$1,440.53	37
		10	WR-137 - SMA Female	EAR99	<a href="#">PE9859B/SF-10</a>	\$1,575.07	\$1,512.07	\$1,449.06	\$1,386.06	38
		15		EAR99	<a href="#">PE9859B/SF-15</a>	\$1,636.97	\$1,571.49	\$1,506.01	\$1,440.53	39
WR-159	4.9 - 7.05	15	WR-159 - N Female	EAR99	<a href="#">PE9860B/NF-15</a>	\$1,891.63	\$1,815.96	\$1,740.30	\$1,664.63	40
		15	WR-159 - SMA Female	EAR99	<a href="#">PE9860B/SF-15</a>	\$1,884.43	\$1,809.05	\$1,733.68	\$1,658.30	41
WR-284	2.6 - 3.95	10	WR-284 - N Female	EAR99	<a href="#">PE9863B/NF-10</a>	\$2,542.84	\$2,441.13	\$2,339.41	\$2,237.70	42
		10	WR-284 - SMA Female	EAR99	<a href="#">PE9863B/SF-10</a>	\$2,865.50	\$2,750.88	\$2,636.26	\$2,521.64	43
WR-430	1.7 - 2.6	10	WR-430 - N Female	EAR99	<a href="#">PE9864B/NF-10</a>	\$3,107.39	\$2,983.09	\$2,858.80	\$2,734.50	44
		15		EAR99	<a href="#">PE9864B/NF-15</a>	\$3,933.64	\$3,776.29	\$3,618.95	\$3,461.60	44
		10	WR-430 - SMA Female	EAR99	<a href="#">PE9864B/SF-10</a>	\$3,078.69	\$2,955.54	\$2,832.39	\$2,709.25	45
		15		EAR99	<a href="#">PE9864B/SF-15</a>	\$4,063.50	\$3,900.96	\$3,738.42	\$3,575.88	45

## Standard Gain Horns

See Our Website For Current Pricing & Real-Time Stock Availability!



Waveguide Type	RF Frequency (GHz.)	Gain (dB)	Flange Type	ECCN	Model No	1 Pc. Price	See Web for Volume Pricing	ROW
WR-5	140 - 220	10		EAR99	<a href="#">PEWAN1029</a>	\$2,217.19		46
		15		EAR99	<a href="#">PEWAN1030</a>	\$2,217.19		47
		20		EAR99	<a href="#">PEWAN1031</a>	\$2,217.19		48
		25		EAR99	<a href="#">PEWAN1032</a>	\$2,325.40		49
WR-6	110 - 170	10		EAR99	<a href="#">PEWAN1025</a>	\$1,814.07		50
		15		EAR99	<a href="#">PEWAN1026</a>	\$1,840.94		51
		20		EAR99	<a href="#">PEWAN1027</a>	\$1,867.82		52
		25		EAR99	<a href="#">PEWAN1028</a>	\$2,196.44		53
WR-8	90 - 140	10	Round Cover UG-387/U-Mod	EAR99	<a href="#">PEWAN1021</a>	\$1,545.32		54
		15		EAR99	<a href="#">PEWAN1022</a>	\$1,572.19		55
		20		EAR99	<a href="#">PEWAN1023</a>	\$1,599.07		56
		25		EAR99	<a href="#">PEWAN1024</a>	\$2,015.63		57
WR-10	75 - 110	10		EAR99	<a href="#">PEWAN1017</a>	\$1,295.68		58
		15		EAR99	<a href="#">PEWAN1018</a>	\$1,303.44		59
		20		EAR99	<a href="#">PEWAN1019</a>	\$1,402.89		60
		25		EAR99	<a href="#">PEWAN1020</a>	\$1,773.03		61
WR-12	60 - 90	10		EAR99	<a href="#">PEWAN1013</a>	\$1,346.21		62
		15		EAR99	<a href="#">PEWAN1014</a>	\$1,374.55		63
		20		EAR99	<a href="#">PEWAN1015</a>	\$1,402.89		64
		25		EAR99	<a href="#">PEWAN1016</a>	\$1,842.19		65
WR-15	50 - 75	10	Round Cover UG-387/U	EAR99	<a href="#">PEWAN1009</a>	\$1,295.68		66
		15	Round Cover UG-385/U-Mod	EAR99	<a href="#">PEWAN1010</a>	\$1,374.55		67
		20	Round Cover UG-385/U	EAR99	<a href="#">PEWAN1011</a>	\$1,330.32		68
		24	Round Cover UG-385/U	EAR99	<a href="#">PE9881-24</a>	\$1,613.93		69
WR-19	40 - 60	10	Round Cover UG-385/U-Mod	EAR99	<a href="#">PEWAN1012</a>	\$1,842.19		70
		15	Round Cover UG-383/U-Mod	EAR99	<a href="#">PEWAN1005</a>	\$1,417.07		71
		20	Round Cover UG-383/U-Mod	EAR99	<a href="#">PEWAN1006</a>	\$1,472.98		72
		25	Round Cover UG-383/U-Mod	EAR99	<a href="#">PEWAN1007</a>	\$1,500.26		73
WR-28	26.5 - 40	10	Square Cover UG-599/U	EAR99	<a href="#">PEWAN1008</a>	\$1,773.03	See Web for Volume Pricing	74
		15		EAR99	<a href="#">PE9850B-10</a>	\$931.16		75
		20		EAR99	<a href="#">PE9850B-15</a>	\$1,116.93		76
		20		EAR99	<a href="#">PE9850B-20</a>	\$1,054.14		77
WR-34	22 - 33	10	Square Cover UG-1530/U	EAR99	<a href="#">PE9851B-10</a>	\$903.79		78
		15		EAR99	<a href="#">PE9851B-15</a>	\$1,039.53		79
		20		EAR99	<a href="#">PE9851B-20</a>	\$1,176.05		80
WR-42	18 - 26.5	10	Square Cover UG-597/U	EAR99	<a href="#">PE9852B-10</a>	\$903.24		81
		15		EAR99	<a href="#">PE9852B-15</a>	\$1,046.79		82
		20		EAR99	<a href="#">PE9852B-20</a>	\$1,178.54		83
WR-51	15 - 22	10	Square Cover	EAR99	<a href="#">PE9853B-10</a>	\$812.95		84
		15		EAR99	<a href="#">PE9853B-15</a>	\$876.00		85
		20		EAR99	<a href="#">PE9853B-20</a>	\$920.32		86
WR-62	12.4 - 18	10	Square Cover UG-1665/U	EAR99	<a href="#">PE9854B-10</a>	\$924.50		87
		15	Square Cover	EAR99	<a href="#">PE9854B-15</a>	\$967.50		88
		20	Square Cover	EAR99	<a href="#">PE9854B-20</a>	\$1,134.84		89
WR-75	10 - 15	10	Square Cover	EAR99	<a href="#">PE9855B-10</a>	\$954.95		90
		15		EAR99	<a href="#">PE9855B-15</a>	\$1,012.25		91
		20		EAR99	<a href="#">PE9855B-20</a>	\$1,021.25		92
WR-90	8.2 - 12.4	10	Square Cover UG-135/U	EAR99	<a href="#">PE9856B-10</a>	\$916.39		93
		15		EAR99	<a href="#">PE9856B-15</a>	\$1,065.35		94
		20		EAR99	<a href="#">PE9856B-20</a>	\$1,116.61		95
WR-102	7 - 11	10	Square Cover UG-1493/U	EAR99	<a href="#">PE9857B-10</a>	\$903.79		96
		15	Square Cover	EAR99	<a href="#">PE9857B-15</a>	\$908.42		97
		20	Square Cover UG-1493/U	EAR99	<a href="#">PE9857B-20</a>	\$963.20		98
WR-112	7.05 - 10	10	Square Cover	EAR99	<a href="#">PE9858B-10</a>	\$994.16		99
		15	Square Cover UG-138/U	EAR99	<a href="#">PE9858B-15</a>	\$1,069.21		1
		20	Square Cover	EAR99	<a href="#">PE9858B-20</a>	\$1,144.88		2
WR-137	58.5 - 82	20	CMR-137F	EAR99	<a href="#">PE9859B-20</a>	\$1,075.00		3
	5.85 - 8.2	10	CMR-137	EAR99	<a href="#">PE9859B-10</a>	\$929.13		4
15		EAR99		<a href="#">PE9859B-15</a>	\$989.77	5		
WR-159	49 - 70.5	20	CMR-159	EAR99	<a href="#">PE9860B-20</a>	Call		6

Waveguides



## Standard Gain Horns



Waveguide Type	RF Frequency (GHz.)	Gain (dB)	Flange Type	ECCN	Model No	1-4	5-9	10-24	25+	R O W
WR-159	4.9 - 7.05	10	CMR-159	EAR99	<a href="#">PE9860B-10</a>	\$983.32	\$934.15	\$884.99	\$845.66	7
		15		EAR99	<a href="#">PE9860B-15</a>	\$1,057.20	\$1,004.34	\$951.48	\$909.19	8
WR-187	3.95 - 5.85	10	CMR-187	EAR99	<a href="#">PE9861B-10</a>	\$1,075.00	\$1,021.25	\$967.50	\$924.50	9
		20		EAR99	<a href="#">PE9862B-20</a>	\$1,705.40	\$1,620.13	\$1,534.86	\$1,466.64	10
WR-229	33 - 49 3.3 - 4.9	15	CMR-229	EAR99	<a href="#">PE9862B-15</a>	\$1,359.99	\$1,291.99	\$1,223.99	\$1,169.59	11
		20		EAR99	<a href="#">PE9863B-15</a>	\$1,827.50	\$1,736.13	\$1,644.75	\$1,571.65	12
WR-284	26 - 39.5	15	Round Cover UG-584/U	EAR99	<a href="#">PE9863B-15-U</a>	\$1,720.00	\$1,634.00	\$1,548.00	\$1,479.20	13
		20		EAR99	<a href="#">PE9863B-20-U</a>	\$1,914.19	\$1,818.48	\$1,722.77	\$1,646.20	14
	2.6 - 3.95	10	CMR-284	EAR99	<a href="#">PE9863B-10</a>	\$1,393.82	\$1,324.13	\$1,254.44	\$1,198.69	15
		10	Round Cover UG-584/U	EAR99	<a href="#">PE9863B-10-U</a>	\$1,526.50	\$1,450.18	\$1,373.85	\$1,312.79	16
WR-430	17 - 26	10	CPR-430F	EAR99	<a href="#">PE9864B-10</a>	\$1,827.77	\$1,736.38	\$1,644.99	\$1,571.88	17

## Conical Gain Horns



Waveguide Type	RF Frequency (GHz.)	Gain (dB)	Flange Type	ECCN	Model No	1 Pc. Price	See Web for Volume Pricing	R O W
WR-5	140 - 220	10	Round Cover UG-387/U	EAR99	<a href="#">PEWAN1065</a>	\$2,163.44		18
		15		EAR99	<a href="#">PEWAN1066</a>	\$2,190.32		19
		20		EAR99	<a href="#">PEWAN1067</a>	\$2,217.19		20
		25		EAR99	<a href="#">PEWAN1068</a>	\$2,416.09		21
WR-6	100 - 112	10	Round Cover UG-387/U-Mod	EAR99	<a href="#">PEWAN1061</a>	\$1,814.07		22
		15		EAR99	<a href="#">PEWAN1062</a>	\$1,840.94		23
		20		EAR99	<a href="#">PEWAN1063</a>	\$1,867.82		24
		25		EAR99	<a href="#">PEWAN1064</a>	\$2,082.82		25
WR-8	100 - 112	10	Round Cover UG-387/U-Mod	EAR99	<a href="#">PEWAN1057</a>	\$1,303.44		26
		15		EAR99	<a href="#">PEWAN1058</a>	\$1,330.32		27
		20		EAR99	<a href="#">PEWAN1059</a>	\$1,478.13		28
		25		EAR99	<a href="#">PEWAN1060</a>	\$1,746.88		29
WR-10	87 - 100	10	Round Cover UG-387/U	EAR99	<a href="#">PEWAN1049</a>	\$1,303.44		30
		15		EAR99	<a href="#">PEWAN1050</a>	\$1,330.32		31
		20		EAR99	<a href="#">PEWAN1051</a>	\$1,478.13		32
		25		EAR99	<a href="#">PEWAN1052</a>	\$1,773.03		33
WR-12	77 - 87	10	Round Cover UG-387/U	EAR99	<a href="#">PEWAN1053</a>	\$1,303.44	See Web for Volume Pricing	34
		15		EAR99	<a href="#">PEWAN1054</a>	\$1,330.32		35
		20		EAR99	<a href="#">PEWAN1055</a>	\$1,478.13		36
		25		EAR99	<a href="#">PEWAN1056</a>	\$1,746.88		37
	68 - 77	10	Round Cover UG-387/U	EAR99	<a href="#">PEWAN1045</a>	\$1,303.44		38
		15		EAR99	<a href="#">PEWAN1046</a>	\$1,330.32		39
		20		EAR99	<a href="#">PEWAN1047</a>	\$1,478.13		40
		25		EAR99	<a href="#">PEWAN1048</a>	\$1,746.88		41
WR-15	58 - 68	10	Round Cover UG-385/U	EAR99	<a href="#">PEWAN1041</a>	\$1,303.44		42
		15		EAR99	<a href="#">PEWAN1042</a>	\$1,330.32		43
		20		EAR99	<a href="#">PEWAN1043</a>	\$1,478.13		44
		25		EAR99	<a href="#">PEWAN1044</a>	\$1,746.88		45
WR-19	50 - 58	10	Round Cover UG-383/U-Mod	EAR99	<a href="#">PEWAN1037</a>	\$1,303.44		46
		15		EAR99	<a href="#">PEWAN1038</a>	\$1,350.24		47
		20		EAR99	<a href="#">PEWAN1039</a>	\$1,478.13		48
		25		EAR99	<a href="#">PEWAN1040</a>	\$1,746.88		49
WR-19	50 - 58	10	Round Cover UG-383/U-Mod	EAR99	<a href="#">PEWAN1033</a>	\$1,182.50		50
		15		EAR99	<a href="#">PEWAN1034</a>	\$1,330.32		51
		20		EAR99	<a href="#">PEWAN1035</a>	\$1,478.13		52
		25		EAR99	<a href="#">PEWAN1036</a>	\$1,773.03		53

See Our Website For Current Pricing & Real-Time Stock Availability!

Waveguides

## Wide Angle Scalar Feed Horns



Waveguide Type	RF Frequency (GHz.)	Gain (dB)	Flange Type	ECCN	Model No	1	2-4	5-9	10+	ROW
WR-10	89 - 99	10	Round Cover UG-385/U-Mod	EAR99	<a href="#">PEWAN1073</a>	\$5,079.38	\$4,901.60	\$4,723.82	\$4,571.44	54
		10		EAR99	<a href="#">PEWAN1074</a>	\$3,574.38	\$3,449.28	\$3,324.17	\$3,216.94	55
WR-12	72 - 82	10	Round Cover UG-385/U	EAR99	<a href="#">PEWAN1071</a>	\$5,155.41	\$4,974.97	\$4,794.53	\$4,639.87	56
		10		EAR99	<a href="#">PEWAN1072</a>	\$3,574.38	\$3,449.28	\$3,324.17	\$3,216.94	57
WR-15	55 - 65	10		EAR99	<a href="#">PEWAN1069</a>	\$5,079.38	\$4,901.60	\$4,723.82	\$4,571.44	58
		10		EAR99	<a href="#">PEWAN1070</a>	\$3,769.38	\$3,637.45	\$3,505.52	\$3,392.44	59

## Lens Gain Horns



Waveguide Type	RF Frequency (GHz.)	Gain (dB)	Flange Type	ECCN	Model No	1 Pc. Price	See Web for Volume Pricing			ROW
WR-10	89 - 99	34	Round Cover UG-387/U	EAR99	<a href="#">PEWAN1083</a>	\$5,079.38	See Web for Volume Pricing			60
		34		EAR99	<a href="#">PEWAN1085</a>	\$6,208.13				61
		40		EAR99	<a href="#">PEWAN1084</a>	\$5,537.30				62
		40		EAR99	<a href="#">PEWAN1086</a>	\$6,584.38				63
	88 - 100	40	Round Cover UG-387/U-Mod	EAR99	<a href="#">PEWAN1101</a>	\$10,054.62				64
48		Square Cover UG-387/U-Mod	EAR99	<a href="#">PEWAN1102</a>	\$10,330.09	65				
WR-12	72 - 82	32	Round Cover UG-387/U	EAR99	<a href="#">PEWAN1079</a>	\$4,326.88	66			
		32		EAR99	<a href="#">PEWAN1081</a>	\$5,455.63	67			
		37		EAR99	<a href="#">PEWAN1080</a>	\$4,703.13	68			
		37		EAR99	<a href="#">PEWAN1082</a>	\$5,831.88	69			
WR-15	55 - 65	32	Round Cover UG-385/U	EAR99	<a href="#">PEWAN1075</a>	\$3,198.13	70			
		32		EAR99	<a href="#">PEWAN1077</a>	\$4,326.88	71			
		37		EAR99	<a href="#">PEWAN1076</a>	\$3,574.38	72			
		37		EAR99	<a href="#">PEWAN1078</a>	\$4,703.13	73			

## Omni-Directional



Waveguide Type	RF Frequency (GHz.)	Gain (dB)	Flange Type	ECCN	Model No	1	2-4	5-9	10+	ROW
WR-10	90 - 100	0	Round Cover UG-387/U-Mod	EAR99	<a href="#">PEWAN1135</a>	\$4,971.88	\$4,797.86	\$4,623.85	\$4,474.69	74
		6.5	Square Cover UG-387/U-Mod	EAR99	<a href="#">PEWAN1136</a>	\$4,971.88	\$4,797.86	\$4,623.85	\$4,474.69	75
WR-12	89 - 99	2	Round Cover UG-387/U	EAR99	<a href="#">PEWAN1089</a>	\$7,446.71	\$7,186.08	\$6,925.44	\$6,702.04	76
	75 - 79	2		EAR99	<a href="#">PEWAN1088</a>	\$7,336.88	\$7,080.09	\$6,823.30	\$6,603.19	77
	71 - 86	2		EAR99	<a href="#">PEWAN1134</a>	\$4,703.13	\$4,538.52	\$4,373.91	\$4,232.82	78
WR-15	58 - 62	3.5	Round Cover UG-385/U	EAR99	<a href="#">PEWAN1087</a>	\$7,446.71	\$7,186.08	\$6,925.44	\$6,702.04	79
WR-28	26.5 - 40	7.5	Square Cover UG-599/U	EAR99	<a href="#">PEWAN1133</a>	\$4,165.63	\$4,019.83	\$3,874.04	\$3,749.07	80

## Probe Waveguide Antennas

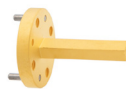

Waveguide Type	RF Frequency (GHz.)	Gain (dB)	Flange Type	ECCN	Model No	1	2-4	5-9	10+	ROW
WR-6	110 - 170	6.5	Round Cover UG-387/U-Mod	EAR99	<a href="#">PEWAN1124</a>	\$1,882.15	\$1,816.27	\$1,750.40	\$1,693.94	81
WR-8	90 - 140	6.5		EAR99	<a href="#">PEWAN1125</a>	\$1,854.38	\$1,789.48	\$1,724.57	\$1,668.94	82
WR-10	75 - 110	6.5		EAR99	<a href="#">PEWAN1126</a>	\$1,854.38	\$1,789.48	\$1,724.57	\$1,668.94	83

## Probe Waveguide Antennas



Waveguide Type	RF Frequency (GHz.)	Gain (dB)	Flange Type	ECCN	Model No	1	2-4	5-9	10+	ROW
WR-12	60 - 90	6.5	Round Cover UG-387/U	EAR99	<a href="#">PEWAN1127</a>	\$1,882.15	\$1,816.27	\$1,750.40	\$1,693.94	84
WR-15	50 - 75	6.5	Round Cover UG-385/U	EAR99	<a href="#">PEWAN1128</a>	\$1,854.38	\$1,789.48	\$1,724.57	\$1,668.94	85
WR-19	40 - 60	6.5	Round Cover UG-383/U-Mod	EAR99	<a href="#">PEWAN1129</a>	\$1,854.38	\$1,789.48	\$1,724.57	\$1,668.94	86
WR-22	33 - 50	6.5	Round Cover UG-383/U	EAR99	<a href="#">PEWAN1130</a>	\$1,854.38	\$1,789.48	\$1,724.57	\$1,668.94	87
WR-28	26.5 - 40	6.5	Square Cover UG-599/U	EAR99	<a href="#">PEWAN1131</a>	\$1,882.15	\$1,816.27	\$1,750.40	\$1,693.94	88
WR-34	22 - 33	6.5	Square Cover UG-1530/U	EAR99	<a href="#">PEWAN1132</a>	\$1,882.15	\$1,816.27	\$1,750.40	\$1,693.94	89

## Sector Waveguide Antennas



Waveguide Type	RF Frequency (GHz.)	Gain (dB)	Flange Type	ECCN	Model No	1	2-4	5-9	10+	ROW
WR-28	30 - 40	0	Square Cover UG-599/U-Mod	EAR99	<a href="#">PEWAN1144</a>	\$3,440.00	\$3,319.60	\$3,199.20	\$3,096.00	90
	27.5 - 29.5	6	Square Cover UG-599/U	EAR99	<a href="#">PEWAN1143</a>	\$3,491.51	\$3,369.31	\$3,247.10	\$3,142.36	91

## Dual Polarized Scalar Feed Horns



Waveguide Type	RF Frequency (GHz.)	Gain (dB)	Flange Type	ECCN	Model No	1	2-4	5-9	10+	ROW
	100 - 112	17	Round Cover UG-387/U-Mod	EAR99	<a href="#">PEWAN1109</a>	\$5,509.38	\$5,316.55	\$5,123.72	\$4,958.44	92
	87 - 100	17	UG-387/U-Mod	EAR99	<a href="#">PEWAN1123</a>	\$4,971.88	\$4,797.86	\$4,623.85	\$4,474.69	93
	77 - 87	17		EAR99	<a href="#">PEWAN1122</a>	\$4,837.50	\$4,668.19	\$4,498.88	\$4,353.75	94
WR-10	75 - 110	13	Square Cover UG-387/U-Mod	EAR99	<a href="#">PEWAN1121</a>	\$20,290.63	\$19,580.46	\$18,870.29	\$18,261.57	95
		15		EAR99	<a href="#">PEWAN1137</a>	\$9,271.88	\$8,947.36	\$8,622.85	\$8,344.69	96
		20		EAR99	<a href="#">PEWAN1141</a>	\$9,271.88	\$8,947.36	\$8,622.85	\$8,344.69	97
WR-12	60 - 90	17	UG-387/U-Mod	EAR99	<a href="#">PEWAN1120</a>	\$4,837.50	\$4,668.19	\$4,498.88	\$4,353.75	98
		13	UG-387/U	EAR99	<a href="#">PEWAN1119</a>	\$19,753.13	\$19,061.77	\$18,370.41	\$17,777.82	99
WR-12	50 - 75	15	Square Cover UG-387/U	EAR99	<a href="#">PEWAN1138</a>	\$8,734.38	\$8,428.68	\$8,122.97	\$7,860.94	1
		17	UG-385/U-Mod	EAR99	<a href="#">PEWAN1118</a>	\$4,703.13	\$4,538.52	\$4,373.91	\$4,232.82	2
WR-15	50 - 75	15	Square Cover UG-385/U	EAR99	<a href="#">PEWAN1139</a>	\$8,062.50	\$7,780.31	\$7,498.13	\$7,256.25	3
WR-19		13	UG-385/U-Mod	EAR99	<a href="#">PEWAN1117</a>	\$20,290.63	\$19,580.46	\$18,870.29	\$18,261.57	4
WR-19	40 - 60	13	UG-383/U-Mod	EAR99	<a href="#">PEWAN1116</a>	\$16,528.13	\$15,949.65	\$15,371.16	\$14,875.32	5
WR-22	33 - 50	15	Square Cover UG-383/U	EAR99	<a href="#">PEWAN1140</a>	\$7,525.00	\$7,261.63	\$6,998.25	\$6,772.50	6
WR-28	33 - 38.5	17	UG-599/U	EAR99	<a href="#">PEWAN1115</a>	\$4,300.00	\$4,149.50	\$3,999.00	\$3,870.00	7
	26 - 33	17		EAR99	<a href="#">PEWAN1114</a>	\$4,300.00	\$4,149.50	\$3,999.00	\$3,870.00	8
	26 - 30	17		EAR99	<a href="#">PEWAN1113</a>	\$4,300.00	\$4,149.50	\$3,999.00	\$3,870.00	9
WR-28	24 - 42	10	Square Choke UG-599/U	EAR99	<a href="#">PEWAN1142</a>	\$10,750.00	\$10,373.75	\$9,997.50	\$9,675.00	10
	24 - 40	15	UG-599/U	EAR99	<a href="#">PEWAN1111</a>	\$12,547.57	\$12,108.41	\$11,669.24	\$11,292.81	11
	24 - 42	15		EAR99	<a href="#">PEWAN1112</a>	\$13,706.25	\$13,226.53	\$12,746.81	\$12,335.63	12
	24 - 33	16	Square Cover UG-1530/U	EAR99	<a href="#">PEWAN1110</a>	\$4,300.00	\$4,149.50	\$3,999.00	\$3,870.00	13

## Specialty Waveguide Antennas



Waveguide Type	RF Frequency (GHz.)	Gain (dB)	Flange Type	ECCN	Model No	1	2-4	5-9	10+	ROW
Broadband	1 - 18		Round Cover - UG-385/U	EAR99	<a href="#">PE9887-11</a>	\$3,872.33	\$3,736.80	\$3,601.27	\$3,485.10	14
		EAR99		<a href="#">PE9888-11</a>	\$3,565.14	\$3,440.36	\$3,315.58	\$3,208.63	15	
WR-15	50 - 75	42	Round Cover - UG-385/U	5A991	<a href="#">PE9881-42</a>	\$2,798.32	\$2,686.39	\$2,574.45	\$2,462.52	16
		20		EAR99	<a href="#">PE9881A-20</a>	\$1,182.42	\$1,135.12	\$1,087.83	\$1,040.53	17
				EAR99	<a href="#">PEW15A001</a>	\$4,274.59	\$4,124.98	\$3,975.37	\$3,847.13	18
				5A991	<a href="#">PE9881-34</a>	\$1,694.40	\$1,635.10	\$1,575.79	\$1,524.96	19
	56.5 - 67									

## WAVEGUIDE ANTENNA ACCESSORIES

### Waveguide to Coax Adapters



WG Type	RF Freq. (GHz.)	IL (dB)	Max VSWR	Flange Type	Connector	ECCN	Model No	1 Pc. Price	See Web for Volume Pricing	ROW		
WR-10	75-110	1	1.32:1	Round Cover UG-387/U-Mod	1.0mm Female	EAR99	<a href="#">PE-W10CA003</a>	\$5,287.99		20		
			1.33:1		1.0mm Male	EAR99	<a href="#">PE-W10CA004</a>	\$5,210.00		21		
WR-12	60-90		1.67:1	Round Cover UG-387/U	1.0mm Female	EAR99	<a href="#">PE-W12CA001</a>	\$3,348.39		22		
					1.0mm Male	EAR99	<a href="#">PE-W12CA002</a>	\$5,111.72		23		
WR-15	50-65	0.5	1.44:1	Round Cover UG-385/U	1.85mm Female	EAR99	<a href="#">PE-W15CA001</a>	\$1,517.58		24		
					1.85mm Male	EAR99	<a href="#">PE-W15CA002</a>	\$1,563.51		25		
WR-19	40-60	0.4	1.38:1	Round Cover UG-383/U-Mod	1.85mm Female	EAR99	<a href="#">PE-W19CA001</a>	\$1,631.35		26		
					1.85mm Male	EAR99	<a href="#">PE-W19CA002</a>	\$1,461.16		27		
WR-22	33-50	0.4	1.33:1	Round Cover UG-383/U	2.4mm Female	EAR99	<a href="#">PE-W22CA001</a>	\$1,691.47	See Web for Volume Pricing	28		
					2.4mm Male	EAR99	<a href="#">PE-W22CA002</a>	\$1,405.68		29		
					2.4mm Female	EAR99	<a href="#">PEW22CA100</a>	\$1,691.47		30		
		0.5	1.6:1	UG383/U	2.4mm Female	EAR99	<a href="#">PEWCA1110</a>	\$1,528.61		31		
		WR-28	26.5-40	0.3	1.25:1	Square Cover UG-599/U	2.92mm Female	EAR99		<a href="#">PEWCA1078</a>	\$777.38	32
UBR320	2.92mm Female					EAR99	<a href="#">PEWCA1103</a>	\$1,019.07	33			
0.4	1.29:1			Square Cover UG-599/U	2.92mm Female	EAR99	<a href="#">PEWCA1104</a>	\$847.96	34			
					2.92mm Male	EAR99	<a href="#">PE-W28CA002</a>	\$838.20	35			
0.35	1.3:1			Square Cover UG-599/U	2.92mm Female	EAR99	<a href="#">PEWCA1000</a>	\$926.26	36			
					2.92mm Female	EAR99	<a href="#">PEWCA1020</a>	\$777.69	37			
					2.92mm Female	EAR99	<a href="#">PEWCA1109</a>	\$1,102.74	38			
WR-34	21.7-33	0.3	1.35:1	Square Cover	2.92mm Female	EAR99	<a href="#">PE9826</a>	\$518.00	39			
				UBR260	2.92mm Female	EAR99	<a href="#">PEWCA1102</a>	\$1,019.07	40			
				22-33	0.3	1.25:1	Square Cover UG-1530/U	2.92mm Female	EAR99	<a href="#">PEWCA1001</a>	\$765.94	41
							Square Cover	2.92mm Female	EAR99	<a href="#">PEWCA1021</a>	\$706.46	42
WR-42	17.6-26.7	0.3	1.25:1	UBR220	2.92mm Female	EAR99	<a href="#">PEWCA1101</a>	\$1,019.07	See Web for Volume Pricing	44		
					0.5	SMA Female	EAR99	<a href="#">PEWCA1100</a>		\$418.28	45	
		0.75	1.03:1	Square Cover UG-597/U	SMA Female	EAR99	<a href="#">PEWCA1026</a>	\$711.31		46		
					SMA Female	EAR99	<a href="#">PEWCA1018</a>	\$801.97		47		
		0.3	1.29:1	Square Cover UG-597/U	2.92mm Female	EAR99	<a href="#">PEWCA1019</a>	\$564.90		48		
					2.92mm Female	EAR99	<a href="#">PE-W42CA001</a>	\$824.67		49		
					2.92mm Male	EAR99	<a href="#">PE-W42CA002</a>	\$812.50		50		
		0.3	1.3:1	Square Cover	2.92mm Female	EAR99	<a href="#">PEWCA1070</a>	\$944.03		51		
					SMA Female	EAR99	<a href="#">PEWCA1022</a>	\$616.04		52		
		WR-51	14.5-22	0.3	1.25:1	Square Cover	2.92mm Female	EAR99		<a href="#">PE9878</a>	\$618.80	53
						Square Cover UG-597/U	2.92mm Male	EAR99		<a href="#">PE9813A</a>	\$660.15	54
Square Type	2.92mm Female					EAR99	<a href="#">PE9812</a>	\$459.34	55			
UBR180	SMA Female					EAR99	<a href="#">PEWCA1099</a>	\$479.13	56			
Square Cover	SMA Female					EAR99	<a href="#">PEWCA1002A</a>	\$570.71	57			
WR-62	11.9-18	0.2	1.25:1	UBR140	SMA Female	EAR99	<a href="#">PEWCA1027</a>	\$795.98	58			
					SMA Female	EAR99	<a href="#">PE9828</a>	\$610.62	59			
					SMA Female	EAR99	<a href="#">PE9879</a>	\$819.05	60			
					N Female	EAR99	<a href="#">PEWCA1097</a>	\$418.28	61			



Technical Support  
+1 (949) 261-1920



Same-Day Shipping,  
Even Custom  
Cable Assemblies



## Waveguide to Coax Adapters



See Our Website For Current Pricing & Real-Time Stock Availability!

WG Type	RF Freq. (GHz.)	IL (dB)	Max VSWR	Flange Type	Connector	ECCN	Model No	1 Pc. Price	See Web for Volume Pricing	ROW	
WR-62	11.9-18	0.2	1.25:1	UBR140	SMA Female	EAR99	<a href="#">PEWCA1098</a>	\$418.28	See Web for Volume Pricing	62	
					SMA Female	EAR99	<a href="#">PEWCA1108</a>	\$471.51		63	
	12.4-18	0.3	1.25:1	Square Cover UG-1665/U	SMA Male	EAR99	<a href="#">PE9809</a>	\$303.48		64	
					N Female	EAR99	<a href="#">PEWCA1028</a>	\$702.17		65	
		1.3:1	1.25:1	Square Cover UG-419/U	SMA Female	EAR99	<a href="#">PEWCA1023</a>	\$580.46		66	
					SMA Female	EAR99	<a href="#">PEWCA1003</a>	\$538.33		67	
			1.3:1	1.3:1	Square Cover UG-1665/U	N Female	EAR99	<a href="#">PEWCA1072</a>		\$917.73	68
						SMA Female	EAR99	<a href="#">PEWCA1071</a>		\$798.75	69
	1.4:1	0.3	1.4:1	Square Type	SMA Female	EAR99	<a href="#">PE9803</a>	\$381.14		70	
					Square Cover	N Male	EAR99	<a href="#">PE9806</a>		\$669.56	71
	WR-75	10-15	0.2	1.25:1	Square Cover	N Female	EAR99	<a href="#">PEWCA1005</a>		\$720.90	75
						N Female	EAR99	<a href="#">PEWCA1029</a>		\$737.27	76
						SMA Female	EAR99	<a href="#">PEWCA1004</a>		\$658.63	77
			1.3:1	0.3		1.3:1	SMA Female	EAR99		<a href="#">PEWCA1024</a>	\$531.64
N Female							EAR99	<a href="#">PEWCA1074</a>	\$886.14	79	
SMA Female							EAR99	<a href="#">PEWCA1073</a>	\$797.69	80	
1.4:1		0.2	1.4:1	Square Type	N Female	EAR99	<a href="#">PE9874</a>	\$466.93	81		
					SMA Female	EAR99	<a href="#">PE9819</a>	\$368.09	82		
					N Female	EAR99	<a href="#">PE9867</a>	\$734.06	83		
					SMA Female	EAR99	<a href="#">PE9847</a>	\$677.32	84		
					SMA Female	EAR99	<a href="#">PEWCA1095</a>	\$418.28	85		
WR-90		8.2-12.4	0.2	1.25:1	UBR120	N Female	EAR99	<a href="#">PEWCA1096</a>	\$418.28	86	
					CMR-90	SMA Female	EAR99	<a href="#">PEWCA1033</a>	\$830.13	87	
						SMA Female	EAR99	<a href="#">PEWCA1032</a>	\$830.13	88	
	CPR-90G				N Male	EAR99	<a href="#">PEWCA1035</a>	\$691.19	89		
					N Female	EAR99	<a href="#">PEWCA1036</a>	\$748.99	90		
					N Female	EAR99	<a href="#">PEWCA1009</a>	\$608.55	91		
					SMA Female	EAR99	<a href="#">PEWCA1034</a>	\$690.83	92		
	Square Cover UG-135/U				SMA Female	EAR99	<a href="#">PEWCA1007</a>	\$565.64	93		
					N Female	EAR99	<a href="#">PE9868</a>	\$831.26	94		
					N Female	EAR99	<a href="#">PEWCA1031</a>	\$838.86	95		
					SMA Female	EAR99	<a href="#">PEWCA1075</a>	\$820.45	96		
					SMA Female	EAR99	<a href="#">PEWCA1025</a>	\$538.33	97		
					SMA Male	EAR99	<a href="#">PEWCA1030</a>	\$718.46	98		
	Square Cover UG-39/U				N Female	EAR99	<a href="#">PEWCA1008</a>	\$702.85	99		
SMA Female		EAR99	<a href="#">PEWCA1006</a>	\$678.76	1						
UBR100	N Female	EAR99	<a href="#">PEWCA1092</a>	\$418.28	2						
	SMA Female	EAR99	<a href="#">PEWCA1093</a>	\$418.28	3						
	SMA Female	EAR99	<a href="#">PEWCA1107</a>	\$471.51	4						
	CPR-90G	N Female	EAR99	<a href="#">PE9873</a>	\$486.75	5					
		N Female	EAR99	<a href="#">PE9801</a>	\$410.10	6					
	Square Type	N Male	EAR99	<a href="#">PE9889</a>	\$477.87	7					
SMA Female		EAR99	<a href="#">PE9804</a>	\$364.97	8						
SMA Male		EAR99	<a href="#">PE9810</a>	\$464.32	9						
SMA Female		EAR99	<a href="#">PE9848</a>	\$599.47	10						
WR-102	7-10	1.25:1	1.25:1	Square Cover UG-1493/U	SMA Female	EAR99	<a href="#">PEWCA1037</a>	\$773.91	11		
				Square Cover	N Female	EAR99	<a href="#">PE9869</a>	\$476.91	12		
	7-11	1.25:1	1.25:1	Square Cover UG-1493/U	N Female	EAR99	<a href="#">PEWCA1038</a>	\$830.70	13		
					N Male	EAR99	<a href="#">PEWCA1039</a>	\$830.70	14		
		1.3:1	1.3:1	Square Cover	SMA Female	EAR99	<a href="#">PE9805</a>	\$666.38	15		
					SMA Male	EAR99	<a href="#">PE9811</a>	\$352.21	16		
	1.4:1	1.4:1	1.4:1	Square Type	N Female	EAR99	<a href="#">PE9802</a>	\$497.48	17		
					N Male	EAR99	<a href="#">PE9890</a>	\$485.36	18		
	WR-112	6.57-9.99	0.2	1.25:1	UBR84	SMA Female	EAR99	<a href="#">PEWCA1089</a>	\$425.89	19	
						SMA Female	EAR99	<a href="#">PEWCA1090</a>	\$419.08	20	
SMA Female						EAR99	<a href="#">PEWCA1106</a>	\$509.54	21		
									22		

Waveguides

## Waveguide to Coax Adapters



WG Type	RF Freq. (GHz.)	IL (dB)	Max VSWR	Flange Type	Connector	ECCN	Model No	1 Pc. Price	See Web for Volume Pricing	ROW				
WR-112	7.05-10		1.25:1	CMR-112	N Female	EAR99	<a href="#">PEWCA1043</a>	\$741.18	See Web for Volume Pricing	23				
					SMA Female	EAR99	<a href="#">PEWCA1042</a>	\$713.35		24				
				CPR-112G	N Female	EAR99	<a href="#">PEWCA1045</a>	\$756.80		25				
					N Female	EAR99	<a href="#">PEWCA1013</a>	\$593.23		26				
					SMA Female	EAR99	<a href="#">PEWCA1044</a>	\$699.13		27				
					SMA Female	EAR99	<a href="#">PEWCA1011</a>	\$693.84		28				
				Square Cover UG-138/U	N Female	EAR99	<a href="#">PEWCA1041</a>	\$699.03		29				
					SMA Female	EAR99	<a href="#">PEWCA1040</a>	\$755.59		30				
				Square Cover UG-51/U	N Female	EAR99	<a href="#">PEWCA1012</a>	\$711.87		31				
					SMA Female	EAR99	<a href="#">PEWCA1010</a>	\$720.90		32				
				CPR-112G	1.3:1		1.4:1	Square Type		N Female	EAR99	<a href="#">PE9837</a>	\$639.79	33
										N Female	EAR99	<a href="#">PE9820</a>	\$410.56	34
N Female	EAR99	<a href="#">PE9870</a>	\$593.41					35						
SMA Female	EAR99	<a href="#">PE9884</a>	\$375.16					36						
SMA Female	EAR99	<a href="#">PE9865</a>	\$643.58	37										
WR-137	5.38-8.17	0.2	1.25:1	PDR70	N Female	EAR99	<a href="#">PEWCA1087</a>	\$492.33	38					
					N Female	EAR99	<a href="#">PEWCA1086</a>	\$438.30	39					
				UDR70	SMA Female	EAR99	<a href="#">PEWCA1088</a>	\$396.27	40					
					N Female	EAR99	<a href="#">PEWCA1049</a>	\$732.13	41					
				CMR-137	SMA Female	EAR99	<a href="#">PEWCA1048</a>	\$721.33	42					
					N Female	EAR99	<a href="#">PEWCA1051</a>	\$764.58	43					
	CPR-137G		N Female	EAR99	<a href="#">PEWCA1017</a>	\$604.50	44							
			SMA Female	EAR99	<a href="#">PEWCA1050</a>	\$732.13	45							
			SMA Female	EAR99	<a href="#">PEWCA1015</a>	\$624.15	46							
			N Female	EAR99	<a href="#">PEWCA1016</a>	\$753.67	47							
	Round Cover UG-344/U		SMA Female	EAR99	<a href="#">PEWCA1014</a>	\$624.15	48							
			N Female	EAR99	<a href="#">PEWCA1047</a>	\$764.58	49							
Round Cover UG-441/U	SMA Female	EAR99	<a href="#">PEWCA1046</a>	\$732.13	50									
	N Female	EAR99	<a href="#">PE9876</a>	\$229.32	51									
CMR-137	1.3:1	0.4	1.3:1	SMA Female	EAR99	<a href="#">PE9830</a>	\$539.07	52						
				N Female	EAR99	<a href="#">PE9838</a>	\$378.30	53						
WR-159	4.9-7.05		1.25:1	CMR-159	N Female	EAR99	<a href="#">PEWCA1053</a>	\$673.87	54					
					SMA Female	EAR99	<a href="#">PEWCA1052</a>	\$726.28	55					
				CPR-159G	N Female	EAR99	<a href="#">PEWCA1055</a>	\$673.87	56					
					SMA Female	EAR99	<a href="#">PEWCA1054</a>	\$699.03	57					
				CMR-159	N Female	EAR99	<a href="#">PE9821</a>	\$728.12	58					
					SMA Female	EAR99	<a href="#">PE9831</a>	\$673.53	59					
CPR-159G	N Female	EAR99	<a href="#">PE9839</a>	\$818.08	60									
WR-187	5.38-8.17	0.2	1.25:1	UDR58	SMA Female	EAR99	<a href="#">PEWCA1085</a>	\$480.32	61					
					N Female	EAR99	<a href="#">PEWCA1084</a>	\$527.16	62					
				PDR48	N Female	EAR99	<a href="#">PEWCA1083</a>	\$492.33	63					
					N Female	EAR99	<a href="#">PEWCA1105</a>	\$551.37	64					
				UDR48	SMA Female	EAR99	<a href="#">PEWCA1076</a>	\$435.57	65					
					N Female	EAR99	<a href="#">PEWCA1058</a>	\$581.96	66					
	CMR-187		SMA Female	EAR99	<a href="#">PEWCA1057</a>	\$670.97	67							
			N Female	EAR99	<a href="#">PEWCA1059</a>	\$581.96	68							
	CPR-187G		N Female	EAR99	<a href="#">PEWCA1056</a>	\$709.99	69							
			N Female	EAR99	<a href="#">PE9822</a>	\$490.87	70							
	Round Cover UG-407/U		SMA Female	EAR99	<a href="#">PE9832</a>	\$882.24	71							
			N Female	EAR99	<a href="#">PE9840</a>	\$916.05	72							
WR-229	3.3-4.9		1.25:1	CMR-229	N Female	EAR99	<a href="#">PEWCA1060</a>	\$692.60	73					
					N Female	EAR99	<a href="#">PEWCA1062</a>	\$692.60	74					
				CPR-229G	SMA Female	EAR99	<a href="#">PEWCA1061</a>	\$706.22	75					
					N Female	EAR99	<a href="#">PE9823</a>	\$629.15	76					
				CMR-229	SMA Female	EAR99	<a href="#">PE9833</a>	\$715.35	77					
					N Female	EAR99	<a href="#">PE9877</a>	\$974.03	78					
CPR-229G	N Female	EAR99	<a href="#">PEWCA1064</a>	\$731.17	79									
WR-284	2.6-3.95		1.25:1	CMR-284	N Female	EAR99	<a href="#">PE9834</a>	\$1,322.00	80					
					SMA Female	EAR99	<a href="#">PEWCA1065</a>	\$835.93	81					
				CPR-284G	N Female	EAR99	<a href="#">PEWCA1063</a>	\$1,035.66	82					
Round Cover UG-584/U	N Female	EAR99	<a href="#">PEWCA1063</a>	\$1,035.66	82									

See Our Website For Current Pricing & Real-Time Stock Availability!

See Web for Volume Pricing

Waveguides



Technical Support  
+1 (949) 261-1920



Same-Day Shipping,  
Even Custom  
Cable Assemblies

## Waveguide to Coax Adapters



WG Type	RF Freq. (GHz.)	IL (dB)	Max VSWR	Flange Type	Connector	ECCN	Model No	1 Pc. Price	See Web for Volume Pricing			ROW
WR-284	2.6-3.95	0.2	1.25:1	UDR32	N Female	EAR99	<a href="#">PEWCA1081</a>	\$638.82	See Web for Volume Pricing			83
					SMA Female	EAR99	<a href="#">PEWCA1082</a>	\$638.82				84
		1.3:1	CMR-284	N Female	EAR99	<a href="#">PE9824</a>	\$597.82	85				
			CPR-284G	N Female	EAR99	<a href="#">PE9842</a>	\$571.82	86				
WR-340	2.17-3.3	0.2	1.25:1	UDR26	N Female	EAR99	<a href="#">PEWCA1077</a>	\$653.89				87
				CPR-340F	N Female	EAR99	<a href="#">PEWCA1066</a>	\$1,404.15				88
	CPR-340G			N Female	EAR99	<a href="#">PEWCA1067</a>	\$1,383.44	89				
	2.2-3.3			CPR-430F	N Female	EAR99	<a href="#">PEWCA1068</a>	\$1,571.22				90
CPR-430G		N Female	EAR99	<a href="#">PEWCA1069</a>	\$1,620.34	91						
WR-430	1.7-2.6	0.2	1.3:1	CPR-430F	N Female	EAR99	<a href="#">PE9872</a>	\$1,405.01				92
					SMA Female	EAR99	<a href="#">PE9835</a>	\$1,512.25				93
				CPR-430G	N Female	EAR99	<a href="#">PE9843</a>	\$1,604.79				94
				1.72-2.61	0.3	1.25:1	UDR22	N Female	EAR99	<a href="#">PEWCA1079</a>	\$1,188.79	95
	SMA Female	EAR99	<a href="#">PEWCA1080</a>				\$1,110.74	96				

## Double Ridge Waveguide to Coax Adapters



WG Type	RF Freq. (GHz.)	IL (dB)	Max VSWR	Flange Type	Connector	ECCN	Model No	1-4	5-9	10-24	25+	ROW
WRD-180	18-40		1.6:1	Square Cover UG	2.92mm Female	EAR99	<a href="#">PEWCA1120</a>	\$1,468.42	\$1,395.00	\$1,321.58	\$1,262.84	97
				Square Cover	2.92mm Female	EAR99	<a href="#">PEWCA1115</a>	\$1,246.49	\$1,184.17	\$1,121.84	\$1,071.98	98
WRD-650	6.5-18	0.5	1.5:1	Square Cover UG	N Female	EAR99	<a href="#">PEWCA1111</a>	\$904.19	\$858.98	\$813.77	\$777.60	99
					N Female	EAR99	<a href="#">PEWCA1116</a>	\$1,323.18	\$1,257.02	\$1,190.86	\$1,137.93	1
					SMA Female	EAR99	<a href="#">PEWCA1112</a>	\$957.44	\$909.57	\$861.70	\$823.40	2
					SMA Female	EAR99	<a href="#">PEWCA1117</a>	\$1,323.18	\$1,257.02	\$1,190.86	\$1,137.93	3
WRD-750	7.5-18				N Female	EAR99	<a href="#">PEWCA1113</a>	\$1,063.94	\$1,010.74	\$957.55	\$914.99	4
					N Female	EAR99	<a href="#">PEWCA1118</a>	\$1,323.18	\$1,257.02	\$1,190.86	\$1,137.93	5
					SMA Female	EAR99	<a href="#">PEWCA1114</a>	\$1,194.09	\$1,134.39	\$1,074.68	\$1,026.92	6
					SMA Female	EAR99	<a href="#">PEWCA1119</a>	\$1,323.18	\$1,257.02	\$1,190.86	\$1,137.93	7

## Corner Reflectors



Description	Model No	1	2-4	5-9	10+	ROW
1.4 inch Edge Length, Trihedral Corner Reflector, 1/4-20 Threaded Hole Mount, Aluminum Body, Gold Chem Film Finish	<a href="#">PEWRL0000</a>	\$940.63	\$907.71	\$874.79	\$846.57	8
1.8 inch Edge Length, Trihedral Corner Reflector, 1/4-20 Threaded Hole Mount, Aluminum Body, Gold Chem Film Finish	<a href="#">PEWRL0001</a>	\$1,034.69	\$998.48	\$962.26	\$931.22	9
2.4 inch Edge Length, Trihedral Corner Reflector, 1/4-20 Threaded Hole Mount, Aluminum Body, Gold Chem Film Finish	<a href="#">PEWRL0002</a>	\$1,128.75	\$1,089.24	\$1,049.74	\$1,015.88	10
3.2 inch Edge Length, Trihedral Corner Reflector, 1/4-20 Threaded Hole Mount, Aluminum Body, Gold Chem Film Finish	<a href="#">PEWRL0003</a>	\$1,582.09	\$1,526.72	\$1,471.34	\$1,423.88	11
4.3 inch Edge Length, Trihedral Corner Reflector, 1/4-20 Threaded Hole Mount, Aluminum Body, Gold Chem Film Finish	<a href="#">PEWRL0004</a>	\$1,558.75	\$1,504.19	\$1,449.64	\$1,402.88	12
6 inch Edge Length, Trihedral Corner Reflector, 1/4-20 Threaded Hole Mount, Aluminum Body, Gold Chem Film Finish	<a href="#">PEWRL0005</a>	\$1,854.38	\$1,789.48	\$1,724.57	\$1,668.94	13
8 inch Edge Length, Trihedral Corner Reflector, 1/4-20 Threaded Hole Mount, Aluminum Body, Gold Chem Film Finish	<a href="#">PEWRL0006</a>	\$2,203.75	\$2,126.62	\$2,049.49	\$1,983.38	14
8.5 inch Edge Length, Trihedral Corner Reflector, 1/4-20 Threaded Hole Mount, Aluminum Body, Gold Chem Film Finish	<a href="#">PEWRL0007</a>	\$2,526.25	\$2,437.83	\$2,349.41	\$2,273.63	15

### Corner Reflectors



Description	Model No	1	2-4	5-9	10+	ROW
8.9 inch Edge Length, Trihedral Corner Reflector, 1/4-20 Threaded Hole Mount, Aluminum Body, Gold Chem Film Finish	<a href="#">PEWRL0008</a>	\$2,821.88	\$2,723.11	\$2,624.35	\$2,539.69	16
10 inch Edge Length, Trihedral Corner Reflector, 1/4-20 Threaded Hole Mount, Aluminum Body, Gold Chem Film Finish	<a href="#">PEWRL0009</a>	\$3,359.38	\$3,241.80	\$3,124.22	\$3,023.44	17
13 inch Edge Length, Trihedral Corner Reflector, 1/4-20 Threaded Hole Mount, Aluminum Body, Gold Chem Film Finish	<a href="#">PEWRL0010</a>	\$3,896.88	\$3,760.49	\$3,624.10	\$3,507.19	18
13.5 inch Edge Length, Trihedral Corner Reflector, 1/4-20 Threaded Hole Mount, Aluminum Body, Gold Chem Film Finish	<a href="#">PEWRL0011</a>	\$4,434.38	\$4,279.18	\$4,123.97	\$3,990.94	19
16 inch Edge Length, Trihedral Corner Reflector, 1/4-20 Threaded Hole Mount, Aluminum Body, Gold Chem Film Finish	<a href="#">PEWRL0012</a>	\$6,450.00	\$6,224.25	\$5,998.50	\$5,805.00	20
24 inch Edge Length, Trihedral Corner Reflector, 1/4-20 Threaded Hole Mount, Aluminum Body, Gold Chem Film Finish	<a href="#">PEWRL0013</a>	\$8,868.75	\$8,558.34	\$8,247.94	\$7,981.88	21

### WAVEGUIDE BANDPASS FILTERS



Waveguide Type	RF Frequency (GHz.)	Max VSWR	Flange Type	ECCN	Model No	1-9	10-24	25-49	50+	ROW
WR-28	30 - 31	1.4:1	Square Cover	EAR99	<a href="#">PE-W28F001</a>	\$396.26	\$376.45	\$356.63	\$340.78	22
	38 - 40	1.5:1		EAR99	<a href="#">PE-W28F002</a>	\$409.60	\$389.12	\$368.64	\$352.26	23
WR-42	20.2 - 21.2	1.5:1		EAR99	<a href="#">PE-W42F001</a>	\$407.32	\$386.95	\$366.59	\$350.30	24
	24.25 - 24.45	1.8:1		EAR99	<a href="#">PE-W42F002</a>	\$380.36	\$365.15	\$353.73	\$346.13	25
		1.5:1		EAR99	<a href="#">PE-W42F003</a>	\$397.91	\$378.01	\$358.12	\$342.20	26
		1.5:1		EAR99	<a href="#">PE-W42F004</a>	\$397.91	\$378.01	\$358.12	\$342.20	26

### WAVEGUIDE BENDS



Waveguide Type	RF Frequency (GHz.)	Insertion Loss (dB)	Bend Plane	Flange Type	ECCN	Model No	1 Pc. Price	See Web for Volume Pricing		ROW
WR-5	140 - 220	0	E-Bend	Round Cover UG-383/U-Mod	EAR99	<a href="#">PEW5B0000</a>	\$571.82	See Web for Volume Pricing		27
			H-Bend		EAR99	<a href="#">PEW5B0001</a>	\$563.39			28
WR-6	110 - 170	0.35	E-Bend		EAR99	<a href="#">PEW6B0000</a>	\$539.40			29
			H-Bend		EAR99	<a href="#">PEW6B0001</a>	\$539.40			30
WR-8	90 - 140	0.3	E-Bend		EAR99	<a href="#">PEW8B0000</a>	\$539.40			31
			H-Bend		EAR99	<a href="#">PEW8B0001</a>	\$531.44			32
WR-10	75 - 110	0.21	E-Bend		EAR99	<a href="#">PE-W10B001</a>	\$525.93			33
			H-Bend		EAR99	<a href="#">PE-W10B002</a>	\$525.93			34
WR-12	60 - 90		E-Bend		EAR99	<a href="#">PE-W12B001</a>	\$443.11			35
			H-Bend		EAR99	<a href="#">PE-W12B002</a>	\$430.69			36
WR-15	50 - 75	0.17	E-Bend	EAR99	<a href="#">PE-W15B001</a>	\$583.98	37			
			H-Bend	EAR99	<a href="#">PE-W15B002</a>	\$583.98	38			
WR-19	40 - 60	0.18	E-Bend	EAR99	<a href="#">PE-W19B001</a>	\$420.58	39			
			H-Bend	EAR99	<a href="#">PE-W19B002</a>	\$420.58	40			
WR-22	33 - 50	0.16	E-Bend	EAR99	<a href="#">PE-W22B001</a>	\$420.58	41			
			H-Bend	EAR99	<a href="#">PEW22B100</a>	\$398.85	42			
		0.25	E-Bend	EAR99	<a href="#">PEW22B101</a>	\$398.85	43			
WR-28	26.5 - 40	0.28	E-Bend	EAR99	<a href="#">PE-W28B001</a>	\$450.04	44			
			H-Bend	EAR99	<a href="#">PE-W28B002</a>	\$560.44	45			
		0.3	E-Bend	EAR99	<a href="#">PE-W28B003</a>	\$464.81	46			



## WAVEGUIDE BENDS



See Our Website For Current Pricing & Real-Time Stock Availability!

Waveguide Type	RF Frequency (GHz.)	Insertion Loss (dB)	Bend Plane	Flange Type	ECCN	Model No	1 Pc. Price	See Web for Volume Pricing	ROW
WR-42	18 - 26.5	0.15	H-Bend	Square Cover UG-595/U	EAR99	<a href="#">PEW42B100</a>	\$433.14	See Web for Volume Pricing	47
		0.2			EAR99	<a href="#">PEW42B101</a>	\$443.40		48
WR-51	15 - 22	0.09	E-Bend	UBR180	EAR99	<a href="#">PE-W51B001</a>	\$409.60		49
WR-62	12.4 - 18				EAR99	<a href="#">PE-W62B003</a>	\$409.60		50
			EAR99	<a href="#">PE-W62B004</a>	\$438.27	51			
			EAR99	<a href="#">PE-W62B001</a>	\$455.47	52			
			EAR99	<a href="#">PE-W62B002</a>	\$421.36	53			
WR-75	10 - 15		E-Bend	UBR120	EAR99	<a href="#">PE-W75B001</a>	\$462.43		54
		EAR99			<a href="#">PE-W75B002</a>	\$498.91	55		
WR-90	8.2 - 12.4	0.15	E-Bend	Square Cover UG-39/U	EAR99	<a href="#">PE-W90B001</a>	\$423.85		56
					EAR99	<a href="#">PE-W90B002</a>	\$433.35		57
			H-Bend	CPR-90G	EAR99	<a href="#">PE-W90B003A</a>	\$424.94		58
					EAR99	<a href="#">PE-W90B004A</a>	\$372.16		59
WR-112	7.05 - 10	E-Bend	Square Cover UG-51/U	EAR99	<a href="#">PE-W112B001</a>	\$615.39	60		
				EAR99	<a href="#">PE-W112B002</a>	\$521.91	61		
WR-137	5.85 - 8.2	0.15	E-Bend	Round Cover UG-344/U	EAR99	<a href="#">PE-W137B001</a>	\$443.90		62
					EAR99	<a href="#">PE-W137B002</a>	\$468.13		63
			H-Bend	CPR-137G	EAR99	<a href="#">PE-W137B003A</a>	\$548.21		64
					EAR99	<a href="#">PE-W137B004</a>	\$540.12		65
WRD-180	18 - 40	0.4	E-Bend	Square Cover UG	EAR99	<a href="#">PEWRD180B001</a>	\$742.28		66
WRD-650	6.5 - 18				EAR99	<a href="#">PEWRD180B002</a>	\$742.28	67	
			WRD-750	7.5 - 18	EAR99	<a href="#">PEWRD650B001</a>	\$661.59	68	
EAR99	<a href="#">PEWRD650B002</a>				\$661.59	69			
				E-Bend		EAR99	<a href="#">PEWRD750B001</a>	\$661.59	70
				H-Bend		EAR99	<a href="#">PEWRD750B002</a>	\$661.59	71

## WAVEGUIDE BULKHEAD ADAPTERS



Waveguides

Frequency Range (GHz.)	Waveguide Size	Flange 1	Flange 2	Model No	1 Pc. Price	See Web for Volume Pricing	ROW
75.0 - 110.0	WR-10	Round Cover UG-387/U-Mod	Round Cover UG-387/U-Mod	<a href="#">PEWAD5000</a>	\$1,112.30	See Web for Volume Pricing	72
60.0 - 90.0	WR-12	Round Cover UG-387/U	Round Cover UG-387/U	<a href="#">PEWAD5001</a>	\$1,006.21		73
50.0 - 75.0	WR-15	Round Cover UG-385/U	Round Cover UG-385/U	<a href="#">PEWAD5002</a>	\$1,006.21		74
40.0 - 60.0	WR-19	Round Cover UG-383/U-Mod	Round Cover UG-383/U-Mod	<a href="#">PEWAD5003</a>	\$991.36		75
			Round Cover UG-383/U	<a href="#">PEWAD5007A</a>	\$924.78		76
33.0 - 50.0	WR-22	Round Cover UG-383/U	Round Cover UG-383/U	<a href="#">PEWAD5004</a>	\$991.36		77
			Square Cover UG-599/U	<a href="#">PEWAD5008</a>	\$803.46		78
26.5 - 40.0	WR-28	Square Cover UG-599/U	Square Cover UG-599/U	<a href="#">PEWAD5005</a>	\$1,126.96		79
22.0 - 33.0	WR-34	Square Cover UG-1530/U	Square Cover UG-1530/U	<a href="#">PEWAD5009</a>	\$818.50		80
			Square Cover UG-595/U	<a href="#">PEWAD5010</a>	\$841.02		81
18.0 - 26.5	WR-42	Square Cover UG-595/U	Square Cover UG-595/U	<a href="#">PEWAD5006</a>	\$1,126.96		82
15.0 - 22.0	WR-51	Square Cover	Square Cover	<a href="#">PEWAD5011</a>	\$843.40		83
12.4 - 18.0	WR-62	Square Cover UG-1665/U	Square Cover UG-1665/U	<a href="#">PEWAD5012</a>	\$893.57		84
10.0 - 15.0	WR-75	Square Cover	Square Cover	<a href="#">PEWAD5013</a>	\$919.87		85
8.2 - 12.4	WR-90	Square Cover UG-39/U	Square Cover UG-39/U	<a href="#">PEWAD5014</a>	\$953.66		86
		CPR-90G	CPR-90G	<a href="#">PEWAD5015</a>	\$953.66		87
7.05 - 10.0	WR-112	Square Cover UG-51/U	Square Cover UG-51/U	<a href="#">PEWAD5016</a>	\$991.36		88
		CPR-112G	CPR-112G	<a href="#">PEWAD5017</a>	\$1,006.21		89
5.85 - 8.2	WR-137	Square Cover UG-344/U	Square Cover UG-344/U	<a href="#">PEWAD5018</a>	\$1,058.77		90
		CPR-137G	CPR-137G	<a href="#">PEWAD5019</a>	\$1,058.77		91

## WAVEGUIDE CONVERTER MIXERS

### Down Converter



RF/LO Frequency (GHz.)	IF Frequency (GHz.)	LO Power (dBm)	Typ Conv. Loss (dB)	RF & LO Waveguide Type	IF Connector	ECCN	Model No	1	2-4	5-9	10+	ROW
26.5 - 40	DC - 18	15	6	WR-28 UG-599/U	SMA Female	EAR99	<a href="#">PE12D1005</a>	\$3,834.26	\$3,680.89	\$3,527.52	\$3,374.15	92
33 - 50	DC - 18	15	7	WR-22 UG-383/U	SMA Female	EAR99	<a href="#">PE12D1004</a>	\$4,417.94	\$4,241.22	\$4,064.50	\$3,887.79	93
50 - 75	DC - 18	15	8	WR-15 UG-385/U	SMA Female	EAR99	<a href="#">PE12D1002</a>	\$4,984.84	\$4,785.45	\$4,586.05	\$4,386.66	94
60 - 90	DC - 18	15	9	WR-12 UG-387/U	SMA Female	EAR99	<a href="#">PE12D1001</a>	\$4,638.43	\$4,452.89	\$4,267.36	\$4,081.82	95
75 - 110	DC - 18	15	9	WR-10 UG-387/U-Mod	SMA Female	EAR99	<a href="#">PE12D1000</a>	\$6,521.71	\$6,260.84	\$5,999.97	\$5,739.10	96

### Up Converter



RF/LO Frequency (GHz.)	IF Frequency (GHz.)	LO Power (dBm)	Typ Conv. Loss (dB)	RF & LO Waveguide Type	IF Connector	ECCN	Model No	1	2-4	5-9	10+	ROW
26.5 - 40	DC - 18	15	6	WR-28 UG-599/U	SMA Female	EAR99	<a href="#">PE13U1005</a>	\$4,151.05	\$3,985.01	\$3,818.97	\$3,652.92	97
33 - 50	DC - 18	15	7	WR-22 UG-383/U	SMA Female	EAR99	<a href="#">PE13U1004</a>	\$5,023.61	\$4,822.67	\$4,621.72	\$4,420.78	98
40 - 60	DC - 18	15	7	WR-19 UG-383/U	SMA Female	EAR99	<a href="#">PE13U1003</a>	\$5,194.53	\$4,986.75	\$4,778.97	\$4,571.19	99
50 - 75	DC - 18	15	8	WR-15 UG-385/U	SMA Female	EAR99	<a href="#">PE13U1002</a>	\$5,983.77	\$5,744.42	\$5,505.07	\$5,265.72	1
60 - 90	DC - 18	15	9	WR-12 UG-387/U	SMA Female	EAR99	<a href="#">PE13U1001</a>	\$5,540.23	\$5,318.62	\$5,097.01	\$4,875.40	2
75 - 110	DC - 18	15	9	WR-10 UG-387/U	SMA Female	EAR99	<a href="#">PE13U1000</a>	\$5,579.55	\$5,356.37	\$5,133.19	\$4,910.00	3

## WAVEGUIDE COUPLERS

### Broadwall



WG Type	RF Freq. (GHz.)	IL (dB)	Max VSWR	Coupling (dB)	Directivity (dB)	Flange Type	ECCN	Model No	1	2-4	5-9	10+	ROW
WR-10	75 - 110	1.1	1.2:1	20	30	Round Cover UG-387/U-Mod	EAR99	<a href="#">PE-W10CP001-20</a>	\$2,520.34	\$2,419.53	\$2,318.71	\$2,217.90	4
				20	30		EAR99	<a href="#">PE-W10CP003-20</a>	\$2,797.74	\$2,685.83	\$2,573.92	\$2,462.01	5
		1.4		10	30	EAR99	<a href="#">PE-W10CP001-10</a>	\$2,520.34	\$2,419.53	\$2,318.71	\$2,217.90	6	
				10	30	EAR99	<a href="#">PE-W10CP003-10</a>	\$2,797.74	\$2,685.83	\$2,573.92	\$2,462.01	7	
WR-12	60 - 90	1	1.2:1	20	30	Round Cover UG-387/U	EAR99	<a href="#">PEW10CP10-20</a>	\$2,653.00	\$2,546.88	\$2,440.76	\$2,334.64	8
				20	30		EAR99	<a href="#">PE-W12CP001-20</a>	\$2,682.26	\$2,574.97	\$2,467.68	\$2,360.39	9
		1.4		20	30	EAR99	<a href="#">PE-W12CP003-20</a>	\$2,714.84	\$2,606.25	\$2,497.65	\$2,389.06	10	
				10	30	EAR99	<a href="#">PE-W12CP001-10</a>	\$2,682.26	\$2,574.97	\$2,467.68	\$2,360.39	11	
WR-15	50 - 75	1	1.1:1	20	30	Round Cover UG-385/U	EAR99	<a href="#">PE-W12CP003-10</a>	\$2,823.43	\$2,710.49	\$2,597.56	\$2,484.62	12
				20	30		EAR99	<a href="#">PEWCP1080-20</a>	\$2,515.43	\$2,414.81	\$2,314.20	\$2,213.58	13
		1.4		20	30	EAR99	<a href="#">PE-W15CP001-20</a>	\$2,613.53	\$2,508.99	\$2,404.45	\$2,299.91	14	
				10	30	EAR99	<a href="#">PE-W15CP001-10</a>	\$2,528.32	\$2,427.19	\$2,326.05	\$2,224.92	15	
WR-19	40 - 60	0.8	1.2:1	10	30	Round Cover UG-383/U	EAR99	<a href="#">PE-W15CP003-10</a>	\$2,823.43	\$2,710.49	\$2,597.56	\$2,484.62	16
				20	30		EAR99	<a href="#">PE-W19CP003-10</a>	\$2,642.30	\$2,536.61	\$2,430.92	\$2,325.22	17
		1		20	30	EAR99	<a href="#">PE-W19CP003-20</a>	\$2,590.49	\$2,486.87	\$2,383.25	\$2,279.63	18	
				10	30	EAR99	<a href="#">PE-W19CP001-20</a>	\$2,333.65	\$2,240.30	\$2,146.96	\$2,053.61	19	
WR-22	33 - 50	0.8	1.1:1	20	30	Round Cover UG-383/U	EAR99	<a href="#">PE-W19CP001-10</a>	\$2,333.65	\$2,240.30	\$2,146.96	\$2,053.61	20
				20	30		EAR99	<a href="#">PEW22CP10-20</a>	\$2,397.79	\$2,301.88	\$2,205.97	\$2,110.06	21
		1		20	30	EAR99	<a href="#">PE-W22CP003-20</a>	\$2,629.47	\$2,524.29	\$2,419.11	\$2,313.93	22	
				10	30	EAR99	<a href="#">PEWCP1079-10</a>	\$2,491.03	\$2,391.39	\$2,291.75	\$2,192.11	23	
1.2	1.2:1	10	30	EAR99	<a href="#">PE-W22CP001-10</a>	\$2,528.32	\$2,427.19	\$2,326.05	\$2,224.92	24			

See Our Website For Current Pricing & Real-Time Stock Availability!

Waveguides



Technical Support  
+1 (949) 261-1920



Same-Day Shipping,  
Even Custom  
Cable Assemblies

## Broadwall



WG Type	RF Freq. (GHz.)	IL (dB)	Max VSWR	Coupling (dB)	Directivity (dB)	Flange Type	ECCN	Model No	1	2-4	5-9	10+	ROW
WR-28	26.5 - 40	0.6	1.1:1	20	30	Square Cover UG-599/U	EAR99	<a href="#">PEW28CP010-20</a>	\$2,445.43	\$2,347.61	\$2,249.80	\$2,151.98	25
		0.7	1.05:1	20	40		EAR99	<a href="#">PE-W28CP002-20</a>	\$2,445.43	\$2,347.61	\$2,249.80	\$2,151.98	26
		1	1.2:1	10	30		EAR99	<a href="#">PE-W28CP003-10</a>	\$2,543.25	\$2,441.52	\$2,339.79	\$2,238.06	27
WR-34	22 - 33	0.15	1.05:1	20	35	Square Cover UG-1530/U	EAR99	<a href="#">PEWCP1006</a>	\$1,645.92	\$1,580.08	\$1,514.25	\$1,448.41	29
				30	35		EAR99	<a href="#">PEWCP1007</a>	\$1,645.92	\$1,580.08	\$1,514.25	\$1,448.41	30
		0.35	10	35	EAR99	<a href="#">PEWCP1005</a>	\$1,584.14	\$1,520.77	\$1,457.41	\$1,394.04	31		
WR-42	18 - 26.5	0.6	1.2:1	20	30	Square Cover UG-595/U	EAR99	<a href="#">PE-W42CP002-20</a>	\$2,445.43	\$2,347.61	\$2,249.80	\$2,151.98	32
				20	30		EAR99	<a href="#">PE-W42CP004-20</a>	\$2,505.73	\$2,405.50	\$2,305.27	\$2,205.04	33
		1	10	30	EAR99	<a href="#">PE-W42CP004-10</a>	\$2,505.73	\$2,405.50	\$2,305.27	\$2,205.04	34		
WR-51	15 - 22	0.15	1.05:1	10	35	Square Cover	EAR99	<a href="#">PEWCP1008</a>	\$1,614.41	\$1,549.83	\$1,485.26	\$1,420.68	35
				20	35		EAR99	<a href="#">PEWCP1009</a>	\$1,614.41	\$1,549.83	\$1,485.26	\$1,420.68	36
				30	35		EAR99	<a href="#">PEWCP1010</a>	\$1,678.98	\$1,611.82	\$1,544.66	\$1,477.50	37
WR-62	12.4 - 18	0.15	1.05:1	10	40	Square Cover UG-419/U	EAR99	<a href="#">PEWCP1011</a>	\$1,441.15	\$1,383.50	\$1,325.86	\$1,268.21	38
				20	40		EAR99	<a href="#">PEWCP1012</a>	\$1,498.79	\$1,438.84	\$1,378.89	\$1,318.94	39
				30	40		EAR99	<a href="#">PEWCP1013</a>	\$1,498.79	\$1,438.84	\$1,378.89	\$1,318.94	40
WR-75	10 - 15	0.15	1.05:1	10	40	Square Cover	EAR99	<a href="#">PEWCP1014</a>	\$1,388.99	\$1,333.43	\$1,277.87	\$1,222.31	41
				20	40		EAR99	<a href="#">PEWCP1015</a>	\$1,388.99	\$1,333.43	\$1,277.87	\$1,222.31	42
				30	40		EAR99	<a href="#">PEWCP1016</a>	\$1,523.37	\$1,462.44	\$1,401.50	\$1,340.57	43
WR-90	8.2 - 12.4	0.15	1.05:1	10	40	Square Cover UG-39/U	EAR99	<a href="#">PEWCP1017</a>	\$1,687.17	\$1,619.68	\$1,552.20	\$1,484.71	44
				10	40	CPR-90G	EAR99	<a href="#">PEWCP1020</a>	\$1,545.81	\$1,483.98	\$1,422.15	\$1,360.31	45
				20	40	Square Cover UG-39/U	EAR99	<a href="#">PEWCP1018</a>	\$1,622.29	\$1,557.40	\$1,492.51	\$1,427.62	46
				20	40	CPR-90G	EAR99	<a href="#">PEWCP1021</a>	\$1,545.81	\$1,483.98	\$1,422.15	\$1,360.31	47
				30	40	Square Cover UG-39/U	EAR99	<a href="#">PEWCP1019</a>	\$1,687.17	\$1,619.68	\$1,552.20	\$1,484.71	48
WR-112	7.05 - 10	0.15	1.05:1	30	40	CPR-90G	EAR99	<a href="#">PEWCP1022</a>	\$1,568.96	\$1,506.20	\$1,443.44	\$1,380.68	49
				10	40	Square Cover UG-51/U	EAR99	<a href="#">PEWCP1023A</a>	\$1,500.67	\$1,440.64	\$1,380.62	\$1,320.59	50
				10	40	CPR-112G	EAR99	<a href="#">PEWCP1026</a>	\$1,471.15	\$1,412.30	\$1,353.46	\$1,294.61	51
				20	40	Square Cover UG-51/U	EAR99	<a href="#">PEWCP1024</a>	\$1,418.88	\$1,362.12	\$1,305.37	\$1,248.61	52
				20	40	CPR-112G	EAR99	<a href="#">PEWCP1027</a>	\$1,471.15	\$1,412.30	\$1,353.46	\$1,294.61	53
WR-137	5.85 - 8.2	0.15	1.05:1	30	40	Square Cover UG-51/U	EAR99	<a href="#">PEWCP1025</a>	\$1,496.29	\$1,436.44	\$1,376.59	\$1,316.74	54
				30	40	CPR-112G	EAR99	<a href="#">PEWCP1028</a>	\$1,471.15	\$1,412.30	\$1,353.46	\$1,294.61	55
				10	40	Round Cover UG-344/U	EAR99	<a href="#">PEWCP1029</a>	\$1,501.01	\$1,440.97	\$1,380.93	\$1,320.89	56
				10	40	CPR-137G	EAR99	<a href="#">PEWCP1032</a>	\$1,576.55	\$1,513.49	\$1,450.43	\$1,387.36	57
				20	40	Round Cover UG-344/U	EAR99	<a href="#">PEWCP1030</a>	\$1,501.01	\$1,440.97	\$1,380.93	\$1,320.89	58
WR-137	5.85 - 8.2	0.15	1.05:1	20	40	CPR-137G	EAR99	<a href="#">PEWCP1033</a>	\$1,553.29	\$1,491.16	\$1,429.03	\$1,366.90	59
				30	40	Round Cover UG-344/U	EAR99	<a href="#">PEWCP1031</a>	\$1,501.01	\$1,440.97	\$1,380.93	\$1,320.89	60
				30	40	CPR-137G	EAR99	<a href="#">PEWCP1034</a>	\$1,638.04	\$1,572.52	\$1,507.00	\$1,441.48	61

## Crossguide\*



WG Type	RF Freq. (GHz.)	IL (dB)	Max VSWR	Coupling (dB)	Directivity (dB)	Flange Type	ECCN	Model No	1-4	5-9	10-24	25+	ROW
WR-34	22 - 33	0.1	1.05:1	20	20	Square Cover UG-1530/U	EAR99	<a href="#">PEWCP1035</a>	\$1,050.83	\$998.29	\$945.75	\$903.71	62
				30	20		EAR99	<a href="#">PEWCP1036</a>	\$1,094.80	\$1,040.06	\$985.32	\$941.53	63
				40	25		EAR99	<a href="#">PEWCP1037</a>	\$1,066.57	\$1,013.24	\$959.91	\$917.25	64
WR-42	18 - 26.5	0.1	1.05:1	50	10	Square Cover UG-595/U	EAR99	<a href="#">PEWCP1038</a>	\$1,050.83	\$998.29	\$945.75	\$903.71	65
				20	30		EAR99	<a href="#">PEWCP1039</a>	\$850.01	\$807.51	\$765.01	\$731.01	66
				30	20		EAR99	<a href="#">PEWCP1040</a>	\$918.48	\$872.56	\$826.63	\$789.89	67
				40	20		EAR99	<a href="#">PEWCP1041</a>	\$837.46	\$795.59	\$753.71	\$720.22	68
WR-42	18 - 26.5	0.1	1.05:1	50	10	EAR99	<a href="#">PEWCP1042</a>	\$918.48	\$872.56	\$826.63	\$789.89	69	

\*These WG crossguide couplers are available as assemblies with termination and/or with WG to Coax Adapters, see WG Coupler Assemblies or visit our website

## Crossguide\*



WG Type	RF Freq. (GHz.)	IL (dB)	Max VSWR	Coupling (dB)	Directivity (dB)	Flange Type	ECCN	Model No	1 Pc. Price	See Web for Volume Pricing	ROW
WR-51	15 - 22	0.1	1.05:1	20	20	Square Cover	EAR99	<a href="#">PEWCP1043</a>	\$1,293.51		70
				30	30		EAR99	<a href="#">PEWCP1044</a>	\$1,293.51		71
				40	30		EAR99	<a href="#">PEWCP1045</a>	\$1,293.51		72
				50	10		EAR99	<a href="#">PEWCP1046</a>	\$1,293.51		73
WR-62	12.4 - 18	0.1	1.05:1	20	20	Square Cover UG-419/U	EAR99	<a href="#">PEWCP1047</a>	\$883.15		74
				30	10		EAR99	<a href="#">PEWCP1048</a>	\$883.15		75
				40	30		EAR99	<a href="#">PEWCP1049</a>	\$837.46		76
				50	10		EAR99	<a href="#">PEWCP1050</a>	\$837.46		77
WR-75	10 - 15	0.1	1.05:1	50	10	Square Cover	EAR99	<a href="#">PEWCP1054</a>	\$842.78		78
				20	25		EAR99	<a href="#">PEWCP1051</a>	\$875.66		79
				30	25		EAR99	<a href="#">PEWCP1052A</a>	\$868.91		80
				40	15		EAR99	<a href="#">PEWCP1053</a>	\$888.77		81
WR-90	8.2 - 12.4	0.1	1.05:1	20	20	Square Cover UG-39/U	EAR99	<a href="#">PEWCP1055</a>	\$793.93	See Web for Volume Pricing	82
				20	25	CPR-90G	EAR99	<a href="#">PEWCP1059</a>	\$880.12		83
				30	20	Square Cover UG-39/U	EAR99	<a href="#">PEWCP1056</a>	\$833.74		84
				30	20	CPR-90G	EAR99	<a href="#">PEWCP1060</a>	\$880.12		85
				40	10	Square Cover UG-39/U	EAR99	<a href="#">PEWCP1057</a>	\$900.92		86
				40	10	CPR-90G	EAR99	<a href="#">PEWCP1061</a>	\$880.12		87
				50	10	Square Cover UG-39/U	EAR99	<a href="#">PEWCP1058</a>	\$900.92		88
				50	10	CPR-90G	EAR99	<a href="#">PEWCP1062</a>	\$951.03		89
WR-112	7.05 - 10	0.1	1.05:1	20	45	Square Cover UG-51/U	EAR99	<a href="#">PEWCP1063</a>	\$959.04		90
				20	25	CPR-112G	EAR99	<a href="#">PEWCP1067</a>	\$954.80		91
				30	25	Square Cover UG-51/U	EAR99	<a href="#">PEWCP1064</a>	\$996.45		92
				30	25	CPR-112G	EAR99	<a href="#">PEWCP1068</a>	\$969.10		93
				40	20	Square Cover UG-51/U	EAR99	<a href="#">PEWCP1065</a>	\$944.90		94
				40	20	CPR-112G	EAR99	<a href="#">PEWCP1069</a>	\$954.80		95
				50	10	Square Cover UG-51/U	EAR99	<a href="#">PEWCP1066</a>	\$1,036.32		96
				50	10	CPR-112G	EAR99	<a href="#">PEWCP1070</a>	\$1,047.18		97
WR-137	5.85 - 8.2	0.1	1.05:1	20	25	Round Cover UG-344/U	EAR99	<a href="#">PEWCP1071</a>	\$960.13		98
				20	20	CPR-137G	EAR99	<a href="#">PEWCP1075</a>	\$917.47		99
				30	20	Round Cover UG-344/U	EAR99	<a href="#">PEWCP1072</a>	\$960.13		1
				30	20	CPR-137G	EAR99	<a href="#">PEWCP1076</a>	\$931.21		2
				40	20	Round Cover UG-344/U	EAR99	<a href="#">PEWCP1073</a>	\$960.13		3
				40	20	CPR-137G	EAR99	<a href="#">PEWCP1077</a>	\$917.47		4
				50	10	Round Cover UG-344/U	EAR99	<a href="#">PEWCP1074</a>	\$960.13		5
				50	10	CPR-137G	EAR99	<a href="#">PEWCP1078</a>	\$917.47		6

## Crossguide\* with Termination



WG Type	RF Freq. (GHz.)	IL (dB)	Max VSWR	Coupling (dB)	Directivity (dB)	Flange Type	ECCN	Model No	1	2-4	5-9	10+	ROW
WR-34	22 - 33	0.1	1.05:1	20	20	Square Cover UG-1530/U	EAR99	<a href="#">PEWCT1000</a>	\$1,657.10	\$1,590.82	\$1,524.53	\$1,458.25	7
				30	20		EAR99	<a href="#">PEWCT1001</a>	\$1,657.10	\$1,590.82	\$1,524.53	\$1,458.25	8
				40	25		EAR99	<a href="#">PEWCT1002</a>	\$1,747.50	\$1,677.60	\$1,607.70	\$1,537.80	9
				50	10		EAR99	<a href="#">PEWCT1003</a>	\$1,657.10	\$1,590.82	\$1,524.53	\$1,458.25	10
WR-42	18 - 26.5	0.1	1.05:1	20	30	Square Cover UG-595/U	EAR99	<a href="#">PEWCT1004</a>	\$1,410.66	\$1,354.23	\$1,297.81	\$1,241.38	11
				30	20		EAR99	<a href="#">PEWCT1005</a>	\$1,410.66	\$1,354.23	\$1,297.81	\$1,241.38	12
				40	20		EAR99	<a href="#">PEWCT1006</a>	\$1,410.66	\$1,354.23	\$1,297.81	\$1,241.38	13
				50	10		EAR99	<a href="#">PEWCT1007</a>	\$1,410.66	\$1,354.23	\$1,297.81	\$1,241.38	14

\*These WG crossguide couplers are available as assemblies with termination and/or with WG to Coax Adapters, see WG Coupler Assemblies or visit our website



Technical Support  
+1 (949) 261-1920



Same-Day Shipping,  
Even Custom Cable Assemblies

See Our Website For Current Pricing & Real-Time Stock Availability!

Waveguides



### Crossguide\* with Termination



WG Type	RF Freq. (GHz.)	IL (dB)	Max VSWR	Coupling (dB)	Directivity (dB)	Flange Type	ECCN	Model No	1	2-4	5-9	10+	ROW
WR-51	15 - 22	0.1	1.05:1	20	20	Square Cover	EAR99	<a href="#">PEWCT1008</a>	\$1,880.01	\$1,804.81	\$1,729.61	\$1,654.41	15
				30	30			<a href="#">PEWCT1009</a>	\$1,880.01	\$1,804.81	\$1,729.61	\$1,654.41	16
				40	30			<a href="#">PEWCT1010</a>	\$1,880.01	\$1,804.81	\$1,729.61	\$1,654.41	17
				50	10			<a href="#">PEWCT1011</a>	\$1,880.01	\$1,804.81	\$1,729.61	\$1,654.41	18
WR-62	12.4 - 18	0.1	1.05:1	20	20	Square Cover UG-419/U	EAR99	<a href="#">PEWCT1012</a>	\$1,395.72	\$1,339.89	\$1,284.06	\$1,228.23	19
				30	10			<a href="#">PEWCT1013</a>	\$1,471.87	\$1,413.00	\$1,354.12	\$1,295.25	20
				40	30			<a href="#">PEWCT1014</a>	\$1,395.72	\$1,339.89	\$1,284.06	\$1,228.23	21
				50	10			<a href="#">PEWCT1015</a>	\$1,395.72	\$1,339.89	\$1,284.06	\$1,228.23	22
WR-75	10 - 15	0.1	1.05:1	50	10	Square Cover	EAR99	<a href="#">PEWCT1019</a>	\$1,481.31	\$1,422.06	\$1,362.81	\$1,303.55	23
				20	25			<a href="#">PEWCT1016</a>	\$1,481.31	\$1,422.06	\$1,362.81	\$1,303.55	24
				30	25			<a href="#">PEWCT1017</a>	\$1,404.68	\$1,348.49	\$1,292.31	\$1,236.12	25
				40	15			<a href="#">PEWCT1018</a>	\$1,404.68	\$1,348.49	\$1,292.31	\$1,236.12	26
WR-90	8.2 - 12.4	0.1	1.05:1	20	20	Square Cover UG-39/U	EAR99	<a href="#">PEWCT1020</a>	\$1,372.58	\$1,317.68	\$1,262.77	\$1,207.87	27
				20	25	CPR-90G	EAR99	<a href="#">PEWCT1024</a>	\$1,441.28	\$1,383.63	\$1,325.98	\$1,268.33	28
				30	20	Square Cover UG-39/U	EAR99	<a href="#">PEWCT1021</a>	\$1,372.58	\$1,317.68	\$1,262.77	\$1,207.87	29
				30	20	CPR-90G	EAR99	<a href="#">PEWCT1025</a>	\$1,441.28	\$1,383.63	\$1,325.98	\$1,268.33	30
				40	10	Square Cover UG-39/U	EAR99	<a href="#">PEWCT1022</a>	\$1,372.58	\$1,317.68	\$1,262.77	\$1,207.87	31
				40	10	CPR-90G	EAR99	<a href="#">PEWCT1026</a>	\$1,441.28	\$1,383.63	\$1,325.98	\$1,268.33	32
				50	10	Square Cover UG-39/U	EAR99	<a href="#">PEWCT1023</a>	\$1,393.13	\$1,337.40	\$1,281.68	\$1,225.95	33
				50	10	CPR-90G	EAR99	<a href="#">PEWCT1027</a>	\$1,441.28	\$1,383.63	\$1,325.98	\$1,268.33	34
WR-112	7.05 - 10	0.1	1.05:1	20	45	Square Cover UG-51/U	EAR99	<a href="#">PEWCT1028</a>	\$1,530.89	\$1,469.65	\$1,408.42	\$1,347.18	35
				20	25	CPR-112G	EAR99	<a href="#">PEWCT1032</a>	\$1,548.06	\$1,486.14	\$1,424.22	\$1,362.29	36
				30	25	Square Cover UG-51/U	EAR99	<a href="#">PEWCT1029</a>	\$1,616.39	\$1,551.73	\$1,487.08	\$1,422.42	37
				30	25	CPR-112G	EAR99	<a href="#">PEWCT1033</a>	\$1,548.06	\$1,486.14	\$1,424.22	\$1,362.29	38
				40	20	Square Cover UG-51/U	EAR99	<a href="#">PEWCT1030</a>	\$1,532.76	\$1,471.45	\$1,410.14	\$1,348.83	39
				40	20	CPR-112G	EAR99	<a href="#">PEWCT1034</a>	\$1,548.06	\$1,486.14	\$1,424.22	\$1,362.29	40
				50	10	Square Cover UG-51/U	EAR99	<a href="#">PEWCT1031</a>	\$1,532.76	\$1,471.45	\$1,410.14	\$1,348.83	41
				50	10	CPR-112G	EAR99	<a href="#">PEWCT1035</a>	\$1,548.06	\$1,486.14	\$1,424.22	\$1,362.29	42
WR-137	5.85 - 8.2	0.1	1.05:1	20	25	Round Cover UG-344/U	EAR99	<a href="#">PEWCT1036</a>	\$1,579.42	\$1,516.24	\$1,453.07	\$1,389.89	43
				20	20	CPR-137G	EAR99	<a href="#">PEWCT1040</a>	\$1,541.34	\$1,479.69	\$1,418.03	\$1,356.38	44
				30	20	Round Cover UG-344/U	EAR99	<a href="#">PEWCT1037</a>	\$1,579.42	\$1,516.24	\$1,453.07	\$1,389.89	45
				30	20	CPR-137G	EAR99	<a href="#">PEWCT1041</a>	\$1,541.34	\$1,479.69	\$1,418.03	\$1,356.38	46
				40	20	Round Cover UG-344/U	EAR99	<a href="#">PEWCT1038</a>	\$1,579.42	\$1,516.24	\$1,453.07	\$1,389.89	47
				40	20	CPR-137G	EAR99	<a href="#">PEWCT1042</a>	\$1,541.34	\$1,479.69	\$1,418.03	\$1,356.38	48
				50	10	Round Cover UG-344/U	EAR99	<a href="#">PEWCT1039</a>	\$1,579.42	\$1,516.24	\$1,453.07	\$1,389.89	49
				50	10	CPR-137G	EAR99	<a href="#">PEWCT1043</a>	\$1,541.34	\$1,479.69	\$1,418.03	\$1,356.38	50

### Crossguide\* with Termination and WG to Coax Adapter



WG Type	RF Freq. (GHz.)	IL (dB)	Max VSWR	Coupling (dB)	Directivity (dB)	Flange Type	ECCN	Model No	1	2-4	5-9	10+	ROW
WR-34	22 - 33	0.1	1.05:1	20	20	Square Cover UG-1530/U	EAR99	<a href="#">PEWCT1044</a>	\$2,312.87	\$2,220.36	\$2,127.84	\$2,035.33	51
				30	20			<a href="#">PEWCT1045</a>	\$2,347.49	\$2,253.59	\$2,159.69	\$2,065.79	52
				40	25			<a href="#">PEWCT1046</a>	\$2,312.87	\$2,220.36	\$2,127.84	\$2,035.33	53
				50	10			<a href="#">PEWCT1047</a>	\$2,312.87	\$2,220.36	\$2,127.84	\$2,035.33	54
WR-42	18 - 26.5	0.1	1.05:1	20	30	Square Cover UG-595/U	EAR99	<a href="#">PEWCT1048</a>	\$2,092.03	\$2,008.35	\$1,924.67	\$1,840.99	55
				30	20			<a href="#">PEWCT1049</a>	\$2,123.36	\$2,038.43	\$1,953.49	\$1,868.56	56
				40	20			<a href="#">PEWCT1050</a>	\$2,092.03	\$2,008.35	\$1,924.67	\$1,840.99	57
				50	10		EAR99	<a href="#">PEWCT1051</a>	\$2,092.03	\$2,008.35	\$1,924.67	\$1,840.99	58

\*These WG crossguide couplers are available as assemblies with termination and/or with WG to Coax Adapters, see WG Coupler Assemblies or visit our website

## Crossguide\* with Termination and WG to Coax Adapter



See Our Website For Current Pricing & Real-Time Stock Availability!

WG Type	RF Freq. (GHz.)	IL (dB)	Max VSWR	Coupling (dB)	Directivity (dB)	Flange Type	ECCN	Model No	1	2-4	5-9	10+	ROW
WR-51	15 - 22	0.1	1.05:1	20	20	Square Cover	EAR99	<a href="#">PEWCT1052</a>	\$2,473.42	\$2,374.48	\$2,275.55	\$2,176.61	59
				30	30		EAR99	<a href="#">PEWCT1053</a>	\$2,473.42	\$2,374.48	\$2,275.55	\$2,176.61	60
				40	30		EAR99	<a href="#">PEWCT1054</a>	\$2,473.42	\$2,374.48	\$2,275.55	\$2,176.61	61
				50	10		EAR99	<a href="#">PEWCT1055</a>	\$2,473.42	\$2,374.48	\$2,275.55	\$2,176.61	62
WR-62	12.4 - 18	0.1	1.05:1	20	20	Square Cover UG-419/U	EAR99	<a href="#">PEWCT1056</a>	\$1,956.59	\$1,878.33	\$1,800.06	\$1,721.80	63
				30	10		EAR99	<a href="#">PEWCT1057</a>	\$2,114.21	\$2,029.64	\$1,945.07	\$1,860.50	64
				40	30		EAR99	<a href="#">PEWCT1058</a>	\$1,927.73	\$1,850.62	\$1,773.51	\$1,696.40	65
				50	10		EAR99	<a href="#">PEWCT1059</a>	\$1,956.59	\$1,878.33	\$1,800.06	\$1,721.80	66
WR-75	10 - 15	0.1	1.05:1	40	15	Square Cover	EAR99	<a href="#">PEWCT1066</a>	\$2,189.68	\$2,102.09	\$2,014.51	\$1,926.92	67
				50	10		EAR99	<a href="#">PEWCT1063</a>	\$2,091.37	\$2,007.72	\$1,924.06	\$1,840.41	68
				50	10		EAR99	<a href="#">PEWCT1067</a>	\$2,026.43	\$1,945.37	\$1,864.32	\$1,783.26	69
				20	25		EAR99	<a href="#">PEWCT1060</a>	\$1,944.28	\$1,866.51	\$1,788.74	\$1,710.97	70
				20	25		EAR99	<a href="#">PEWCT1064</a>	\$2,026.43	\$1,945.37	\$1,864.32	\$1,783.26	71
				30	25		EAR99	<a href="#">PEWCT1061</a>	\$2,050.35	\$1,968.34	\$1,886.32	\$1,804.31	72
				30	25		EAR99	<a href="#">PEWCT1065</a>	\$1,996.54	\$1,916.68	\$1,836.82	\$1,756.96	73
				40	15		EAR99	<a href="#">PEWCT1062</a>	\$2,132.37	\$2,047.08	\$1,961.78	\$1,876.49	74
WR-90	8.2 - 12.4	0.1	1.05:1	20	20	Square Cover UG-39/U	EAR99	<a href="#">PEWCT1068</a>	\$2,035.70	\$1,954.27	\$1,872.84	\$1,791.42	75
				20	25	CPR-90G	EAR99	<a href="#">PEWCT1072</a>	\$2,000.27	\$1,920.26	\$1,840.25	\$1,760.24	76
				20	20	Square Cover UG-39/U	EAR99	<a href="#">PEWCT1076</a>	\$2,162.18	\$2,075.69	\$1,989.21	\$1,902.72	77
				20	25	CPR-90G	EAR99	<a href="#">PEWCT1080</a>	\$2,071.91	\$1,989.03	\$1,906.16	\$1,823.28	78
				30	20	Square Cover UG-39/U	EAR99	<a href="#">PEWCT1069</a>	\$2,035.70	\$1,954.27	\$1,872.84	\$1,791.42	79
				30	20	CPR-90G	EAR99	<a href="#">PEWCT1073</a>	\$2,000.27	\$1,920.26	\$1,840.25	\$1,760.24	80
				30	20	Square Cover UG-39/U	EAR99	<a href="#">PEWCT1077</a>	\$1,971.47	\$1,892.61	\$1,813.75	\$1,734.89	81
				30	20	CPR-90G	EAR99	<a href="#">PEWCT1081</a>	\$2,041.34	\$1,959.69	\$1,878.03	\$1,796.38	82
				40	10	Square Cover UG-39/U	EAR99	<a href="#">PEWCT1070</a>	\$1,930.39	\$1,853.17	\$1,775.96	\$1,698.74	83
				40	10	CPR-90G	EAR99	<a href="#">PEWCT1074</a>	\$2,000.27	\$1,920.26	\$1,840.25	\$1,760.24	84
				40	10	Square Cover UG-39/U	EAR99	<a href="#">PEWCT1078</a>	\$2,079.02	\$1,995.86	\$1,912.70	\$1,829.54	85
				40	10	CPR-90G	EAR99	<a href="#">PEWCT1082</a>	\$2,041.34	\$1,959.69	\$1,878.03	\$1,796.38	86
				50	10	Square Cover UG-39/U	EAR99	<a href="#">PEWCT1071</a>	\$1,930.39	\$1,853.17	\$1,775.96	\$1,698.74	87
				50	10	CPR-90G	EAR99	<a href="#">PEWCT1075</a>	\$2,000.27	\$1,920.26	\$1,840.25	\$1,760.24	88
				50	10	Square Cover UG-39/U	EAR99	<a href="#">PEWCT1079</a>	\$2,079.02	\$1,995.86	\$1,912.70	\$1,829.54	89
				50	10	CPR-90G	EAR99	<a href="#">PEWCT1083</a>	\$2,041.34	\$1,959.69	\$1,878.03	\$1,796.38	90
WR-112	7.05 - 10	0.1	1.05:1	20	45	Square Cover UG-51/U	EAR99	<a href="#">PEWCT1084</a>	\$2,240.71	\$2,151.08	\$2,061.45	\$1,971.82	91
				20	25	CPR-112G	EAR99	<a href="#">PEWCT1088</a>	\$2,142.16	\$2,056.47	\$1,970.79	\$1,885.10	92
				20	45	Square Cover UG-51/U	EAR99	<a href="#">PEWCT1092</a>	\$2,139.73	\$2,054.14	\$1,968.55	\$1,882.96	93
				20	25	CPR-112G	EAR99	<a href="#">PEWCT1096</a>	\$2,157.11	\$2,070.83	\$1,984.54	\$1,898.26	94
				30	25	Square Cover UG-51/U	EAR99	<a href="#">PEWCT1085</a>	\$2,124.79	\$2,039.80	\$1,954.81	\$1,869.82	95
				30	25	CPR-112G	EAR99	<a href="#">PEWCT1089</a>	\$2,142.16	\$2,056.47	\$1,970.79	\$1,885.10	96
				30	25	Square Cover UG-51/U	EAR99	<a href="#">PEWCT1093</a>	\$2,139.73	\$2,054.14	\$1,968.55	\$1,882.96	97
				30	25	CPR-112G	EAR99	<a href="#">PEWCT1097</a>	\$2,157.11	\$2,070.83	\$1,984.54	\$1,898.26	98
				40	20	Square Cover UG-51/U	EAR99	<a href="#">PEWCT1086</a>	\$2,124.79	\$2,039.80	\$1,954.81	\$1,869.82	99
				40	20	CPR-112G	EAR99	<a href="#">PEWCT1090</a>	\$2,142.16	\$2,056.47	\$1,970.79	\$1,885.10	1
				40	20	Square Cover UG-51/U	EAR99	<a href="#">PEWCT1094</a>	\$2,139.73	\$2,054.14	\$1,968.55	\$1,882.96	2
				40	20	CPR-112G	EAR99	<a href="#">PEWCT1098</a>	\$2,157.11	\$2,070.83	\$1,984.54	\$1,898.26	3
				50	10	Square Cover UG-51/U	EAR99	<a href="#">PEWCT1087</a>	\$2,124.79	\$2,039.80	\$1,954.81	\$1,869.82	4
				50	10	CPR-112G	EAR99	<a href="#">PEWCT1091</a>	\$2,142.16	\$2,056.47	\$1,970.79	\$1,885.10	5
				50	10	Square Cover UG-51/U	EAR99	<a href="#">PEWCT1095</a>	\$2,139.73	\$2,054.14	\$1,968.55	\$1,882.96	6
				50	10	CPR-112G	EAR99	<a href="#">PEWCT1099</a>	\$2,365.79	\$2,271.16	\$2,176.53	\$2,081.90	7
WR-137	5.85 - 8.2	0.1	1.05:1	20	25	Round Cover UG-344/U	EAR99	<a href="#">PEWCT1100</a>	\$2,196.03	\$2,108.19	\$2,020.35	\$1,932.51	8
				20	20	CPR-137G	EAR99	<a href="#">PEWCT1104</a>	\$2,157.09	\$2,070.81	\$1,984.52	\$1,898.24	9
				20	25	Round Cover UG-344/U	EAR99	<a href="#">PEWCT1108</a>	\$2,199.78	\$2,111.79	\$2,023.80	\$1,935.81	10

\*These WG crossguide couplers are available as assemblies with termination and/or with WG to Coax Adapters, see WG Coupler Assemblies or visit our website

## Crossguide\* with Termination and WG to Coax Adapter



WG Type	RF Freq. (GHz.)	IL (dB)	Max VSWR	Coupling (dB)	Directivity (dB)	Flange Type	ECCN	Model No	1	2-4	5-9	10+	R O W
WR-137	5.85 - 8.2	0.1	1.05:1	20	20	CPR-137G	EAR99	<a href="#">PEWCT1112</a>	\$2,193.19	\$2,105.46	\$2,017.73	\$1,930.01	11
				30	20	Round Cover UG-344/U	EAR99	<a href="#">PEWCT1101</a>	\$2,196.03	\$2,108.19	\$2,020.35	\$1,932.51	12
				30	20	CPR-137G	EAR99	<a href="#">PEWCT1105</a>	\$2,189.38	\$2,101.80	\$2,014.23	\$1,926.65	13
				30	20	Round Cover UG-344/U	EAR99	<a href="#">PEWCT1109</a>	\$2,199.78	\$2,111.79	\$2,023.80	\$1,935.81	14
				30	20	CPR-137G	EAR99	<a href="#">PEWCT1113</a>	\$2,160.84	\$2,074.41	\$1,987.97	\$1,901.54	15
				40	20	Round Cover UG-344/U	EAR99	<a href="#">PEWCT1102</a>	\$2,196.03	\$2,108.19	\$2,020.35	\$1,932.51	16
				40	20	CPR-137G	EAR99	<a href="#">PEWCT1106</a>	\$2,157.09	\$2,070.81	\$1,984.52	\$1,898.24	17
				40	20	Round Cover UG-344/U	EAR99	<a href="#">PEWCT1110</a>	\$2,319.79	\$2,227.00	\$2,134.21	\$2,041.42	18
				40	20	CPR-137G	EAR99	<a href="#">PEWCT1114</a>	\$2,369.89	\$2,275.09	\$2,180.30	\$2,085.50	19
				50	10	Round Cover UG-344/U	EAR99	<a href="#">PEWCT1103</a>	\$2,196.03	\$2,108.19	\$2,020.35	\$1,932.51	20
				50	10	CPR-137G	EAR99	<a href="#">PEWCT1107</a>	\$2,189.38	\$2,101.80	\$2,014.23	\$1,926.65	21
				50	10	Round Cover UG-344/U	EAR99	<a href="#">PEWCT1111</a>	\$2,199.78	\$2,111.79	\$2,023.80	\$1,935.81	22
50	10	CPR-137G	EAR99	<a href="#">PEWCT1115</a>	\$2,160.84	\$2,074.41	\$1,987.97	\$1,901.54	23				

## WAVEGUIDE COUPLER ASSEMBLIES

WG Crossguide Coupler	WG Crossguide Coupler with Termination	WG Crossguide Coupler with Termination & Coax Adapter SMA/ Type N	Conn. Type	WG Crossguide Coupler	WG Crossguide Coupler with Termination	WG Crossguide Coupler with Termination & Coax Adapter SMA/ Type N	Conn. Type
<a href="#">PEWCP1035</a>	<a href="#">PEWCT1000</a>	<a href="#">PEWCT1044</a>	2.92mm	<a href="#">PEWCP1061</a>	<a href="#">PEWCT1026</a>	<a href="#">PEWCT1074</a>	SMA
<a href="#">PEWCP1036</a>	<a href="#">PEWCT1001</a>	<a href="#">PEWCT1045</a>	2.92mm			<a href="#">PEWCT1082</a>	N
<a href="#">PEWCP1037</a>	<a href="#">PEWCT1002</a>	<a href="#">PEWCT1046</a>	2.92mm			<a href="#">PEWCT1075</a>	SMA
<a href="#">PEWCP1038</a>	<a href="#">PEWCT1003</a>	<a href="#">PEWCT1047</a>	2.92mm			<a href="#">PEWCT1083</a>	N
<a href="#">PEWCP1039</a>	<a href="#">PEWCT1004</a>	<a href="#">PEWCT1048</a>	SMA			<a href="#">PEWCT1084</a>	SMA
<a href="#">PEWCP1040</a>	<a href="#">PEWCT1005</a>	<a href="#">PEWCT1049</a>	SMA			<a href="#">PEWCT1092</a>	N
<a href="#">PEWCP1041</a>	<a href="#">PEWCT1006</a>	<a href="#">PEWCT1050</a>	SMA			<a href="#">PEWCT1085</a>	SMA
<a href="#">PEWCP1042</a>	<a href="#">PEWCT1007</a>	<a href="#">PEWCT1051</a>	SMA			<a href="#">PEWCT1093</a>	N
<a href="#">PEWCP1043</a>	<a href="#">PEWCT1008</a>	<a href="#">PEWCT1052</a>	SMA			<a href="#">PEWCT1086</a>	SMA
<a href="#">PEWCP1044</a>	<a href="#">PEWCT1009</a>	<a href="#">PEWCT1053</a>	SMA			<a href="#">PEWCT1094</a>	N
<a href="#">PEWCP1045</a>	<a href="#">PEWCT1010</a>	<a href="#">PEWCT1054</a>	SMA			<a href="#">PEWCT1087</a>	SMA
<a href="#">PEWCP1046</a>	<a href="#">PEWCT1011</a>	<a href="#">PEWCT1055</a>	SMA			<a href="#">PEWCT1095</a>	N
<a href="#">PEWCP1047</a>	<a href="#">PEWCT1012</a>	<a href="#">PEWCT1056</a>	SMA	<a href="#">PEWCT1088</a>	SMA		
<a href="#">PEWCP1048</a>	<a href="#">PEWCT1013</a>	<a href="#">PEWCT1057</a>	SMA	<a href="#">PEWCT1096</a>	N		
<a href="#">PEWCP1049</a>	<a href="#">PEWCT1014</a>	<a href="#">PEWCT1058</a>	SMA	<a href="#">PEWCT1089</a>	SMA		
<a href="#">PEWCP1050</a>	<a href="#">PEWCT1015</a>	<a href="#">PEWCT1059</a>	SMA	<a href="#">PEWCT1097</a>	N		
<a href="#">PEWCP1051</a>	<a href="#">PEWCT1016</a>	<a href="#">PEWCT1060</a>	SMA	<a href="#">PEWCT1090</a>	SMA		
		<a href="#">PEWCT1064</a>	N	<a href="#">PEWCT1098</a>	N		
<a href="#">PEWCP1052</a>	<a href="#">PEWCT1017</a>	<a href="#">PEWCT1061</a>	SMA	<a href="#">PEWCT1091</a>	SMA		
		<a href="#">PEWCT1065</a>	N	<a href="#">PEWCT1099</a>	N		
<a href="#">PEWCP1053</a>	<a href="#">PEWCT1018</a>	<a href="#">PEWCT1062</a>	SMA	<a href="#">PEWCT1100</a>	SMA		
		<a href="#">PEWCT1066</a>	N	<a href="#">PEWCT1108</a>	N		
<a href="#">PEWCP1054</a>	<a href="#">PEWCT1019</a>	<a href="#">PEWCT1063</a>	SMA	<a href="#">PEWCT1101</a>	SMA		
		<a href="#">PEWCT1067</a>	N	<a href="#">PEWCT1109</a>	N		
<a href="#">PEWCP1055</a>	<a href="#">PEWCT1020</a>	<a href="#">PEWCT1068</a>	SMA	<a href="#">PEWCT1102</a>	SMA		
		<a href="#">PEWCT1076</a>	N	<a href="#">PEWCT1110</a>	N		
<a href="#">PEWCP1056</a>	<a href="#">PEWCT1021</a>	<a href="#">PEWCT1069</a>	SMA	<a href="#">PEWCT1103</a>	SMA		
		<a href="#">PEWCT1077</a>	N	<a href="#">PEWCT1111</a>	N		
<a href="#">PEWCP1057</a>	<a href="#">PEWCT1022</a>	<a href="#">PEWCT1070</a>	SMA	<a href="#">PEWCT1104</a>	SMA		
		<a href="#">PEWCT1078</a>	N	<a href="#">PEWCT1112</a>	N		
<a href="#">PEWCP1058</a>	<a href="#">PEWCT1023</a>	<a href="#">PEWCT1071</a>	SMA	<a href="#">PEWCT1105</a>	SMA		
		<a href="#">PEWCT1079</a>	N	<a href="#">PEWCT1113</a>	N		
<a href="#">PEWCP1059</a>	<a href="#">PEWCT1024</a>	<a href="#">PEWCT1072</a>	SMA	<a href="#">PEWCT1106</a>	SMA		
		<a href="#">PEWCT1080</a>	N	<a href="#">PEWCT1114</a>	N		
<a href="#">PEWCP1060</a>	<a href="#">PEWCT1025</a>	<a href="#">PEWCT1073</a>	SMA	<a href="#">PEWCT1107</a>	SMA		
		<a href="#">PEWCT1081</a>	N	<a href="#">PEWCT1115</a>	N		
<a href="#">PEWCP1062</a>	<a href="#">PEWCT1027</a>	<a href="#">PEWCT1074</a>	SMA	<a href="#">PEWCP1063</a>	<a href="#">PEWCT1028</a>	<a href="#">PEWCT1084</a>	SMA
		<a href="#">PEWCT1082</a>	N			<a href="#">PEWCT1092</a>	N
		<a href="#">PEWCT1075</a>	SMA			<a href="#">PEWCT1085</a>	SMA
		<a href="#">PEWCT1083</a>	N			<a href="#">PEWCT1093</a>	N
		<a href="#">PEWCT1084</a>	SMA			<a href="#">PEWCT1086</a>	SMA
		<a href="#">PEWCT1085</a>	SMA			<a href="#">PEWCT1094</a>	N
		<a href="#">PEWCT1086</a>	SMA			<a href="#">PEWCT1087</a>	SMA
		<a href="#">PEWCT1087</a>	SMA			<a href="#">PEWCT1095</a>	N
		<a href="#">PEWCT1088</a>	SMA			<a href="#">PEWCT1088</a>	SMA
		<a href="#">PEWCT1089</a>	SMA			<a href="#">PEWCT1096</a>	N
		<a href="#">PEWCT1090</a>	SMA			<a href="#">PEWCT1089</a>	SMA
		<a href="#">PEWCT1091</a>	SMA			<a href="#">PEWCT1097</a>	N
<a href="#">PEWCP1064</a>	<a href="#">PEWCT1029</a>	<a href="#">PEWCT1084</a>	SMA	<a href="#">PEWCP1065</a>	<a href="#">PEWCT1030</a>	<a href="#">PEWCT1094</a>	N
		<a href="#">PEWCT1093</a>	N			<a href="#">PEWCT1094</a>	N
<a href="#">PEWCP1066</a>	<a href="#">PEWCT1031</a>	<a href="#">PEWCT1087</a>	SMA	<a href="#">PEWCP1066</a>	<a href="#">PEWCT1031</a>	<a href="#">PEWCT1087</a>	SMA
		<a href="#">PEWCT1095</a>	N			<a href="#">PEWCT1095</a>	N
<a href="#">PEWCP1067</a>	<a href="#">PEWCT1032</a>	<a href="#">PEWCT1088</a>	SMA	<a href="#">PEWCP1067</a>	<a href="#">PEWCT1032</a>	<a href="#">PEWCT1088</a>	SMA
		<a href="#">PEWCT1096</a>	N			<a href="#">PEWCT1096</a>	N
<a href="#">PEWCP1068</a>	<a href="#">PEWCT1033</a>	<a href="#">PEWCT1089</a>	SMA	<a href="#">PEWCP1068</a>	<a href="#">PEWCT1033</a>	<a href="#">PEWCT1089</a>	SMA
		<a href="#">PEWCT1097</a>	N			<a href="#">PEWCT1097</a>	N
<a href="#">PEWCP1069</a>	<a href="#">PEWCT1034</a>	<a href="#">PEWCT1090</a>	SMA	<a href="#">PEWCP1069</a>	<a href="#">PEWCT1034</a>	<a href="#">PEWCT1090</a>	SMA
		<a href="#">PEWCT1098</a>	N			<a href="#">PEWCT1098</a>	N
<a href="#">PEWCP1070</a>	<a href="#">PEWCT1035</a>	<a href="#">PEWCT1091</a>	SMA	<a href="#">PEWCP1070</a>	<a href="#">PEWCT1035</a>	<a href="#">PEWCT1091</a>	SMA
		<a href="#">PEWCT1099</a>	N			<a href="#">PEWCT1099</a>	N
<a href="#">PEWCP1071</a>	<a href="#">PEWCT1036</a>	<a href="#">PEWCT1100</a>	SMA	<a href="#">PEWCP1071</a>	<a href="#">PEWCT1036</a>	<a href="#">PEWCT1100</a>	SMA
		<a href="#">PEWCT1108</a>	N			<a href="#">PEWCT1108</a>	N
<a href="#">PEWCP1072</a>	<a href="#">PEWCT1037</a>	<a href="#">PEWCT1101</a>	SMA	<a href="#">PEWCP1072</a>	<a href="#">PEWCT1037</a>	<a href="#">PEWCT1101</a>	SMA
		<a href="#">PEWCT1109</a>	N			<a href="#">PEWCT1109</a>	N
<a href="#">PEWCP1073</a>	<a href="#">PEWCT1038</a>	<a href="#">PEWCT1102</a>	SMA	<a href="#">PEWCP1073</a>	<a href="#">PEWCT1038</a>	<a href="#">PEWCT1102</a>	SMA
		<a href="#">PEWCT1110</a>	N			<a href="#">PEWCT1110</a>	N
<a href="#">PEWCP1074</a>	<a href="#">PEWCT1039</a>	<a href="#">PEWCT1103</a>	SMA	<a href="#">PEWCP1074</a>	<a href="#">PEWCT1039</a>	<a href="#">PEWCT1103</a>	SMA
		<a href="#">PEWCT1111</a>	N			<a href="#">PEWCT1111</a>	N
<a href="#">PEWCP1075</a>	<a href="#">PEWCT1040</a>	<a href="#">PEWCT1104</a>	SMA	<a href="#">PEWCP1075</a>	<a href="#">PEWCT1040</a>	<a href="#">PEWCT1104</a>	SMA
		<a href="#">PEWCT1112</a>	N			<a href="#">PEWCT1112</a>	N
<a href="#">PEWCP1076</a>	<a href="#">PEWCT1041</a>	<a href="#">PEWCT1105</a>	SMA	<a href="#">PEWCP1076</a>	<a href="#">PEWCT1041</a>	<a href="#">PEWCT1105</a>	SMA
		<a href="#">PEWCT1113</a>	N			<a href="#">PEWCT1113</a>	N
<a href="#">PEWCP1077</a>	<a href="#">PEWCT1042</a>	<a href="#">PEWCT1106</a>	SMA	<a href="#">PEWCP1077</a>	<a href="#">PEWCT1042</a>	<a href="#">PEWCT1106</a>	SMA
		<a href="#">PEWCT1114</a>	N			<a href="#">PEWCT1114</a>	N
<a href="#">PEWCP1078</a>	<a href="#">PEWCT1043</a>	<a href="#">PEWCT1107</a>	SMA	<a href="#">PEWCP1078</a>	<a href="#">PEWCT1043</a>	<a href="#">PEWCT1107</a>	SMA
		<a href="#">PEWCT1115</a>	N			<a href="#">PEWCT1115</a>	N

\*These WG crossguide couplers are available as assemblies with termination and/or with WG to Coax Adapters, see WG Coupler Assemblies or visit our website

## WAVEGUIDE DETECTORS



Connector 1	RF Frequency (GHz.)	Voltage Sensitivity (V/nW)	Input Power (dBm)	Connector 2	ECCN	Model No	1	2-4	5-9	10+	ROW
WR-28 UG-599/U	26.5 - 40	-1,000	20	SMA Female	EAR99	<a href="#">PE80T3005</a>	\$3,627.84	\$3,482.73	\$3,337.61	\$3,192.50	24
WR-22 UG-383/U	33 - 50	-800		SMA Female	EAR99	<a href="#">PE80T3004</a>	\$4,377.60	\$4,224.38	\$4,071.17	\$3,939.84	25
WR-19 UG-383/U	40 - 60	-800		SMA Female	EAR99	<a href="#">PE80T3003</a>	\$3,865.20	\$3,710.59	\$3,555.98	\$3,401.38	26
WR-15 UG-385/U	50 - 75	-700		SMA Female	EAR99	<a href="#">PE80T3002</a>	\$4,628.16	\$4,443.03	\$4,257.91	\$4,072.78	27
WR-12 UG-387/U	60 - 90	-900		SMA Female	EAR99	<a href="#">PE80T3001</a>	\$4,445.27	\$4,267.46	\$4,089.65	\$3,911.84	28
WR-10 UG-387/U	75 - 100	-900		SMA Female	EAR99	<a href="#">PE80T3000</a>	\$4,288.89	\$4,117.33	\$3,945.78	\$3,774.22	29

## WAVEGUIDE DIRECT READ ATTENUATORS



WG Type	RF Freq. (GHz.)	Max Atten (dB)	IL (dB)	Max VSWR	Input Power (Watts)	Flange Type	ECCN	Model No	1	2-4	5-9	10+	ROW
WR-10	75 - 110	50	1	1.2:1	0.2	Round Cover UG-387/U-Mod	EAR99	<a href="#">PE-W10AT5001</a>	\$5,588.44	\$5,364.90	\$5,141.36	\$4,917.83	30
WR-12	60 - 90		0.9	1.2:1	0.2	Round Cover UG-387/U	EAR99	<a href="#">PE-W12AT5001</a>	\$6,129.03	\$5,914.51	\$5,700.00	\$5,516.13	31
WR-15	50 - 75		0.8	1.2:1	0.3	Round Cover UG-385/U	EAR99	<a href="#">PE-W15AT5001</a>	\$5,893.31	\$5,657.58	\$5,421.85	\$5,186.11	32
WR-19	40 - 60		0.7	1.15:1	0.2	Round Cover UG-383/U-Mod	EAR99	<a href="#">PE-W19AT5001</a>	\$5,588.44	\$5,364.90	\$5,141.36	\$4,917.83	33
WR-22	33 - 50		0.6	1.15:1	0.4	Round Cover UG-383/U	EAR99	<a href="#">PE-W22AT5001</a>	\$5,806.38	\$5,574.12	\$5,341.87	\$5,109.61	34
		60	1.15:1	0.5	EAR99		<a href="#">PE-W22AT5002</a>	\$5,590.00	\$5,366.40	\$5,142.80	\$4,919.20	35	
WR-28	26.5 - 40	50	0.5	1.15:1	0.5	Square Cover UG-599/U	EAR99	<a href="#">PE-W28AT5001</a>	\$5,482.14	\$5,262.85	\$5,043.57	\$4,824.28	36
WR-42	18 - 26.5		0.5	1.15:1	1	Square Cover UG-595/U	EAR99	<a href="#">PE-W42AT5001</a>	\$6,129.03	\$5,883.87	\$5,638.71	\$5,393.55	37

## WAVEGUIDE ELECTROMECHANICAL RELAY SWITCHES



**Features:**  
 A: Absorptive  
 AR: Auto Reset  
 F: Failsafe  
 D: Diode  
 GR: Global Reset  
 H: Hot Switches  
 I: Indicators  
 L: Latching  
 M: Manual Override  
 N: Normally Open  
 NT: Non-Terminated  
 P: Pulse  
 Latching  
 R: Reflective  
 RS: Reset  
 S: Self Cut Off  
 SI: Set Indicator  
 T: Terminated  
 TTL: TTL Logic  
 V: Viewing Window

WG Type	Switch Type	RF Freq. (GHz.)	Actuator / Features	IL (dB)	Iso (dB)	DC Power (V)	ECCN	Model No	1	2-4	5-9	10+	ROW
WR-28	SPDT/DPDT	26.5 - 40	F, I	0.15	55	12	EAR99	<a href="#">PEWGS6056</a>	Call	Call	Call	Call	38
				0.15	55	28	EAR99	<a href="#">PEWGS6057</a>	Call	Call	Call	Call	39
			F, TTL, I	0.15	55	12	EAR99	<a href="#">PEWGS6058</a>	Call	Call	Call	Call	40
	0.15			55	28	EAR99	<a href="#">PEWGS6059</a>	Call	Call	Call	Call	41	
	B, L, S, I, M			0.15	55	12	EAR99	<a href="#">PEWGS6002</a>	\$3,714.09	\$3,565.53	\$3,416.96	\$3,268.40	42
			0.15	55	28	EAR99	<a href="#">PEWGS6000</a>	\$3,684.68	\$3,537.29	\$3,389.91	\$3,242.52	43	
B, L, TTL, S, I, M		0.15	55	12	EAR99	<a href="#">PEWGS6003</a>	\$4,204.68	\$4,036.49	\$3,868.31	\$3,700.12	44		
	0.15	55	28	EAR99	<a href="#">PEWGS6001</a>	\$3,828.39	\$3,675.25	\$3,522.12	\$3,368.98	45			
	L, S, SI, M, V	0.15	60	12	EAR99	<a href="#">PEWGS6042</a>	\$4,489.34	\$4,309.77	\$4,130.19	\$3,950.62	46		
0.15		60	28	EAR99	<a href="#">PEWGS6040</a>	\$4,556.55	\$4,374.29	\$4,192.03	\$4,009.76	47			
L, TTL, S, SI, M, V		0.15	60	12	EAR99	<a href="#">PEWGS6043</a>	\$4,662.67	\$4,476.16	\$4,289.66	\$4,103.15	48		
	0.15	60	28	EAR99	<a href="#">PEWGS6041</a>	\$4,662.67	\$4,476.16	\$4,289.66	\$4,103.15	49			
	B, L, S, I, M	0.15	60	12	EAR99	<a href="#">PEWGS6006</a>	\$3,714.09	\$3,565.53	\$3,416.96	\$3,268.40	50		
0.15		60	28	EAR99	<a href="#">PEWGS6004</a>	\$3,630.33	\$3,485.12	\$3,339.90	\$3,194.69	51			
B, L, TTL, S, I, M		0.15	60	12	EAR99	<a href="#">PEWGS6007</a>	\$3,714.09	\$3,565.53	\$3,416.96	\$3,268.40	52		
	0.15	60	28	EAR99	<a href="#">PEWGS6005</a>	\$3,828.39	\$3,675.25	\$3,522.12	\$3,368.98	53			
	B, L, S, I, M	0.1	60	12	EAR99	<a href="#">PEWGS6010</a>	\$3,521.96	\$3,381.08	\$3,240.20	\$3,099.32	54		
0.1		60	28	EAR99	<a href="#">PEWGS6008</a>	\$3,630.33	\$3,485.12	\$3,339.90	\$3,194.69	55			
B, L, TTL, S, I, M		0.1	60	12	EAR99	<a href="#">PEWGS6011</a>	\$3,957.14	\$3,798.85	\$3,640.57	\$3,482.28	56		
	0.1	60	28	EAR99	<a href="#">PEWGS6009</a>	\$4,296.02	\$4,124.18	\$3,952.34	\$3,780.50	57			
	B, L, S, I, M	0.05	75	12	EAR99	<a href="#">PEWGS6014</a>	\$3,521.96	\$3,381.08	\$3,240.20	\$3,099.32	58		
0.05		75	28	EAR99	<a href="#">PEWGS6012</a>	\$3,828.39	\$3,675.25	\$3,522.12	\$3,368.98	59			
B, L, TTL, S, I, M		0.05	75	12	EAR99	<a href="#">PEWGS6015</a>	\$3,521.96	\$3,381.08	\$3,240.20	\$3,099.32	60		
	0.05	75	28	EAR99	<a href="#">PEWGS6013</a>	\$4,109.70	\$3,945.31	\$3,780.92	\$3,616.54	61			
	F, I	0.07	80	12	EAR99	<a href="#">PEWGS6060</a>	Call	Call	Call	Call	62		
0.07		80	EAR99		<a href="#">PEWGS6064</a>	Call	Call	Call	Call	63			
0.07		80	EAR99		<a href="#">PEWGS6061</a>	Call	Call	Call	Call	64			
0.07		80	EAR99		<a href="#">PEWGS6065</a>	Call	Call	Call	Call	65			



Technical Support  
 +1 (949) 261-1920



Same-Day Shipping,  
 Even Custom Cable Assemblies



## WAVEGUIDE ELECTROMECHANICAL RELAY SWITCHES



**Features:**

A: Absorptive  
AR: Auto Reset  
F: Failsafe  
D: Diode  
GR: Global Reset

H: Hot Switches  
I: Indicators  
L: Latching  
M: Manual Override  
N: Normally Open  
NT: Non-Terminated

P: Pulse Latching  
R: Reflective  
RS: Reset  
S: Self Cut Off  
SI: Set Indicator

T: Terminated  
TTL: TTL Logic  
V: Viewing Window

WG Type	Switch Type	RF Freq. (GHz.)	Actuator / Features	IL (dB)	Iso (dB)	DC Power (V)	ECCN	Model No	1	2-4	5-9	10+	ROW			
WR-90	SPDT/DPDT	8.2 - 12.4	F, TTL, I	0.07	80	12	EAR99	<a href="#">PEWGS6062</a>	Call	Call	Call	Call	66			
				0.07	80		EAR99	<a href="#">PEWGS6066</a>	Call	Call	Call	Call	67			
				0.07	80	28	EAR99	<a href="#">PEWGS6063</a>	Call	Call	Call	Call	68			
				0.07	80		EAR99	<a href="#">PEWGS6067</a>	Call	Call	Call	Call	69			
	SPDT		B, L, S, I, M	0.07	80	12	EAR99	<a href="#">PEWGS6018</a>	\$4,438.58	\$4,261.04	\$4,083.49	\$3,905.95	70			
				0.07	80	28	EAR99	<a href="#">PEWGS6016</a>	\$4,142.67	\$3,976.96	\$3,811.26	\$3,645.55	71			
				0.07	80	12	EAR99	<a href="#">PEWGS6019</a>	\$4,390.32	\$4,214.71	\$4,039.09	\$3,863.48	72			
WR-102	SPDT/DPDT	7 - 11	L, S, SI, M, V	0.06	80	12	EAR99	<a href="#">PEWGS6038</a>	\$4,489.34	\$4,309.77	\$4,130.19	\$3,950.62	74			
				0.06	80	28	EAR99	<a href="#">PEWGS6036</a>	\$4,489.34	\$4,309.77	\$4,130.19	\$3,950.62	75			
			L, TTL, S, SI, M, V	0.06	80	12	EAR99	<a href="#">PEWGS6039</a>	\$4,662.67	\$4,476.16	\$4,289.66	\$4,103.15	76			
				0.06	80	28	EAR99	<a href="#">PEWGS6037</a>	\$4,662.67	\$4,476.16	\$4,289.66	\$4,103.15	77			
			WR-112	SPDT	7.05 - 10	F, I	0.05	80	12	EAR99	<a href="#">PEWGS6068</a>	Call	Call	Call	Call	78
							0.05	80	28	EAR99	<a href="#">PEWGS6069</a>	Call	Call	Call	Call	79
F, TTL, I	0.05	80				12	EAR99	<a href="#">PEWGS6070</a>	Call	Call	Call	Call	80			
	0.05	80					EAR99	<a href="#">PEWGS6071</a>	Call	Call	Call	Call	81			
WR-137	SPDT	5.85 - 8.2	B, L, S, I, M	0.05	80	28	EAR99	<a href="#">PEWGS6022</a>	\$3,521.96	\$3,381.08	\$3,240.20	\$3,099.32	82			
				0.05	80	28	EAR99	<a href="#">PEWGS6020</a>	\$3,630.33	\$3,485.12	\$3,339.90	\$3,194.69	83			
			B, L, TTL, S, I, M	0.05	80	12	EAR99	<a href="#">PEWGS6023</a>	\$3,714.09	\$3,565.53	\$3,416.96	\$3,268.40	84			
				0.05	80	28	EAR99	<a href="#">PEWGS6021</a>	\$3,630.33	\$3,485.12	\$3,339.90	\$3,194.69	85			
			B, L, S, I, M	0.02	70	12	EAR99	<a href="#">PEWGS6026</a>	\$3,521.96	\$3,381.08	\$3,240.20	\$3,099.32	86			
				0.02	70	28	EAR99	<a href="#">PEWGS6024</a>	\$3,828.39	\$3,675.25	\$3,522.12	\$3,368.98	87			
WR-159	SPDT/DPDT	4.9 - 7.05	B, L, S, I, M	0.02	70	12	EAR99	<a href="#">PEWGS6027</a>	\$3,521.96	\$3,381.08	\$3,240.20	\$3,099.32	88			
				0.02	70	28	EAR99	<a href="#">PEWGS6025</a>	\$3,630.33	\$3,485.12	\$3,339.90	\$3,194.69	89			
			L, S, SI, M, V	0.06	70	12	EAR99	<a href="#">PEWGS6034</a>	\$4,489.34	\$4,309.77	\$4,130.19	\$3,950.62	90			
				0.06	70	28	EAR99	<a href="#">PEWGS6032</a>	\$4,489.34	\$4,309.77	\$4,130.19	\$3,950.62	91			
			L, TTL, S, SI, M, V	0.06	70	12	EAR99	<a href="#">PEWGS6033</a>	\$4,662.67	\$4,476.16	\$4,289.66	\$4,103.15	92			
				0.06	70		EAR99	<a href="#">PEWGS6035</a>	\$4,662.67	\$4,476.16	\$4,289.66	\$4,103.15	93			
WR-187	SPDT/DPDT	3.95 - 5.85	L, S, SI, M, V	0.02	80	28	EAR99	<a href="#">PEWGS6030</a>	\$4,489.34	\$4,309.77	\$4,130.19	\$3,950.62	94			
				0.02	80		EAR99	<a href="#">PEWGS6028</a>	\$4,489.03	\$4,309.47	\$4,129.91	\$3,950.35	95			
			L, TTL, S, SI, M, V	0.002	80	12	EAR99	<a href="#">PEWGS6031</a>	\$4,662.67	\$4,476.16	\$4,289.66	\$4,103.15	96			
				0.02	80	28	EAR99	<a href="#">PEWGS6029</a>	\$4,662.67	\$4,476.16	\$4,289.66	\$4,103.15	97			

## DOUBLE RIDGE WAVEGUIDE ELECTROMECHANICAL RELAY SWITCHES



**Features:**

A: Absorptive  
AR: Auto Reset  
F: Failsafe  
D: Diode  
GR: Global Reset

H: Hot Switches  
I: Indicators  
L: Latching  
M: Manual Override  
N: Normally Open  
NT: Non-Terminated

P: Pulse Latching  
R: Reflective  
RS: Reset  
S: Self Cut Off  
SI: Set Indicator

T: Terminated  
TTL: TTL Logic  
V: Viewing Window

WG Type	Switch Type	RF Freq. (GHz.)	Actuator / Features	IL (dB)	Iso (dB)	DC Power (V)	ECCN	Model No	1	2-4	5-9	10+	ROW	
WRD-180	SPDT/DPDT	18 - 40	L, S, SI, M, V	0.4	50	12	EAR99	<a href="#">PEWGS6054</a>	\$8,822.67	\$8,469.76	\$8,116.86	\$7,763.95	98	
				0.4	50	28	EAR99	<a href="#">PEWGS6052</a>	\$8,822.67	\$8,469.76	\$8,116.86	\$7,763.95	99	
				L, TTL, S, SI, M, V	0.4	50	12	EAR99	<a href="#">PEWGS6056</a>	Call	Call	Call	Call	1
					0.4	50		EAR99	<a href="#">PEWGS6065</a>	Call	Call	Call	Call	2
			0.4		50	EAR99		<a href="#">PEWGS6066</a>	Call	Call	Call	Call	3	
			0.4		50	EAR99		<a href="#">PEWGS6067</a>	Call	Call	Call	Call	4	
			0.4		50	EAR99		<a href="#">PEWGS6068</a>	Call	Call	Call	Call	5	
			0.4		50	EAR99		<a href="#">PEWGS6069</a>	Call	Call	Call	Call	6	
			0.4		50	EAR99		<a href="#">PEWGS6070</a>	Call	Call	Call	Call	7	
			0.4		50	EAR99		<a href="#">PEWGS6071</a>	Call	Call	Call	Call	8	
			0.4		50	EAR99		<a href="#">PEWGS6057</a>	Call	Call	Call	Call	9	
			0.4		50	EAR99		<a href="#">PEWGS6058</a>	Call	Call	Call	Call	10	
			0.4		50	EAR99		<a href="#">PEWGS6059</a>	Call	Call	Call	Call	11	
			0.4		50	EAR99		<a href="#">PEWGS6060</a>	Call	Call	Call	Call	12	
			0.4		50	EAR99		<a href="#">PEWGS6061</a>	Call	Call	Call	Call	13	
			0.4		50	EAR99		<a href="#">PEWGS6062</a>	Call	Call	Call	Call	14	
			0.4		50	EAR99		<a href="#">PEWGS6055</a>	\$8,996.00	\$8,636.16	\$8,276.32	\$7,916.48	15	
			0.4		50	EAR99		<a href="#">PEWGS6063</a>	Call	Call	Call	Call	16	
			0.4	50	EAR99	<a href="#">PEWGS6064</a>	Call	Call	Call	Call	17			
			0.4	50	28	EAR99	<a href="#">PEWGS6053</a>	\$8,996.00	\$8,636.16	\$8,276.32	\$7,916.48	18		

## DOUBLE RIDGE WAVEGUIDE ELECTROMECHANICAL RELAY SWITCHES



**Features:**

A: Absorptive	H: Hot Switches	P: Pulse Latching	T: Terminated
AR: Auto Reset	I: Indicators	R: Reflective	TTL: TTL Logic
F: Failsafe	L: Latching	RS: Reset	V: Viewing Window
D: Diode	M: Manual Override	S: Self Cut Off	
GR: Global Reset	N: Normally Open	SI: Set Indicator	
	NT: Non-Terminated		

WG Type	Switch Type	RF Freq. (GHz.)	Actuator / Features	IL (dB)	Iso (dB)	DC Power (V)	ECCN	Model No	1	2-4	5-9	10+	ROW
WRD-650	SPDT/DPDT	6.5 - 18	L, S, SI, M, V	0.35	60	12	EAR99	<a href="#">PEWGS6046</a>	\$7,956.00	\$7,637.76	\$7,319.52	\$7,001.28	19
				0.35	60	28	EAR99	<a href="#">PEWGS6044</a>	\$8,075.11	\$7,752.11	\$7,429.10	\$7,106.10	20
			L, TTL, S, SI, M, V	0.35	60	12	EAR99	<a href="#">PEWGS6047</a>	\$8,129.34	\$7,804.17	\$7,478.99	\$7,153.82	21
				0.35	60	28	EAR99	<a href="#">PEWGS6045</a>	\$8,129.34	\$7,804.17	\$7,478.99	\$7,153.82	22
WRD-750	SPDT/DPDT	7.5 - 18	L, S, SI, M, V	0.3	60	12	EAR99	<a href="#">PEWGS6050</a>	\$7,956.00	\$7,637.76	\$7,319.52	\$7,001.28	23
				0.3	60	28	EAR99	<a href="#">PEWGS6048</a>	\$7,956.00	\$7,637.76	\$7,319.52	\$7,001.28	24
			L, TTL, S, SI, M, V	0.3	60	12	EAR99	<a href="#">PEWGS6051</a>	\$8,129.34	\$7,804.17	\$7,478.99	\$7,153.82	25
				0.3	60	28	EAR99	<a href="#">PEWGS6049</a>	\$8,129.34	\$7,804.17	\$7,478.99	\$7,153.82	26

## ELECTROMECHANICAL RELAY SWITCHES see page 324

## WAVEGUIDE FIXED ATTENUATORS



Waveguide Type	RF Frequency (GHz.)	Flange Type	Atten. (dB)	VSWR	Max. Power (W)	ECCN	Model No	1-24	25-49	50-99	100+	ROW
WR-10	75 - 110	Round Cover UG-387/U-Mod	3	1.15:1	1	EAR99	<a href="#">PEWAT1012-3</a>	1,270.46	1,181.53	1,092.60	1,016.37	27
			6		1	EAR99	<a href="#">PEWAT1012-6</a>	1,270.46	1,181.53	1,092.60	1,016.37	28
			10		1	EAR99	<a href="#">PEWAT1012-10</a>	1,270.46	1,181.53	1,092.60	1,016.37	29
			20		1	EAR99	<a href="#">PEWAT1012-20</a>	1,270.46	1,181.53	1,092.60	1,016.37	30
			30		1	EAR99	<a href="#">PEWAT1012-30</a>	1,270.46	1,181.53	1,092.60	1,016.37	31
WR-12	60 - 90	Round Cover UG-387/U	3	1	EAR99	<a href="#">PEWAT1011-3</a>	1,270.46	1,181.53	1,092.60	1,016.37	32	
			6	1	EAR99	<a href="#">PEWAT1011-6</a>	1,270.46	1,181.53	1,092.60	1,016.37	33	
			10	1	EAR99	<a href="#">PEWAT1011-10</a>	1,270.46	1,181.53	1,092.60	1,016.37	34	
			20	1	EAR99	<a href="#">PEWAT1011-20</a>	1,270.46	1,181.53	1,092.60	1,016.37	35	
			30	1	EAR99	<a href="#">PEWAT1011-30</a>	1,270.46	1,181.53	1,092.60	1,016.37	36	
WR-15	50 - 75	Round Cover UG-385/U	3	2	EAR99	<a href="#">PEWAT1010-3</a>	1,270.46	1,181.53	1,092.60	1,016.37	37	
			6	2	EAR99	<a href="#">PEWAT1010-6</a>	1,270.46	1,181.53	1,092.60	1,016.37	38	
			10	2	EAR99	<a href="#">PEWAT1010-10</a>	1,270.46	1,181.53	1,092.60	1,016.37	39	
			20	2	EAR99	<a href="#">PEWAT1010-20</a>	1,270.46	1,181.53	1,092.60	1,016.37	40	
			30	2	EAR99	<a href="#">PEWAT1010-30</a>	1,270.46	1,181.53	1,092.60	1,016.37	41	
WR-19	40 - 60	Round Cover UG-383/U-Mod	3	3	EAR99	<a href="#">PEWAT1009-3</a>	1,465.91	1,363.30	1,260.68	1,172.73	42	
			6	3	EAR99	<a href="#">PEWAT1009-6</a>	1,465.91	1,363.30	1,260.68	1,172.73	43	
			10	3	EAR99	<a href="#">PEWAT1009-10</a>	1,465.91	1,363.30	1,260.68	1,172.73	44	
			20	3	EAR99	<a href="#">PEWAT1009-20</a>	1,465.91	1,363.30	1,260.68	1,172.73	45	
			30	3	EAR99	<a href="#">PEWAT1009-30</a>	1,465.91	1,363.30	1,260.68	1,172.73	46	
WR-22	33 - 50	Round Cover UG-383/U	3	4	EAR99	<a href="#">PEWAT1008-3</a>	1,465.91	1,363.30	1,260.68	1,172.73	47	
			6	4	EAR99	<a href="#">PEWAT1008-6</a>	1,465.91	1,363.30	1,260.68	1,172.73	48	
			10	4	EAR99	<a href="#">PEWAT1008-10</a>	1,465.91	1,363.30	1,260.68	1,172.73	49	
			20	4	EAR99	<a href="#">PEWAT1008-20</a>	1,465.91	1,363.30	1,260.68	1,172.73	50	
			30	4	EAR99	<a href="#">PEWAT1008-30</a>	1,465.91	1,363.30	1,260.68	1,172.73	51	
WR-28	26.5 - 40	Square Cover UG-599/U	3	5	EAR99	<a href="#">PEWAT1007-3</a>	1,465.91	1,363.30	1,260.68	1,172.73	52	
			6	5	EAR99	<a href="#">PEWAT1007-6</a>	1,465.91	1,363.30	1,260.68	1,172.73	53	
			10	5	EAR99	<a href="#">PEWAT1007-10</a>	1,465.91	1,363.30	1,260.68	1,172.73	54	
			20	5	EAR99	<a href="#">PEWAT1007-20</a>	1,465.91	1,363.30	1,260.68	1,172.73	55	
			30	5	EAR99	<a href="#">PEWAT1007-30</a>	1,465.91	1,363.30	1,260.68	1,172.73	56	

See Our Website For Current Pricing & Real-Time Stock Availability!

Waveguides



## FLEXIBLE WAVEGUIDES

### Seamless



Waveguide Type	RF Frequency (GHz.)	IL (dB)	Max VSWR	Length (in)	Flange Type	ECCN	Model No	1	2-4	5-9	10+	R O W
WR-22	33 - 50	0.49	1.2:1	6	Round Cover UG-383/U	EAR99	<a href="#">PE-W22SF005-6</a>	\$1,712.81	\$1,644.30	\$1,575.79	\$1,507.27	57
		0.49	1.2:1	12	Round Cover UG-383/U	EAR99	<a href="#">PE-W22SF005-12</a>	\$2,568.67	\$2,465.92	\$2,363.18	\$2,260.43	58
		0.49	1.2:1	24	Round Cover UG-383/U	EAR99	<a href="#">PE-W22SF005-24</a>	\$3,464.07	\$3,325.51	\$3,186.94	\$3,048.38	59
WR-28	26.5 - 40	0.49	1.2:1	12	Square Cover UG-599/U	EAR99	<a href="#">PE-W28SF005-12</a>	\$1,451.75	\$1,393.68	\$1,335.61	\$1,277.54	60
		0.98	1.2:1	24	Square Cover UG-599/U	EAR99	<a href="#">PE-W28SF005-24</a>	\$2,308.90	\$2,216.54	\$2,124.19	\$2,031.83	61
		1.47	1.2:1	36	Square Cover UG-599/U	EAR99	<a href="#">PE-W28SF005-36</a>	\$3,221.91	\$3,093.03	\$2,964.16	\$2,835.28	62
WR-34	22 - 33	0.4	1.15:1	12	Square Cover UG-1530/U	EAR99	<a href="#">PE-W34SF005-12</a>	\$1,395.90	\$1,340.06	\$1,284.23	\$1,228.39	63
		0.8	1.15:1	24	Square Cover UG-1530/U	EAR99	<a href="#">PE-W34SF005-24</a>	\$2,189.46	\$2,101.88	\$2,014.30	\$1,926.72	64
		1.2	1.15:1	36	Square Cover UG-1530/U	EAR99	<a href="#">PE-W34SF005-36</a>	\$3,221.91	\$3,093.03	\$2,964.16	\$2,835.28	65
WR-42	18 - 26.5	0.27	1.15:1	12	Square Cover UG-595/U	EAR99	<a href="#">PE-W42SF005-12</a>	\$1,226.13	\$1,177.08	\$1,128.04	\$1,078.99	66
		0.54	1.15:1	24	Square Cover UG-595/U	EAR99	<a href="#">PE-W42SF005-24</a>	\$1,991.99	\$1,912.31	\$1,832.63	\$1,752.95	67
		0.81	1.15:1	36	Square Cover UG-595/U	EAR99	<a href="#">PE-W42SF005-36</a>	\$2,761.63	\$2,651.16	\$2,540.70	\$2,430.23	68
WR-51	15 - 22	0.18	1.1:1	12	Square Cover	EAR99	<a href="#">PE-W51SF005-12</a>	\$1,173.43	\$1,126.49	\$1,079.56	\$1,032.62	69
		0.36	1.1:1	24	Square Cover	EAR99	<a href="#">PE-W51SF005-24</a>	\$1,896.11	\$1,820.27	\$1,744.42	\$1,668.58	70
		0.54	1.1:1	36	Square Cover	EAR99	<a href="#">PE-W51SF005-36</a>	\$2,665.24	\$2,558.63	\$2,452.02	\$2,345.41	71
WR-62	12.4 - 18	0.14	1.08:1	12	Square Cover UG-419/U	EAR99	<a href="#">PE-W62SF005-12</a>	\$1,177.09	\$1,130.01	\$1,082.92	\$1,036.72	72
		0.28	1.08:1	24	Square Cover UG-419/U	EAR99	<a href="#">PE-W62SF005-24</a>	\$1,699.36	\$1,631.39	\$1,563.41	\$1,495.44	73
		0.42	1.08:1	36	Square Cover UG-419/U	EAR99	<a href="#">PE-W62SF005-36</a>	\$2,418.93	\$2,322.17	\$2,225.42	\$2,128.66	74
WR-75	10 - 15	0.12	1.07:1	12	Square Cover	EAR99	<a href="#">PE-W75SF005-12</a>	\$1,150.70	\$1,104.67	\$1,058.64	\$1,012.62	75
		0.24	1.07:1	24	Square Cover	EAR99	<a href="#">PE-W75SF005-24</a>	\$1,859.80	\$1,785.41	\$1,711.02	\$1,636.62	76
		0.36	1.07:1	36	Square Cover	EAR99	<a href="#">PE-W75SF005-36</a>	\$2,526.83	\$2,425.76	\$2,324.68	\$2,223.61	77
WR-90	8.2 - 12.4	0.09	1.07:1	12	Square Cover UG-39/U	EAR99	<a href="#">PE-W90SF005-12</a>	\$1,224.17	\$1,175.20	\$1,126.24	\$1,077.27	78
		0.18	1.07:1	24	CPR-90G	EAR99	<a href="#">PE-W90SF006-24</a>	\$1,745.85	\$1,676.02	\$1,606.18	\$1,536.35	79
		0.18	1.07:1	24	Square Cover UG-39/U	EAR99	<a href="#">PE-W90SF005-24</a>	\$1,841.11	\$1,767.47	\$1,693.82	\$1,620.18	80
		0.27	1.07:1	36	CPR-90G	EAR99	<a href="#">PE-W90SF006-36</a>	\$2,368.35	\$2,273.62	\$2,178.88	\$2,084.15	81
		0.27	1.07:1	36	Square Cover UG-39/U	EAR99	<a href="#">PE-W90SF005-36</a>	\$2,497.56	\$2,397.66	\$2,297.76	\$2,197.85	82
WR-112	7.05 - 10	0.9	1.07:1	36	CPR-90G	EAR99	<a href="#">PE-W90SF006-12</a>	\$1,116.20	\$1,071.55	\$1,026.90	\$982.26	83
		0.08	1.07:1	12	CPR-112G	EAR99	<a href="#">PE-W112SF006-12</a>	\$1,209.22	\$1,160.85	\$1,112.48	\$1,064.11	84
		0.08	1.07:1	24	Square Cover UG-51/U	EAR99	<a href="#">PE-W112SF005-12</a>	\$1,227.33	\$1,178.24	\$1,129.14	\$1,080.05	85
		0.16	1.07:1	24	CPR-112G	EAR99	<a href="#">PE-W112SF006-24</a>	\$1,903.25	\$1,827.12	\$1,750.99	\$1,674.86	86
		0.16	1.07:1	24	Square Cover UG-51/U	EAR99	<a href="#">PE-W112SF005-24</a>	\$1,931.74	\$1,854.47	\$1,777.20	\$1,699.93	87
		0.24	1.07:1	36	CPR-112G	EAR99	<a href="#">PE-W112SF006-36</a>	\$2,604.46	\$2,500.28	\$2,396.10	\$2,291.92	88
WR-137	5.85 - 8.2	0.24	1.07:1	36	Square Cover UG-51/U	EAR99	<a href="#">PE-W112SF005-36</a>	\$2,604.46	\$2,500.28	\$2,396.10	\$2,291.92	89
		0.06	1.07:1	12	CPR-137G	EAR99	<a href="#">PE-W137SF006-12</a>	\$1,237.83	\$1,188.32	\$1,138.80	\$1,089.29	90
		0.06	1.07:1	24	Round Cover UG-344/U	EAR99	<a href="#">PE-W137SF005-12</a>	\$1,345.15	\$1,291.34	\$1,237.54	\$1,183.73	91
		0.12	1.07:1	24	CPR-137G	EAR99	<a href="#">PE-W137SF006-24</a>	\$2,124.19	\$2,039.22	\$1,954.25	\$1,869.29	92
		0.12	1.07:1	24	Round Cover UG-344/U	EAR99	<a href="#">PE-W137SF005-24</a>	\$2,139.37	\$2,053.80	\$1,968.22	\$1,882.65	93
WR-137	5.85 - 8.2	0.18	1.07:1	36	CPR-137G	EAR99	<a href="#">PE-W137SF006-36</a>	\$2,883.51	\$2,768.17	\$2,652.83	\$2,537.49	94
		0.18	1.07:1	36	Round Cover UG-344/U	EAR99	<a href="#">PE-W137SF005-36</a>	\$2,933.58	\$2,816.24	\$2,698.89	\$2,581.55	95

### Twistable



Waveguide Type	RF Frequency (GHz.)	IL (dB)	Max VSWR	Length (in)	Flange Type	ECCN	Model No	1 Pc. Price	See Web for Volume Pricing	R O W
WR-22	33 - 50	0.6	1.3:1	6	Round Cover UG-383/U	EAR99	<a href="#">PE-W22TF005-6</a>	\$860.18	See Web for Volume Pricing	96
		0.6	1.3:1	12	Round Cover UG-383/U	EAR99	<a href="#">PE-W22TF005-12</a>	\$875.28		97
		0.6	1.3:1	24	Round Cover UG-383/U	EAR99	<a href="#">PE-W22TF005-24</a>	\$920.55		98
WR-28	26.5 - 40	0.6	1.3:1	12	Square Cover UG-599/U	EAR99	<a href="#">PE-W28TF005-12</a>	\$566.78		99
		1.2	1.3:1	24	Square Cover UG-599/U	EAR99	<a href="#">PE-W28TF005-24</a>	\$635.41		1
		1.8	1.3:1	36	Square Cover UG-599/U	EAR99	<a href="#">PE-W28TF005-36</a>	\$620.28		2
WR-34	22 - 33	0.5	1.22:1	12	Square Cover UG-1530/U	EAR99	<a href="#">PE-W34TF005-12</a>	\$526.90		3
		1	1.22:1	24	Square Cover UG-1530/U	EAR99	<a href="#">PE-W34TF005-24</a>	\$593.24		4
		1.5	1.22:1	36	Square Cover UG-1530/U	EAR99	<a href="#">PE-W34TF005-36</a>	\$635.02		5
WR-42	18 - 26.5	0.35	1.3:1	12	Square Cover UG-595/U	EAR99	<a href="#">PE-W42TF005-12</a>	\$487.71	6	
		0.7	1.3:1	24	Square Cover UG-595/U	EAR99	<a href="#">PE-W42TF005-24</a>	\$518.04	7	
		1.05	1.35:1	36	Square Cover UG-595/U	EAR99	<a href="#">PE-W42TF005-36</a>	\$542.02	8	
WR-51	15 - 22	0.55	1.15:1	12	Square Cover	EAR99	<a href="#">PE-W51TF005-12</a>	\$515.19	9	

## Twistable



Waveguide Type	RF Frequency (GHz.)	IL (dB)	Max VSWR	Length (in)	Flange Type	ECCN	Model No	1 Pc. Price	See Web for Volume Pricing	ROW
WR-51	15 - 22	1.1	1.15:1	24	Square Cover	EAR99	<a href="#">PE-W51TF005-24</a>	\$535.74	See Web for Volume Pricing	10
		1.65	1.15:1	36	Square Cover	EAR99	<a href="#">PE-W51TF005-36</a>	\$596.32		11
WR-62	12.4 - 18	0.28	1.1:1	12	Square Cover UG-419/U	EAR99	<a href="#">PE-W62TF005-12</a>	\$574.60		12
		0.56	1.1:1	24	Square Cover UG-419/U	EAR99	<a href="#">PE-W62TF005-24</a>	\$668.47		13
		0.84	1.1:1	36	Square Cover UG-419/U	EAR99	<a href="#">PE-W62TF005-36</a>	\$683.22		14
WR-75	10 - 15	0.18	1.1:1	12	Square Cover	EAR99	<a href="#">PE-W75TF005-12</a>	\$629.75		15
		0.36	1.1:1	24	Square Cover	EAR99	<a href="#">PE-W75TF005-24</a>	\$626.67		16
		0.54	1.1:1	36	Square Cover	EAR99	<a href="#">PE-W75TF005-36</a>	\$674.31		17
WR-90	8.2 - 12.4	0.15	1.07:1	12	CPR-90G	EAR99	<a href="#">PE-W90TF006-12</a>	\$535.74		18
		0.15	1.1:1	12	Square Cover UG-39/U	EAR99	<a href="#">PE-W90TF005-12</a>	\$680.95		19
		0.3	1.07:1	24	CPR-90G	EAR99	<a href="#">PE-W90TF006-24</a>	\$650.64		20
		0.36	1.1:1	24	Square Cover UG-39/U	EAR99	<a href="#">PE-W90TF005-24</a>	\$726.67		21
		0.45	1.07:1	36	CPR-90G	EAR99	<a href="#">PE-W90TF006-36</a>	\$714.12		22
WR-112	7.05 - 10	0.12	1.07:1	12	CPR-112G	EAR99	<a href="#">PE-W112TF006-12</a>	\$676.80		23
		0.12	1.3:1	12	Square Cover UG-51/U	EAR99	<a href="#">PE-W112TF005-12</a>	\$699.07		24
		0.24	1.07:1	24	CPR-112G	EAR99	<a href="#">PE-W112TF006-24</a>	\$759.00		25
		0.24	1.07:1	24	Square Cover UG-51/U	EAR99	<a href="#">PE-W112TF005-24</a>	\$714.11		26
		0.36	1.07:1	36	CPR-112G	EAR99	<a href="#">PE-W112TF006-36</a>	\$792.58		27
WR-137	5.85 - 8.2	0.07	1.05:1	12	CPR-137G	EAR99	<a href="#">PE-W137TF006-12</a>	\$650.64		28
		0.07	1.05:1	12	Round Cover UG-344/U	EAR99	<a href="#">PE-W137TF005-12</a>	\$651.13		29
		0.14	1.05:1	24	CPR-137G	EAR99	<a href="#">PE-W137TF006-24</a>	\$742.69		30
		0.14	1.05:1	24	Round Cover UG-344/U	EAR99	<a href="#">PE-W137TF005-24</a>	\$813.56		31
		0.18	1.05:1	36	Round Cover UG-344/U	EAR99	<a href="#">PE-W137TF005-36</a>	\$918.15		32
		0.21	1.05:1	36	CPR-137G	EAR99	<a href="#">PE-W137TF006-36</a>	\$846.15		33
										34
										35

## WAVEGUIDE GUNN OSCILLATORS



WG Type	Center Freq. (GHz.)	Tuning Range (GHz.)	Integrated Heatsink	Phase Noise (dBc/Hz)	Output Power (dBm)	Flange Type	ECCN	Model No	1-9	10-24	25-49	50+	ROW
WR-42	24.125	+/- 1	No	-98	12.5	Square Cover UG-595/U	EAR99	<a href="#">PEWGN1012</a>	\$1,356.18	\$1,288.37	\$1,220.56	\$1,166.31	36
WR-28	35	+/- 3	No	-95	15	Square Cover UG-599/U	EAR99	<a href="#">PEWGN1010</a>	\$8,051.18	\$7,648.62	\$7,246.06	\$6,924.01	37
		+/- 3	Yes	-95	15	Square Cover UG-599/U	EAR99	<a href="#">PEWGN1011</a>	\$7,639.18	\$7,257.22	\$6,875.26	\$6,569.69	38
WR-90	93.75	+/- 0.25	No	-105	18.5	Square Cover UG-39/U	EAR99	<a href="#">PEWGN1013</a>	\$3,828.18	\$3,636.77	\$3,445.36	\$3,292.23	39

## WAVEGUIDE ISOLATORS



WG Type	RF Freq. (GHz.)	Min Isolation (dB)	Max IL (dB)	Max VSWR	Flange Type	ECCN	Model No	1	2-4	5-9	10+	ROW	
WR-10	75 - 110	25	2.3	1.5:1	UG-387/U-Mod		<a href="#">PEWIR1000</a>	Call	Call	Call	Call	40	
WR-12	60 - 90		2	1.5:1	UG-387/U		<a href="#">PEWIR1001</a>	\$2,821.60	\$2,708.74	\$2,595.87	\$2,483.01	41	
WR-15	50 - 75		1.8	1.4:1	UG-385/U		<a href="#">PEWIR1002</a>	\$2,717.05	\$2,608.37	\$2,499.69	\$2,391.00	42	
WR-19	40 - 60		1.6	1.4:1	UG-383/U-Mod		<a href="#">PEWIR1003</a>	\$2,821.60	\$2,708.74	\$2,595.87	\$2,483.01	43	
WR-22	33 - 50		1.5	1.4:1	UG-383/U		<a href="#">PEWIR1004</a>	\$2,772.27	\$2,661.38	\$2,550.49	\$2,439.60	44	
WR-28	26.5 - 40					UG-599/U		<a href="#">PEWIR1015</a>	\$2,985.97	\$2,866.53	\$2,747.09	\$2,627.65	45
WR-42	18 - 26.5					UG-597/U		<a href="#">PEWIR1010</a>	\$2,487.83	\$2,388.32	\$2,288.80	\$2,189.29	46
WR-62	12.4 - 18					UG-1665/U		<a href="#">PEWIR1009</a>	\$2,412.86	\$2,316.35	\$2,219.83	\$2,123.32	47
WR-75	10 - 15					Cover		<a href="#">PEWIR1008</a>	\$2,327.91	\$2,234.79	\$2,141.68	\$2,048.56	48
WR-90	8.2 - 12.4					UG-135/U		<a href="#">PEWIR1007</a>	\$2,371.18	\$2,276.33	\$2,181.49	\$2,086.64	49
WR-112	7.05 - 10					UG-138/U		<a href="#">PEWIR1006</a>	\$2,466.50	\$2,367.84	\$2,269.18	\$2,170.52	50



## WAVEGUIDE LOW NOISE AMPLIFIERS



RF Freq. (GHz.)	Gain (dB)	Gain Variation ± (dB)	NF (dB)	P1dB (dBm)	IP3 (dBm)	Waveguide Type	ECCN	Model No	1	2-4	5-9	10+	ROW
26.5 - 40	47	2.5	3.2	20	25	WR-28	EAR99	<a href="#">PE15A1076</a>	\$9,871.27	\$9,476.42	\$9,081.57	\$8,686.72	51
27 - 40	35	3	3	10	20		EAR99	<a href="#">PE15A1077</a>	\$9,114.65	\$8,750.06	\$8,385.48	\$8,020.89	52

## WAVEGUIDE MAGIC TEES



Waveguide Type	RF Frequency (GHz.)	Flange Type	IL (dB)	Min Isolation (dB)	ECCN	Model No	1	2-4	5-9	10+	ROW
WR-10	75 - 110	Round Cover UG-387/U-Mod	1	25	EAR99	<a href="#">PEWMT1000</a>	\$2,786.39	\$2,674.93	\$2,563.48	\$2,452.02	53
WR-12	60 - 90	Round Cover UG-387/U			EAR99	<a href="#">PEWMT1001</a>	\$2,815.03	\$2,702.43	\$2,589.83	\$2,477.23	54
WR-15	50 - 75	Round Cover UG-385/U			EAR99	<a href="#">PEWMT1002</a>	\$2,670.14	\$2,563.33	\$2,456.53	\$2,349.72	55
WR-19	40 - 60	Round Cover UG-383/U-Mod	0.8		EAR99	<a href="#">PEWMT1003</a>	\$2,408.23	\$2,311.90	\$2,215.57	\$2,119.24	56
WR-22	33 - 50	Round Cover UG-383/U	0.7		EAR99	<a href="#">PEWMT1004</a>	\$2,408.23	\$2,311.90	\$2,215.57	\$2,119.24	57
WR-28	26.5 - 40	Square Cover UG-599/U	0.5		EAR99	<a href="#">PEWMT1005</a>	\$2,293.98	\$2,202.22	\$2,110.46	\$2,018.70	58
WR-42	18 - 26.5	Square Cover UG-595/U		EAR99	<a href="#">PEWMT1006</a>	\$2,249.01	\$2,159.05	\$2,069.09	\$1,979.13	59	

## WAVEGUIDE ORTHOMODE TRANSDUCERS



RF Freq. (GHz.)	H to A IL (dB)	V to A IL (dB)	H to V Isolation (dB)	H to A Cross Polarization (dB)	V to A Cross Polarization (dB)	Waveguide Type	ECCN	Model No	1	2-4	5-9	10+	ROW
24 - 33	0.6	0.5	45	35	35	WR-34	EAR99	<a href="#">PEWOT0001</a>	\$5,371.65	\$5,183.64	\$4,995.63	\$4,834.49	60
30 - 42	0.5		40	35	35	WR-28	EAR99	<a href="#">PEWOT0003</a>	\$5,096.18	\$4,917.81	\$4,739.45	\$4,586.56	61
26.5 - 40		35		35	EAR99		<a href="#">PEWOT0007</a>	\$4,820.71	\$4,651.99	\$4,483.26	\$4,338.64	62	
60 - 90	1.2	0.8		35	35	WR-12	EAR99	<a href="#">PEWOT0009</a>	\$4,848.25	\$4,678.56	\$4,508.87	\$4,363.43	63
8.2 - 12.4						WR-90	EAR99	<a href="#">PEWOT0014</a>	\$3,856.57	\$3,721.59	\$3,586.61	\$3,470.91	64

## WAVEGUIDE PHASE SHIFTERS



WG Type	RF Freq. (GHz.)	Phase Range (GHz.)	Input Power (Watts)	IL (dB)	Length (in)	Flange Type	ECCN	Model No	1	2-4	5-9	10+	ROW
WR-10	75 - 110	0 - 180°	0.6	1	3	Round Cover UG-387/U-Mod	EAR99	<a href="#">PE-W10PS1001</a>	\$2,207.30	\$2,119.01	\$2,030.72	\$1,942.42	65
WR-12	60 - 90	0 - 180°	0.7	1	3	Round Cover UG-387/U	EAR99	<a href="#">PE-W12PS1001</a>	\$2,293.38	\$2,201.64	\$2,109.91	\$2,018.17	66
WR-15	50 - 75	0 - 180°	0.8	1	3	Round Cover UG-385/U	EAR99	<a href="#">PE-W15PS1001</a>	\$2,259.55	\$2,169.17	\$2,078.79	\$1,988.40	67
WR-19	40 - 60	0 - 180°	1	1	3	Round Cover UG-383/U-Mod	EAR99	<a href="#">PE-W19PS1001</a>	\$2,174.74	\$2,087.75	\$2,000.76	\$1,913.77	68
WR-22	33 - 50	0 - 180°	1	1	4	Round Cover UG-383/U	EAR99	<a href="#">PE-W22PS1001</a>	\$2,293.38	\$2,201.64	\$2,109.91	\$2,018.17	69
WR-28	26.5 - 40	0 - 180°	1		4	Square Cover UG-599/U	EAR99	<a href="#">PE-W28PS1002</a>	\$2,848.99	\$2,735.03	\$2,621.07	\$2,507.11	70
WR-42	18 - 26.5	0 - 180°	1.5	1	4	Square Cover UG-595/U	EAR99	<a href="#">PE-W42PS1001</a>	\$2,293.38	\$2,201.64	\$2,109.91	\$2,018.17	71

## WAVEGUIDE PIN DIODE SWITCHES



WG Type	Switch Type	RF Freq. (GHz.)	IL (dB)	Min Isolation (dB)	Max Switching (in)	Flange Type	ECCN	Model No	1	2-4	5-9	10+	ROW
WR-10	SPST/ Reflective	75 - 110	5.5	20	300	Round Cover UG-387/U	EAR99	<a href="#">PE71S9003</a>	\$8,669.44	\$8,322.66	\$7,975.88	\$7,629.11	72
	SPDT/ Reflective		7	20	300	Round Cover UG-387/U	EAR99	<a href="#">PE71S9004</a>	\$10,294.96	\$9,883.16	\$9,471.36	\$9,059.56	73
WR-12	SPST/ Reflective	60 - 90	4.5	20	300	Round Cover UG-387/U	EAR99	<a href="#">PE71S9001</a>	\$7,946.63	\$7,628.76	\$7,310.90	\$6,993.03	74
	SPDT/ Reflective		6	20	300	Round Cover UG-387/U	EAR99	<a href="#">PE71S9002</a>	\$9,392.27	\$9,016.58	\$8,640.89	\$8,265.20	75

## PIN DIODE SWITCHES, see page 331

## WAVEGUIDE POLARIZERS



Band	RF Freq. (GHz.)	Typ Bandwidth (GHz)	Typ IL (dB)	Typ Axial Ratio (dB)	Length (in)	Flange Type	ECCN	Model No	1	2-4	5-9	10+	ROW
Ku	14 - 16	±1	0.5	1.1	3	Square Cover UG-419/U-Mod	EAR99	<a href="#">PEWPL0000</a>	\$4,223.00	\$4,075.20	\$3,927.39	\$3,800.70	76
Ka	26 - 33	±3.5		1.1	2	Square Cover UG-599/U-Mod	EAR99	<a href="#">PEWPL0005</a>	\$4,223.00	\$4,075.20	\$3,927.39	\$3,800.70	77
V	58 - 63	±2.5		1.1	1	Round Cover UG-385/U-Mod	EAR99	<a href="#">PEWPL0008</a>	\$4,223.00	\$4,075.20	\$3,927.39	\$3,800.70	78

## WAVEGUIDE POWER AMPLIFIERS



Waveguide Type	RF Frequency (GHz.)	Min Gain (dB)	Psat (dBm)	Flange Type	ECCN	Model No	1	2-4	5-9	10+	ROW
WR-12	70.5 - 76.5	25	20	Round Cover UG-387/U	EAR99	<a href="#">PE15A4023</a>	\$11,090.00	\$10,646.40	\$10,202.80	\$9,759.20	79
	80.5 - 86.5	20	19	Round Cover UG-387/U	EAR99	<a href="#">PE15A4024</a>	\$11,537.55	\$11,076.05	\$10,614.55	\$10,153.04	80

## WAVEGUIDE SECTIONS



WG Type	RF Freq. (GHz.)	IL (dB)	VSWR	Length (in)	Flange Type	ECCN	Model No	1-9	10-24	25-49	50+	ROW
WR-5	140 - 220			1	Round Cover UG-387/U-Mod	EAR99	<a href="#">PEW05S000-1</a>	\$620.84	\$589.80	\$558.76	\$533.92	81
				3		EAR99	<a href="#">PEW05S000-3</a>	\$577.19	\$548.33	\$519.47	\$496.38	82
				6		EAR99	<a href="#">PEW05S000-6</a>	\$740.86	\$703.82	\$666.77	\$637.14	83
				9		EAR99	<a href="#">PEW05S000-9</a>	\$837.43	\$795.56	\$753.69	\$720.19	84
				12		EAR99	<a href="#">PEW05S000-12</a>	\$980.90	\$931.86	\$882.81	\$843.57	85
WR-6	110 - 170	0.35	1.15:1	1		EAR99	<a href="#">PEW06S000-1</a>	\$500.83	\$475.79	\$450.75	\$430.71	86
		0.55		3		EAR99	<a href="#">PEW06S000-3</a>	\$544.46	\$517.24	\$490.01	\$468.24	87
		0.75		6		EAR99	<a href="#">PEW06S000-6</a>	\$697.68	\$662.80	\$627.91	\$600.00	88
		1.5		9		EAR99	<a href="#">PEW06S000-9</a>	\$805.18	\$764.92	\$724.66	\$692.45	89
				12		EAR99	<a href="#">PEW06S000-12</a>	\$934.18	\$887.47	\$840.76	\$803.39	90
				1		EAR99	<a href="#">PEW08S000-1</a>	\$435.36	\$413.59	\$391.82	\$374.41	91
WR-8	90 - 140	0.3		3		EAR99	<a href="#">PEW08S000-3</a>	\$479.00	\$455.05	\$431.10	\$411.94	92
		0.5		6		EAR99	<a href="#">PEW08S000-6</a>	\$653.57	\$620.89	\$588.21	\$562.07	93

## WAVEGUIDE SECTIONS



WG Type	RF Freq. (GHz.)	IL (dB)	VSWR	Length (in)	Flange Type	ECCN	Model No	1 Pc. Price	See Web for Volume Pricing	R O W
WR-8	90 - 140	0.7	1.15:1	9	Round Cover UG-387/U-Mod	EAR99	<a href="#">PEW08S000-9</a>	\$805.18		94
		1.2		12		EAR99	<a href="#">PEW08S000-12</a>	\$948.17		95
WR-10	75 - 110	0.25		3		EAR99	<a href="#">PEW10S010-3</a>	\$503.41		96
		0.5		6		EAR99	<a href="#">PEW10S010-6</a>	\$515.41		97
WR-12	60 - 90	0.3		3	Round Cover UG-387/U	EAR99	<a href="#">PEW12S010-3</a>	\$391.73		98
		0.5		6		EAR99	<a href="#">PEW12S010-6</a>	\$412.47		99
		0.64		9		EAR99	<a href="#">PE-W12S001-9</a>	\$513.24		1
		0.8		12		EAR99	<a href="#">PEW12S010-9</a>	\$513.24		2
WR-15	50 - 75	0.82	1.06:1	12	Round Cover UG-385/U	EAR99	<a href="#">PE-W12S001-12</a>	\$532.95		3
		0.2		3		EAR99	<a href="#">PE-W15S001-3</a>	\$418.71		4
		0.34		6		EAR99	<a href="#">PE-W15S001-6</a>	\$426.23		5
		0.49		9		EAR99	<a href="#">PE-W15S001-9</a>	\$501.83		6
		0.64		12		EAR99	<a href="#">PE-W15S001-12</a>	\$699.32		7
		0.95				EAR99	<a href="#">PEW15S010-12</a>	\$699.32		8
WR-19	40 - 60	0.15		3	Round Cover UG-383/U-Mod	EAR99	<a href="#">PE-W19S001-3</a>	\$388.78		9
		0.2		6		EAR99	<a href="#">PEW19S010-3</a>	\$388.78		10
		0.25		9		EAR99	<a href="#">PE-W19S001-6</a>	\$441.01		11
		0.34		12		EAR99	<a href="#">PE-W19S001-9</a>	\$501.83		12
		0.44				EAR99	<a href="#">PE-W19S001-12</a>	\$570.26		13
		0.8				EAR99	<a href="#">PEW19S010-12</a>	\$561.84		14
WR-22	33 - 50	0.13	1.1:1	3	Round Cover UG-383/U	EAR99	<a href="#">PE-W22S001-3</a>	\$385.10		15
		0.21		6		EAR99	<a href="#">PE-W22S001-6</a>	\$405.04		16
		0.25	3	EAR99		<a href="#">PEW22S010-3</a>	\$428.93	17		
		0.29	9	EAR99		<a href="#">PE-W22S001-9</a>	\$458.34	18		
		0.36	12	EAR99		<a href="#">PE-W22S001-12</a>	\$551.25	19		
	1.09:1	4	EAR99	<a href="#">PEWSP1000</a>	\$634.77	20				
WR-28	26.5 - 40	0.11	1.06:1	3	Square Cover UG-599/U	EAR99	<a href="#">PE-W28S001-3</a>	\$363.03		21
		0.2		6		EAR99	<a href="#">PEW28S010-3</a>	\$396.08		22
		0.22		9		EAR99	<a href="#">PEW28S010-6</a>	\$441.91		23
						EAR99	<a href="#">PE-W28S001-9</a>	\$475.22		24
WR-34	20 - 33		1.09:1	4	Square Cover UG-1530/U	EAR99	<a href="#">PEWSP1001</a>	\$560.08	25	
			1.07:1	4	Square Cover UG-1530/U	EAR99	<a href="#">PEWSP1002</a>	\$578.76	26	
WR-42	18 - 26.5	0.08	1.06:1	3	Square Cover UG-595/U	EAR99	<a href="#">PE-W42S002-3</a>	\$428.93		27
		0.12		6		EAR99	<a href="#">PE-W42S001A-6</a>	\$398.69		28
		0.15		9		EAR99	<a href="#">PE-W42S001A-9</a>	\$470.32		29
		0.18		12		EAR99	<a href="#">PE-W42S001-12</a>	\$572.74		30
			1.07:1	4		EAR99	<a href="#">PEWSP1003</a>	\$560.08	31	
WR-51	15 - 22	0.11	1.06:1	9	UBR180	EAR99	<a href="#">PE-W51S001-9</a>	\$399.92		32
		0.13		12	EAR99	<a href="#">PE-W51S001-12</a>	\$541.16	33		
			1.07:1	4	Square Cover	EAR99	<a href="#">PEWSP1004</a>	\$597.44	34	
WR-62	12.4 - 18	0.08	1.06:1	6	Square Cover UG-419/U	EAR99	<a href="#">PE-W62S002-6</a>	\$456.89		35
		0.1		9		EAR99	<a href="#">PE-W62S002-9</a>	\$542.16		36
		0.11		12		EAR99	<a href="#">PE-W62S002-12</a>	\$613.85		37
			3	EAR99		<a href="#">PE-W62S001-3</a>	\$341.08	38		
			1.03:1	4		EAR99	<a href="#">PEWSP1005</a>	\$576.07		39
			1.07:1	6		EAR99	<a href="#">PE-W62S001-6</a>	\$348.44		40
WR-75	10 - 15	0.1		9	UBR120	EAR99	<a href="#">PE-W75S001A-6</a>	\$336.05		41
				3	EAR99	<a href="#">PE-W75S001-3</a>	\$350.72	42		
				4	EAR99	<a href="#">PEWSP1006</a>	\$587.43	43		
				6	EAR99	<a href="#">PE-W75S001-6</a>	\$341.08	44		
WR-90	8.2 - 12.4	0.1	1.03:1	9	Square Cover	EAR99	<a href="#">PE-W75S001-9</a>	\$348.44		45
				3	Square Cover UG-39/U	EAR99	<a href="#">PE-W90S001A-9</a>	\$256.56		46
				3	CPR-90G	EAR99	<a href="#">PE-W90S001-3</a>	\$223.73	47	
				4	Square Cover UG-39/U	EAR99	<a href="#">PE-W90S002-3</a>	\$276.87	48	
				4	Square Cover UG-39/U	EAR99	<a href="#">PEWSP1007</a>	\$606.38	49	
				4	CPR-90G	EAR99	<a href="#">PEWSP1008</a>	\$604.89	50	
				6	Square Cover UG-39/U	EAR99	<a href="#">PE-W90S001-6</a>	\$227.39	51	
				6	CPR-90G	EAR99	<a href="#">PE-W90S002-6</a>	\$325.88	52	
				9	Square Cover UG-39/U	EAR99	<a href="#">PE-W90S001-9</a>	\$260.41	53	
				9	CPR-90G	EAR99	<a href="#">PE-W90S002-9</a>	\$324.84	54	
		12	Square Cover UG-39/U	EAR99	<a href="#">PE-W90S001-12</a>	\$272.26	55			
		12	CPR-90G	EAR99	<a href="#">PE-W90S002-12</a>	\$337.83	56			
									57	
									58	

See Web for Volume Pricing

## WAVEGUIDE SECTIONS



WG Type	RF Freq. (GHz.)	IL (dB)	VSWR	Length (in)	Flange Type	ECCN	Model No	1 Pc. Price	See Web for Volume Pricing	ROW	
WR-112	7.05 - 10		1.03:1	3	Square Cover UG-51/U	EAR99	<a href="#">PE-W112S001-3</a>	\$344.76	See Web for Volume Pricing	59	
			1.07:1	4		EAR99	<a href="#">PEWSP1009</a>	\$616.09		60	
			1.03:1	6	CPR-112G	EAR99	<a href="#">PEWSP1010</a>	\$619.84		61	
				9	Square Cover UG-51/U	EAR99	<a href="#">PE-W112S001-6</a>	\$331.35		62	
				12		EAR99	<a href="#">PE-W112S001-9</a>	\$379.42		63	
WR-137	5.85 - 8.2	0.1	1.03:1	6	CPR-137G	EAR99	<a href="#">PE-W137S002A-6</a>	\$390.26		64	
				3	Round Cover UG-344/U	EAR99	<a href="#">PE-W137S001-3</a>	\$367.90		65	
		1.07:1	4	CPR-137G	EAR99	<a href="#">PE-W137S002-3</a>	\$366.77	66			
			6	Round Cover UG-344/U	EAR99	<a href="#">PEWSP1011</a>	\$642.24	67			
			9	CPR-137G	EAR99	<a href="#">PEWSP1012</a>	\$636.68	68			
		1.03:1	6	Round Cover UG-344/U	EAR99	<a href="#">PE-W137S001-6</a>	\$370.32	69			
			9		EAR99	<a href="#">PE-W137S001-9</a>	\$405.03	70			
			12	CPR-137G	EAR99	<a href="#">PE-W137S002-9</a>	\$381.40	71			
		WRD-180	18 - 40	0.4	1.25:1	3	Square Cover UG	EAR99	<a href="#">PEWRD180S001-3</a>	\$602.66	72
				0.5		6		EAR99	<a href="#">PEWRD180S001-6</a>	\$1,009.85	73
WRD-650	6.5 - 18	0.3	1.15:1	3	EAR99	<a href="#">PEWRD650S001-3</a>		\$537.50	74		
		0.4		6	EAR99	<a href="#">PEWRD650S001-6</a>		\$912.12	75		
WRD-750	7.5 - 18	0.3	1.15:1	3	EAR99	<a href="#">PEWRD750S001-3</a>		\$537.50	76		
		0.4		6	EAR99	<a href="#">PEWRD750S001-6</a>		\$912.12	77		
										78	
											79
											80

## WAVEGUIDE TERMINATIONS



Waveguide Type	RF Frequency (GHz.)	Input Power (Watts)	Max VSWR	Length (in)	Flange Type	ECCN	Model No	1 Pc. Price	See Web for Volume Pricing	ROW
WR-10	75 - 110	0.4	1.06:1	2	Round Cover UG-387/U	EAR99	<a href="#">PEW10TR0001</a>	\$557.93	See Web for Volume Pricing	81
		0.4	1.25:1		Round Cover UG-387/U-Mod	EAR99	<a href="#">PE-W10TR1001</a>	\$588.37		82
WR-12	60 - 90	0.6	1.2:1	Round Cover UG-387/U	EAR99	<a href="#">PE-W12TR1001</a>	\$570.31	83		
WR-15	50 - 75	1	1.2:1	Round Cover UG-385/U	EAR99	<a href="#">PEW15TR0001</a>	\$599.02	84		
WR-19	40 - 60	2	1.06:1	Round Cover UG-383/U	EAR99	<a href="#">PEW19TR0001</a>	\$502.93	85		
		2	1.09:1	Round Cover UG-383/U-Mod	EAR99	<a href="#">PE-W19TR1001</a>	\$530.38	86		
WR-22	33 - 50	4	1.05:1	Round Cover UG-383/U	EAR99	<a href="#">PE-W22TR1002</a>	\$518.28	87		
WR-28	26.5 - 40	0.5	1.3:1	1	Square Cover UG-599/U	EAR99	<a href="#">PE6800</a>	\$485.38		88
		0.5	1.05:1	2	Square Cover	EAR99	<a href="#">PE6809</a>	\$925.09		89
		0.5	1.02:1	Square Cover UG-599/U	EAR99	<a href="#">PEWTR1000</a>	\$716.65	90		
	29.4 - 31	1	1.03:1	2	Square Cover UG-599/U	EAR99	<a href="#">PE-W28TR1003</a>	\$532.13		91
		2	1.15:1	1	Square Cover UG-599/U	EAR99	<a href="#">PE-W28TR1002</a>	\$374.46		92
		40	1.07:1	3	Square Cover	EAR99	<a href="#">PE6818</a>	\$1,006.58	93	
		50	1.25:1	4	Square Cover UG-599/U	EAR99	<a href="#">PE-W28TR1004</a>	\$886.88	94	
WR-34	22 - 33	0.5	1.25:1	1	Square Cover	EAR99	<a href="#">PE6801</a>	\$384.32	95	
		0.5	1.05:1	3	Square Cover	EAR99	<a href="#">PE6810</a>	\$889.49	96	
WR-42	19.6 - 21.2	1	1.15:1	1	Square Cover UG-597/U	EAR99	<a href="#">PE-W34TR1001</a>	\$413.88	97	
		1	1.25:1	Square Cover UG-1530/U	EAR99	<a href="#">PEWTR1001</a>	\$627.29	98		
	22 - 33	45	1.1:1	4	Square Cover	EAR99	<a href="#">PE6819</a>	\$1,422.00	99	
		75	1.1:1	Square Cover	EAR99	<a href="#">PE6828</a>	\$1,319.98	1		
WR-51	18 - 26.5	0.5	1.25:1	1	Square Cover UG-597/U	EAR99	<a href="#">PE6802</a>	\$471.63	2	
		0.5	1.05:1	3	Square Cover	EAR99	<a href="#">PE6811</a>	\$1,047.79	3	
	19.6 - 21.2	1	1.15:1	1	Square Cover UG-597/U	EAR99	<a href="#">PE-W42TR1002</a>	\$374.46	4	
		1	1.02:1	Square Cover UG-595/U	EAR99	<a href="#">PEWTR1002</a>	\$622.15	5		
		6	1.08:1	3	Square Cover UG-595/U	EAR99	<a href="#">PE-W42TR1001</a>	\$559.12	6	
18 - 26.5	50	1.07:1	4	Square Cover	EAR99	<a href="#">PE6820</a>	\$938.93	7		
	100	1.1:1	Square Cover	EAR99	<a href="#">PE6829</a>	\$997.21	8			
	1	1.2:1	1	Square Cover	EAR99	<a href="#">PE6803</a>	\$432.67	9		
15 - 18	15 - 22	1	1.05:1	3	Square Cover	EAR99	<a href="#">PE6812</a>	\$1,082.72	10	
		1	1.02:1	Square Cover	EAR99	<a href="#">PEWTR1003</a>	\$645.78	11		
									12	



Technical Support  
+1 (949) 261-1920



Same-Day Shipping,  
Even Custom  
Cable Assemblies



## WAVEGUIDE TERMINATIONS

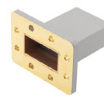
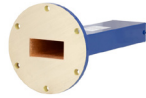

Waveguide Type	RF Frequency (GHz.)	Input Power (Watts)	Max VSWR	Length (in)	Flange Type	ECCN	Model No	1 Pc. Price	See Web for Volume Pricing	R O W
WR-62	14.5 - 17.8	1	1.05:1	1	Square Cover UG-1665/U	EAR99	<a href="#">PE-W62TR1003</a>	\$453.29	See Web for Volume Pricing	13
	12.4 - 18	1.5	1.02:1		Square Cover UG-419/U	EAR99	<a href="#">PEWTR1004</a>	\$606.38		14
	11.9 - 18	2	1.03:1	4	Square Cover		<a href="#">PE6201A</a>	\$536.43		15
	12.4 - 18	2	1.2:1	1	Square Cover	EAR99	<a href="#">PE6804</a>	\$486.35		16
WR-75	10 - 15	60	1.07:1	4	Square Cover	EAR99	<a href="#">PE6836</a>	\$971.89		17
		2	1.2:1	1	Square Cover	EAR99	<a href="#">PE6805</a>	\$724.47		18
		2	1.05:1	4	Square Cover	EAR99	<a href="#">PE6814</a>	\$874.79		19
		2.5	1.02:1		Square Cover	EAR99	<a href="#">PEWTR1005</a>	\$653.06		20
		75	1.07:1	5	Square Cover	EAR99	<a href="#">PE6823</a>	\$965.35		21
		175	1.1:1	6	Square Cover	EAR99	<a href="#">PE6832</a>	\$1,472.62		22
WR-90	8.2 - 12.4	2	1.2:1	1	Square Cover UG-135/U	EAR99	<a href="#">PE6806</a>	\$524.94		23
		2	1.05:1	4	Square Cover	EAR99	<a href="#">PE6815</a>	\$841.14		24
	9 - 10	2	1.05:1	1	Square Cover UG-135/U	EAR99	<a href="#">PE-W90TR1001</a>	\$492.71		25
		4	1.02:1		Square Cover UG-39/U	EAR99	<a href="#">PEWTR1006</a>	\$598.53		26
	8.2 - 12.4	4	1.02:1		CPR-90G	EAR99	<a href="#">PEWTR1007</a>	\$610.35		27
		50	1.25:1	4	Square Cover UG-135/U	EAR99	<a href="#">PE-W90TR1002</a>	\$1,103.66		28
8.2 - 12.4	90	1.07:1	6	Square Cover	EAR99	<a href="#">PE6824</a>	\$1,245.89	29		
		1.1:1		Square Cover	EAR99	<a href="#">PE6833</a>	\$1,639.32	30		
WR-102	7 - 11	300	1.1:1	7	Square Cover	EAR99	<a href="#">PE6834</a>	\$1,677.04		31
WR-112	7.05 - 10	2	1.2:1	1	Square Cover	EAR99	<a href="#">PE6808</a>	\$444.80		32
		5	1.02:1		Square Cover UG-51/U	EAR99	<a href="#">PEWTR1008</a>	\$637.89		33
		5	1.02:1		CPR-112G	EAR99	<a href="#">PEWTR1009</a>	\$690.97		34
		300	1.1:1	7	Square Cover UG-51/U	EAR99	<a href="#">PE6835</a>	\$2,266.17		35
WR-137	5.85 - 8.2	6	1.02:1		Round Cover UG-344/U	EAR99	<a href="#">PEWTR1010</a>	\$673.32		36
		6	1.02:1		CPR-137G	EAR99	<a href="#">PEWTR1011A</a>	\$665.15		37
WR-159	5.38 - 8.17	500	1.25:1	14	CPR-137F	EAR99	<a href="#">PE-W137TR1001</a>	\$2,601.50		38
	4.64 - 7.05	5	1.03:1	8	CPR-159F	EAR99	<a href="#">PE-W159TR1002</a>	\$670.08		39
WR-187	4.8 - 5.2	50	1.2:1	4	CPR-159F	EAR99	<a href="#">PE-W159TR1001</a>	\$1,241.63		40
	3.94 - 5.99	5	1.03:1	9	CPR-187F	EAR99	<a href="#">PE-W187TR1002</a>	\$591.25		41
WR-229	4.4 - 5	70	1.1:1	3	CPR-187F	EAR99	<a href="#">PE-W187TR1001</a>	\$709.50		42
		5	1.03:1	10	CPR-229F	EAR99	<a href="#">PE-W229TR1001</a>	\$788.33		43
WR-284	3.22 - 4.9	5	1.2:1	3	CPR-229F	EAR99	<a href="#">PE-W229TR1002</a>	\$867.16		44
		5	1.03:1	12	CPR-284F	EAR99	<a href="#">PE-W284TR1001</a>	\$1,103.66		45
WRD-180	18 - 40	0.5	1.15:1		Square Cover UG	EAR99	<a href="#">PEWRD180TR1000</a>	\$1,417.05		46
WRD-650	6.5 - 18	1	1.15:1	4	Square Cover UG	EAR99	<a href="#">PEWRD650TR1000</a>	\$1,075.00		47
WRD-750	7.5 - 18	1	1.15:1		Square Cover UG	EAR99	<a href="#">PEWRD750TR1000</a>	\$1,075.00		48

## WAVEGUIDE TRANSITIONS



WG 1 Type	Flange 1 Type	WG 2 Type	Flange 2 Type	VSWR	ECCN	Model No	1 Pc. Price	See Web for Volume Pricing	R O W
WR-10	Round Cover UG-387/U-Mod	WR-12	Round Cover UG-387/U	1.6:1	EAR99	<a href="#">PE-W10TS12001A</a>	\$1,328.18	See Web for Volume Pricing	49
		WR-15	Round Cover UG-385/U	1.45:1	EAR99	<a href="#">PE-W10TS15001</a>	\$1,321.63		50
		WR-19	Round Cover UG-383/U-Mod	1.4:1	EAR99	<a href="#">PE-W10TS19001</a>	\$1,363.82		51
WR-12	Round Cover UG-387/U	WR-15	Round Cover UG-385/U	1.2:1	EAR99	<a href="#">PE-W12TS15001</a>	\$1,374.49		52
WR-15	Round Cover UG-385/U	WR-19	Round Cover UG-383/U-Mod	1.1:1	EAR99	<a href="#">PE-W15TS19001</a>	\$1,374.49		53
		WR-22	Round Cover UG-383/U	1.15:1	EAR99	<a href="#">PE-W15TS22001</a>	\$1,363.82		54
WR-19	Round Cover UG-383/U-Mod	WR-22	Round Cover UG-383/U	1.5:1	EAR99	<a href="#">PE-W19TS22001</a>	\$1,321.63		55
		WR-28	Square Cover UG-599/U	1.35:1	EAR99	<a href="#">PE-W19TS28001</a>	\$1,374.49		56
WR-22	Round Cover UG-383/U	WR-28	Square Cover UG-599/U	1.35:1	EAR99	<a href="#">PE-W22TS28001</a>	\$1,374.49		57
		WR-42	Square Cover UG-595/U	1.35:1	EAR99	<a href="#">PE-W22TS42001</a>	\$1,253.25		58
WR-28	Square Cover UG-599/U	WR-42	Square Cover UG-595/U	1.2:1	EAR99	<a href="#">PE-W28TS42001</a>	\$1,253.25		59
		WR-51	UBR-180/U-Mod	1.38:1	EAR99	<a href="#">PE-W28TS51001</a>	\$1,438.22		60
WR-34	Square Cover UG-1530/U	WR-28	Square Cover UG-599/U	1.08:1	EAR99	<a href="#">PEWTS1010</a>	\$841.79		61
WR-42	Square Cover UG-595/U	WR-34	Square Cover UG-1530/U	1.08:1	EAR99	<a href="#">PEWTS1009</a>	\$816.31		62
WR-62	Square Cover UG-1665/U	WR-51	Square Cover	1.08:1	EAR99	<a href="#">PEWTS1007A</a>	\$837.24		63

## WAVEGUIDE TRANSITIONS



WG 1 Type	Flange 1 Type	WG 2 Type	Flange 2 Type	VSWR	ECCN	Model No	1-4	5-9	10-24	25+	ROW
WR-75	Square Cover	WR-62	Square Cover UG-1665/U	1.08:1	EAR99	<a href="#">PEWTS1006</a>	\$882.92	\$838.77	\$794.63	\$759.31	64
WR-90	Square Cover UG-39/U	WR-75	Square Cover	1.08:1	EAR99	<a href="#">PEWTS1004</a>	\$894.66	\$849.93	\$805.19	\$769.41	65
	CPR-90G	WR-75		1.08:1	EAR99	<a href="#">PEWTS1005A</a>	\$888.99	\$844.54	\$800.09	\$764.53	66
WR-112	Square Cover UG-51/U	WR-90	Square Cover UG-39/U	1.08:1	EAR99	<a href="#">PEWTS1002</a>	\$946.89	\$899.55	\$852.20	\$814.33	67
	CPR-112G	WR-90	CPR-90G	1.08:1	EAR99	<a href="#">PEWTS1003</a>	\$898.78	\$853.84	\$808.90	\$772.95	68
WR-137	Round Cover UG-344/U	WR-112	Square Cover UG-51/U	1.08:1	EAR99	<a href="#">PEWTS1000</a>	\$1,012.20	\$961.59	\$910.98	\$870.49	69
	CPR-137G	WR-112	CPR-112G	1.08:1	EAR99	<a href="#">PEWTS1001</a>	\$1,018.75	\$967.81	\$916.88	\$876.13	70

## WAVEGUIDE TWISTS



WG Type	RF Freq. (GHz.)	Max VSWR	WG Offset Angle (Deg)	Length (in)	Flange Type	ECCN	Model No	1-9	10-24	25-49	50+	ROW
WR-10	75 - 110	1.1:1	45 Left-hand	1	Round Cover UG-387/U-Mod	EAR99	<a href="#">PE-W10TW1002</a>	\$456.33	\$433.51	\$410.70	\$392.44	71
			45 Right-hand		Round Cover UG-387/U-Mod	EAR99	<a href="#">PE-W10TW1003</a>	\$449.59	\$427.11	\$404.63	\$386.65	72
			90		Round Cover UG-387/U-Mod	EAR99	<a href="#">PE-W10TW1001</a>	\$430.35	\$408.83	\$387.32	\$370.10	73
WR-12	60 - 90	1.16:1	45 Left-hand	1	Round Cover UG-387/U	EAR99	<a href="#">PE-W12TW1002</a>	\$456.33	\$433.51	\$410.70	\$392.44	74
			45 Right-hand		Round Cover UG-387/U	EAR99	<a href="#">PE-W12TW1003</a>	\$456.33	\$433.51	\$410.70	\$392.44	75
			90 Right-hand		Round Cover UG-387/U-Mod	EAR99	<a href="#">PEW12TW001</a>	\$510.49	\$484.97	\$459.44	\$439.02	76
			90		Round Cover UG-387/U	EAR99	<a href="#">PE-W12TW1001</a>	\$510.49	\$484.97	\$459.44	\$439.02	77
WR-15	50 - 75	1.11:1	45 Left-hand	1	Round Cover UG-385/U	EAR99	<a href="#">PE-W15TW1002</a>	\$449.59	\$427.11	\$404.63	\$386.65	78
			45 Right-hand		Round Cover UG-385/U	EAR99	<a href="#">PE-W15TW1003</a>	\$456.33	\$433.51	\$410.70	\$392.44	79
			90		Round Cover UG-385/U	EAR99	<a href="#">PE-W15TW1001</a>	\$430.35	\$408.83	\$387.32	\$370.10	80
			90		Round Cover UG-385/U	EAR99	<a href="#">PE-W15TW1002</a>	\$449.59	\$427.11	\$404.63	\$386.65	81
WR-19	40 - 60	1.25:1	45 Left-hand	1	Round Cover UG-383/U-Mod	EAR99	<a href="#">PE-W19TW1002</a>	\$449.59	\$427.11	\$404.63	\$386.65	82
			45 Right-hand		Round Cover UG-383/U-Mod	EAR99	<a href="#">PE-W19TW1003</a>	\$449.59	\$427.11	\$404.63	\$386.65	83
			90		Round Cover UG-383/U-Mod	EAR99	<a href="#">PE-W19TW1001</a>	\$396.25	\$376.44	\$356.63	\$340.78	84
WR-22	33 - 50	1.02:1	45 Left-hand	2	Round Cover UG-383/U	EAR99	<a href="#">PE-W22TW1002</a>	\$449.59	\$427.11	\$404.63	\$386.65	85
			45 Right-hand		Round Cover UG-383/U	EAR99	<a href="#">PE-W22TW1003</a>	\$449.59	\$427.11	\$404.63	\$386.65	86
			90		Round Cover UG-383/U	EAR99	<a href="#">PEW22TW001</a>	\$396.25	\$376.44	\$356.63	\$340.78	87
			90		Round Cover UG-383/U	EAR99	<a href="#">PE-W22TW1001</a>	\$402.18	\$382.07	\$361.96	\$345.87	88
WR-28	26.5 - 40	1.1:1	45 Right-hand	1	Square Cover UG-595/U	EAR99	<a href="#">PEW28TW001</a>	\$481.07	\$457.02	\$432.96	\$413.72	89
			45 Left-hand		Square Cover UG-599/U	EAR99	<a href="#">PE-W28TW1002</a>	\$488.27	\$463.86	\$439.44	\$419.91	90
			45 Right-hand		Square Cover UG-599/U	EAR99	<a href="#">PE-W28TW1003</a>	\$488.27	\$463.86	\$439.44	\$419.91	91
			90		Square Cover UG-599/U	EAR99	<a href="#">PE-W28TW1001</a>	\$402.18	\$382.07	\$361.96	\$345.87	92
WR-42	18 - 26.5	1.25:1	45 Left-hand	3	Square Cover UG-595/U	EAR99	<a href="#">PE-W42TW1002</a>	\$475.67	\$451.89	\$428.10	\$409.08	93
			45 Right-hand		Square Cover UG-595/U	EAR99	<a href="#">PE-W42TW1003</a>	\$475.67	\$451.89	\$428.10	\$409.08	94
			90		Square Cover UG-595/U	EAR99	<a href="#">PE-W42TW1001</a>	\$419.57	\$398.59	\$377.61	\$360.83	95
WRD-750	7.5 - 18	1.25:1	90	8	Square Cover UG	EAR99	<a href="#">PEWRD750TW1001</a>	\$912.12	\$866.51	\$820.91	\$784.42	96
WRD-180	18 - 40	1.35:1	90	3	Square Cover UG	EAR99	<a href="#">PEWRD180TW1001</a>	\$1,009.85	\$959.36	\$908.87	\$868.47	97
WR-8	90 - 140	1.1:1	45 Right-hand	1	Square Cover UG-387/U-Mod	EAR99	<a href="#">PEW8TW0000</a>	\$544.46	\$517.24	\$490.01	\$468.24	98
			45 Left-hand		Square Cover UG-387/U-Mod	EAR99	<a href="#">PEW8TW0001</a>	\$536.43	\$509.61	\$482.79	\$461.33	99
			90 Right-hand		Round Cover UG-387/U-Mod	EAR99	<a href="#">PEW8TW0002</a>	\$536.43	\$509.61	\$482.79	\$461.33	1
WR-6	110 - 170	1.1:1	45 Right-hand	1	Square Cover UG-387/U-Mod	EAR99	<a href="#">PEW6TW0000</a>	\$544.46	\$517.24	\$490.01	\$468.24	2
			45 Left-hand		Square Cover UG-387/U-Mod	EAR99	<a href="#">PEW6TW0001</a>	\$536.43	\$509.61	\$482.79	\$461.33	3
			90 Right-hand		Round Cover UG-387/U-Mod	EAR99	<a href="#">PEW6TW0002</a>	\$544.46	\$517.24	\$490.01	\$468.24	4
WR-5	140 - 220	1.1:1	45 Right-hand	1	Square Cover UG-387/U-Mod	EAR99	<a href="#">PEW5TW0000</a>	\$577.19	\$548.33	\$519.47	\$496.38	5
			45 Left-hand		Square Cover UG-387/U-Mod	EAR99	<a href="#">PEW5TW0001</a>	\$568.68	\$540.25	\$511.81	\$489.06	6
			90 Right-hand		Round Cover UG-387/U-Mod	EAR99	<a href="#">PEW5TW0002</a>	\$568.68	\$540.25	\$511.81	\$489.06	7
WRD-650	6.5 - 18	1.25:1	90	8	Square Cover UG	EAR99	<a href="#">PEWRD650TW1001</a>	\$912.12	\$866.51	\$820.91	\$784.42	7



Technical Support  
+1 (949) 261-1920



Same-Day Shipping,  
Even Custom  
Cable Assemblies

## WAVEGUIDE VARIABLE ATTENUATORS



Waveguide Type	RF Frequency (GHz.)	Flange Type	IL (dB)	Max Atten. (dB)	ECCN	Model No	1	2-4	5-9	10+	ROW
WR-10	75 - 110	Round Cover UG-387/U-Mod	1	30	EAR99	<a href="#">PE-W10AT002-30</a>	\$2,029.41	\$1,948.23	\$1,867.06	\$1,785.88	8
WR-12	60 - 90	Round Cover UG-387/U	0.4		EAR99	<a href="#">PE-W12AT002-30</a>	\$2,098.22	\$2,014.29	\$1,930.36	\$1,846.43	9
WR-15	50 - 75	Round Cover UG-385/U	0.8		EAR99	<a href="#">PE-W15AT001-30</a>	\$2,098.22	\$2,014.29	\$1,930.36	\$1,846.43	10
WR-19	40 - 60	Round Cover UG-383/U-Mod	0.6		EAR99	<a href="#">PE-W19AT001-30</a>	\$2,048.32	\$1,966.39	\$1,884.45	\$1,802.52	11
WR-22	33 - 50	Round Cover UG-383/U	0.5		EAR99	<a href="#">PE-W22AT001-30</a>	\$2,008.15	\$1,937.86	\$1,867.58	\$1,807.34	12

## WAVEGUIDE ACCESSORIES



Waveguide Type	Description	Model No	1 Pc. Price	See Web for Volume Pricing	ROW
WR-10	WR-10 Waveguide Shim, UG-Cover Round flange, 2mm Brass	<a href="#">PEW10FS2</a>	\$117.18	See Web for Volume Pricing	13
	WR-10 Waveguide Short Plate, UG-Cover Round Flange, 4mm Copper	<a href="#">PEW10SP4</a>	\$106.15		14
WR-12	WR-12 Waveguide Shim, UG-Cover Round flange, 2mm Brass	<a href="#">PEW12FS2</a>	\$106.15		15
	WR-12 Waveguide Short Plate, UG-Cover Round Flange, 4mm Copper	<a href="#">PEW12SP4</a>	\$117.18		16
WR-15	WR-15 Waveguide Shim, UG-Cover Round flange, 2mm Brass	<a href="#">PEW15FS2</a>	\$106.15		17
	WR-15 Waveguide Short Plate, UG-Cover Round Flange, 4mm Copper	<a href="#">PEW15SP4</a>	\$106.15		18
WR-19	WR-19 Waveguide Shim, UG-Cover Round flange, 3mm Brass	<a href="#">PEW19FS3</a>	\$106.15		19
	WR-19 Waveguide Short Plate, UG-Cover Round Flange, 4mm Copper	<a href="#">PEW19SP4</a>	\$106.15		20
WR-22	WR-22 Waveguide Shim, UG-Cover Round flange, 3mm Brass	<a href="#">PEW22FS3</a>	\$106.15		21
	WR-22 Waveguide Short Plate, UG-Cover Round Flange, 4mm Copper	<a href="#">PEW22SP4</a>	\$106.15		22
WR-28	WR-28 Waveguide Electrically Conductive Gasket kit Square Cover, Choke Flange	<a href="#">PEWGK1014</a>	\$115.66		23
	WR-28 Waveguide Gasket kit Square Cover, Choke Flange, Non-Conductive	<a href="#">PEWGK1000</a>	\$49.46		24
	WR-28 Waveguide Shim, UG-Cover Square flange, 3mm Brass	<a href="#">PEW28FS3</a>	\$139.58		25
	WR-28 Waveguide Short Plate, UG-Cover Square Flange, 5mm Copper	<a href="#">PEW28SP4</a>	\$139.58		26
WR-34	WR-34 Waveguide Shim, UG-Cover Square flange, 4mm Brass	<a href="#">PEW34FS4</a>	\$139.58		27
	WR-34 Waveguide Short Plate, UG-Cover Square Flange, 4mm Copper	<a href="#">PEW34SP4</a>	\$139.58		28
WR-42	WR-42 Waveguide Shim, UG-Cover Square flange, 4mm Brass	<a href="#">PEW42FS4</a>	\$136.17		29
	WR-42 Waveguide Short Plate, UG-Cover Square Flange, 4mm Copper	<a href="#">PEW42SP4</a>	\$160.18		30
WR-42,	WR-42, WR-34 Waveguide Electrically Conductive Gasket kit Square Cover, Choke Flange	<a href="#">PEWGK1015</a>	\$133.30		31
WR-42	WR-42, WR-34 Waveguide Gasket kit Square Cover, Choke Flange, Non-Conductive	<a href="#">PEWGK1001</a>	\$47.88		32
WR-51	WR-51 Waveguide Electrically Conductive Gasket kit Square Cover, Choke Flange	<a href="#">PEWGK1016</a>	\$144.44		33
	WR-51 Waveguide Gasket kit Square Cover, Choke Flange, Non-Conductive	<a href="#">PEWGK1002</a>	\$48.03		34
WR-62	WR-62 Waveguide Electrically Conductive Gasket kit Square Cover, Choke Flange	<a href="#">PEWGK1017</a>	\$211.09		35
	WR-62 Waveguide Gasket kit Square Cover, Choke Flange, Non-Conductive	<a href="#">PEWGK1003</a>	\$54.67		36
	WR-62 Waveguide Shim, UG-Cover Square flange, 5mm Brass	<a href="#">PEW62FS5</a>	\$70.77		37
	WR-62 Waveguide Short Plate, UG-Cover Square Flange, 5mm Copper	<a href="#">PEW62SP5</a>	\$88.46		38
WR-75	WR-75 Waveguide Electrically Conductive Gasket kit Square Cover, Choke Flange	<a href="#">PEWGK1018</a>	\$133.03		39
	WR-75 Waveguide Gasket kit Square Cover, Choke Flange, Non-Conductive	<a href="#">PEWGK1004</a>	\$54.67		40
	WR-75 Waveguide Shim, UG-Cover Square flange, 5mm Brass	<a href="#">PEW75FS5</a>	\$74.31		41
	WR-75 Waveguide Short Plate, UG-Cover Square Flange, 5mm Copper	<a href="#">PEW75SP5</a>	\$88.46		42

# WAVEGUIDE ACCESSORIES



Waveguide Type	Description	Model No	1 Pc. Price	See Web for Volume Pricing	ROW
WR-90	WR-90 Waveguide Electrically Conductive Gasket kit Square Cover, Choke Flange	<a href="#">PEWGK1019</a>	\$186.51	See Web for Volume Pricing	43
	WR-90 Waveguide Electrically Conductive Gasket kit, CPR Flat Flange	<a href="#">PEWGK1021</a>	\$135.29		44
	WR-90 Waveguide Electrically Conductive Gasket kit, CPR Grooved Flange	<a href="#">PEWGK1020</a>	\$156.20		45
	WR-90 Waveguide Gasket kit Square Cover, Choke Flange, Non-Conductive	<a href="#">PEWGK1005</a>	\$58.27		46
	WR-90 Waveguide Gasket kit, CPR90 Flat Flange, Non-Conductive	<a href="#">PEWGK1007</a>	\$65.68		47
	WR-90 Waveguide Gasket kit, CPR90 Grooved Flange, Non-Conductive	<a href="#">PEWGK1006</a>	\$65.68		48
	WR-90 Waveguide Shim, UG-Cover Square flange, 5mm Brass	<a href="#">PEW90FS5</a>	\$74.31		49
	WR-90 Waveguide Short Plate, UG-Cover Square Flange, 5mm Brass	<a href="#">PEW90SP5</a>	\$103.45		50
WR-112	WR-112 Waveguide Electrically Conductive Gasket kit Square Cover, Choke Flange	<a href="#">PEWGK1022</a>	\$161.96	See Web for Volume Pricing	51
	WR-112 Waveguide Electrically Conductive Gasket kit, CPR Flat Flange	<a href="#">PEWGK1024</a>	\$146.11		52
	WR-112 Waveguide Electrically Conductive Gasket kit, CPR Grooved Flange	<a href="#">PEWGK1023</a>	\$202.89		53
	WR-112 Waveguide Gasket kit Square Cover, Choke Flange, Non-Conductive	<a href="#">PEWGK1008</a>	\$58.27		54
	WR-112 Waveguide Gasket kit, CPR112 Flat Flange, Non-Conductive	<a href="#">PEWGK1010</a>	\$67.65		55
	WR-112 Waveguide Gasket kit, CPR112 Grooved Flange, Non-Conductive	<a href="#">PEWGK1009</a>	\$67.65		56
	WR-112 Waveguide Shim, UG-Cover Square flange, 5mm Brass	<a href="#">PEW112FS5</a>	\$88.46		57
	WR-112 Waveguide Short Plate, UG-Cover Square Flange, 5mm Copper	<a href="#">PEW112SP5</a>	\$88.46		58
WR-137	WR-137 Waveguide Electrically Conductive Gasket kit, CPR Grooved Flange	<a href="#">PEWGK1026</a>	\$190.48	See Web for Volume Pricing	59
	WR-137 Waveguide Electrically Conductive Gasket kit, CPR Grooved Flange	<a href="#">PEWGK1027</a>	\$161.96		60
	WR-137 Waveguide Electrically Conductive Gasket kit, Round Cover, Choke Flange	<a href="#">PEWGK1025</a>	\$316.15		61
	WR-137 Waveguide Gasket kit Round Cover, Choke Flange, Non-Conductive	<a href="#">PEWGK1011</a>	\$59.53		62
	WR-137 Waveguide Gasket kit, CPR137 Flat Flange, Non-Conductive	<a href="#">PEWGK1013</a>	\$62.80		63
	WR-137 Waveguide Gasket kit, CPR137 Grooved Flange, Non-Conductive	<a href="#">PEWGK1012</a>	\$69.76		64
	WR-137 Waveguide Shim, CPR-137F flange, 7mm Brass	<a href="#">PEW137FS7</a>	\$108.94		65
	WR-137 Waveguide Short Plate, CPR-137F Flange, 7mm Copper	<a href="#">PEW137SP7</a>	\$106.15		66
WR-159	WR-159 Waveguide Shim, CPR-159F flange, 7mm Aluminum	<a href="#">PEW159FS7</a>	\$88.46	See Web for Volume Pricing	67
	WR-159 Waveguide Short Plate, CPR-159F Flange, 7mm Aluminum	<a href="#">PEW159SP7</a>	\$88.46		68
WR-187	WR-187 Waveguide Shim, CPR-187F flange, 7mm Aluminum	<a href="#">PEW187FS7</a>	\$88.46	See Web for Volume Pricing	69
	WR-187 Waveguide Short Plate, CPR-187F Flange, 7mm Aluminum	<a href="#">PEW187SP7</a>	\$88.46		70
WR-284	WR-284 Waveguide Shim, CPR-284F flange, 8mm Aluminum	<a href="#">PEW284FS8</a>	\$106.15	See Web for Volume Pricing	71
	WR-284 Waveguide Short Plate, CPR-284F Flange, 8mm Aluminum	<a href="#">PEW284SP8</a>	\$106.15		72
WR-340	WR-340 Waveguide Shim, CPR-340F flange, 10mm Aluminum	<a href="#">PEW340FS10</a>	\$125.62	See Web for Volume Pricing	73
	WR-340 Waveguide Short Plate, CPR-340F Flange, 10mm Aluminum	<a href="#">PEW340SP10</a>	\$181.41		74
WR-430	WR-430 Waveguide Shim, CPR-430F flange, 10mm Aluminum	<a href="#">PEW430FS10</a>	\$125.62	See Web for Volume Pricing	75
	WR-430 Waveguide Short Plate, CPR-430F Flange, 10mm Aluminum	<a href="#">PEW430SP10</a>	\$180.60		76
	0.75 inch Diameter Flange, Standard Antenna Mounting Fixture with UG-385/U and UG-387/U Flanges	<a href="#">PEWAM0000</a>	\$564.38	See Web for Volume Pricing	77
	0.75 inch Square Flange, Standard Antenna Mounting Fixture with UG-599/U Flanges	<a href="#">PEWAM0001</a>	\$564.38		78
	0.88 inch Square Flange, Standard Antenna Mounting Fixture with UG-595/U and UG-1530/U Flanges	<a href="#">PEWAM0002</a>	\$564.38		79
	1.125 inch Diameter Flange, Standard Antenna Mounting Fixture with UG-383/U Flanges	<a href="#">PEWAM0003</a>	\$572.83		80
	4-40 with 3/32 inch Hex, Stainless Steel Waveguide Flange Screw	<a href="#">PEWGHW9000</a>	\$5.13		81
	Waveguide Table Jack, Large	<a href="#">PEWGHW1001</a>	\$374.09		82
	Waveguide Table Jack, Medium	<a href="#">PEWGHW1000</a>	\$323.91		83

See Our Website For Current Pricing & Real-Time Stock Availability!

Waveguides



Technical Support  
+1 (949) 261-1920



Same-Day Shipping,  
Even Custom  
Cable Assemblies



# INDEX GUIDE TO APPENDIX

<b>APPENDIX.....</b>	<b>390</b>
<i>PASTERNAK REACH PROGRAM.....</i>	<i>391</i>
<i>PASTERNAK RoHS PROGRAM.....</i>	<i>391</i>
<i>MAILING LIST CHANGES.....</i>	<i>392</i>
<i>BINDING TERMS.....</i>	<i>392</i>
<i>PE PART # INDEX.....</i>	<i>395</i>
<i>CONVERSION TABLES.....</i>	<i>407</i>
<i>MOUNTING HOLES.....</i>	<i>409</i>
<i>CONNECTOR IDENTIFIER.....</i>	<i>410</i>
<i>CONNECTOR FREQUENCY RANGE CHART.....</i>	<i>414</i>

# PASTERNAK ENTERPRISES – REACH PRODUCT COMPLIANCE PROGRAM

## OUR COMMITMENT

At Infinite Electronics, we maintain a comprehensive REACH compliance program to help customers with their green aspirations. We strive to have accurate and available material content data on all of our products. When data is not yet available, customer requests will be given top priority.

## WHAT IS REACH?

Regulation (EC) No. 1907/2006 of the European Parliament and of the Council of 18 December 2006 is commonly referred to as REACH (Registration, Evaluation, Authorization, and Restriction of Chemicals). The REACH regulation became effective on June 1, 2007 with the objective to improve protection of human health and the environment from exposure to chemicals. Under REACH, there is an obligation to ensure that articles do not contain any of the substances on the REACH Substances of Very High Concern (SVHCs) Candidate list in concentrations greater than 0.1% by weight. SVHCs are substances that may cause cancer or other serious health or environmental effects and thus face potential restriction or outright bans. The SVHC list is updated with additional substances at approximately every six months, thus product declarations must indicate the applicable SVHC release date.

## OUR APPROACH

Infinite Electronics has partnered with Assent Compliance, a world class provider of compliance software and professional support staff, to obtain current material content data on our vast selection of electronic products. Together, we work with our supply chain to routinely collect and analyze this data which enables us to determine the state of compliance for each item we sell. As part of our process integration efforts, we are currently redesigning the way this data can be found on-line so that it is consistent across all brands. Once deployed, we will have a customer self-serve search engine tool to enable real-time creation of part number specific declarations. Until then, customers may request declarations directly from our Assent Compliance partners at [InfiniteElectronicsRequests@assentcompliance.com](mailto:InfiniteElectronicsRequests@assentcompliance.com). Please ensure you that you list all Infinite Electronics part numbers within your request.

# PASTERNAK ENTERPRISES ROHS COMPLIANCE PROGRAM

Lead-free solder is now available for all cable assemblies upon request or online at [www.Pasternack.com](http://www.Pasternack.com).

## OUR COMMITMENT

At Infinite Electronics, we maintain a comprehensive RoHS compliance program to help customers with their green aspirations. We strive to have accurate and available material content data on all of our products. When data is not yet available, customer requests will be given top priority.

## WHAT IS ROHS?

Short for Directive on the restriction of the use of certain hazardous substances in electrical and electronic equipment, RoHS was adopted in February 2003 by the European Union. Now in its third iteration as (EU) Directive 2015/863, RoHS guidelines and legislation are intended to reduce the presence of ten (10) materials deemed hazardous to the environment. To comply, products entering the EU must not have a homogeneous presence of these materials above the following levels by percentage of their weight:

- Lead (Pb) < 0.1%
- Mercury (Hg) < 0.1%
- Cadmium (Cd) < 0.01%
- DEHP < 0.1%
- DBP < 0.1%
- Hexavalent Chromium (CrVI) < 0.1%
- Polybrominated Biphenyls (PBB) < 0.1%
- Polybrominated Diphenyl Esters (PBDE) < 0.1%
- BBP < 0.1%
- DIBP < 0.1%

## OUR APPROACH

Infinite Electronics has partnered with Assent Compliance, a world class provider of compliance software and professional support staff, to obtain current material content data on our vast selection of electronic products. Together, we work with our supply chain to routinely collect and analyze this data which enables us to determine the state of compliance for each item we sell. As part of our process integration efforts, we are currently redesigning the way this data can be found on-line so that it is consistent across all brands. Once deployed, we will have a customer self-serve search engine tool to enable real-time creation of part number specific declarations. Until then, customers may request declarations directly from our Assent Compliance partners at [InfiniteElectronicsRequests@assentcompliance.com](mailto:InfiniteElectronicsRequests@assentcompliance.com). Please ensure you that you list all Infinite Electronics part numbers within your request.



Technical  
Support  
+1 (949) 261-1920



Same-Day Shipping,  
Even Custom  
Cable Assemblies

# MAILING LIST CHANGES

If you receive more than one RF Product Guide with the same name and address, please notify Pasternack and pass the RF Product Guide along to a friend. Also, if you do not require multiple copies to the same company address, contact a sales representative to verify and modify your mailing information. A forms-based communications method to add, delete or modify mailing information is available at [www.pasternack.com](http://www.pasternack.com). By clicking "Contact Us", and then clicking "Remove Name from Mailing List", you may complete the form to request a change to your mailing preferences. In addition, by clicking "RF Product Guide", and then clicking "Request a Printed RF Product Guide", you may add your contact information to our mailing list. Please note service opt-in and opt-out options located on the forms. Alternatively, you may mail, email, telephone or fax Pasternack your request.

## PLACING YOUR ORDER

### ► BY TELEPHONE: 866-PASTERNAK (866-727-8376) US & CANADA, OR 949-261-1920

Our friendly sales representatives are ready to serve you from 5:00am to 5:30pm Pacific Standard Time (PST), Monday through Friday. For the most efficient service, please have ready a list of quantities and part numbers and, if paying by credit card, your MasterCard, VISA, American Express or Discover card. Note: Calls may be recorded or monitored for quality and training purposes.

### ► BY FAX: 949-261-7451

Our fax lines can be accessed 7 days a week, 24 hours a day. Orders received after 4:00pm PST will be promptly processed and shipped the next business day. Please include your daytime phone number and/or email address in case we have any questions about your order.

### ► BY INTERNET: [WWW.PASTERNAK.COM](http://WWW.PASTERNAK.COM) OR EMAIL: [SALES@PASTERNAK.COM](mailto:SALES@PASTERNAK.COM)

Order online 7 days a week, 24 hours a day using our online ordering system. Just search for the items you want and add them to your shopping cart. Internet orders entered after 4:00 pm PST will be promptly processed and shipped the next business day.

### ► BY MAIL: SIMPLY MAIL YOUR ORDER TO: PASTERNAK ENTERPRISES.

17802 FITCH  
PO BOX 16759  
IRVINE, CA 92623-6759 USA

International customers, please see "International Orders" below for additional information.

### TERMS AND CONDITIONS OF SALE:

The following from Pasternack's Binding Terms and Conditions of Sale are provided for your convenience. A complete documentation of the Binding Terms and Conditions of Sale may be found in the back of the RF Product Guide, or on Pasternack's website at <https://www.pasternack.com/t-terms-of-sale.aspx>. Any questions or clarifications may be answered by contacting Customer Service at (+1) 949-261-1920 or by any of the methods listed above.

### NO MINIMUM ORDER REQUIREMENT

### GROUND FREIGHT:

Shipping or freight charges and insurance will be paid by the customer. All sales are made FCA-Shipping Point (as defined by the INCOTERMS 2000) in Irvine, CA USA & Lewisville, TX USA. Shipping or freight charges from Pasternack's Irvine, CA factory are prepaid and added to the invoice or billed collect.

### SAME-DAY SHIPMENT:

Same-day shipment will apply to orders received Monday through Friday, prior to 4:00pm PST.

- All UPS air and surface options
- All FedEx air options (with an approved account number)
- Most other shipping options, including DHL (with an approved account number) and USPS

### COUNTER-TO-COUNTER SHIPPING:

For your urgent order requiring our fastest shipping method, we will place your order on the next available flight from Santa Ana-Orange County John Wayne International Airport (Airport code: SNA) and Dallas/Fort Worth International Airport (Airport Code: DFW) to the destination you specify. Please call for details.

### PAYMENT TERMS:

Pasternack offers a number of convenient payment methods:

**For United States customers**, we offer check, money order, MasterCard, VISA, American Express, and Discover, as well as open account credit to qualified institutions and businesses. Payment must be made in US Dollars.

**For Canadian customers**, we offer all of the above payment options.

**For International customers**, see International Orders.

### OPEN ACCOUNT CREDIT:

Net 30 Days terms are available to businesses, schools and agencies subject to credit approval. Approval can begin by submitting a completed Credit Application, which can be found online at: [www.Pasternack.com/t-CreditApplication.aspx](http://www.Pasternack.com/t-CreditApplication.aspx)

### EFT/WIRE TRANSFERS:

Please contact us for details. We will inform you of the total amount which will include shipping charges and any applicable wire transfer fees. Orders will not be accepted until funds have been received in full.

**WELLS FARGO BANK**  
420 MONTGOMERY ST.  
SAN FRANCISCO, CA 94104 USA  
ACCOUNT NUMBER: 4270 0000 0000 0000 1  
ROUTING NUMBER: 121000248  
SWIFT NUMBER: WFBUS6S

### INTERNATIONAL ORDERS:

In addition to the United States and its territories, Pasternack accepts international orders. All orders of international origin are exported from the US in accordance with the Export Administration Regulations. Diversion contrary to US Law is prohibited. Please see Pasternack's Binding Terms and Conditions of Sale for full details.

Pasternack has international distributors for the following countries:

**Africa:** Namibia, South Africa

**Asia-Pacific:** Australia, China PRC, India, Indonesia, Japan, Malaysia, New Zealand, Singapore, South Korea, Thailand

**Europe:** Austria, Belgium, Czech Republic, Denmark, Finland, France, Germany, Ireland, Italy, Kazakhstan, Luxembourg, Netherlands, Norway, Poland, Portugal, Russia, Slovakia, Spain, Sweden, Switzerland, Turkey, United Kingdom

**Middle East:** Israel

**South America:** Brazil

To access their complete contact information, please see our International Distributors section in this RF Product Guide. (inside back cover)

### INTERNATIONAL SHIPPING CHARGES:

Shipping or freight charges and insurance will be paid by the customer. All sales are made FCA-Shipping Point (as defined by the INCOTERMS 2000) in Irvine, CA USA. We ship orders by UPS, FedEx (with an approved account number), or DHL (with approved account number) with delivery in 2 to 3 days to most locations worldwide.

### INTERNATIONAL TAXES AND DUTIES:

Customer is responsible for duties and taxes.

## BINDING TERMS AND CONDITIONS OF SALE

### 1. SCOPE; CHANGES

The terms and conditions stated herein (this "Agreement") govern all sales of products or services ("products") by Infinite Electronics, Inc. (collectively, "we," "us," "our," or "seller") to you or the entity you represent ("you" or "buyer"). You represent to us that you are lawfully able to enter into contracts (e.g., you are not a minor) and that if you are entering into this Agreement for an entity, such as the company you work for, you represent to us that you have the legal authority to bind that entity. Unless otherwise agreed to in writing by seller's authorized agent, any terms and conditions contained in buyer's purchase order or any other document that are different from or in addition to these terms and conditions are objected to, are rejected, and will not be binding on us. By placing an order for products from us, or by accepting delivery of the products described on the applicable packing slip, bill of lading and/or invoice received with the products, you agree to be bound by and accept these terms and conditions of sale.

We may change the terms and conditions of this Agreement in our sole discretion by posting an updated version of these terms and conditions at this location; provided, however, that the terms and condition of this Agreement in effect as of the date of an applicable order shall continue to govern such order and the products purchased thereunder.

### 2. ORDER ACCEPTANCE

a) Your receipt of an email or other form of order confirmation does not constitute our acceptance of your order or a confirmation of an offer to sell.

b) We reserve the right, without prior notification, to limit the order quantity on any item and/or refuse service to anyone.

c) All orders are subject to review and acceptance by us. You agree to provide complete and accurate contact information in connection with any order submitted to us. Verification of information may be required prior to the acceptance of any order.

d) In the case of pre-stocked finished goods, order acceptance is designated by fulfilling the order. In the case of products requiring post-order processing (including but not limited to design, material purchase, manufacturing or test), order acceptance is designated by performing activities unique to the order.

### 3. ORDER CANCELLATION

a) Orders fully or partially processed by seller may not be cancelled by buyer.

b) Products not previously stocked as finished goods are both Non-Cancelable and Non-Refundable ("NC/NR"). NC/NR products include cable assemblies, special orders, custom orders, orders for non-standard products, products not customarily in stock, scheduled orders requiring special procurements, or orders for products requiring assembly or manufacturing activities prior to shipping (not stored in completed state) as well as purchased services such as special testing or product modifications.

c) In the event of cancellation or other withdrawal of an order for any reason and without limiting any other remedy as a result of such cancellation or other withdrawal, reasonable cancellation or restocking charges, which shall include all expenses then incurred and commitments made by seller, shall be paid by buyer. Buyer's requests to reschedule are subject to acceptance by seller in its sole discretion. Orders may not be rescheduled after the order has been submitted by seller to the shipment carrier.

#### 4. PRICES

a) Orders are billed at the prices (in US dollars) in effect at the time of shipment.

b) Prices will be as specified within seller's website or as stated in seller's quote / proposal. If no period is specified, quoted prices will be applicable for thirty (30) days.

c) For catalog products, the website contains the most current catalog pricing and is the price reference for such orders. Pricing included in the catalog is for reference only and final pricing is determined by the published website price.

d) For non-catalog products and services, prices cited are based on current costs and are subject to reasonable adjustment on or after the date of acceptance of any purchase order to meet a rise or fall in such costs, as computed on the date of delivery.

e) Prices are subject to change without notice.

f) Prices are exclusive of taxes, impositions and other charges, including: sales, use, excise, value added and similar taxes or charges imposed by any government authority, international shipping charges, forwarding agent's and broker's fees, bank fees, consular fees, document fees and import duties.

#### 5. TERMS OF PAYMENT

a) All payments must be in US Dollars, or will be converted to US Dollars using seller's standard exchange rate at the time of purchase.

b) MasterCard, VISA, Discover, and American Express credit cards, purchase cards and major bank debit cards are accepted. Payment via net thirty (30) days is available to businesses, schools and agencies or as otherwise specified by seller subject to credit approval.

c) For International Orders, MasterCard, VISA, and American Express credit cards are accepted. Payment via open credit account with Net thirty (30) days may be established for companies having three U.S. references accepted to seller. Prepaid Wire Transfer: You can wire the funds to our bank. We will contact you with the total amount, which will include shipping charges and a \$40 wire transfer fee. Orders will not be accepted until funds have been received in full and the Purchase Order (PO) has been received. Notwithstanding anything to the contrary in this Agreement, seller may add or remove payment options in seller's sole discretion.

d) Buyer acknowledges that seller has the right to reassess buyer's creditworthiness from time to time. To the extent such is in accordance with law, in the event there is a decline in buyer's creditworthiness, seller may, upon thirty (30) days written notice, revise the payment terms between the parties. Upon request, buyer shall provide financial data evidencing the buyer's worth in order for seller to determine the creditworthiness of buyer. Such information shall include, but not be limited to, annual reports, balance sheets, and bank records.

e) If buyer is delinquent in its payment obligations, without prejudice to any other remedies available to it by law or in equity, seller may demand immediate payment and at seller's option (i) suspend all further deliveries to be made under the purchase order or any further performance under any other contract with buyer or buyer's affiliates, in which event buyer shall not be released in any respect from its obligations to seller under the purchase order; (ii) recover all costs of collection including but not limited to reasonable attorneys' fees; (iii) repossess the product for which payment has not been made; (iv) charge interest at 1.5% per month on the past due amount, not to exceed the interest percentage allowed by law; and (vii) reassess the credit worthiness of buyer and change any current payment terms. Any discount from seller's rates, if any, shall cease to apply to the delinquent invoice, buyer shall be invoiced for such differences in cost, and shall immediately pay the resulting invoice.

#### 6. TAXES AND DUTIES

a) Any taxes related to the products purchased are the responsibility of buyer (excluding taxes based on seller's net income), unless buyer presents an exemption certificate acceptable to seller and the applicable taxing authorities. If any exemption certificate presented by buyer is held to be invalid, then buyer will pay seller the amount of the tax and any penalties and interest related thereto.

b) If possible, seller will bill taxes as a separate item on the invoice presented to buyer.

c) Sales tax will be charged on product cost and shipping & handling where applicable and required by law. Any sales tax due that is not collected by the seller is the responsibility of the buyer.

d) International orders may be subject to various taxes and duties in the country of destination, all of which are the responsibility of the buyer. This includes sales, use, excise, value added and similar taxes or charges imposed by any government authority, international shipping charges, forwarding agent's and broker's fees, bank fees, consular fees, document fees and import duties.

#### 7. SHIPPING COSTS

Shipping or freight charges and insurance will be paid by the buyer and added to the invoice or billed collect unless specifically stated in the quote or order confirmation based on seller practices or promotions.

#### 8. DELIVERY AND TITLE

a) Unless otherwise agreed to in writing, all products are shipped Incoterms 2010 - FCA Shipping Point. Subject to seller's right of stoppage in transit, delivery of the products to the carrier will constitute delivery to buyer and title and risk of loss will pass to buyer.

b) Seller will make reasonable efforts to initiate shipment and schedule delivery as close as possible to buyer's requested delivery date(s). Buyer acknowledges that delivery dates provided by seller are estimates only and that seller will not be liable for failure to deliver on such dates.

c) Selection of the carrier and delivery route will be made by seller unless specifically designated by buyer.

d) Seller reserves the right to make deliveries in installments. Delay in delivery of one installment will not entitle buyer to cancel any other installment(s). Delivery of any installment of products within thirty (30) days after the date requested will constitute a timely delivery. Delivery of a quantity that varies from the quantity specified shall not relieve buyer of the obligation to accept delivery and pay for the products delivered.

e) Deliveries shall be made during normal business hours Monday through Friday. One attempt to deliver will be made. Should delivery need to be rescheduled, any additional costs incurred for redelivery and/or storage fees will be charged to the buyer. Seller shall use reasonable efforts to make timely delivery but shall be excused from any delays arising out of causes beyond its reasonable control. Any specific delivery dates that may be stated are approximate.

f) If completion of delivery is prevented through no fault of seller, seller may specify a reasonable alternative place of delivery. Buyer agrees that all costs of storage and transport incurred following an initial attempt at delivery are hereby allocated to and imposed upon buyer, and shall be added by seller to the sale price. Delivery may at any time be withheld by seller pending payment of any sum due from the buyer to seller. Seller will return Product via the incoming method unless an alternative method has been indicated on the purchase order or a change authorized by the buyer representative.

g) Deliveries made outside the 48 contiguous States may be subject to modified terms and conditions as stated within the order quote.

#### 9. LIMITED WARRANTY

a) Products manufactured and/or branded by seller are warranted for a period of one year from time of delivery against defects in workmanship or materials or failure to operate as described in product data sheets under normal use. In some cases, the warranty period may exceed one year where a written warranty description specific to a certain product is stated in a contract or posted on a company website, product catalog or user's manual. Accessories and consumable goods such as batteries, chargers and accessory cables are warranted for four months.

b) Products manufactured by seller in accordance with buyer's instructions or specifications provided by seller are warranted for a period of one year from time of delivery against defects in workmanship or materials only under normal use. In some cases, the warranty period may exceed one year where a written warranty description specific to a certain product is stated in a contract or posted on a company website, product catalog or user's manual.

c) Calibration services are warranted for a period of one year from time of completion against defects in workmanship or materials or failure to operate as described in product data sheets under normal use.

d) The warranties set forth in this Section 9 shall not apply to any defect, failure, or damage arising from or in connection with: (i) improper use, or improper or inadequate maintenance and care; (ii) modifications to or repairs of the products performed by any party other than seller; (iii) combination of the products with any other technology, equipment, hardware, software, or other materials; (iv) use of the products in an environment not meeting the operating specifications for the products; (v) failure to properly transport, prepare, and store the products; (vi) acts of God; or (vii) any normal wear and tear or normal environmental degradation.

e) Products solely distributed by seller without alteration carry the warranty of the respective manufacturer only.

f) Seller will at seller's option and in seller's sole discretion, repair, replace or refund any products that are returned under warranty, and Seller's repair, replacement, or refunding of the price paid for a product under warranty shall be seller's sole liability, and buyer's sole remedy, for any breach of the warranties in this Section 9.

g) This warranty applies to the original purchaser only and is not transferable.

h) This warranty does not cover damage incurred during shipment which is the responsibility of the freight shipping company.

i) Buyer will bear the costs of access, de-installation, re-installation and transportation of the products to seller and back to buyer in connection with any warranty claims. Seller will reimburse the costs of transportation to seller and bear the costs of returning the repaired product or sending replacement product to buyer if the product is found to be covered under warranty.

j) Any repair or replacement pursuant to this limited warranty for products manufactured and/or branded by seller shall be warranted against the same defects re-occurring in a period of 12 months from time of delivery of the repaired or replaced product, or until the expiration of the original product warranty, which ever shall be the latter.

k) This limited warranty and remedies are expressly conditioned upon: (i) buyer's payment of the purchase price in full, (ii) buyer giving written notice of the defect, reasonably described, to seller within ten (10) days of the time when buyer discovers or ought to have discovered the defect, (iii) the storage, installation, operation, use, and maintenance of the products in compliance with product instructions, (iv) the existence of proper records of buyer's operation and maintenance of the products during the warranty period, (v) buyer providing seller with a reasonable opportunity to examine the products and the aforementioned records, and (vi) the absence of any unauthorized modification or repair of the products, including without limitation the removal or alternation of any serial numbers or product identifications.

l) THIS WARRANTY IS IN LIEU OF ANY AND ALL OTHER WARRANTIES, WHETHER ORAL, WRITTEN, EXPRESSED, IMPLIED OR STATUTORY. ANY IMPLIED WARRANTIES OF MERCHANTABILITY, FITNESS FOR A PARTICULAR PURPOSE AND NON-INFRINGEMENT ARE HEREBY DISCLAIMED.

#### 10. RETURNS

a) Buyers wishing to return products must first obtain a Return Material Authorization (RMA) number from a Customer Service representative. Unauthorized returns will not be accepted at point of receipt. The RMA number must be printed on the outside of the package in order for it to be received and processed. Merchandise must be shipped prepaid.

b) Seller will determine in seller's sole discretion the appropriate remedies for returned items based on the product's limited warranty and circumstances of the return including a possible refund of purchase price, credit for future purchase, replacement, repair, return to buyer as-is, scrap with consent, and refund of shipping expenses.

c) Items stocked as finished goods and ordered in error must have a Return Material Authorization (RMA) number issued within 30 days of the original order. These parts are eligible for full credit only if the returned products and packaging are in mint and salable condition. A repackaging/restocking charge not to exceed 25% of the sale price may be charged on any products not returned unopened. Under no circumstances will credit be issued after 30 days from date of invoice or for orders exceeding \$500.00 in total value. All freight charges are the responsibility of buyer.

d) Products not previously stocked as finished goods are not returnable unless found to be defective. These include cable assemblies, special orders, custom orders, orders for non-standard products, products requiring assembly or manufacturing activities prior to shipping (not stored in completed state).

e) Defective items must have a Return Material Authorization (RMA) number marked on the package prior to shipping.

f) After 30 days from invoice all merchandise returns for distributed products not manufactured by seller must be handled directly with that manufacturer in accordance with their warranty.

#### 11. ORDER DISCREPANCIES

Claims for shortages, incorrect materials or invoicing errors must be made by buyer in writing within ten (10) business days after receipt of shipment. Claims for nonreceipt of shipment must be made in writing within ten (10) business days after receipt of invoice. No products shall be returned without seller's express instructions. Buyer must provide in writing the order number and describe all defects associated with the order.

#### 12. LIMITATION OF LIABILITIES; INDEMNITY

a) IN NO EVENT WILL SELLER BE LIABLE TO BUYER OR TO ANY THIRD PARTY FOR ANY DELAY, FAILURE TO GIVE NOTICE OF DELAY, LOSS OF USE, SECURITY OR DATA BREACH, LOSS OF REVENUE OR PROFIT OR LOSS OF DATA, RECALL COSTS, SERVICE INTERRUPTIONS, DOWNTIME, TESTING, INSTALLATION, REPLACEMENT, OR REMOVAL COSTS, OR FOR ANY CONSEQUENTIAL, INCIDENTAL, INDIRECT, EXEMPLARY, SPECIAL OR PUNITIVE DAMAGES, WHETHER ARISING OUT OF BREACH OF CONTRACT, TORT (INCLUDING NEGLIGENCE), OR OTHERWISE, REGARDLESS OF WHETHER SUCH DAMAGE WAS FORESEEABLE AND WHETHER OR NOT SELLER HAS BEEN ADVISED OF





THE POSSIBILITY OF SUCH DAMAGES. SELLER'S AGGREGATE LIABILITY FOR ANY CLAIMS ARISING OUT OF OR IN CONNECTION WITH THIS AGREEMENT SHALL NOT EXCEED THE PURCHASE PRICE PAID BY BUYER FOR THE PRODUCTS WHICH ARE THE SUBJECT OF THE CLAIM. THE DISCLAIMERS AND LIMITATIONS IN THIS SECTION 12 WILL APPLY NOTWITHSTANDING ANY FAILURE OF ESSENTIAL PURPOSE OF ANY LIMITED REMEDY AND TO THE MAXIMUM EXTENT PERMITTED UNDER APPLICABLE LAW.

b) Buyer shall defend seller from and against any claims, actions, proceedings, or suits brought by any third party (i) alleging infringement of intellectual property rights arising out of or in connection with seller's compliance with buyer's drawings, specifications, requirements or instructions or (ii) arising out of or in connection with the products supplied by seller and incorporated into the buyer's products (each a "Claim") and shall indemnify and hold harmless seller from any costs, liabilities, damages, fines, judgments, or expenses (including reasonable attorneys' fees) arising out of or in connection with any Claim.

### 13. EXPORT COMPLIANCE

a) Items are controlled by the U.S. Government and authorized for export only to the country of ultimate destination for use by the ultimate consignee or end-user(s) identified in the invoice. They may not be resold, transferred, or otherwise disposed of, to any other country or to any person other than the authorized ultimate consignee or end-user(s), either in their original form or after being incorporated into other items, without first obtaining approval from the U.S. Government or as otherwise authorized by U.S. law and regulations. Buyer agrees to comply with all applicable export control laws, restrictions and regulations of the United States and those of the buyer's country, and shall not export, or transfer for the purpose of re-export, any product to any embargoed country or region, including but not limited to Cuba, the Crimean Region of Ukraine, Iran, North Korea, Sudan, and Syria, or to any denied, blocked, or designated person or entity as mentioned in any such United States or EU law or regulation. Buyer represents and warrants that it is not on the Denied Persons, Specially Designated Nationals or Debarred Persons List, as identified by the U.S. Treasury Office of Foreign Asset Control (OFAC) and by the U.S. Department of Commerce, Bureau of Industry and Security (BIS), or any other United States list of prohibited persons; is not owned or controlled by any person that is on one of those lists, or is otherwise prohibited by United States or other law from purchasing the products or services hereunder, and shall notify the seller immediately if buyer's status related to the above changes. Buyer shall be solely responsible to obtain any license to export, re-export or import as may be required. Buyer also agrees that it will not use these products in connection with the proliferation of weapons of mass destruction, including missiles, nuclear, chemical or biological weapons.

b) Seller shall not be liable for delays or refusals by governmental authorities or other authorities to grant licenses or approvals, nor for suspension or revocation thereof, nor for changes in export classification. Buyer must deliver requested information, including requested end-user information, necessary for export licenses to be granted, and necessary for seller to determine if a license or other type of authorization is required.

c) For all custom orders, buyer shall provide seller with export classification information for all buyer property and information (including buyer drawings) delivered to seller in relation to this order. Export classification information includes the applicable export control classification, the country of origin and, for hardware only, the Harmonized Tariff Code. For such custom orders, seller will supply buyer with similar export classification information for products and/or information for which seller has design authority. Buyer and seller will promptly notify the other upon a change in classification information if any occurs prior to delivery.

### 14. GOVERNING LAW; VENUE

a) All matters arising out of or relating to this agreement, or a breach thereof, are governed by and construed in accordance with the internal laws of the State of California without giving effect to any choice or conflict of law provision or rule (whether of the State of California or any other jurisdiction) that would cause the application of the laws of any jurisdiction other than those of the State of California.

b) Any legal suit, action or proceeding arising out of or relating to this agreement, or a breach thereof, will be instituted in the federal or State courts located in the city of Irvine, California or its closest California venue. Each party irrevocably submits to the exclusive jurisdiction of the courts in any legal suit, action or proceeding.

### 15. LEGAL NOTICES

Any legal notice sent to seller from buyer, required or permitted hereunder, will be deemed to have been effectively delivered if in writing and served by personal delivery or sent by registered or certified mail with return receipt requested, postage prepaid, to seller at the primary address specified as seller's place of business.

### 16. INTELLECTUAL PROPERTY

a) Notwithstanding delivery of and the passing of title in any product, nothing in these terms and conditions shall have the effect of granting or transferring to, or vesting in, buyer any intellectual property rights in or to any products.

b) The drawings, text, product depictions, logos, content, product descriptions, and organization and taxonomy of seller's website, catalogue, product guides or other documents and media owned by the seller and of the described content there within are proprietary to the seller and protected by intellectual property laws, including but not limited to United States Copyright law and United States Trademark law. Whether seller owns copyrights in these works or not, their content and the selection, arrangement, coordination and structure of the arranged content there within are the sole property of the seller. Use of the above stated materials does not give anyone the right to modify, reproduce, transmit, publish, publicly display, adapt, or create derivative works or in any way exploit any of the materials without express written permission of the seller.

c) All trademarks referenced in seller's catalog or website or depicted within any seller's documents or digital media, whether registered in United States or other countries, may not be used without permission of the respective trademark owner. This applies to seller owned trademarks as well as those of seller's suppliers.

d) SELLER MAKES NO REPRESENTATION OR WARRANTY THAT THE PRODUCTS (OR BUYER'S USE OR EXPLOITATION THEREOF) WILL NOT INFRINGE ANY INTELLECTUAL PROPERTY RIGHTS.

### 17. SOFTWARE

a) To the extent that the product or services contain or are software, seller hereby grants to buyer a non-exclusive, non-transferable, personal license to use the software and related documentation. Buyer's use conclusively evidences its acceptance of this license. Title to the software shall at all times remain with seller. Buyer agrees that the software, all enhancements, related documentation, and derivative works are, and will remain the sole property of seller and includes valuable trade secrets. Buyer agrees to treat the software and related documentation as confidential and to not copy, reproduce, sub-license, or otherwise disclose the software and related documentation to third parties. Buyer agrees to not disassemble, decompile, reverse engineer, create derivative works from or otherwise translate, customize, localize, modify, add to, or in any way alter, rent, or loan the software or related documentation unless the operation is specifically authorized by law.

b) Third party product software Licenses are separate end user license agreements ("EULA") and not issued pursuant to the above stated personal license.

### WARNING:

Products in this catalog can expose you to chemicals including phthalates, which are known to the State of California to cause cancer and birth defects or other reproductive harm. For more information, go to [www.P65Warnings.ca.gov](http://www.P65Warnings.ca.gov). For specific products impacted, please visit [www.pasternack.com](http://www.pasternack.com).

c) Buyer agrees to defend, indemnify and hold harmless seller from all damages and third party claims arising from unauthorized use or transfer of the software or firmware.

d) If the software is licensed for use in the performance of a U.S. Government prime contract or subcontract, buyer agrees that consistent with FAR 12.211 and 12.212, commercial computer software, computer software documentation and technical data for commercial items are licensed under seller's standard commercial license.

### 18. CONFIDENTIAL INFORMATION

Buyer agrees that all confidential information furnished by or obtained from seller in connection with the sale of items hereunder (including product data and manufacturing process data) shall be adequately safeguarded to prevent unauthorized disclosure. Buyer agrees not to (i) disclose any such information to any other person or entity, or (ii) use such information for any purpose, other than performing authorized activities directly related to the governing contract.

### 19. TOLERANCES

Unless otherwise agreed to in writing by seller, standard tolerances as described on seller's drawings, websites and/or posted catalog datasheets shall apply.

### 20. PRODUCT LINE CHANGES

Product specifications and availability are subject to change without notice. Seller reserves the right to change specifications or discontinue items at seller's sole discretion for any reason whatsoever including, but not limited to changing market conditions, product discontinuation, component unavailability, manufacturing cost changes and errors in advertisements.

### 21. FCC PART 15 AND PART 97 NOTICE

For systems operating within the jurisdiction of the United States Federal Communications Commission (FCC), buyer acknowledges that any amplification device it purchases is intended for use only in a transmission system certified under Part 15, Part 97 or other applicable section of the rules and regulations of the FCC, or that a legal exception to this requirement applies.

### 22. ASSIGNMENT

Buyer shall not assign this Agreement or any order hereunder without the prior written consent of the seller. Any assignment in violation of the foregoing will be void and of no force or effect. Seller may assign this Agreement or any order hereunder in seller's sole discretion and without restriction. This Agreement will be binding upon and inure to the benefit of the parties, their successors, and permitted assigns.

### 23. RELATIONSHIP

Nothing in this Agreement or any product or service orders shall be construed to place the buyer or seller in the relationship of partners or joint ventures, and the buyer and seller shall have no power to obligate or bind the other in any manner whatsoever.

### 24. WAIVER

No waiver by seller of any breach of this Agreement by the buyer shall be considered as a waiver of the subsequent breach of the same or any other provision.

### 25. SEVERABILITY

If any provision or portion of this Agreement shall be adjudged invalid or unenforceable by a court of competent jurisdiction or by operation of any applicable law, that provision or portion of this Agreement shall be deemed omitted and the remaining provisions and portions shall remain in full force and effect.

### 26. LIENS AND TITLE

a) Buyer hereby grants to seller a security interest in any property owned by the buyer (including buyer's beneficial rights to property leased by seller) in the possession of seller or any of seller's affiliates, at any time, to secure all amounts owed by buyer to seller under this Agreement.

b) In the case of repairs or overhauls performed pursuant to this Agreement, buyer grants seller a perfected security interest in all products retained in possession of seller upon which any repair or overhaul services have been performed by seller. Buyer further acknowledges and agrees that, in addition to the security interest and lien expressly granted by buyer to seller, seller shall have a lien on the product retained in possession of seller to the extent otherwise provided by law. Buyer acknowledges that the lien (whether granted by buyer or through the operation of law) for repairs or overhaul shall be for the full value of such work, and shall be superior to any lien or interest in favor of buyer, its parents, affiliates, or subsidiaries, or any other person who has knowledge of this Agreement. To the extent that seller maintains possession of product under repair, buyer agrees that seller is a secured creditor of buyer and has all the rights of a secured creditor.

c) With respect to products sold pursuant to this Agreement, buyer agrees and acknowledges that seller shall retain a security interest in such product, unless and until all payment for such products has been made and all other covenants and agreements of this Agreement have been performed in full. Accordingly, buyer agrees that it will not suffer or permit any lien or encumbrance to be established that effects the title to the product sold by seller pursuant hereto until seller has been paid in full. Buyer agrees that, in the event of buyer's insolvency, or in the event that any petition is filed by or against buyer under Chapter 7 or Chapter 11 of the Bankruptcy Code, seller may, at its discretion, recover all products sold pursuant to this Agreement and/or seek damages or costs under applicable laws.

### 27. STORAGE FEES

A storage fee will be applied monthly up to the maximum allowed by law on all repaired and overhauled units if delivery is not taken within five (5) days of notification.

### 28. FORCE MAJEURE

Notwithstanding anything else in this Agreement, no default, delay, or failure to perform on the part of seller will be considered a breach of this Agreement if such default, delay, or failure to perform is shown to be due to causes beyond reasonable control of seller, including, but not limited to, causes such as strikes, lockouts or other labor disputes, riots, civil disturbances, actions or inactions of governmental authorities or suppliers, epidemics, war, embargoes, severe weather, fire, earthquakes, acts of God or the public enemy, nuclear disasters, or default of a common carrier.

### 29. ENTIRE AGREEMENT; CONSTRUCTION; SURVIVAL

This Agreement sets forth the entire agreement and understanding of the Parties relating to the subject matter herein and supersedes all prior and contemporaneous communications, representations, discussions, and agreements between the Parties with respect to such subject matter. The titles and section headings used in this Agreement are for ease of reference only and shall not be used in the interpretation or construction of this Agreement. No rule of construction resolving any ambiguity in favor of the non-drafting party shall be applied hereto. The word "including", when used herein, is illustrative rather than exclusive and means "including, without limitation." In the event of any termination or expiration of this Agreement, buyer's obligations to pay amounts due hereunder and arising prior to the date of termination or expiration, as well as Sections 9, 12-18, and 21-29 shall survive such termination or expiration.

# PART NUMBER INDEX

Note: C/R stands for the Column and/or Row location of the specific product on a given page.

Model No.	Page	C/R	Model No.	Page	C/R	Model No.	Page	C/R	Model No.	Page	C/R	Model No.	Page	C/R	Model No.	Page	C/R	Model No.	Page	C/R
CST-400	Web		PE-SR405AL	229	8	PE-W1517Y1001	387	80	PE-W62S001-12	384	42	PE15A1051	54	59	PE15A4022	51	52	PE15A5055	55	24
DBTU	Web		PE-SR405AL	229	9	PE-W1517Y1002	387	78	PE-W62S001-3	384	38	PE15A1052	54	56	PE15A4023	51	52	PE15A5056	55	24
EZ-200-NMH-D	Web		STRAIGHT	229	9	PE-W1517Y1003	387	79	PE-W62S001-6	384	40	PE15A1053	54	57	PE15A4024	51	52	PE15A5057	55	24
EZ-200-NMH-X	Web	82	PE-SR405FL	229	10	PE-W187TR1001	386	42	PE-W62S001-9	384	41	PE15A1054	54	57	PE15A4025	56	43	PE15A5058	55	24
EZ-200-TRP	Web	48	PE-SR405FLJ	229	11	PE-W187TR1002	386	41	PE-W62S002-12	384	37	PE15A1055	54	43	PE15A4026	56	42	PE15A5059	55	24
EZ-200-TM	Web	28	PE-SR405TN	229	12	PE-W1919T1001-30	388	33	PE-W62S002-6	384	35	PE15A1056	54	61	PE15A4027	51	35	PE15A5060	55	24
EZ-200-TM-RP	Web	28	PE-SR405T	229	13	PE-W1919T1001	387	33	PE-W62S002-18	384	35	PE15A1057	54	61	PE15A4028	51	35	PE15A5061	55	24
EZ-240-310M-X	Web	286	STRAIGHT	229	13	PE-W19B001	369	39	PE-W62S005-12	380	72	PE15A1058	54	64	PE15A4029	51	9	PE15A5062	55	24
EZ-240-NMH-D	Web	286	PE-T1000	241	76	PE-W19B002	369	40	PE-W62S005-24	380	73	PE15A1059	54	63	PE15A4030	51	36	PE15A5063	55	24
EZ-240-NMH-X	Web	286	PE-T1003	241	84	PE-W19CA001	365	26	PE-W62S005-36	380	74	PE15A1060	54	63	PE15A4031	51	36	PE15A5064	55	24
EZ-240-NMH-X	Web	286	PE-T1009	241	75	PE-W19CA002	365	27	PE-W62T005-12	381	12	PE15A1061	54	60	PE15A4032	51	7	PE15A5065	55	24
EZ-240-NMH-X	Web	286	PE-T1010	241	85	PE-W19CA003	365	27	PE-W62T005-24	381	12	PE15A1062	54	60	PE15A4033	51	7	PE15A5066	55	24
EZ-240-SM-R-X	Web	270	PE-T1011	241	86	PE-W19CP001-10	371	20	PE-W62T005-36	381	13	PE15A1063	54	59	PE15A4034	51	16	PE15A5067	55	24
EZ-240-SM-R-X	Web	270	PE-T2000	342	5	PE-W19CP003-20	371	17	PE-W62T005-48	381	13	PE15A1064	54	59	PE15A4035	51	18	PE15A5068	55	24
EZ-240-SM-R-X	Web	270	PE-T2001	342	1	PE-W19CP003-20	371	18	PE-W78001	370	54	PE15A1065	54	72	PE15A4040	51	25	PE15A5069	55	24
EZ-240-SM-X	Web	267	PE-T2003	342	92	PE-W19PS1001	382	68	PE-W78002	370	55	PE15A1066	54	72	PE15A4041	51	25	PE15A5070	55	24
EZ-240-TF	Web	267	PE-T2004	342	8	PE-W19S001-12	384	13	PE-W78004	370	55	PE15A1067	54	72	PE15A4042	51	25	PE15A5071	55	24
EZ-240-TM	Web	228	PE-T2006	342	89	PE-W19S001-3	384	9	PE-W78004A	370	59	PE15A1068	54	72	PE15A4043	51	25	PE15A5072	55	24
EZ-400-716M-R-X	Web	244	PE-T2010	342	97	PE-W19S001-6	384	10	PE-W78004A	370	59	PE15A1069	54	72	PE15A4044	51	25	PE15A5073	55	24
EZ-400-FM-75	Web	243	PE-T2011	342	14	PE-W19S001-9	384	12	PE-W78004A	370	59	PE15A1070	54	72	PE15A4045	51	25	PE15A5074	55	24
EZ-400-FM-75	Web	243	PE-T2012	342	13	PE-W19S001-12	384	13	PE-W78004A	370	59	PE15A1071	54	72	PE15A4046	51	25	PE15A5075	55	24
EZ-400-FM-75	Web	243	PE-T2013	342	19	PE-W19S001-18	384	14	PE-W78004A	370	59	PE15A1072	54	72	PE15A4047	51	25	PE15A5076	55	24
EZ-400-NH-BH	Web	244	PE-T2014	342	11	PE-W19S001-30	384	15	PE-W78004A	370	59	PE15A1073	54	72	PE15A4048	51	25	PE15A5077	55	24
EZ-400-NH-X	Web	244	PE-T2015	342	97	PE-W19S001-6	384	16	PE-W78004A	370	59	PE15A1074	54	72	PE15A4049	51	25	PE15A5078	55	24
EZ-400-NH-X	Web	244	PE-T2016A	342	17	PE-W19S001-9	384	17	PE-W78004A	370	59	PE15A1075	54	72	PE15A4050	51	25	PE15A5079	55	24
EZ-400-NH-X	Web	244	PE-T2017	342	16	PE-W19S001-12	384	18	PE-W78004A	370	59	PE15A1076	54	72	PE15A4051	51	25	PE15A5080	55	24
EZ-400-NH-X	Web	244	PE-T2018	342	99	PE-W19S001-18	384	19	PE-W78004A	370	59	PE15A1077	54	72	PE15A4052	51	25	PE15A5081	55	24
EZ-400-NH-X	Web	244	PE-T2019	342	100	PE-W19S001-30	384	20	PE-W78004A	370	59	PE15A1078	54	72	PE15A4053	51	25	PE15A5082	55	24
EZ-400-NH-X	Web	244	PE-T2020	342	15	PE-W22A001-30	377	34	PE-W90000A	370	59	PE15A1079	54	72	PE15A4054	51	25	PE15A5083	55	24
EZ-400-NH-X	Web	244	PE-T2021	342	16	PE-W22A002	377	35	PE-W90000A	370	59	PE15A1080	54	72	PE15A4055	51	25	PE15A5084	55	24
EZ-400-NH-X	Web	244	PE-T2022	342	17	PE-W22A003	377	36	PE-W90000A	370	59	PE15A1081	54	72	PE15A4056	51	25	PE15A5085	55	24
EZ-400-NH-X	Web	244	PE-T2023	342	18	PE-W22A004	377	37	PE-W90000A	370	59	PE15A1082	54	72	PE15A4057	51	25	PE15A5086	55	24
EZ-400-NH-X	Web	244	PE-T2024	342	19	PE-W22A005	377	38	PE-W90000A	370	59	PE15A1083	54	72	PE15A4058	51	25	PE15A5087	55	24
EZ-400-NH-X	Web	244	PE-T2025	342	20	PE-W22A006	377	39	PE-W90000A	370	59	PE15A1084	54	72	PE15A4059	51	25	PE15A5088	55	24
EZ-400-NH-X	Web	244	PE-T2026	342	21	PE-W22A007	377	40	PE-W90000A	370	59	PE15A1085	54	72	PE15A4060	51	25	PE15A5089	55	24
EZ-400-NH-X	Web	244	PE-T2027	342	22	PE-W22A008	377	41	PE-W90000A	370	59	PE15A1086	54	72	PE15A4061	51	25	PE15A5090	55	24
EZ-400-NH-X	Web	244	PE-T2028	342	23	PE-W22A009	377	42	PE-W90000A	370	59	PE15A1087	54	72	PE15A4062	51	25	PE15A5091	55	24
EZ-400-NH-X	Web	244	PE-T2029	342	24	PE-W22A010	377	43	PE-W90000A	370	59	PE15A1088	54	72	PE15A4063	51	25	PE15A5092	55	24
EZ-400-NH-X	Web	244	PE-T2030	342	25	PE-W22A011	377	44	PE-W90000A	370	59	PE15A1089	54	72	PE15A4064	51	25	PE15A5093	55	24
EZ-400-NH-X	Web	244	PE-T2031	342	26	PE-W22A012	377	45	PE-W90000A	370	59	PE15A1090	54	72	PE15A4065	51	25	PE15A5094	55	24
EZ-400-NH-X	Web	244	PE-T2032	342	27	PE-W22A013	377	46	PE-W90000A	370	59	PE15A1091	54	72	PE15A4066	51	25	PE15A5095	55	24
EZ-400-NH-X	Web	244	PE-T2033	342	28	PE-W22A014	377	47	PE-W90000A	370	59	PE15A1092	54	72	PE15A4067	51	25	PE15A5096	55	24
EZ-400-NH-X	Web	244	PE-T2034	342	29	PE-W22A015	377	48	PE-W90000A	370	59	PE15A1093	54	72	PE15A4068	51	25	PE15A5097	55	24
EZ-400-NH-X	Web	244	PE-T2035	342	30	PE-W22A016	377	49	PE-W90000A	370	59	PE15A1094	54	72	PE15A4069	51	25	PE15A5098	55	24
EZ-400-NH-X	Web	244	PE-T2036	342	31	PE-W22A017	377	50	PE-W90000A	370	59	PE15A1095	54	72	PE15A4070	51	25	PE15A5099	55	24
EZ-400-NH-X	Web	244	PE-T2037	342	32	PE-W22A018	377	51	PE-W90000A	370	59	PE15A1096	54	72	PE15A4071	51	25	PE15A5100	55	24
EZ-400-NH-X	Web	244	PE-T2038	342	33	PE-W22A019	377	52	PE-W90000A	370	59	PE15A1097	54	72	PE15A4072	51	25	PE15A5101	55	24
EZ-400-NH-X	Web	244	PE-T2039	342	34	PE-W22A020	377	53	PE-W90000A	370	59	PE15A1098	54	72	PE15A4073	51	25	PE15A5102	55	24
EZ-400-NH-X	Web	244	PE-T2040	342	35	PE-W22A021	377	54	PE-W90000A	370	59	PE15A1099	54	72	PE15A4074	51	25	PE15A5103	55	24
EZ-400-NH-X	Web	244	PE-T2041	342	36	PE-W22A022	377	55	PE-W90000A	370	59	PE15A1100	54	72	PE15A4075	51	25	PE15A5104	55	24
EZ-400-NH-X	Web	244	PE-T2042	342	37	PE-W22A023	377	56	PE-W90000A	370	59	PE15A1101	54	72	PE15A4076	51	25	PE15A5105	55	24
EZ-400-NH-X	Web	244	PE-T2043	342	38	PE-W22A024	377	57	PE-W90000A	370	59	PE15A1102	54	72	PE15A4077	51	25	PE15A5106	55	24
EZ-400-NH-X	Web	244	PE-T2044	342	39	PE-W22A025	377	58	PE-W90000A	370	59	PE15A1103	54	72	PE15A4078	51	25	PE15A5107	55	24
EZ-400-NH-X	Web	244	PE-T2045	342	40	PE-W22A026	377	59	PE-W90000A	370	59	PE15A1104	54	72	PE15A4079	51	25	PE15A5108	55	24
EZ-400-NH-X	Web	244	PE-T2046	342	41	PE-W22A027	377	60	PE-W90000A	370	59	PE15A1105	54	72	PE15A4080	51	25	PE15A5109	55	24
EZ-4																				

# PART NUMBER INDEX

Note: C/R stands for the Column and/or Row location of the specific product on a given page.

Model No.	Page	C/R	Model No.	Page	C/R	Model No.	Page	C/R	Model No.	Page	C/R	Model No.	Page	C/R	Model No.	Page	C/R	Model No.	Page	C/R			
PE1V11011	338	59	PE2024	Web	PE2240-30	303	25	PE22C013	306	48	PE22C1141	306	58	PE3076	184	82	PE3288	145	82	PE3477	145	71	
PE1V11012	338	60	PE2026	320	4	PE2242-10	303	46	PE22C017	306	51	PE22C1142	307	60	PE3078	171	95	PE3290	130	41	PE3478	Web	71
PE1V11013	338	61	PE2027	321	10	PE2242-20	303	46	PE22C019	306	55	PE22C1143	306	57	PE3080	149	70	PE3291	163	54	PE3479	161	65
PE1V11014	338	62	PE2028	319	51	PE2242-30	303	48	PE22C021	306	47	PE22C1144	306	49	PE3081	121	70	PE3293	130	42	PE3480	221	93
PE1V11015	338	63	PE2029	321	28	PE2243-10	303	49	PE22C023	306	54	PE22C1145	306	50	PE3082	121	78	PE3295	130	40	PE3481	167	61
PE1V11016	338	64	PE2030	Web	PE2243-16	303	49	PE22C024-10	304	52	PE22C1146	306	42	PE3083	129	81	PE3297	130	43	PE3483	163	33	
PE1V11017	338	65	PE2031	321	27	PE2243-20	303	49	PE22C025	306	53	PE22C1147	306	43	PE3084	129	81	PE3299	130	43	PE3485	141	56
PE1V11018	338	66	PE2032	319	41	PE2243-30	303	49	PE22C027	306	17	PE22C1148	306	43	PE3087	120	52	PE3301	131	55	PE3487	138	63
PE1V11019	338	67	PE2033	320	97	PE2200V000	319	49	PE22C0102	305	1	PE22C1149	306	41	PE3088	124	69	PE3302	164	60	PE3488	142	99
PE1V11020	338	68	PE2034	320	2	PE2200V001	319	60	PE22C0103	305	2	PE22C1150	306	39	PE3089	177	79	PE3304	131	53	PE3490	198	43
PE1V11021	338	69	PE2035	321	6	PE2200V002	320	71	PE22C0104	305	18	PE22C1151	307	94	PE3093	172	21	PE3306	131	56	PE3492	168	13
PE1V11022	338	70	PE2036	319	53	PE2200V003	320	76	PE22C0105	305	15	PE22C1152	307	96	PE3094	126	73	PE3307	220	62	PE3494	172	36
PE1V11023	338	71	PE2037	320	74	PE2200V004	320	76	PE22C0106	305	15	PE22C1153	307	96	PE3095	129	13	PE3309	130	42	PE3496	166	46
PE1V11024	338	72	PE2038	320	63	PE2200V005	319	50	PE22C0107	305	4	PE22C1154	307	97	PE3097	145	64	PE3311	130	47	PE3498	138	56
PE1V11025	338	73	PE2039	320	67	PE2200V006	320	72	PE22C0108	305	5	PE22C1155	307	98	PE3098	131	63	PE3312	Web	30	PE3497	205	93
PE1V11026	338	74	PE2040	320	69	PE2200V007	319	44	PE22C0109	305	19	PE22C1157	307	99	PE3100	221	74	PE3314	130	45	PE3498	205	2
PE1V11027	338	75	PE2041	320	30	PE2200V008	319	45	PE22C0110	305	7	PE22C1158	307	1	PE3102	171	9	PE3316	130	48	PE3499	169	67
PE1V12000	339	89	PE2042	Web	PE2200V009	319	43	PE22C0111	305	7	PE22C1159	307	2	PE3103	122	19	PE3318	164	63	PE3500	137	63	
PE1V12001	339	90	PE2044	Web	PE2200V010	319	43	PE22C0112	305	10	PE22C1160	307	3	PE3111	158	98	PE3319	169	40	Web	30	31	
PE1V12002	339	91	PE2045	Web	PE2200V011	320	75	PE22C0113	305	11	PE22C1161	307	93	PE3107	Web	30	PE3320	142	3	PE3504	207	69	
PE1V12003	339	92	PE2046	Web	PE2200V012	320	66	PE22C0114	305	23	PE2PB1000	349	31	PE3108	132	90	PE3321	163	55	PE3505	125	75	
PE1V12004	339	93	PE2047	319	39	PE2200V013	319	47	PE22C0115	305	12	PE2PB1001	349	33	PE3109	190	24	PE3323	163	52	PE3508	121	88
PE1V12005	339	94	PE2048	321	40	PE2200V014	319	46	PE22C0116	305	13	PE2PB1002	349	27	PE3112	221	75	PE3325	163	52	PE3509	Web	30
PE1V12006	339	95	PE2049	321	42	PE2200V015	320	68	PE22C0117	305	16	PE2PB1003	349	29	PE3116	162	86	PE3326	Web	30	PE3510	169	44
PE1V12007	339	96	PE2050	321	46	PE2200V016	320	74	PE22C0118	305	17	PE2PB1004	349	30	PE3117	159	8	PE3327	163	51	PE3511	169	40
PE1V12008	339	97	PE2051	Web	PE2200V017	319	59	PE22C0119	305	14	PE2PB1005	349	32	PE3120	125	92	PE3328	Web	30	PE3512	168	41	
PE1V12009	339	98	PE2052	306	52	PE2200V018	320	70	PE22C0120	305	8	PE2PB1006	349	26	PE3121	167	78	PE3329	Web	30	PE3513	169	48
PE1V12010	339	99	PE2053	Web	PE2200V019	319	42	PE22C0121	305	6	PE2PB1007	349	28	PE3122	202	46	PE3333	171	8	PE3514	183	37	
PE1V13002	339	1	PE2054	Web	PE2200V020	320	64	PE22C0122	307	61	PE2V000	337	9	PE3125	Web	30	PE3334	158	1	PE3515	183	43	
PE1V13003	339	2	PE2055	307	59	PE2200V026	341	77	PE22C0123	303	31	PE2V001	337	11	PE3126	Web	30	PE3335	Web	30	PE3516	131	64
PE1V13004	339	3	PE2056	Web	PE2200V027	341	78	PE22C0124-10	303	31	PE2V002	337	13	PE3128	Web	30	PE3338	159	23	PE3517	132	76	
PE1V13005	339	4	PE2056A	307	62	PE2200V028	341	79	PE22C0124-20	303	31	PE2V003	337	13	PE3129	98	8	PE3339	157	18	PE3518	163	58
PE1V13006	339	5	PE2057	307	63	PE2200V029	341	80	PE22C0123-30	303	31	PE2V004	337	17	PE3133	219	50	PE3341	129	50	PE3519	163	58
PE1V13007	339	6	PE2058	306	53	PE2200V030	341	81	PE22C0124-6	304	53	PE2V005	337	19	PE3134	203	49	PE3343	126	90	PE3520	192	87
PE1V13008	339	7	PE2059	306	56	PE2200V031	341	82	PE22C0124-30	304	55	PE2V006	337	21	PE3137	170	71	PE3344	126	90	PE3521	190	22
PE1V13009	339	8	PE2061	321	43	PE2200V032	Web	92	PE22C0125-10	304	54	PE2V007	337	23	PE3138	208	87	PE3345	125	86	PE3522	126	86
PE1V13010	339	9	PE2062	321	41	PE2200V033A	Web	92	PE22C0125-20	304	54	PE2V008	337	25	PE3139	168	76	PE3346	125	87	PE3523	190	25
PE1V13011	339	10	PE2063	320	79	PE2200V033B	Web	92	PE22C0126	306	64	PE2V009	337	27	PE3141	162	62	PE3348	158	4	PE3525	126	46
PE1V13012	339	11	PE2064	320	81	PE2200V033A	320	91	PE22C0127	306	65	PE2V010	337	29	PE3143	140	19	PE3349	195	58	PE3526	Web	30
PE1V13013	339	12	PE2065	320	86	PE2200V034	Web	92	PE22C0128	306	66	PE2V011	337	31	PE3145	129	1	PE3351	124	50	PE3528	220	61
PE1V13014	339	13	PE2066	320	82	PE2200V034A	321	18	PE22C0129	306	67	PE2V012	337	33	PE3146	Web	30	PE3352	170	74	PE3531	173	51
PE1V13015	339	14	PE2067	320	80	PE2200V035	Web	92	PE22C0130	306	68	PE2V013	337	35	PE3147	184	51	PE3353	167	72	PE3534	189	8
PE1V14000	338	76	PE2068	320	84	PE2200V036	Web	92	PE22C0131	306	69	PE2V014	337	37	PE3149	167	73	PE3355	121	81	PE3535	168	8
PE1V14001	338	77	PE2069	Web	PE2200V037	321	24	PE22C0132	306	70	PE2V015	337	39	PE3149	180	80	PE3356	167	73	PE3536	Web	30	
PE1V14002	338	78	PE2070	319	38	PE2200V038A	321	24	PE22C0133	306	71	PE2V016	337	41	PE3152	185	81	PE3358	121	85	PE3539	161	56
PE1V14003	338	79	PE2071	Web	PE2200V037	Web	92	PE22C0134	306	72	PE2V017	337	43	PE3154	176	50	PE3360	121	94	PE3542	131	75	
PE1V14004	338	80	PE2072	Web	PE2200V038	Web	92	PE22C0135	306	73	PE2V018	337	45	PE3156	185	78	PE3361	167	75	PE3543	212	95	
PE1V14005	338	81	PE2073	Web	PE2200V038A	321	38	PE22C0136	306	74	PE2V019	337	47	PE3157	203	50	PE3362	221	79	PE3544	207	53	
PE1V14006	338	82	PE2074	320	96	PE2200V039	Web	92	PE22C0137	306	75	PE300	168	85	PE3158	129	5	PE3364	125	74	PE3545	123	33
PE1V14007	338	83	PE2075	Web	PE2200V040	321	37	PE22C0138	306	76	PE301	167	83	PE3159	167	79	PE3365	125	74	PE3546	Web	30	
PE1V14008	338	84	PE2077	319	55	PE2200V040	319	58	PE22C0139	306	77	PE302	164	62	PE3166								



# PART NUMBER INDEX

Note: C/R stands for the Column and/or Row location of the specific product on a given page.

Model No.	Page	C/R	Model No.	Page	C/R	Model No.	Page	C/R	Model No.	Page	C/R	Model No.	Page	C/R	Model No.	Page	C/R	Model No.	Page	C/R	Model No.	Page	C/R			
PE3675	125	77	PE3811	163	56	PE33236	138	59	PE33551	Web	PE33977	150	16	PE34250	177	72	PE34466	200	78	PE34727	179	27				
PE3678	120	64	PE3814	161	66	PE33237	Web	PE33552	Web	PE33978	Web	PE34252	173	53	PE34467	198	24	PE34479	198	24	PE34729	101	81			
PE3679	185	96	PE3815	196	76	PE33243	Web	PE33555	Web	PE33982	Web	PE34253	177	61	PE34469	198	21	PE34730	Web							
PE3680	Web		PE3816	197	11	PE33247	220	71	PE33554	165	9	PE34254	173	54	PE34470	200	94	PE34731	100	80						
PE3681	181	79	PE3817	197	17	PE33252	Web	PE33556	199	56	PE33989	161	64	PE34255	177	74	PE34471	198	22	PE34733	100	73				
PE3683	200	81	PE3818	200	81	PE33253	Web	PE33557	Web	PE33986	165	96	PE34256	173	55	PE34472	200	99	PE34734	101	86					
PE3684	208	47	PE3819	200	87	PE33254	Web	PE33559	189	14	PE33988	164	63	PE34257	173	56	PE34473	198	23	PE34735	101	73				
PE3686	143	9	PE3820	139	88	PE33257	Web	PE33561	Web	PE34008	160	50	PE34259	164	72	PE34474	200	1	PE34745	101	85					
PE3688	121	83	PE3821	142	85	PE33258	Web	PE33562	Web	PE34036	119	25	PE34261	164	67	PE34475	198	31	PE34750	179	38					
PE3690	Web		PE3822	143	26	PE33260	Web	PE33565	Web	PE34036	Web	PE34263	163	49	PE34476	200	91	PE34752	Web							
PE3693	Web		PE3824	172	42	PE33261	Web	PE33567	Web	PE34046	Web	PE34265	164	68	PE34477	198	26	PE34754	Web							
PE3694	131	70	PE3825	185	97	PE33266	Web	PE33574	121	71	PE34050	Web	PE34266	166	63	PE34478	200	92	PE34755	Web						
PE3695	Web		PE3826	192	9	PE33267	Web	PE33575	Web	PE34078	Web	PE34268	163	48	PE34479	198	20	PE34757	Web							
PE3696	160	53	PE3829	192	89	PE33269	138	62	PE33580	199	68	PE34061	185	87	PE34480	196	73	PE34759	Web							
PE3697	171	1	PE3830	221	94	PE33270	220	70	PE33581	Web	PE34062	Web	PE34270	164	69	PE34481	196	90	PE34764	174	78					
PE3698	150	20	PE3831	190	23	PE33271	Web	PE33582	129	15	PE34069	162	25	PE34271	207	83	PE34770	207	70	PE34773	179	33				
PE3699	140	18	PE3832	192	66	PE33272	Web	PE33584	Web	PE34070	192	80	PE34272	148	56	PE34483	197	2	PE34773	Web						
PE3700	Web		PE3833	192	60	PE33275	Web	PE33586	221	77	PE34071	192	91	PE34273	207	79	PE34484	200	96	PE34777	163	30				
PE3701	Web		PE3836	192	99	PE33278	Web	PE33589	Web	PE34078	200	93	PE34274	141	68	PE34485	196	89	PE34786	Web						
PE3704	167	82	PE3840	173	45	PE33280	Web	PE33596	Web	PE34087	Web	PE34275	208	86	PE34486	200	90	PE34792	Web							
PE3706	171	99	PE3844	174	48	PE33284	Web	PE33601	Web	PE34098	144	42	PE34276	141	64	PE34487	197	1	PE34801	148	41					
PE3708	Web		PE3845	Web		PE33285	Web	PE33603	Web	PE34106	Web	PE34277	207	80	PE34488	196	67	PE34808	Web							
PE3713	183	45	PE3846	Web		PE33288	138	64	PE33605	220	52	PE34111	207	81	PE34489	197	97	PE34809	Web							
PE3714	181	58	PE3848	Web		PE33298	Web	PE33606	Web	PE34116	173	62	PE34280	206	43	PE34490	196	79	PE34812	Web						
PE3715	Web		PE3849	122	99	PE33300	Web	PE33615	143	52	PE34119	207	82	PE34491	197	91	PE34817	Web								
PE3721	196	73	PE3850	132	79	PE33304	129	8	PE33616	Web	PE34122	162	28	PE34492	206	44	PE34819	199	57	PE34831	Web					
PE3722	174	85	PE3853	125	73	PE33307	Web	PE33632	Web	PE34123	Web	PE34283	141	60	PE34493	197	92	PE34833	189	7						
PE3724	Web		PE3856	127	35	PE33316	125	82	PE33633	Web	PE34129	Web	PE34284	207	82	PE34494	199	52	PE34834	190	21					
PE3725	Web		PE3857	163	59	PE33318	Web	PE33634	Web	PE34135	185	1	PE34285	142	82	PE34495	197	93	PE34835	189	19					
PE3726	140	20	PE3858	169	37	PE33320	Web	PE33635	Web	PE34138	139	84	PE34287	142	79	PE34496	199	64	PE34836	199	20					
PE3729	Web		PE3859	172	38	PE33324	140	31	PE33636	Web	PE34140	139	85	PE34288	142	81	PE34497	199	65	PE34837	198	21				
PE3733	131	74	PE3860	172	26	PE33330	241	76	PE33637	Web	PE34141	139	86	PE34289	141	54	PE34498	200	76	PE34841	199	66				
PE3736	131	69	PE3861	172	33	PE33342	Web	PE33643	200	79	PE34142	139	82	PE34292	189	10	PE34499	199	59	PE34842	198	22				
PE3736	175	2	PE3863	138	47	PE33345	Web	PE33644	220	72	PE34143	165	16	PE34293	141	55	PE34500	199	61	PE34858	198	23				
PE3739	168	1	PE3865	141	57	PE33349	Web	PE33645	200	80	PE34144	139	83	PE34296	142	80	PE34501	199	71	PE34860	128	99				
PE3740	186	6	PE3866	142	2	PE33350	197	12	PE33646	221	78	PE34146	138	41	PE34297	185	93	PE34502	199	53	PE34862	128	94			
PE3741	Web		PE3867	147	19	PE33355	199	69	PE33647	199	64	PE34147	138	42	PE34298	184	94	PE34503	199	54	PE34863	128	95			
PE3743	213	10	PE3868	142	1	PE33361	Web	PE33648	200	86	PE34149	138	43	PE34299	185	91	PE34504	200	82	PE34864	128	96				
PE3744	Web		PE3872	Web		PE33356	196	83	PE33650	196	68	PE34150	142	98	PE34505	185	92	PE34505	199	67	PE34879	135	74			
PE3747	207	60	PE3873	176	55	PE33361	176	55	PE33652	196	69	PE34151	165	15	PE34307	184	72	PE34507	199	73	PE34881	136	83			
PE3749	120	50	PE3876	Web		PE33363	199	62	PE33654	197	9	PE34152	143	19	PE34309	185	89	PE34508	205	11	PE34882	145	73			
PE3750	145	63	PE3877	141	69	PE33365	Web	PE33656	197	10	PE34153	165	96	PE34311	185	94	PE34509	199	65	PE34883	136	84				
PE3753	Web		PE3879	142	83	PE33367	Web	PE33657	147	89	PE34154	165	97	PE34312	185	95	PE34510	205	10	PE34884	Web					
PE3754	189	84	PE3880	Web		PE33370	128	11	PE33658	199	54	PE34156	165	98	PE34313	184	76	PE34511	205	11	PE34885	136	85			
PE3758	189	18	PE3882	148	63	PE33377	128	14	PE33659	Web	PE34156	142	97	PE34314	Web		PE34512	199	65	PE34887	162	77				
PE3759	185	79	PE3883	143	23	PE33380	Web	PE33660	199	55	PE34157	165	18	PE34315	185	95	PE34520	200	17	PE34889	136	85				
PE3764	192	95	PE3886	141	67	PE33381	Web	PE33662	125	94	PE34158	143	21	PE34316	207	61	PE34523	Web		PE34891	135	78				
PE3765	200	82	PE3887	183	44	PE33382	192	82	PE33664	191	63	PE34159	166	21	PE34317	185	98	PE34524	Web		PE34893	136	86			
PE3767	Web		PE3888	142	86	PE33384	Web	PE33666	196	80	PE34160	165	99	PE34319	184	73	PE34526	199	68	PE34894	136	87				
PE3769	189	82	PE3889	148	82	PE33389	Web	PE33668	200	85	PE34161	166	22	PE34321	185	91	PE34527	200	83	PE34895	136	88				
PE3770	Web		PE3891	148	60	PE33393	Web	PE33669	176	49	PE34162	120	61	PE34323	179	34	PE34544	Web		PE34902	Web					
PE3776	183	38	PE3892	159	19	PE33394	Web	PE33670	196	87	PE34163	165	97	PE34324	Web		PE34548	Web		PE34917	Web					
PE3776	120	40	PE3893	143	27	PE33396	177	63	PE33672	196	88	PE34164	120	60	PE34331	173	64	PE34553	Web		PE34922	Web				
PE3777	122	96	PE3894	Web		PE33399	217	81	PE33673	176	56	PE34165	Web	PE34333	Web		PE34554	149	79	PE34925	Web					
PE3778	167	76	PE3895	139	89	PE33400	Web	PE33674	197	94	PE34166	120	38	PE34334	Web		PE34559	Web		PE34926	Web					
PE3781	141	69	PE3896	142	83	PE33401	Web	PE33675	197	94	PE34168	120	39	PE34335	Web		PE34560	Web		PE34927	Web					
PE3780	181	70	PE3897	138	58	PE33405	217	84	PE33676	197	95	PE34169	166	22	PE34335	182	9	PE34562	Web		PE34945	Web				
PE3781	151	24	PE3899	120	44	PE33407	217	86	PE33680	Web	PE34170	120	62	PE34337	144	47	PE34568	Web		PE34952	Web					
PE3782	139	86	PE33001	164	70	PE33412	217	89	PE33682	198	27	PE34171	165	3	PE34339	144	48	PE34569	101	94	PE34957	Web				
PE3785	Web		PE33002	Web		PE33417	217	90	PE33686	199	70	PE34173	120	37	PE34343	109	83	PE34571	Web		PE34962	Web				



# PART NUMBER INDEX

Note: C/R stands for the Column and/or Row location of the specific product on a given page.

Model No.	Page	C/R	Model No.	Page	C/R	Model No.	Page	C/R	Model No.	Page	C/R	Model No.	Page	C/R	Model No.	Page	C/R	Model No.	Page	C/R	Model No.	Page	C/R			
PE35242	178	3	PE36034	Web		PE37401	175	19	PE38215	Web		PE38748	126	22	PE391972	161	83	PE39436	161	82						
PE35243	149	82	PE36046	Web		PE37411	Web		PE38219	Web		PE38748K	126	23	PE391974	162	99	PE39437	167	63						
PE35244	178	4	PE36056	Web		PE37421	Web		PE38231	135	81	PE38748Z	126	24	PE39199C	162	1	PE39438	183	32						
PE35245	149	83	PE36058	Web	176	34	PE37431	Web		PE38240	172	22	PE38749A	126	33	PE39199C	162	2	PE39439	169	35					
PE35246	178	7	PE36059	Web		PE37441	Web		PE38249	124	45	PE38749B	126	34	PE39199D	162	3	PE39440	171	93						
PE35247	149	84	PE36064	Web		PE37451	Web		PE38280	Web		PE38749C	126	35	PE39199H	162	4	PE39441	172	31						
PE35266	97	144	PE36065	Web	55	97	PE37452	Web		PE38288	Web		PE38749D	126	36	PE39199I	162	5	PE39442	173	70					
PE35269	144	56	PE36066	Web	119	27	PE37453	Web		PE38270	157	70	PE38749H	126	37	PE39199K	162	6	PE39443	138	46					
PE35276	145	77	PE36067	Web	148	39	PE37454	Web		PE38271	157	69	PE38749I	126	38	PE39199L	162	7	PE39444	150	7					
PE35281	Web		PE36068	Web	204	89	PE37455	Web		PE38272	157	66	PE38749K	126	39	PE39229	159	25	PE39445	140	8					
PE35282	Web		PE36072	Web	179	26	PE37456	Web		PE38273	166	25	PE38749Z	126	40	PE39231	Web		PE39446	141	47					
PE35283	109	73	PE36073	Web		PE37457	Web		PE38274	166	26	PE38750A	127	63	PE39242	Web		PE39447	163	93						
PE35284	Web	39	PE36087	Web		PE37459	Web	11	24	PE38275	166	24	PE38750B	127	64	PE39243	Web		PE39448	182	7					
PE35334	Web		PE36101	Web		PE37460	Web			PE38276	189	99	PE38750C	127	65	PE39255	Web	97	PE39449	155	23					
PE35343	Web		PE36108	Web		PE37461	Web			PE38277	189	98	PE38750D	127	66	PE39256	Web		PE39450	155	25					
PE35347	183	17	PE36109	Web	216	69	PE37462	Web		PE38278	189	97	PE38750H	127	67	PE39258	Web		PE39451	138	45					
PE35348	221	87	PE36110	Web	162	17	PE37463	Web		PE38291	Web		PE38750I	127	68	PE39260	Web		PE39452	150	17					
PE35349	180	47	PE36111	Web	216	70	PE37464	Web		PE38292	216	68	PE38750K	127	69	PE39275	Web		PE39453	139	7					
PE35350	221	88	PE36112	Web	162	18	PE37465	Web		PE38298	Web		PE38751K	126	9	PE39277	Web		PE39454	141	6					
PE35351	173	71	PE36113	Web	216	71	PE37466	Web		PE38299	194	22	PE38751A	126	4	PE39278	Web		PE39455	165	91					
PE35352	221	88	PE36114	Web	130	30	PE37467	Web		PE38300	194	33	PE38751C	126	5	PE39298	Web		PE39456	182	4					
PE35353	180	48	PE36116	Web	130	31	PE37468	Web		PE38301	195	41	PE38751D	126	6	PE39301	Web		PE39457	137	27					
PE35354	221	83	PE36117	Web	216	72	PE37469	Web		PE38302	216	17	PE38751H	126	7	PE39315	Web		PE39458	150	8					
PE35355	173	72	PE36118	Web	130	32	PE37470	Web		PE38303	212	85	PE38751I	126	8	PE39318	Web		PE39459	140	9					
PE35356	221	89	PE36119	Web	216	73	PE37471	Web	29	92	PE38304	212	80	PE38751J	126	9	PE39324	Web		PE39460	151	6				
PE35357	180	49	PE36120	Web	130	33	PE37472	Web		PE38311	Web		PE38751Z	126	10	PE39326	Web		PE39461	165	94					
PE35358	221	84	PE36122	Web	130	34	PE37473	Web		PE38313	Web		PE38752A	126	26	PE39332	Web		PE39462	182	8					
PE35359	174	73	PE36123	Web	217	77	PE37474	Web		PE38314	Web		PE38752C	126	27	PE39333	Web		PE39463	155	24					
PE35360	221	90	PE36124	Web	130	35	PE37475	Web		PE38318	Web		PE38752D	126	28	PE39340	Web		PE39464	156	26					
PE35361	180	50	PE36125	Web	217	78	PE37476	Web		PE38322	136	82	PE38752H	126	29	PE39342A	161	69	PE39465	137	26					
PE35362	221	85	PE36126	Web	130	36	PE37477	Web		PE38343	218	26	PE38752I	126	30	PE39342B	161	70	PE39466	157	18					
PE35363	221	86	PE36127	Web	217	79	PE37478	Web		PE38344	218	27	PE38752J	126	31	PE39342C	161	71	PE39467	148	17					
PE35364	221	91	PE36128	Web	130	37	PE37479	Web		PE38347	Web		PE38752K	126	32	PE39342D	161	72	PE39468	153	88					
PE35365	180	51	PE36129	Web	216	75	PE37480	Web		PE38355	Web		PE38753A	127	41	PE39342H	161	73	PE39469	165	92					
PE35366	221	86	PE36130	Web	130	38	PE37481	Web		PE38377	Web		PE38753C	127	42	PE39342I	161	74	PE39470	182	5					
PE35367	174	75	PE36131	Web	216	76	PE37482	Web		PE38387	Web		PE38753D	127	43	PE39342J	161	75	PE39471	205	40					
PE35368	180	52	PE36132	Web	216	77	PE37483	Web		PE38388	Web		PE38753H	127	44	PE39342K	161	76	PE39472	210	38					
PE35369	174	76	PE36134	Web	109	78	PE37484	Web		PE38394	Web		PE38753I	127	45	PE39343A	161	77	PE39473	203	30					
PE35373	180	53	PE36135	Web	218	20	PE37485	Web		PE38402	Web		PE38753J	127	46	PE39343C	161	78	PE39474	208	98					
PE35376	174	77	PE36136	Web	109	81	PE37486	Web		PE38407	202	41	PE38753Z	127	47	PE39343D	161	79	PE39475	178	94					
PE35384	159	17	PE36137	Web	218	23	PE37487	Web		PE38411	Web		PE38754A	127	72	PE39343H	161	87	PE39476	187	36					
PE35387	Web		PE36138	Web	109	84	PE37488	Web		PE38423	Web		PE38754B	127	73	PE39343I	161	88	PE39477	210	51					
PE35389	Web		PE36139	Web	218	24	PE37489	Web		PE38433	Web	35	PE38754C	127	74	PE39343K	161	89	PE39478	215	49					
PE35404	Web	81	PE36140	Web	109	79	PE37490	Web		PE38436	Web	32	PE38754D	127	75	PE39344A	161	90	PE39479	226	39					
PE35430	Web	175	PE36141	Web	218	21	PE37491	Web		PE38438	Web		PE38754H	127	76	PE39344A	161	90	PE39480	210	40					
PE35435	Web		PE36142	Web	109	85	PE37492	Web		PE38446	Web		PE38754I	128	77	PE39344C	161	91	PE39481	208	92					
PE35437	Web		PE36143	Web	218	22	PE37493	Web		PE38447	Web		PE38754K	128	78	PE39344D	161	92	PE39482	210	47					
PE35441	Web		PE36144	Web	109	72	PE37494	Web		PE38448	Web		PE38754Z	128	79	PE39344H	161	93	PE39483	178	96					
PE35444	Web		PE36145	Web	218	11	PE37495	Web		PE38449	Web		PE38755A	128	80	PE39344I	161	94	PE39484	187	34					
PE35454	Web		PE36146	Web	109	73	PE37496	Web		PE38451	Web		PE38755B	128	81	PE39344J	161	95	PE39485	208	48					
PE35463	131	58	PE36147	Web	218	12	PE37497	Web		PE38451	Web		PE38755D	128	82	PE39344Z	161	96	PE39486	210	39					
PE35474	Web		PE36148	Web	201	10	PE37498	Web		PE38452	Web		PE38755H	126	13	PE39345A	161	97	PE39487	210	94					
PE35480	210	48	PE36149	Web	218	13	PE37499	Web		PE38453	Web		PE38755I	126	14	PE39345C	161	98	PE39488	208	99					
PE35505	Web		PE36150	Web	201	15	PE37500	Web		PE38454	Web		PE38755K	126	16	PE39345D	161	99	PE39489	178	95					
PE35508	Web		PE36151	Web	218	14	PE37501	Web		PE38455	Web		PE38755L	126	17	PE39345H	161	100	PE39490	187	38					
PE35512	179	35	PE36152	Web	201	16	PE37502	Web		PE38456	Web		PE38756A	126	18	PE39345I	161	101	PE39491	187	39					
PE35522	174	91	PE36153	Web	218	15	PE37503	Web		PE38457	Web		PE38756C	126	19	PE39345K	161	102	PE39492	210	55					
PE35541	Web		PE36154	Web	201	19	PE37504	Web		PE38466	Web		PE38756D	126	20	PE39345Z	161	103	PE39493	205	46					
PE35552	Web		PE36155	Web	218	16	PE37505	Web		PE38474	Web		PE38756H	126	21	PE39346A	161	104	PE39494	210	37					
PE35556	Web		PE36156	Web	201	16	PE37506	Web		PE38478	Web		PE38756I	126	22	PE39346C	161	105	PE39495	203	93					
PE35563	Web		PE36157	Web	130	38	PE37507	Web	44	PE38486	Web		PE38756K	126	23	PE39346D	161	106	PE39496	208						

# PART NUMBER INDEX

Note: C/R stands for the Column and/or Row location of the specific product on a given page.

Model No.	Page	C/R	Model No.	Page	C/R	Model No.	Page	C/R	Model No.	Page	C/R	Model No.	Page	C/R	Model No.	Page	C/R	Model No.	Page	C/R			
PEC30054	195	50	PEC33249	182	97	PEC34042	134	35	PEC34468	204	78	PEC34948	115	31	PEC35830	96	12	PEC36355	107	27	PEC37853	214	32
PEC30061	137	8	PEC33250	182	98	PEC34043	135	35	PEC34470	204	72	PEC34949	114	94	PEC35881	96	50	PEC36356	109	66	PEC37854	214	33
PEC30102	163	31	PEC33251	164	79	PEC34044	133	17	PEC34471	176	30	PEC34950	113	73	PEC35882	96	85	PEC36357	110	13	PEC37855	214	34
PEC30103	166	38	PEC33252	164	85	PEC34045	134	53	PEC34472	186	14	PEC34951	115	27	PEC35883	96	65	PEC36358	110	18	PEC37856	98	35
PEC30104	169	19	PEC33253	143	15	PEC34046	133	21	PEC34473	190	35	PEC34952	118	87	PEC35884	96	71	PEC36359	111	32	PEC37857	98	36
PEC30105	137	19	PEC33275	113	61	PEC34047	138	57	PEC34474	193	35	PEC34953	113	79	PEC35885	96	73	PEC36360	137	35	PEC37858	98	37
PEC30106	139	97	PEC33276	128	21	PEC34048	133	7	PEC34475	123	35	PEC34954	114	91	PEC35886	96	38	PEC36361	140	18	PEC37859	98	38
PEC30107	150	99	PEC33286	143	25	PEC34049	133	7	PEC34476	123	40	PEC34955	114	7	PEC35887	180	39	PEC36362	149	90	PEC37860	99	39
PEC30109	148	43	PEC33314	124	63	PEC34050	134	43	PEC34478	147	35	PEC34956	116	43	PEC35884	99	54	PEC36363	104	55	PEC37861	99	40
PEC30110	137	14	PEC33318	195	59	PEC34051	133	29	PEC34480	204	80	PEC34957	115	13	PEC35888	97	6	PEC36365	105	75	PEC37862	99	41
PEC30111	139	2	PEC33321	161	67	PEC34052	135	65	PEC34481	203	57	PEC34958	116	49	PEC35889	132	92	PEC36366	110	14	PEC37863	167	52
PEC30112	137	15	PEC33325	172	20	PEC34053	134	52	PEC34482	203	69	PEC34959	114	4	PEC35890	219	45	PEC36367	137	36	PEC37864	169	26
PEC30113	168	27	PEC33328	160	54	PEC34054	134	25	PEC34483	204	73	PEC34960	116	37	PEC35891	103	32	PEC36368	137	37	PEC37865	171	88
PEC30116	168	88	PEC33332	179	20	PEC34055	135	69	PEC34484	175	27	PEC34961	115	22	PEC35892	103	36	PEC36369	140	14	PEC37866	172	28
PEC30117	206	34	PEC33344	122	3	PEC34056	133	11	PEC34485	186	12	PEC34962	117	58	PEC35893	104	68	PEC36372	150	12	PEC37867	183	24
PEC30118	136	95	PEC33349	121	68	PEC34057	134	47	PEC34486	193	6	PEC34963	114	95	PEC35894	104	52	PEC36374	137	38	PEC37868	184	64
PEC30119	150	1	PEC33350	181	76	PEC34058	134	38	PEC34487	123	37	PEC34964	115	32	PEC35895	104	64	PEC36375	140	15	PEC37869	184	71
PEC30120	150	94	PEC33354	164	65	PEC34059	135	73	PEC34488	123	41	PEC34965	115	11	PEC35896	106	16	PEC36376	150	13	PEC37870	157	67
PEC30121	163	32	PEC33359	121	89	PEC34060	133	25	PEC34489	141	32	PEC34966	169	20	PEC35897	104	53	PEC36377	153	91	PEC37871	157	72
PEC30124	136	96	PEC33377	121	80	PEC34061	135	56	PEC34490	204	77	PEC34967	156	46	PEC35898	104	54	PEC36379	153	92	PEC37872	157	74
PEC30125	142	87	PEC33378	144	61	PEC34062	133	24	PEC34491	176	37	PEC34968	193	98	PEC35899	104	65	PEC36380	104	56	PEC37873	157	76
PEC30126	153	94	PEC33379	144	62	PEC34063	136	60	PEC34492	100	65	PEC34969	166	30	PEC35900	109	64	PEC36381	105	85	PEC37874	157	80
PEC30128	138	72	PEC33380	145	66	PEC34064	132	98	PEC34493-12	350	34	PEC34970	172	25	PEC35902	110	4	PEC36382	105	91	PEC37875	158	83
PEC30230	166	40	PEC33387	130	39	PEC34065	134	39	PEC34494-24	350	35	PEC34971	184	68	PEC35903	111	38	PEC36383	112	46	PEC37876	158	84
PEC30231	163	33	PEC33391	121	84	PEC34066	135	63	PEC34494-48	350	36	PEC34972	169	20	PEC35904	112	50	PEC36384	112	50	PEC37877	158	85
PEC30232	164	64	PEC33393	205	3	PEC34067	136	61	PEC34495	152	62	PEC34973	192	74	PEC35905	107	25	PEC36385	137	39	PEC37878	159	88
PEC30233	146	97	PEC33397	122	13	PEC34068	133	12	PEC34801	203	48	PEC34974	183	20	PEC35906	105	74	PEC36387	104	57	PEC37879	112	81
PEC30438	201	18	PEC33399	122	13	PEC34069	134	48	PEC34807	136	63	PEC34975	206	36	PEC35907	103	39	PEC36388	104	58	PEC37880	187	41
PEC30441	97	3	PEC33400	205	96	PEC34130	96	44	PEC34844	113	71	PEC35250	209	33	PEC35908	109	90	PEC36389	104	59	PEC37881	140	34
PEC30481	179	25	PEC33401	205	96	PEC34131	95	52	PEC34845	113	63	PEC35251	212	77	PEC35909	111	36	PEC36390	98	22	PEC37882	123	43
PEC30531	201	65	PEC33402	178	28	PEC34132	96	78	PEC34846	115	20	PEC35252	208	88	PEC35910	110	19	PEC36391	98	26	PEC37883	98	26
PEC30567	137	19	PEC33403	178	28	PEC34133	96	59	PEC34848	115	25	PEC35253	212	72	PEC35911	110	11	PEC36392	98	27	PEC37884	98	27
PEC30589	163	41	PEC33412	179	22	PEC34134	96	59	PEC34849	116	86	PEC35254	210	45	PEC35912	110	11	PEC36393	98	28	PEC37885	98	28
PEC30689	163	41	PEC33413	179	24	PEC34135	96	30	PEC34850	114	85	PEC35255	137	21	PEC35913	110	16	PEC36394	100	69	PEC37886	98	29
PEC30752	97	14	PEC33414	209	29	PEC34136	96	79	PEC34851	113	82	PEC35256	155	33	PEC35914	111	26	PEC36395	97	9	PEC37887	98	30
PEC30757	201	13	PEC33420	128	88	PEC34137	96	80	PEC34852	113	67	PEC35257	142	91	PEC35915	111	28	PEC36396	97	10	PEC37888	99	44
PEC30780	177	68	PEC33421	121	79	PEC34138	95	63	PEC34853	113	70	PEC35258	176	80	PEC35916	112	43	PEC36397	100	70	PEC37889	99	43
PEC30835	100	67	PEC33422	128	88	PEC34139	96	87	PEC34854	114	5	PEC35259	181	84	PEC35917	112	43	PEC36398	100	71	PEC37890	99	44
PEC30847	176	38	PEC33428	195	61	PEC34140	96	76	PEC34855	116	72	PEC35260	211	64	PEC35918	111	40	PEC36399	104	59	PEC37891	99	45
PEC30867	150	2	PEC33437	181	73	PEC34141	96	77	PEC34856	117	41	PEC35261	186	17	PEC35919	112	41	PEC36400	105	96	PEC37892	99	46
PEC30867	150	2	PEC33446	122	17	PEC34142	96	28	PEC34857	115	11	PEC35262	186	24	PEC35920	141	51	PEC36401	105	76	PEC37893	98	32
PEC30870	155	32	PEC33448	181	71	PEC34143	96	1	PEC34858	117	76	PEC35263	187	31	PEC35921	142	96	PEC36402	105	86	PEC37894	99	33
PEC30870	155	32	PEC33453	122	92	PEC34144	95	53	PEC34859	116	98	PEC35264	147	12	PEC35922	137	42	PEC36403	109	68	PEC37895	99	34
PEC31037	188	10	PEC33459	97	2	PEC34145	96	88	PEC34860	116	93	PEC35265	183	63	PEC35923	132	32	PEC36404	110	5	PEC37896	98	35
PEC31041	209	20	PEC33465	215	48	PEC34146	96	39	PEC34861	117	69	PEC35266	194	18	PEC35924	151	40	PEC36405	112	45	PEC37897	99	47
PEC31081	191	57	PEC33476	127	54	PEC34147	96	38	PEC34862	116	35	PEC35267	148	46	PEC35925	140	11	PEC36406	105	97	PEC37898	99	48
PEC31084	156	50	PEC33483	140	35	PEC34148	176	36	PEC34863	115	21	PEC35268	149	72	PEC35926	150	11	PEC36407	105	77	PEC37899	99	49
PEC31110	156	48	PEC33471	121	91	PEC34149	158	38	PEC34864	116	83	PEC35269	149	75	PEC35927	167	53	PEC36408	105	87	PEC37900	194	26
PEC31128	147	22	PEC33481	131	54	PEC34150	201	12	PEC34865	110	57	PEC35270	156	49	PEC35928	163	26	PEC36409	109	68	PEC37901	194	27
PEC31144	186	19	PEC33482	133	27	PEC34151	193	13	PEC34866	113	32	PEC35271	157	50	PEC35929	110	32	PEC36410	110	32	PEC37902	194	28
PEC31173	186	10	PEC33492	133	27	PEC34152	115	12	PEC34867	117	78	PEC35272	156	53	PEC35930	169	27	PEC36411	112	47	PEC37903	194	24
PEC31179	186	16	PEC33497	133	99	PEC34153	203	54	PEC34868	116	52	PEC35273	146	98	PEC35931	152	60	PEC36412	109	69	PEC37904	194	25
PEC31203	183	47	PEC33498	132	1	PEC34154	203	61	PEC34869	115	18	PEC35274	155	39	PEC35932	147	18	PEC36413	105	78	PEC37905	194	23
PEC31239	189	5	PEC33499	133	5	PEC34155	204	83	PEC34870	118	80	PEC35275	147	15	PEC35933	146	2	PEC36414	104	60	PEC37906	194	21
PEC31271	152	66	PEC33499	134	45	PEC34156	173	22	PEC34871	116	54	PEC35276	155	42	PEC35934	155	40	PEC36415	109	70	PEC37907	194	22
PEC31276	152	66	PEC33499	134	45	PEC34157	173	22	PEC34872	116	54	PEC35277	155	42	PEC35935	155	40	PEC36416	109	70	PEC37908	194	22
PEC31377	100	74	PEC33499	134	50	PEC34158	190	30	PEC34873	117	66	PEC35278	156	45	PEC35936	156	43	PEC36417	104	61	PEC37909	156	59
PEC31398	1																						

# PART NUMBER INDEX

Note: C/R stands for the Column and/or Row location of the specific product on a given page.

Model No.	Page	C/R	Model No.	Page	C/R	Model No.	Page	C/R	Model No.	Page	C/R	Model No.	Page	C/R	Model No.	Page	C/R	Model No.	Page	C/R			
PE3CA1130	166	50	PE3CM127	94	50	PE3TC0101-24	353	77	PE3W00587	198	33	PE3W08017	202	43	PE4062	281	76	PE4191	263	86	PE4330	263	74
PE3CA001	93	5	PE3CM128	94	48	PE3TC0102	171	86	PE3W00676	141	44	PE3W08018	202	43	PE4063	281	76	PE4192	263	5	PE4331	263	78
PE3CM002	93	6	PE3CM129	94	51	PE3TC0102-24	353	75	PE3W00780	208	2	PE3W08020	221	95	PE4064	288	8	PE4193	267	84	PE4332	269	62
PE3CM003	93	7	PE3CM130	94	53	PE3TC0103	137	28	PE3W00808	207	67	PE3W08055	190	28	PE4064SP	288	7	PE4194	268	40	PE4333	268	36
PE3CM004	93	8	PE3CM131	94	52	PE3TC0103-24	353	73	PE3W00825	190	37	PE3W08085	187	95	PE4065	288	2	PE4195	248	77	PE4334	284	63
PE3CM005	93	9	PE3CM132	94	46	PE3TC0104	141	46	PE3W00832	163	40	PE3W08095	149	41	PE4066	288	2	PE4196	273	91	PE4335	273	91
PE3CM006	93	10	PE3CM133	94	46	PE3TC0104-24	353	46	PE3W00852	182	80	PE3W08121	151	72	PE4067	288	14	PE4197	272	92	PE4336	268	68
PE3CM007	93	11	PE3CM134	94	45	PE3TC0105	163	46	PE3W00906	173	61	PE3W08234	201	21	PE4068	287	65	PE4198	254	82	PE4337	284	69
PE3CM008	93	36	PE3CM135	94	69	PE3TC0105-24	353	74	PE3W00921	182	90	PE3W08305	125	79	PE4069	280	76	PE4199	282	18	PE4338	284	71
PE3CM009	93	37	PE3CM136	94	70	PE3TC0201	166	46	PE3W00934	191	55	PE3W08365	145	74	PE4070	248	88	PE4200	277	31	PE4339	284	72
PE3CM010	93	38	PE3CM137	94	67	PE3TC0201-24	353	78	PE3W01041	119	32	PE3W08405	155	41	PE4071	248	88	PE4201	277	31	PE4340	284	73
PE3CM011	93	42	PE3CM138	94	72	PE3TC0202	171	67	PE3W01114	181	84	PE3W08410	175	23	PE4072	263	73	PE4202	279	78	PE4341	284	74
PE3CM012	93	43	PE3CM139	94	79	PE3TC0202-24	353	76	PE3W01217	139	79	PE3W08447	147	16	PE4073	247	16	PE4203	276	33	PE4342	284	75
PE3CM013	93	44	PE3CM140	94	74	PE3TC0301	166	47	PE3W01283	175	15	PE3W08425	182	15	PE4074	279	81	PE4204	248	81	PE4343	284	76
PE3CM014	93	39	PE3CM141	94	61	PE3TC0301-24	353	81	PE3W01300	131	59	PE3W08444	151	38	PE4075	257	64	PE4205	248	82	PE4344	261	5
PE3CM015	93	40	PE3CM142	94	65	PE3TC0302	137	29	PE3W01357	119	34	PE3W08441	218	10	PE4076	257	57	PE4206	247	33	PE4345	248	76
PE3CM016	93	41	PE3CM143	94	63	PE3TC0302-24	353	79	PE3W01379	212	81	PE3W08468	130	49	PE4077	249	19	PE4207	247	34	PE4346	299	3
PE3CM017	93	45	PE3CM144	94	71	PE3TC0303	163	47	PE3W01570	131	52	PE3W08580	208	5	PE4078	249	9	PE4208	249	10	PE4347	300	5
PE3CM018	93	47	PE3CM145	94	68	PE3TC0303-24	353	80	PE3W01582	121	74	PE3W08629	186	22	PE4085	249	98	PE4209	249	9	PE4348	254	66
PE3CM019	93	49	PE3CM146	94	73	PE3TC0401	166	48	PE3W01626	163	45	PE3W08660	182	16	PE4080	277	34	PE4210	247	50	PE4349	268	38
PE3CM020	93	46	PE3CM147	94	77	PE3TC0401-24	353	82	PE3W01634	125	81	PE3W08682	158	16	PE4081	261	77	PE4211	248	64	PE4350	257	61
PE3CM021	93	48	PE3CM148	94	75	PE3TC0500	99	52	PE3W01739	215	5	PE3W08701	175	12	PE4082	248	65	PE4212	248	65	PE4351	247	55
PE3CM022	93	50	PE3CM149	94	62	PE3TC0500-24	351	63	PE3W01818	186	43	PE3W08709	210	44	PE4083	271	56	PE4213	270	3	PE4352	254	77
PE3CM023	94	86	PE3CM150	94	66	PE3TC0500-48	351	63	PE3W01959	205	13	PE3W08717	202	45	PE4084	274	35	PE4214	269	59	PE4353	272	43
PE3CM024	94	87	PE3CM151	94	64	PE3TC0600	103	59	PE3W01992	121	74	PE3W08829	186	22	PE4085	274	35	PE4215	269	63	PE4354	270	15
PE3CM025	94	89	PE3CM152	94	57	PE3TC0600-24	352	64	PE3W02012	146	28	PE3W08882	123	25	PE4088	286	13	PE4216	274	20	PE4355	265	45
PE3CM026	94	88	PE3CM153	94	58	PE3TC0600-48	352	64	PE3W02172	178	90	PE3W08883	140	21	PE4089	300	6	PE4218	274	25	PE4356	277	30
PE3CM027	94	90	PE3CM154	94	60	PE3TC0660	100	61	PE3W02209	127	71	PE3W08905	197	5	PE4091	249	16	PE4219	272	52	PE4357	277	30
PE3CM028	94	21	PE3CM155	94	59	PE3TC0660	214	37	PE3W02215	149	71	PE3W08981	117	73	PE4092	248	78	PE4220	278	41	PE4358	278	41
PE3CM029	93	12	PE3CM156	94	54	PE3TC0670	214	38	PE3W02336	179	36	PE3W07034	218	9	PE4093	257	63	PE4221	261	73	PE4359	279	66
PE3CM030	93	13	PE3CM157	94	56	PE3TC0700	107	57	PE3W02356	148	67	PE3W07044	217	9	PE4094	279	96	PE4222	263	10	PE4360	278	50
PE3CM031	93	14	PE3CM158	94	55	PE3TC0700-24	352	65	PE3W02430	187	40	PE3W07068	193	93	PE4095	278	53	PE4223	263	10	PE4361	278	50
PE3CM032	93	15	PE3CM159	95	19	PE3TC0700-48	352	65	PE3W02458	167	40	PE3W07094	123	27	PE4096	278	52	PE4224	267	15	PE4362	278	61
PE3CM033	93	16	PE3CM160	95	21	PE3TC0800	97	11	PE3W02466	171	79	PE3W07181	177	88	PE4097	278	63	PE4225	257	70	PE4363	278	64
PE3CM034	93	17	PE3CM161	95	20	PE3TC0800-24	352	66	PE3W02547	142	88	PE3W07225	173	80	PE4098	267	58	PE4226	257	67	PE4365	280	8
PE3CM035	93	18	PE3CM162	95	16	PE3TC0800-48	352	66	PE3W02744	181	83	PE3W07265	149	76	PE4099	278	67	PE4227	257	68	PE4366	277	39
PE3CM036	93	19	PE3CM163	95	15	PE3TC0800-500CM	352	66	PE3W02828	181	83	PE3W07284	206	25	PE4100	278	67	PE4228	257	69	PE4367	277	39
PE3CM037	93	52	PE3CM164	95	97	PE3TC0900	97	11	PE3W02943	128	80	PE3W07334	161	53	PE4101	278	67	PE4229	257	70	PE4368	278	36
PE3CM038	93	53	PE3CM165	95	30	PE3TC0900-24	352	67	PE3W02965	193	96	PE3W07396	131	60	PE4102	278	67	PE4230	257	71	PE4369	278	36
PE3CM039	93	57	PE3CM166	95	29	PE3TC0900-48	352	67	PE3W02976	153	96	PE3W07452	161	59	PE4104	278	67	PE4231	257	72	PE4370	278	36
PE3CM040	93	58	PE3CM167	95	26	PE3TC0950	98	25	PE3W02993	169	38	PE3W07480	124	65	PE4105	240	4	PE4231	268	28	PE4372	262	63
PE3CM041	93	59	PE3CM168	95	28	PE3TC0950	214	35	PE3W02994	184	65	PE3W07481	96	6	PE4106	240	5	PE4232	268	27	PE4373	262	63
PE3CM042	93	59	PE3CM169	95	25	PE3TC0970	214	36	PE3W03024	161	94	PE3W07489	207	16	PE4107	240	16	PE4233	254	78	PE4374	251	7
PE3CM043	93	55	PE3CM170	95	19	PE3TC1000	97	11	PE3W03030	192	53	PE3W07491	100	79	PE4108	240	16	PE4234	268	28	PE4375	261	81
PE3CM044	93	56	PE3CM171	95	22	PE3TC1000-24	352	69	PE3W03032	188	91	PE3W07493	174	99	PE4109	240	16	PE4235	268	29	PE4376	261	82
PE3CM045	93	60	PE3CM172	95	24	PE3TC1000-48	352	69	PE3W03078	159	28	PE3W07532	134	34	PE4110	240	16	PE4236	268	30	PE4377	247	39
PE3CM046	93	62	PE3CM173	95	23	PE3TC1100	120	35	PE3W03154	135	58	PE3W07591	136	88	PE4111	274	26	PE4237	268	31	PE4378	247	54
PE3CM047	93	64	PE3CM174	94	26	PE3TC1101	121	33	PE3W03175	211	65	PE3W07602	157	46	PE4112	274	26	PE4238	268	32	PE4379	247	41
PE3CM048	93	63	PE3CM175	94	28	PE3TC1102	137	20	PE3W03271	110	10	PE3W07619	219	63	PE4113	263	5	PE4239	268	32	PE4380	247	42
PE3CM049	93	63	PE3CM176	94	24	PE3TC1103	141	45	PE3W03310	133	10	PE3W07646	212	46	PE4114	263	5	PE4240	268	32	PE4381	247	42
PE3CM050	93	65	PE3CM177	94	31	PE3TC1200	220	58	PE3W03353	166	44	PE3W07647	210	50	PE4115	271	85	PE4241	251	8	PE4382	247	42
PE3CM051	94	91	PE3CM178	94	30	PE3TC1201	220	58	PE3W03361	128	84	PE3W07649	209	31	PE4116	271	88	PE4242	251	79	PE4383	247	42
PE3CM052	94	92	PE3CM179	94	29	PE3TC1202	218	17	PE3W03365	155	31	PE3W07653	196	89	PE4117	272	12	PE4243	251	77	PE4384	247	42
PE3CM053	94	94	PE3CM180	95	81	PE3TC1203	218	28	PE3W03377	125	80	PE3W07670	132	70	PE4118	272	12	PE4244	251	77	PE4385	247	42
PE3CM054	94	93	PE3CM181	95	83	PE3TC1204	220	57	PE3W03391	129	29	PE3W07671	123	29	PE4119	272	39	PE4245	278	49	PE4386	247	42
PE3CM055	94	93	PE3CM182	95	82	PE3TC1205	220	57	PE3W03406	161	66	PE3W07672	142	82	PE4120	272	39	PE4246	278	49	PE4387	247	42
PE3CM056	94	22	PE3CM183	95	84	PE3TC1206	219	31	PE3W03499	111	69	PE3W07											



# PART NUMBER INDEX

Note: C/R stands for the Column and/or Row location of the specific product on a given page.

Model No.	Page C/R	Model No.	Page C/R	Model No.	Page C/R	Model No.	Page C/R	Model No.	Page C/R	Model No.	Page C/R	Model No.	Page C/R	Model No.	Page C/R		
PE4589	287	72	PE4589	291	6	PE4743	250	53	PE4931	272	35	PE44084	258	12	PE44234	Web	
PE4600	287	66	PE4600	292	24	PE4744	250	50	PE4932	272	55	PE44085	258	10	PE44235	272	10
PE4601	287	62	PE4601	291	8	PE4745	250	51	PE4933	287	59	PE44086	258	14	PE44236	274	41
PE4602	287	68	PE4602	291	11	PE4746	250	63	PE4934	261	6	PE44087	258	13	PE44237	274	36
PE4603	287	63	PE4603	291	7	PE4747	250	66	PE4935	262	31	PE44088	258	7	PE44238	274	37
PE4604	287	64	PE4604	292	25	PE4748	250	67	PE4936	262	50	PE44089	258	16	PE44239	274	38
PE4605	287	64	PE4605	292	24	PE4749	250	64	PE4937	262	51	PE44090	258	6	PE44240	274	39
PE4606	287	67	PE4606	292	30	PE4750	250	62	PE4938	262	27	PE44091	258	18	PE44241	274	31
PE4607	287	82	PE4607	292	33	PE4751	250	65	PE4939	264	25	PE44092	258	15	PE44242	237	4
PE4608	288	5	PE4608	292	29	PE4752	250	61	PE4940	264	26	PE44093	258	10	PE44243	237	5
PE4609	288	99	PE4609	292	32	PE4753	250	71	PE4941	264	26	PE44094	258	10	PE44244	237	2
PE4610	288	99	PE4610	292	32	PE4754	250	69	PE4942	263	4	PE44095	258	11	PE44245	237	8
PE4611	288	44	PE4611	292	36	PE4755	250	68	PE4943	263	89	PE44096	258	85	PE44246	237	9
PE4612	288	44	PE4612	292	35	PE4756	250	68	PE4944	263	89	PE44097	258	85	PE44247	237	9
PE4613	288	44	PE4613	292	36	PE4757	250	69	PE4945	263	89	PE44098	258	85	PE44248	237	9
PE4614	288	44	PE4614	292	36	PE4758	250	73	PE4946	264	27	PE44099	251	98	PE44249	237	6
PE4615	288	44	PE4615	292	36	PE4759	250	73	PE4947	264	27	PE44100	251	96	PE44250	237	11
PE4616	288	44	PE4616	292	36	PE4760	250	43	PE4948	264	27	PE44101	251	96	PE44251	237	11
PE4617	288	44	PE4617	292	36	PE4761	250	43	PE4949	264	27	PE44102	251	96	PE44252	237	11
PE4618	288	44	PE4618	292	36	PE4762	250	43	PE4950	264	27	PE44103	251	96	PE44253	237	11
PE4619	288	44	PE4619	292	36	PE4763	250	43	PE4951	264	27	PE44104	251	96	PE44254	237	11
PE4620	288	44	PE4620	292	36	PE4764	250	43	PE4952	264	27	PE44105	251	96	PE44255	237	11
PE4621	288	44	PE4621	292	36	PE4765	250	43	PE4953	264	27	PE44106	251	96	PE44256	237	11
PE4622	288	44	PE4622	292	36	PE4766	250	43	PE4954	264	27	PE44107	251	96	PE44257	237	11
PE4623	288	44	PE4623	292	36	PE4767	250	43	PE4955	264	27	PE44108	251	96	PE44258	237	11
PE4624	288	44	PE4624	292	36	PE4768	250	43	PE4956	264	27	PE44109	251	96	PE44259	237	11
PE4625	288	44	PE4625	292	36	PE4769	250	43	PE4957	264	27	PE44110	251	96	PE44260	237	11
PE4626	288	44	PE4626	292	36	PE4770	250	43	PE4958	264	27	PE44111	251	96	PE44261	237	11
PE4627	288	44	PE4627	292	36	PE4771	250	43	PE4959	264	27	PE44112	251	96	PE44262	237	11
PE4628	288	44	PE4628	292	36	PE4772	250	43	PE4960	264	27	PE44113	251	96	PE44263	237	11
PE4629	288	44	PE4629	292	36	PE4773	250	43	PE4961	264	27	PE44114	251	96	PE44264	237	11
PE4630	288	44	PE4630	292	36	PE4774	250	43	PE4962	264	27	PE44115	251	96	PE44265	237	11
PE4631	288	44	PE4631	292	36	PE4775	250	43	PE4963	264	27	PE44116	251	96	PE44266	237	11
PE4632	288	44	PE4632	292	36	PE4776	250	43	PE4964	264	27	PE44117	251	96	PE44267	237	11
PE4633	288	44	PE4633	292	36	PE4777	250	43	PE4965	264	27	PE44118	251	96	PE44268	237	11
PE4634	288	44	PE4634	292	36	PE4778	250	43	PE4966	264	27	PE44119	251	96	PE44269	237	11
PE4635	288	44	PE4635	292	36	PE4779	250	43	PE4967	264	27	PE44120	251	96	PE44270	237	11
PE4636	288	44	PE4636	292	36	PE4780	250	43	PE4968	264	27	PE44121	251	96	PE44271	237	11
PE4637	288	44	PE4637	292	36	PE4781	250	43	PE4969	264	27	PE44122	251	96	PE44272	237	11
PE4638	288	44	PE4638	292	36	PE4782	250	43	PE4970	264	27	PE44123	251	96	PE44273	237	11
PE4639	288	44	PE4639	292	36	PE4783	250	43	PE4971	264	27	PE44124	251	96	PE44274	237	11
PE4640	288	44	PE4640	292	36	PE4784	250	43	PE4972	264	27	PE44125	251	96	PE44275	237	11
PE4641	288	44	PE4641	292	36	PE4785	250	43	PE4973	264	27	PE44126	251	96	PE44276	237	11
PE4642	288	44	PE4642	292	36	PE4786	250	43	PE4974	264	27	PE44127	251	96	PE44277	237	11
PE4643	288	44	PE4643	292	36	PE4787	250	43	PE4975	264	27	PE44128	251	96	PE44278	237	11
PE4644	288	44	PE4644	292	36	PE4788	250	43	PE4976	264	27	PE44129	251	96	PE44279	237	11
PE4645	288	44	PE4645	292	36	PE4789	250	43	PE4977	264	27	PE44130	251	96	PE44280	237	11
PE4646	288	44	PE4646	292	36	PE4790	250	43	PE4978	264	27	PE44131	251	96	PE44281	237	11
PE4647	288	44	PE4647	292	36	PE4791	250	43	PE4979	264	27	PE44132	251	96	PE44282	237	11
PE4648	288	44	PE4648	292	36	PE4792	250	43	PE4980	264	27	PE44133	251	96	PE44283	237	11
PE4649	288	44	PE4649	292	36	PE4793	250	43	PE4981	264	27	PE44134	251	96	PE44284	237	11
PE4650	288	44	PE4650	292	36	PE4794	250	43	PE4982	264	27	PE44135	251	96	PE44285	237	11
PE4651	288	44	PE4651	292	36	PE4795	250	43	PE4983	264	27	PE44136	251	96	PE44286	237	11
PE4652	288	44	PE4652	292	36	PE4796	250	43	PE4984	264	27	PE44137	251	96	PE44287	237	11
PE4653	288	44	PE4653	292	36	PE4797	250	43	PE4985	264	27	PE44138	251	96	PE44288	237	11
PE4654	288	44	PE4654	292	36	PE4798	250	43	PE4986	264	27	PE44139	251	96	PE44289	237	11
PE4655	288	44	PE4655	292	36	PE4799	250	43	PE4987	264	27	PE44140	251	96	PE44290	237	11
PE4656	288	44	PE4656	292	36	PE4800	250	43	PE4988	264	27	PE44141	251	96	PE44291	237	11
PE4657	288	44	PE4657	292	36	PE4801	250	43	PE4989	264	27	PE44142	251	96	PE44292	237	11
PE4658	288	44	PE4658	292	36	PE4802	250	43	PE4990	264	27	PE44143	251	96	PE44293	237	11
PE4659	288	44	PE4659	292	36	PE4803	250	43	PE4991	264	27	PE44144	251	96	PE44294	237	11
PE4660	288	44	PE4660	292	36	PE4804	250	43	PE4992	264	27	PE44145	251	96	PE44295	237	11
PE4661	288	44	PE4661	292	36	PE4805	250	43	PE4993	264	27	PE44146	251	96	PE44296	237	11
PE4662	288	44	PE4662	292	36	PE4806	250	43	PE4994	264	27	PE44147	251	96	PE44297	237	11
PE4663	288	44	PE4663	292	36	PE4807	250	43	PE4995	264	27	PE44148	251	96	PE44298	237	11
PE4664	288	44	PE4664	292	36	PE4808	250	43	PE4996	264	27	PE44149	251	96	PE44299	237	11
PE4665	288	44	PE4665	292	36	PE4809	250	43	PE4997	264	27	PE44150	251	96	PE44300	237	11
PE4666	288	44	PE4666	292	36	PE4810	250	43	PE4998	264	27	PE44151	251	96	PE44301	237	11
PE4667	288	44	PE4667	292	36	PE4811	250	43	PE4999	264	27	PE44152	251	96	PE44302	237	11
PE4668	288	44	PE4668	292	36	PE4812	250	43	PE5000	264	27	PE44153	251	96	PE44303	237	11
PE4669	288	44	PE4669	292	36	PE4813	250	43	PE5001	264	27	PE44154	251	96	PE44304	237	11
PE4670	288	44	PE4670	292	36	PE4814	250	43	PE5002	264	27	PE44155	251	96	PE44305	237	11
PE4671	288	44	PE4671	292	36	PE4815	250	43	PE5003	264	27	PE44156	251	96	PE44306	237	11
PE4672	288	44	PE4672	292	36	PE4816	250	43	PE5004	264	27	PE44157	251	96	PE44307	237	11
PE4673	288	44	PE4673	292	36	PE4817	250	43	PE5005	264	27	PE44158	251	96	PE44308	237	11
PE4674	288	44	PE4674	292	36	PE4818	250	43	PE5006	264	27	PE44159	251	96	PE44309	237	11
PE4675	288	44	PE4675	292	36	PE4819	250	43	PE5007	264	27	PE44160	251	96	PE44310	237	11
PE4676	288	44	PE4676														



# PART NUMBER INDEX

Note: C/R stands for the Column and/or Row location of the specific product on a given page.

Model No.	Page C/R	Model No.	Page C/R	Model No.	Page C/R	Model No.	Page C/R	Model No.	Page C/R	Model No.	Page C/R	Model No.	Page C/R	Model No.	Page C/R								
PE4481	252	29	PE44812	286	45	PE45001	243	20	PE45274	256	46	PE45432	271	93	PE45603	241	38	PE51090	66	95	PE510M1011	64	29
PE4481C	252	30	PE44813	263	1	PE45002	261	11	PE45277	282	90	PE45433	271	93	PE45604	241	42	PE51096	62	80	PE510M1012	64	32
PE4481D	252	31	PE44814	271	65	PE45004	276	92	PE45282	271	53	PE45434	271	64	PE45605	241	45	PE51103	63	1	PE510M1013	64	16
PE4481H	252	32	PE44815	285	6	PE45005	237	18	PE45283	288	21	PE45437	286	16	PE45606	241	36	PE51107A	66	91	PE510M1014	64	15
PE4481A	252	33	PE44816	262	28	PE45008	275	53	PE45284	266	93	PE45440	269	54	PE45607	241	39	PE51119	66	90	PE510M1015	64	17
PE4481K	252	34	PE44817	270	31	PE45011	242	60	PE45285	282	96	PE45441	272	16	PE45608	241	43	PE51121	66	93	PE510M1016	64	18
PE4481B	252	35	PE44818	278	46	PE45012	275	64	PE45287	282	95	PE45442	272	32	PE45609	241	23	PE51123	66	94	PE510M1017	64	20
PE4481A	252	36	PE44819	260	67	PE45032	238	44	PE45290	282	98	PE45443	285	7	PE45610	240	99	PE51125A	66	15	PE510M1018	64	21
PE4481B	252	37	PE44820	269	53	PE45035	258	90	PE45292	272	23	PE45444	287	78	PE45611	240	2	PE51127	66	16	PE510M1019	64	19
PE4481C	252	38	PE44821	272	13	PE45036	262	59	PE45295	242	72	PE45445	286	46	PE45612	240	6	PE51129	60	26	PE510M1020	64	13
PE4481D	252	39	PE44822	270	79	PE45037	243	17	PE45296	242	73	PE45446	280	68	PE45613	240	6	PE51133	66	26	PE510M1021	64	14
PE4481E	252	40	PE44823	278	46	PE45039	273	66	PE45297	243	81	PE45447	283	63	PE45614	240	98	PE51134	66	14	PE510M1022	63	7
PE4481F	252	41	PE44824	289	27	PE45040	269	70	PE45298	242	80	PE45448	282	29	PE45615	240	1	PE51135A	66	14	PE510M1023	63	10
PE4481G	252	42	PE44825	280	49	PE45041	270	33	PE45299	242	78	PE45450	241	24	PE45616	240	3	PE51136	63	12	PE510M1024	64	22
PE4481H	252	43	PE44826	287	1	PE45042	269	56	PE45300	242	79	PE45451	241	25	PE45617	240	5	PE51142	66	6	PE510M1025	64	23
PE4481I	252	44	PE44827	284	70	PE45045	247	42	PE45301	243	85	PE45452	241	18	PE45618	240	88	PE51143	66	7	PE510M1026	64	24
PE4481J	252	45	PE44828	248	72	PE45046	244	39	PE45302	243	91	PE45453	241	17	PE45619	240	91	PE51144	66	8	PE510M1027	65	69
PE4481K	252	46	PE44829	282	38	PE45047	264	19	PE45303	243	93	PE45454	240	76	PE45620	240	94	PE51146	65	64	PE510M1028	65	73
PE4481L	252	47	PE44830	289	20	PE45048	249	4	PE45304	245	87	PE45455	240	97	PE45621	240	97	PE51152	65	77	PE510M1029	65	79
PE4481M	252	48	PE44831	286	53	PE45050	256	51	PE45306	243	86	PE45456	239	70	PE45622	240	87	PE51154	65	76	PE510M1030	65	68
PE4481N	252	49	PE44832	288	10	PE45051	256	50	PE45307	254	88	PE45457	239	69	PE45623	240	89	PE51157	65	75	PE510M1031	64	37
PE4481O	252	50	PE44833	280	13	PE45053	274	18	PE45310	245	89	PE45458	271	95	PE45624	240	92	PE51158	62	77	PE510M1032	64	38
PE4481P	252	51	PE44834	280	48	PE45054	Web		PE45311	245	90	PE45459	271	94	PE45625	240	95	PE51159	65	65	PE51PD1001	61	52
PE4481Q	252	52	PE44835	260	50	PE45055	273	80	PE45313	245	88	PE45460	269	51	PE45626	240	86	PE51160	65	66	PE51PD1002	61	51
PE4481R	252	53	PE44836	287	45	PE45054	287	43	PE45314	245	87	PE45461	289	52	PE45627	240	90	PE51161	65	67	PE51PD1003	61	50
PE4481S	252	54	PE44837	286	38	PE45056	286	32	PE45315	245	84	PE45462	272	96	PE45628	240	93	PE51164	65	81	PE51PD1004	61	47
PE4481T	252	55	PE44838	279	75	PE45057	273	85	PE45316	245	86	PE45463	272	97	PE45629	240	96	PE51165	65	82	PE51PD1005	61	48
PE4481U	252	56	PE44839	287	91	PE45061	267	15	PE45317	245	85	PE45464	272	99	PE45630	238	36	PE51166	65	80	PE51PD1006	61	49
PE4481V	252	57	PE44840	264	24	PE45086	265	58	PE45318	245	83	PE45466	272	1	PE45631	238	35	PE51167	66	81	PE51PD1007	61	34
PE4481W	252	58	PE44841	280	27	PE45086	294	92	PE45319	246	81	PE45466	272	96	PE45632	238	33	PE51171	61	39	PE51PD1008	65	35
PE4481X	252	59	PE44842	280	26	PE45114	247	43	PE45320	246	82	PE45467	241	32	PE45633	240	94	PE51177	62	88	PE51PD1009	65	36
PE4481Y	252	60	PE44843	280	26	PE45116	248	2	PE45321	246	16	PE45468	241	31	PE45634	238	73	PE51178	62	82	PE51PD1010	65	20
PE4481Z	252	61	PE44844	249	21	PE45117	292	18	PE45322	246	17	PE45469	241	32	PE45640	242	63	PE51194	65	47	PE51PD1011	65	37
PE4481A	252	62	PE44845	249	23	PE45119	277	38	PE45323	246	15	PE45470	241	28	PE45650	242	63	PE51195	65	43	PE51PD1012	65	38
PE4481B	252	63	PE44846	249	13	PE45126	261	56	PE45324	246	10	PE45471	241	33	PE45651	242	65	PE51196	65	46	PE51PD1013	65	32
PE4481C	252	64	PE44847	281	58	PE45127	281	58	PE45325	246	11	PE45472	240	80	PE45652	242	68	PE51197	65	45	PE51PD1014	65	17
PE4481D	252	65	PE44848	289	97	PE45128	282	59	PE45326	246	18	PE45473	240	81	PE45653	242	69	PE51198	65	46	PE51PD1015	65	18
PE4481E	252	66	PE44849	287	91	PE45131	288	1	PE45327	246	19	PE45474	240	83	PE45654	242	82	PE51199	65	47	PE51PD1016	65	19
PE4481F	252	67	PE44850	289	89	PE45131	249	8	PE45328	246	9	PE45475	240	84	PE45655	243	92	PE51200	64	41	PE51PD1017	65	21
PE4481G	252	68	PE44851	287	82	PE45132	287	92	PE45329	247	24	PE45476	240	81	PE45656	243	97	PE51201	65	58	PE51PD1018	65	22
PE4481H	252	69	PE44852	287	76	PE45133	264	51	PE45330	247	25	PE45477	238	30	PE45657	243	2	PE51202	65	59	PE51PD1019	65	23
PE4481I	252	70	PE44853	287	96	PE45134	272	48	PE45331	247	26	PE45478	230	87	PE45658	243	83	PE51203	65	57	PE51PD1020	65	26
PE4481J	252	71	PE44854	287	86	PE45135	270	5	PE45332	247	23	PE45479	247	23	PE45659	243	82	PE51204	65	54	PE51PD1021	65	30
PE4481K	252	72	PE44855	287	86	PE45136	272	25	PE45333	246	21	PE45480	240	82	PE45660	243	88	PE51205	65	55	PE51PD1022	65	31
PE4481L	252	73	PE44856	288	6	PE45137	271	76	PE45334	246	21	PE45481	269	89	PE45661	243	82	PE51206	65	50	PE51PD1023	65	33
PE4481M	252	74	PE44857	289	62	PE45138	272	29	PE45335	245	82	PE45482	237	20	PE45662	244	61	PE51207	65	55	PE51PD1024	65	34
PE4481N	252	75	PE44858	289	63	PE45139	270	18	PE45336	245	81	PE45483	240	12	PE45663	244	71	PE51208	65	52	PE51PD1025	65	35
PE4481O	252	76	PE44859	289	63	PE45140	269	65	PE45337	246	13	PE45484	237	21	PE45664	242	78	PE51209	65	53	PE51PD1026	65	36
PE4481P	252	77	PE44860	289	63	PE45141	272	20	PE45338	246	13	PE45485	240	13	PE45665	262	78	PE51210	65	56	PE51PD1027	65	37
PE4481Q	252	78	PE44861	289	63	PE45142	269	70	PE45339	246	9	PE45486	240	14	PE45666	262	90	PE51211	65	57	PE51PD1028	65	38
PE4481R	252	79	PE44862	289	63	PE45143	287	69	PE45340	246	20	PE45487	240	11	PE45667	264	28	PE51212	63	91	PE51PD1029	65	39
PE4481S	252	80	PE44863	289	63	PE45144	287	47	PE45341	246	95	PE45488	284	78	PE45668	266	74	PE51213	63	91	PE51PD1030	65	40
PE4481T	252	81	PE44864	289	63	PE45145	269	79	PE45342	246	96	PE45489	284	77	PE45669	266	76	PE51214	65	60	PE51PD1031	65	41
PE4481U	252	82	PE44865	289	63	PE45147	280	14	PE45343	246	97	PE45492	284	79	PE45670	266	78	PE51215	65	61	PE51PD1032	65	42
PE4481V	252	83	PE44866	289	63	PE45150	248	94	PE45344	246	98	PE45493	285	80	PE45671	266	79	PE51216	65	62	PE51PD1033	65	43
PE4481W	252	84	PE44867	289	63	PE45153	249	94	PE45345	246	99	PE45494	285	80	PE45672	266	80	PE51217	65	63	PE51PD1034	65	44
PE4481X	252	85	PE44868	289	63	PE45154	249	94	PE45346	246	92	PE45496	284	81	PE45673	239	58	PE51218	62				

# PART NUMBER INDEX

Note: C/R stands for the Column and/or Row location of the specific product on a given page.

Model No.	Page	C/R	Model No.	Page	C/R	Model No.	Page	C/R	Model No.	Page	C/R	Model No.	Page	C/R	Model No.	Page	C/R	Model No.	Page	C/R
PE6031	301	54	PE6203	345	48	PE61R1102	343	18	PE7206-30	81	24	PE7316-30	78	90	PE7388-30	78	93	PE7DA0111	72	22
PE6032	344	93	PE6204	345	49	PE61R1103	343	22	PE7206-40	81	24	PE7316-40	78	90	PE7388-40	78	93	PE7DA0112	72	23
PE6033	347	15	PE6205	345	44	PE61R1104	343	20	PE7206-50	81	24	PE7317-50	79	2	PE7389-3	78	94	PE7DA0114	72	24
PE6034	345	27	PE6206	345	46	PE61R1105	343	23	PE7206-60	81	24	PE7317-3	79	2	PE7389-6	78	94	PE7DA0115	72	25
PE6035	345	30	PE6207	345	51	PE61R1106	343	27	PE7207-3	80	13	PE7317-6	79	2	PE7389-10	78	94	PE7DA0117	72	25
PE6036	345	32	PE6208	345	52	PE61R1107	343	25	PE7207-6	80	13	PE7317-10	79	2	PE7389-15	78	94	PE7DA0121	72	26
PE6037	345	29	PE6209	345	40	PE61R1108	343	28	PE7207-10	80	13	PE7317-10	79	2	PE7389-20	78	94	PE7DA0122	72	27
PE6038	345	50	PE6210	345	42	PE61R1109	343	30	PE7207-20	80	13	PE7317-20	79	2	PE7389-30	78	94	PE7DA0123	72	28
PE6039	345	71	PE6211	345	72	PE61R1110	343	31	PE7207-30	80	13	PE7317-30	79	2	PE7389-40	78	94	PE7DA0124	72	29
PE6040	346	76	PE6212	346	75	PE61R1111	343	32	PE7207-40	80	13	PE7321-50	78	89	PE7390-1	74	37	PE7DA0125	72	30
PE6041	346	90	PE6213	345	66	PE61R1112	343	33	PE7207-50	80	13	PE7321-3	78	91	PE7390-2	74	37	PE7DA0131	72	31
PE6043	346	96	PE6214	346	70	PE61R1113	344	63	PE7207-60	80	13	PE7321-6	78	91	PE7390-3	74	37	PE7DA0200	72	32
PE6046	330	46	PE6215	346	74	PE61R1114	344	64	PE7208-30	81	25	PE7321-10	78	91	PE7390-6	74	37	PE7DA0201	72	33
PE6057	300	10	PE6216	346	78	PE61R1115	344	65	PE7208-60	81	25	PE7321-20	78	91	PE7390-10	74	37	PE7DA0202	72	34
PE6058	300	11	PE6217	345	61	PE61R1116	344	66	PE7208-10	81	25	PE7321-30	78	91	PE7390-15	74	37	PE7DA0203	72	35
PE6059	300	21	PE6218	345	62	PE61R1117	343	37	PE7208-15	81	25	PE7321-40	78	91	PE7390-20	74	37	PE7DA0204	72	36
PE6069	343	48	PE6219	346	95	PE61R1118	343	38	PE7208-20	81	25	PE7321-50	78	91	PE7390-25	74	37	PE7DA0205	72	37
PE6070	343	11	PE6220	346	98	PE61R1119	343	39	PE7208-30	81	25	PE7321-60	78	91	PE7391-1	74	40	PE7DA0206	72	38
PE6071	343	50	PE6221	346	64	PE61R1120	344	40	PE7209-30	81	25	PE7321-6	78	98	PE7391-2	74	40	PE7DA0207	72	39
PE6072	343	49	PE6222	346	99	PE61R671	344	1	PE7209-60	81	25	PE7322-10	78	98	PE7391-3	74	40	PE7DA0208	72	40
PE6073	343	53	PE6223	344	68	PE61R672	344	2	PE7210-30	81	33	PE7322-20	78	98	PE7391-6	74	40	PE7DA0209	72	41
PE6076	344	89	PE6224	346	99	PE61R675	344	98	PE7211-3	79	10	PE7322-30	78	98	PE7391-10	74	40	PE7DA0210	72	42
PE6076	344	92	PE6225	345	10	PE61R677	344	99	PE7211-6	79	10	PE7322-40	78	98	PE7391-15	74	40	PE7DA0211	72	43
PE6077	343	52	PE6226	346	2	PE7000	70	7	PE7211-10	79	10	PE7323-30	79	3	PE7391-20	74	40	PE7DA0212	72	44
PE6078	343	51	PE6227	346	3	PE7001	71	8	PE7211-20	79	10	PE7323-6	79	3	PE7391-25	74	40	PE7DA0213	72	45
PE6079	343	55	PE6228	345	73	PE7002	71	8	PE7211-30	79	10	PE7323-6	79	3	PE7391-30	74	40	PE7DA0214	72	46
PE6080	343	54	PE6229	345	73	PE7003	71	12	PE7211-40	79	10	PE7323-10	79	3	PE7392-2	76	59	PE7DA0215	72	47
PE6081	344	97	PE6230	345	69	PE7004	72	18	PE7211-50	79	10	PE7323-20	79	3	PE7392-3	76	59	PE7DA0216	72	48
PE6082	344	96	PE6231	343	15	PE7005	73	30	PE7211-60	79	10	PE7323-30	79	3	PE7392-6	76	59	PE7DA0217	72	49
PE6083	344	4	PE6232	343	15	PE7006	347	18	PE7212-6	79	10	PE7323-40	79	3	PE7392-10	76	59	PE7DA0218	72	50
PE6084	343	3	PE6233	345	89	PE7007	347	19	PE7212-10	79	10	PE7323-50	79	3	PE7392-15	76	59	PE7DA0219	72	51
PE6089	343	3	PE6234	300	20	PE7008	82	44	PE7212-20	80	14	PE7323-60	79	6	PE7392-20	76	59	PE7DA0220	72	52
PE6089	343	3	PE6235	343	46	PE7009	82	44	PE7212-30	80	14	PE7323-6	79	6	PE7392-25	76	59	PE7DA0221	72	53
PE6089	343	5	PE6236	344	69	PE7010	75	46	PE7212-40	80	14	PE7323-10	79	6	PE7393-3	77	76	PE7DA0222	72	54
PE6089	344	9	PE6237	344	69	PE7011	75	41	PE7212-50	80	14	PE7323-20	79	6	PE7393-6	77	76	PE7DA0223	72	55
PE6089	344	9	PE6238	344	67	PE7012	74	39	PE7212-60	80	14	PE7323-30	79	6	PE7393-10	77	76	PE7DA0224	72	56
PE6089	344	13	PE6239	345	89	PE7015	75	49	PE7212-6	80	14	PE7323-40	79	6	PE7393-15	77	76	PE7DA0225	72	57
PE6092	344	12	PE6240	300	20	PE7016	75	51	PE7212-10	80	14	PE7323-50	79	6	PE7393-20	77	76	PE7DA0226	72	58
PE6096	345	21	PE6241	343	46	PE7017	76	61	PE7212-20	80	14	PE7323-60	79	6	PE7394-2	78	95	PE7DA0227	72	59
PE6096	345	22	PE6242	344	69	PE7018	77	78	PE7212-30	80	14	PE7323-6	79	6	PE7394-3	78	95	PE7DA0228	72	60
PE6096	345	22	PE6243	344	67	PE7019	78	97	PE7212-40	80	14	PE7323-10	79	6	PE7394-6	78	95	PE7DA0229	72	61
PE6097	345	19	PE6244	385	3	PE7020	78	97	PE7212-50	80	14	PE7323-20	79	6	PE7394-10	78	95	PE7DA0230	72	62
PE6098	345	20	PE6245	385	3	PE7021	79	4	PE7212-60	80	14	PE7323-30	79	6	PE7394-15	78	95	PE7DA0231	72	63
PE6098	345	20	PE6246	385	3	PE7022	80	17	PE7212-6	80	14	PE7323-40	79	6	PE7394-20	78	95	PE7DA0232	72	64
PE6100	344	15	PE6247	386	16	PE7023	81	27	PE7212-10	80	14	PE7323-50	79	6	PE7394-25	78	95	PE7DA0233	72	65
PE6101	345	28	PE6248	386	18	PE7024	71	13	PE7212-20	80	14	PE7323-60	79	6	PE7394-30	78	95	PE7DA0234	72	66
PE6102	345	31	PE6249	386	23	PE7025	71	14	PE7212-30	81	26	PE7323-6	79	6	PE7395-1	71	16	PE7DA0235	72	67
PE6103	345	33	PE6250	386	32	PE7026	75	45	PE7212-40	81	26	PE7323-10	79	6	PE7395-2	71	16	PE7DA0236	72	68
PE6104	345	34	PE6251	386	32	PE7027	80	52	PE7212-50	81	26	PE7323-20	79	6	PE7395-3	71	16	PE7DA0237	72	69
PE6105	345	36	PE6252	386	37	PE7028	347	26	PE7212-60	81	26	PE7323-30	79	6	PE7395-4	71	16	PE7DA0238	72	70
PE6106	345	45	PE6253	386	38	PE7029	347	26	PE7213-6	81	26	PE7323-40	79	6	PE7395-5	71	16	PE7DA0239	72	71
PE6107	345	40	PE6254	386	39	PE7030	347	26	PE7213-10	81	26	PE7323-50	79	6	PE7395-6	71	16	PE7DA0240	72	72
PE6108	300	15	PE6255	386	24	PE7031	82	39	PE7213-20	81	26	PE7323-60	79	6	PE7395-7	71	16	PE7DA0241	72	73
PE6109	300	17	PE6256	385	93	PE7032	82	40	PE7213-30	81	26	PE7323-6	79	6	PE7395-8	71	16	PE7DA0242	72	74
PE6110	300	18	PE6257	385	1	PE7033	84	55	PE7213-40	81	26	PE7323-10	79	6	PE7395-9	71	16	PE7DA0243	72	75
PE6111	300	22	PE6258	385	60	PE7034	84	55	PE7213-50	81	26	PE7323-20	79	6	PE7395-10	71	16	PE7DA0244	72	76
PE6113	300	22	PE6259	386	21	PE7035	84	60	PE7213-60	81	26	PE7323-30	79	6	PE7395-15	71	16	PE7DA0245	72	77
PE6114	300	23	PE6260	386	29	PE7036	74	36	PE7213-10	81	30	PE7323-40	79	6	PE7395-20	71	16	PE7DA0246	72	78
PE6115	300	24	PE6261	386	29	PE7037	75	44	PE7213-20	81	30	PE7323-50	79	6	PE7395-25	71	16	PE7DA0247	72	79
PE6116	300	28	PE6262	385	9	PE7038	76	55	PE7213-30	81	30	PE7323-60	79	6	PE7395-30	71	16	PE7DA0248	72	80
PE6117	301	29	PE6263	386	22	PE7039	77	64	PE7213-40	81	30	PE7323-6	79	6	PE7395-35	71	16	PE7DA0249	72	81
PE6118	301	30	PE6264	386	22	PE7040	79	49	PE7213-50	81	30	PE7323-10	79	6	PE7395-40	71	16	PE7DA0250	72	82
PE6119	301	33	PE6265	386	31	PE7041	79	49	PE7213-60	81	30	PE7323-20	79	6	PE7395-45	71	16	PE7DA0251	72	83
PE6120	301	34	PE6266	386	35	PE7042	72	19	PE7213-10	81	30	PE7323-30	79	6	PE7395-50	71	16	PE7DA0252	72	84
PE6121	301	35	PE6267	386	37	PE7043	72	19	PE7213-20	81	30	PE7323-40	79	6	PE7395-55	71	16	PE7DA0253	72	85
PE6122	3																			

# PART NUMBER INDEX

Note: C/R stands for the Column and/or Row location of the specific product on a given page.

Model No.	Page C/R	Model No.	Page C/R	Model No.	Page C/R	Model No.	Page C/R	Model No.	Page C/R	Model No.	Page C/R	Model No.	Page C/R	Model No.	Page C/R		
PE715S002	335	98	PE715S240	332	11	PE715S387	328	88	PE715S1036	323	14	PE87028	314	86	PE87011	308	16
PE715S003	335	1	PE715S241	332	5	PE715S388	327	30	PE715S1037	322	70	PE87027	314	87	PE87020	308	22
PE715S004	335	2	PE715S242	333	38	PE715S389	327	31	PE715S1038	323	86	PE87028	314	88	PE87021	308	23
PE715S005	335	96	PE715S243	333	41	PE715S390	328	89	PE715S1039	323	83	PE87029	314	89	PE87022	308	8
PE715S006	335	99	PE715S244	333	43	PE715S391	326	7	PE715S1040	322	80	PE87030	314	90	PE87023	308	9
PE715S052	330	36	PE715S245	333	44	PE715S392	326	8	PE715S1041	322	8	PE87031	314	91	PE87024	308	10
PE715S053	330	37	PE715S246	333	45	PE715S393	326	9	PE715S1042	323	7	PE87032	314	92	PE87025	308	11
PE715S054	330	38	PE715S247	333	46	PE715S394	326	9	PE715S1043	323	6	PE87033	314	93	PE87026	308	12
PE715S055	330	39	PE715S248	333	42	PE715S395	326	92	PE715S1044	323	12	PE87034	314	94	PE87027	308	13
PE715S056	330	50	PE715S249	333	58	PE715S396	326	93	PE715S1045	323	5	PE87035	314	95	PE87028	308	14
PE715S057	330	51	PE715S250	333	61	PE715S397	326	88	PE715S1046	322	65	PE87036	314	96	PE87029	308	15
PE715S058	324	19	PE715S251	333	63	PE715S398	326	89	PE715S1047	322	69	PE87037	314	97	PE87030	308	16
PE715S059	325	20	PE715S252	333	64	PE715S399	326	94	PE715S1048	322	69	PE87038	314	98	PE87031	308	17
PE715S060	326	9	PE715S253	333	65	PE715S400	327	32	PE715S1049	322	67	PE87039	314	99	PE87032	308	18
PE715S063	327	14	PE715S254	333	66	PE715S401	329	13	PE715S1050	322	72	PE87040	314	100	PE87033	308	19
PE715S064	328	63	PE715S255	333	62	PE715S402	329	12	PE715S1051	322	78	PE87041	314	101	PE87034	308	20
PE715S065	328	78	PE715S256	331	80	PE715S403	326	97	PE715S1052	323	1	PE87042	314	102	PE87035	308	21
PE715S066	328	79	PE715S257	331	86	PE715S404	327	12	PE715S1053	323	1	PE87043	314	103	PE87036	308	22
PE715S067	328	81	PE715S258	331	87	PE715S405	329	13	PE715S1054	323	20	PE87044	314	104	PE87037	308	23
PE715S068	328	82	PE715S259	331	91	PE715S406	329	14	PE715S1055	323	19	PE87045	314	105	PE87038	308	24
PE715S069	328	80	PE715S260	331	92	PE715S407	329	15	PE715S1056	323	21	PE87046	314	106	PE87039	308	25
PE715S070	328	77	PE715S261	331	93	PE715S408	327	16	PE715S1057	322	68	PE87047	314	107	PE87040	308	26
PE715S071	328	83	PE715S262	331	87	PE715S409	327	20	PE715S1058	322	68	PE87048	314	108	PE87041	308	27
PE715S072	326	99	PE715S263	332	18	PE715S410	330	58	PE715S1059	322	78	PE87049	314	109	PE87042	308	28
PE715S073	326	97	PE715S264	332	35	PE715S411	330	59	PE715S1060	322	78	PE87050	314	110	PE87043	308	29
PE715S074	329	6	PE715S265	332	36	PE715S412	330	58	PE715S1061	322	74	PE87051	314	111	PE87044	308	30
PE715S075	329	11	PE715S266	332	37	PE715S413	330	59	PE715S1062	322	74	PE87052	314	112	PE87045	308	31
PE715S076	327	27	PE715S267	332	31	PE715S414	330	60	PE715S1063	322	74	PE87053	314	113	PE87046	308	32
PE715S077	329	7	PE715S268	332	37	PE715S415	330	60	PE715S1064	322	74	PE87054	314	114	PE87047	308	33
PE715S078	328	71	PE715S269	333	47	PE715S416	330	62	PE715S1065	322	74	PE87055	314	115	PE87048	308	34
PE715S079	327	56	PE715S270	333	52	PE715S417	330	61	PE715S1066	322	74	PE87056	314	116	PE87049	308	35
PE715S080	326	25	PE715S271	333	53	PE715S418	330	61	PE715S1067	322	74	PE87057	314	117	PE87050	308	36
PE715S082	326	2	PE715S272	333	54	PE715S419	330	61	PE715S1068	322	74	PE87058	314	118	PE87051	308	37
PE715S083	327	28	PE715S273	333	54	PE715S420	327	35	PE715S1069	322	74	PE87059	314	119	PE87052	308	38
PE715S084	328	70	PE715S274	333	54	PE715S421	327	36	PE715S1070	322	74	PE87060	314	120	PE87053	308	39
PE715S085	329	35	PE715S275	333	55	PE715S422	327	43	PE715S1071	322	74	PE87061	314	121	PE87054	308	40
PE715S086	328	70	PE715S276	333	51	PE715S423	327	52	PE715S1072	322	74	PE87062	314	122	PE87055	308	41
PE715S087	329	35	PE715S277	333	69	PE715S424	327	53	PE715S1073	322	74	PE87063	314	123	PE87056	308	42
PE715S088	330	47	PE715S278	333	72	PE715S425	326	86	PE715S1074	322	74	PE87064	314	124	PE87057	308	43
PE715S089	330	49	PE715S279	333	74	PE715S426	326	86	PE715S1075	322	74	PE87065	314	125	PE87058	308	44
PE715S090	330	56	PE715S280	333	76	PE715S427	327	54	PE715S1076	322	74	PE87066	314	126	PE87059	308	45
PE715S092	325	63	PE715S281	333	78	PE715S428	327	55	PE715S1077	322	74	PE87067	314	127	PE87060	308	46
PE715S093	325	65	PE715S282	333	79	PE715S429	326	3	PE715S1078	322	74	PE87068	314	128	PE87061	308	47
PE715S094	325	67	PE715S283	333	73	PE715S430	327	37	PE715S1079	322	74	PE87069	314	129	PE87062	308	48
PE715S095	325	66	PE715S284	333	77	PE715S431	326	67	PE715S1080	322	74	PE87070	314	130	PE87063	308	49
PE715S096	325	68	PE715S285	333	78	PE715S432	326	74	PE715S1081	322	74	PE87071	314	131	PE87064	308	50
PE715S097	326	79	PE715S286	334	88	PE715S433	326	29	PE715S1082	322	74	PE87072	314	132	PE87065	308	51
PE715S123	326	80	PE715S287	334	89	PE715S434	326	92	PE715S1083	322	74	PE87073	314	133	PE87066	308	52
PE715S130	325	59	PE715S288	334	91	PE715S435	326	84	PE715S1084	322	74	PE87074	314	134	PE87067	308	53
PE715S131	325	60	PE715S289	334	92	PE715S436	326	4	PE715S1085	322	74	PE87075	314	135	PE87068	308	54
PE715S137	326	73	PE715S290	334	93	PE715S437	327	44	PE715S1086	322	74	PE87076	314	136	PE87069	308	55
PE715S140	326	74	PE715S291	334	95	PE715S438	327	85	PE715S1087	322	74	PE87077	314	137	PE87070	308	56
PE715S143	326	78	PE715S292	334	90	PE715S439	326	10	PE715S1088	322	74	PE87078	314	138	PE87071	308	57
PE715S146	326	78	PE715S293	334	90	PE715S440	326	14	PE715S1089	322	74	PE87079	314	139	PE87072	308	58
PE715S155	326	27	PE715S294	334	92	PE715S441	326	15	PE715S1090	322	74	PE87080	314	140	PE87073	308	59
PE715S156	325	24	PE715S300	334	99	PE715S442	326	16	PE715S1091	322	74	PE87081	314	141	PE87074	308	60
PE715S157	325	25	PE715S301	334	99	PE715S443	326	62	PE715S1092	322	74	PE87082	314	142	PE87075	308	61
PE715S158	325	26	PE715S302	334	99	PE715S444	326	61	PE715S1093	322	74	PE87083	314	143	PE87076	308	62
PE715S159	325	23	PE715S303	334	99	PE715S445	326	30	PE715S1094	322	74	PE87084	314	144	PE87077	308	63
PE715S160	324	17	PE715S304	334	99	PE715S446	326	30	PE715S1095	322	74	PE87085	314	145	PE87078	308	64
PE715S161	324	18	PE715S305	334	99	PE715S447	326	46	PE715S1096	322	74	PE87086	314	146	PE87079	308	65
PE715S162	325	28	PE715S310	334	99	PE715S448	326	21	PE715S1097	322	74	PE87087	314	147	PE87080	308	66
PE715S163	325	29	PE715S313	334	99	PE715S449	326	22	PE715S1098	322	74	PE87088	314	148	PE87081	308	67
PE715S164	325	29	PE715S314	334	99	PE715S450	326	22	PE715S1099	322	74	PE87089	314	149	PE87082	308	68
PE715S165	325	35	PE715S315	334	99	PE715S451	326	28	PE715S1100	322	74	PE87090	314	150	PE87083	308	69
PE715S166	325	35	PE715S316	334	99	PE715S452	326	48	PE715S1101	322	74	PE87091	314	151	PE87084	308	70
PE715S167	325	36	PE715S317	334	99	PE715S453	326	49	PE715S1102	322	74	PE87092	314	152	PE87085	308	71
PE715S168	325	30	PE715S318	334	99	PE715S454	326	57	PE715S1103	322	74	PE87093	314	153	PE87086	308	72
PE715S169	325	31	PE715S319	334	99	PE715S455	326	58	PE715S1104	322	74	PE87094	314	154	PE87087	308	73
PE715S170	325	43	PE715S320	334	99	PE715S456	326	58	PE715S1105	322	74	PE87095	314	155	PE87088	308	74
PE715S171	325	40	PE715S321	334	99	PE715S457	326	68	PE715S1106	322	74	PE87096	314	156	PE87089	308	75



# PART NUMBER INDEX

Note: C/R stands for the Column and/or Row location of the specific product on a given page.

Model No.	Page	C/R	Model No.	Page	C/R	Model No.	Page	C/R	Model No.	Page	C/R	Model No.	Page	C/R	Model No.	Page	C/R	Model No.	Page	C/R			
PE9088	44	E3	PE9251	40	E3	PE9395	42	B6	PE9542	44	D2	PE9692	36	C2	PE9851B-20	361	80	PE91038	23	B7	PE91219	22	E5
PE9099	43	C4	PE9252	39	C3	PE9396	46	B5	PE9543	44	C2	PE9693	38	C1	PE9852B/2F-10	360	7	PE91039	23	E4	PE91222	24	C5
PE9100	43	C3	PE9253	38	C6	PE9397	46	B7	PE9544	44	E4	PE9694	34	C4	PE9852B-10	361	81	PE91040	29	B7	PE91227	23	D4
PE9101	30	A4	PE9255	38	D6	PE9398	27	D7	PE9545	44	D4	PE9695	34	E7	PE9852B/2F-15	360	8	PE91042	38	A4	PE91228	23	B5
PE9102	30	C2	PE9256	36	C6	PE9399	40	B2	PE9546	34	B4	PE9696	26	E7	PE9852B-15	361	82	PE91044	26	C3	PE91229	23	D6
PE9103	34	E3	PE9257	31	A4	PE9400	37	E7	PE9547	30	B1	PE9697	27	B1	PE9852B/2F-20	360	83	PE91045	36	C5	PE91230	23	C7
PE9104	33	C3	PE9258	32	E4	PE9401	37	D1	PE9548	30	B1	PE9698	27	C1	PE9852B-20	361	83	PE91046	38	B3	PE91231	23	D3
PE9105	37	A3	PE9259	36	A6	PE9402	37	C2	PE9550	31	E7	PE9699	44	D1	PE9853B/SF-10	360	10	PE91048	19	B6	PE91233	22	A4
PE9106	25	C7	PE9260	38	B6	PE9403	33	D5	PE9551	39	C2	PE9700	44	E1	PE9853B-10	361	84	PE91049	39	B6	PE91234	22	C4
PE9108	41	A7	PE9261	32	D3	PE9404	33	C6	PE9552	33	A2	PE9701	45	B1	PE9853B/SF-15	360	11	PE91050	39	C6	PE91235	23	D5
PE9109	26	A2	PE9263	33	C1	PE9405	33	A6	PE9553	32	C5	PE9703	38	E5	PE9853B-15	361	85	PE91051	39	A1	PE91236	23	A7
PE9111	32	C1	PE9264	27	C6	PE9406	26	D2	PE9554	31	B4	PE9704	31	E3	PE9853B-20	361	86	PE91052	39	C7	PE91237	30	E2
PE9112	32	D2	PE9265	28	C5	PE9407	27	C5	PE9555	23	A7	PE9705	28	E7	PE9853B/NF-10	360	12	PE91054	39	B7	PE91238	30	D6
PE9113	32	B1	PE9266	28	A6	PE9408	39	B4	PE9557	39	B4	PE9706	29	A1	PE9854B/SF-10	360	15	PE91055	19	C7	PE91239	43	B1
PE9114	44	B7	PE9267	28	C4	PE9409	23	E6	PE9558	24	E2	PE9707	36	E5	PE9854B-10	361	87	PE91056	39	D6	PE91240	43	B2
PE9116	41	A2	PE9268	28	D4	PE9411	36	D4	PE9559	24	C6	PE9708	38	A6	PE9854B/NF-15	360	13	PE91057	39	C7	PE91241	43	B4
PE9117	41	B1	PE9269	25	C5	PE9413	28	C1	PE9560	43	E1	PE9709	29	B1	PE9854B/SF-15	360	18	PE91058	39	D7	PE91242	43	E5
PE9118	41	A4	PE9270	43	E2	PE9414	23	C7	PE9561	43	B3	PE9710	29	D1	PE9854B-15	361	88	PE91059	40	B1	PE91243	24	C1
PE9119	41	A3	PE9271	41	A3	PE9415	40	B4	PE9562	44	O1	PE9711	27	D1	PE9854B/NF-20	360	18	PE91060	21	B2	PE91244	24	A8
PE9120	41	C1	PE9275	39	D2	PE9416	46	A4	PE9563	44	B2	PE9712	27	E1	PE9854B/SF-20	360	17	PE91061	39	E7	PE91245	24	E4
PE9122	41	C2	PE9276	40	A4	PE9417	46	A4	PE9564	44	B4	PE9713	44	A2	PE9854B-20	361	89	PE91062	37	E5	PE91246	24	B4
PE9123	32	A3	PE9277	32	D6	PE9418	34	D2	PE9565	31	A2	PE9714	44	C4	PE9855B/NF-10	360	19	PE91063	37	B5	PE91247	24	B5
PE9125	31	C4	PE9278	31	D2	PE9419	27	E7	PE9566	32	E2	PE9715	18	D3	PE9855B/SF-10	360	21	PE91064	40	D1	PE91248	24	B3
PE9126	27	D5	PE9280	48	B2	PE9420	25	E6	PE9567	27	C5	PE9716	18	B3	PE9855B-10	361	90	PE91065	42	E2	PE91249	24	D3
PE9127	31	D1	PE9281	45	E1	PE9421	25	E6	PE9568	33	A7	PE9718	18	D6	PE9855B/NF-15	360	18	PE91066	40	A1	PE91250	24	A8
PE9128	30	C4	PE9282	41	B7	PE9429	30	B5	PE9569	27	C7	PE9719	18	E5	PE9855B/SF-15	360	20	PE91068	42	B1	PE91251	24	E6
PE9129	27	D6	PE9283	41	C7	PE9431	37	A2	PE9570	31	D5	PE9720	18	A7	PE9855B-15	361	91	PE91069	28	B6	PE91252	24	D7
PE9130	31	B7	PE9284	41	C6	PE9432	39	B3	PE9571	33	B7	PE9721	18	B7	PE9855B/NF-20	360	19	PE91070	20	A4	PE91254	22	C5
PE9131	33	D1	PE9285	27	C2	PE9433	37	D2	PE9572	33	E5	PE9722	36	A4	PE9855B/SF-20	360	21	PE91072	42	C1	PE91255	22	D6
PE9132	41	C3	PE9286	27	B2	PE9434	39	A4	PE9573	33	D6	PE9724	38	E2	PE9855B-20	361	92	PE91073	44	C5	PE91256	22	A6
PE9136	41	E1	PE9287	45	A6	PE9435	39	C4	PE9574	37	E4	PE9725	38	A3	PE9855B/NF-10	360	19	PE91080	47	C7	PE91258	35	B9
PE9138	43	D3	PE9288	43	B6	PE9436	43	D3	PE9575	19	C7	PE9726	38	C1	PE9855B/SF-10	360	25	PE91081	47	B7	PE91259	35	E4
PE9137	41	A3	PE9290	43	D3	PE9437	19	E7	PE9576	27	E3	PE9727	36	E2	PE9856B-10	361	93	PE91082	48	A1	PE91260	26	E5
PE9138	41	D6	PE9291	44	B3	PE9438	20	C1	PE9577	27	D3	PE9728	36	A3	PE9856B/NF-15	360	23	PE91083	47	E7	PE91261	26	D7
PE9139	41	E5	PE9292	32	E6	PE9439	37	A7	PE9578	27	B4	PE9729	38	E1	PE9856B/SF-15	360	26	PE91084	47	E3	PE91262	35	D6
PE9140	41	E6	PE9293	26	E5	PE9440	40	B3	PE9579	27	E5	PE9730	33	B3	PE9856B-15	361	94	PE91085	18	A3	PE91263	35	C5
PE9141	41	E4	PE9294	26	E5	PE9442	40	B3	PE9580	43	C1	PE9731	33	C3	PE9856B/NF-20	360	19	PE91086	47	C7	PE91264	35	B9
PE9142	39	A3	PE9295	32	B4	PE9443	43	A3	PE9581	40	A5	PE9732	38	D7	PE9856B/SF-20	360	27	PE91087	44	A6	PE91265	35	E5
PE9143	39	A5	PE9296	27	A6	PE9444	43	E4	PE9582	46	A6	PE9733	40	C6	PE9856B-20	361	95	PE91088	24	D1	PE91266	35	A6
PE9144	37	E3	PE9297	28	E3	PE9445	43	D1	PE9583	47	C1	PE9734	45	A6	PE9857B/NF-10	360	28	PE91090	24	C4	PE91267	35	B6
PE9145	37	A4	PE9298	32	E5	PE9446	31	E1	PE9584	46	E5	PE9735	47	C4	PE9857B/SF-10	360	30	PE91091	24	A5	PE91268	35	A7
PE9146	39	B5	PE9299	31	D4	PE9449	33	C1	PE9585	47	B1	PE9736	47	A4	PE9857B-10	361	96	PE91092	22	A5	PE91269	36	C1
PE9147	39	B5	PE9300	26	D3	PE9450	33	C2	PE9586	46	A5	PE9738	46	A5	PE9857B/NF-15	360	28	PE91093	22	E6	PE91270	36	A8
PE9148	39	B5	PE9301	41	B7	PE9451	18	E7	PE9587	47	E1	PE9739	46	A5	PE9857B/SF-15	361	97	PE91094	22	E6	PE91271	36	A8
PE9149	37	C4	PE9302	41	B2	PE9452	18	E7	PE9588	47	D1	PE9740	46	D7	PE9857B-15	361	97	PE91095	22	E6	PE91272	36	A8
PE9150	26	C2	PE9303	41	E4	PE9453	19	C1	PE9593	36	A1	PE9741	45	B7	PE9857B/NF-20	360	29	PE91099	42	D1	PE91274	21	C5
PE9151	26	B4	PE9304	41	B5	PE9454	20	D6	PE9594	35	C7	PE9742	45	C6	PE9857B/SF-20	360	31	PE91101	42	E1	PE91298	20	B3
PE9152	26	B2	PE9305	41	C4	PE9455	20	E3	PE9595	30	A2	PE9743	45	D6	PE9857B-20	361	98	PE91102	42	E1	PE91299	38	B7
PE9153	26	C4	PE9306	46	E2	PE9456	20	A7	PE9596	40	B6	PE9744	45	C7	PE9858B/NF-10	360	32	PE91103	36	E7	PE91300	38	E7
PE9154	26	B3	PE9307	40	C3	PE9457	20	C3	PE9597	40	B6	PE9745	45	E5	PE9858B/SF-10	360	32	PE91104	36	E7	PE91301	38	E7
PE9155	26	D3	PE9308	46	B3	PE9458	19	C3	PE9598	40	D6	PE9746	21	A5	PE9858B-10	361	99	PE91105	48	D5	PE91302	36	A7
PE9158	26	D4	PE9309	41	D1	PE9460	20	A5	PE9599	40	E6	PE9747	18	C5	PE9858B/NF-15	360	32	PE91106	48	B5	PE91303	36	B7
PE9160	45	A5	PE9310	41	B1	PE9461	21	A1	PE9600	40	B5	PE9748	21	A7	PE9858B/SF-15	360	34	PE91107	48	C5	PE91304	36	D7
PE9163	45	E7	PE9311	29	E7	PE9462	32	B6	PE9602	40	C5	PE9749	33	D7	PE9858B-15	361	1	PE91108	18	B2	PE91305	39	D5
PE9164	45	E5	PE9312	35	C3	PE9463	32	A6	PE9603	40	D5	PE9750	25	B2	PE9858B/NF-20	360	33	PE91109	18	D2	PE91306	39	E5
PE9168	45	C5	PE9313	34	A5	PE9464	32	A6	PE9604	40	D5	PE9751	25	B2	PE9858B/SF-20	360	33	PE91110	18	D2	PE91307	39	E5
PE9166	45	E5	PE9314	31	C6	PE9465	31	E4	PE9605	40	A7	PE9752	25	C2	PE9858B-20	361	2	PE91113	20	A2	PE91308	40	C1
PE9167	45	A2	PE9315	32	C7	PE9466	28	B3	PE9606	40	D7	PE9753	25	E1	PE9858B/NF-10	360	36	PE91114	29	C7	PE91309	37	D4
PE9169	48	C4	PE9316	32	B7	PE9467	28	E2	PE9607	40	C7	PE9754	25	D2	PE9858B/SF-10	360	38	PE91115	18	A4	PE91310	37	E4
PE9171	26	B2	PE9317	31	A7	PE9468	28	A3	PE9608	46	D1	PE9755	25	A2	PE9859B-10	361	4	PE91117	23	E5	PE91311	37	A5
PE9172	25	E7	PE9318	31	E6	PE9469	28	D2	PE9609	46	B1	PE9756	25	A1	PE9859B/NF-15	360	37	PE91118	18	A2	PE91312	37	



# PART NUMBER INDEX

Note: C/R stands for the Column and/or Row location of the specific product on a given page.

Model No.	Page	C/R	Model No.	Page	C/R	Model No.	Page	C/R	Model No.	Page	C/R	Model No.	Page	C/R	Model No.	Page	C/R	Model No.	Page	C/R	Model No.	Page	C/R
PE31463	18	D1	PEW137FS7	389	65	PEWAN1042	362	43	PEWCA008	366	99	PEWCP1018	372	46	PEWCT1081	375	72	PEWGS8018	378	70	PEWSP1008	384	52
PE31464	23	B1	PEW137SP7	389	66	PEWAN1043	362	44	PEWCA1009	366	91	PEWCP1019	372	48	PEWCT1082	375	74	PEWGS8019	378	72	PEWSP1009	385	60
PE31465	22	D7	PEW159FS7	389	67	PEWAN1044	362	45	PEWCA1010	367	32	PEWCP1020	372	45	PEWCT1083	375	68	PEWGS8020	378	83	PEWSP1010	385	61
PE31466	22	B7	PEW159SP7	389	68	PEWAN1045	362	38	PEWCA1011	367	28	PEWCP1021	372	47	PEWCT1084	375	71	PEWGS8021	378	85	PEWSP1011	385	68
PE31467	22	E7	PEW15A001	385	18	PEWAN1046	362	39	PEWCA1012	367	31	PEWCP1022	372	49	PEWCT1085	375	67	PEWGS8022	378	82	PEWSP1012	385	69
PE31468	24	B7	PEW15FS7	388	18	PEWAN1047	362	40	PEWCA1013	367	26	PEWCP1023A	372	50	PEWCT1086	375	67	PEWGS8023	378	84	PEWTR1000	385	90
PE31469	24	C2	PEW15S010-12	384	8	PEWAN1048	362	38	PEWCA1014	367	47	PEWCP1024	372	52	PEWCT1087	375	69	PEWGS8024	378	87	PEWTR1001	385	90
PE31470	24	C5	PEW15SP4	388	18	PEWAN1049	362	30	PEWCA1015	367	46	PEWCP1025	372	54	PEWCT1088	375	75	PEWGS8025	378	89	PEWTR1002	385	6
PE31471	24	A6	PEW15TR0001	385	84	PEWAN1050	362	31	PEWCA1016	367	47	PEWCP1026	372	51	PEWCT1089	375	79	PEWGS8026	378	86	PEWTR1003	385	12
PE31472	24	D5	PEW187FS7	389	69	PEWAN1051	362	32	PEWCA1017	367	44	PEWCP1027	372	53	PEWCT1090	375	83	PEWGS8027	378	88	PEWTR1004	386	14
PE31473	24	B6	PEW187SP7	389	70	PEWAN1052	362	33	PEWCA1018	367	47	PEWCP1028	372	57	PEWCT1091	375	87	PEWGS8028	378	95	PEWTR1005	386	20
PE31474	23	B2	PEW19FS7	388	19	PEWAN1053	362	34	PEWCA1019	367	48	PEWCP1029	372	56	PEWCT1092	375	76	PEWGS8029	378	97	PEWTR1006	386	26
PE31475	23	E3	PEW19S010-12	384	10	PEWAN1054	362	36	PEWCA1020	367	35	PEWCP1030	372	58	PEWCT1093	375	80	PEWGS8030	378	99	PEWTR1007	386	27
PE31476	23	E1	PEW19S10-3	384	10	PEWAN1055	362	36	PEWCA1021	367	42	PEWCP1031	372	60	PEWCT1094	375	84	PEWGS8031	378	96	PEWTR1008	386	33
PE31477	23	C2	PEW19SP4	388	20	PEWAN1056	362	37	PEWCA1022	367	52	PEWCP1032	372	57	PEWCT1095	375	88	PEWGS8032	378	91	PEWTR1009	386	34
PE31478	23	D2	PEW19TR0001	385	85	PEWAN1057	362	26	PEWCA1023	366	66	PEWCP1033	372	59	PEWCT1096	375	77	PEWGS8033	378	92	PEWTR1010	386	36
PE31479	23	C3	PEW22B10	369	42	PEWAN1058	362	27	PEWCA1024	366	78	PEWCP1034	372	61	PEWCT1097	375	81	PEWGS8034	378	90	PEWTR1011A	386	37
PE31480	23	A2	PEW22B10	369	43	PEWAN1059	362	28	PEWCA1025	366	97	PEWCP1035	372	62	PEWCT1098	375	85	PEWGS8035	378	93	PEWTR10100	387	69
PE31481	23	D3	PEW22CA10	369	41	PEWAN1060	362	29	PEWCA1026	366	48	PEWCP1036	372	63	PEWCT1099	375	89	PEWGS8036	378	75	PEWTR10011	387	70
PE31482	23	A4	PEW22CP10-20	371	21	PEWAN1061	362	22	PEWCA1027	366	58	PEWCP1037	372	64	PEWCT1080	375	78	PEWGS8037	378	77	PEWTR10022	387	67
PE31483	23	E2	PEW22FS3	388	21	PEWAN1062	362	23	PEWCA1028	366	65	PEWCP1038	372	65	PEWCT1081	375	82	PEWGS8038	378	74	PEWTR10033	387	68
PE31484	23	B3	PEW22S010-3	384	17	PEWAN1063	362	24	PEWCA1029	366	76	PEWCP1039	372	66	PEWCT1082	375	86	PEWGS8039	378	76	PEWTR10044	387	65
PE31487	44	C6	PEW22SP4	388	22	PEWAN1064	362	25	PEWCA1030	366	98	PEWCP1040	372	67	PEWCT1083	375	90	PEWGS8040	377	47	PEWTR1005A	387	66
PE31492	34	E4	PEW22T0001	387	86	PEWAN1065	362	18	PEWCA1031	366	85	PEWCP1041	372	68	PEWCT1084	375	91	PEWGS8041	377	49	PEWTR10068	387	64
PE31493	34	E4	PEW24FS3	389	71	PEWAN1066	362	19	PEWCA1032	366	97	PEWCP1042	372	69	PEWCT1085	375	95	PEWGS8042	377	51	PEWTR1007A	387	64
PE31494	35	A1	PEW28ASB	388	72	PEWAN1067	362	20	PEWCA1033	366	87	PEWCP1043	372	70	PEWCT1086	375	99	PEWGS8043	377	48	PEWTR10088	386	62
PE31495	35	B1	PEW28CP10-20	372	25	PEWAN1068	362	21	PEWCA1034	366	92	PEWCP1044	373	71	PEWCT1087	375	4	PEWGS8044	379	20	PEWTR1010	386	61
PE31496	34	B2	PEW28FS3	388	25	PEWAN1069	362	58	PEWCA1035	366	89	PEWCP1045	373	72	PEWCT1088	375	92	PEWGS8045	379	22	RG108AU	230	30
PE31497	34	C2	PEW28S010-3	384	22	PEWAN1070	362	59	PEWCA1036	366	93	PEWCP1046	373	73	PEWCT1089	375	96	PEWGS8046	379	23	RG11AU	226	10
PE31498	19	B1	PEW28S10-6	384	23	PEWAN1071	362	56	PEWCA1037	366	11	PEWCP1047	373	74	PEWCT1090	375	1	PEWGS8047	379	21	RG141AU	227	55
PE31499	20	B2	PEW28T0001	388	26	PEWAN1072	362	57	PEWCA1038	366	13	PEWCP1048	373	75	PEWCT1091	375	5	PEWGS8048	379	24	RG142AU	226	56
PE31500	20	B3	PEW28T1000	388	27	PEWAN1073	362	54	PEWCA1039	366	14	PEWCP1049	373	76	PEWCT1092	375	93	PEWGS8049	379	26	RG174AU	225	57
PE31503	20	A1	PEW340FS10	389	73	PEWAN1074	362	55	PEWCA1040	367	30	PEWCP1050	373	77	PEWCT1093	375	97	PEWGS8050	379	23	RG178AU	228	58
PE31504	34	E6	PEW340SP10	389	74	PEWAN1075	362	70	PEWCA1041	367	29	PEWCP1051	373	79	PEWCT1094	375	2	PEWGS8051	379	25	RG179AU	226	11
PE31505	43	C2	PEW34FS4	388	27	PEWAN1076	362	72	PEWCA1042	367	24	PEWCP1052A	373	80	PEWCT1095	375	6	PEWGS8052	378	99	RG180AU	228	59
PE31506	33	B1	PEW34SP4	388	28	PEWAN1077	362	71	PEWCA1043	367	23	PEWCP1053	373	81	PEWCT1096	375	94	PEWGS8053	378	18	RG181AU	226	12
PE31507	19	A3	PEW34B10	370	47	PEWAN1078	362	63	PEWCA1044	367	25	PEWCP1054	373	82	PEWCT1097	375	98	PEWGS8054	378	22	RG182AU	226	60
PE31508	19	A3	PEW34B10	370	48	PEWAN1079	362	66	PEWCA1045	367	25	PEWCP1055	373	82	PEWCT1098	375	93	PEWGS8055	378	15	RG183-DS	225	61
PE31510	20	B1	PEW42FS4	388	29	PEWAN1080	362	68	PEWCA1046	367	50	PEWCP1056	373	84	PEWCT1099	375	7	PEWGS8056	377	38	RG198AU	228	62
PE31511	18	E4	PEW42SP4	388	30	PEWAN1081	362	67	PEWCA1047	367	49	PEWCP1057	373	86	PEWCT1100	375	8	PEWGS8057	377	39	RG213AU	228	63
PE31512	18	C6	PEW430FS10	389	75	PEWAN1082	362	69	PEWCA1048	367	42	PEWCP1058	373	88	PEWCT1101	376	12	PEWGS8058	377	40	RG214AU	228	64
PE31513	18	E6	PEW430SP10	389	76	PEWAN1083	362	60	PEWCA1049	367	41	PEWCP1059	373	83	PEWCT1102	376	16	PEWGS8059	377	41	RG217AU	228	65
PE31514	20	D1	PEW50B001	369	27	PEWAN1084	362	62	PEWCA1050	367	43	PEWCP1060	373	87	PEWCT1103	376	20	PEWGS8060	377	62	RG218AU	228	66
PE31515	19	D3	PEW50B001	369	28	PEWAN1085	362	63	PEWCA1051	367	43	PEWCP1061	373	87	PEWCT1104	376	24	PEWGS8061	377	66	RG222AU	228	67
PE31516	19	D7	PEW5T0000	387	4	PEWAN1086	362	63	PEWCA1052	367	55	PEWCP1062	373	89	PEWCT1105	376	13	PEWGS8062	378	68	RG225AU	228	68
PE31517	20	D1	PEW5T0000	387	5	PEWAN1087	362	79	PEWCA1053	367	54	PEWCP1063	373	90	PEWCT1106	376	17	PEWGS8063	378	68	RG302AU	226	13
PE31518	18	D4	PEW5T0002	387	6	PEWAN1088	362	77	PEWCA1054	367	57	PEWCP1064	373	92	PEWCT1107	376	21	PEWGS8064	377	63	RG303AU	226	14
PE31519	18	B5	PEW5ZFS5	388	37	PEWAN1089	362	76	PEWCA1055	367	56	PEWCP1065	373	94	PEWCT1108	376	25	PEWGS8065	377	65	RG316-DS	228	71
PE31520	20	B7	PEW5ZSP5	388	38	PEWAN1090	362	64	PEWCA1056	367	69	PEWCP1066	373	96	PEWCT1109	376	29	PEWGS8066	377	67	RG316-DS	228	71
PE31521	20	B7	PEW5ZSP5	388	39	PEWAN1091	362	65	PEWCA1057	367	70	PEWCP1067	373	96	PEWCT1110	376	33	PEWGS8067	377	68	RG333AU	228	72
PE31522	20	C4	PEW6B0001	369	30	PEWAN1092	362	62	PEWCA1058	367	66	PEWCP1068	373	93	PEWCT1111	376	22	PEWGS8068	378	78	RG400AU	228	73
PE31523	21	A4	PEW6T0000	387	1	PEWAN1100	364	13	PEWCA1059	367	68	PEWCP1069	373	95	PEWCT1112	376	11	PEWGS8069	378	79	RG401AU	230	14
PE31524	19	B5	PEW6T0000	387	2	PEWAN1101	364	11	PEWCA1060	367	73	PEWCP1070	373	97	PEWCT1113	376	15	PEWGS8070	378	80	RG402AU	230	15
PE31526	19	E4	PEW6T0002	387	3	PEWAN1112	364	12	PEWCA1061	367	75	PEWCP1071	373	98	PEWCT1114	376	19	PEWGS8071	378	81	RG402U-STRAIGHT	230	16
PE31528	21	D4	PEW7FS5	388	41	PEWAN1113	364	9	PEWCA1062	367	82	PEWCP1072	373	1	PEWCT1115	376	23	PEWTR1000	381	40	RG405U	230	17
PE31529	20	D3	PEW7SP5	388	40	PEWAN1114	364	8	PEWCA1063	367	82	PEWCP1073	373	2	PEWCT1116	376	2						

# 50-OHM CONVERSION TABLE

## (dBm - volts- watts)

dBm	V	Po
+53	100.0	200W
+50	70.7	100W
+49	64.0	80W
+48	58.0	64W
+47	50.0	50W
+46	44.5	40W
+45	40.0	32W
+44	32.5	25W
+43	32.0	20W
+42	28.0	16W
+41	26.2	12.5W
+40	22.5	10W
+39	20.0	8W
+38	18.0	6.4W
+37	16.0	5W
+36	14.1	4W
+35	12.5	3.2W
+34	11.5	2.5W
+33	10.0	2W
+32	9.0	1.6W
+31	8.0	1.25W
+30	7.10	1.0W
+29	6.40	800 mW
+28	5.80	640 mW
+27	5.00	500 mW
+26	4.45	400 mW
+25	4.00	320 mW
+24	3.55	250 mW
+23	3.20	200 mW
+22	2.80	160 mW
+21	2.52	125 mW
+20	2.25	100 mW
+19	2.00	80 mW
+18	1.80	64 mW
+17	1.60	50 mW
+16	1.41	40 mW
+15	1.25	32 mW
+14	1.15	25 mW
+13	1.00	20 mW
+12	0.90	16 mW
+11	0.80	12.5 mW
+10	0.71	10 mW
+9	0.64	8 mW
+8	0.58	6.4 mW
+7	0.50	5 mW
+6	0.45	4 mW
+5	0.40	3.2 mW
+4	0.36	2.5 mW
+3	0.32	2.0 mW

dBm	V	Po
+2	0.28	1.6 mW
+1	0.25	1.25 mW
0	0.23	1.0 mW
-1	0.20	.80 mW
-2	0.18	.64 mW
-3	0.16	.50 mW
-4	0.14	.40 mW
-5	0.13	.32 mW
-6	0.12	.25 mW
-7	0.10	.20 mW
-8	0.09	.16 mW
-9	0.08	.125 mW
-10	0.07	.10 mW
-11	0.06	
-12	0.06	
-13	0.05	
-14	0.05	
-15	0.04	
-16	0.0355	
dBm	mV	Po
-17	31.5	
-18	28.5	
-19	25.1	
-20	22.5	.01 mW
-21	20.0	
-22	17.9	
-23	15.9	
-24	14.1	
-25	12.8	
-26	11.5	
-27	10.0	
-28	8.9	
-29	8.0	
-30	7.1	.001 mW
-31	6.25	
-32	5.8	
-33	5.0	
-34	4.5	
-35	4.0	
-36	3.5	
-37	3.2	
-38	2.85	
-39	2.5	
-40	2.25	.1 µW
-41	2.0	
-42	1.8	
-43	1.6	
-44	1.4	
-45	1.25	

dBm	mV	Po
-46	1.18	
-47	1.0	
-48	0.9	
-49	0.8	
-50	0.71	.01 µW
-51	0.64	
-52	0.57	
-53	0.5	
-54	0.45	
-55	0.4	
-56	0.351	
-57	0.32	
-58	0.286	
-59	0.251	
-60	0.225	.001 µW
-61	0.2	
-62	0.18	
-63	0.16	
-64	0.141	
dBm	µV	Po
-65	128	
-66	115	
-67	100	
-68	90	
-69	80	
-70	71	.1 nW
-71	65	
-72	58	
-73	50	
-74	45	
-75	40	
-76	35	
-77	32	
-78	29	
-79	25	
-80	22.5	.01 nW
-81	20	
-82	18	
-83	16	
-84	11.1	
-85	12.9	
-86	11.5	
-87	10.0	
-88	9.0	
-89	8.0	
-90	7.1	.001 nW
-91	6.1	
-92	5.75	
-93	5.0	

dBm	µV	Po
-94	4.5	
-95	4.0	
-96	3.51	
-97	3.2	
-98	2.9	
-99	2.51	
-100	2.25	.1 pW
-101	2.0	
-102	1.8	
-103	1.6	
-104	1.41	
-105	1.27	
-106	1.18	
dBm	nV	Po
-107	1000	
-108	900	
-109	800	
-110	710	.01 pW
-109	640	
-112	580	
-113	500	
-114	450	
-115	400	
-116	355	
-117	825	
-118	285	
-119	251	
-120	225	.001 pW
-121	200	
-122	180	
-123	160	
-124	141	
-125	128	
-126	117	
-127	100	
-128	90	
-129	80	
-130	71	.1 fW
-131	61	
-132	58	
-133	50	
-134	45	
-135	40	
-136	35	
-137	33	
-138	29	
-139	25	
-140	23	.01 fW



Technical Support  
+1 (949) 261-1920



Same-Day Shipping,  
Even Custom  
Cable Assemblies

# RETURN LOSS CONVERSION TABLE

Return Loss (dBm)	VSWR	Return Loss (dBm)	VSWR	Return Loss (dBm)	VSWR	Return Loss (dBm)	VSWR	Return Loss (dBm)	VSWR
46.064	1.01	13.842	1.51	9.485	2.01	7.327	2.51	5.999	3.01
40.086	1.02	13.708	1.52	9.428	2.02	7.294	2.52	5.970	3.02
36.607	1.03	13.577	1.53	9.372	2.03	7.262	2.53	5.956	3.03
34.151	1.04	13.449	1.54	9.317	2.04	7.230	2.54	5.935	3.04
32.256	1.05	13.324	1.55	9.262	2.05	7.198	2.55	5.914	3.05
30.714	1.06	13.201	1.56	9.208	2.06	7.167	2.56	5.893	3.06
29.417	1.07	13.081	1.57	9.155	2.07	7.135	2.57	5.872	3.07
28.299	1.08	12.964	1.58	9.103	2.08	7.105	2.58	5.852	3.08
27.318	1.09	12.849	1.59	9.051	2.09	7.074	2.59	5.832	3.09
26.444	1.10	12.736	1.60	8.999	2.10	7.044	2.60	5.811	3.10
25.658	1.11	12.625	1.61	8.949	2.11	7.014	2.61	5.791	3.11
24.943	1.12	12.518	1.62	8.899	2.12	6.984	2.62	5.771	3.12
24.289	1.13	12.412	1.63	8.849	2.13	6.954	2.63	5.751	3.13
23.686	1.14	12.308	1.64	8.800	2.14	6.925	2.64	5.732	3.14
23.127	1.15	12.207	1.65	8.752	2.15	6.896	2.65	5.712	3.15
22.607	1.16	12.107	1.66	8.705	2.16	6.867	2.66	5.693	3.16
22.120	1.17	12.009	1.67	8.657	2.17	6.839	2.67	5.674	3.17
21.664	1.18	11.913	1.68	8.611	2.18	6.811	2.68	5.654	3.18
21.234	1.19	11.818	1.69	8.565	2.19	6.783	2.69	5.635	3.19
20.828	1.20	11.725	1.70	8.519	2.20	6.755	2.70	5.617	3.20
20.443	1.21	11.634	1.71	8.474	2.21	6.728	2.71	5.598	3.21
20.079	1.22	11.545	1.72	8.430	2.22	6.700	2.72	5.579	3.22
19.732	1.23	11.457	1.73	8.386	2.23	6.673	2.73	5.561	3.23
19.401	1.24	11.370	1.74	8.342	2.24	6.646	2.74	5.542	3.24
19.085	1.25	11.285	1.75	8.299	2.25	6.620	2.75	5.524	3.25
18.783	1.26	11.202	1.76	8.257	2.26	6.594	2.76	5.506	3.26
18.493	1.27	11.120	1.77	8.215	2.27	6.567	2.77	5.488	3.27
18.216	1.28	11.039	1.78	8.173	2.28	6.541	2.78	5.470	3.28
17.949	1.29	10.960	1.79	8.138	2.29	6.516	2.79	5.452	3.29
17.690	1.30	10.881	1.80	8.091	2.30	6.490	2.80	5.435	3.30
17.445	1.31	10.804	1.81	8.051	2.31	6.465	2.81	5.417	3.31
17.207	1.32	10.729	1.82	8.011	2.32	6.440	2.82	5.400	3.32
16.977	1.33	10.654	1.83	7.972	2.33	6.415	2.83	5.383	3.33
16.755	1.34	10.581	1.84	7.933	2.34	6.390	2.84	5.365	3.34
16.540	1.35	10.509	1.85	7.894	2.35	6.366	2.85	5.348	3.35
16.332	1.36	10.437	1.86	7.856	2.36	6.341	2.86	5.331	3.36
16.131	1.37	10.367	1.87	7.818	2.37	6.317	2.87	5.315	3.37
15.936	1.38	10.298	1.88	7.781	2.38	6.293	2.88	5.298	3.38
15.747	1.39	10.230	1.89	7.744	2.39	6.270	2.89	5.281	3.39
15.563	1.40	10.163	1.90	7.707	2.40	6.246	2.90	5.265	3.40
15.385	1.41	10.097	1.91	7.671	2.41	6.223	2.91	5.248	3.41
15.211	1.42	10.032	1.92	7.635	2.42	6.200	2.92	5.232	3.42
15.043	1.43	9.968	1.93	7.599	2.43	6.177	2.93	5.216	3.43
14.879	1.44	9.904	1.94	7.564	2.44	6.154	2.94	5.200	3.44
14.719	1.45	9.842	1.95	7.529	2.45	6.131	2.95	5.184	3.45
14.564	1.46	9.780	1.96	7.494	2.46	6.109	2.96	5.168	3.46
14.412	1.47	9.720	1.97	7.460	2.47	6.086	2.97	5.152	3.47
14.264	1.48	9.660	1.98	7.426	2.48	6.064	2.98	5.137	3.48
14.120	1.49	9.601	1.99	7.393	2.49	6.042	2.99	5.121	3.49
13.979	1.50	9.542	2.00	7.360	2.50	6.021	3.00	5.105	3.50

# MOUNTING HOLES

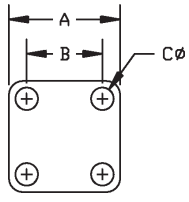

CODE	A	B	C
A01	.500	.340	.102
A02	.687	.500	.109
A03	.687	.500	#3-56 TAP
A04	.687	.500	.125
A05	1.000	.718	.125
A06	.750	.531	.140
A07	.750	.531	.125
A08	1.190	.906	.125
A09	.687	.500	#4-40 TAP
A10	.687	.500	.136
A11	1.250	.975	.147
A12	2.000	1.440	.257
A13	1.000	.718	.141
A14	1.000	.718	.144
A15	.687	.500	.104
A16	.750	.531	.136
A17	.375	.232	.067
A18	.625	.437	.094
A19	1.000	.718	#6-32 TAP
A20	.500	.340	#2-56 TAP
A21	1.250	.975	.142
A22	.375	.232	.093

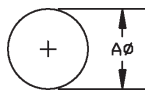

CODE	A
F01	.250
F02	.500
F03	.630
F04	1.200
F05	.380
F06	.450
F07	.200
F08	.362
F09	.220
F10	.317
F11	4.83mm
F12	.390

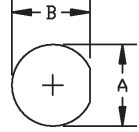

CODE	A	B
B01	.195	.177
B02	.250	.235
B03	.330	.295
B04	.380	.350
B05	.440	.410
B06	.512	.480
B07	.760	.720
B08	.565	.537
B09	.314	.296
B10	.140	.126
B11	.695	.655
B12	.625	.575
B13	.405	.361
B14	.277	.252
B15	.630	.596
B16	.317	.285
B17	.284	.268

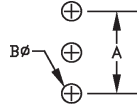

CODE	A	B
J01	.200	.046

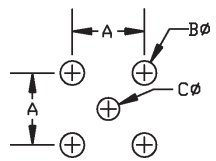

CODE	A	B	C
D01	.200	.067	.062
D02	.200	.067	.046
D03	.100	.031	.031
D04	.200	.052	.052
D05	.260	.067	.043
D06	.200	.052	.047
D07	.200	.055	.043
D08	.200	.067	.035
D09	.200	.055	.028
D10	.200	.055	.035
D11	.320	.091	.031
D12	.400	.062	.062
D13	.320	.091	.091
D14	.340	.091	.043
D15	.164	.067	.091
D16	.500	.126	.440
D17	.380	.083	.043

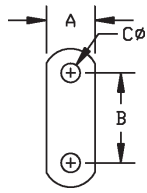

CODE	A	B	C
C01	.223	.481	.102
C02	.260	.481	.102
C03	.192	.328	.067
C04	.640	1.000	.125
C05	.275	.481	.102
C06	.230	.354	.067
C07	.188	.328	.093

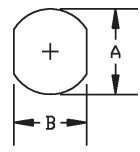

CODE	A	B
G01	.640	.546
G02	.380	.340
G03	.765	.712
G04	.362	.323
G05	.236	.197
G06	.217	.177
G07	.380	.310
G08	1.161	1.000

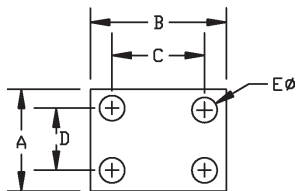

CODE	A	B	C	D	E
E01	.375	.500	.340	.222	.093

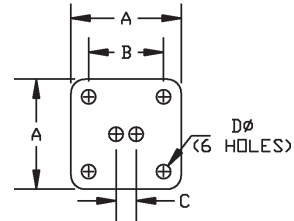

CODE	A	B	C	D
H01	.687	.500	.125	.045



# CONNECTOR IDENTIFIER

SPECIFICATIONS SHOWN ARE INTENDED FOR IDENTIFICATION PURPOSES ONLY

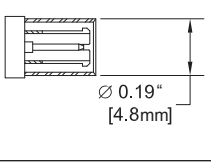
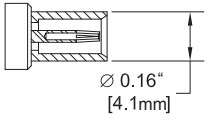
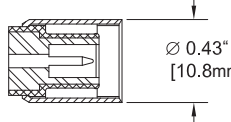
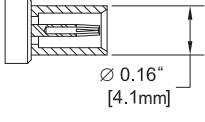
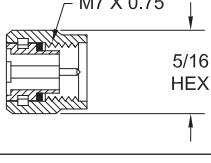
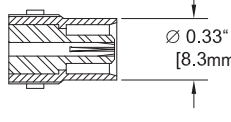
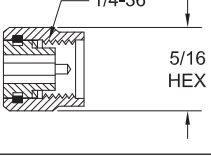
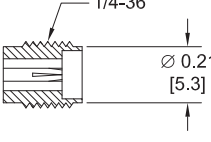
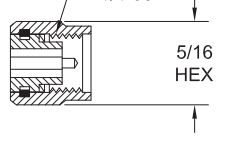
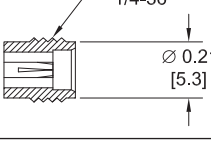
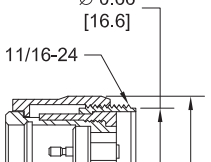
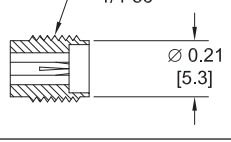
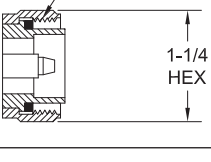
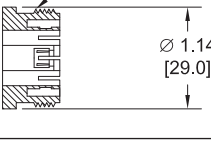
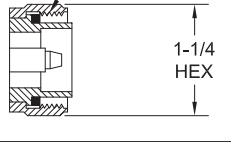
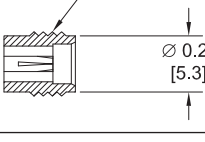
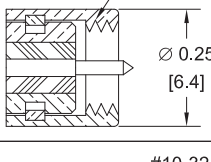
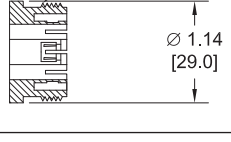
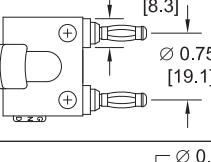
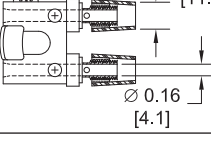
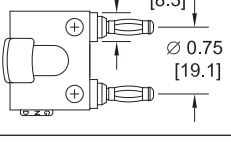
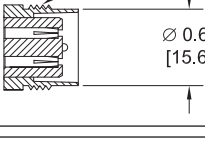
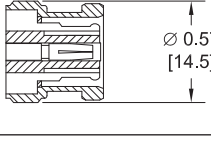
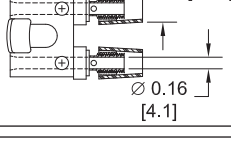
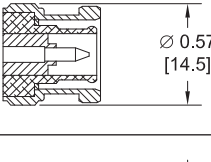
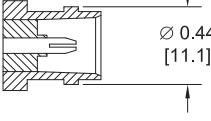









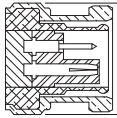
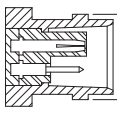
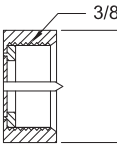
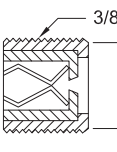
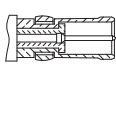
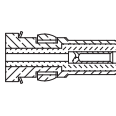
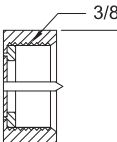
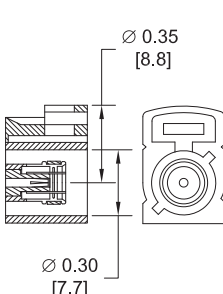
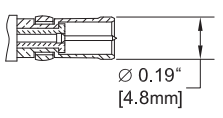
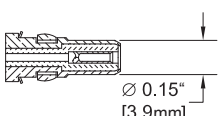







<b>1.0/2.3 SLIDE ON</b>	<b>PLUG</b>	
	<b>JACK</b>	
<b>1.85 mm**</b>	<b>MALE</b>	
	<b>FEMALE</b>	
<b>2.4 mm**</b>	<b>MALE</b>	
	<b>FEMALE</b>	
<b>2.92 mm*</b>	<b>MALE</b>	
	<b>FEMALE</b>	
<b>3.5 mm*</b>	<b>MALE</b>	
	<b>FEMALE</b>	
<b>7 mm</b>	<b>PLUG</b>	
	<b>JACK</b>	
<b>7/16</b>	<b>PLUG</b>	
	<b>JACK</b>	
<b>3/4-20 TWINAX</b>	<b>MALE</b>	
	<b>FEMALE</b>	
<b>10 - 32</b>	<b>MALE</b>	
	<b>FEMALE</b>	
<b>BANANA</b>	<b>PLUG</b>	
	<b>JACK</b>	
<b>BNC</b>	<b>MALE</b>	
	<b>FEMALE</b>	
<b>REVERSE POLARITY BNC</b>	<b>MALE</b>	
	<b>FEMALE</b>	
<b>75 OHM BNC</b>	<b>MALE</b>	
	<b>FEMALE</b>	

\*SMA, 2.92mm, & 3.5mm CONNECTORS WILL MATE MECHANICALLY & ELECTRICALLY TO EACH OTHER.

\*\*1.85mm & 2.4mm CONNECTORS WILL MATE MECHANICALLY & ELECTRICALLY TO EACH OTHER.

# CONNECTOR IDENTIFIER

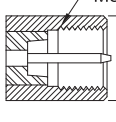
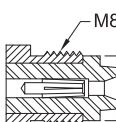
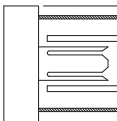
SPECIFICATIONS SHOWN ARE INTENDED FOR IDENTIFICATION PURPOSES ONLY

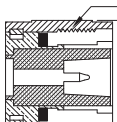
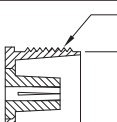
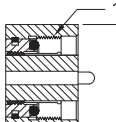
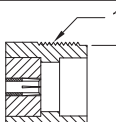
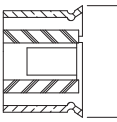
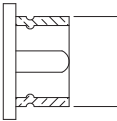
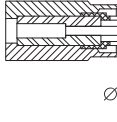
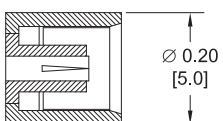
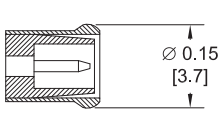
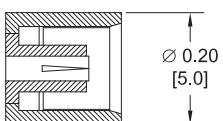
<b>BNC TWINAX</b>	<b>PLUG</b>	 Ø 0.57" [14.5mm]				
	<b>JACK</b>	 Ø 0.44" [11.1mm]				
<b>C</b>	<b>MALE</b>	 Ø 0.75" [19.1mm]				
	<b>FEMALE</b>	 Ø 0.60" [15.2mm]				
<b>D SUBMINIATURE</b>	<b>PLUG</b>	 Ø 0.19" [4.8mm]				
	<b>RECEPTACLE</b>	 Ø 0.15" [3.9mm]				
<b>F</b>	<b>MALE</b>	 3/8-32 7/16 HEX				
	<b>FEMALE</b>	 3/8-32 Ø 0.34 [8.5]				
<b>FAKRA</b>	<b>PLUG</b>	 0.10 [2.4] Ø 0.26 [6.5] Ø 0.30 [7.5]				
	<b>JACK</b>	 Ø 0.35 [8.8] Ø 0.30 [7.7]				
<b>FAKRA</b>	<b>COMPLETE KEY CODE INFO</b>	<b>CODE</b>	<b>JACK</b>	<b>PLUG</b>	<b>COLOR</b>	<b>APPLICATION</b>
		<b>A</b>			BLACK	RADIO WITH PHANTOM SUPPLY
		<b>B</b>			WHITE	RADIO WITHOUT PHANTOM SUPPLY
		<b>C</b>			BLUE	GPS: TELEMATICS OR NAVIGATION
		<b>D</b>			BORDEAUX	GSM: CELLULAR PHONE
<b>H</b>			VIOLET	GPS: TELEMATICS AND NAVIGATION		
<b>I</b>			BEIGE	BLUETOOTH		
<b>K</b>			CURRY	RADIO WITH I.F. OUTPUT (ANTENNA DIVERSITY)		
<b>Z</b>			WATER BLUE	NEUTRAL CODING		
<b>FME</b>	<b>PLUG</b>	 M8 X P.75 Ø 0.37 [9.5]				
	<b>JACK</b>	 M8 X P.75 Ø 0.29 [7.3]				
<b>GR874</b>	<b>PLUG</b>	 Ø 0.81 [20.6]				
	<b>JACK</b>					
<b>HN</b>	<b>MALE</b>	 3/4-20 Ø 0.90 [22.9]				
	<b>FEMALE</b>	 3/4-20 Ø 0.67 [17.1]				
<b>LC</b>	<b>MALE</b>	 1-1/4-18 1-1/2 HEX				
	<b>FEMALE</b>	 1-1/4-18 Ø 1.17 [29.6]				
<b>UMCX</b>	<b>PLUG</b>	 Ø 0.10 [2.5]				
	<b>JACK</b>	 Ø 0.08 [2.0]				
<b>MC-CARD</b>	<b>PLUG</b>	 Ø 0.087 [2.2]				
	<b>JACK</b>	 Ø 0.20 [5.0]				
<b>MCX</b>	<b>PLUG</b>	 Ø 0.15 [3.7]				
	<b>JACK</b>	 Ø 0.20 [5.0]				



# CONNECTOR IDENTIFIER

SPECIFICATIONS SHOWN ARE INTENDED FOR IDENTIFICATION PURPOSES ONLY

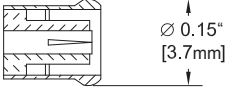
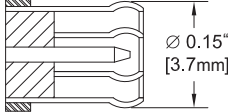
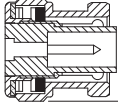
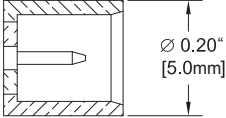
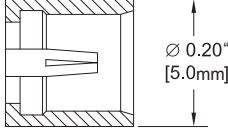
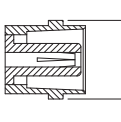
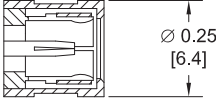
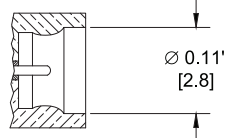
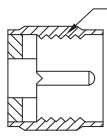
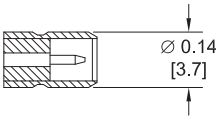
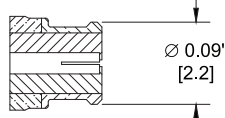
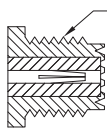
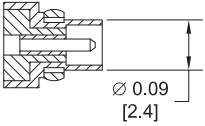
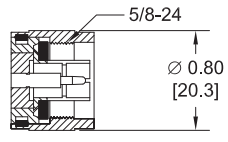
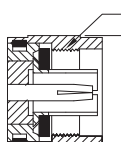
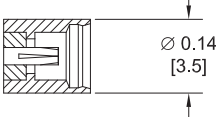
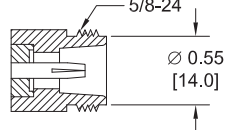
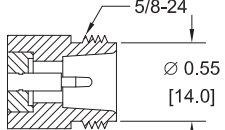
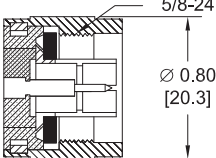
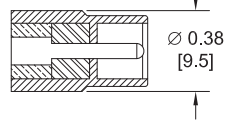
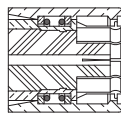
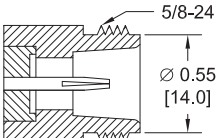
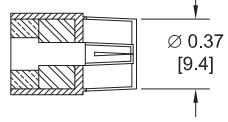
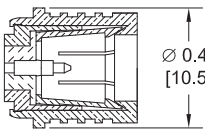
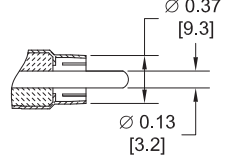
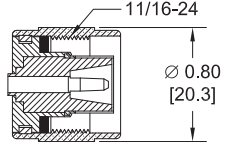
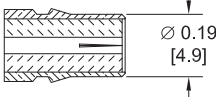
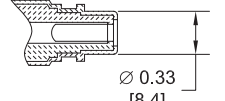
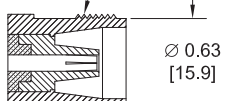
<b>REVERSE POLARITY MCX</b>	<b>PLUG</b>	 Ø 0.15" [3.7mm]	<b>75 OHM MCX</b>	<b>PLUG</b>	 Ø 0.15" [3.7mm]	<b>MHV</b>	<b>MALE</b>	 Ø 0.57" [14.5mm]
	<b>JACK</b>	 Ø 0.20" [5.0mm]		<b>JACK</b>	 Ø 0.20" [5.0mm]		<b>FEMALE</b>	 Ø 0.44" [11.1mm]
<b>MINI 75 OHM SMB</b>	<b>PLUG</b>	 Ø 0.25 [6.4]	<b>MINI SMP</b>	<b>MALE</b>	 Ø 0.11" [2.8]	<b>MINI-UHF</b>	<b>MALE</b>	 3/8-24 Ø 0.45 [11.5]
	<b>JACK</b>	 Ø 0.14 [3.7]		<b>FEMALE</b>	 Ø 0.09" [2.2]		<b>FEMALE</b>	 3/8-24 Ø 0.31 [7.8]
<b>MMCX</b>	<b>PLUG</b>	 Ø 0.09 [2.4]	<b>N</b>	<b>MALE</b>	 5/8-24 Ø 0.80 [20.3]	<b>REVERSE POLARITY N</b>	<b>MALE</b>	 5/8-24 Ø 0.80 [20.3]
	<b>JACK</b>	 Ø 0.14 [3.5]		<b>FEMALE</b>	 5/8-24 Ø 0.55 [14.0]		<b>FEMALE</b>	 5/8-24 Ø 0.55 [14.0]
<b>75 OHM N</b>	<b>MALE</b>	 5/8-24 Ø 0.80 [20.3]	<b>PAL</b>	<b>PLUG</b>	 Ø 0.38 [9.5]	<b>POSITIVE SNAP</b>	 Ø 0.39 [9.9]	
	<b>FEMALE</b>	 5/8-24 Ø 0.55 [14.0]		<b>JACK</b>	 Ø 0.37 [9.4]			
<b>QMA</b>	<b>MALE</b>	 Ø 0.41 [10.5]	<b>RCA</b>	<b>PLUG</b>	 Ø 0.37 [9.3] Ø 0.13 [3.2]	<b>SC</b>	<b>MALE</b>	 11/16-24 Ø 0.80 [20.3]
	<b>FEMALE</b>	 Ø 0.19 [4.9]		<b>JACK</b>	 Ø 0.33 [8.4]		<b>FEMALE</b>	 11/16-24 Ø 0.63 [15.9]

# CONNECTOR IDENTIFIER

SPECIFICATIONS SHOWN ARE INTENDED FOR IDENTIFICATION PURPOSES ONLY

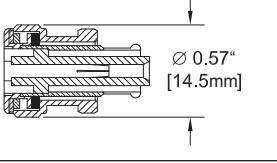
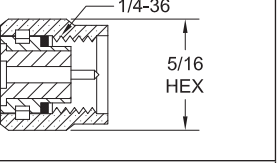
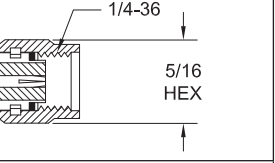
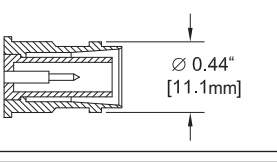
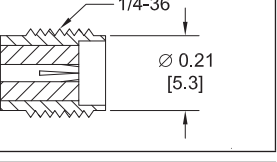
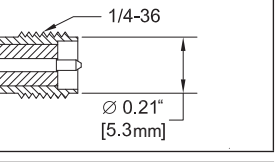
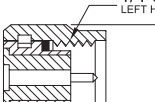
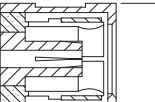
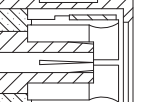
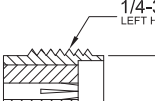
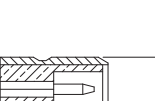
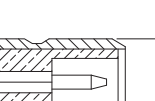
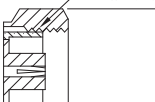
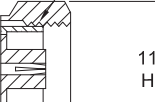
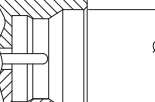
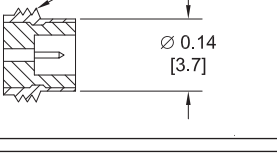
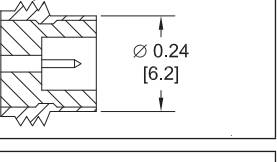
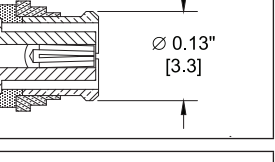
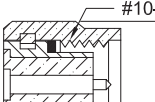
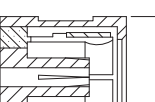
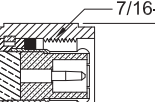
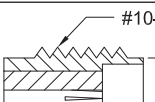
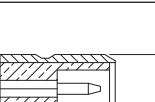
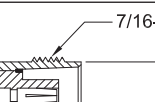
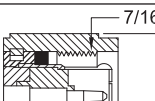
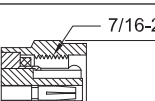
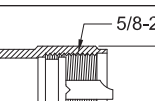
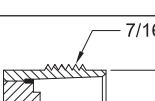
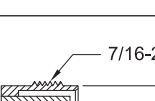
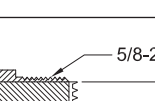
<b>SHV</b>	<b>PLUG</b>	 Ø 0.57" [14.5mm]	<b>SMA*</b>	<b>MALE</b>	 1/4-36 5/16 HEX	<b>REVERSE POLARITY SMA</b>	<b>MALE</b>	 1/4-36 5/16 HEX
	<b>JACK</b>	 Ø 0.44" [11.1mm]		<b>FEMALE</b>	 1/4-36 Ø 0.21 [5.3]		<b>FEMALE</b>	 1/4-36 Ø 0.21" [5.3mm]
<b>SMA REVERSE THREAD</b>	<b>MALE</b>	 1/4-36 LEFT HAND THREAD 5/16 HEX	<b>SMB</b>	<b>PLUG</b>	 Ø 0.25 [6.4]	<b>75 OHM SMB</b>	<b>PLUG</b>	 Ø 0.37 [9.2]
	<b>FEMALE</b>	 1/4-36 LEFT HAND THREAD Ø 0.21 [5.3]		<b>JACK</b>	 Ø 0.14 [3.7]		<b>JACK</b>	 Ø 0.24 [6.2]
<b>SMC</b>	<b>PLUG</b>	 #10-32 1/4 HEX	<b>75 OHM SMC</b>	<b>PLUG</b>	 5/16-32 11/32 HEX	<b>SMP</b>	<b>MALE</b>	 Ø 0.15" [3.7]
	<b>JACK</b>	 #10-32 Ø 0.14 [3.7]		<b>JACK</b>	 5/16-32 Ø 0.24 [6.2]		<b>FEMALE</b>	 Ø 0.13" [3.3]
<b>SSMA</b>	<b>MALE</b>	 #10-36 1/4 HEX	<b>SSMB</b>	<b>PLUG</b>	 Ø 0.18 [4.7]	<b>TNC</b>	<b>MALE</b>	 7/16-28 Ø 0.59 [15.0]
	<b>FEMALE</b>	 #10-36 Ø 0.16 [4.1]		<b>JACK</b>	 Ø 0.10 [2.6]		<b>FEMALE</b>	 7/16-28 Ø 0.38 [9.6]
<b>75 OHM TNC</b>	<b>MALE</b>	 7/16-28 Ø 0.59 [15.0]	<b>REVERSE POLARITY TNC</b>	<b>MALE</b>	 7/16-28 Ø 0.59 [15.0]	<b>UHF</b>	<b>MALE</b>	 5/8-24 Ø 0.70 [17.8]
	<b>FEMALE</b>	 7/16-28 Ø 0.38 [9.6]		<b>FEMALE</b>	 7/16-28 Ø 0.38 [9.6]		<b>FEMALE</b>	 5/8-24 Ø 0.55 [14.0]

\*SMA, 2.92mm & 3.5mm CONNECTORS WILL MATE MECHANICALLY & ELECTRICALLY TO EACH OTHER.



Technical Support  
+1 (949) 261-1920



Same-Day Shipping,  
Even Custom  
Cable Assemblies



# CONNECTOR FREQUENCY RANGE CHART

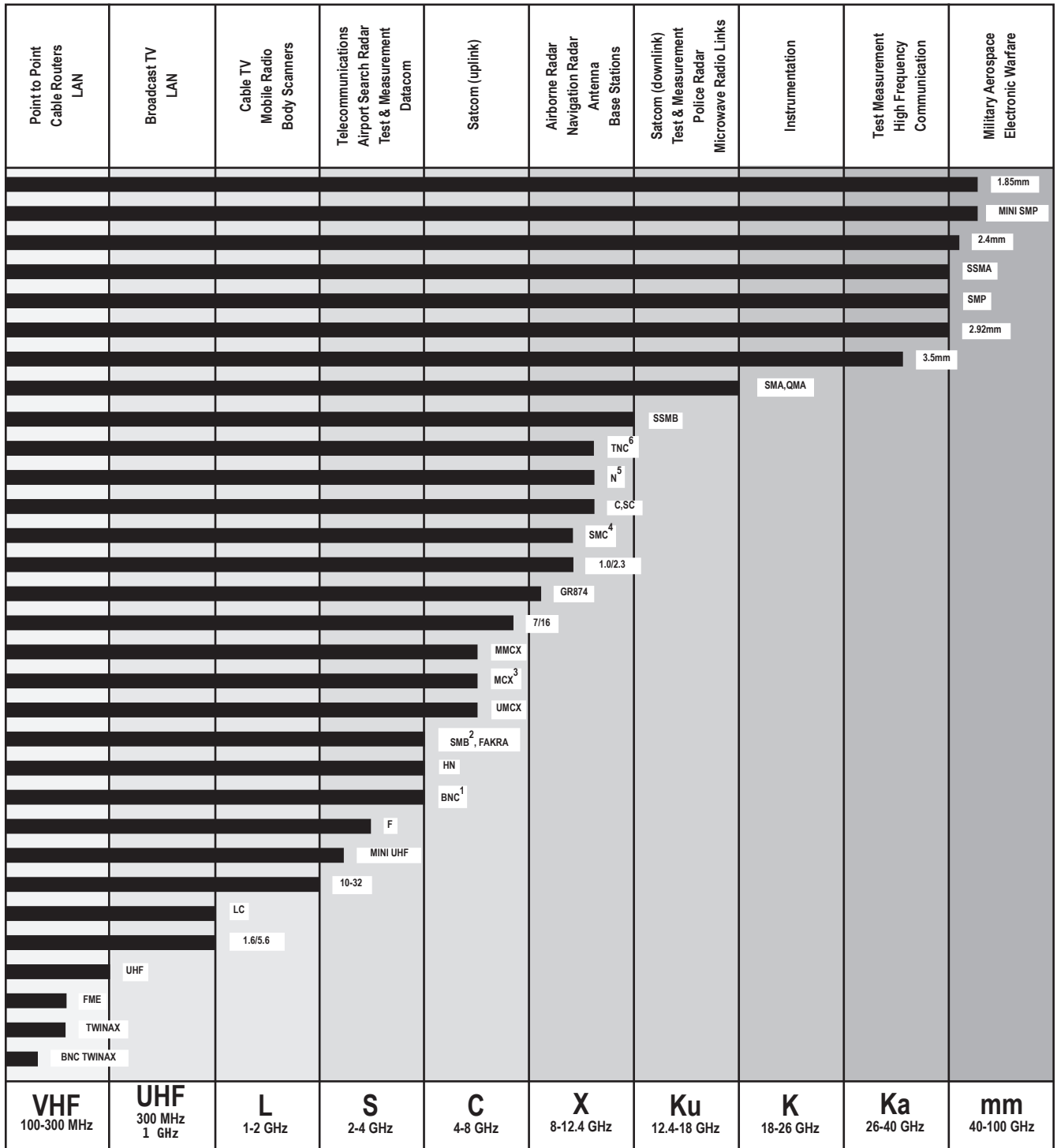

**Notes:**

- 1: BNC-75 Ohm connectors operate up to 1 GHz
- 2: SMB-75 Ohm & Mini SMB-75 Ohm connectors operate up to 4 GHz
- 3: MCX-75 Ohm connectors operate up to 6 GHz
- 4: SMC-75 Ohm connectors operate up to 10 GHz
- 5: N-75 Ohm connectors operate up to 1.5 GHz
- 6: TNC-75 Ohm connectors operate up to 1 GHz



## RF Solutions from RF Engineers

Authorized Pasternack Distributor:

**ES** *Département*  
*RF & HYPERFREQUENCES*

**EQUIPEMENTS SCIENTIFIQUES S.A.**

TEL: +33 1 47 95 99 60

FAX: +33 1 47 01 16 22

EMAIL: [hyper@es-france.com](mailto:hyper@es-france.com)

WEB: [www.es-france.com](http://www.es-france.com)



Same-Day Shipping  
on orders placed by 4:00 pm PST



24-Hour Support  
by phone, chat or email



Secure Online Ordering  
[pasternack.com](http://pasternack.com)  
[sales@pasternack.com](mailto:sales@pasternack.com)



USA & Canada: 1 (866) 727-8376  
International: +1 (949) 261-1920