

AIOT SOLUTIONS

Product
Catalog

2026



MEON

 ES France - Mobilité & Systèmes Embarqués
127 rue de Buzenval BP 26 - 92380 Garches

 Tél. 01 47 95 99 80

 e-mail : mse@es-france.com
Site Web : www.es-france.com

► Table of Contents

00 Introduction

About AAEON	00-1
Milestones	00-3
Operation Strength	00-4
OEM/ODM Capability	00-4
Core Competence	00-5
Quality Assurance	00-6
AAEON AI Website	00-7
AAEON eShop	00-8
Applications	00-9
IoT Solutions	00-13
Design Manufacturing Service	00-15
Wide Temperature Assurance Service (WiTAS)	00-16
AAEON's Embedded OS Solution	00-17
AAEON Hi-Safe	00-18
AAEON AI-Angel	00-19
AAEON BIOX	00-20
UP Edge AI Toolkit	00-21
AAEON's Multilayered Software Security Framework	00-21
System Product Lines	00-22

01 AI@Edge Solutions

BOXER-8221AI	AI@Edge Compact Fanless Embedded BOX PC with NVIDIA® Jetson Nano™	01-1
BOXER-8223AI	AI@Edge Compact Fanless Embedded AI System with NVIDIA® Jetson Nano™	01-3
BOXER-8224AI	AI@Edge Embedded System with NVIDIA® Jetson Nano™	01-5
BOXER-8240AI	AI@Edge Fanless Embedded Box PC with NVIDIA® Jetson AGX Xavier™	01-7
BOXER-8251AI	AI@Edge Compact Fanless Embedded AI System with NVIDIA® Jetson Xavier™ NX	01-9
BOXER-8253AI	AI@Edge Compact Fanless Embedded BOX PC with NVIDIA® Jetson Xavier™ NX	01-11
BOXER-8256AI	AI@Edge Fanless Embedded AI System with NVIDIA® Jetson Xavier™ NX, HDMI Input x4	01-13
BOXER-8621AI	AI@Edge Compact Fanless Embedded AI System with NVIDIA® Jetson Orin Nano™ with Super Mode	01-15
BOXER-8622AI	AI@Edge Compact Fanless Embedded AI System with NVIDIA® Jetson Orin Nano™ with Super Mode	01-17
BOXER-8623AI	AI@Edge Compact Fanless Embedded AI System with NVIDIA® Jetson Orin Nano™	01-19
BOXER-8640AI	AI@Edge Fanless Embedded AI System with NVIDIA® Jetson AGX Orin™	01-21
BOXER-8641AI	AI@Edge Compact Fanless Embedded AI System with NVIDIA® Jetson AGX Orin™	01-23
BOXER-8641AI-PLUS	AI@Edge Compact Fanless Embedded AI System with NVIDIA® Jetson AGX Orin™	01-25
BOXER-8642AI	AI@Edge Fanless Embedded AI System with NVIDIA® Jetson AGX Orin™	01-27
BOXER-8645AI	AI@Edge Fanless Embedded AI System with NVIDIA® Jetson AGX Orin™	01-29
BOXER-8646AI	AI@Edge Fanless PoE Embedded AI System with NVIDIA® Jetson AGX Orin™	01-31
BOXER-8651AI	AI@Edge Compact Fanless Embedded AI System with NVIDIA® Jetson Orin™ NX	01-33
BOXER-8651AI-PLUS	AI@Edge Compact Fanless Embedded AI System with NVIDIA® Jetson Orin™ NX	01-35
BOXER-8652AI	AI@Edge Compact Fanless Embedded AI System with NVIDIA® Jetson Orin™ NX	01-37
BOXER-8652AI-PLUS	AI@Edge Compact Fanless Embedded AI System with NVIDIA® Jetson Orin™ NX	01-39
BOXER-8653AI	AI@Edge Compact Fanless Embedded AI System with NVIDIA® Jetson Orin™ NX	01-41
BOXER-8653AI-PLUS	AI@Edge Compact Fanless Embedded AI System with NVIDIA® Jetson Orin™ NX	01-43
BOXER-8654AI-KIT	AI@Edge Embedded board with NVIDIA® Jetson Orin™ NX	01-45
BOXER-8654AI-KIT-PLUS	AI@Edge Embedded board with NVIDIA® Jetson Orin™ NX	01-47
BOXER-8655AI	AI@Edge Fanless Embedded AI System with NVIDIA® Jetson Orin™ NX	01-49
BOXER-8658AI	AI@Edge Fanless PoE Embedded AI System with NVIDIA® Jetson Orin™ NX	01-51
BOXER-8658AI-PLUS	AI@Edge Fanless PoE Embedded AI System with NVIDIA® Jetson Orin™ NX	01-53
BOXER-8741AI	AI@Edge Board with NVIDIA® Jetson T5000™	01-55
BOXER-8742AI	AI@Edge Board with NVIDIA® Jetson T5000™	01-57

AI Inference Server

MAXER-2100	AI Inference Server, 2U Rackmount, 12/13th Gen CPU, RTX-4080 Super	01-59
MAXER-5100	AI Inference Server, Tower, 12th/13th/14th Gen Intel® Core™ CPU	01-61
MAXER-5310	AI Inference Server with NVIDIA® Jetson T5000™	01-63

02 RISC Gateway Solutions

SRG-IMX8P	Standard RISC Gateway with ARM i.MX8M Plus Quad-Core Cortex-A53 1.6GHz Processor	02-1
SRG-IMX8PL	Standard RISC Gateway with ARM i.MX8M Plus Quad-Core Cortex-A53 1.6GHz Processor	02-3
SRG-AM62	Standard RISC Gateway with TI AM62x Sitara™ Processors	02-5
SRG-CM4	Standard RISC Gateway Board With Broadcom BCM2711 Quad-Core Cortex-A72 SoC @ 1.5GHz	02-7

03 Compact Fanless BOX PC Solutions

BOXER-6614	Fanless Embedded Box PC with Intel® Celeron® N2930 Quad Core 1.83 GHz/ Celeron® N2807 Dual Core 1.58 GHz	03-1
BOXER-6616	Fanless Embedded Box PC with Intel® Celeron® Processor N3350/N4200	03-3
BOXER-6617-AND	Fanless Compact Embedded Computer with Intel® Core™ i3 Processor N/Intel® Atom® Processor X/Intel® Processor N-series SoC	03-5
BOXER-6617-ASL	Fanless Compact Embedded Computer with Intel Atom® Processor X-series	03-7
BOXER-6619-TWL	Fanless Compact Embedded Computer with Intel® Processor Core™ 3 & N Series	03-9
BOXER-6641	Fanless Embedded Box PC with Socket Type 8th Generation Intel® Processor	03-11
BOXER-6641-PRO	Fanless Embedded Box PC with Socket Type 8th/9th Generation Intel® Processor	03-13
BOXER-6642-CML	Fanless Embedded Box PC with Socket Type 10th Generation Intel® Core™ Processor	03-15

▶ Table of Contents

▶ Table of Contents

BOXER-6643-TGU	Fanless Embedded Box PC 11th Generation Intel® Core™ SoC Processor	03-17
BOXER-6645-ADS	Fanless Embedded Box PC with Socket Type 12th/13th Generation Intel® Core™ Processors	03-19
BOXER-6645U-RPL	Fanless Embedded Box PC with Socket Type 12/13/14th Generation Intel® Core™ Processor	03-21
BOXER-6646-ADP	Fanless Compact Embedded Computer with 12th/13th Generation Intel® Core™ i7/i5/i3 Processor	03-23
BOXER-6647-MTH	Fanless Compact Embedded Computer with Intel® Core™ Ultra 7/5 Processors	03-25
BOXER-6648-ARS	Fanless Compact Embedded Computer with Intel® Core™ Ultra Processors (Series 2)	03-27
BOXER-6649-RAP	Fanless Compact Embedded Computer with 13th Gen Intel® Core™ i7/i5/i3 Processors	03-29

04 Ultra Slim Fanless BOX PC Solutions

BOXER-6404U	Compact Embedded Box PC with Intel® Celeron® Processor SoC	04-1
BOXER-6404	Compact Embedded Box PC with LAN x 4, HDMI x 2, Intel® Celeron® J1900/N2807 Processor SoC	04-3
BOXER-6404WT	Wide Temperature Compact Embedded Box PC with Intel® Celeron® J1900/ N2807 Processor SoC	04-5
BOXER-6404M	Wide Temperature Compact Embedded Box PC with LAN x 4, HDMI x 2, Intel® Celeron® J1900/N2807 Processor SoC	04-7
BOXER-6405	Fanless Compact Embedded Computer with Intel® Celeron®/Pentium® Processor	04-9
BOXER-6405M	Fanless Compact Embedded Computer with Intel® Celeron®/Pentium® Processor	04-11
BOXER-6406-AND	Fanless Compact Embedded Computer with Intel Atom® Processor X-series/N-series (formerly Alder Lake-N)	04-13
BOXER-6406-ASL	Fanless Compact Embedded Computer with Intel Atom® Processor X-series (formerly Amston Lake)	04-15
BOXER-6406U-AND	Fanless Compact Embedded Computer with Intel Atom® Processor X-series/N-series (formerly Alder Lake-N)	04-17
BOXER-6406U-ASL	Fanless Compact Embedded Computer with Intel Atom® Processor X-series (formerly Amston Lake)	04-19
BOXER-6407-TWL	Fanless Compact Embedded Computer with Intel® Processor N-series	04-21
BOXER-6451-ADP	Fanless Compact Embedded Computer with 12th Generation Intel® Core™ Processors	04-23

05 Din Rail Fanless BOX PC

BOXER-6751-ADP	DIN Rail Fanless Embedded BOX PC with 12th Generation Intel® Core™ Processors	05-1
BOXER-6711-AND	DIN Rail Mount Embedded BOX PC with Intel Atom® x7211E/Intel® Processor N-Series Processors	05-3
BOXER-6710	Din Rail Mount Embedded BOX PC with Intel® Atom® Processor N4200 or N3350	05-5

06 Expandable Fanless BOX PC Solutions

BOXER-6801-RAP	Fanless Embedded Computer with 13th Gen Intel® Core™ i7/i5/i3 Mobile Processors	06-1
BOXER-6839-CFL	Fanless Embedded Box PC with Socket Type 8th/9th Generation Intel® Processor	06-3
BOXER-6839-RPL	Fanless Embedded Controller with 12th, 13th, 14th Gen Intel® Core™ LGA 1700 Socket-Type Processors	06-5
BOXER-6842M	Fanless Embedded Controller with 8th/9th Generation Intel® Processor	06-7
BOXER-6843-ADS/RPL	Embedded Controller with 12th/13th/14th Generation Intel® Core™/Celeron® Processor G Series	06-9
BOXER-6845-BTL	Compact Embedded Computer with 15th Gen Bartlett Lake Intel® Core™ Processors	06-11

Frame Grabber Card

PER-T479	4-Port USB 3.2 Gen 1 PCI-E [x4] Frame Grabber Card	06-13
PER-T481	4-Port/ 2-Port Intel® GbE LAN/ PoE PCI-E [x4] Frame Grabber Card	06-14
PER-T514	2 Ports Intel® 10GbE LAN PCI-E [x4] Frame Grabber Card	06-15

07 Smart In-vehicle & AMR BOX PC

VPC-3350S	Multi-PoE & Fanless Appliance with Intel® Pentium®/ Celeron®/ Atom® Processor	07-1
VPC-5600S	Multi-PoE & Fanless Appliance with 7th Generation Intel® Core™ Processors	07-3
VPC-5640S	Multi-PoE & Fanless Appliance with 12th Generation Intel® Core™ i7 Processor	07-5

08 UP Systems

UP 4000 Edge	UP 4000 System with Intel® Pentium® N4200/ Celeron® N3350/ Atom® E3950 Processor SoC	08-1
UP 7000 Edge	UP 7000 System with Intel® Processor N-series Processor (formerly Alder Lake N)	08-3
UP 710S Edge	UP 710S System with Intel® Processor N-series Processor (formerly Alder Lake N)	08-5
UP TWL Edge	UP TWL System with Intel® Processor N-series Processor (formerly Twin Lake)	08-7
UP TWLS Edge	UP TWLS System with Intel® Processor N-series Processor (formerly Twin Lake)	08-9
UPS-GWS01	Tiny Gateway System with UP Squared	08-11
UP Squared V2 Edge	UP Squared V2 System with Intel® Pentium® Celeron® Processor SoC	08-13
UP Squared i12 Edge	UP Squared i12 system with 12th/13th generation Intel® Core™ i7/i5/i3/Celeron® Processor SoC	08-15
UP Squared 7100 Edge	UP Squared 7100 edge system with Intel® Processor N-series SoC	08-17
UP Squared TWL Edge	UP Squared TWL edge system with Intel® Processor N-series SoC (formerly Twin Lake)	08-19
UPN-Edge Pro	UP Squared Pro EDGE System with Intel® Pentium® N4200/ Celeron® N3350/ Atom® E3950 Processor SoC	08-21
UP Squared Pro 7000 Edge	UP Squared Pro 7000 System with Intel Atom® x7000E Series, Intel® Processor N-series, and Intel® Core™ i3-N305 Processor	08-23
UP Squared Pro 710H Edge	UP Squared Pro 710H Edge System with Intel Atom® x7000 RE Series, Intel® Processor N Series, and Intel® Core™ i3-N305 Processors	08-25
UP Squared Pro TWL Edge	UP Squared Pro TWL System with Intel® Processor N-series, and Intel® Core™ i3-N355 Processor (formerly Twin Lake)	08-27
UP Xtreme i11 Edge	UP System powered by 11th Generation Intel® Core™ i7/i5/i3/Celeron® Processor SoC	08-29
UP Xtreme i11 Edge Computing kit	11th Generation Intel® Core™ i7/i5 Processor SoC (formerly Tiger Lake UP3)	08-31
UP Xtreme i12 Edge	UP Xtreme i12/13 system with 12th/13th Generation Intel® Core™ i7/i5/i3/Celeron® Processor SoC	08-33
UP Xtreme i14 Edge	UP Xtreme i14 system with Intel® Core™ Ultra Processor SoC	08-35
UP Xtreme ARL Edge	UP Xtreme ARL system with Intel® Core™ Ultra 5/7 Processors	08-37
UP Xtreme 7100 Edge	UP Xtreme 7100 System powered by Intel® Processor N-series, and Intel® Core™ i3-N305 Processor	08-39
UP Xtreme PTL Edge	UP Xtreme 7100 System powered by Intel® Processor N-series, and Intel® Core™ i3-N305 Processor	08-39
Intelli i14 Edge	Vision System Embedded Box PC with 14th Generation Intel® Core™ Processors (Socket Type)	08-41
Intelli STX TWL	Intelli STX TWL with Intel® Processor N-series SoC (formerly Twin Lake)	08-43

09 Turn-Key Chassis Solutions

ACS-1U01-BT4	Fanless Solution with Intel® Atom® J1900/ N2807 Processor	09-1
ACS-1U01-H110B	Mini-ITX 1U Chassis with 6th Generation Intel® Processor	09-3
ACS-1U01	Low-profile Mini-ITX Embedded Chassis	09-5

10 Industrial Chassis

ARC-645	4U 14-Slot Rackmount Chassis, Full-Size/ Half-Size CPU Cards Support	10-1
---------	--	------

▶ Table of Contents



About AAEON

The Trusted Innovation Partner

We have the drive to provide innovative, agile solutions tailored to benefit our customers.



Established in 1992, AAEON stands at the forefront of industrial IoT and AI Edge solutions, renowned for its commitment to continual innovation. As a leading designer and manufacturer, AAEON specializes in delivering reliable, high-quality computing platforms and offers comprehensive OEM/ODM services on a global scale. Collaborating with businesses, AAEON goes beyond providing individual platforms, extending its expertise to offer end-to-end solutions that prioritize technological innovation and design excellence, fostering a reputation for delivering a trusted, customer-centric, and high standard of service.

Working closely with premier chip designers, AAEON ensures the creation of stable and reliable platforms, showcasing an innovative approach to product development and operational flexibility that solidifies its standing as a provider synonymous with demonstrated quality and dependability. The experienced engineering team at AAEON has played a pivotal role in assisting numerous companies worldwide, guiding them through product launches with solutions tailored to their specific needs. AAEON's customer-centric approach is underscored by expedited, localized technical support and meticulous attention to detail, reinforcing its dedication to delivering unparalleled service.

AAEON Brand Advantages

Innovation:

Technological Innovation – continually seeking to bring new and exciting technologies to market for our customers

Product Innovation – evolving with our customer's needs to maximize the utility of embedded solutions

Innovative Business Model – maintaining a worldwide community model for peer-to-peer collaboration and expert technical support

Trusted Quality:

Design Quality – rigorously monitoring standards to ensure continual improvement

Advanced Manufacturing – integrating AI, automation, and new technologies into our processes

Higher Standard Of Service – building industry trust in our abilities through external endorsements from premier organizations

Flexibility:

Low Total Cost Of Ownership (TCO) – adopting a modular design process for streamlined customization to lower the cost of entry

Fast Service – faster troubleshooting for issue resolution, straightforward after-sales care

Customer Focus – provide localized solutions for even the most complex customer needs through regional RD & design center





System Level Products

AAEON is committed to delivering high-quality intelligent systems that include edge AI computing platforms, fanless embedded industrial systems, rugged panel PCs and tablets, full HD infotainment displays, and accessories. Our solutions serve a wide range of industries, from industrial automation, smart healthcare, and transportation to retail, digital signage, marine/harbor, military/government, public safety, and energy.

As a customization specialist, AAEON provides dedicated services to help our customers develop end-user solutions tailored to exact application requirements. To help large customers with high-volume needs, we offer end-to-end Design Manufacturing Services (DMS), covering everything from initial design to contract manufacturing. Rigorous quality assurance ensures elite performance across all our system platforms, driving our global growth and industry leadership.

Board Level Products

Embedded boards are the brains behind every computer system. AAEON offers a wide range of embedded boards designed to empower customers to innovate in their fields. Our lineup includes single boards in de next (86mm x 55mm), 3.5" SubCompact, 4" EPIC, and PICO-ITX form factors, as well as COM Express Modules, PC/104 Modules, and RISC Gateway Boards—serving a broad spectrum of vertical markets.

As we enter the AI era, AAEON's embedded boards are at the forefront of adopting cutting-edge technologies, delivering a streamlined path to AI at the edge. These solutions help optimize industrial platforms in areas such as smart cities, automated manufacturing, intelligent transportation, retail, and AI-assisted healthcare.

Engineered for superior resilience, AAEON's boards are built to perform in extreme environments. The WiTAS (Wide Temperature Assurance Services) series operates reliably from -40°C to 85°C, thriving in both bitter cold and intense heat, ensuring consistent performance where it's needed most.

Milestones

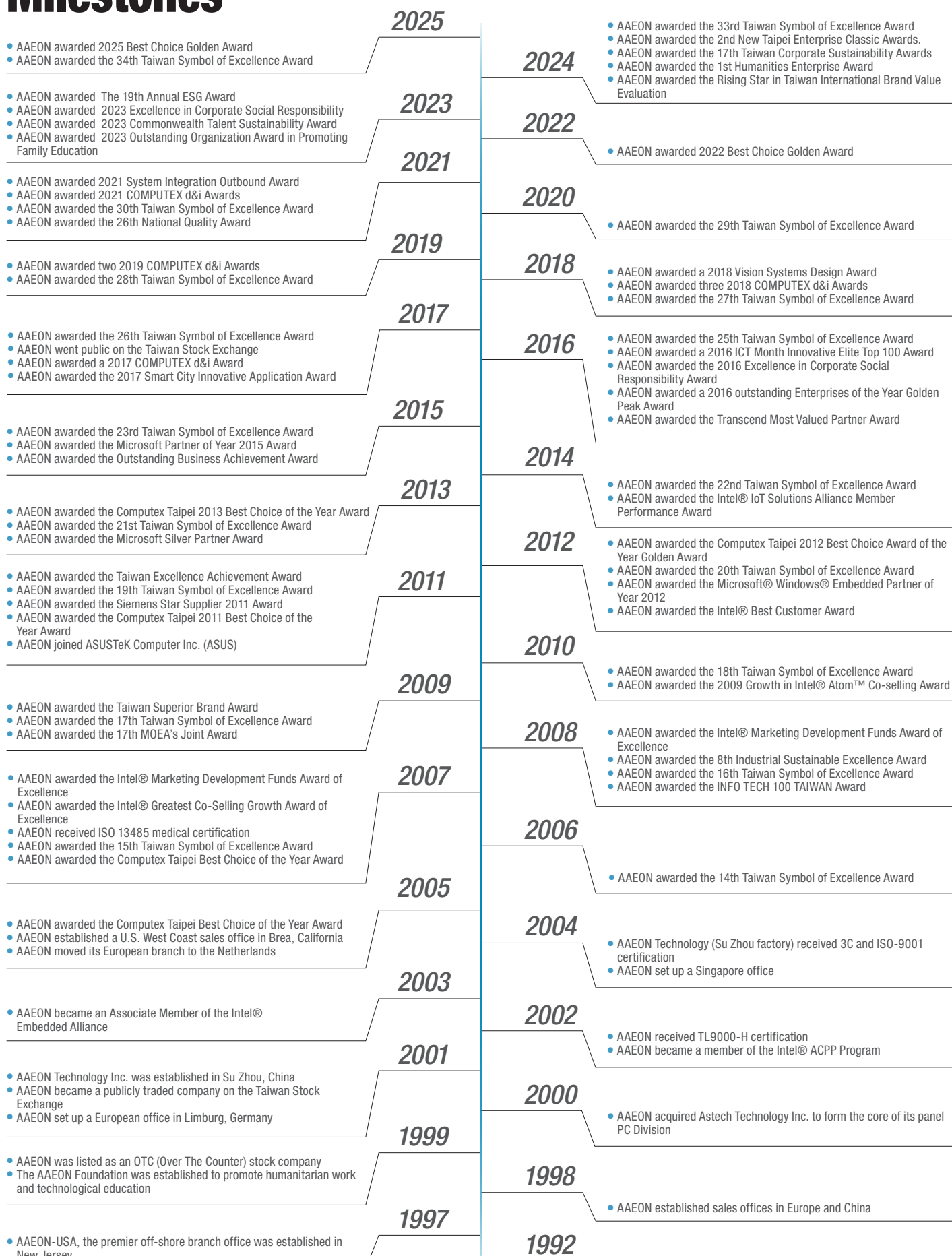

A member of the ASUS Group: A strong high-tech conglomerate

ASUS Technology and Financing

AAEON Design Flexibility and Domain Know-how



OEM/ODM Capability

The OEM/ODM service has been a key factor in AAEON's phenomenal growth over the past 10 years. AAEON offers design services for full custom requirements as well as modification services for its off-the-shelf products. Whatever you need, AAEON has the experience and expertise to help you create or modify products to perfectly fit your requirements.

Core Competence

Product Innovation

AAEON's integration expertise is integral to product designs that have the most desirable built-in features, saving customers valuable design and customization time. AAEON's OEM/ODM capabilities help us meet customers' exact specifications and requirements. In addition, AAEON has invested aggressively in R&D capabilities and will continue to do so to maintain a competitive advantage for new designs. In cooperation with premier technology vendors, AAEON participates in vendor early access programs to provide the latest technology to its customers.

Market Focus

AAEON has established a worldwide reputation for being an innovator with a pragmatic, customer-centric philosophy. This expertise has enabled AAEON to secure a leading position as a trusted partner for customers integrating AI capabilities into industries as varied as transportation, industrial automation, medical technology, smart cities, security, and the energy sector.

R&D Strength

AAEON takes great pride in its World Class R&D aptitudes. With more than 20% of AAEON's workforce employed in R&D and 10% of annual sales revenue invested in this field, AAEON is prepared to handle the most demanding designs based on the latest technologies. With our strong background in innovation, AAEON has been granted a raft of design patents around the world.

Design Capability

From our core competence of single board computer design, AAEON has expanded its capabilities to award-winning Panel PC System Design, BIOS Engineering with multi-vendor expertise, Mechanical Design, Peripheral Device Design, Design Verification and in-house EMI/EMC Debugging.

Manufacturing Capability

AAEON has manufacturing facilities located in Taipei, Taiwan and Suzhou, China. To become the leading supplier of Industrial Computers, AAEON has created manufacturing facilities with flexible layouts and expansion capabilities to easily address the demand for increased production capacity. Drawing upon the skills of its professional and experienced personnel to develop an efficient production system, AAEON has the ability to respond rapidly to customer requests for standard or customized IPC products.



Quality Assurance

AAEON's Quality Assurance Closed Loop Feedback System provides solid and consistent feedback through the design, manufacturing and service stages to ensure continuous progress and meet customer expectations. The three stages of the Quality Assurance System are Design Quality Assurance (DQA), Manufacturing Quality Assurance (MQA) and Service Quality Assurance (SQA).

DQA

Design Quality Assurance starts at the conceptual stage of a project and covers the product development stage to ensure the utmost quality throughout the process. AAEON's safety and environmental test labs ensure our products meet the requirements of CE/UL/FCC/CCC standards. All AAEON products go through an extensive and comprehensive test plan for compatibility, function, performance and usability. Therefore, AAEON customers can always expect to receive well-designed, high-quality products.

MQA

Manufacturing Quality Assurance is carried out in accordance with ISO 9001, ISO 13485, ISO 14001 certification standards. All AAEON products are built using production and quality testing equipment in a static-free environment. Additionally, these products go through rigorous tests on the production line and dynamic aging in the burn-in room. AAEON's Total Quality Control (TQC) program includes Incoming Quality Control (IQC), In-Process Quality Control (IPQC) and Final Quality Control (FQC). Periodic training, auditing and facility calibration are strictly implemented to ensure all quality standards are followed to meet customers' requirements. The Quality Control Team constantly communicates with R&D to improve product performance and compatibility.

SQA

Service Quality Assurance includes technical support and a repair service. With SQA, AAEON can serve its customers and also receive their feedback and work with R&D and Manufacturing to strengthen AAEON's response time in resolving customer concerns and improve service levels.

Technical Support

The backbone of customer support is a team of professional Application Engineers who provide customers with real-time technical support. Their expertise is shared through internal knowledge management and links to the website for online nonstop service and solutions.

Repair Service

With an efficient eRMA system and RMA service policy, AAEON's RMA Team is able to ensure prompt, high-quality product repair and replacement services with a short turnaround time.

Quality Certification



AAEON has acquired many official certifications to maintain its quality system.

ISO 9001: 2015	QMS
ISO 13485: 2016	Medical Devices-QMS
ISO 14001: 2015	EMS
ISO 27001: 2022	ISMS
3C:	China Compulsory Certification
CE/FCC:	All AAEON products undergo and meet CE and FCC test standards which prove their design quality and integrity

AAEON.AI

Connecting You
with AI at the Edge



Introduction

To keep ahead of the ever-growing markets and demand for AI hardware solutions, AAEON is pleased to announce our new webpage, AAEON.ai. AAEON.ai offers developers and systems integrators a centralized resource for finding the latest AI edge computing technology from AAEON.

Market analysts have consistently pointed to expanded growth and deployment of Industry 4.0 technologies, especially AI edge computing, in various vertical markets. AAEON.ai collects all of AAEON's rugged, compact, industrial grade AI edge solutions in one convenient location. From boards and systems to AI accelerator modules, AI developers and systems integrators can easily find the platforms that meet their project, budget and performance needs. AAEON.ai will also feature solutions partners, allowing visitors to connect with local vendors and software providers, and building an AI ecosystem designed to make creating and deploying AI applications easier than ever. Visitors to AAEON.ai will also have a chance to learn about the latest news and browse a library of application stories and white papers of real-world applications using AAEON technology.



Visit AAEON.ai today and explore the latest in AI Edge technology from AAEON!



Shop Online for Prompt Global Service

AAEON eShop offers customers a convenient way to quickly place orders from a selection of our latest and most popular IPC, AI and Edge Computing platforms. Orders are processed and shipped within two working days on all in stock items, with 50% off worldwide shipping on all orders over US\$500. Customers can also order any accessories or configurations listed on the AAEON.com product page through eShop. Registering an account on eShop allows customers access to benefits including managing multiple shipping addresses, order tracking, price drop and in stock notifications and more! Visit AAEON eShop today at eshop.aaeon.com.

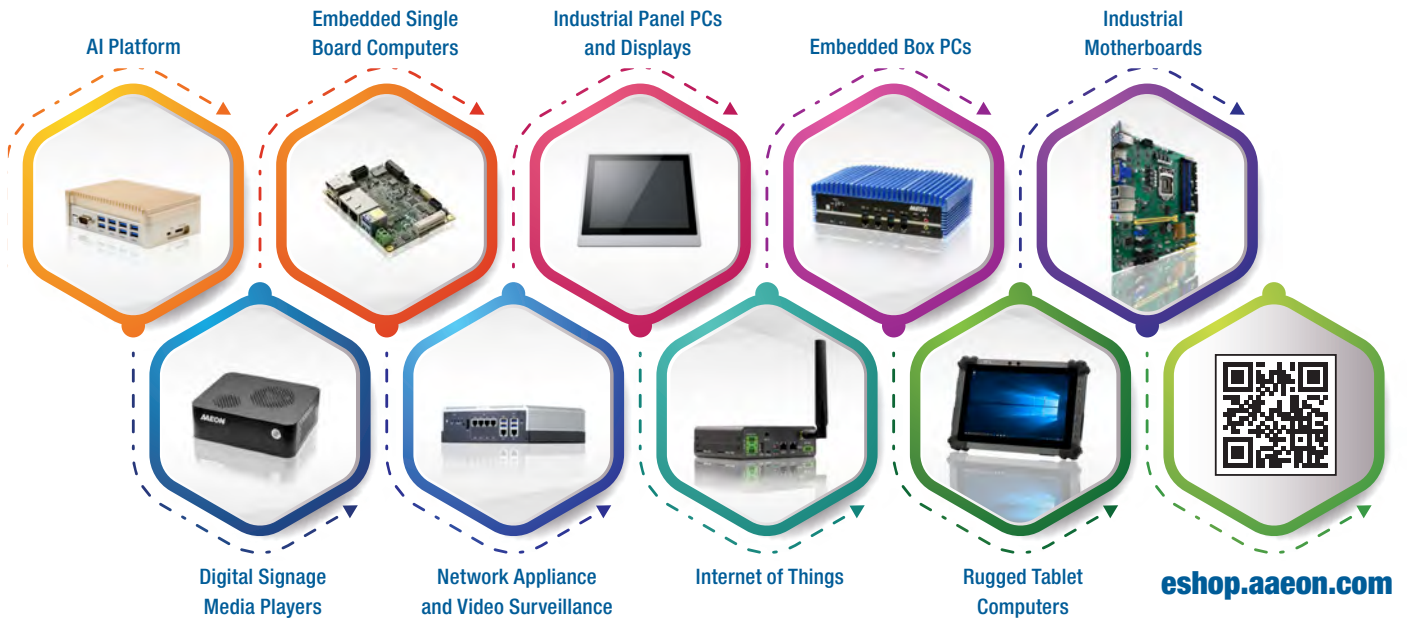

AAEON eShop Benefits



Fast Processing

eShop brings you the convenience of fast order processing. Orders are processed and shipped within two working days for all in-stock items.



Easy Payment

eShop supports payment options including credit card, PayPal™ and even wire transfer. (Advanced notification is needed when using wire transfer.)



50% off Shipping

Save more when you shop more with eShop! Receive 50% off global shipping on all eShop orders over US\$500.



Official Warranty

All products sold on eShop are backed by the same official warranty and industry leading support offered on every AAEON product.



Flexible Service

Purchase any product accessory or configuration listed on the AAEON.com product page, including processor, memory, storage and more. Contact AAEON eShop service representatives for more details. (eShop@aaeon.com)



eshop.aaeon.com

Join Us Now

Enjoy regular promotions!





BOXER-8641AI-PLUS

- NVIDIA® Jetson AGX Orin™
- Giga LAN x 1, 10G LAN x 1
- USB 3.2 Gen 2 (Type-A) x 4
- DB-9 x 1 for DIO x 8
- DB-9 x 2 for RS-232/422/485(Rx/Tx/RTS/CTS)



BOXER-8653AI

- NVIDIA® Jetson Orin™ NX
- GbE PoE/PSE 802.3af/at x 4 + GbE LAN x 1
- M.2 2230 E-Key x 1, M.2 2280 M-Key x 1
- M.2 3042/3052 B-Key x 1
- COM/CANBus/DIO
- Operating Temperature: -15°C ~ 60°C



BOXER-8645AI

- NVIDIA® Jetson AGX Orin™
- GMSL2 with FAKRA Connectors x 8
- 10G LAN x 1, Giga LAN x 1
- ACC Ignition Delay On/Off
- Military Standard Vibration and Shock



BOXER-8655AI

- NVIDIA® Jetson Orin NX
- GMSL2 with FAKRA Connectors x 8
- Giga LAN x 5
- TPM, 9-Axis sensor and GPS
- 9V ~ 36V DC in with ACC Ignition Delay On/Off
- Military Standard Vibration and Shock



BOXER-8651AI-PLUS

- NVIDIA® Jetson Orin™ NX w/ Super Mode
- Supports NVIDIA JetPack™ 6.2
- DB-9 x 1 for RS-232(Rx/Tx/RTS/CTS) & CANBus
- 10-Pin Header for DIO
- Onboard TPM
- M.2 2230 E-Key, M.2 3052 B-Key



MAXER-2100

- High-performance for AI inference
- 12/13th Gen Intel® Core™ LGA1700 Socket Processors
- High CPU computing performance: Build in i9-13900, up to i9-13900K supported
- supported
- 2U Rack Mount, Front Access I/O Design
- Onboard TPM 2.0



BOXER-8652AI

- NVIDIA® Jetson Orin™ NX
- 8GB LPDDR5
- Supports M.2 E-Key x 1, M.2 B-Key x 1
- M.2 M-Key x 1
- Supports DB-9 x 1 for CANBus
- Supports GbE LAN x 2



MAXER-5100

- Supports NVIDIA RTX™ 2000 Ada GPU x 2
- 12/13th/14th Gen Intel® Core™ LGA1700 Socket Processors
- M.2 2242/2280 M-Key x 1
- SATA Drive Bay x 2
- Onboard TPM 2.0



Industrial Automation



BOXER-6406U-ADN

- Intel Atom® x7211E and Intel® Processor N-series Processors
- DDR5 4800MHz via SODIMM
- 2.5GbE x 2
- M.2 2280 M-Key x 1, M.2 2230 E-Key x 1
- USB 3.2 Gen 2 (Type-A) x 2
- Onboard TPM 2.0



BOXER-6617-ADN

- Intel® Core™ i3 Processor N/Intel® Atom® Processor X/Intel®/Processor N-series SoC
- DDR5 4800MHz SODIMM x 1
- 2.5GbE x 2
- M.2 2280 M-Key/M.2 2230 E-Key
- M.2 3052 B-Key for 5G
- Onboard TPM 2.0



BOXER-6645U-RPL

- 12/13/14th Generation Intel® Core™ LGA 1700 socket-type
- Processor with Intel® H610E Chipset
- Wide Operating Temperature (-25°C ~ 70°C)
- HDMI output x 2
- GbE LAN x 2
- USB Type-A x 6



BOXER-6647-MTH

- Intel® Core™ Ultra 5/7 Processor
- DDR5 4800 SODIMM x 2, up to 64GB
- Accessible M.2 2280 NVMe SSD Tray + 2.5" SSD Tray
- M.2 3052 B-Key for 5G
- USB 3.2 Gen 2 (Type-A) x 4
- Onboard TPM 2.0

In-Vehicle



VPC-5640S

- 12th Gen Intel® Core™ i7 Processor
- DDR5 SODIMM x 2, Max 64GB
- 2.5GbE POE/PSE 802.3 af/at x 4
- Dual LTE Module with SIM Slots x 4, 5G Supported
- M.2 2280 M-Key (PCIe [x4])/M.2 2230 E-Key
- M.2 3052 B-Key x 2 (USB 2.0, USB 3.0)
- Onboard TPM 2.0



VPC-3350S

- Mobile Network Video Recorder Platform
- Fanless System
- 204-pin Single Channel DDR3L 1866 MHz SODIMM up to 8 GB
- Intel® Integrated Graphics Engine Supports Two Display by HDMI x 1, DP x 1
- Intel® Ethernet Connection x 5 Ports (including 4 x PoE Ports)



BOXER-8658AI

- NVIDIA® Jetson Orin™ NX
- PoE/PSE GbE LAN x 8
- Giga LAN x 2
- 9V ~ 36V DC in with ACC Ignition Delay On/Off
- Military Standard Vibration and Shock
- IMU, TPM, GNSS



Applications

Machine Vision



BOXER-6839

- Intel® 6th Core-i Desktop processor
- Mini-Card Slot x 2 (USB & PCIe Signal)
- PCIe [x1] + PCIe [x4]
- LAN x 3
- 34bit DIO
- Dual 2.5" Drive Bay Support



BOXER-6639M

- Intel® 6th Core-i Desktop processor
- Mini-Card Slot x 2 (USB & PCIe Signal)
- LAN x 7 or LANx3 + PoE x4
- 34bit DIO
- Dual 2.5" Drive Bay Support



BOXER-6843-ADS

- 12th/13th Generation Intel® Core™/Celeron® Processor G Serie
- DDR5 U-DIMM x 4
- HDMI x 2 + DP x 2
- PCIe [x16] + PCIe [x4] or Dual PCIe [x8] (in [x16] slot) + PCIe [x4]
- Supports Dual Graphics Cards with Dual Power Inputs
- Support NVIDIA L4

Robotics



UP Squared Pro 710H Edge

- Intel Atom® x7000 RE Series, Intel® Processor N Series, and Intel®
- Core™ i3-N305 Processors
- Onboard Hailo-8™ edge AI processor
- Onboard LPDDR5 Memory, up to 16GB
- Onboard eMMC Storage, up to 128GB
- 2.5GbE x 2 (Intel® I226-IT)
- USB 3.2 (Type-A) x 2



UP Xtreme ARL Edge

- Intel® Core™ Ultra 5/7 Processors
- Onboard Dual Channel LPDDR5 6400, up to 64GB
- Up to 4 Simultaneous Displays
- M.2 2280 M-Key x 2, M.2 3052 B-Key x 1 (5G), M.2 2230 E-Key x 1 (Wi-Fi/BT)
- 2.5GbE x 1, GbE x 1
- USB 3.2 Gen 2 (Type A x 2)
- Onboard TPM 2.0



Intelli i14 Edge

- Intel® Core™ i9 Processors (14th Gen), up to 65W
- Integrated NVIDIA RTX™ A2000/NVIDIA® RTX™ A4500 MXM Module
- Compact 205mm x 190mm x 70mm design
- M.2 2280 M-Key x 2 (NVMe)
- DDR5 SODIMM x 2, up to 32GB, 4800 MT/s, ECC supported



IoT Gateway



Smart Retail



UP-GWS01

- Intel® Cherry Trail x5-Z8350 SoC
- On board DDR3L 4GB memory
- 32GB eMMC storage
- 1x Giga LAN, 4x USB 2.0, 1xUSB 3.0,1x HDMI
- Optimized Fan-less Cooling Design
- Smallest Gateway system of Intel solution



UPS-GWS01

- Intel® Pentium® N4200/ Celeron® N3350 Processor SoC
- Onboard LPDDR4 Memory, eMMC Storage
- Gigabit LAN x 2
- HDMI x 1, DP x 1
- USB 3.0 x 3, USB 3.0 OTG x 1



SRG-AM62

- ARM TI AM62x, up to Quad 64-bit Arm® Cortex®-A53
- DDR4, up to 4 GB, eMMC 5.1 x 1
- HDMI 1.4b x 1
- GbE x 2
- USB 2.0 x 2
- Minicard x 2 (half x 1, full x 1)



SRG-IMX8PL

- ARM NXP i.MX8M Plus Quad-Core, Cortex-A53 1.6GHz
- LPDDR4, up to 4 GB, eMMC 5.1 x 1
- HDMI 2.0 x 1
- GbE x 2
- USB 3.0 Gen 1 x 2
- M.2 2230 E Key x 1, Full-sized minicard x 1



UP 7000 Edge

- Intel® Processor N-series
- Onboard LPDDR5 Memory, up to 8GB
- Onboard eMMC Storage, up to 64GB
- 1Gigabit LAN x 1
- HDMI 1.4b x 1
- USB 3.2 Gen 2 (Type-A) x 3, 10-pin USB 2.0 x 2/ UART x 1



UP Squared i12 Edge

- 12th/13th Generation Intel® Core™ i7/i5/i3/Celeron® Processor SoC
- Up to 16GB Onboard LPDDR5
- Up to 128GB Onboard SSD
- M.2 2230 E-Key/M.2 2280 M-Key/SATA 6Gb/s x 1
- 1GbE x 2
- HDMI 1.4b x 1, DP 1.2 x 1, DP 1.4a via USB Type-C x 1
- USB 3.2 x 3 (Type A x 2, Type C x 1)



UP Squared TWL Edge

- Intel® Processor N-series SoC
- Onboard LPDDR5 Memory up to 16GB
- Onboard eMMC Storage up to 128GB
- Gb Ethernet (full speed) RJ-45 x 2
- USB 3.2 Type A x 3
- DP 1.2 / HDMI 2.0b / eDP 1.3



IoT Solutions

Edge AI Introduction

AAEON's is committed to bringing AI to the edge as part of its mission to help customers develop intelligent applications across smart city, industrial automation, healthcare, and retail solutions. We integrate the newest and most innovative AI technologies into our platforms to optimize their suitability for different industry needs. For end customers, the primary benefits of working with AAEON to bring AI to their businesses are the flexibility offered throughout the development process, the elite performance of our platforms, and the broad selection of technologies we are able to harness to bring solutions to market. As a committed service provider, our first priority is connecting customers with the most suitable platforms with which to build new, sustainable, and reliable solutions.





Manufacturing & Industry

In a broader context, AI is a valuable tool through which to optimize industrial setups to make them more efficient, cost-effective, and productive. By processing and analyzing vast swathes of data, industrial AI systems can autonomously execute tasks across the sector, from inference-based quality inspection eliminating inefficiencies to autonomous mobile robot deployment streamlining day-to-day operations.



Intelligent Healthcare

In healthcare, real-time AI at the edge is shaping the future of patient care and medical innovation. Applications such as diagnostic imaging, patient monitoring, and hospital automation benefit from low-latency inference and enhanced privacy through local data processing. AAEON helps healthcare providers build solutions that improve outcomes, streamline operations, and deliver smarter, more personalized care.



Smart Retail

From intelligent inventory tracking to customer behavior analytics, Edge AI is helping retailers transform the shopping experience. AAEON platforms enable real-time decision-making on the shop floor, powering applications such as AI-driven checkouts, automated inventory management, frictionless shopping, and intelligent vending machines. With smarter insights, retailers can create more engaging and efficient environments for their customers.



Smart Cities

Edge AI is the foundation of sustainable, connected urban ecosystems. By powering intelligent transport architectures, public safety systems, energy management solutions, and environmental monitoring applications, AAEON helps cities become safer, greener, and more livable. Our solutions empower municipalities to act in real time, improving quality of life while building resilient infrastructure for the future.



Design Manufacturing Service

Design Manufacturing Service (DMS) offers exceptional end-to-end services from product conceptualization, product development to manufacturing and service programs. All services are linked together through a comprehensive process and closely monitored by dedicated professionals to guarantee the highest level in product quality, reliability and durability.

Collaboration Models



Customers can consign to AAEON the manufacturing of their existing products, customize existing AAEON COTS products, or joint develop new products with the expertise of a dedicated project team that oversees the project from product conceptualization to on-time delivery of the goods. AAEON DMS handles Large-volume as well as Low-Volume-High-Mix projects, satisfying the need of our customers for every kind of computing platform requirements.

Areas of Expertise

- Retail
- Transportation
- Energy
- Automation
- Medical and Healthcare
- Networking

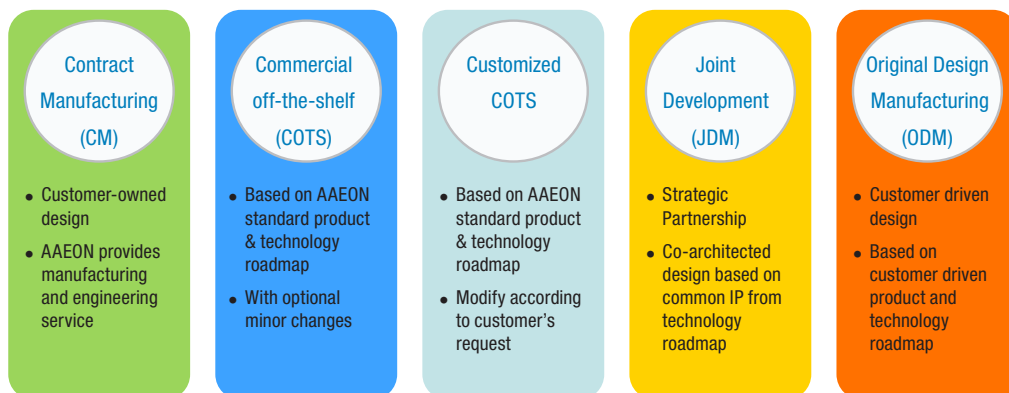

Wide Temperature Assurance Service (WiTAS)

Wide Temperature Embedded Computing

Applications of embedded computing systems continue to improve the quality and convenience of our lives. As the global population increases, there are greater demands on resources, and the need for automation and computing capability in remote regions will grow. To address a demand for computers that operate in extreme environments, platforms must follow design methodologies for wide temperature range use. In addition, testing and product qualification must follow more stringent criteria to assure continuous operation. As the core of any embedded system, the CPU board plays perhaps the most critical role and, therefore, requires careful design and validation for wide temperature capabilities.

AAEON has been designing and manufacturing quality embedding products for over two decades. Our accumulated experience in all aspects of the embedded electronics market puts us in a strong position to develop wide temperature CPU boards and systems.

AAEON's WiTAS (Wide Temperature Assurance Service) program produces boards in two temperature range categories:

-20°C to 70°C (-4°F ~ 158°F) = WiTAS 1

-40°C to 85°C (-40°F ~ 185°F) = WiTAS 2

Processes for WiTAS Production

WiTAS 1 Production

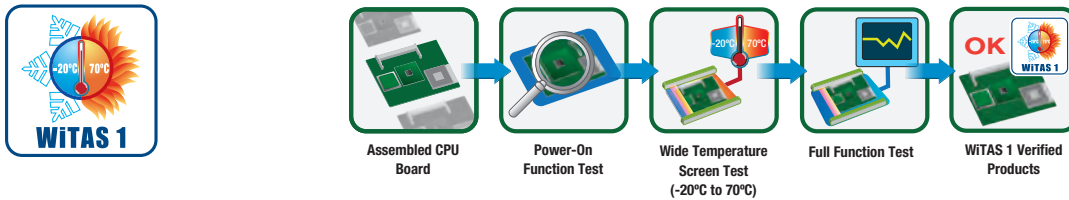

WiTAS 2 Production

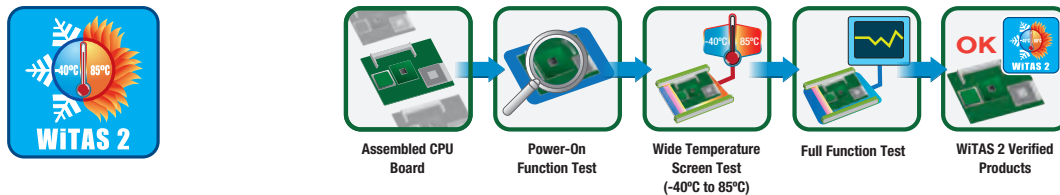

Boards that pass -20°C to 70°C (-4°F ~ 158°F) thermal tests are given a WiTAS 1 designation, and boards that endure -40°C to 85°C (-40°F ~ 185°F) tests are assigned a WiTAS 2 designation, as part of AAEON's special service assurance of wide temperature durability and reliability. This, in conjunction with the use of durable components throughout the duration of testing, allows AAEON to enhance the longevity of its boards and systems.

Application

Applications for WiTAS CPU boards can be found in a range of industries and markets:

- Transportation: Trains, Ships, Airplanes and Traffic Surveillance Systems
- Factory Automation: Power Stations, Steel Manufacturing
- Military: Field Electronic Devices, Controllers
- Energy: Windmill Controllers, Solar Energy Controllers
- Environmental: Climate, Water, Air Quality
- Anti-dust, Fanless Applications: Medical, Chemical and Pharmaceutical Factories



AAEON's Embedded OS Solution

AAEON provides Embedded OS Solutions to customers who are in need of OS customization. AAEON's Embedded OS Solutions are designed to shorten times to market and save our customers' time and R&D resources.

Windows® Embedded Products

 Windows 10 IoT

**Windows 10 IoT Enterprise LTSC
1809/ 2021**

 Windows 11 IoT

**Windows 11 IoT Enterprise LTSC
2024**

AAEON Embedded OS Solution

Chipset	Windows® 10 IoT Enterprise	Windows® 11 IoT Enterprise
NXP i.MX8 plus WOA (Windows on ARM)	✓	—
NXP i.MX8 Mini WOA (Windows on ARM)	✓	—
Intel® Core™ Ultra Processors Series 2 Arrow lake	✓	✓
Intel® Core™ Ultra Processors Series 1 Meteor Lake	✓	✓
Intel® 13th and 14th Raptor Lake	✓	✓
Intel® 12th Alder Lake	✓	✓
Intel® 11th Tiger Lake	✓	✓
Intel® 10th Comet Lake	✓	✓
Intel® 8th and 9th Coffee Lake	✓	✓
Intel® 8th Whiskey Lake	✓	✓
Intel® 7th KabyLake (Q170/H110/C236)	✓	✓
Intel® 6th SkyLake (Q170/ H110/C236)	✓	—
Intel® ApolloLake (N4200/N3350/E3930/E3940/ E3950)	✓	—



Hi-Safe is a powerful, free program which provides SDKs for systems and UIs running Microsoft® Windows® operating systems. Hi-Safe controls system hardware by utilizing the Windows Management Interface, providing a safe and standard interface for Windows machines. Hi-Safe allows end users to easily develop their own UI software to monitor vital system components such as the processor, RAM and display. It also provides interface and functionality for Hardware Monitor, Digital I/O, Watchdog timer, Smart Fan settings, SM Bus, and backlight controller for LVDS and eDP. With the SDK user interface, no coding is needed, and customers can create their own user interface by using the function codes provided by AAEON. Customers can download the Hi-Safe V3 application directly from the Microsoft Store.

Hi-Safe V3 Advantages

Modern and Flexible User Interface

Easy and Friendly to Use

Safe Operation Control for Windows



System Information:

Receives CPU, display and RAM information



Hardware Monitor:

Receives super I/O, fan, temperature and voltage data



Smart Fan:

Supports multi-stage adjustment of temperature and speed controls



DIO:

Obtains DIO information: sets the pin direction and pin data



SM Bus:

Reads and writes to SMBus device and detects SMBus base address automatically

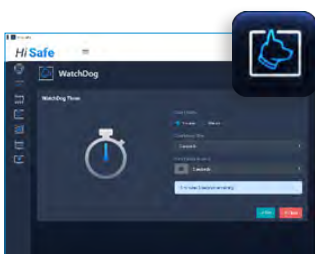

Watchdog:

Sets the system reboot timer

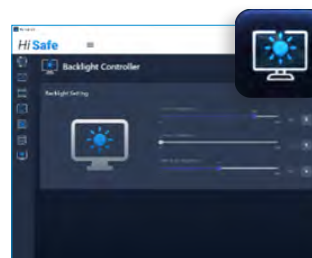

Backlight Controller:

Controls LVDS or eDP display



AAEON AI-Angel

One Click to Accelerate Your AI

AI Angel is a powerful tool designed to deliver a unified AI model toolkit for systems operating on various hardware devices. It seamlessly integrates inference frameworks such as OpenVINO, Hailo RT, and CUDA, providing a secure and efficient standardized interface for AI applications. AI Angel empowers users to effortlessly build AI models while fully leveraging the performance of CPUs, GPUs, NPUs and dedicated AI accelerator chips. Its core features include one-click environment setup, cross-hardware performance acceleration, and visual performance analysis. Through an intuitive user interface, users can quickly apply trained models to target devices without needing to delve into complex underlying configurations.

AI-Angel Advantages

Modern and Flexible User Interface

Simple One-Click Environment Setup

Real-Time Hardware Usage Monitoring

BIOS2 (BIOS + OS) Optimization Setting

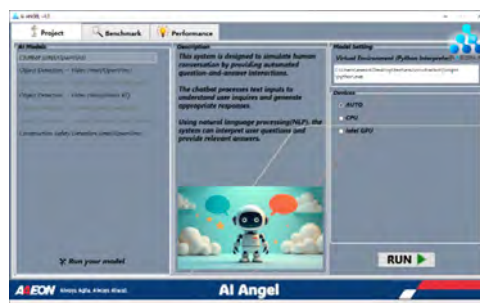

Supports

AI Accelerator	Windows 10 21H2 LTSC	Windows 11 24H2 LTSC
Hailo 8	✓	✓
Intel NPU	—	✓
Intel GPU	✓	✓
Nvidia GPU	✓	✓



Project:

Select the AI project and the execution device



Use your model:

Allow users to use their own models to execute



Project:



Performance:



BIOX is a BIOS customization SaaS solution for AAEON products. Most field applications and deployments require BIOS customization for platforms and systems to meet a customer's requirements. Often this requires constant communication with vendors, possibly delaying deployment or slowing down maintenance. With BIOX, the end user can customize the BIOS on their own, anytime, in five simple steps, without the need to contact a service rep.

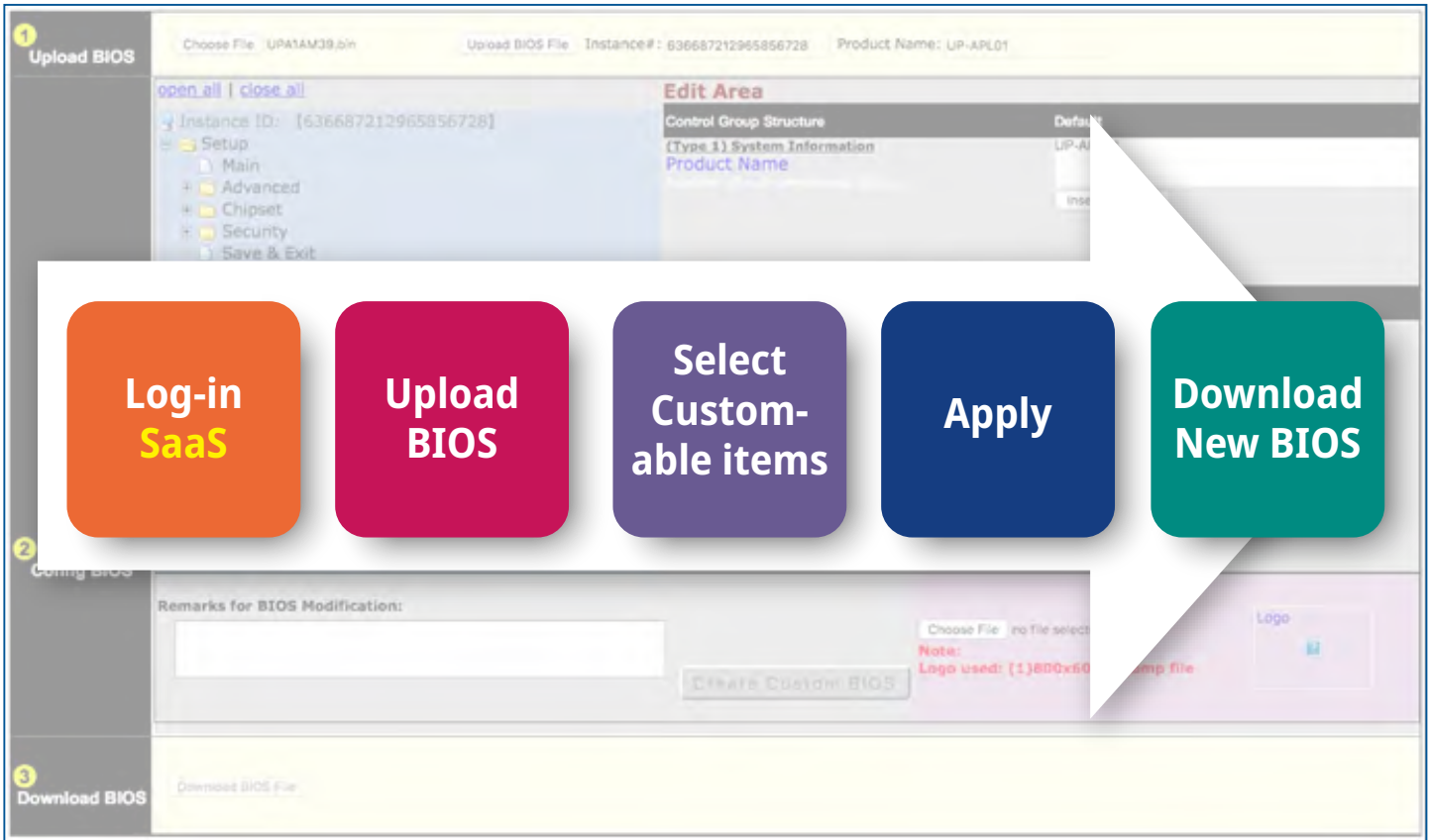

BIOX Advantages

Modern and Flexible User Interface

- Logo
- Boot Order
- Setup Values
- SMBIOS Strings
- Password Management

Version Control Access

- Retrievable
- Re-customizable
- History Traceable



AAEON Software Support Portal:
<https://aaeoncm.github.io/>

UP Edge AI Toolkit

The new UP Edge AI Toolkit provides you with a comprehensive framework through which to build, convert, and deploy AI models across the UP hardware ecosystem. Combining a one-click runtime environment setup, cross-platform model conversion, embedded benchmarking tools for performance simulation, and out-of-the-box compatibility with hardware from across the UP series of developer boards, the free UP Edge AI Toolkit makes AI project development and deployment faster, simpler, and more reliable.



AAEON's Multilayered Software Security Framework

Recognizing the need for a more comprehensive solution, AAEON has developed a multilayered software security framework designed to address security threats throughout each level of the AI application ecosystem. This framework includes server-side management tools, device-level security mechanisms, and secure tunnel communication protocols, all working in concert to maintain the integrity of critical edge AI application data. This package includes AAEON's tailored Trusted Execution Environment (TEE) for AI model protection, MAZU, which is now available on the BOXER-8621AI, BOXER-8641AI-Plus, and the BOXER-8651AI-Plus, with expansion to additional products from AAEON's Embedded AI System range to follow.





AI@Edge Solutions

AAEON's AI@Edge platforms feature embedded platforms purpose-built for powering Artificial Intelligence and Edge Computing applications. Utilizing the most innovative edge AI technologies from leading providers such as NVIDIA and Intel, these systems are designed with a range of I/O configurations conducive to optimal performance across different vertical markets.



RISC Gateway

AAEON's RISC gateway series focuses on combining efficient processing platforms with robust, multifaceted communication protocols to make edge computing in IoT environments easier. Based on Arm architecture, AAEON's RISC Gateways feature foundations that include Texas Instruments AM62x Sitara™ Processors, the NXP i.MX9 and i.MX8M Plus series, as well as barebone kits designed to accommodate Raspberry Pi Compute Modules.



Fanless Embedded BOX PC

AAEON's Fanless Embedded Box PC ("BOXER") Series delivers a comprehensive range of industrial-grade, fanless embedded systems designed for edge computing, Industry 4.0, and industrial IoT (IIoT) applications. Built to combine performance, efficiency, and reliability in a variety of form factors, the BOXER Series is the gold standard across smart manufacturing, transportation, automation, surveillance, and more.



Expansion BOX PC

AAEON's Expansion Box PCs are made to bring modularity to industrial computing, opening the door to more advanced, flexible configurations that include 12th, 13th, and 14th Generation Intel® Core™ processors (formerly Alder Lake and Raptor Lake), high-performance GPUs, and wireless modules. Moreover, the series is designed for maximum thermal efficiency, allowing for the installation of multiple expansion cards, such as AI accelerators, storage, and wireless modules without the risk of overheating, particularly suited to bringing advanced inferencing to the edge.



In-vehicle Embedded BOX PC

AAEON's lineup of in-vehicle Box PCs address the growing market need for advanced driver assistance systems (ADAS), real-time threat and hazard detection, and autonomous vehicles such as AMRs. Each system provides crucial power management and power safety features to prevent damage from fluctuating voltage inputs or damaging the vehicle's own electrical system and batteries. The series offers a broad selection of communication interfaces, including CANBus, PoE LAN, and serial ports alongside 5G, 4G/LTE, and cellular network expansion.



AI Inference Server Series

provides the foundation for the future of AI technology. Offering both CPU/GPU-integrated and barebone systems configurable to meet project demands, AAEON AI Inference Server Systems blend raw processing power and scalable AI inference performance to act as standalone, heavy-duty solutions or as the central server for multi-device deployments.



UP Series

All of the strength and utility of the UP board in compact industrial edge computing system form, the newest UP systems enable users to bring projects to market faster, without sacrificing quality. UP x86 industrial Edge systems ensure the key facets their board-level counterparts, such as the latest in Intel® processor and inference modelling platforms, are easily harnessed via precisely designed



01

01

AI@Edge Solutions



BOXER-8221AI

AI@Edge Compact Fanless Embedded BOX PC with NVIDIA® Jetson Nano™

Front View

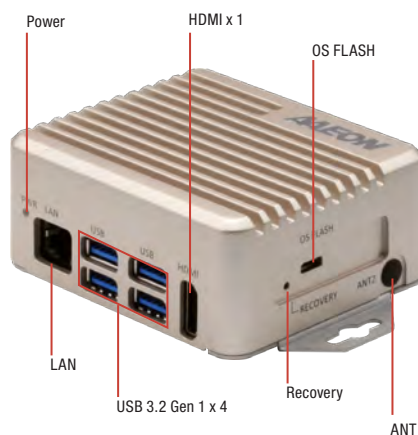

Rear View

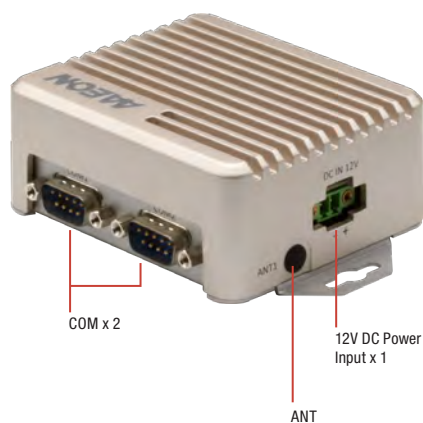

Features

- NVIDIA® Jetson Nano™
- Quad-core ARM Cortex-A57 processor
- 4GB LPDDR4 + 16GB Micro-SD or eMMC
- LAN x 1 + RS-232 x 2
- 12Vdc Power input



Specifications

System	
AI Accelerator	NVIDIA Jetson Nano
CPU	Quad Core Arm® Cortex®-A57 MPCore Processor
System Memory	4GB LPDDR4
Storage Device	32GB Micro-SD (A version) or 16GB eMMC (B version)
Display Interface	HDMI 2.0
Ethernet	10/100/1000Base-TX x 1
I/O	USB 3.2 Gen 1 x 4 LAN x 1 RS-232 x 2 HDMI x 1 MicroSD x 1 DC Power Input x 1 Recovery Button x 1 Micro-USB for Flash OS x 1
Expansion	M.2 E-Key 2230 x 1(for WiFi)
Indicator	Power LED x 1
OS Support	Linux (AAEON ACLinux 4.9) Linux (NVIDIA Jetpack 4.5)
Power Supply	
Power Requirement	12Vdc w/ 2-pin terminal block
Mechanical	
Mounting	Wallmount
Dimensions (W x D x H)	3.39" x 2.87" x 1.3" (88mm x 75mm x 39mm)
Gross Weight	1.10 lb (0.5 kg)
Net Weight	0.66 lb (0.3 kg)
Environmental	
Operating Temperature	-4°F ~ 122°F (-20°C ~ 50°C, according to IEC60068-2 with 0.5 m/s AirFlow)
Storage Temperature	-49°F ~ 176°F (-45°C ~ 80°C)
Storage Humidity	95% @ 40°C, non-condensing
Anti-Vibration	3 Grms/ 5 ~ 500Hz/ operation – MicroSD or eMMC
Anti-Shock	—
Certification	CE/FCC class A





Dimension

Unit: mm

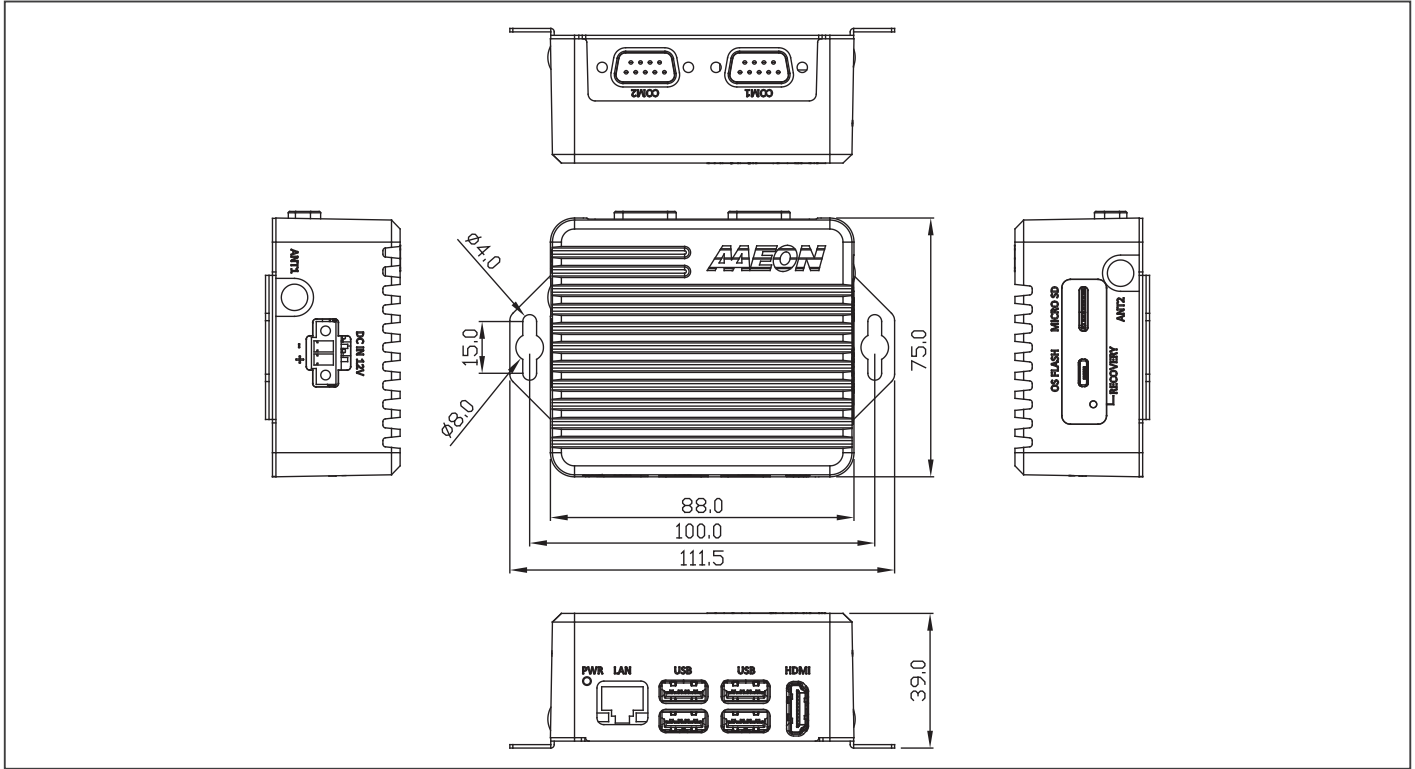

Ordering Information

Part Number	AI Solution	LAN	USB	RS-232/422/485	Storage	Display	Mounting	Power	Operation Temp	Operation System
BOXER-8221AI-JP46E-D1-1010	Jetson Nano	1	USB 3.2 Gen 1 x 4	2	16GB eMMC MicroSD Slot x 1	HDMI x 1	Wallmount	12Vdc w/ 2 pin terminal block	-20°C ~ 50°C	NVIDIA Jetpack 4.6
BOXER-8221AI-JP46S-D1-1010	Jetson Nano	1	USB 3.2 Gen 1 x 4	2	16GB eMMC 64GB MicroSD x 1	HDMI x 1	Wallmount	12Vdc w/ 2 pin terminal block	-20°C ~ 50°C	NVIDIA Jetpack 4.6

Packing List

- Wallmount Bracket x 2
- Power Connector x 1
- BOXER-8221AI

Optional Accessories

- 1255300611
60W Power Adapter
- 170X000799
Power Cord (US type)
- 170X000800
Power Cord (European Type)
- 170X000803
Power Cord (Japanese Type)

BOXER-8223AI

AI@Edge Compact Fanless Embedded AI System with NVIDIA® Jetson Nano™

Front View

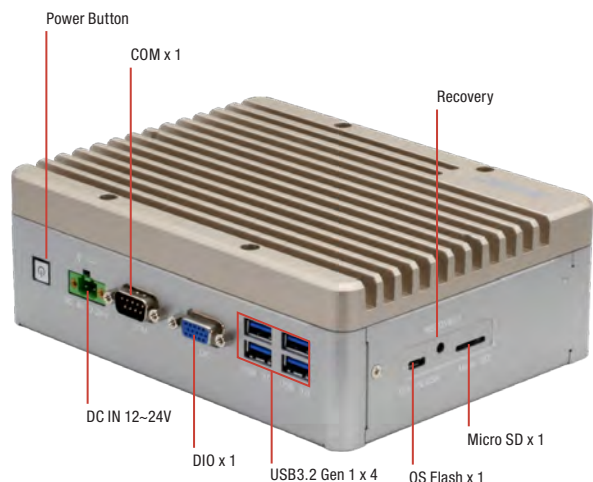

Rear View

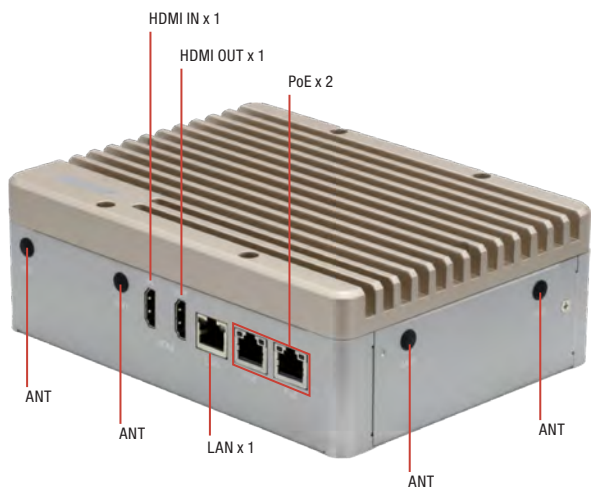

Features

- NVIDIA® Jetson Nano™
- 4GB LPDDR4
- 16GB eMMC + Micro SD Card Slot
- PoE/PSE GbE LAN x 2
- HDMI Input
- Digital I/O 13-channel
- Full-size Mini Card x 1 w/ SIM Slot
- 12~24Vdc Power Input



Specifications

System	
AI Accelerator	NVIDIA® Jetson Nano™
CPU	Quad Core ARM® Cortex®-A57 MPCore Processor
System Memory	4GB LPDDR4
Storage Device	16GB eMMC + Micro SD Card Slot 2.5" SATA Drive Bay x 1
Display Interface	HDMI 2.0 (Type-A) x 1 (Output) HDMI 1.4 (Type-A) x 1 (Input)
Ethernet	PoE/PSE LAN x 2 (IEEE 802.3at)
I/O	USB 3.2 Gen 1 (Type-A) x 4 GbE LAN with LED Indicator PoE/PSE LAN x 2 (IEEE 802.3at) DB-9 x 1 for RS-232/485 DB-15 x 1 Female for 13-Channel DIO O.S Flash Port x 1 Recovery Port x1 Antenna Opening x 2 HDMI 2.0 (Type-A) x 1 (Output) HDMI 1.4 (Type-A) x 1 (Input via MIPI CSI) Power Bottom x 1
Expansion	Mini Card x 1 w/ SIM Slot M.2 2230 E-Key x 1 (for Wi-Fi)
Indicator	Power LED x 1
OS Support	NVIDIA Jetpack™ 4.5 or above
Power Supply	
Power Requirement	DC 12V~24V with 2-pin terminal block ATX mode
Mechanical	
Mounting	Wallmount (default)
Dimensions (W x D x H)	7.09" x 5.35" x 2.41" (180.0mm x 136.0mm x 61.1mm)
Gross Weight	4.63 lb (2.1kg)
Net Weight	2.87 lb (1.3kg)
Environmental	
Operating Temperature	14°F ~ 158°F (-10°C ~ 70°C), with 0.5m/s airflow
Storage Temperature	-40°F ~ 176°F (-40°C ~ 80°C)
Storage Humidity	5 ~ 95% @ 40°C, non-condensing
Anti-Vibration	Random, 3 Grms, 5~500Hz
Anti-Shock	50G peak acceleration (11 msec. duration,eMMC)
Certification	CE/FCC Class A/UKCA





Dimension

Unit: mm

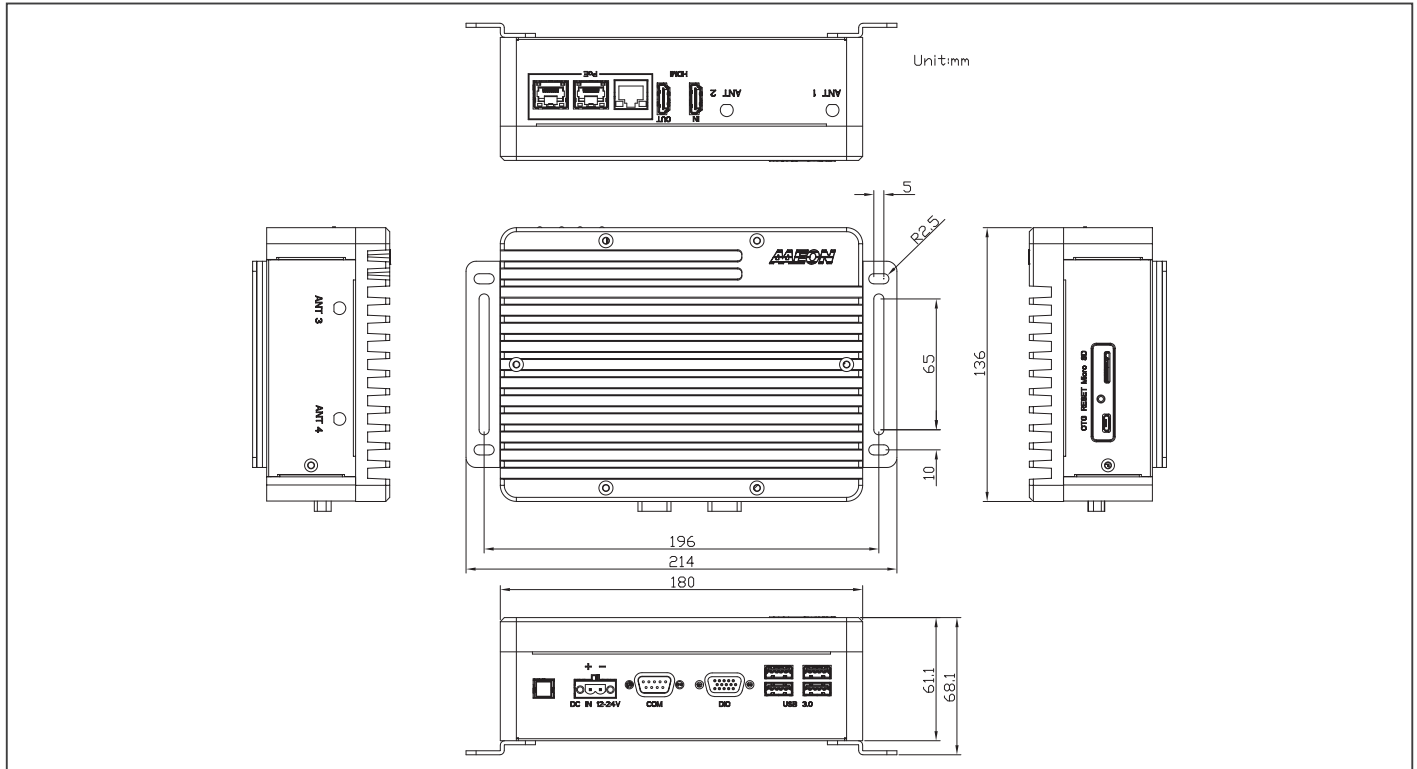

Ordering Information

Part Number	AI Accelerator	LAN	POE	USB	RS-232/485	Storage	Display	Mounting	Power	Operation Temp	Operation System
BOXER-8223AI-JP46E-A1-1010	NVIDIA® Jetson Nano™	1	2	USB 3.2 Gen 1 x 4	1	16GB eMMC + MicroSD 2.5" SATA drive bay x 1	HDMI IN x 1 HDMI OUT x 1	Wallmount	DC 12V-24V	-10°C ~ 70°C with 0.5m/s airflow	NVIDIA Jetpack™ 4.6
BOXER-8223AI-JP462E-A1-1110	NVIDIA® Jetson Nano™	1	2	USB 3.2 Gen 1 x 4	1	16GB eMMC + MicroSD 2.5" SATA drive bay x 1	HDMI IN x 1 HDMI OUT x 1	Wallmount	DC 12V-24V	-10°C ~ 70°C with 0.5m/s airflow	NVIDIA Jetpack™ 4.6.2

Packing List

- Power Connector
- BOXER-8223AI

Optional Accessories

- **1255X00066**
120W Power Adapter
- **170X000799**
Power Cord (US type)
- **170X000800**
Power Cord (European Type)
- **170X000803**
Power Cord (Japanese Type)

BOXER-8224AI

AI@Edge Embedded System with NVIDIA® Jetson Nano™

Front View

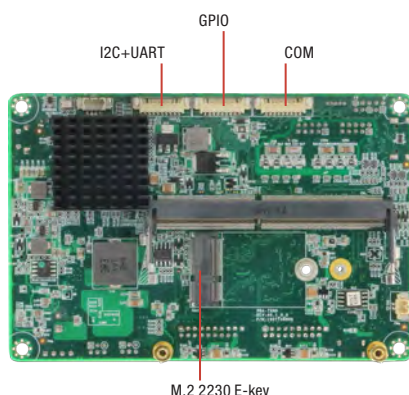

Rear View

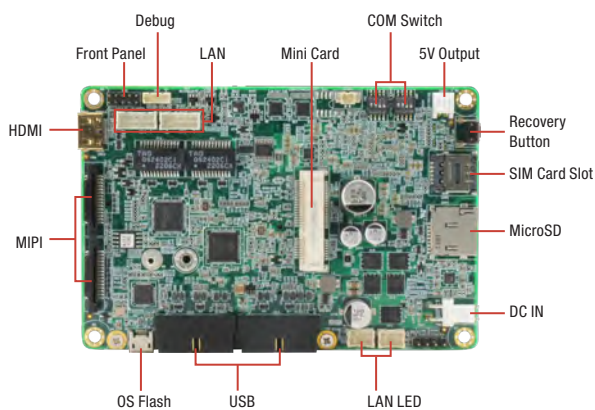

Front View with Module

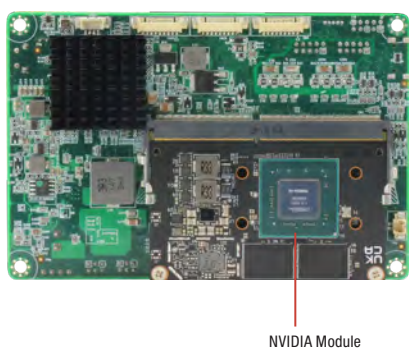

Features

- NVIDIA® Jetson Nano™
- MIPI Connector x 2
- MicroSD x 1, Mini Card x 1, M.2 2230 E-Key x 1
- GbE LAN x 2, USB 3.2 x 4, GPIO, UART, I2C (via Wafer)
- 12V ~ 24V Wide Power DC Input



Specifications

System	
AI Accelerator	NVIDIA® Jetson Nano™
CPU	ARM® Cortex® -A57 Quad-Core Processor
System Memory	4GB LPDDR4
Storage Device	16GB eMMC 5.1 x 1 MicroSD slot x 1
Display Interface	Mini HDMI x 1 for HDMI 2.0
Ethernet	Wafer connector x 2 for Giga LAN
I/O	USB 3.2 Gen 1 x 4 (via 2x19-Pin Wafer) Mini HDMI x 1 for HDMI 2.0 RS-232/485 x 2 (via 1x9-Pin Wafer) UART x 1 and I2C x 2 (via 1x9-Pin Wafer) 5V Output (via 1x2-Pin Wafer) GPIO x 6 (via 1x9-Pin Wafer) MIPI Connector x 2 for MIPI Camera LAN LED x 2 (via 2x6-Pin Wafer) Micro USB for Flash OS x 1 Recovery Button x 1 Reset Button x 1 and Power Button x 1 (via Pin Header)
Expansion	M.2 2230 E Key x 1 for Wifi/BT Mini Card x 1 (LTE) Micro SD x 1 SIM card slot x 1
Indicator	—
OS Support	Linux (NVIDIA Jetpack™ 4.6 and above)
Power Supply	
Power Requirement	Wafer connector x 1 for 12V ~ 24V DC
Mechanical	
Mounting	—
Dimensions (W x D x H)	4.72" x 3.1" x 0.76" (120mm x 80mm x 19.7mm), SOM + Carrier Board Only
Gross Weight	0.45lb (0.2kg)
Net Weight	0.23lb (0.1kg)
Environmental	
Operating Temperature	-4°F ~ 140°F (-20°C ~ 60°C with 0.5 m/s airflow)
Storage Temperature	-49°F ~ 176°F (-45°C ~ 80°C)
Storage Humidity	5 ~ 95% @ 40°C, non-condensing
Anti-Vibration	3.5Grms / 5~500Hz / X/Y/Z axis, random (by M.2 storage)
Anti-Shock	—
Certification	CE/FCC Class A





Dimension

Unit: mm

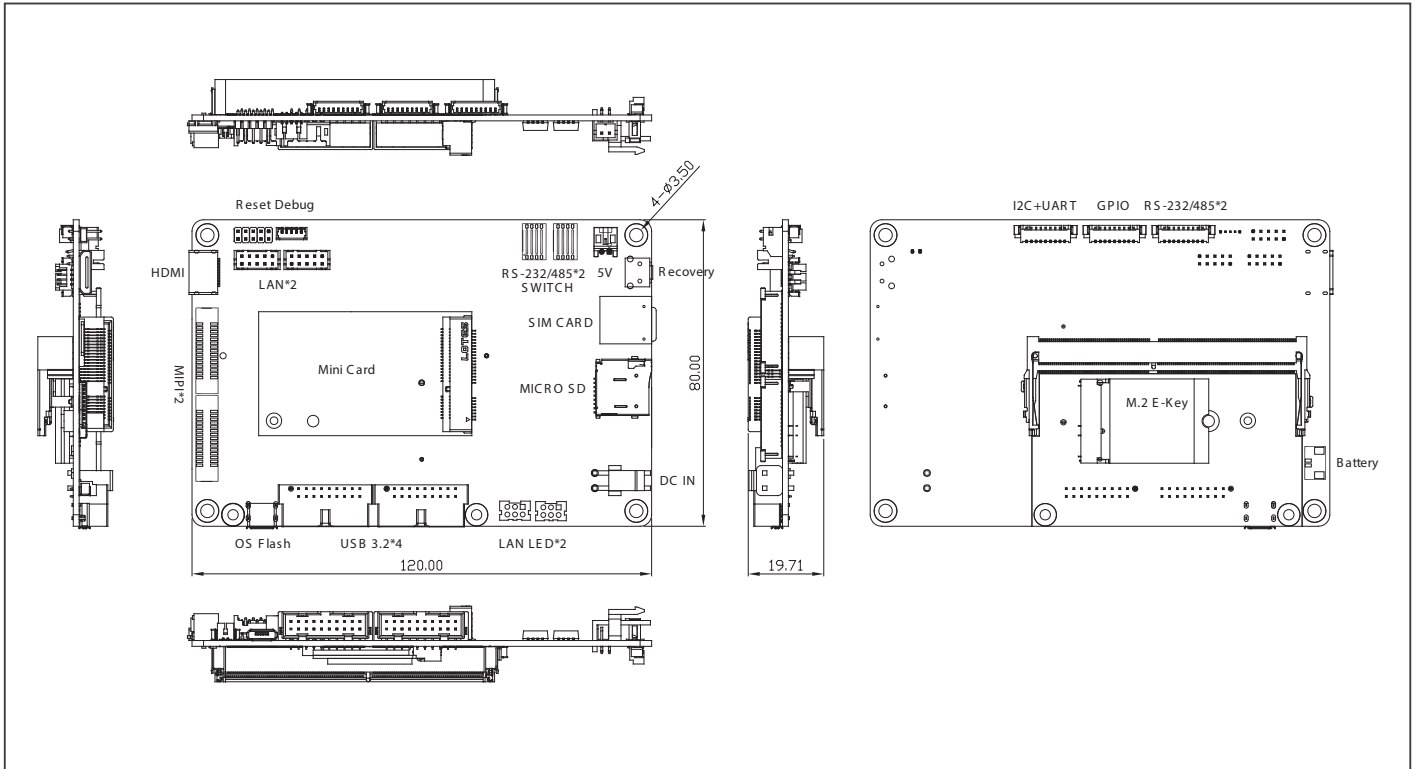

Ordering Information

Part Number	AI Solution	MIPI	LAN	USB	COM	UART	I2C	DISPLAY	Expansion Slot	Power	Operation System	Remark
BOXER-8224AI-JP462E-KIT-A1-1010	Jetson Nano™	2	2	4	2	1	2	HDMI x 1	M.2 2230 E Key x 1, Micro SD x 1, Mini card x 1	12V ~ 24V DC	Linux (NVIDIA Jetpack 4.x up)	with Nano SOM, w/o Cable

Packing List

- BOXER-8224AI (with Nano SOM, w/o Cable) x 1

Optional Accessories

- 9651822400
Development Cable Kit
- 1255900603
60W Power Adapter
- 170X000799
Power Cord (US Type)
- 170X000800
Power Cord (European Type)
- 170X000803
Power Cord (Japanese Type)

BOXER-8240AI

AI@Edge Fanless Embedded Box PC with NVIDIA® Jetson AGX Xavier™

Front View

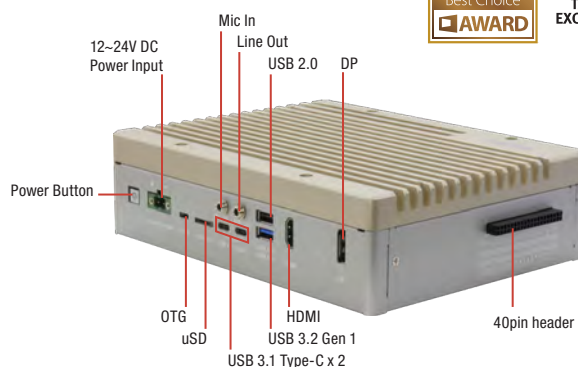

Rear View

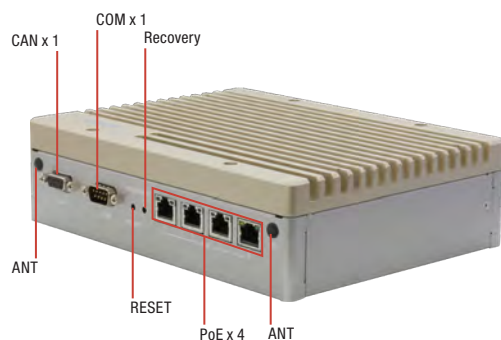

Bottom View

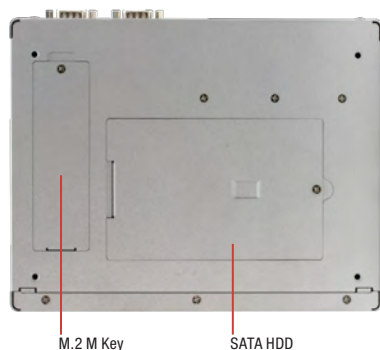

Features

- 512-core Volta GPU with Tensor Cores
- Support RJ-45 x 4 for PoE (802.3af, total 60W)
- Support DB-9 x 1 for RS-232/422/485, CANBUS x 1
- Support 40-pin header, Mic in and Line out
- Support M.2 E key, M key and SATA storage



Specifications

System	
AI Accelerator	NVIDIA® Jetson AGX Xavier™
CPU	8-core ARM v8.2 64bit CPU, 8MB L2 + 4MB L3
System Memory	32GB 256-Bit LPDDR4x 137GB/s
Storage Device	32GB eMMC 5.1 Micro SD card slot 2.5" SATA drive bay M.2 Key M 2280
Display Interface	HDMI 2.0 x 1
Ethernet	10/100/1000 Base-TX with IEEE 802.3af PoE LAN x 4
I/O	PoE x 4 (IEEE 802.3af, total 60W) USB Type A x 1 for USB 3.2 Gen 1 USB Type C x 2 for USB 3.2 Gen 1 USB Type A x 1 for USB 2.0 RS-232/422/485 x1 CANBUS x 1 HDMI 2.0 x1 DP 1.4 x 1 Mic-in x 1 Line-out x 1 MicroSD slot x 1 Micro USB x 1 for OS Flash Recovery button x 1 Power button x 1 40-pin header compliance with NVIDIA Dev Kit 40 pins (4 pins CANBUS occupied)
Expansion	USB 2.0 header x 1 (Optional, circuit reserved) M.2 Key E 2230 x 1 for WiFi/Bluetooth (PCIe[x1] + USB) M.2 Key M 2280 x 1 (PCIe[x4]) SATA x 1 RS-232/422/485 pin header x 1
Indicator	Power LED x 1
OS Support	Linux (NVIDIA Jetpack 4.5 and above)
Power Supply	
Power Requirement	DC 12V-24V 2-pin terminal
Mechanical	
Mounting	Wallmount
Dimensions (W x D x H)	8.26" x 6.46" x 2.32" (210mm x 164.2mm x 59mm)
Gross Weight	6 lbs (2.72kg)
Net Weight	4.23 lbs (1.92kg)
Environmental	
Operating Temperature	14°F ~ 131°F (-10°C ~ 55°C, according to IEC60068-2 with 0.5 m/s AirFlow)
Storage Temperature	-40 °F ~ 158°F(-40°C ~ 70°C)
Storage Humidity	95% @ 40°C, non-condensing
Anti-Vibration	Random, 3 Grms, 5 ~ 500Hz
Anti-Shock	—
Certification	CE/FCC class A





Dimension

Unit: mm

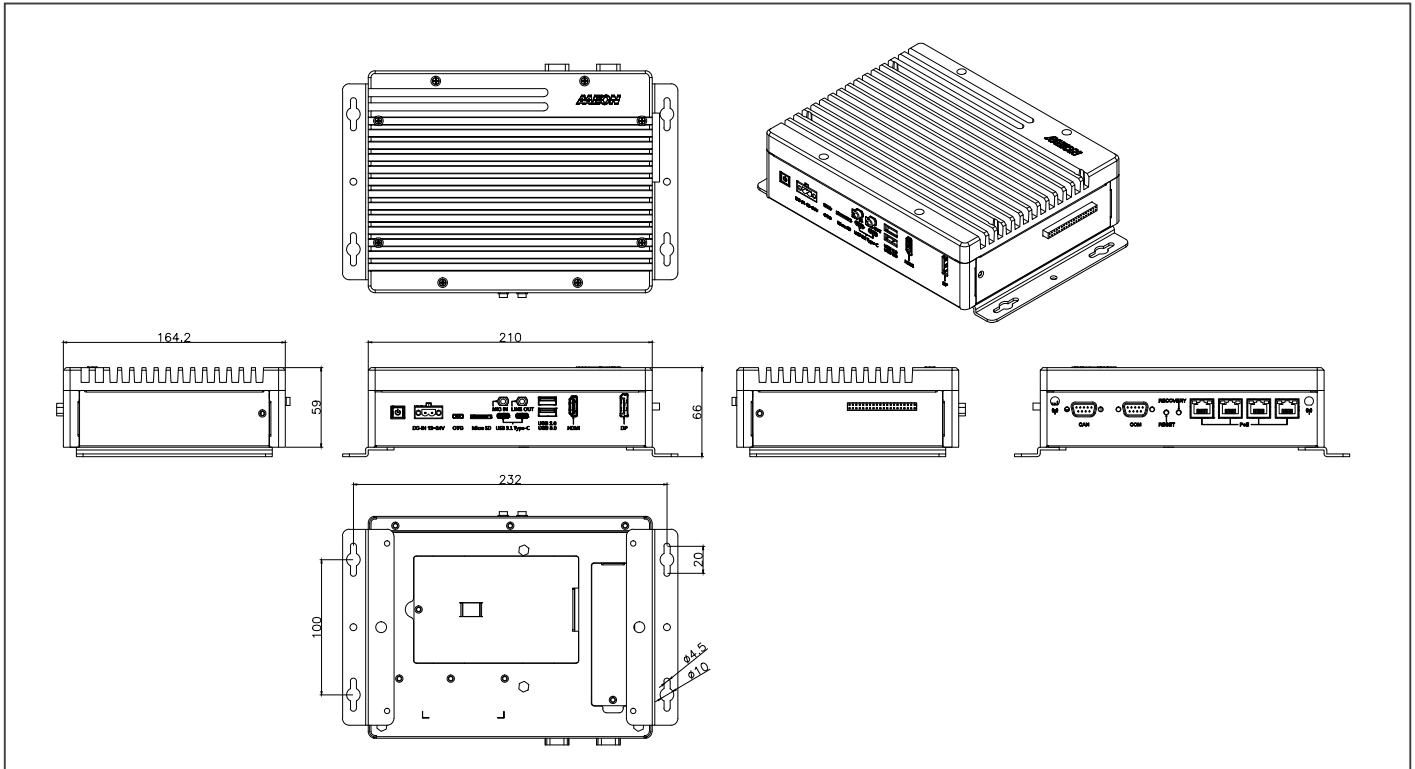

Ordering Information

Part Number	AI Solution	POE	USB	RS-232/422/485	CANBus	Storage	Expansion	Display	Audio	Mounting	Power	Operation Temp	Operation System
BOXER-8240AI-A3-1111	NVIDIA AGX Xavier	4	USB 3.2 Gen 1 x 2 + 2 (TypeA+C)	1	Dual Canbus in one Connector	eMMC / M.2 M Key / Micro-SD / 2.5" SATA	M.2 E Key	HDMI x 1 DP x1	MIC-in x1 LINE-OUT x1	Wallmount	DC 12V-24V	-10°C - 55°C	NVIDIA Jetpack 4.5
BOXER-8240AI-A4-1111	NVIDIA AGX Xavier	4	USB 3.2 Gen 1 x 2 + 2 (TypeA+C)	1	Dual Canbus in one Connector	eMMC / M.2 M Key / Micro-SD / 2.5" SATA	M.2 E Key	HDMI x 1 DP x1	—	Wallmount	DC 12V-24V	-10°C - 55°C	NVIDIA Jetpack 4.5
BOXER-8240AI-JP46E-A1-1111	NVIDIA AGX Xavier	4	USB 3.2 Gen 1 x 2 + 2 (TypeA+C)	1	Dual Canbus in one Connector	eMMC / M.2 M Key / Micro-SD / 2.5" SATA	M.2 E Key	HDMI x 1 DP x1	MIC-in x1 LINE-OUT x1	Wallmount	DC 12V-24V	-10°C - 55°C	NVIDIA Jetpack 4.6
BOXER-8240AI-JP46E-A2-1111	NVIDIA AGX Xavier	4	USB 3.2 Gen 1 x 2 + 2 (TypeA+C)	1	Dual Canbus in one Connector	eMMC / M.2 M Key / Micro-SD / 2.5" SATA	M.2 E Key	HDMI x 1 DP x1	—	Wallmount	DC 12V-24V	-10°C - 55°C	NVIDIA Jetpack 4.6

Packing List

- BOXER-8240AI
- Power Connector x 1
- Wallmount Bracket x 2
- Screw Package x 1

Optional Accessories

- 1255X00066
120W Power Adapter
- 170X000799
Power Cord (US type)
- 170X000800
Power Cord (European Type)
- 170X000803
Power Cord (Japanese Type)

BOXER-8251AI

AI@Edge Compact Fanless Embedded AI System with NVIDIA® Jetson Xavier™ NX

Front View



Rear View

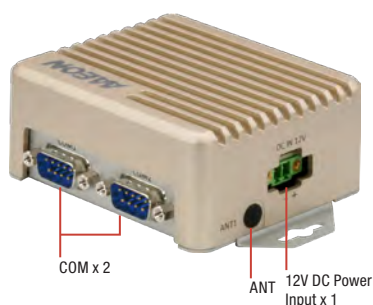

With High Heatsink Front View



Rear View



Features

- NVIDIA® Jetson Xavier™ NX
- 8GB LPDDR4x + 16GB eMMC
- USB3.2 Gen 1 x 4
- LAN x 1 + RS-232/422/485 x 2
- 12Vdc Power input



Specifications

System	
AI Accelerator	NVIDIA® Jetson Xavier™ NX
CPU	6 Core ARM® Carmel®V8.2 64bit CPU 6MB L2 + 4MB L3
System Memory	8GB LPDDR4x
Storage Device	16GB eMMC + MicroSD
Display Interface	HDMI 2.0
Ethernet	10/100/1000Base-TX x 1
I/O	USB 3.2 Gen 1 x 4 LAN x 1 RS-232/422/485 x 2 HDMI x 1 MicroSD x 1 DC Power Input x 1 Recovery Button x 1 Micro-USB for Flash OS x 1
Expansion	M.2 E-Key 2230 x 1(for WiFi)
Indicator	Power LED x 1
OS Support	Linux (AAEON ACLinux 4.9) Linux (NVIDIA Jetpack 4.5) Ubuntu18.04
Power Supply	
Power Requirement	12Vdc w/ 2-pin terminal block
Mechanical	
Mounting	Wallmount
Dimensions (W x D x H)	Standard: 3.46" x 2.95" x 1.53" (88mm x 75mm x 39mm) High heatsink Dimension: 3.54" x 3.30" x 2.04" (90mm x 84mm x 52mm)
Gross Weight	Standard: 1.10 lb (0.5 kg) High heatsink: 1.76lb(0.8kg)
Net Weight	Standard: 0.66 lb (0.3 kg) High heatsink: 1.3lb(0.6kg)
Environmental	
Operating Temperature	-4°F ~ 140°F (-20°C ~ 60°C) (varies depending on selected power model)
Storage Temperature	-40°F ~ 158°F (-40°C ~ 70°C)
Storage Humidity	95% @ 40°C, non-condensing
Anti-Vibration	3 Grms/ 5 ~ 500Hz/ operation – MicroSD or eMMC
Anti-Shock	—
Certification	CE/FCC class A

Operating Temperature

Power Mode	CPU Core	CPU Maximum Frequency	Operation Temp.
20W	6 Core	1.4GHz	-20°C ~ 55°C (for high heat sink)
	4 Core	1.4GHz	-20°C ~ 40°C
15W	6 Core	1.4GHz	-20°C ~ 40°C/-20°C ~ 50°C (for high heat sink)
	4 Core	1.4GHz	-20°C ~ 40°C
	2 Core	1.9GHz	-20°C ~ 50°C/-20°C ~ 60°C (for high heat sink)
10W	4 Core	1.2GHz	-20°C ~ 50°C/-20°C ~ 60°C (for high heat sink)
	2 Core	1.5GHz	-20°C ~ 50°C





Dimension

Unit: mm

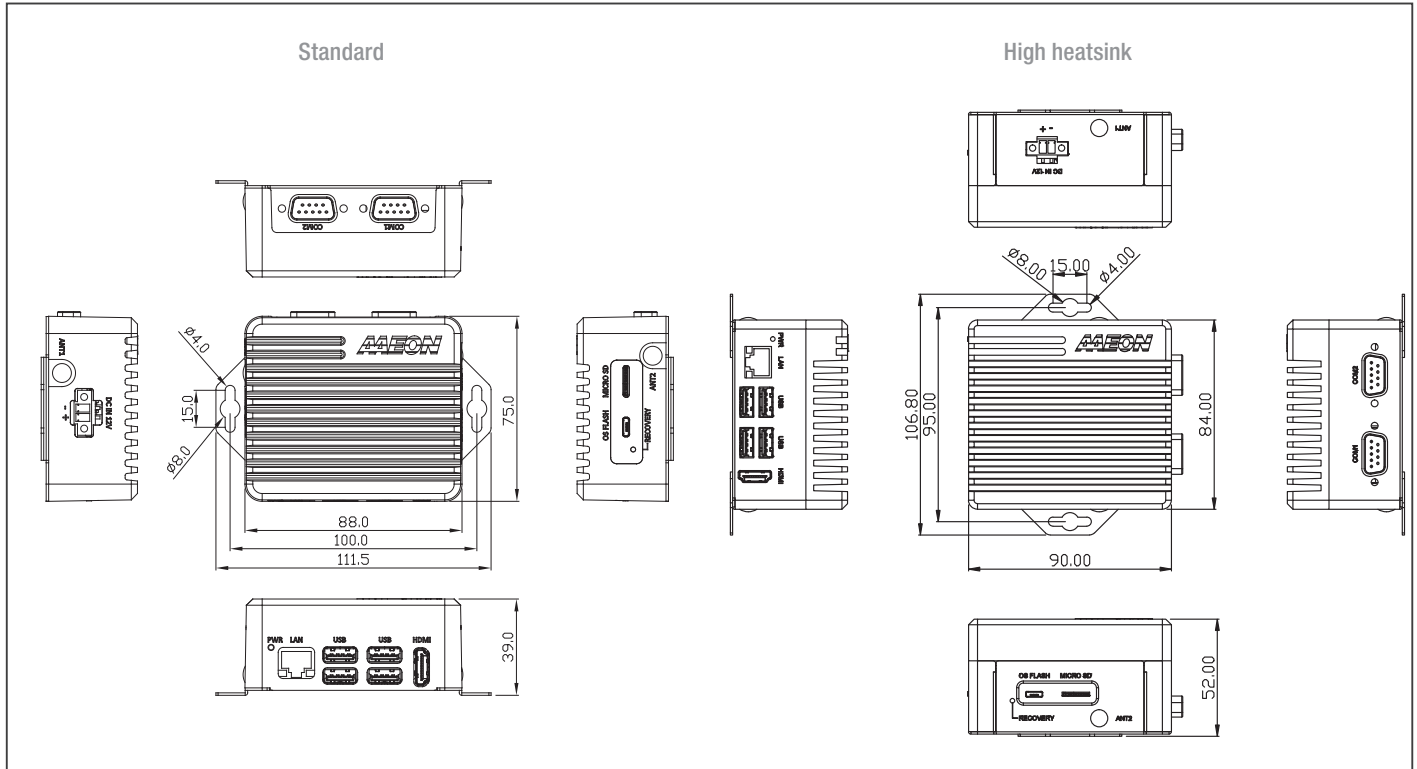

Ordering Information

Part Number	AI Solution	LAN	USB	RS-232	Storage	Display	Mounting	Power	Operation System
BOXER-8251AI-JP46E-A1-1110	Jetson Xavier NX	1	3.2 Gen 1 x 4	2	16GB eMMC + Micro SD Slot	HDMI x 1	Wallmount	12Vdc w/ 2 pin terminal block	NVIDIA Jetpack 4.6
BOXER-8251AI-JP46S-A1-1110	Jetson Xavier NX	1	3.2 Gen 1 x 4	2	16GB eMMC + 64GB Micro SD	HDMI x 1	Wallmount	12Vdc w/ 2 pin terminal block	NVIDIA Jetpack 4.6
BOXER-8251AI-JP46E-E1-1010 (high heatsink)	Jetson Xavier NX	1	3.2 Gen 1 x 4	2	16GB eMMC + Micro SD Slot	HDMI x 1	Wallmount	12Vdc w/ 2 pin terminal block	NVIDIA Jetpack 4.6

Packing List

- Power Connector x 1
- BOXER-8251AI

Optional Accessories

- 1255300611
60W Power Adapter
- 170X000799
Power Cord (US type)
- 170X000800
Power Cord (European Type)
- 170X000803
Power Cord (Japanese Type)

BOXER-8253AI

AI@Edge Compact Fanless Embedded BOX PC with NVIDIA® Jetson Xavier™ NX

Front View

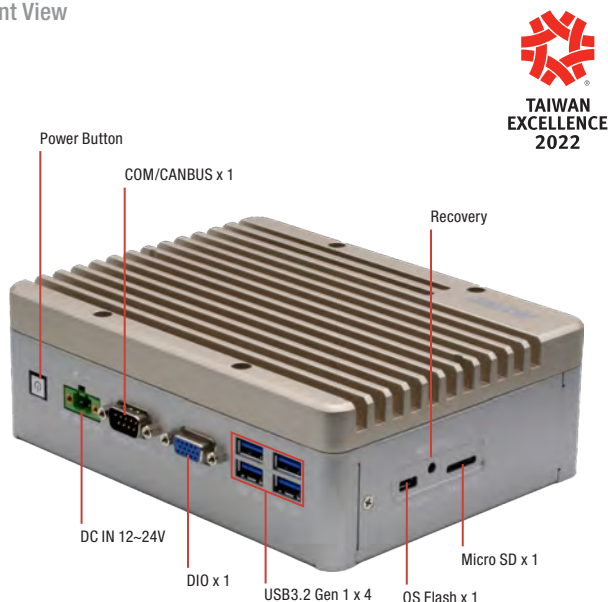

Rear View

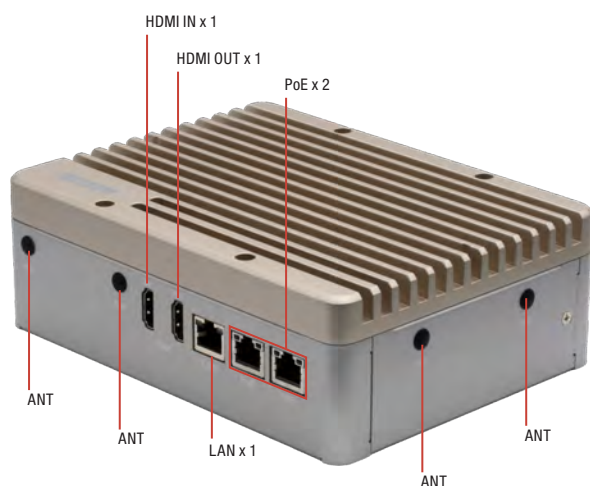

Features

- NVIDIA® Jetson Xavier™ NX
- 8GB LPDDR4x
- Multi-storage option: 16GB eMMC / MicroSD slot / mSATA slot / 2.5 drive bay
- GbE PoE/PSE LAN x 2
- HDMI Input x 1 & HDMI Output x 1
- Digital I/O 13-channel
- Expansion support for WiFi/LTE



Specifications

System	
AI Accelerator	NVIDIA® Jetson Xavier™ NX
CPU	6 Core ARM® Carmel®V8.2 64bit CPU 6MB L2 + 4MB L3
System Memory	8GB LPDDR4x
Storage Device	eMMC 16GB MicroSD slot x 1 Full-size mSATA (sharing slot with Full-size minicard module) 2.5" SATA drive bay x 1
Display Interface	HDMI Type A for HDMI 2.0 x 1
Ethernet	RJ-45 x 2 For GbE PoE/PSE (802.3at) RJ-45 x 1 For GbE LAN
I/O	USB Type A x 4 for USB 3.2 Gen 1 USB Micro A/B x 1 for OS Flash RJ-45 x 2 for PoE/PSE (802.3at) (Total 60W) RJ-45 x 1 for GbE LAN DB-9 x 1 for RS-232/485 & CANbus DB15 x 1 for Digital I/O 13-Channel (programmable) Recovery Button x 1 MicroSD card slot x 1 Antenna opening x 4 HDMI Type A for HDMI 2.0 output x 1 HDMI Type A for HDMI 1.4 input x 1 Power Button x 1
Expansion	Full-size minicard slot x1 (PCIe/USB/mSATA, default PCIe) M.2 E-Key 2230 x 1 (for WiFi) SIM socket x 1 SATA III (6.0 Gbps) port x 1 for 2.5" drive
Indicator	Power LED x 1
OS Support	Linux (AAEON ACLinux4.9) Linux (NVIDIA Jetpack 4.5)
Power Supply	
Power Requirement	12~24V DC with 2-pin terminal block
Mechanical	
Mounting	Wallmount
Dimensions (W x D x H)	7.09 " x 5.35 " x 2.41" (180.0 mm x 136.0 mm x 61.1 mm)
Gross Weight	4.63 lbs. (2.1 kg)
Net Weight	2.87 lbs. (1.3 kg)
Environmental	
Operating Temperature	5°F ~ 131°F (-15°C ~ 55°C with 0.5 m/s airflow)
Storage Temperature	-40°F ~ 176°F (-40°C ~ 80°C)
Storage Humidity	5 ~ 95% @ 40°C, non-condensing
Anti-Vibration	3.5Grms / 5~500Hz / operation-eMMC, MicroSD or mSATA
Anti-Shock	50G peak acceleration (11 msec. duration, eMMC, microSD, or mSATA)
Certification	CE / FCC class A





Dimension

Unit: mm

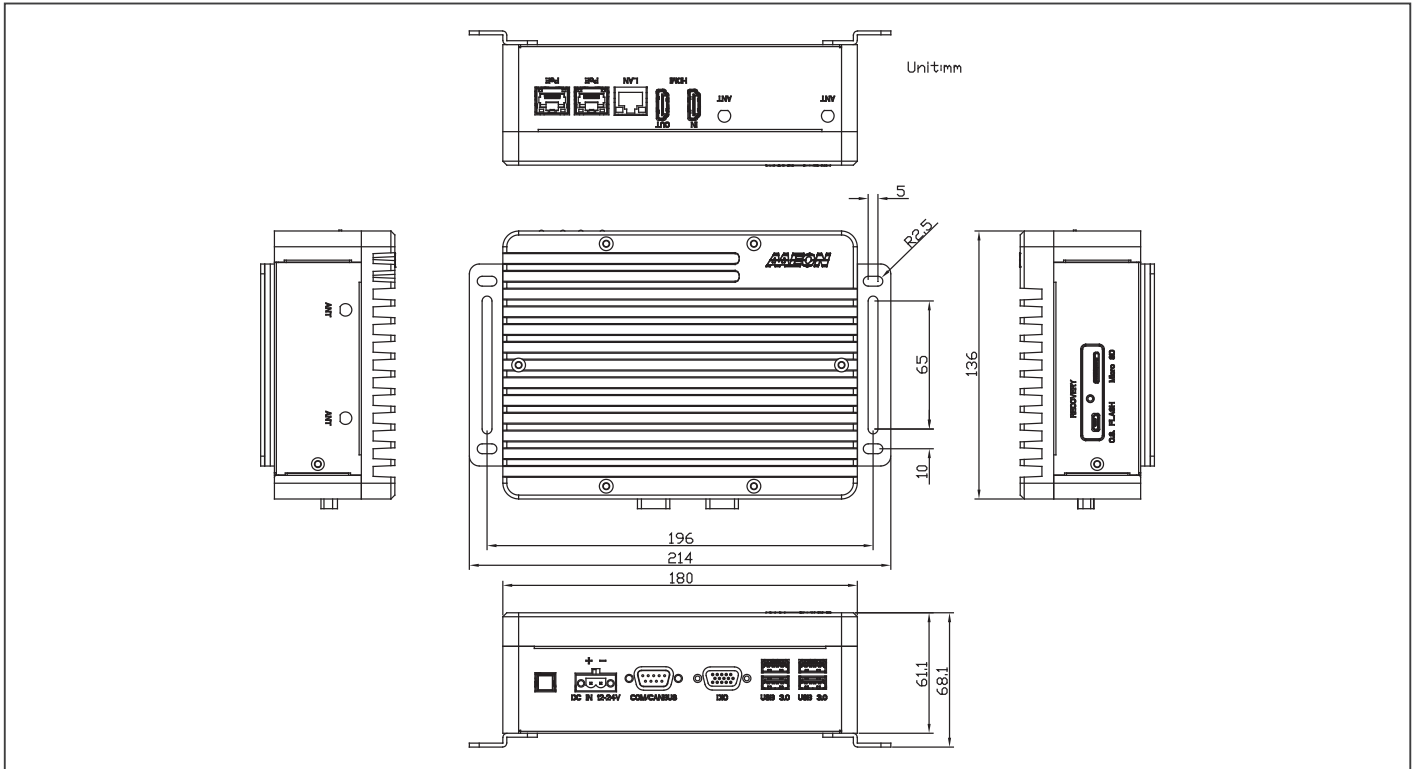

Ordering Information

Part Number	AI Accelerator	LAN	POE	USB 3.2 Gen1	RS-232/485 & CANbus	Storage	Display	Mounting	Power	Operation temp.	Operation System
BOXER-8253AI-A1-1011	Jetson Xavier NX	1	2	4	1	16GB eMMC / MicroSD slot / mSATA slot / 2.5 drive bay	HDMI OUT x 1	Wallmount	DC 12V~24V	-15°C ~ 55°C with 0.5m/s airflow	ACLinux 4.9
BOXER-8253AI-A3-1010	Jetson Xavier NX	1	2	4	1	16GB eMMC / MicroSD slot / mSATA slot / 2.5 drive bay	HDMI OUT x 1	Wallmount	DC 12V~24V	-15°C ~ 55°C with 0.5m/s airflow	NVIDIA Jetpack 4.5
BOXER-8253AI-JP46E-A1-1211	Jetson Xavier NX	1	2	4	1	16GB eMMC / MicroSD slot / mSATA slot / 2.5 drive bay	HDMI OUT x 1	Wallmount	DC 12V~24V	-15°C ~ 55°C with 0.5m/s airflow	NVIDIA Jetpack 4.6

Packing List

- Wallmount Bracket x 2
- Power Connector x 1
- Screw Package x 1
- BOXER-8253AI

Optional Accessories

- **1255X00066**
120W Power Adapter
- **170X000799**
Power Cord (US type)
- **170X000800**
Power Cord (European Type)
- **170X000803**
Power Cord (Japanese Type)

BOXER-8256AI

AI@Edge Fanless Embedded AI System with NVIDIA® Jetson Xavier™ NX, HDMI Input x4



Front View

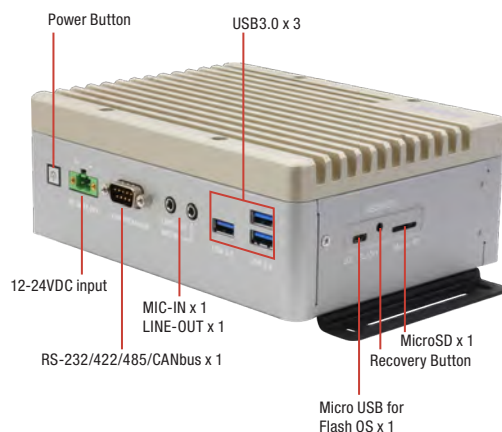

Rear View

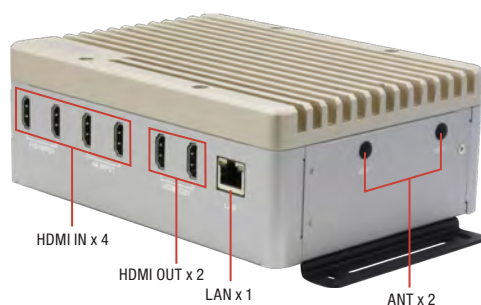

Features

- HDMI x 4 for Video Input 1.4
- HDMI x 2 for Video Display 2.0
- USB Type A x 3 for USB 3.2 Gen 1
- DB9 for RS-232/422/485 (By switch) and CANbus x1
- RJ-45 x 1 for GbE LAN
- M.2 M-Key (PCIEx4)
- M.2 B-Key (PCIEx2 and USB 3.0)
- M.2 E-key (PCIEx1 and USB 2.0)



Specifications

System	
AI Accelerator	NVIDIA® Jetson Xavier™ NX
CPU	6-core NVIDIA Carmel Arm®v8.2 64-bit CPU
System Memory	8GB LPDDR4x
Storage Device	16GB eMMC x 1 MicroSD Slot x 1 M.2 M-Key 2280 x 1 (PCIEx4) 2.5" SATA x 1
Display Interface	HDMI 2.0 x 2
Ethernet	RJ-45 x 1 for GbE LAN
I/O	USB Type A x 3 for USB 3.2 Gen 1 DB9 for RS-232/422/485 (By switch) and CANbus x1 HDMI x 2 for Video Display 2.0 HDMI x 4 for Video Input 1.4 (Limitation have stated in User manual) Mic-in x 1, Line-Out x 1 Micro USB for OS Flash x 1 Power ON/OFF switch x 1 Recovery button x 1 SMA Antenna hole x 2
Expansion	M.2 B-Key 3042/3052 x 1 (PCIEx2] + USB 3.0) M.2 E-key x 1(PCIEx1] + USB 2.0)
Indicator	Power LED x 1
OS Support	Linux (NVIDIA Jetpack 4.6.2 or above)
Power Supply	
Power Requirement	DC-in 12-24V with 2-pin terminal block
Mechanical	
Mounting	Wallmount
Dimensions (W x D x H)	7.09" x 5.35" x 2.64" (180 mm x 136 mm x 67 mm)
Gross Weight	4.23 lb (1.92 kg)
Net Weight	2.87 lb (1.3 kg)
Environmental	
Operating Temperature	-5°F ~ 140°F (-15°C ~ 60°C with 0.5 m/s airflow)
Storage Temperature	-40°F ~ 176°F (-40°C ~ 80°C)
Storage Humidity	5 ~ 95% @ 40°C, non-condensing
Anti-Vibration	3.5 Grms/ 5 ~ 500Hz/ operation – eMMC
Anti-Shock	50G, IEC 60068-2-27, half sine, 11 ms duration – eMMC
Certification	CE / FCC class A





Dimension

Unit: mm

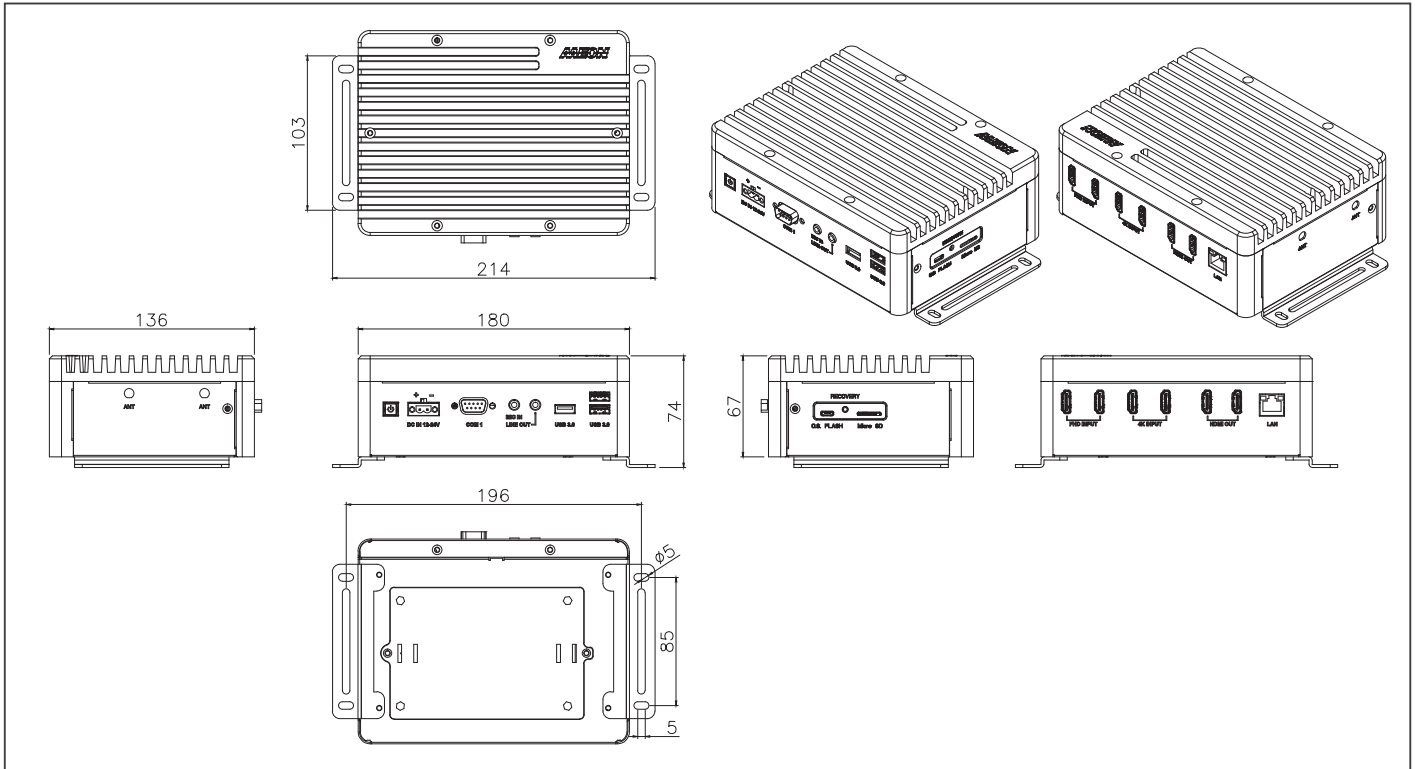

Ordering Information

Part Number	AI Solution	LAN	USB	CANBus	RS-232/422/485	Digital I/O	Audio	Storage	Display	Expansion	Mounting	Power	Operation temp.	Operation System
BOXER-8256AI-JP462E-A1-1010	Jetson Xavier NX	1	USB 3.2 Gen 1 x 3	1 (by Switch)	1 (by Switch)	—	Mic-in x 1 Line-Out x 1	16GB eMMC MicroSD slot x 1 M.2 M Key x 1 2.5" SATA x 1	HDMI x 2	M.2 B key x 1 M.2 E key x 1 SATA connector and 5V x 1 COM pin header x 1	Wallmount	DC 12V-24V	-15°C ~ 60°C	NVIDIA Jetpack 4.6.2

Packing List

- Wallmount Bracket x 2
- Screw Package x 1
- Power Connector x 1
- BOXER-8256AI

Optional Accessories

- 1255X00023
60W Power Adapter
- 170X000799
Power Cord (US type)
- 170X000800
Power Cord (European Type)
- 170X000803
Power Cord (Japanese Type)



BOXER-8621AI

AI@Edge Compact Fanless Embedded AI System with NVIDIA® Jetson Orin Nano™ with Super Mode



Front View

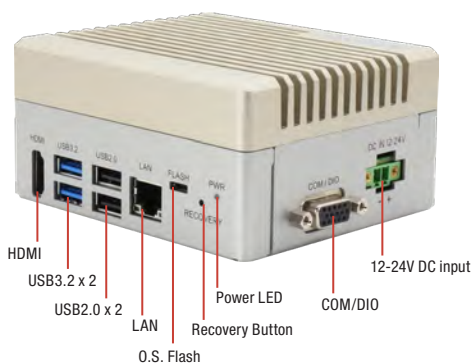

Rear View



Features

- NVIDIA® Jetson Orin Nano™ with Super Mode
- Expansion: M.2 2230 E-Key x 1, M.2 3052 B-Key x 1
- USB 3.2 Gen 2 (Type-A) x 2 & USB 2.0 (Type-A) x 2
- COM, DIO, CANBus
- Operating Temperature: -5°F~ 140°F (-15°C ~ 60°C)



Specifications

System	
AI Accelerator	NVIDIA® Jetson Orin Nano™ NVIDIA® Jetson Orin Nano™ with Super Mode
CPU	6-core Arm® Cortex®-A78AE ARMv8.2 64-bit CPU
System Memory	4GB/8GB LPDDR5
Storage Device	M.2 3052 B-Key x 1 for M.2 2242 B+M Key SSD (Default Storage) M.2 2230 E-Key x 1 (Optional)
Display Interface	HDMI 1.4 (Type-A) x 1
Ethernet	RJ-45 x 1 for GbE LAN
I/O	USB 3.2 Gen 2 (Type-A) x 2 USB 2.0 (Type-A) x 2 DB-9 for RS-232 (Rx/Tx/CTS/RTS)/485 x 1 and CANBus FD x 1 DB-15 for RS-232 (Rx/Tx)/422/485 x 1 and DIO x 8 Micro USB x 1 for OS Flash Recovery Button x 1 Antenna x 2
Expansion	M.2 3042/3052 B Key x 1 (4G/5G/M.2 2242 B+M Key storage) M.2 2230 E Key x 1 (Wifi/BT/Storage) SIM Slot x 1
Indicator	Power LED x 1
OS Support	Linux (NVIDIA Jetpack™ 6.x and up)
Power Supply	
Power Requirement	12V~24V DC in with 2 pins terminal block x 1
Mechanical	
Mounting	Wallmount
Dimensions (W x D x H)	4.13" x 3.54" x 2.05" (105mm x 90mm x 52mm), w/o bracket
Gross Weight	2.4 lb (1.1kg)
Net Weight	1.58 lb (0.7kg)
Environmental	
Operating Temperature	-5°F ~ 140°F (-15°C ~ 60°C), according to IEC60068-2 with 0.5 m/s AirFlow
Storage Temperature	-40°F ~ 185°F (-40°C ~ 85°C)
Storage Humidity	5% ~ 95% @ 40C, non-condensing
Anti-Vibration	3.5Grms / 5~500Hz / Operation
Anti-Shock	50G peak acceleration
Certification	CE/FCC class A





Dimension

Unit: mm

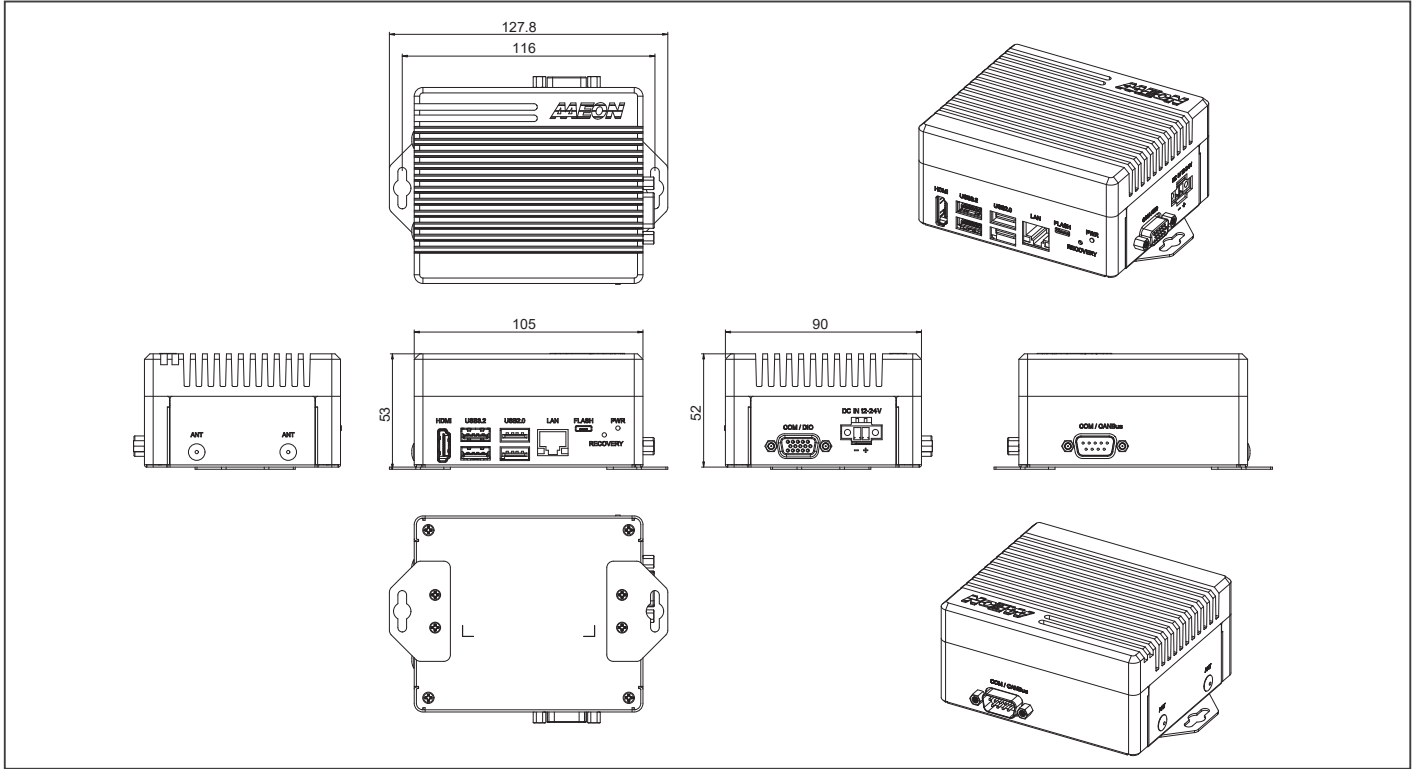

Ordering Information

Part Number	AI Solution	LAN	USB	RS-232/422/485	CANbus	DIO	Storage	Display	Mounting	Power	Operation System
BOXER-8621AI-JP511N-A1-1010	NVIDIA® Jetson Orin Nano™ 4GB	1	3.2 Gen 2 x 2, 2.0 x 2	2	1	8	M.2 3052 B-Key x 1 for M.2 2242 B+M Key SSD (Default: 128GB) M.2 2230 E-Key x 1 (Optional)	HDMI x 1	Wallmount	12 ~ 24VDC w/ 2 pin terminal block	Linux (NVIDIA Jetpack™ 5.0 or above)
BOXER-8621AI-JP511N-A2-1010	NVIDIA® Jetson Orin Nano™ 8GB	1	3.2 Gen 2 x 2, 2.0 x 2	2	1	8	M.2 3052 B-Key x 1 for M.2 2242 B+M Key SSD (Default: 128GB) M.2 2230 E-Key x 1 (Optional)	HDMI x 1	Wallmount	12 ~ 24VDC w/ 2 pin terminal block	Linux (NVIDIA Jetpack™ 5.0 or above)
BOXER-8621AI-JP620N-A1-1010	NVIDIA® Jetson Orin Nano™ 4GB (Super Mode Support)	1	3.2 Gen 2 x 2, 2.0 x 2	2	1	8	M.2 3052 B-Key x 1 for M.2 2242 B+M Key SSD (Default: 128GB) M.2 2230 E-Key x 1 (Optional)	HDMI x 1	Wallmount	12 ~ 24VDC w/ 2 pin terminal block	Linux (NVIDIA Jetpack™ 6.2)
BOXER-8621AI-JP620N-A2-1010	NVIDIA® Jetson Orin Nano™ 8GB (Super Mode Support)	1	3.2 Gen 2 x 2, 2.0 x 2	2	1	8	M.2 3052 B-Key x 1 for M.2 2242 B+M Key SSD (Default: 128GB) M.2 2230 E-Key x 1 (Optional)	HDMI x 1	Wallmount	12 ~ 24VDC w/ 2 pin terminal block	Linux (NVIDIA Jetpack™ 6.2)
BOXER-8621AI-JP620N-A3-1010	NVIDIA® Jetson Orin Nano™ 4GB (Super Mode Support)	1	3.2 Gen 2 x 2, 2.0 x 2	2	1	8	M.2 3052 B-Key x 1 for M.2 2242 B+M Key SSD (Default: 128GB) M.2 2230 E-Key x 1 (Optional)	HDMI x 1	Wallmount	12 ~ 24VDC w/ 2 pin terminal block	Linux (NVIDIA Jetpack™ 6.2), MAZU Security Support

Packing List

- BOXER-8621AI x 1
- Wallmount Bracket x 2
- Power connector x 1
- Screw Package x 1

Optional Accessories

- 1255300611
60W Power Adapter
- 170X000799
Power Cord (US type)
- 170X000800
Power Cord (European Type)
- 170X000803
Power Cord (Japanese Type)

BOXER-8622AI

AI@Edge Compact Fanless Embedded AI System with NVIDIA® Jetson Orin Nano™ with Super Mode



Front View

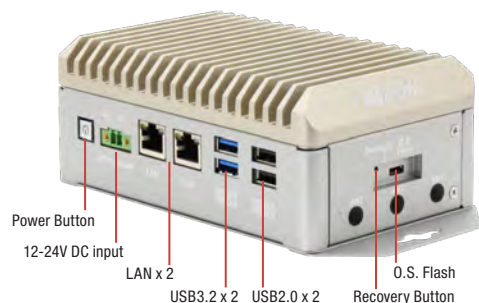

Rear View

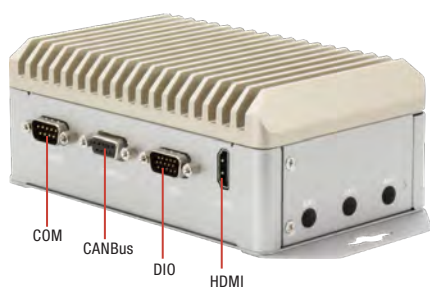

Features

- NVIDIA® Jetson Orin Nano™ with Super Mode
- 4GB/8GB LPDDR5
- Supports M.2 E-Key x 1, M.2 B-Key x 1, M.2 M-Key x 1
- Supports DB-9 x 1 for CANBus
- Supports GbE LAN x 2



Specifications

System	
AI Accelerator	NVIDIA® Jetson Orin Nano™ NVIDIA® Jetson Orin Nano™ with Super Mode
CPU	6-core Arm® Cortex®-A78AE v8.2 64-bit CPU
System Memory	4GB/8GB LPDDR5
Storage Device	M.2 2280 M-Key x 1
Display Interface	HDMI 1.4 (Type-A) x 1
Ethernet	RJ-45 x 2 for 10/100/1000 Base-T
I/O	USB 3.2 Gen 2 (Type-A) x 2 USB 2.0 (Type-A) x 2 Micro USB x 1 for OS Flash DB-9 x 1 for CANbus DB-9 x 1 for RS-232/422/485 DB-15 x 1 for 13-bit DIO Power ON/OFF switch x 1 Recovery button x 1 Antenna Hole x 6
Expansion	M.2 2230 E-Key x 1 (Wi-Fi/Bluetooth) M.2 3042/3052 B-Key x 1 (4G/5G) M.2 2280 M-Key x 1
Indicator	Power LED x 1
OS Support	Linux (NVIDIA Jetpack™ 6.x and up)
Power Supply	
Power Requirement	DC-in 12-24V with 2-pin terminal block
Mechanical	
Mounting	Wallmount
Dimensions (W x D x H)	5.98" x 3.78" x 2.42" (152mm x 96 mm x 61.5mm)
Gross Weight	3.97lb (1.8kg)
Net Weight	2.65lb (1.2kg)
Environmental	
Operating Temperature	-5°F ~ 149°F (-15°C ~ 65°C with 0.5 m/s airflow)
Storage Temperature	-40°F ~ 176°F (-40°C ~ 85°C)
Storage Humidity	5 ~ 95% @ 40°C, non-condensing
Anti-Vibration	3.5Grms / 5~500Hz
Anti-Shock	50G peak acceleration
Certification	CE / FCC class A





Dimension

Unit: mm

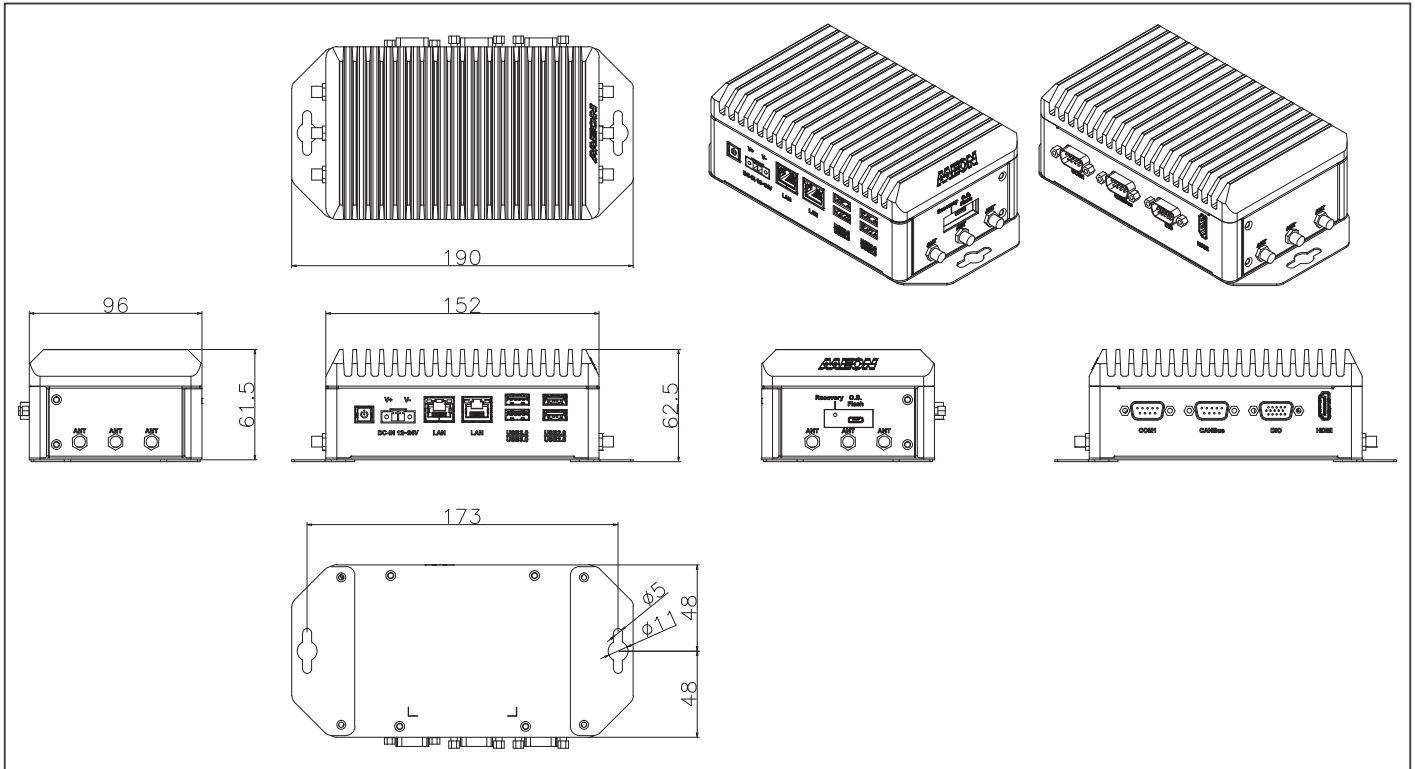

Ordering Information

Part Number	AI Solution	LAN	USB	RS-232/422/485	CANBus	DIO	Storage	Display	Mounting	Power	Operation System
BOXER-8622AI-JP511N-A1-1010	NVIDIA® Jetson Orin Nano™ 4GB	2	3.2 Gen 2 x 2, 2.0 x 2	1	1	13	M.2 2280 M-Key x 1 (Default: 128GB)	HDMI x 1	Wallmount	12 ~ 24VDC w/ 2 pin terminal block	Linux (NVIDIA Jetpack™ 5.0 or above)
BOXER-8622AI-JP511N-A2-1010	NVIDIA® Jetson Orin Nano™ 8GB	2	3.2 Gen 2 x 2, 2.0 x 2	1	1	13	M.2 2280 M-Key x 1 (Default: 128GB)	HDMI x 1	Wallmount	12 ~ 24VDC w/ 2 pin terminal block	Linux (NVIDIA Jetpack™ 5.0 or above)
BOXER-8622AI-JP600N-A1-1010	NVIDIA® Jetson Orin Nano™ 4GB w/ Super Mode	2	3.2 Gen 2 x 2, 2.0 x 2	1	1	13	M.2 2280 M-Key x 1 (Default: 128GB)	HDMI x 1	Wallmount	12 ~ 24VDC w/ 2 pin terminal block	Linux (NVIDIA Jetpack™ 6.0)
BOXER-8622AI-JP600N-A2-1010	NVIDIA® Jetson Orin Nano™ 8GB w/ Super Mode	2	3.2 Gen 2 x 2, 2.0 x 2	1	1	13	M.2 2280 M-Key x 1 (Default: 128GB)	HDMI x 1	Wallmount	12 ~ 24VDC w/ 2 pin terminal block	Linux (NVIDIA Jetpack™ 6.0)
BOXER-8622AI-JP620N-A1-1010	NVIDIA® Jetson Orin Nano™ 4GB w/ Super Mode	2	3.2 Gen 2 x 2, 2.0 x 2	1	1	13	M.2 2280 M-Key x 1 (Default: 128GB)	HDMI x 1	Wallmount	12 ~ 24VDC w/ 2 pin terminal block	Linux (NVIDIA Jetpack™ 6.2)
BOXER-8622AI-JP620N-A2-1010	NVIDIA® Jetson Orin Nano™ 8GB w/ Super Mode	2	3.2 Gen 2 x 2, 2.0 x 2	1	1	13	M.2 2280 M-Key x 1 (Default: 128GB)	HDMI x 1	Wallmount	12 ~ 24VDC w/ 2 pin terminal block	Linux (NVIDIA Jetpack™ 6.2)

Packing List

- BOXER-8622AI x 1
- Wallmount Bracket x 2
- Power connector x 1
- Screw Package x 1

Optional Accessories

- 1255300611
60W Power Adapter
- 170X000799
Power Cord (US type)
- 170X000800
Power Cord (European Type)
- 170X000803
Power Cord (Japanese Type)

BOXER-8623AI

AI@Edge Compact Fanless Embedded AI System with NVIDIA® Jetson Orin Nano™

Front View

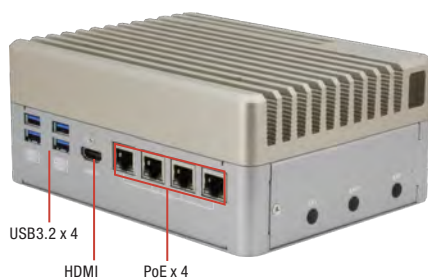

Rear View

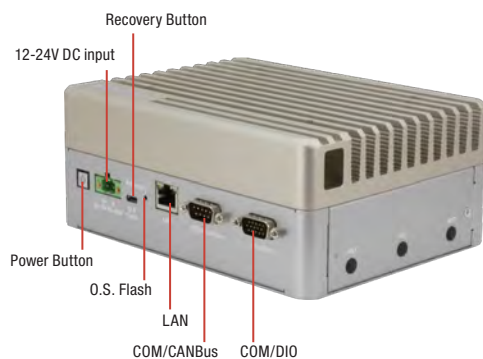

Features

- NVIDIA® Jetson Orin Nano™
- GbE PoE/PSE 802.3af/at x 4 + GbE LAN x 1
- M.2 2230 E-Key x 1, M.2 2280 M-Key x 1, M.2 3042/3052 B-Key x 1
- COM/CANBus/DIO
- Operating Temperature: -15°C ~ 65°C



Specifications

System	
AI Accelerator	NVIDIA® Jetson Orin Nano™
CPU	6-core Arm® Cortex®-A78AE ARMv8.2 64-bit CPU
System Memory	4GB LPDDR5 8GB LPDDR5
Storage Device	M.2 2280 M Key x 1
Display Interface	HDMI 1.4 (Type-A) x 1
Ethernet	RJ-45 x 1 for GbE LAN RJ-45 x 4 for GbE PoE/PSE 802.3af/at (Max.60W)
I/O	USB 3.2 Gen 2 (Type-A) x 4 DB-9 x 1 for RS-232 (Rx/Tx/CTS/RTS) x 1 and CANBus FD x 1 DB-15 x 1 for RS-232(Rx/Tx)/422/485 x 1 and DIO x 8 Micro USB x 1 for OS Flash Power Button x 1 Recovery Button x 1 Antenna Hole x 6
Expansion	M.2 2280 M-Key x 1 (NVMe) M.2 3042/3052 B-Key x 1 M.2 2230 E-Key x 1 SIM Slot x 1
Indicator	Power LED x 1
OS Support	Linux (NVIDIA Jetpack™ 5.0 and up)
Power Supply	
Power Requirement	12V ~ 24V DC in with 2-pin Terminal Block x 1
Mechanical	
Mounting	Wallmount
Dimensions (W x D x H)	7.09" x 5.35" x 2.95" (180mm x 136mm x 75mm)
Gross Weight	7.7 lb (3.5kg)
Net Weight	5.5 lb (2.5kg)
Environmental	
Operating Temperature	5°F ~ 149°F (-15°C ~ 65°C), according to IEC60068-2 with 0.5 m/s AirFlow
Storage Temperature	-40°F ~ 185°F (-40°C ~ 85°C)
Storage Humidity	5% ~ 95% @ 40°C, non-condensing
Anti-Vibration	3.5Grm / 5~500Hz / Operation
Anti-Shock	50G peak acceleration
Certification	CE/FCC class A





Dimension

Unit: mm

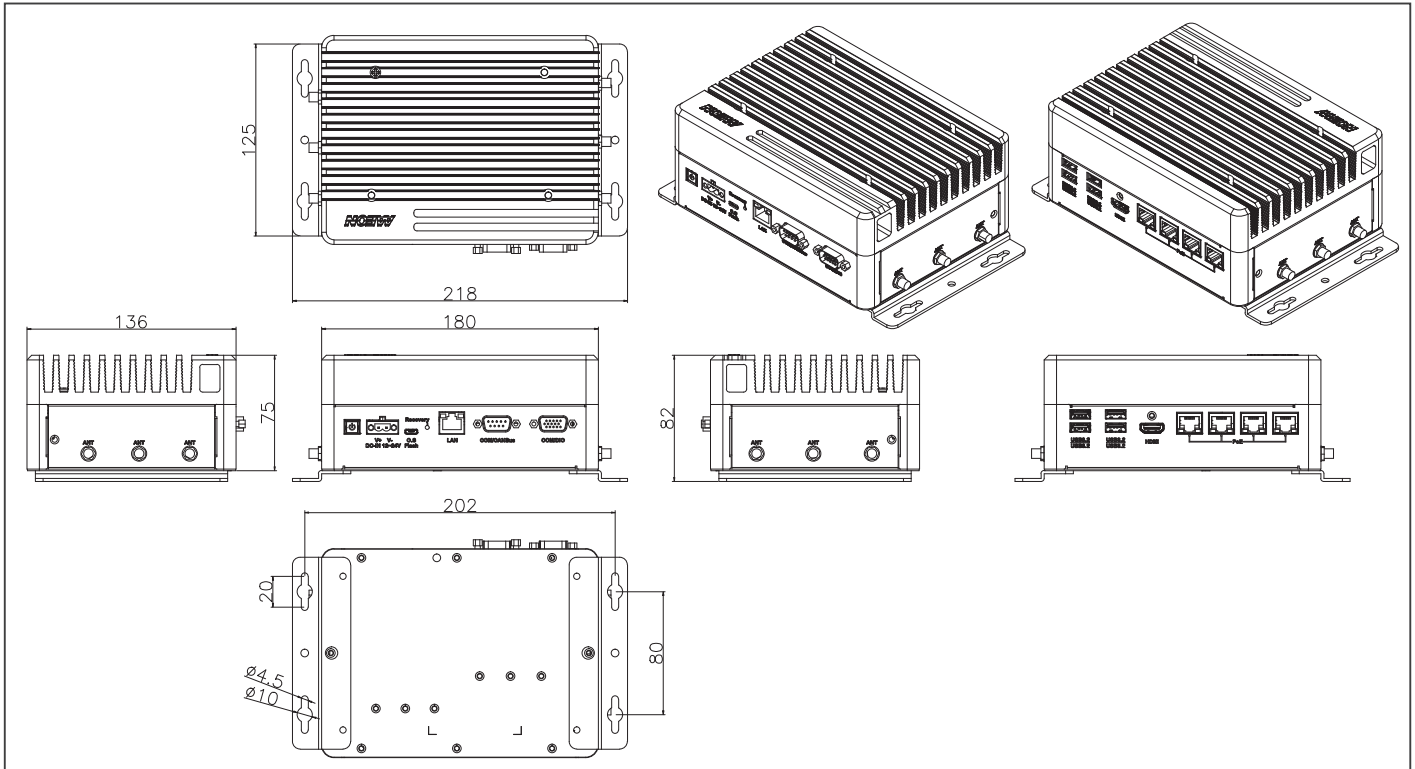

Ordering Information

Part Number	AI Solution	LAN	POE	USB	COM	CANBus	DIO	Storage	Display	Mounting	Power	Operation System
BOXER-8623AI-JP511N-A1-1010	NVIDIA® Jetson Orin Nano™ 4GB	1	4	3.2 Gen 2 x 4	2	1	8	M.2 2280 M-Key x 1 for Storage (Default: 128GB)	HDMI x 1	Wallmount	12 ~ 24VDC w/ 2 pin terminal block	Linux (NVIDIA Jetpack™ 5.0 or above)
BOXER-8623AI-JP511N-A2-1010	NVIDIA® Jetson Orin Nano™ 8GB	1	4	3.2 Gen 2 x 4	2	1	8	M.2 2280 M-Key x 1 for Storage (Default: 128GB)	HDMI x 1	Wallmount	12 ~ 24VDC w/ 2 pin terminal block	Linux (NVIDIA Jetpack™ 5.0 or above)

Packing List

- BOXER-8623AI x 1
- Wallmount Bracket x 2
- Power connector x 1
- Screw Package x 1

Optional Accessories

- 1255X00066
120W Power Adapter
- 170X000799
Power Cord (US type)
- 170X000800
Power Cord (European Type)
- 170X000803
Power Cord (Japanese Type)

BOXER-8640AI

AI@Edge Fanless Embedded AI System with NVIDIA® Jetson AGX Orin™



Front View

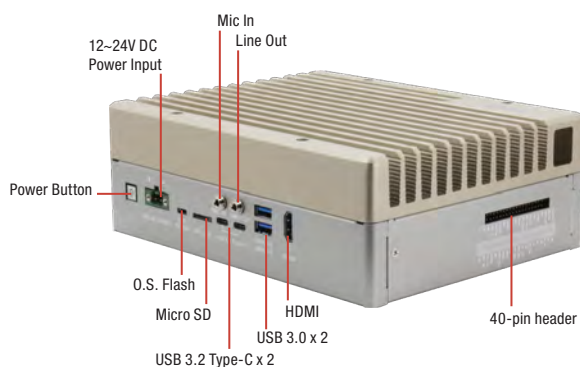

Rear View

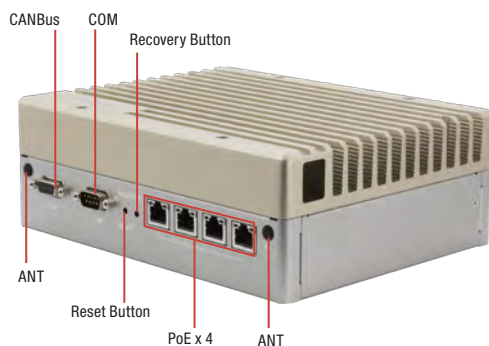

Features

- NVIDIA® Jetson AGX Orin™
- PoE/PSE 802.3af x 4 (Max. 60W)
- RS-232/422/485 x 1, CANBus x 1
- 40-pin Header, Mic-in/Line-out
- M.2 2230 E-Key, M.2 2280 M-Key, 2.5" SATA Drive Bay



Specifications

System	
AI Accelerator	NVIDIA® Jetson AGX Orin™
CPU	AGX Orin 32GB: 8-core Arm® Cortex®-A78AE CPU AGX Orin 64GB: 12-core Arm® Cortex®-A78AE CPU
System Memory	32GB LPDDR5 64GB LPDDR5
Storage Device	64GB eMMC 5.1 Micro SD Card Slot x 1 2.5" SATA Drive Bay x 1 M.2 2280 M-Key x 1
Display Interface	HDMI 2.0 x 1
Ethernet	RJ-45 for GbE PoE/PSE 802.3af x 4 (Max. 60W)
I/O	USB 3.2 Gen 2 (Type-A) x 2 USB 3.2 Gen 2 (Type-C) x 2 RS-232/422/485 x 1 CANBus x 1 Mic-in x 1 Line-out x 1 MicroSD Slot x 1 Micro USB x 1 for OS Flash Recovery Button x 1 Power Button x 1 40-pin Header compliant with NVIDIA Jetson Orin Nano Developer Kit (without CANBus)
Expansion	USB 2.0 Header x 1 (Optional, Circuit Reserved) M.2 2230 E-Key x 1 (Wifi/BT) M.2 2280 M-Key x 1 (NVMe) 2.5" SATA Drive Bay x 1 RS-232/422/485 Pin Header x 1
Indicator	Power LED x 1
OS Support	Linux (NVIDIA Jetpack™ 6.x and up)
Power Supply	
Power Requirement	DC 12V ~ 24V 2-pin terminal
Mechanical	
Mounting	Wallmount
Dimensions (W x D x H)	8.26" x 6.46" x 2.91" (210mm x 164.2mm x 74mm)
Gross Weight	8.3 lb (3.76kg)
Net Weight	6.4 lb (2.9kg)
Environmental	
Operating Temperature	-4°F ~ 131°F (-20°C ~ 55°C, according to IEC60068-2 with 0.5 m/s AirFlow)
Storage Temperature	-40°F ~ 158°F (-40°C ~ 70°C)
Storage Humidity	95% @ 40°C, non-condensing
Anti-Vibration	Random, 3.5 Grms, 5 ~ 500Hz
Anti-Shock	50G Peak Acceleration
Certification	CE/FCC Class A



ES France - Mobilité & Systèmes Embarqués
127 rue de Buzenval BP 26 - 92380 Garches



Tél. 01 47 95 99 80



e-mail : mse@es-france.com
Site Web : www.es-france.com



Dimension

Unit: mm

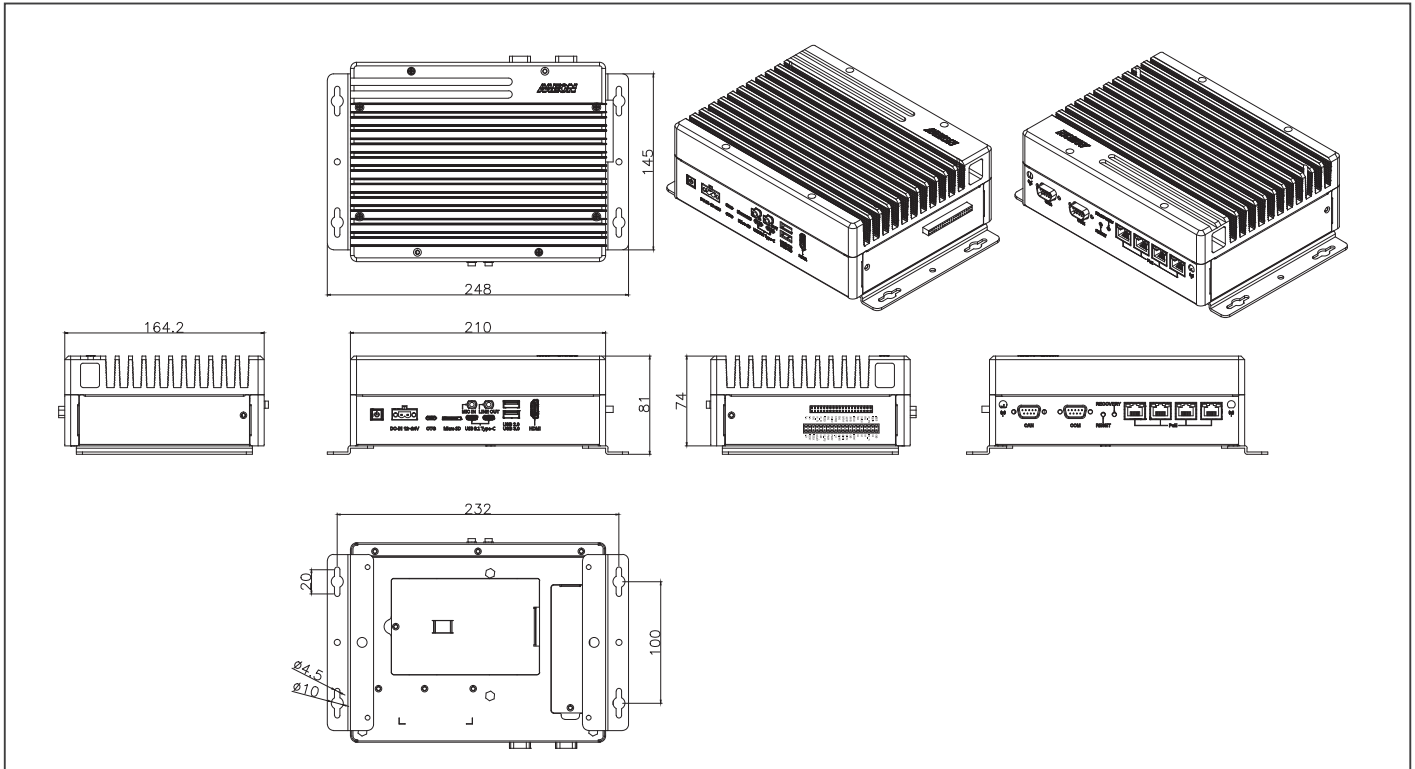

Ordering Information

PART NUMBER	AI SOLUTION	PoE LAN	USB	RS-232/422/485	CANBus	40-PIN HEADER	STORAGE	DISPLAY	MOUNTING	POWER	OPERATING SYSTEM
BOXER-8640AI-JP511E-A1-1010	NVIDIA® Jetson AGX Orin™ 32GB	4	3.2 Gen 2 x 4	2	1	1	64GB eMMC + MicroSD + 2.5" SATA + M.2 2280 M Key	HDMI x 1	Wallmount	12 ~ 24VDC w/ 2 pin terminal block	Linux (NVIDIA Jetpack™ 5.1.1 or above)
BOXER-8640AI-JP511E-A2-1010	NVIDIA® Jetson AGX Orin™ 64GB	4	3.2 Gen 2 x 4	2	1	1	64GB eMMC + MicroSD + 2.5" SATA + M.2 2280 M Key	HDMI x 1	Wallmount	12 ~ 24VDC w/ 2 pin terminal block	Linux (NVIDIA Jetpack™ 5.1.1 or above)
BOXER-8640AI-JP600N-A1-1010	NVIDIA® Jetson AGX Orin™ 32GB	4	3.2 Gen 2 x 4	2	1	1	64GB eMMC + MicroSD + 2.5" SATA + M.2 2280 M Key	HDMI x 1	Wallmount	12 ~ 24VDC w/ 2 pin terminal block	Linux (NVIDIA Jetpack™ 6.0)
BOXER-8640AI-JP600N-A2-1010	NVIDIA® Jetson AGX Orin™ 64GB	4	3.2 Gen 2 x 4	2	1	1	64GB eMMC + MicroSD + 2.5" SATA + M.2 2280 M Key	HDMI x 1	Wallmount	12 ~ 24VDC w/ 2 pin terminal block	Linux (NVIDIA Jetpack™ 6.0)

Packing List

- BOXER-8640AI
- Wallmount Bracket x 2
- Power Connector x 1
- Screw Package x 1

Optional Accessories

- 1255X00066
120W Power Adapter
- 170X000799
Power Cord (US type)
- 170X000800
Power Cord (European Type)
- 170X000803
Power Cord (Japanese Type)

BOXER-8641AI

AI@Edge Compact Fanless Embedded AI System with NVIDIA® Jetson AGX Orin™

Front View

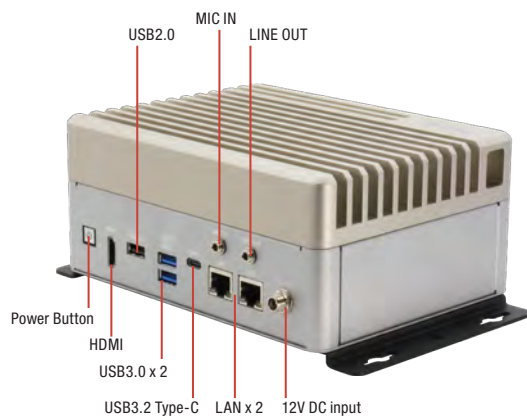

Rear View

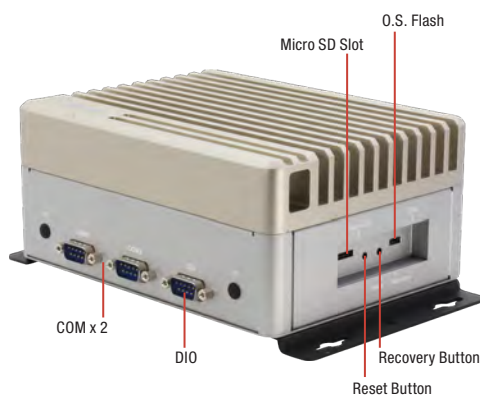

Features

- NVIDIA® Jetson AGX Orin™
- Multi-storage option: 64GB eMMC / MicroSD slot / 2.5" SATA drive bay/ M.2 2280 M Key
- Support M.2 E Key / M.2 B Key / M.2 M Key
- Support GbE LAN x 2



Specifications

System	
AI Accelerator	NVIDIA® Jetson AGX Orin™
CPU	AGX Orin 32GB: 8-core Arm® Cortex®-A78AE CPU AGX Orin 64GB: 12-core Arm® Cortex®-A78AE CPU
System Memory	32GB LPDDR5 64GB LPDDR5
Storage Device	64GB eMMC 5.1 x 1 MicroSD slot x 1 SATA drive bay x 1
Display Interface	HDMI Type A for HDMI 2.0 x 1
Ethernet	RJ-45 for GbE LAN x 2
I/O	USB Type A for USB 3.2 Gen 2 x 2 USB Type C for USB 3.2 Gen 2 x 1 USB Type A for USB 2.0 x 1 Micro USB x 1 for OS Flash Mic in and Line out x1 Reset Button x 1 Recovery Button x 1 MicroSD card slot x 1 Antenna opening x 4 Power Button x 1 DB-9 x 2 for RS-232/422/485 DB-9 x 1 for DIO x 8
Expansion	M.2 E-Key 2230 (for Wifi/BT) x 1 M.2 B-Key 3052 x 1 M.2 M-Key 2280 (NVMe) x 1 2.5" SATA drive bay SIM Slot x 1
Indicator	Power LED x 1
OS Support	Linux (NVIDIA Jetpack™ 6.x and up)
Power Supply	
Power Requirement	12V DC with lockable DC Jack
Mechanical	
Mounting	Wallmount
Dimensions (W x D x H)	7.09 " x 5.35 " x 3.11" (180.0 mm x 136.0 mm x 79.1 mm)
Gross Weight	7.8lb (3.55kg)
Net Weight	5.5lb (2.5kg)
Environmental	
Operating Temperature	-4°F ~ 131°F (-20°C ~ 55°C with 0.5 m/s airflow)
Storage Temperature	-40°F ~ 158°F (-40°C ~ 70°C)
Storage Humidity	5 ~ 95% @ 40°C, non-condensing
Anti-Vibration	3.5Grms / 5~500Hz / operation-eMMC, MicroSD or SSD
Anti-Shock	50G peak acceleration (11 msec. duration, eMMC, microSD, or SSD)
Certification	CE / FCC Class B





Dimension

Unit: mm

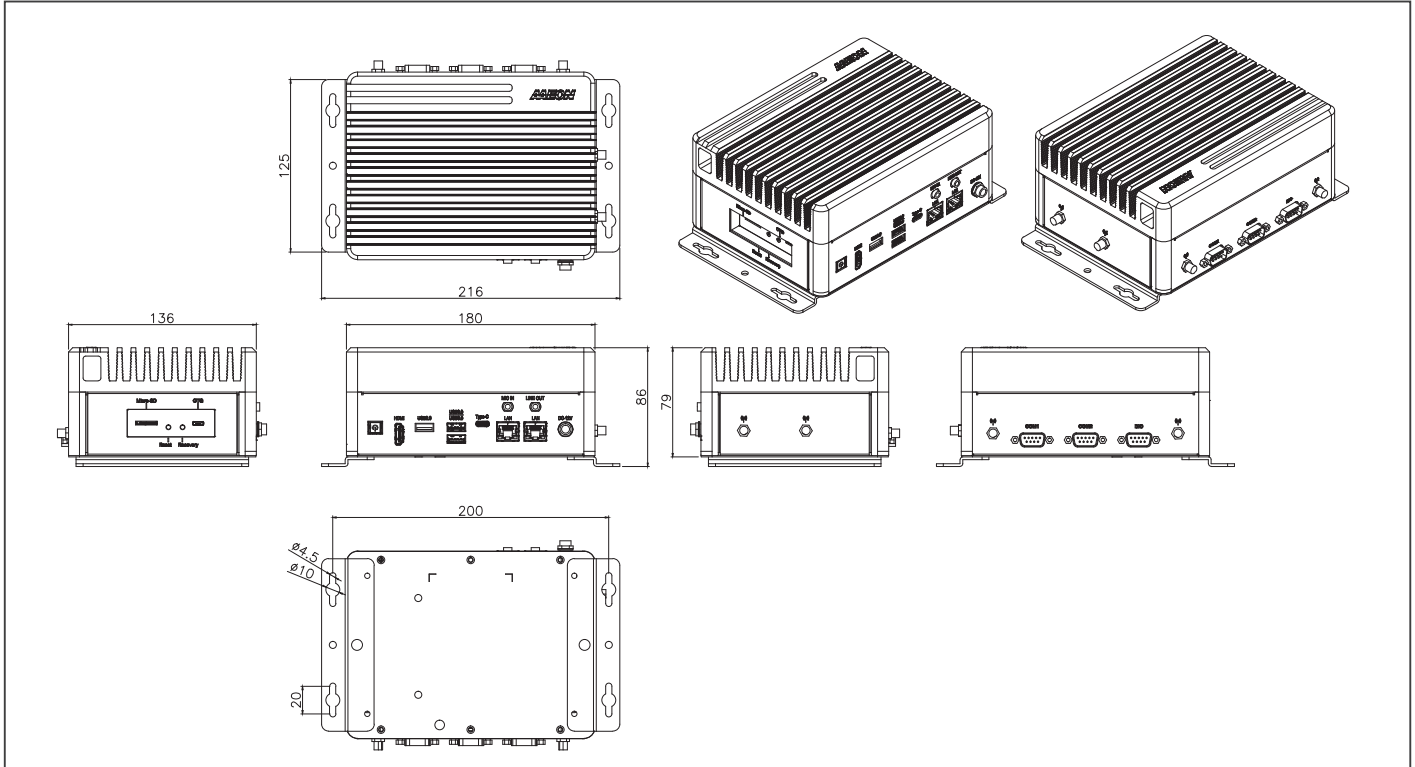

Ordering Information

Part Number	AI Solution	LAN	USB	RS-232/422/485	CANBus	DIO	Storage	Display	Mounting	Power	Operation System
BOXER-8652AI-JP511N-A1-1010	NVIDIA® Jetson Orin NX™ 8GB	1	3.2 Gen 2 x 2, 2.0 x 2	2	1	8	M.2 3052 B-Key x 1 for M.2 2242 B+M Key SSD (Default: 128GB), M.2 2230 E-Key x 1 (Opt.)	HDMI x 1	Wallmount	12 – 24VDC w/ 2 pin terminal block	Linux (NVIDIA Jetpack™ 5.0 or above)
BOXER-8652AI-JP511N-A2-1010	NVIDIA® Jetson Orin NX™ 16GB	1	3.2 Gen 2 x 2, 2.0 x 2	2	1	8	M.2 3052 B-Key x 1 for M.2 2242 B+M Key SSD (Default: 128GB), M.2 2230 E-Key x 1 (Opt.)	HDMI x 1	Wallmount	12 – 24VDC w/ 2 pin terminal block	Linux (NVIDIA Jetpack™ 5.0 or above)
BOXER-8652AI-JP600N-A1-1010	NVIDIA® Jetson Orin NX™ 8GB w/ Super Mode	1	3.2 Gen 2 x 2, 2.0 x 2	2	1	8	M.2 3052 B-Key x 1 for M.2 2242 B+M Key SSD (Default: 128GB), M.2 2230 E-Key x 1 (Opt.)	HDMI x 1	Wallmount	12 – 24VDC w/ 2 pin terminal block	Linux (NVIDIA Jetpack™ 6.0)
BOXER-8652AI-JP600N-A2-1010	NVIDIA® Jetson Orin NX™ 16GB w/ Super Mode	1	3.2 Gen 2 x 2, 2.0 x 2	2	1	8	M.2 3052 B-Key x 1 for M.2 2242 B+M Key SSD (Default: 128GB), M.2 2230 E-Key x 1 (Opt.)	HDMI x 1	Wallmount	12 – 24VDC w/ 2 pin terminal block	Linux (NVIDIA Jetpack™ 6.0)

Packing List

- BOXER-8641AI
- Wallmount Bracket x 2
- Screw Package x 1

Optional Accessories

- 1255X00057
84W, lockable DC jack
- 170X000799
Power Cord (US type)
- 170X000800
Power Cord (European Type)
- 170X000803
Power Cord (Japanese Type)

BOXER-8641AI-PLUS

AI@Edge Compact Fanless Embedded AI System with NVIDIA® Jetson AGX Orin™



Front View

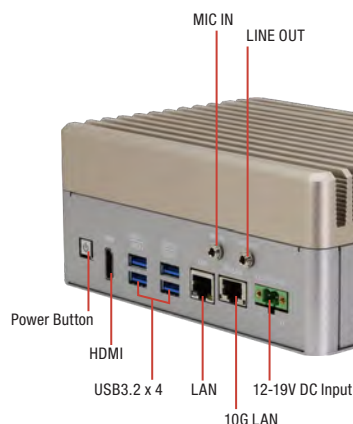

Rear View

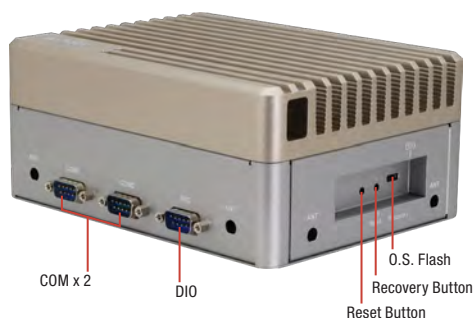

Features

- NVIDIA® Jetson AGX Orin™
- Giga LAN x 1, 10G LAN x 1
- USB 3.2 Gen 2 (Type-A) x 4
- DB-9 x 1 for DIO x 8
- DB-9 x 2 for RS-232/422/485(Rx/Tx/RTS/CTS)



Specifications

System	
AI Accelerator	NVIDIA® Jetson AGX Orin™
CPU	AGX Orin 32GB: 8-core Arm® Cortex®-A78AE CPU AGX Orin 64GB: 12-core Arm® Cortex®-A78AE CPU
System Memory	32GB LPDDR5 64GB LPDDR5
Storage Device	64GB eMMC 5.1 x 1 MicroSD slot x 1 2.5" SATA drive bay x 1
Display Interface	HDMI Type A for HDMI 2.0 x 1
Ethernet	RJ-45 for Giga LAN x 1 RJ-45 for 10G LAN x 1
I/O	USB 3.2 Gen 2 (Type-A) x 2 (from SoM) USB 3.2 Gen 2 (Type-A) x 2 (from Hub) DB-9 x 2 for RS-232/422/485(Rx/Tx/RTS/CTS) DB-9 x 1 for DIO x 8 Micro USB x 1 for OS Flash Mic in and Line out x 1 MicroSD Card Slot x 1 Antenna Opening x 6 Reset Button x 1 Recovery Button x 1 Power Button x 1 OOB Connector x 1 TPM 2.0 x 1
Expansion	M.2 2230 E-Key x 1 M.2 3052 B-Key x 1 M.2 2280 M-Key x 1 2.5" SATA Drive Bay x 1 SIM Slot x 1
Indicator	Power LED x 1
OS Support	Linux (NVIDIA Jetpack 6.0 and above)
Power Supply	
Power Requirement	12~19VDC 2-pin Terminal Block
Mechanical	
Mounting	Wallmount
Dimensions (W x D x H)	7.09" x 5.35" x 3.11" (180mm x 136mm x 79.1mm)
Gross Weight	7.8 lb (3.55kg)
Net Weight	5.5 lb (2.5kg)
Environmental	
Operating Temperature	-13°F ~ 131°F (-25°C ~ 55°C) with 0.7 m/s airflow
Storage Temperature	-40°F ~ 185°F (-40°C ~ 85°C)
Storage Humidity	5 ~ 95% @ 40°C, non-condensing
Anti-Vibration	3.5 Grms, 5~500Hz with SSD
Anti-Shock	50G peak acceleration
Certification	CE / FCC class B





BOXER-8641AI-PLUS

Dimension

Unit: mm

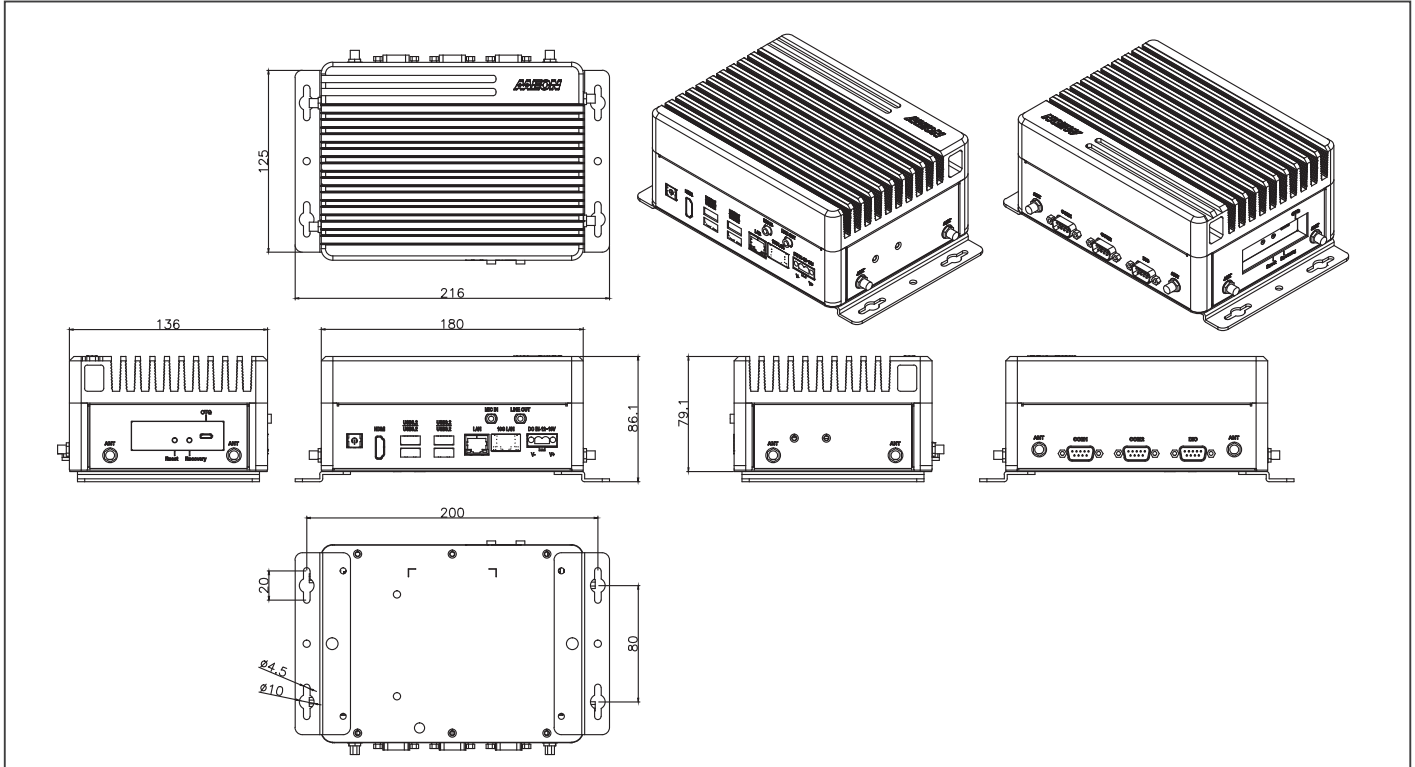

Ordering Information

Part Number	AI SOLUTION	LAN	USB 3.2 Gen 2	COM	CANBUS	Storage	Display	Expansion	Mounting	Power	Operation System
BOXER-8641AI-B1-JP600E-A1-1010	NVIDIA® Jetson AGX Orin™ 32GB	1	1	3.2 Gen 2 x 4	2	8	HDMI x 1	64GB eMMC + MicroSD + 2.5"SATA + M.2 2280 M Key	Wallmount	12 ~ 19VDC w/ 2 pin terminal block	JetPack™ 6.0.0
BOXER-8641AI-B1-JP600E-A2-1010	NVIDIA® Jetson AGX Orin™ 64GB	1	1	3.2 Gen 2 x 4	2	8	HDMI x 1	64GB eMMC + MicroSD + 2.5"SATA + M.2 2280 M Key	Wallmount	12 ~ 19VDC w/ 2 pin terminal block	JetPack™ 6.0.0
BOXER-8641AI-B1-JP600E-A3-1010	NVIDIA® Jetson AGX Orin™ 32GB	1	1	3.2 Gen 2 x 4	2	8	HDMI x 1	64GB eMMC + MicroSD + 2.5"SATA + M.2 2280 M Key	Wallmount	12 ~ 19VDC w/ 2 pin terminal block	JetPack™ 6.0.0, MAZU Security Support

Packing List

- BOXER-8641AI-B1
- Wallmount Bracket x 2
- Screw Package x 1

Optional Accessories

- 1255X00066
120W Power Adapter
- 170X000799
Power Cord (US type)
- 170X000800
Power Cord (European Type)
- 170X000803
Power Cord (Japanese Type)

BOXER-8642AI

AI@Edge Fanless Embedded AI System with NVIDIA® Jetson AGX Orin™



Front View

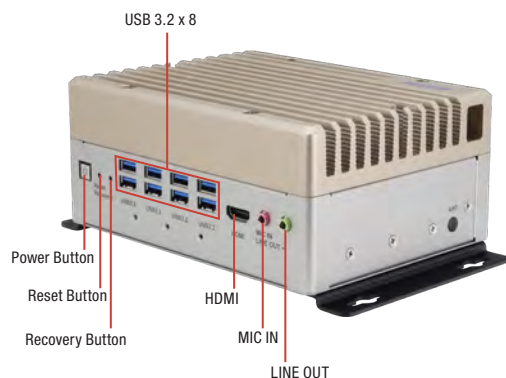

Rear View

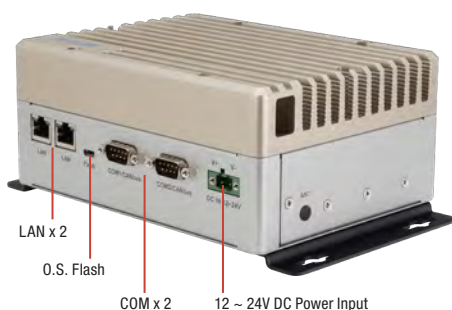

Features

- NVIDIA® Jetson AGX Orin™
- USB 3.2 Gen 2 (Type-A) x 8 (Independent 10Gbps)
- Intel® RealSense™ Depth Camera D405 Support
- GbE LAN x 2
- DB-9 x 2 for RS-232/422/485(Rx/Tx) & CANBus FD
- M.2 E-Key, eMMC and SATA storage



Specifications

System	
AI Accelerator	NVIDIA® Jetson AGX Orin™
CPU	AGX Orin 32GB: 8-core Arm® Cortex®-A78AE CPU AGX Orin 64GB: 12-core Arm® Cortex®-A78AE CPU
System Memory	32GB LPDDR5 64GB LPDDR5
Storage Device	64GB eMMC 5.1 x 1 2.5" SATA SSD drive bay x 1
Display Interface	HDMI 2.0 x 1
Ethernet	RJ-45 x 2 for GbE LAN
I/O	USB 3.2 Gen 2 (Type-A) x 8 (Independent 10Gbps) DB-9 x 2 for RS-232/422/485(Rx/Tx) & CANBus FD Mic-in x 1 Line-Out x 1 Power Button x 1 Recovery Button x 1 Micro USB x 1 for OS Flash SMA Antenna Hole x 2
Expansion	M.2 2230 E-Key x 1 (Wi-Fi/BT) 2.5" SATA SSD Bay x 1
Indicator	Power LED x 1
OS Support	Linux (NVIDIA Jetpack™ 5.1.2 and above)
Power Supply	
Power Requirement	12V ~ 24V DC-in with 2-pin Terminal Block x 1
Mechanical	
Mounting	Wallmount
Dimensions (W x D x H)	7.09" x 5.35" x 3.07" (180.0 mm x 136.0 mm x 78 mm)
Gross Weight	7.8lb (3.55kg)
Net Weight	5.5lb (2.5kg)
Environmental	
Operating Temperature	-13°F ~ 131°F (-25°C ~ 55°C), according to IEC60068-2 with 0.7 m/s AirFlow (w/Industrial wide Temp. SSD)
Storage Temperature	-40°F ~ 185°F (-40°C ~ 85°C)
Storage Humidity	5 ~ 95% @ 40°C, non-condensing, non-operation
Anti-Vibration	3.5 Grms/ 5 ~ 500Hz/ operating
Anti-Shock	50G peak acceleration
Certification	CE/FCC Class A



ES France - Mobilité & Systèmes Embarqués
127 rue de Buzenval BP 26 - 92380 Garches



Tél. 01 47 95 99 80



e-mail : mse@es-france.com
Site Web : www.es-france.com



Dimension

Unit: mm

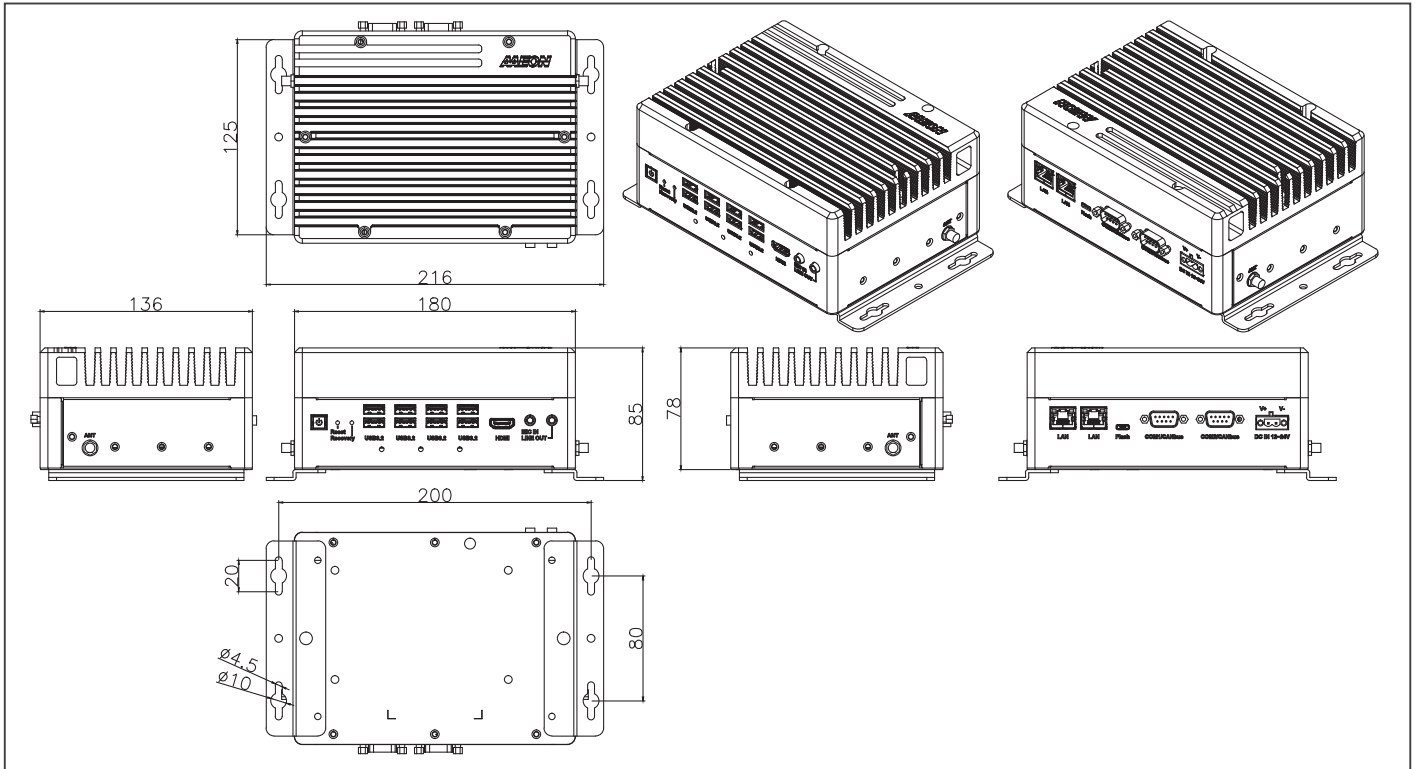

Ordering Information

Part Number	AI Solution	LAN	USB 3.2 Gen 2	COM	CANbus	Storage	Display	Expansion	Mounting	Power	Operation System
BOXER-8642AI-JP511E-A1-1010	NVIDIA® Jetson AGX Orin™ 32GB	2	8	2	2	64GB eMMC + 2.5" SATA SSD drive bay	HDMI x 1	M.2 2230 E-Key x 1 (Wi-Fi/BT)	Wallmount	12V ~ 24V DC-in with 2-pin Terminal Block	NVIDIA Jetpack™ 5.1.1
BOXER-8642AI-JP511E-A2-1010	NVIDIA® Jetson AGX Orin™ 64GB	2	8	2	2	64GB eMMC + 2.5" SATA SSD drive bay	HDMI x 1	M.2 2230 E-Key x 1 (Wi-Fi/BT)	Wallmount	12V ~ 24V DC-in with 2-pin Terminal Block	NVIDIA Jetpack™ 5.1.1

Packing List

- BOXER-8642AI
- Wallmount Bracket x 2
- Screw Package x 1

Optional Accessories

- 1255X00066
120W Power Adapter
- 170X000799
Power Cord (US type)
- 170X000800
Power Cord (European Type)
- 170X000803
Power Cord (Japanese Type)
- 9651864201
USB Lock Kit



BOXER-8645AI

AI@Edge Fanless Embedded AI System with NVIDIA® Jetson AGX Orin™



Front View

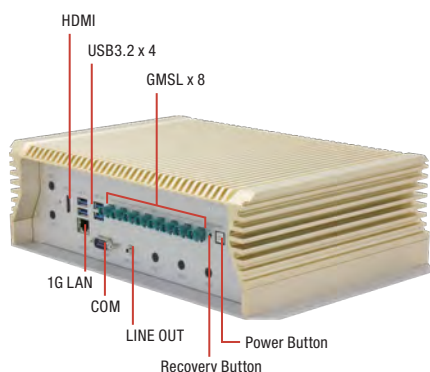

Rear View

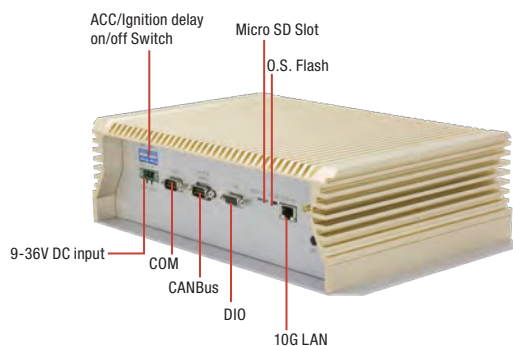

Features

- NVIDIA® Jetson AGX Orin™
- GMSL2 with FAKRA Connectors x 8
- 10G LAN x 1, Giga LAN x 1
- ACC Ignition Delay On/Off
- Military Standard Vibration and Shock
- E-Mark Certified
- Additional LAN x 8 (By request)



Specifications

System	
AI Accelerator	NVIDIA® Jetson AGX Orin™
CPU	AGX Orin 32GB: 8-core Arm® Cortex®-A78AE CPU AGX Orin 64GB: 12-core Arm® Cortex®-A78AE CPU
System Memory	32GB LPDDR5 64GB LPDDR5
Storage Device	64GB eMMC 5.1 x 1 M.2 2280 M-Key x 1 (NVMe) 2.5" SATA x 2
Display Interface	HDMI 2.0 x 1 (Type-A)
Ethernet	RJ-45 for 10G LAN x 1 RJ-45 for Giga LAN x 1 Additional LAN x 8 (By request)
I/O	GMSL2 with FAKRA x 8 USB 3.2 Gen 2 x 4 (Type-A) Micro USB x 1 for OS Flash Line-Out x 1 DB-9 x 1 for Isolated CANBus x 2 DB-9 x 2 for RS-232 (Rx/Tx/CTS/RTS)/RS-485 x 2 DB-9 x 1 for DIO x 8 Switch x 2 for Ignition Delay On/Off 3-pin Terminal Block x 1 for Power Input Power Button x 1 Recovery Button x 1 Antenna Hole x 7 TPM Support GNSS Support 9-Axis Sensor Support
Expansion	M.2 2230 E-Key x 1 (Wifi/BT) M.2 3052 B-Key x 1 (LTE) M.2 2280 M-Key x 1 (NVMe) 2.5" SATA x 2 SIM Slot x 2 MicroSD Slot x 1
Indicator	Power LED x 1
OS Support	Linux (NVIDIA JetPack™ 5.0 and above)
Power Supply	
Power Requirement	3-pin Terminal Block x 1 for 9V ~ 36V ACC Ignition Delay On/Off
Mechanical	
Mounting	Wallmount (default)
Dimensions (W x D x H)	11.26" x 7.95" x 3.54" (286mm x 202mm x 90mm)
Gross Weight	13 lb (5.9kg)
Net Weight	11 lb (5kg)
Environmental	
Operating Temperature	-13°F ~ 149°F (-25°C ~ 65°C with 0.5 m/s airflow)
Storage Temperature	-40°F ~ 185°F (-40°C ~ 85°C)
Storage Humidity	5 ~ 95% @ 40°C, non-condensing
Anti-Vibration	MIL-STD-810G, 514.6C Procedure 1, Category 4 Trucker/Semitrailer on US highway (Figure 514.6C-1-Category 4-Common carrier)
Anti-Shock	MIL-STD-810G, Method 516.6, Procedure I, flight vehicle equipment
Certification	E-Mark, CE/FCC Class A





Dimension

Unit: mm

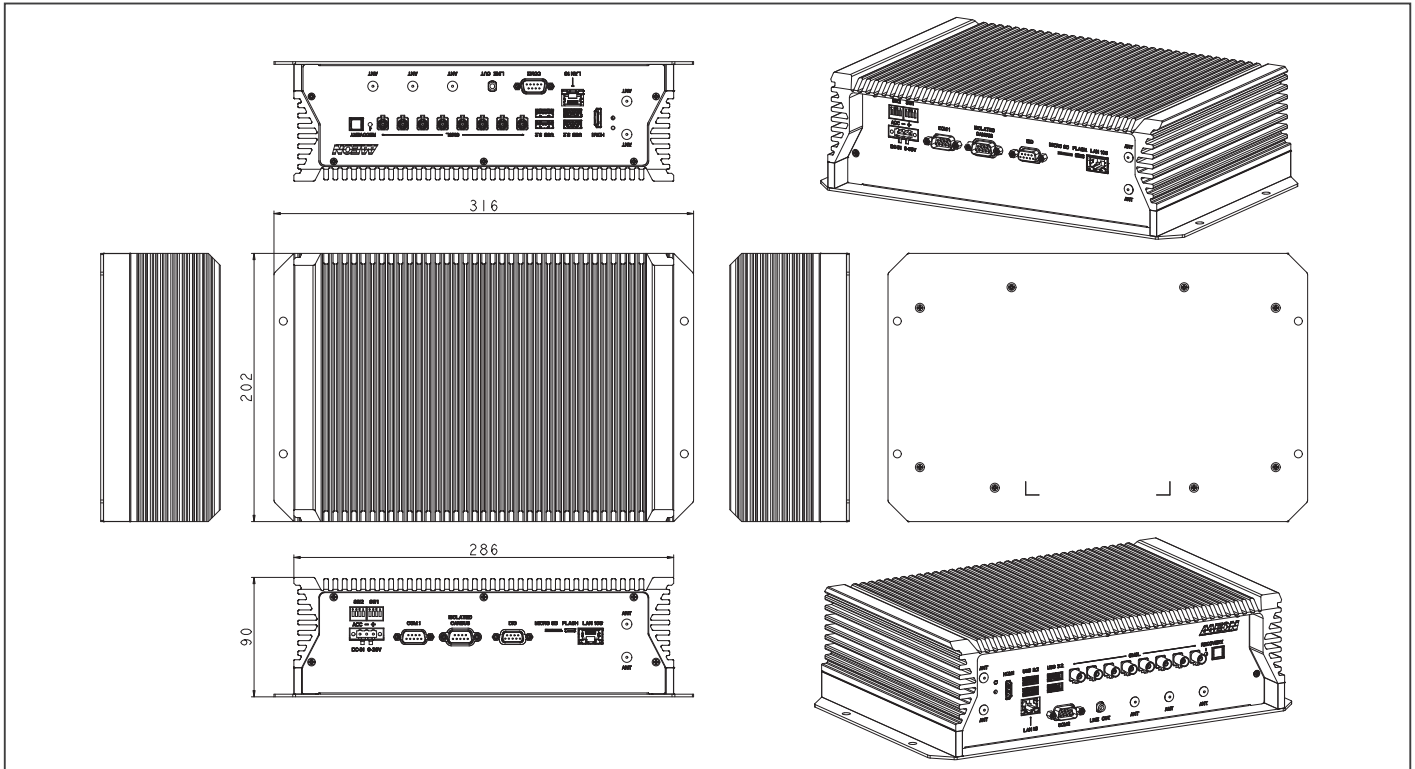

Ordering Information

Part Number	AI Solution	GMSL	LAN	USB	RS-232/422/485	Isolated CANBUS	DIO	Storage	GNSS & 9 axis sensors & TPM	Display	Mounting	Power	Operation System
BOXER-8645AI-JP511E-A1-1110	NVIDIA® Jetson AGX Orin™ 32GB	8	10G x 1 & Giga x 1	3.2 Gen 2 x 4	2	2	8	64GB eMMC, M.2 2280 NVMe M Key x 2, 2.5" SATA x 2	Built in	HDMI x 1	Wallmount	9 – 36VDC w/ 3 pin terminal block and Ignition delay on/off	Linux (NVIDIA Jetpack™ 5.0 or above)
BOXER-8645AI-JP511E-A2-1110	NVIDIA® Jetson AGX Orin™ 64GB	8	10G x 1 & Giga x 1	3.2 Gen 2 x 4	2	2	8	64GB eMMC, M.2 2280 NVMe M Key x 2, 2.5" SATA x 2	Built in	HDMI x 1	Wallmount	9 – 36VDC w/ 3 pin terminal block and Ignition delay on/off	Linux (NVIDIA Jetpack™ 5.0 or above)

Packing List

- BOXER-8645AI
- Power Connector x 1
- Screw Package x 1
- HDMI Cable Holder x 1

Optional Accessories

- **1255X00059**
120W Power Adapter
- **170X000799**
Power Cord (US Type)
- **170X000800**
Power Cord (European Type)
- **170X000803**
Power Cord (Japanese Type)
- **9641864500**
M.2 2280 NVMe Gen 3 M key Thermal Kit. For the SSD support list, please check the user manual.
- **9641864510**
M.2 2280 NVMe Gen 4 M key Thermal Kit. For the SSD support list, please check the user manual.

BOXER-8646AI

AI@Edge Fanless PoE Embedded AI System with NVIDIA® Jetson AGX Orin™

Front View

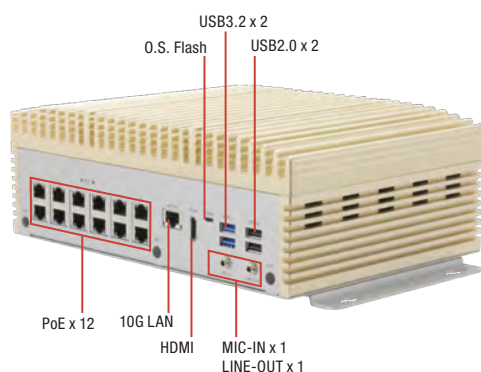

Rear View

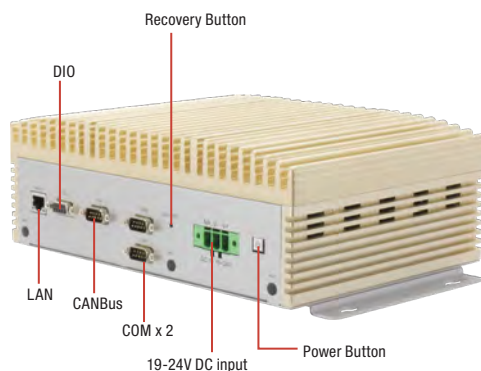

Features

- NVIDIA® Jetson AGX Orin™
- PoE/PSE GbE LAN x 12
- 10G LAN x 1 and Giga LAN x 1
- Multi-expansion: M.2 E Key / M.2 B Key / M.2 M Key
- CANBus / COM / DIO



Specifications

System	
AI Accelerator	NVIDIA® Jetson AGX Orin™
CPU	8-core ARM v8.2 64bit CPU, 2MB L2 + 4MB L3
System Memory	32GB LPDDR5
Storage Device	64GB eMMC 5.1 x 1 M.2 2280 NVMe M Key x 1
Display Interface	HDMI Type A x 1 for HDMI 2.0
Ethernet	RJ-45 x 12 for GbE PoE/PSE (802.3af/at, MAX.:120W) RJ-45 x 1 for 10G LAN RJ-45 x 1 for Giga LAN
I/O	USB Type A for USB 3.2 Gen 1 x 2 USB Type A for USB 2.0 x 2 Micro USB x 1 for OS Flash Mic-in x 1 Line-out x 1 DB-9 x 1 for CANBus FD x 2 DB-9 x 2 for RS-232/422/485 DB-9 x 1 for DIO x 8 3-pin terminal block x 1 for power input Power button x 1 Recovery button x 1 Antenna hole x 6
Expansion	M.2 2230 E Key x 1 (Wifi/BT) M.2 3052 B Key x 1 (LTE) M.2 2280 NVMe M Key x 1 SIM Slot x 1
Indicator	Power LED x 1
OS Support	Linux (NVIDIA Jetpack 6.x and up)
Power Supply	
Power Requirement	3-pin terminal block x 1 for 19V~24V
Mechanical	
Mounting	Wallmount
Dimensions (W x D x H)	10.42 " x 7.24 " x 3.67" (264.76 mm x 184.00 mm x 93.30 mm)
Gross Weight	12.13lb (5.5kg)
Net Weight	9.92lb (4.5kg)
Environmental	
Operating Temperature	-4°F ~ 122°F (-20°C ~ 50°C with 0.5 m/s airflow)
Storage Temperature	-40°F ~ 158°F (-40°C ~ 70°C)
Storage Humidity	5 ~ 95% @ 40°C, non-condensing
Anti-Vibration	3.5Grms / 5~500Hz
Anti-Shock	50G peak acceleration
Certification	CE / FCC class A





Dimension

Unit: mm

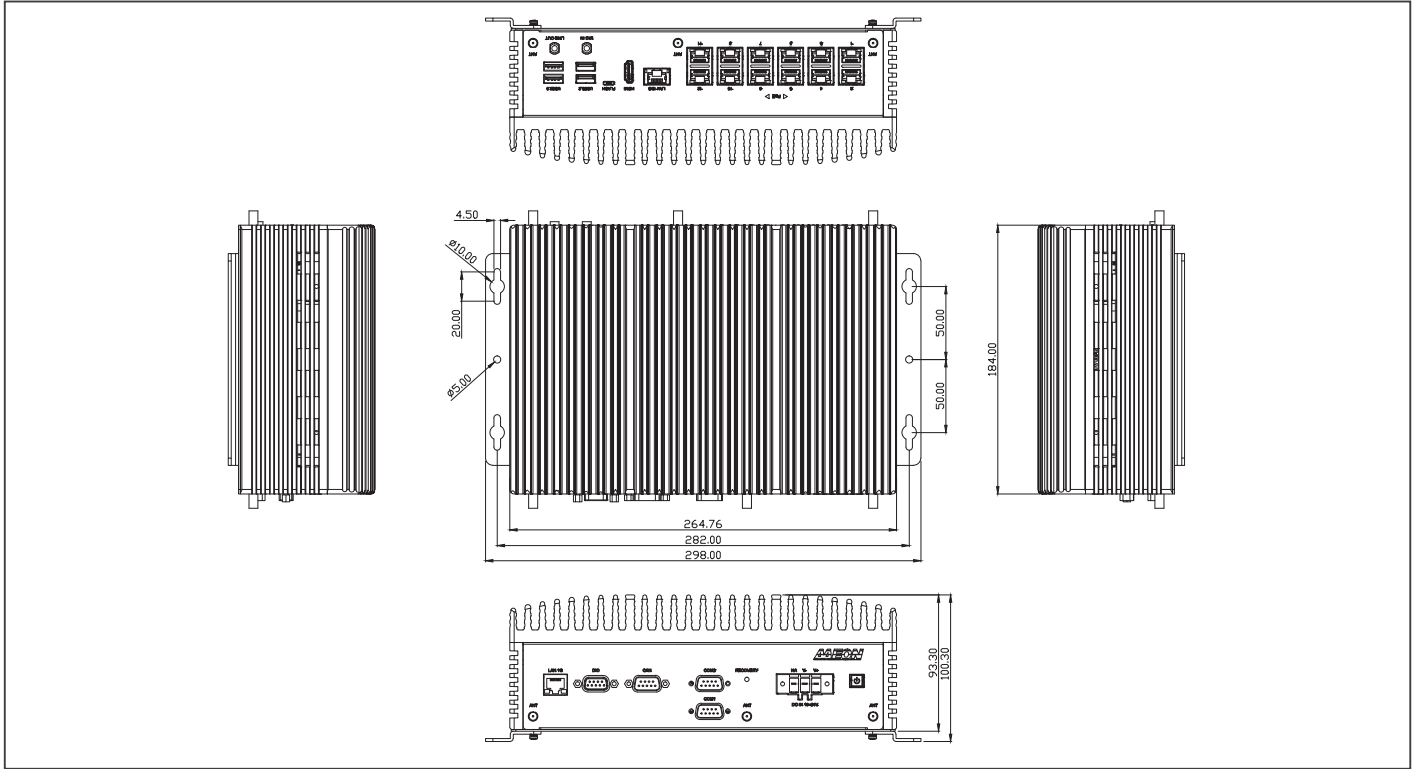

Ordering Information

Part Number	AI Solution	POE LAN	USB	RS-232/422/485	CANBus	LAN	DIO	Storage	Display	Mounting	Power	Operation System
BOXER-8646AI-JP511N-A1-1010	NVIDIA® Jetson AGX Orin™ 32GB	12 (Max. 120W)	3.2 Gen 1 x 2, 2.0 x 2	2	2	10G LAN x 1, Giga LAN x 1	8	64GB eMMC M.2 2280 NVMe M Key	HDMI 2.0 x 1	Wallmount	19V ~ 24VDC w/ 3 pin terminal block	Linux (NVIDIA Jetpack™ 5.0 or above)
BOXER-8646AI-JP511N-A2-1010	NVIDIA® Jetson AGX Orin™ 64GB	12 (Max. 120W)	3.2 Gen 1 x 2, 2.0 x 2	2	2	10G LAN x 1, Giga LAN x 1	8	64GB eMMC M.2 2281 NVMe M Key	HDMI 2.0 x 1	Wallmount	19V ~ 24VDC w/ 3 pin terminal block	Linux (NVIDIA Jetpack™ 5.0 or above)
BOXER-8646AI-JP600N-A1-1010	NVIDIA® Jetson AGX Orin™ 32GB	12 (Max. 120W)	3.2 Gen 1 x 2, 2.0 x 2	2	2	10G LAN x 1, Giga LAN x 1	8	64GB eMMC M.2 2282 NVMe M Key	HDMI 2.0 x 1	Wallmount	19V ~ 24VDC w/ 3 pin terminal block	Linux (NVIDIA Jetpack™ 6.0)
BOXER-8646AI-JP600N-A2-1010	"NVIDIA® Jetson AGX Orin™ 64GB"	12 (Max. 120W)	3.2 Gen 1 x 2, 2.0 x 2	2	2	10G LAN x 1, Giga LAN x 1	8	64GB eMMC M.2 2283 NVMe M Key	HDMI 2.0 x 1	Wallmount	19V ~ 24VDC w/ 3 pin terminal block	Linux (NVIDIA Jetpack™ 6.0)

Packing List

- BOXER-8646AI x 1
- Wallmount Bracket x 2
- Power Connector x 1
- Screw Package x 1

Optional Accessories

- 1255903300
330W Power Adapter
- 170X000799
Power Cord (US type)
- 170X000800
Power Cord (European Type)
- 170X000803
Power Cord (Japanese Type)

BOXER-8651AI

AI@Edge Compact Fanless Embedded AI System with NVIDIA® Jetson Orin™ NX



Front View

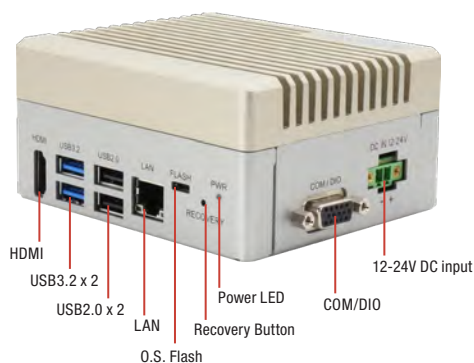

Rear View



Features

- NVIDIA® Jetson Orin™ NX
- Expansion: M.2 2230 E-Key x 1, M.2 3052 B-Key x 1
- USB 3.2 Gen 2 (Type-A) x 2 & USB 2.0 (Type-A) x 2
- COM, DIO, CANBus
- Operating Temperature: -5°F~ 131°F (-15°C ~ 55°C)



Specifications

System	
AI Accelerator	NVIDIA® Jetson Orin™ NX
CPU	6-core Arm® Cortex®-A78AE ARMv8.2 64-bit CPU
System Memory	8GB/16GB LPDDR5
Storage Device	M.2 3052 B-Key x 1 for M.2 2242 B+M Key SSD (Default Storage) M.2 2230 E-Key x 1 (Optional)
Display Interface	HDMI 2.1 (Type-A) x 1
Ethernet	RJ-45 x 1 for GbE LAN
I/O	USB 3.2 Gen 2 (Type-A) x 2 USB 2.0 (Type-A) x 2 DB-9 for RS-232 (Rx/Tx/CTS/RTS)/485 x 1 and CANBus FD x 1 DB-15 for RS-232 (Rx/Tx)/422/485 x 1 and DIO x 8 Micro USB x 1 for OS Flash Recovery Button x 1 Antenna x 2
Expansion	M.2 3042/3052 B Key x 1 (4G/5G/M.2 2242 B+M Key storage) M.2 2230 E Key x 1 (Wifi/BT/Storage) SIM Slot x 1
Indicator	Power LED x 1
OS Support	Linux (NVIDIA Jetpack™ 5.0 up)
Power Supply	
Power Requirement	12V~24V DC in with 2 pins terminal block x 1
Mechanical	
Mounting	Wallmount
Dimensions (W x D x H)	4.13" x 3.54" x 2.05" (105mm x 90mm x 52mm), w/o bracket
Gross Weight	2.4 lb (1.1kg)
Net Weight	1.58 lb (0.7kg)
Environmental	
Operating Temperature	-5°F ~ 131°F (-15°C ~ 55°C), according to IEC60068-2 with 0.5 m/s AirFlow
Storage Temperature	-40°F ~ 185°F (-40°C ~ 85°C)
Storage Humidity	5% ~ 95% @ 40C, non-condensing
Anti-Vibration	3.5Grms / 5~500Hz / Operation
Anti-Shock	50G peak acceleration
Certification	CE/FCC class A





Dimension

Unit: mm

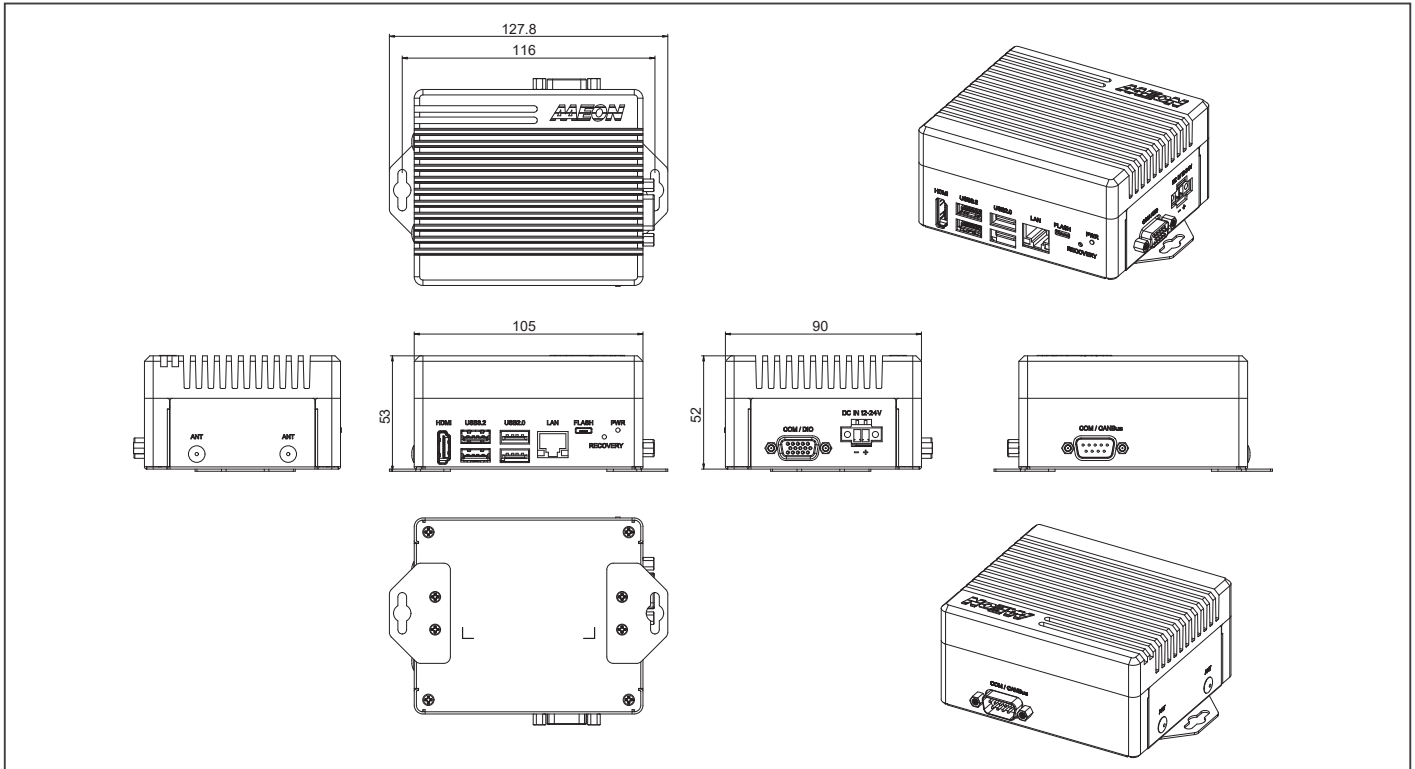

Ordering Information

Part Number	AI Solution	LAN	USB	RS-232/422/485	CANBus	DIO	Storage	Display	Mounting	Power	Operation System
BOXER-8651AI-JP511N-A1-1010	NVIDIA® Jetson Orin NX™ 8GB	1	3.2 Gen 2 x 2, 2.0 x 2	2	1	8	M.2 3052 B-Key x 1 for M.2 2242 B+M Key SSD (Default: 128GB) M.2 2230 E-Key x 1 (Optional)	HDMI x 1	Wallmount	12 ~ 24VDC w/ 2 pin terminal block	Linux (NVIDIA Jetpack™ 5.0 or above)
BOXER-8651AI-JP511N-A2-1010	NVIDIA® Jetson Orin NX™ 16GB	1	3.2 Gen 2 x 2, 2.0 x 2	2	1	8	M.2 3052 B-Key x 1 for M.2 2242 B+M Key SSD (Default: 128GB) M.2 2230 E-Key x 1 (Optional)	HDMI x 1	Wallmount	12 ~ 24VDC w/ 2 pin terminal block	Linux (NVIDIA Jetpack™ 5.0 or above)

Packing List

- BOXER-8651AI x 1
- Wallmount Bracket x 2
- Power connector x 1
- Screw Package x 1

Optional Accessories

- 1255300611
60W Power Adapter
- 170X000799
Power Cord (US type)
- 170X000800
Power Cord (European Type)
- 170X000803
Power Cord (Japanese Type)

BOXER-8651AI-PLUS

AI@Edge Compact Fanless Embedded AI System with NVIDIA® Jetson Orin™ NX

Front View

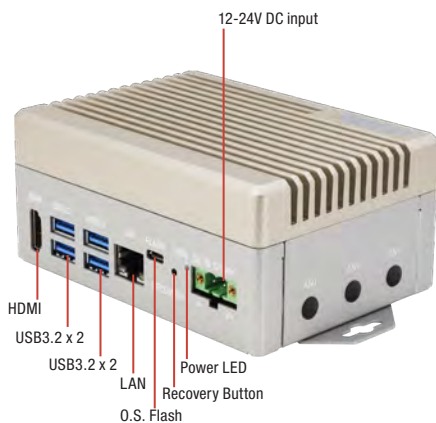

Rear View

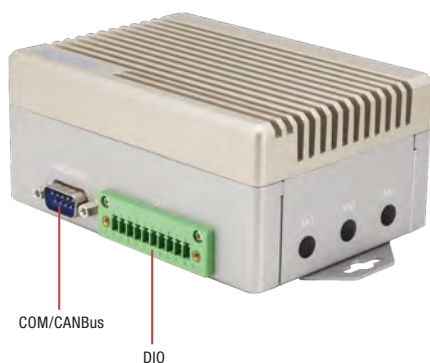

Features

- NVIDIA® Jetson Orin™ NX with Super Mode
- Supports NVIDIA JetPack™ 6.2
- USB 3.2 Gen 2 (Type-A) x 4
- DB-9 x 1 for RS-232(Rx/Tx/RTS/CTS) & CANBus
- 10-pin terminal block for DIO x 8
- Onboard TPM
- M.2 2230 E-Key, M.2 3052 B-Key
- Operating Temperature: -13°F - 131°F (-25°C - 55°C)



Specifications

System	
AI Accelerator	NVIDIA® Jetson Orin™ NX
CPU	Orin NX 8GB: 6-core Arm® Cortex®-A78AE v8.2 64-bit CPU Orin NX 16GB: 8-core Arm® Cortex®-A78AE v8.2 64-bit CPU
System Memory	Orin NX 8GB: 8GB LPDDR5 Orin NX 16GB: 16GB LPDDR5
Storage Device	M.2 3052 B-Key x 1 for M.2 2242 B+M Key SSD (Default Storage) M.2 2230 E-Key x 1 (Optional)
Display Interface	HDMI 1.2 (Type-A) x 1, up to 1920 x 1080
Ethernet	RJ-45 x 1 for GbE LAN
I/O	USB 3.2 Gen 2 (Type-A) x 4 DB-9 for RS-232 (Rx/Tx/CTS/RTS) & CANBus FD x 1 10-pin terminal block for DIO x 8 Micro USB x 1 for OS Flash Recovery Button x 1 Antenna x 6
Expansion	M.2 3042/3052 B Key x 1 (4G/5G/M.2 2242 B+M-Key storage) M.2 2230 E Key x 1 (Wi-Fi/BT) SIM Slot x 1
Indicator	Power LED x 1
OS Support	Linux (NVIDIA Jetpack™ 6.2 and above)
Power Supply	
Power Requirement	12VDC ~ 24VDC via 2-pin Terminal Block
Mechanical	
Mounting	Wallmount
Dimensions (W x D x H)	4.92" x 3.54" x 2.2" (125mm x 90mm x 56mm)
Gross Weight	3.13 lb. (1.42Kg)
Net Weight	1.85 lb. (0.84Kg)
Environmental	
Operating Temperature	-13°F ~ 131°F (-25°C ~ 55°C with 0.7m/s airflow)
Storage Temperature	-40°F ~ 185°F (-40°C ~ 85°C)
Storage Humidity	5 ~ 95% @ 40°C, non-condensing
Anti-Vibration	3.5 Grms, 5~500Hz with SSD
Anti-Shock	50G peak acceleration
Certification	CE / FCC class A





BOXER-8651AI-PLUS

Dimension

Unit: mm

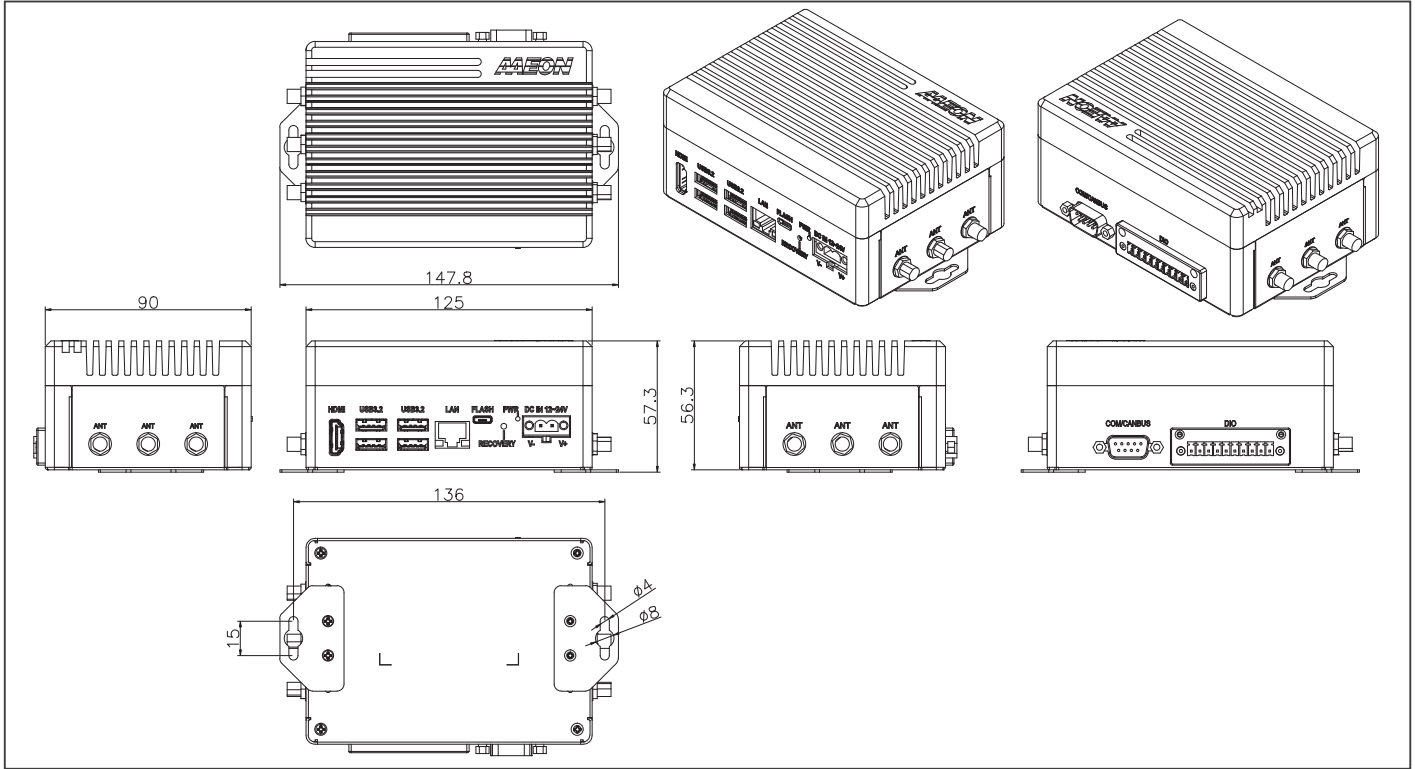

Ordering Information

Part Number	AI SOLUTION	LAN	USB 3.2 Gen 2	RS232/422/485	CANBUS	DIO	Storage	Display	Mounting	Power	Operation System
BOXER-8651AI-JP620N-B1-1010	NVIDIA® Jetson Orin™ NX 8GB	1	4	1	1	8	M.2 3052 B-Key x 1 for M.2 2242 B-M Key SSD (Default: 128GB) M.2 2230 E-Key x 1 (Optional)	HDMI x 1	Wallmount	12 – 24VDC w/ 2 pin terminal block	Linux (NVIDIA Jetpack™ 6.2 or above)
BOXER-8651AI-JP620N-B2-1010	NVIDIA® Jetson Orin™ NX 16GB	1	4	1	1	8	M.2 3052 B-Key x 1 for M.2 2242 B-M Key SSD (Default: 128GB) M.2 2230 E-Key x 1 (Optional)	HDMI x 1	Wallmount	12 – 24VDC w/ 2 pin terminal block	Linux (NVIDIA Jetpack™ 6.2 or above)
BOXER-8651AI-JP620N-B3-1010	NVIDIA® Jetson Orin NX™ 8GB	1	4	1	1	8	M.2 3052 B-Key x 1 for M.2 2242 B-M Key SSD (Default: 128GB) M.2 2230 E-Key x 1 (Optional)	HDMI x 1	Wallmount	12 – 24VDC w/ 2 pin terminal block	Linux (NVIDIA Jetpack™ 6.2 or above), MAZU Security Support

Packing List

- BOXER-8651AI-PLUS (BOXER-8651AI-B1)
- Wallmount Bracket x 2
- Screw Package x 1

Optional Accessories

- 1255300611
60W Power Adapter
- 170X000799
Power Cord (US type)
- 170X000800
Power Cord (European Type)
- 170X000803
Power Cord (Japanese Type)

BOXER-8652AI

AI@Edge Compact Fanless Embedded AI System with NVIDIA® Jetson Orin™ NX

Front View

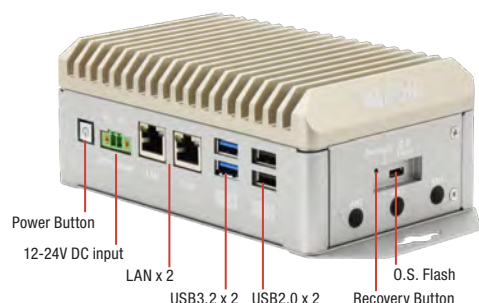

Rear View

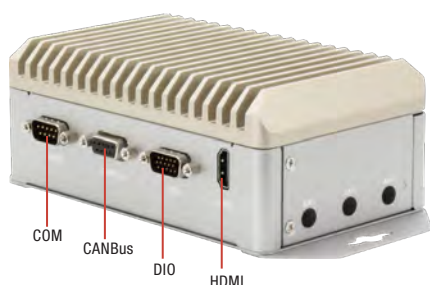

Features

- NVIDIA® Jetson Orin™ NX
- 8GB/16GB LPDDR5
- Supports M.2 E-Key x 1, M.2 B-Key x 1, M.2 M-Key x 1
- Supports DB-9 x 1 for CANBus
- Supports GbE LAN x 2



Specifications

System	
AI Accelerator	NVIDIA® Jetson Orin™ NX
CPU	6-core Arm® Cortex®-A78AE v8.2 64-bit CPU
System Memory	8GB/16GB LPDDR5
Storage Device	M.2 2280 M-Key x 1
Display Interface	HDMI 2.0 (Type-A) x 1
Ethernet	RJ-45 x 2 for 10/100/1000 Base-T
I/O	USB 3.2 Gen 2 (Type-A) x 2 USB 2.0 (Type-A) x 2 Micro USB x 1 for OS Flash DB-9 x 1 for CANBus DB-9 x 1 for RS-232/422/485 DB-15 x 1 for 13-bit DIO Power ON/OFF switch x 1 Recovery button x 1 Antenna Hole x 6
Expansion	M.2 2230 E-Key x 1 (Wi-Fi/Bluetooth) M.2 3042/3052 B-Key x 1 (4G/5G) M.2 2280 M-Key x 1
Indicator	Power LED x 1
OS Support	Linux (NVIDIA Jetpack™ 5.0 and up)
Power Supply	
Power Requirement	DC-in 12-24V with 2-pin terminal block
Mechanical	
Mounting	Wallmount
Dimensions (W x D x H)	5.98" x 3.78" x 2.42" (152mm x 96 mm x 61.5mm)
Gross Weight	3.97lb (1.8kg)
Net Weight	2.65lb (1.2kg)
Environmental	
Operating Temperature	-5°F ~ 140°F (-15°C ~ 60°C with 0.5 m/s airflow)
Storage Temperature	-40°F ~ 176°F (-40°C ~ 85°C)
Storage Humidity	5 ~ 95% @ 40°C, non-condensing
Anti-Vibration	3.5Grms / 5~500Hz
Anti-Shock	50G peak acceleration
Certification	CE / FCC class A





Dimension

Unit: mm

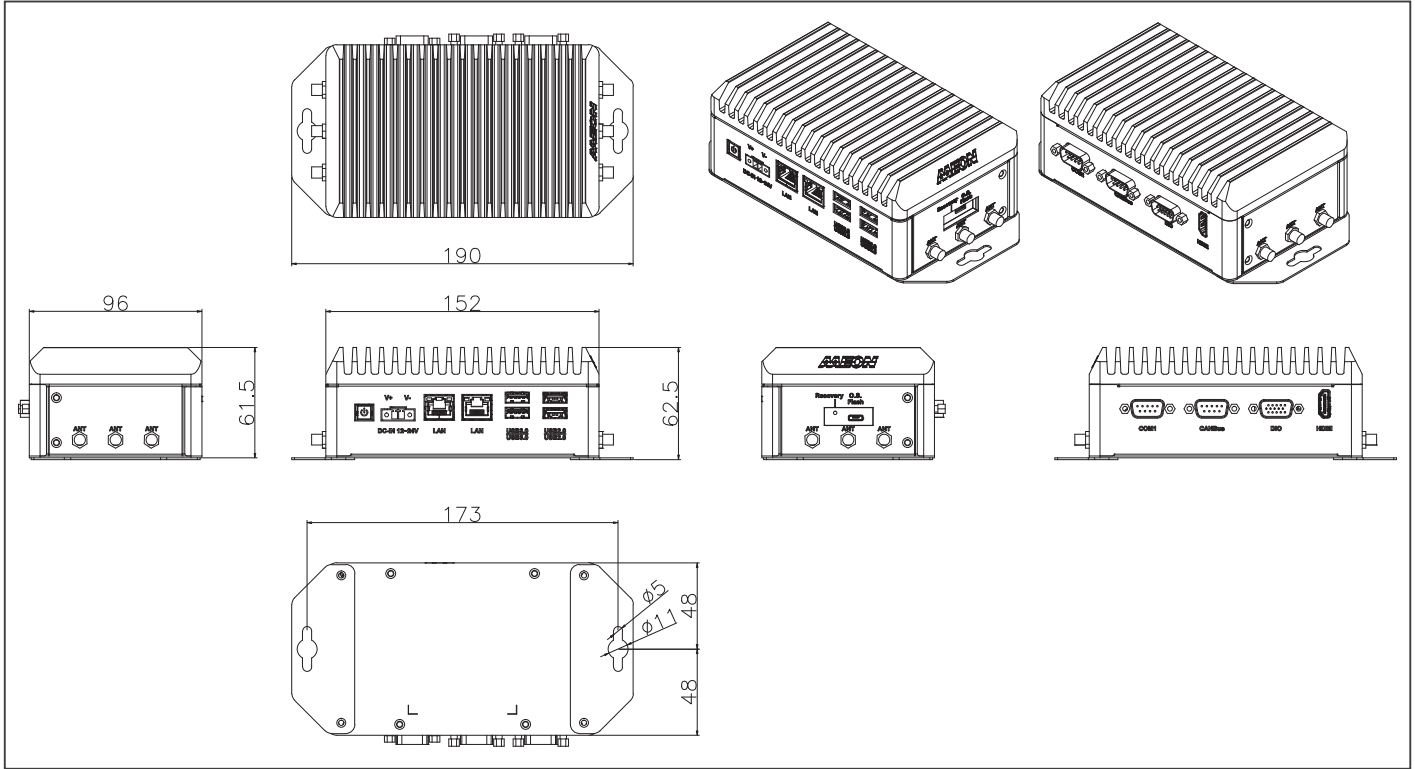

Ordering Information

Part Number	AI Solution	LAN	USB	RS-232/422/485	CANBus	DIO	Storage	Display	Mounting	Power	Operation System
BOXER-8652AI-JP511N-A1-1010	NVIDIA® Jetson Orin NX™ 8GB	2	3.2 Gen 2 x 2, 2.0 x 2	1	1	13	M.2 2280 M-Key x 1 for Storage (Default: 128GB)	HDMI x 1	Wallmount	12 ~ 24VDC w/ 2 pin terminal block	Linux (NVIDIA Jetpack™ 5.0 or above)
BOXER-8652AI-JP511N-A2-1010	NVIDIA® Jetson Orin NX™ 16GB	2	3.2 Gen 2 x 2, 2.0 x 2	1	1	13	M.2 2280 M-Key x 1 for Storage (Default: 128GB)	HDMI x 1	Wallmount	12 ~ 24VDC w/ 2 pin terminal block	Linux (NVIDIA Jetpack™ 5.0 or above)
BOXER-8652AI-JP600N-A1-1010	NVIDIA® Jetson Orin NX™ 8GB	2	3.2 Gen 2 x 2, 2.0 x 2	1	1	13	M.2 2280 M-Key x 1 for Storage (Default: 128GB)	HDMI x 1	Wallmount	12 ~ 24VDC w/ 2 pin terminal block	Linux (NVIDIA Jetpack™ 6.0 or above)
BOXER-8652AI-JP600N-A2-1010	NVIDIA® Jetson Orin NX™ 16GB	2	3.2 Gen 2 x 2, 2.0 x 2	1	1	13	M.2 2280 M-Key x 1 for Storage (Default: 128GB)	HDMI x 1	Wallmount	12 ~ 24VDC w/ 2 pin terminal block	Linux (NVIDIA Jetpack™ 6.0 or above)

Packing List

- BOXER-8652AI x 1
- Wallmount Bracket x 2
- Power connector x 1
- Screw Package x 1

Optional Accessories

- 1255300611
60W Power Adapter
- 170X000799
Power Cord (US type)
- 170X000800
Power Cord (European Type)
- 170X000803
Power Cord (Japanese Type)

BOXER-8652AI-PLUS PRELIMINARY

AI@Edge Compact Fanless Embedded AI System with NVIDIA® Jetson Orin™ NX



Front View



Rear View



Features

- NVIDIA® Jetson Orin™ NX
- Supports NVIDIA® JetPack 6.2 Super mode
- 8GB/16GB LPDDR5
- M.2 E-Key, M.2 B-Key, M.2 M-Key
- DB-9 x 3 for CANBus, RS-232/422/485, DIO
- GbE LAN x 2, OOB Management Support



Specifications

System	
AI Accelerator	NVIDIA® Jetson Orin™ NX
CPU	6-core Arm® Cortex®-A78AE v8.2 64-bit CPU
System Memory	8GB/16GB LPDDR5
Storage Device	M.2 M-Key x 1, 128G Gen 3 SSD by default
Display Interface	HDMI x 1 for HDMI 2.0
Ethernet	RJ-45 Giga LAN x 2
I/O	USB 3.2 Gen 2 type A x 4 DB-9 x 1 for CANBUS FD DB-9 x 1 for RS232/422/485 DB-9 x 1 for DIO x 8 Mini-USB x 1 for OS Flash Reset button x 1 Power Button x 1 External SMA antenna x 6
Expansion	M.2 B-Key 3052 x 1 + Nano SIM x 1 for 4G/5G LTE M.2 E-Key 2230 x 1 for Wi-Fi/BT M.2 M-Key 2280 x 1 for NVMe
Indicator	Power LED x 1 System LED x 1
OS Support	NVIDIA Jetpack 6.x and up
Power Supply	
Power Requirement	DC-in 12-24V with 2-pin terminal block
Mechanical	
Mounting	Wallmount
Dimensions (W x D x H)	5.98" x 3.78" x 2.42" (152mm x 96 mm x 61.5mm)
Gross Weight	TBD
Net Weight	TBD
Environmental	
Operating Temperature	-25°C ~ 65°C, according to IEC60068-2 with 0.7 m/s Airflow with 25W
Storage Temperature	-40°C ~ 85°C, non operation
Storage Humidity	5%~ 95% @ 40°C, non-condensing
Anti-Vibration	3.5G / 5~500Hz / operating – NMVe M Key
Anti-Shock	50G peak acceleration – NMVe M Key
Certification	CE/FCC class A without RF





BOXER-8652AI-PLUS

Dimension

Unit: mm

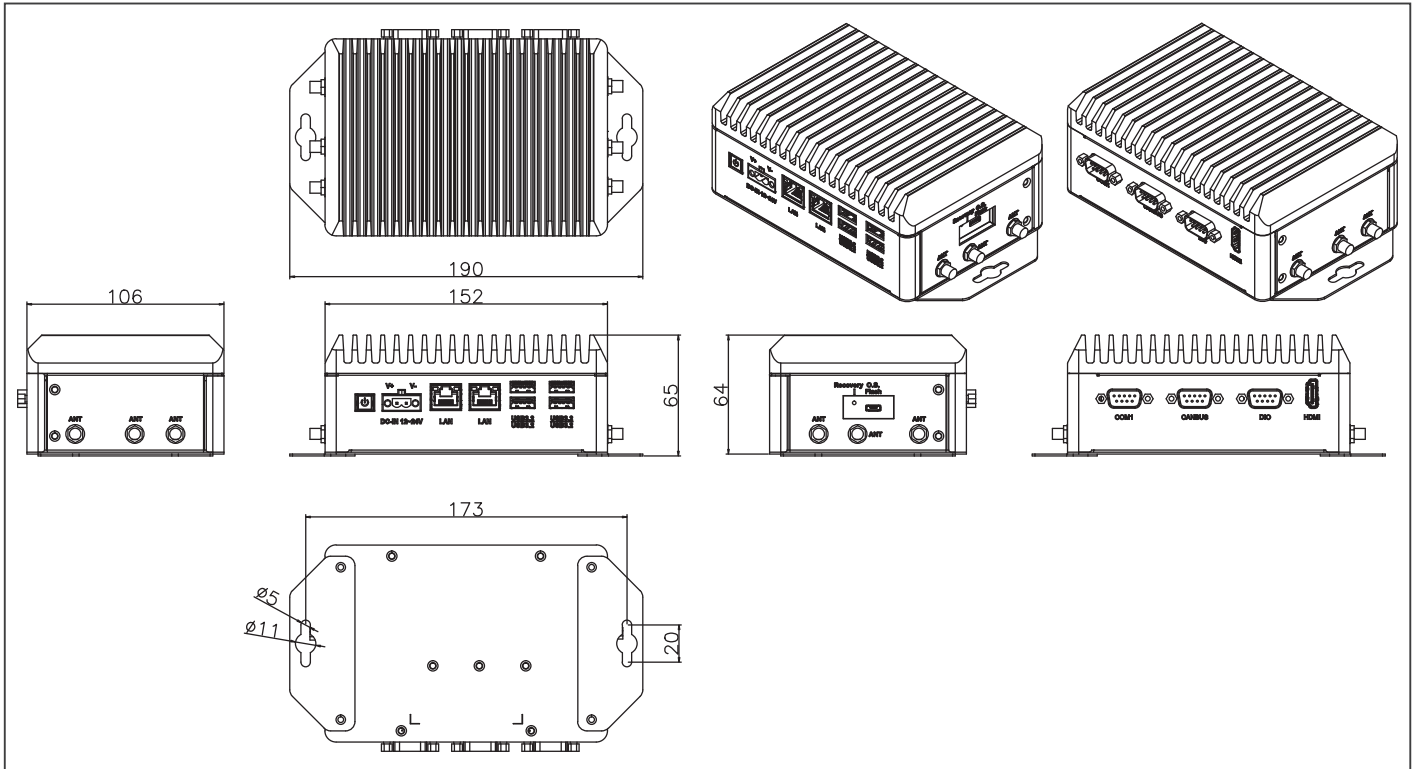

Ordering Information

- TBD

Optional Accessories

- 1255300611
60W Power Adapter
- 170X000799
Power Cord (US type)
- 170X000800
Power Cord (European Type)
- 170X000803
Power Cord (Japanese Type)

Packing List

- BOXER-8652AI-PLUS x 1
- Wallmount Bracket x 2
- Power connector x 1
- Screw Package x 1

BOXER-8653AI

AI@Edge Compact Fanless Embedded AI System with NVIDIA® Jetson Orin™ NX

Front View

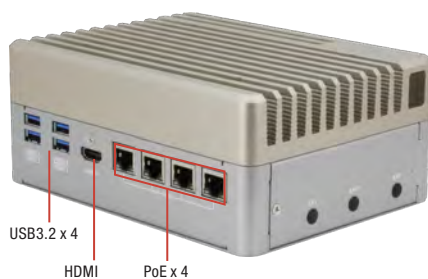

Rear View

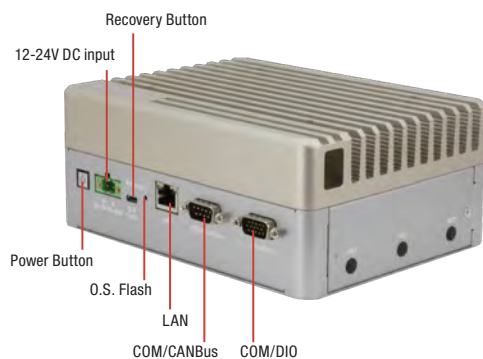

Features

- NVIDIA® Jetson Orin™ NX
- GbE PoE/PSE 802.3af/at x 4 + GbE LAN x 1
- M.2 2230 E-Key x 1, M.2 2280 M-Key x 1, M.2 3042/3052 B-Key x 1
- COM/CANBus/DIO
- Operating Temperature: -15°C ~ 60°C



Specifications

System	
AI Accelerator	NVIDIA® Jetson Orin™ NX
CPU	6-core Arm® Cortex®-A78AE ARMv8.2 64-bit CPU 8-core Arm® Cortex®-A78AE ARMv8.2 64-bit CPU
System Memory	8GB/16GB LPDDR5
Storage Device	M.2 2280 M Key x 1
Display Interface	HDMI 2.0 (Type-A) x 1
Ethernet	RJ-45 x 1 for GbE LAN RJ-45 x 4 for GbE PoE/PSE 802.3af/at (Max.60W)
I/O	USB 3.2 Gen 2 (Type-A) x 4 DB-9 x 1 for RS-232 (Rx/Tx/CTS/RTS)/RS485 x 1 and CANBus FD x 1 DB-15 x 1 for RS-232(Rx/Tx)/422/485 x 1 and DIO x 8 Micro USB x 1 for OS Flash Power Button x 1 Recovery Button x 1 Antenna Hole x 6
Expansion	M.2 2280 M-Key x 1 (NVMe) M.2 3042/3052 B-Key x 1 M.2 2230 E-Key x 1 SIM Slot x 1
Indicator	Power LED x 1
OS Support	Linux (NVIDIA Jetpack™ 5.0 and up)
Power Supply	
Power Requirement	12V ~ 24V DC in with 2-pin Terminal Block x 1
Mechanical	
Mounting	Wallmount
Dimensions (W x D x H)	7.09" x 5.35" x 2.95" (180mm x 136mm x 75mm)
Gross Weight	7.7 lb (3.5kg)
Net Weight	5.5 lb (2.5kg)
Environmental	
Operating Temperature	5°F ~ 140°F (-15°C ~ 60°C), according to IEC60068-2 with 0.5 m/s AirFlow
Storage Temperature	-40°F ~ 185°F (-40°C ~ 85°C)
Storage Humidity	5% ~ 95% @ 40°C, non-condensing
Anti-Vibration	3.5Grm / 5~500Hz / Operation
Anti-Shock	50G peak acceleration
Certification	CE/FCC class A





Dimension

Unit: mm

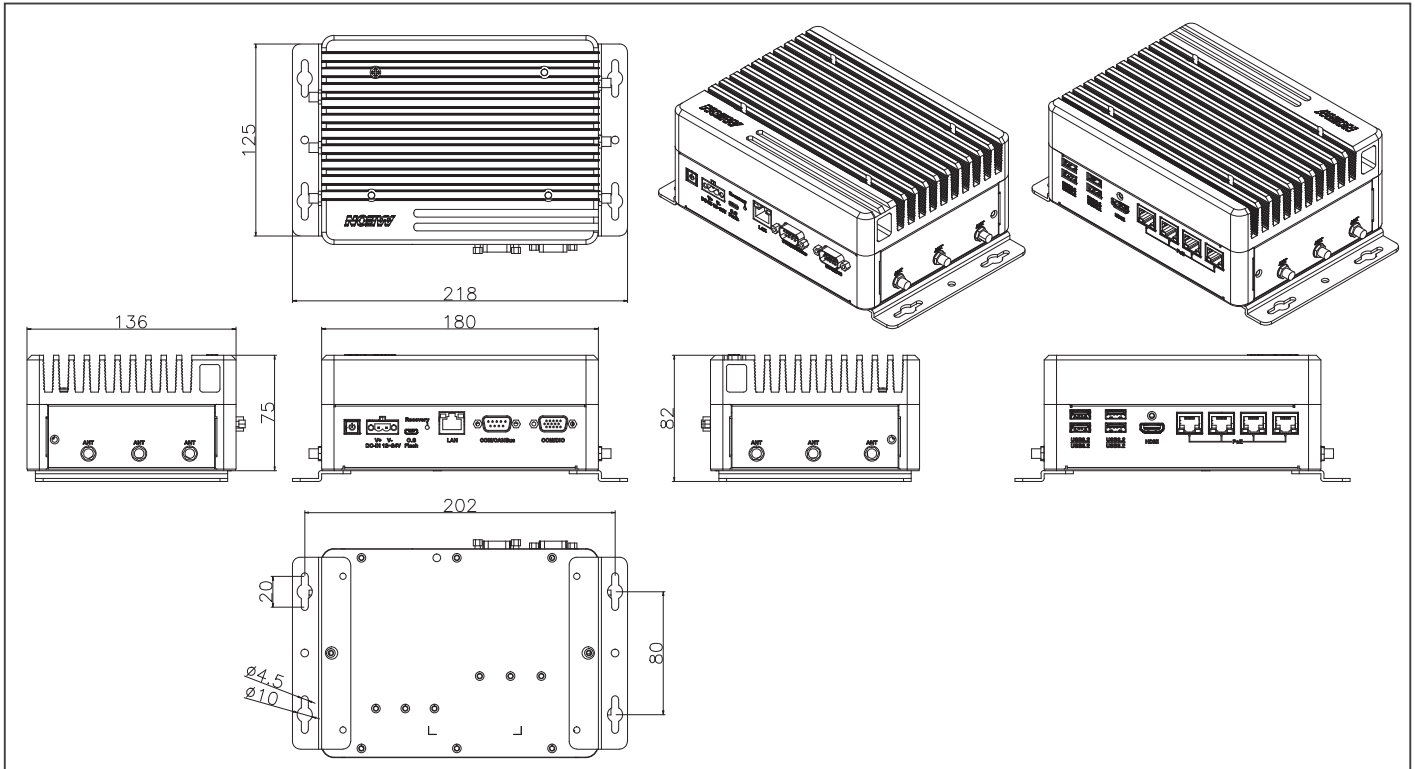

Ordering Information

Part Number	AI Solution	LAN	POE	USB	COM	CANBus	DIO	Storage	Display	Mounting	Power	Operation System
BOXER-8653AI-JP511N-A1-1010	NVIDIA® Jetson Orin NX™ 8GB	1	4	3.2 Gen 2 x 4	2	1	8	M.2 2280 M-Key x 1 for Storage (Default: 128GB)	HDMI x 1	Wallmount	12 ~ 24VDC w/ 2 pin terminal block	Linux (NVIDIA Jetpack™ 5.0 or above)
BOXER-8653AI-JP511N-A2-1010	NVIDIA® Jetson Orin NX™ 16GB	1	4	3.2 Gen 2 x 4	2	1	8	M.2 2280 M-Key x 1 for Storage (Default: 128GB)	HDMI x 1	Wallmount	12 ~ 24VDC w/ 2 pin terminal block	Linux (NVIDIA Jetpack™ 5.0 or above)

Packing List

- BOXER-8653AI x 1
- Wallmount Bracket x 2
- Power connector x 1
- Screw Package x 1

Optional Accessories

- 1255X00066
120W Power Adapter
- 170X000799
Power Cord (US type)
- 170X000800
Power Cord (European Type)
- 170X000803
Power Cord (Japanese Type)

BOXER-8653AI-PLUS PRELIMINARY

AI@Edge Compact Fanless Embedded AI System with NVIDIA® Jetson Orin NX™



Front View



Rear View



Features

- NVIDIA® Jetson Orin NX
- Supports NVIDIA® JetPack 6.2.1 Super mode
- GbE PoE/PSE 802.3af/at x 4 + GbE LAN x 1
- M.2 2230 E-Key x 1, M.2 2280 M-Key x 1, M.2 3042/3052 B-Key x 1, NANO SIM x1
- COM/CANBus/DIO
- On board TPM as default
- Operating Temperature: -25°C ~ 65°C



Specifications

System	
AI Accelerator	NVIDIA® Jetson Orin NX™
CPU	Orin NX 8GB: 6-core Arm® Cortex®-A78AE v8.2 64-bit CPU Orin NX 16GB: 8-core Arm® Cortex®-A78AE v8.2 64-bit CPU
System Memory	Orin NX 8GB: 8GB LPDDR5 Orin NX 16GB: 16GB LPDDR5
Storage Device	M.2 2280 M Key (128GB built-in) M.2 3042/3052 B Key x 1 M.2 2230 E key
Display Interface	HDMI 1.2a (Type-A) x 1
Ethernet	RJ-45 x 1 for GbE LAN RJ-45 x 4 for GbE LAN PoE/PSE (IEEE 802.3af/at, total 60W)
I/O	USB 3.2 Gen 2 (Type-A) x 4 DB-9 for RS-232 (Rx/Tx/CTS/RTS) & CANBus FD x 1 DB-15 for RS422/485/232 (Rx/Tx) x 1 & DIO x 8 Micro USB x 1 for OS Flash Recovery Button x 1 Antenna x 6
Expansion	M.2 3042/3052 B Key x 1 (LTE/5G/M.2 2242 B+M Key storage) M.2 2230 E Key x 1 (Wifi/BT) M.2 2280 M Key x 1 (NVMe 128GB built-in) NANO SIM x 1 TPM x 1 (onboard) Box Header x 1 for OOB"
Indicator	Power LED x 1
OS Support	Linux (NVIDA Jetpack 6.2 and above)
Power Supply	
Power Requirement	12~24VDC 2-pin Terminal Block
Mechanical	
Mounting	Wall mount kit
Dimensions (W x D x H)	7.48" x 5.35" x 2.95" (190mm x 136mm x 75mm)
Gross Weight	7.41 lb (3.36kg)
Net Weight	5.51 lb (2.5kg)
Environmental	
Operating Temperature	-13°F ~ 149°F (-25°C ~ 65°C with 0.7m/s airflow)
Storage Temperature	-40°F ~ 185°F (-40°C ~ 85°C)
Storage Humidity	5 ~ 95% @ 40°C, non-condensing
Anti-Vibration	3.5 Grms, 5~500Hz with SSD
Anti-Shock	50G peak acceleration with SSD
Certification	CE / FCC class A





BOXER-8653AI-PLUS

Dimension

Unit: mm

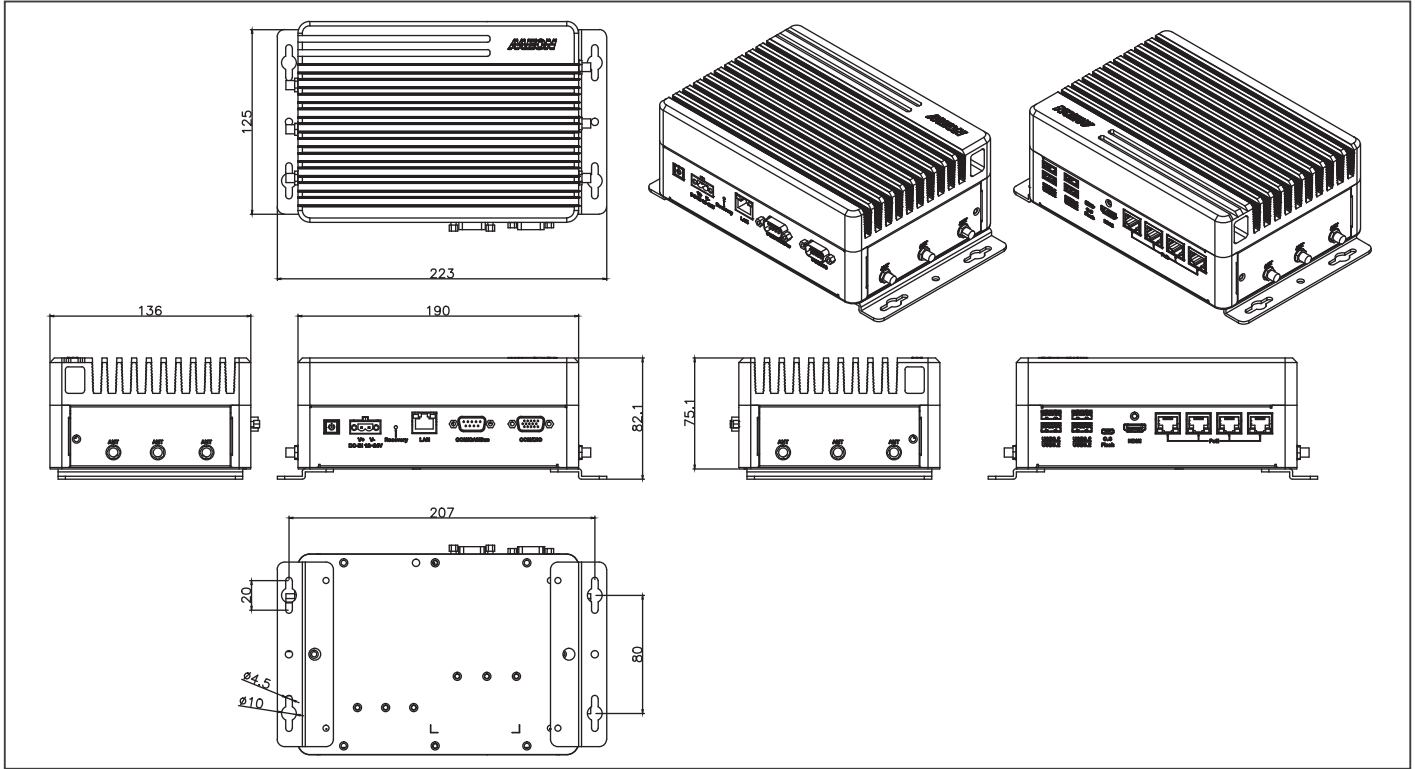

Ordering Information

Part Number	AI Solution	LAN	POE	USB	COM	CANBus	DIO	Storage	Display	Mounting	Power	Operation System
BOXER-8653AI-JP620N-B1-1010	NVIDIA® Jetson Orin NX™ 8GB	1	4	3.2 Gen 2 x 4	2	1	8	M.2 3042/3052 B Key x 1 (LTE/5G/M.2 2242 B+M Key storage) M.2 2230 E Key x 1 (Wifi/BT) M.2 2280 M Key x 1 (NVMe 128GB built-in)	HDMI 2.0 x 1	Wallmount	12 ~ 24VDC w/ 2 pin terminal block	Linux (NVIDIA Jetpack™ 6.2.1 or above)
BOXER-8653AI-JP620N-B2-1010	NVIDIA® Jetson Orin NX™ 16GB	1	4	3.2 Gen 2 x 4	2	1	8	M.2 3042/3052 B Key x 1 (LTE/5G/M.2 2242 B+M Key storage) M.2 2230 E Key x 1 (Wifi/BT) M.2 2280 M Key x 1 (NVMe 128GB built-in)	HDMI 2.0 x 1	Wallmount	12 ~ 24VDC w/ 2 pin terminal block	Linux (NVIDIA Jetpack™ 6.2.1 or above)

Packing List

- BOXER-8653AI-B1
- Wallmount Bracket x 2
- Screw Package x 1
- Power connector x 1

Optional Accessories

- 1255X00066
120W Power Adapter
- 170X000799
Power Cord (US type)
- 170X000800
Power Cord (European Type)
- 170X000803
Power Cord (Japanese Type)

BOXER-8654AI-KIT

AI@Edge Embedded board with NVIDIA® Jetson Orin™ NX

Front View

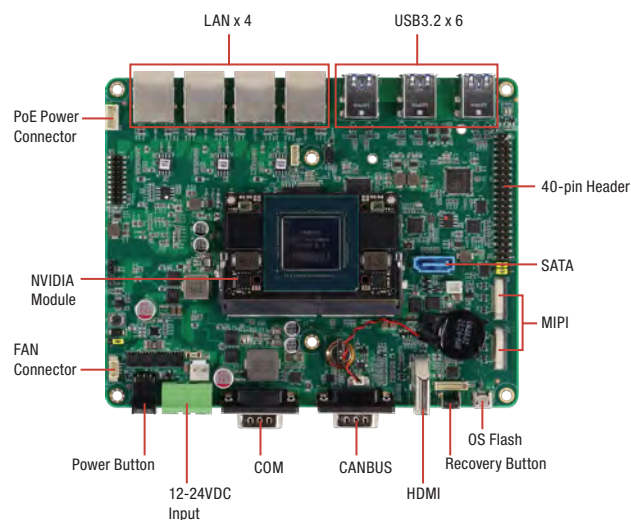

Rear View

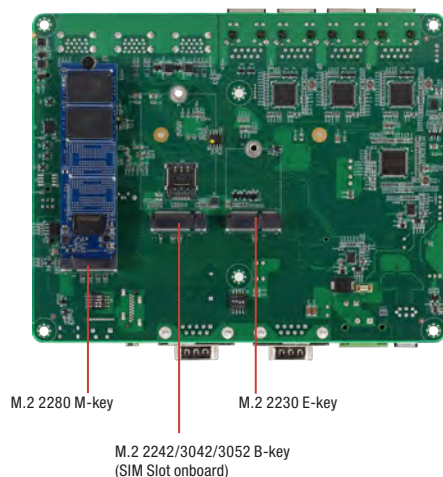

Features

- NVIDIA® Jetson Orin™ NX
- MIPI connector x 2
- M.2 2230 E-Key x 1, M.2 2280 M-Key x 1, M.2 3052 B-Key x 1
- 40-pin Header compliant with NVIDIA Jetson Orin Nano Developer Kit
- PoE Connector, FAN connector
- 12V ~ 24V Wide Power DC Input
- TPM 2.0 Support (by Jumper select)



Specifications

System	
AI Accelerator	NVIDIA® Jetson Orin™ NX
CPU	Orin NX 16GB: 8-core Arm® Cortex®-A78AE ARMv8.2 64-bit CPU Orin NX 8GB: 6-core Arm® Cortex®-A78AE ARMv8.2 64-bit CPU
System Memory	16GB LPDDR5 8GB LPDDR5
Storage Device	M.2 M-Key 2280 x 1 (NVMe)
Display Interface	HDMI Type A for HDMI 1.4 x 1
Ethernet	RJ-45 x 4 for GbE LAN (optional: power module for PoE (25.6W each port))
I/O	MIPI Connector x 2 (4 lanes for each MIPI connector, Default IMX219) DB-9 x 1 for RS-232(RX/TX/GND)/422/485 DB-9 x 1 for CANBus USB Type A x 6 for USB 3.2 Gen 2 Micro USB for image flash x 1 Power Button with LED Indicator x 1 2-pin Phoenix Type x 1 for Power Input Recovery Button x 1 40-pin Header compliant with NVIDIA Jetson Orin Nano Developer Kit Pin Header x 1 for RS/232/422/485 by jump select UART to 40-pin Box Header x 1 for OOB SATA Connector x 1 SATA power Connector x 1
Expansion	M.2 2230 E-Key x 1 M.2 2242/3042/3052 B-Key x 1 (SIM onboard) M.2 2280 M-Key x 1
Indicator	Power LED x 1
OS Support	Linux (NVIDIA Jetpack™ 6.0 and above)
Power Supply	
Power Requirement	12V ~ 24V DC in with 2-pin Terminal Block x 1
Mechanical	
Mounting	—
Dimensions (W x D x H)	6.53" x 5.24" (166mm x 133mm)
Gross Weight	0.79 lbs (0.36 kg)
Net Weight	0.42 lbs (0.19 kg)
Environmental	
Operating Temperature	-13°F ~ 158°F (-25°C ~ 70°C) w/ Fan Kit, according to IEC60068-2 with 0.5 m/s AirFlow
Storage Temperature	-40°F ~ 185°F (-40°C ~ 85°C)
Storage Humidity	5 ~ 95% @ 40°C, non-condensing
Anti-Vibration	—
Anti-Shock	—
Certification	CE / FCC class A





Dimension

Unit: mm

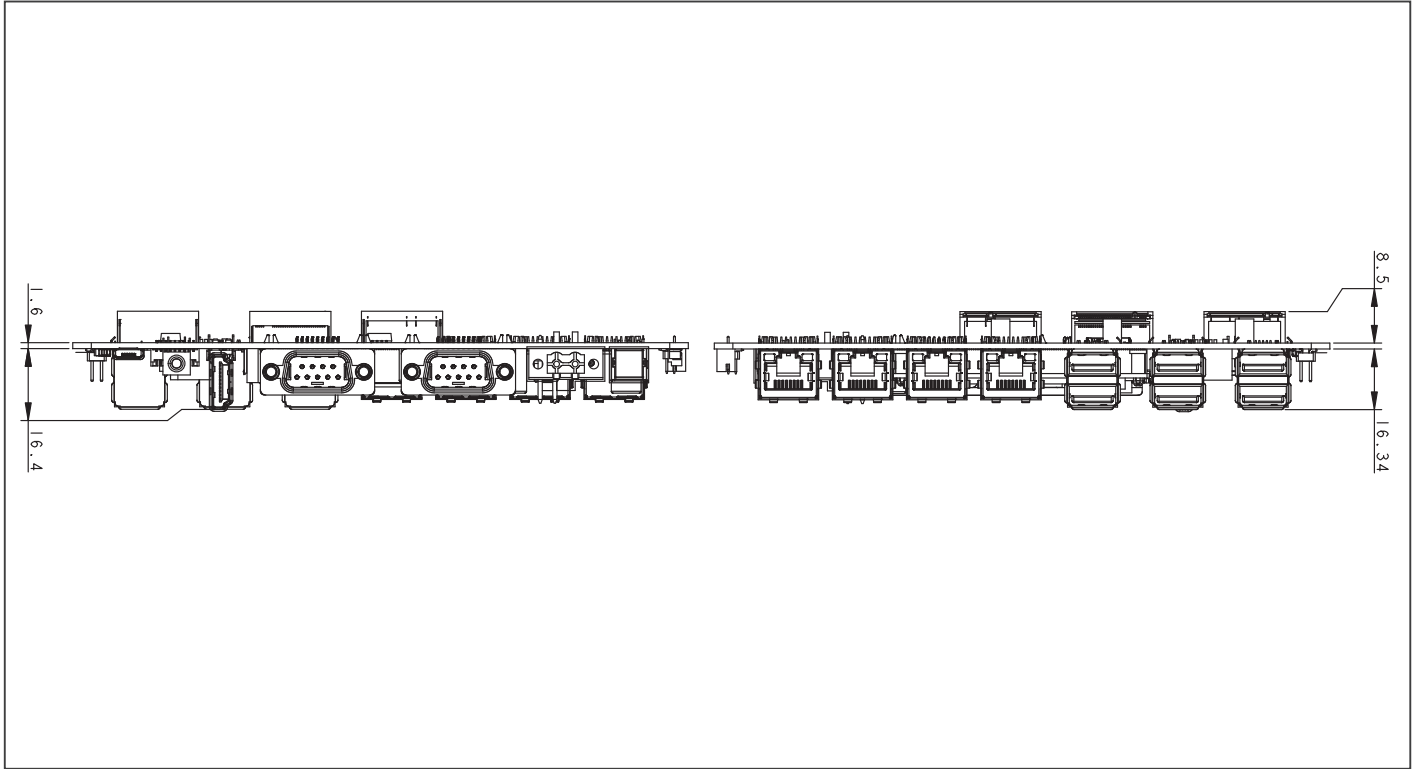

Ordering Information

Part Number	AI Solution	LAN	USB 3.2 Gen 2	COM	CANBus	Storage	Display	Expansion	Power
BOXER-8654AI-KIT-JP600N-A1-1010	NVIDIA® Jetson Orin™ NX 8GB	4	6	1	1	M.2 M Key 2280 NVME x 1 (Default: 128GB)	HDMI x 1	M.2 2230 E-Key x 1 M.2 2242/3042/3052 B-Key x 1 (SIM onboard) M.2 2280 M-Key x 1	DC 12-24V
BOXER-8654AI-KIT-JP600N-A2-1010	NVIDIA® Jetson Orin™ NX 16GB	4	6	1	1	M.2 M Key 2280 NVME x 1 (Default: 128GB)	HDMI x 1	M.2 2230 E-Key x 1 M.2 2242/3042/3052 B-Key x 1 (SIM onboard) M.2 2280 M-Key x 1	DC 12-24V

Packing List

- BOXER-8654AI-KIT x 1
- Power Connector x 1
- Screw Package x 1

Optional Accessories

- 1255X00066
120W Power Adapter
- 170X000799
Power Cord (US type)
- 170X000800
Power Cord (European Type)
- 170X000803
Power Cord (Japanese Type)
- 9641865400
Cooler Fan Kit
- 9641865401
Heat Spreader Kit
- 9641865402
Top Heat Sink with Heat Spreader Kit

BOXER-8654AI-KIT-PLUS

PRELIMINARY

AI@Edge Compact Fanless Embedded board with NVIDIA® Jetson Orin™ NX

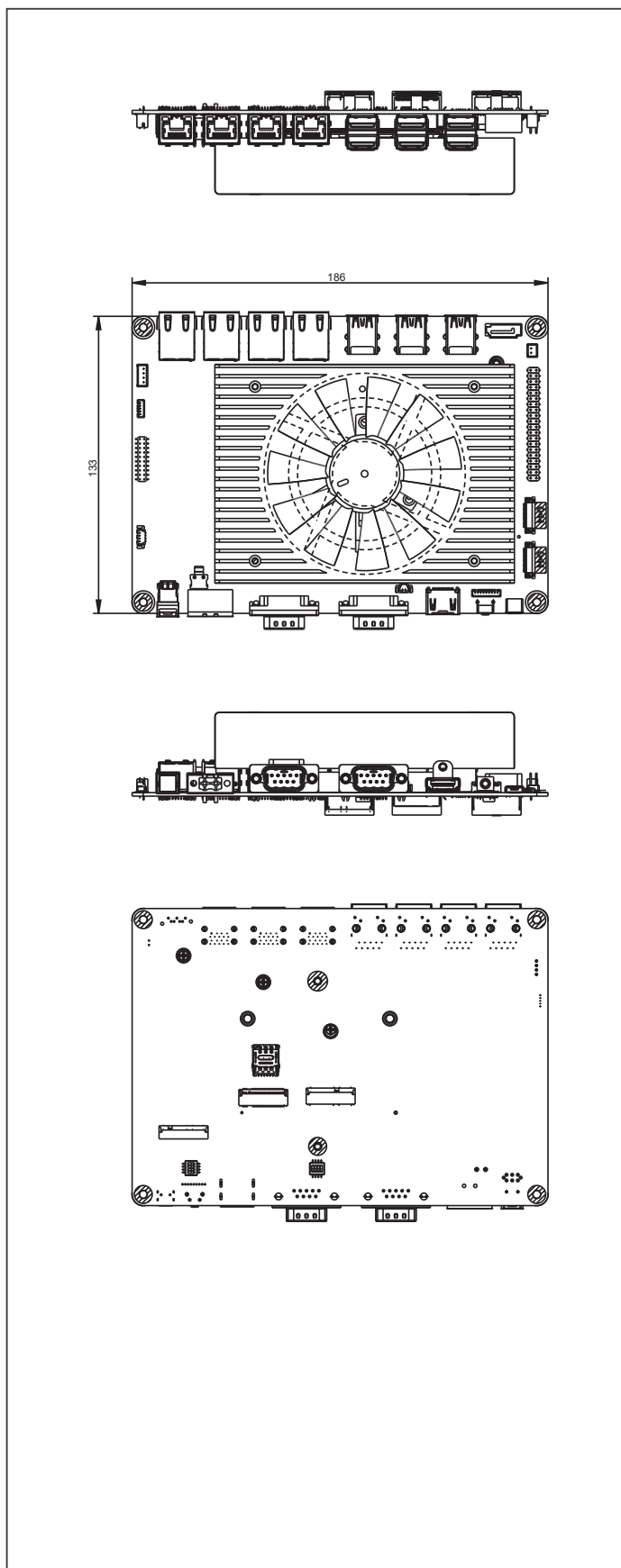

Features

- NVIDIA® Jetson Orin™ NX
- Supports NVIDIA® JetPack 6.2 Super mode
- MIPI Connector x 2
- M.2 2230 E-Key x 1, M.2 2280 M-Key x 1, M.2 3052 B-Key x 1
- 40-pin Header compliant with NVIDIA Jetson Orin Nano Developer Kit
- PoE Connector, FAN Connector
- 12V ~ 24V Wide Power DC Input
- TPM 2.0 Support (by Jumper select)



Specifications

System	
AI Accelerator	NVIDIA® Jetson Orin™ NX
CPU	Orin NX 16GB: 8-core Arm® Cortex®-A78AE ARMv8.2 64-bit CPU Orin NX 8GB: 6-core Arm® Cortex®-A78AE ARMv8.2 64-bit CPU
System Memory	8GB/16GB LPDDR5
Storage Device	M.2 M-Key 2280 x 1 (NVMe)
Display Interface	HDMI Type A for HDMI 1.4 x 1
Ethernet	RJ-45 x 4 for GbE LAN (optional: power module for PoE (25.6W each port))
I/O	"MIPI Connector x 2 (4 lanes for each MIPI connector, Default IMX219) DB-9 x 1 for RS-232(RX/TX/GND)/422/485 DB-9 x 1 for CANBus USB Type A x 6 for USB 3.2 Gen 2 Micro USB for image flash x 1 Power Button with LED Indicator x 1 2-pin Phoenix Type x 1 for Power Input Recovery Button x 1 40-pin Header compliant with NVIDIA Jetson Orin Nano Developer Kit Pin Header x 1 for RS/232/422/485 by jump select UART to 40-pin Box Header x 1 for OOB SATA Connector x 1 SATA power Connector x 1"
Expansion	M.2 2230 E-Key x 1 M.2 2242/3042/3052 B-Key x 1 (SIM onboard) M.2 2280 M-Key x 1
Indicator	Power LED x 1
OS Support	Linux (NVIDIA Jetpack 6.x and above)
Power Supply	
Power Requirement	DC-in 12-24V with 2-pin terminal block
Mechanical	
Mounting	—
Dimensions (W x D x H)	6.53" x 5.24" (166mm x 133mm)
Gross Weight	TBD
Net Weight	TBD
Environmental	
Operating Temperature	-25°C ~ 70°C, according to IEC60068-2 with 0.7 m/s Airflow
Storage Temperature	-40°C ~ 85°C, non operation
Storage Humidity	5%~ 95% @ 40°C, non-condensing
Anti-Vibration	—
Anti-Shock	—
Certification	CE/FCC class A





BOXER-8654AI-KIT-PLUS

Dimension

Unit: mm

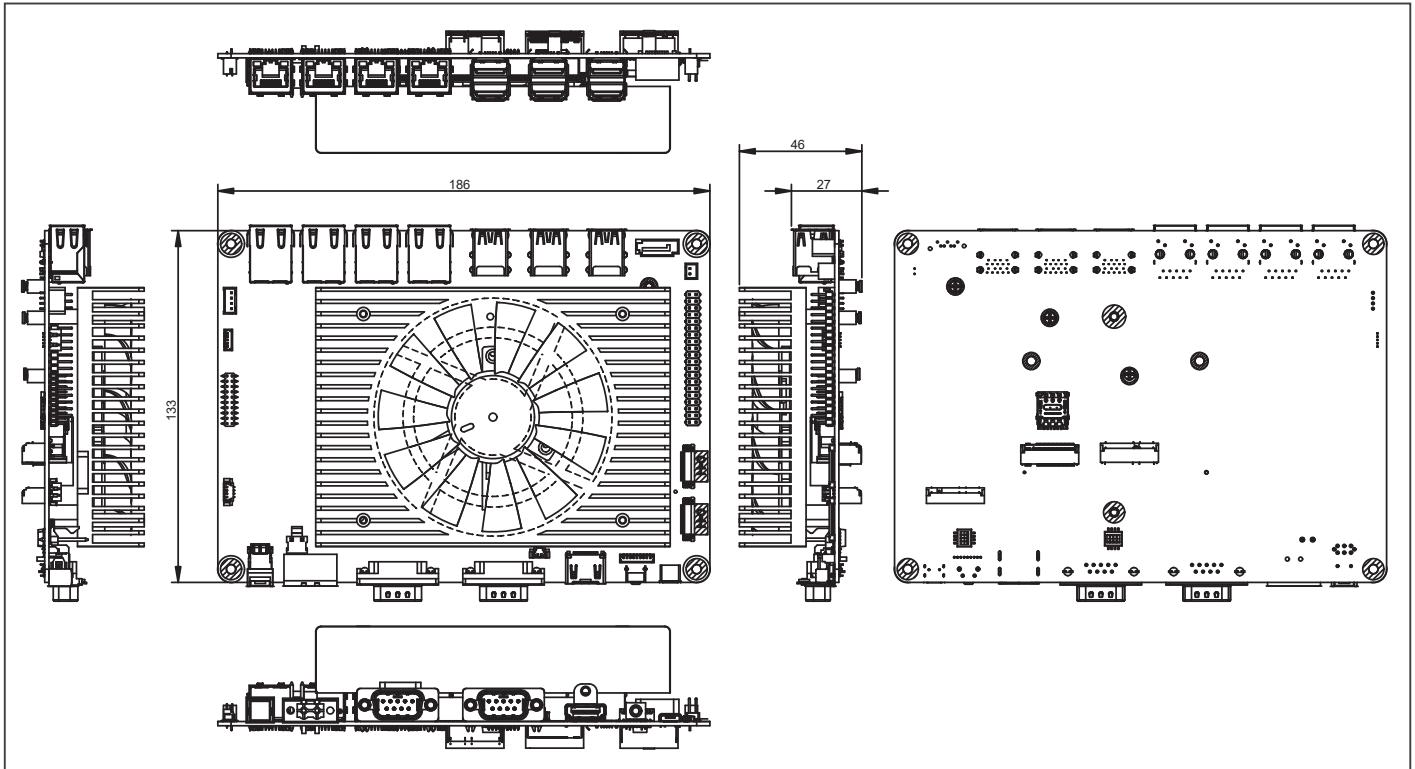

Ordering Information

- TBD

Packing List

- BOXER-8652AI-KIT-PLUS x 1
- Power Connector x 1
- Screw Package x 1

Optional Accessories

- 1255X00066
120W Power Adapter
- 170X000799
Power Cord (US type)
- 170X000800
Power Cord (European Type)
- 170X000803
Power Cord (Japanese Type)
- 9641865400
Cooler Fan Kit
- 9641865401
Heat Spreader Kit
- 9641865402
Top Heat Sink with Heat Spreader Kit

BOXER-8655AI

AI@Edge Fanless Embedded AI System with NVIDIA® Jetson Orin NX

Front View

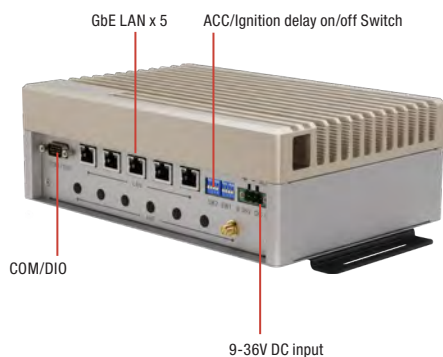

Rear View

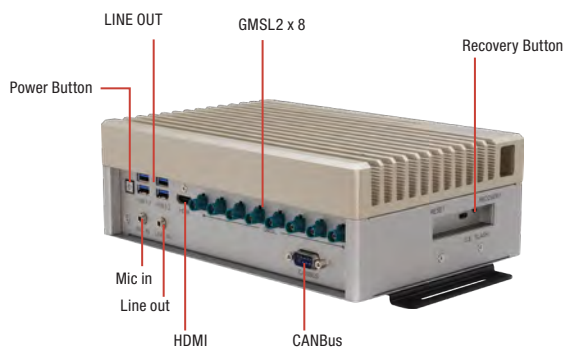

Features

- NVIDIA® Jetson Orin NX
- GMSL2 with FAKRA Connectors x 8
- Giga LAN x 5
- TPM, 9-Axis sensor and GPS
- 9V ~ 36V DC in with ACC Ignition Delay On/Off
- Military Standard Vibration and Shock
- E-Mark Certified

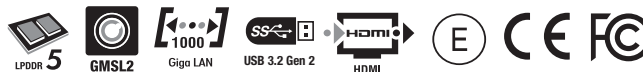

Specifications

System	
AI Accelerator	NVIDIA® Jetson Orin™ NX
CPU	Orin NX 8GB : 6-core Arm® Cortex®-A78AE v8.2 64-bit CPU 1.5MB L2 + 4MB L3 Orin NX 16GB : 8-core Arm® Cortex®-A78AE v8.2 64-bit CPU 2MB L2 + 4MB L3
System Memory	Orin NX 8GB : 8GB LPDDR5 Orin NX 16GB : 16GB LPDDR5
Storage Device	M.2 2280 M-Key x 1 (NVMe) 2.5" SATA Driver Bay x 1
Display Interface	HDMI 1.2 x 1
Ethernet	RJ-45 for GbE LAN x 5
I/O	GMSL2 x 8 with Fakra connectors DB-9 x 1 for CANBus FD DB-15 for RS232 (Rx/Tx)/RS422/RS485 x 1, programmable DIO x 8 External SMA antenna x 7 Power button x 1 Recovery button x 1 Micro USB x 1 for OS Flash Mic in and Line out x1 Reset button x1 USB Type A for USB 3.2 Gen 2 x 4
Expansion	M.2 2230 E-Key x 1 (Wifi/BT) M.2 3042/3052 B-Key x 1 (LTE/5G) (USB 2.0,USB3.0) M.2 2280 M-Key x 1 (NVMe) 2.5" SATA x 1
Indicator	Power LED
OS Support	Linux (NVIDIA JetPack™ 6.x and up)
Power Supply	
Power Requirement	3-pin Terminal Block x 1 for 9V~36V ACC Ignition Delay On/Off
Mechanical	
Mounting	Wallmount
Dimensions (W x D x H)	9.68 " x 6.46 " x 3.49" (246.0 mm x 164 .2 mm x 88.8 mm)
Gross Weight	7.9 lbs (3.6Kg)
Net Weight	6.2 lbs (2.8Kg)
Environmental	
Operating Temperature	5°F ~ 158°F (-15°C ~ 70°C with 0.7 m/s airflow)
Storage Temperature	-40°F ~ 185°F (-40°C ~ 85°C)
Storage Humidity	5 ~ 95% @ 40°C, non-condensing
Anti-Vibration	MIL-STD-810G, 514.6C Procedure 1, Category 4 Trucker/Semitrailer on US highway (Figure 514.6C-1-Category 4-Common carrier)
Anti-Shock	MIL-STD-810G, Method 516.6, Procedure I, flight vehicle equipment
Certification	E-Mark, CE/FCC Class A





Dimension

Unit: mm

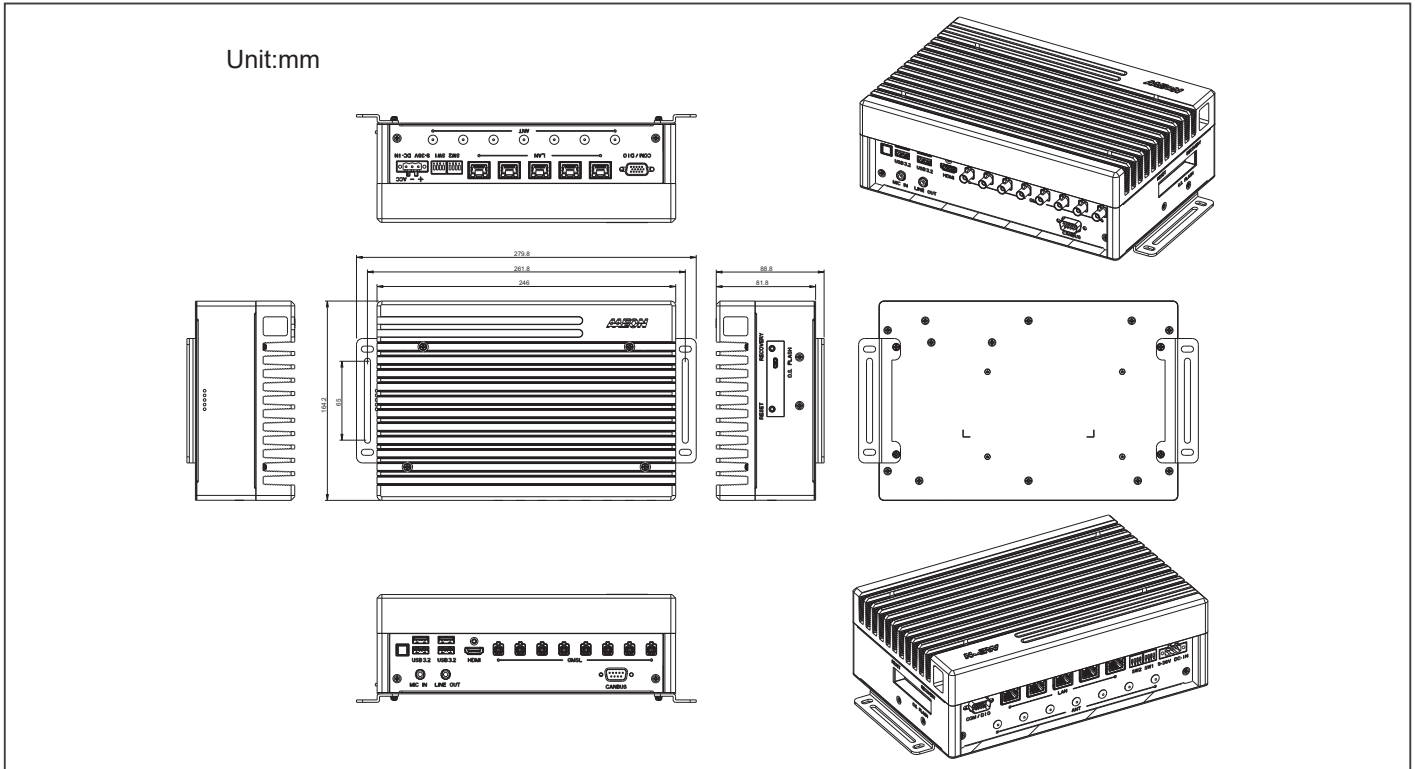

Ordering Information

Part Number	AI Solution	LAN	GMSL2	USB 3.2 Gen 2	DIO	COM	CANBus FD	Display	Storage	Mounting	Power	Operation System
BOXER-8655AI-JP600N-A1-1010	NVIDIA® Jetson Orin NX™ 8GB	5	8	4	8	1	1	HDMI x 1	M.2 2280 M-Key x 1 (Default: 128GB) 2.5" SATA Drive Bay x 1	Wallmount	9-36V	Linux (NVIDIA Jetpack™ 6.0)
BOXER-8655AI-JP600N-A2-1010	NVIDIA® Jetson Orin NX™ 16GB	5	8	4	8	1	1	HDMI x 1	M.2 2280 M-Key x 1 (Default: 128GB) 2.5" SATA Drive Bay x 1	Wallmount	9-36V	Linux (NVIDIA Jetpack™ 6.0)

Packing List

- BOXER-8655AI X 1
- Wallmount Bracket x 2
- Power connector x 1
- Screw Package x 1

Optional Accessories

- 1255302300
230W Power Adapter
- 170X000799
Power Cord (US type)
- 170X000800
Power Cord (European Type)
- 170X000803
Power Cord (Japanese Type)

BOXER-8658AI

AI@Edge Fanless PoE Embedded AI System with NVIDIA® Jetson Orin™ NX

Front View

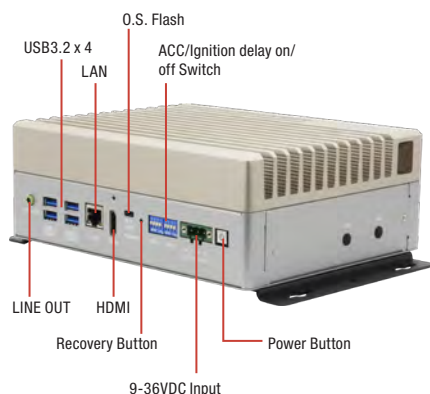

Rear View

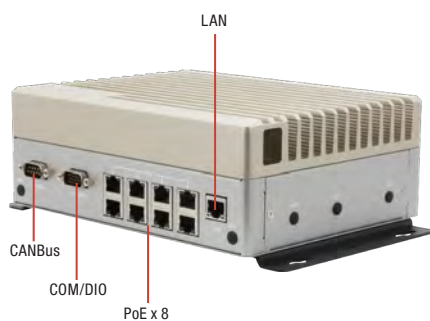

Features

- NVIDIA® Jetson Orin™ NX
- PoE/PSE GbE LAN x 8
- Giga LAN x 2
- 9V ~ 36V DC in with ACC Ignition Delay On/Off
- Military Standard Vibration and Shock
- IMU, TPM, GNSS



Specifications

System	
AI Accelerator	NVIDIA® Jetson Orin™ NX
CPU	Orin NX 8GB: 6-core Arm® Cortex®-A78AE v8.2 64-bit CPU Orin NX 16GB: 8-core Arm® Cortex®-A78AE v8.2 64-bit CPU
System Memory	8GB LPDDR5 16GB LPDDR5
Storage Device	2.5" SATA Driver Bay x 1 M.2 2280 NVMe M Key x 1
Display Interface	HDMI 2.0 type A x 1
Ethernet	RJ-45 x 2 for Giga LAN RJ-45 x 8 for GbE PoE/PSE (802.3af/at, MAX.:120W) *4 PoE ports sharing one MAC address and one Giga bandwidth. Supports total 120W PoE when input voltage is at or over 24V. Supports total 80W PoE when input voltage is between 12-24V. Supports total 30W PoE when input voltage is below 12V.
I/O	USB 3.2 Gen 2 type A x 4 DB-9 x 1 for CANBus FD x 1 DB-15 x 1 for RS232/422/485 x 1 and DIO x 8 Line out x 1 Micro USB x 1 for OS Flash Power button x 1 Recovery button x 1 Switch x 2 for ACC Ignition Delay On/Off Antenna x 7 TPM Support GNSS Support 9-Axis Sensor Support
Expansion	M.2 2230 E Key x 1 (Wifi/BT) M.2 3052 B Key x 1 (LTE) M.2 2280 NVMe M Key x 1 2.5" SATA x 1 SIM Slot x 2
Indicator	Power LED x 1
OS Support	Linux (NVIDIA JetPack™ 6.0 and above)
Power Supply	
Power Requirement	3-pin Terminal Block x 1 for 9V ~ 36V ACC Ignition Delay On/Off
Mechanical	
Mounting	Wallmount
Dimensions (W x D x H)	8.27" x 6.46" x 2.99" (210 x 164.2 x 76 mm) (Without Bracket) 9.69" x 6.46" x 3.27" (246 x 164.2 x 83 mm) (With Bracket)
Gross Weight	8.6 lbs (3.9kg)
Net Weight	6.7 lbs (3kg)
Environmental	
Operating Temperature	5°F ~ 140°F (-15°C ~ 60°C with 0.7 m/s airflow, with Industrial wide Temp. SSD)
Storage Temperature	-40°F ~ 185°F (-40°C ~ 85°C)
Storage Humidity	5 ~ 95% @ 40°C, non-condensing
Anti-Vibration	MIL-STD-810G, 514.6C Procedure 1, Category 4 Trucker/Semitrailer on US highway (Figure 514.6C-1-Category 4-Common carrier)
Anti-Shock	MIL-STD-810G, Method 516.6, Procedure I, flight vehicle equipment
Certification	CE / FCC class A, E-Mark Compliance





Dimension

Unit: mm

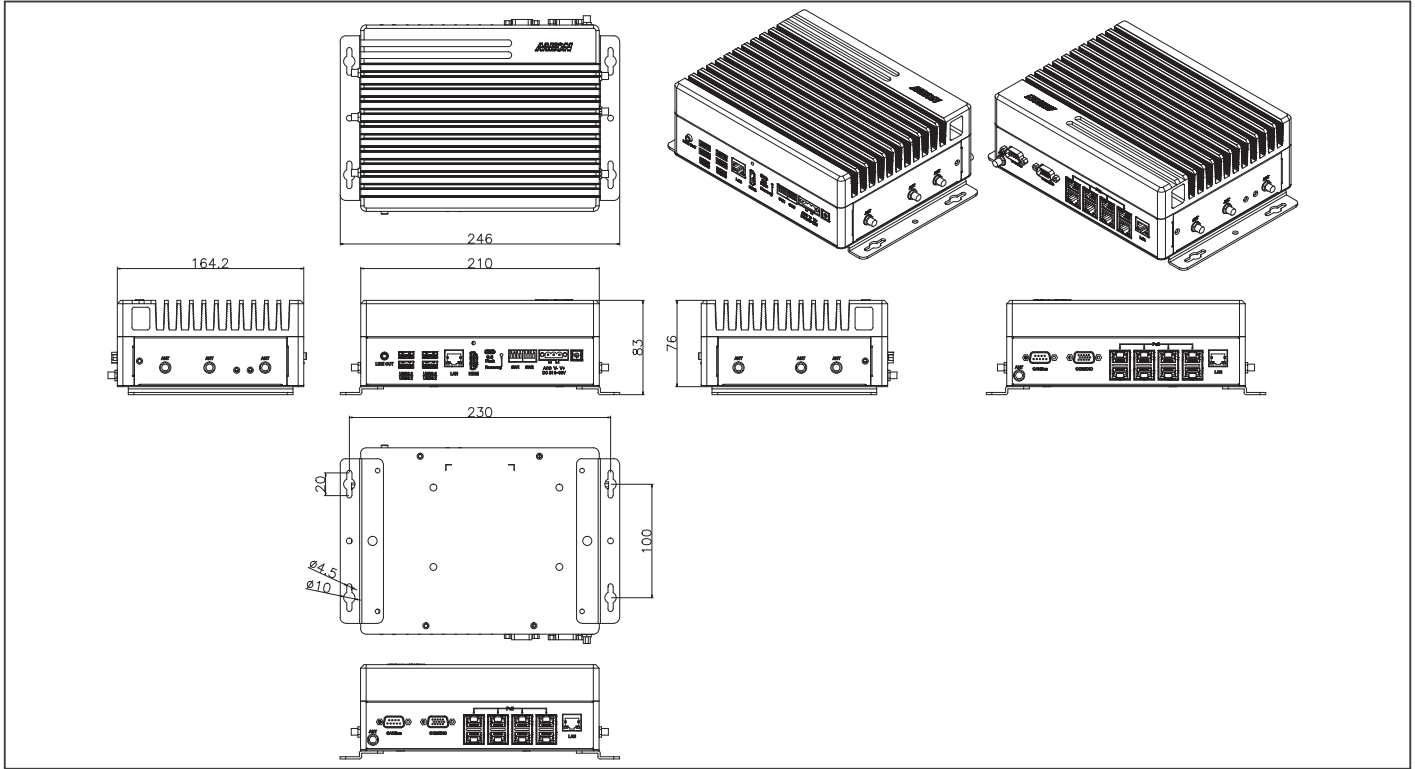

Ordering Information

Part Number	AI Solution	LAN	POE	USB 3.2 Gen 2	COM	CANBUS	DIO	Storage	Display	Expansion	Mounting	Power	Operation System
BOXER-8658AI-JP600N-A1-1010	NVIDIA® Jetson Orin NX™ 8GB	2	8	4	1	1	8 bits	M.2 2280 M-Key x 1 (Default: 128GB) 2.5" SATA Drive Bay x 1	HDMI x 1	M.2 2230 E Key x 1 (Wifi/BT) M.2 3052 B Key x 1 (LTE) M.2 2280 NVMe M Key x 1 Build in GNSS & 9 axis sensors & TPM	Wallmount	9 ~ 36VDC w/ 3 pin terminal block and Ignition delay on/off	NVIDIA Jetpack™ 6.0
BOXER-8658AI-JP600N-A2-1010	NVIDIA® Jetson Orin NX™ 16GB	2	8	4	1	1	8 bits	M.2 2280 M-Key x 1 (Default: 128GB) 2.5" SATA Drive Bay x 1	HDMI x 1	M.2 2230 E Key x 1 (Wifi/BT) M.2 3052 B Key x 1 (LTE) M.2 2280 NVMe M Key x 1 Build in GNSS & 9 axis sensors & TPM	Wallmount	9 ~ 36VDC w/ 3 pin terminal block and Ignition delay on/off	NVIDIA Jetpack™ 6.0

Packing List

- BOXER-8658AI x 1
- Wallmount Bracket x 2
- Power connector x 1
- Screw Package x 1

Optional Accessories

- 1255302300
230W Power Adapter
- 170X000799
Power Cord (US type)
- 170X000800
Power Cord (European Type)
- 170X000803
Power Cord (Japanese Type)

BOXER-8658AI-PLUS PRELIMINARY

AI@Edge Fanless PoE Embedded AI System with NVIDIA® Jetson Orin™ NX



Front View

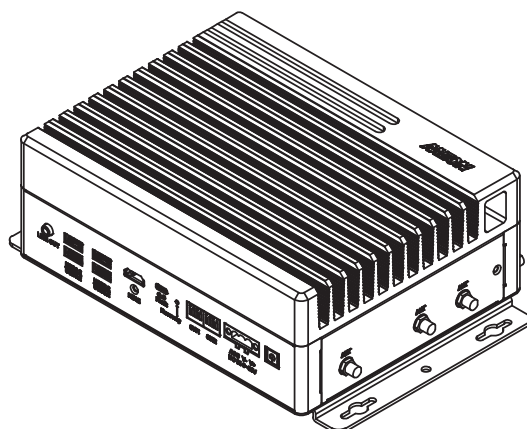

Rear View

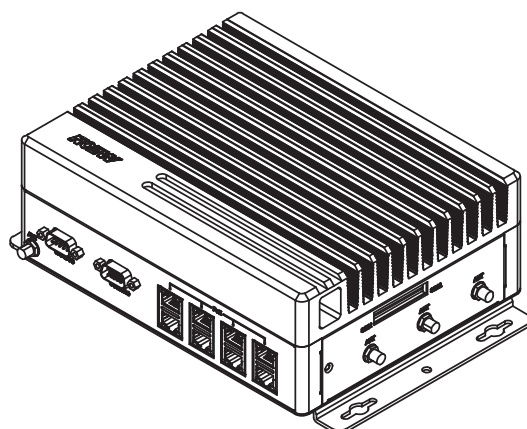

Features

- NVIDIA® Jetson Orin™ NX
- Supports NVIDIA® JetPack 6.2 Super mode
- PoE/PSE GbE LAN x 8
- GbE LAN x 2
- 9V ~ 36V DC in with ACC Ignition Delay On/Off
- Military Standard Vibration and Shock
- IMU, TPM, GNSS



Specifications

System	
AI Accelerator	NVIDIA® Jetson Orin™ NX
CPU	Orin NX 16GB: 8-core Arm® Cortex®-A78AE ARMv8.2 64-bit CPU Orin NX 8GB: 6-core Arm® Cortex®-A78AE ARMv8.2 64-bit CPU
System Memory	8GB/16GB LPDDR5
Storage Device	2.5" SATA Driver Bay x 1 M.2 2280 NVMe M Key x 1
Display Interface	HDMI 2.0 type A x 1
Ethernet	RJ-45 x 2 for GbE LAN RJ-45 x 8 for GbE PoE/PSE (802.3af/at, Max: 120W) *4 PoE ports share one MAC address and one Gigabit uplink (bandwidth) Supports total 120W PoE power with ≥ 24 VDC input voltage. Supports total 80W PoE power with 12-24 VDC input voltage. Supports total 30W PoE power with < 12 VDC input voltage.
I/O	USB 3.2 Gen 2 type A x 4 DB-9 x 1 for CANBus FD x 1 DB-15 x 1 for RS232/422/485 x 1 DIO x 8 Line Out x 1 Micro USB x 1 for OS Flash Power Button x 1 Recovery button x 1 Switch x 2 for ACC Ignition Delay On/Off Antenna x 7 TPM Support GNSS Support 22 pins for OOB module
Expansion	M.2 2230 E Key x 1 (Wifi/BT) M.2 3052 B Key x 1 (LTE) M.2 2280 NVMe M Key x 1 2.5" SATA x 1 SIM Slot x 2
Indicator	Power LED x 1
OS Support	Linux (NVIDIA Jetpack 6.x and above)
Power Supply	
Power Requirement	3-pin Terminal Block x 1 for 9V ~ 36V ACC Ignition Delay On/Off
Mechanical	
Mounting	Wallmount
Dimensions (W x D x H)	8.27" x 6.46" x 2.99" (210 x 164.2 x 76 mm) (Without Bracket) 9.69" x 6.46" x 3.27" (246 x 164.2 x 83 mm) (With Bracket)
Gross Weight	TBD
Net Weight	TBD
Environmental	
Operating Temperature	-13°F ~ 140°F (-25°C ~ 60°C with 0.7 m/s airflow, with Industrial wide Temp. SSD)
Storage Temperature	-40°F ~ 185°F (-40°C ~ 85°C)
Storage Humidity	5%~ 95% @ 40°C, non-condensing
Anti-Vibration	MIL-STD-810H, 514.8C Procedure 6, Category 4 (by 2.5" SATA SSD)
Anti-Shock	MIL-STD-810H, 516.8 Procedure I, Functional Shock – Sawtooth 40G 11ms (by 2.5" SATA SSD)
Certification	CE/FCC class A





BOXER-8658AI-PLUS

Dimension

Unit: mm

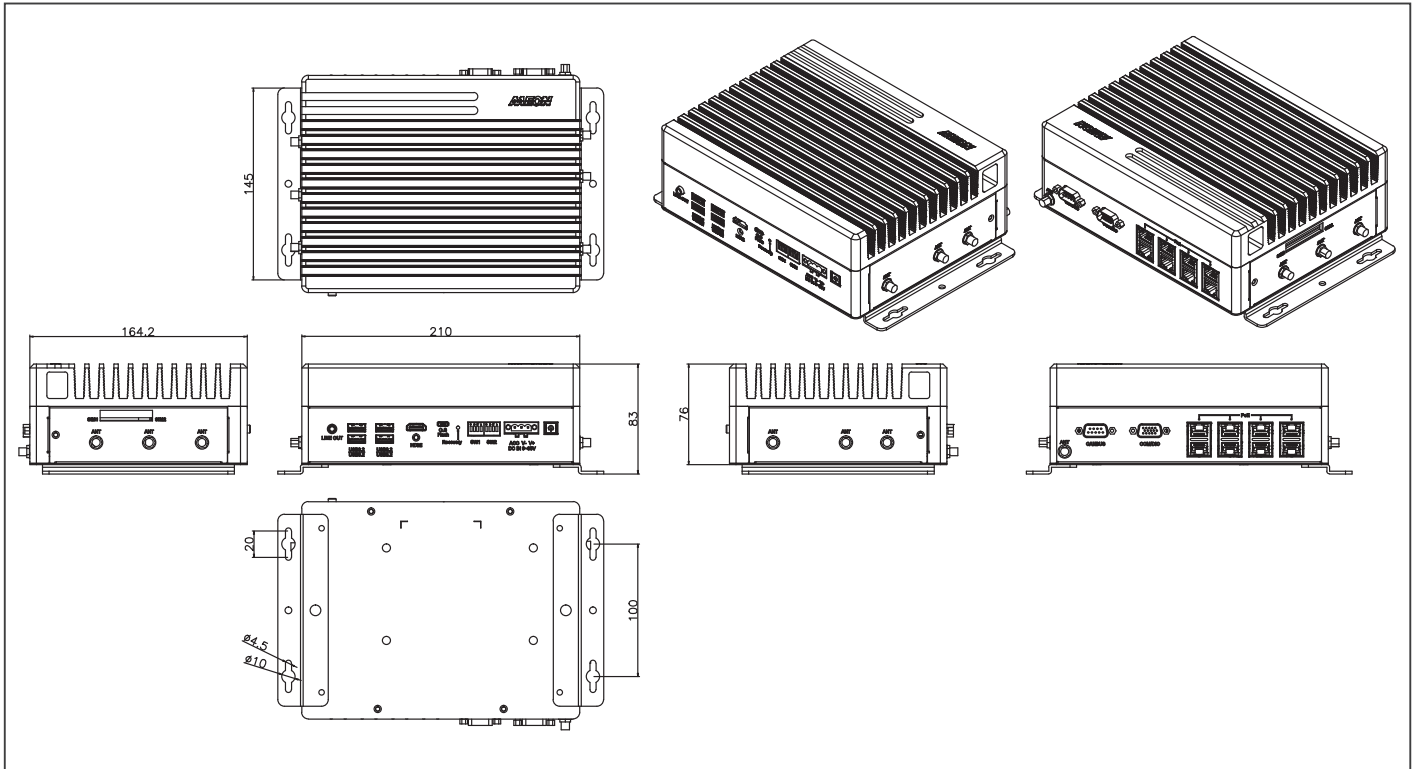

Ordering Information

- TBD

Optional Accessories

- **1255302300**
230W Power Adapter
- **170X000799**
Power Cord (US type)
- **170X000800**
Power Cord (European Type)
- **170X000803**
Power Cord (Japanese Type)

Packing List

- BOXER-8658AI x 1
- Wallmount Bracket x 2
- Power connector x 1
- Screw Package x 1

BOXER-8741AI PRELIMINARY

AI@Edge Board with NVIDIA® Jetson T5000™



Front View



Rear View

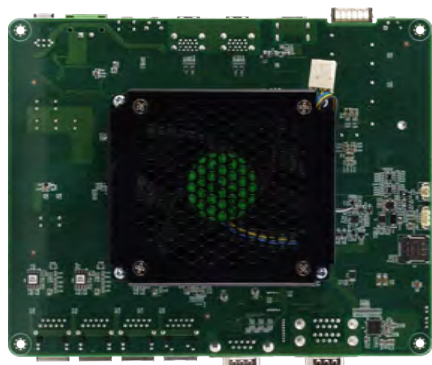

Features

- NVIDIA® Jetson T5000™ AI Edge System
- 14-core Arm® Neoverse®-V3AE 64-bit CPU, 128GB LPDDR5x onboard memory
- QSFP28 x 1, 4 x 25GbE for high-speed sensor integration
- 5GbE x 1 and 1GbE x 3 (supports LiDAR)
- Dual CAN FD and RS-232/RS-485 for LiDAR control
- GPIO, I²C, SPI for peripheral expansion
- Supports NVIDIA JetPack 7.0



Specifications

System	
AI Accelerator	NVIDIA® Jetson T5000™
CPU	14-core Arm® Neoverse®-V3AE 64-bit CPU
System Memory	128GB 256-bit LPDDR5X
Storage Device	M.2 2280 M-Key x 1
Display Interface	HDMI 1.4a x 1
Ethernet	QSFP28 x 1 for 4 x 25GbE RJ-45 x 1 for 5GbE RJ-45 x 3 for 1GbE
I/O	DB-9 x 1 for CAN FD x 2 DB-9 x 1 for RS-232 x 1/ RS-485 x 1 USB 3.2 Gen 2 USB (Type-A) x 4 10-pin Terminal Block for 8-bit GPIO Line-in/Line-out x 1 Mini USB x 1 for OS Flash Reset Button x 1 Pin header for RS-232 x 1/RS-485 x 1 Pin header for CAN FD x 2 Pin header for MIPI CSI-2 (4 x 4-lane) I ² C x 4 SPI x 2 UART x 1 12V Fan connector x 1
Expansion	M.2 B key 3052 x 1 for 4G/5G LTE M.2 E key 2230 x 1 for WiFi 5/6/BT M.2 M key 2280 x 1 for NVMe
Indicator	System LED x 1 onboard
OS Support	NVIDIA Jetpack™ 7.0
Power Supply	
Power Requirement	2-pin Terminal Block x 1 for 12~24Vdc Power Input (pitch 5mm)
Mechanical	
Mounting	Wallmount
Dimensions (W x D x H)	6.33" x 7.87" (161mm x 200mm)
Gross Weight	TBD
Net Weight	TBD
Environmental	
Operating Temperature	-4°F ~ 140°F (-20°C ~ 60°C) according to IEC68-2-14 with 0.7 m/s AirFlow
Storage Temperature	-4°F ~ 158°F (-20°C ~ 70°C)
Storage Humidity	5 ~ 95% @ 40C, non-condensing
Anti-Vibration	MIL-STD-810H
Anti-Shock	MIL-STD-810H
Certification	FCC/CE Class A





Dimension

Unit: mm

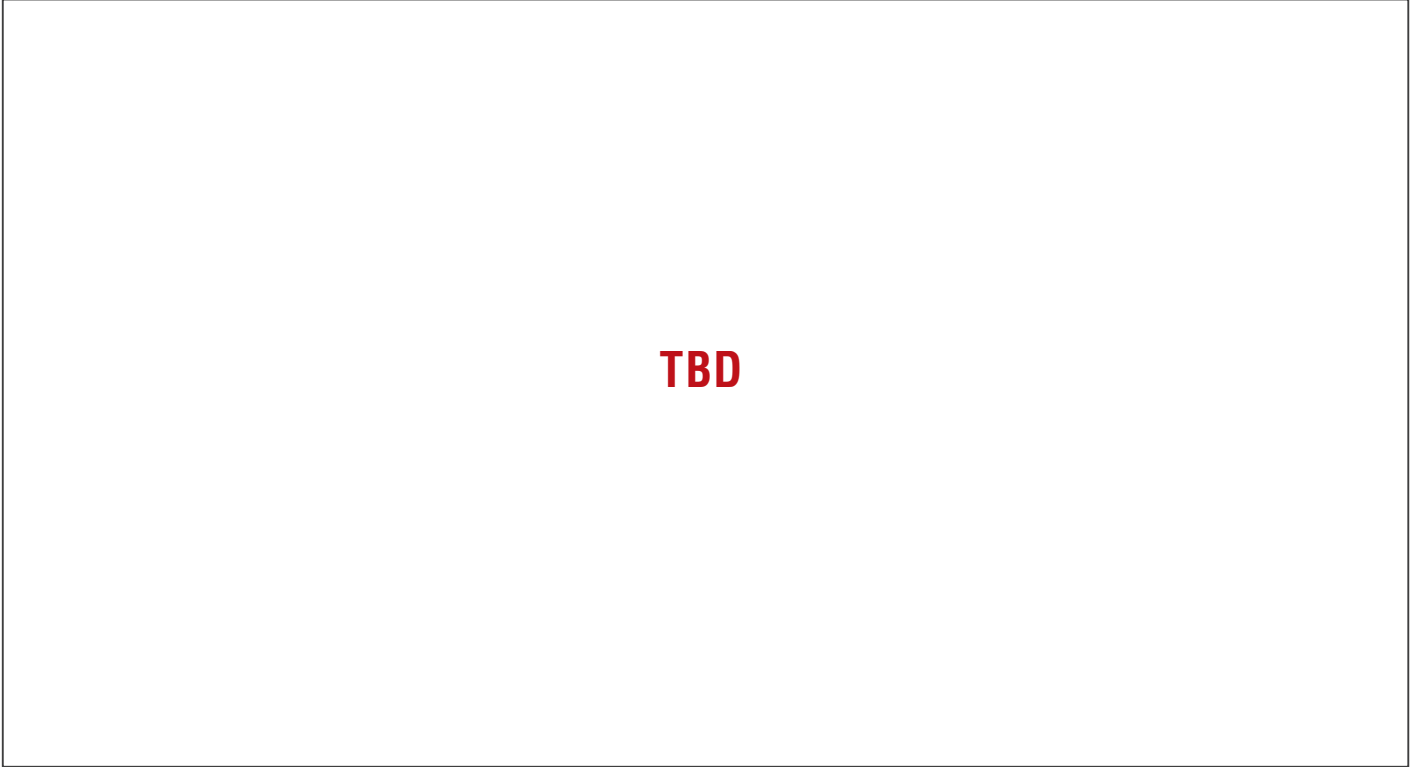

TBD

Ordering Information

- TBD

Optional Accessories

- TBD

Packing List

- TBD

BOXER-8742AI PRELIMINARY

AI@Edge Fanless Embedded Box PC with NVIDIA® Jetson Thor™



Front View

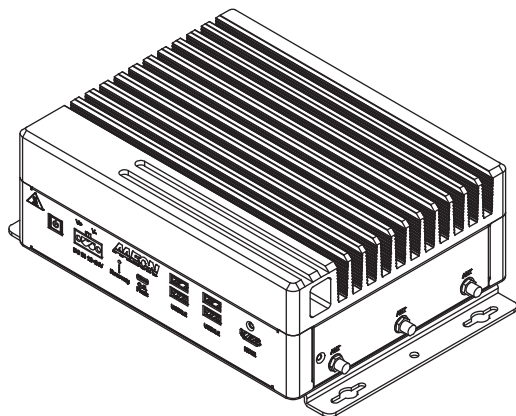

Rear View

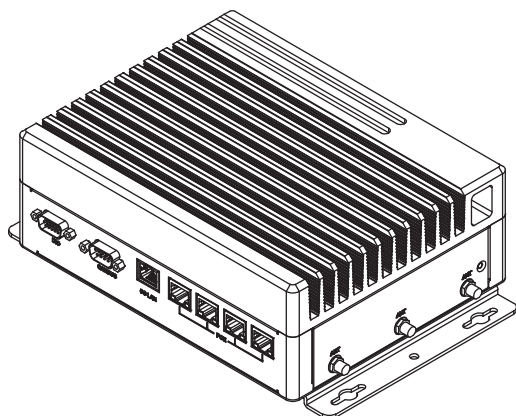

Features

- NVIDIA® Jetson T4000™
- 5GbE LAN x 1
- 1GbE LAN x 4 with PoE/PSE 802.3af (Max. 60W)
- RS-232/422/485, CAN FD, DIO/GPIO
- M.2 expansion for 5G, Wi-Fi, and NVMe SSD
- -25°C - 60°C Operating Temperature



Specifications

System	
AI Accelerator	NVIDIA® Jetson T4000™
CPU	12-core Arm® Neoverse®-V3AE 64-bit CPU
System Memory	64 GB 256-bit LPDDR5X
Storage Device	M.2 2280 M-Key x 1 for NVMe
Display Interface	HDMI 2.0 x 1
Ethernet	RJ-45 x 1 for 5GbE LAN RJ-45 x 4 for 1GbE LAN with PoE 802.3af/at, Max: 60W
I/O	USB 3.2 Gen 2 (Type-A) x 4 DB-15 x 1 for RS-232/422/485 & DIO x 8 DB-9 x 1 for RS-232 & CAN FD x 2 Mini USB x 1 for OS Flash Recovery Button x 1 Reset Button x 1 Power Button x 1 External SMA Antenna x 6 SIM Slot x 2
Expansion	M.2 2280 M-Key x 1 for NVMe M.2 3042/3052 B-Key x 1 for 4G/5G (USB 3.0 + PCIe) M.2 2230 E-Key x 1 for WiFi/BT/NVMe
Indicator	Power LED x 1
OS Support	NVIDIA Jetpack™ 7.0 and up
Power Supply	
Power Requirement	2-pin 12V-24V DC Input Phoenix Connector
Mechanical	
Mounting	TBD
Dimensions (W x D x H)	8.26" x 6.46" x 2.91" (210mm x 164.2mm x 74mm)
Gross Weight	TBD
Net Weight	TBD
Environmental	
Operating Temperature	13°F - 140°F (-25°C ~ 60°C), according to IEC60068-2 with 0.7 m/s Airflow
Storage Temperature	-40°F - 185°F (-40°C ~ 85°C), non operation
Storage Humidity	5%~ 95% @ 40°C, non-condensing
Anti-Vibration	3.5G / 5~500Hz / operating
Anti-Shock	50G peak acceleration (11 msec.)
Certification	CE/FCC class A





Dimension

Unit: mm

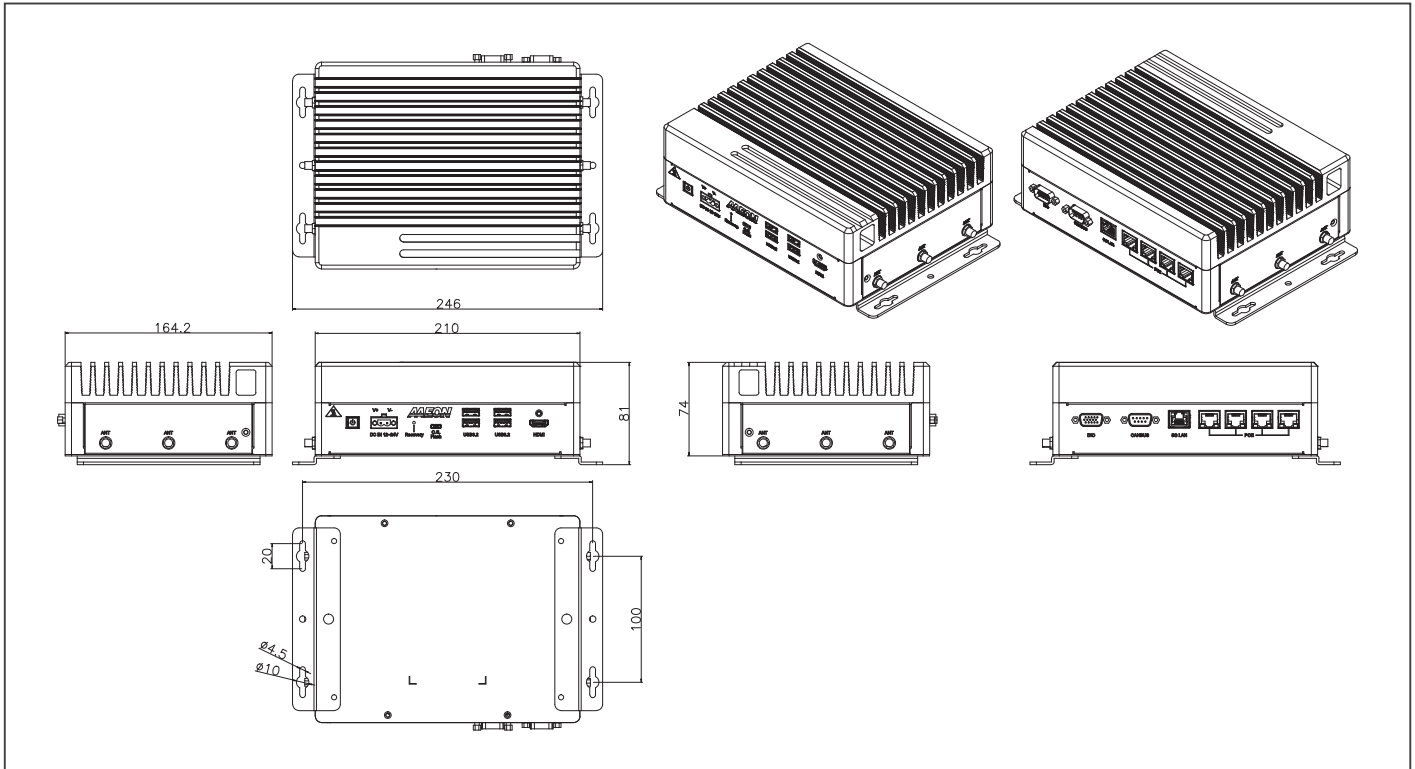

Ordering Information

- TBD

Optional Accessories

- TBD

Packing List

- TBD

MAXER-2100

AI Inference Server, 2U Rackmount, 12/13th Gen CPU, RTX-4080 Super

Front View

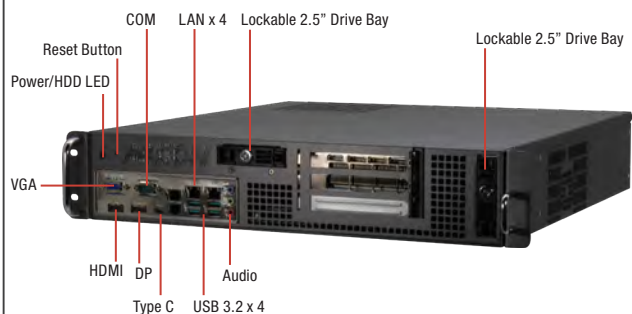

Rear View



Features

- High-performance for AI inference
- 12/13th Gen Intel® Core™ LGA1700 Socket Processors
- High CPU computing performance: Build in i9-13900, up to i9-13900K supported
- 2U Rack Mount, Front Access I/O Design
- M.2 2242/2280 M-Key x 2
- M.2 3042/3052/2242 B-Key + Micro SIM Slot
- M.2 2230 E-Key x 1
- Onboard TPM 2.0



Specifications

System	
CPU	A2: Please select required CPU before shipping A3: Intel® Core™ i9-13900
GPU	A2: PCIe Gen 4 [x16] x 1 for GPU card. A3: NVIDIA RTX™ 6000 Ada
Chipset	Intel Q670
System Memory	DDR5 4000MHz DIMM x 4, Up to 128GB Non-ECC, Un-buffered Memory, Dual-Channel Memory Architecture
Display Interface	HDMI 2.0 x 1, DP 1.4 x 1, VGA x1
Storage Device	2.5" SATA-III Drive Bay x 2 (Swappable, RAID 0/1) M.2 2280 M key for NVMe SSD x 1
Ethernet	RJ-45 GbE LAN x 1 (supports Intel® AMT 12.0) RJ-45 GbE LAN x 1 RJ-45 2.5GbE LAN x 2
USB	USB 3.2 Gen2 x 4 (10Gbps)
Serial Port	DB-9 x 1 for RS-232/422/485
Audio	Audio (Mic-in/Line-out/Line-In)
Expansion	M.2 3042/3052 B-Key x 1 + MicroSIM Slot M.2 2230 E-Key x 1
TPM	TPM 2.0 Onboard
Indicator	System LED x 1, HDD Activity x 1
OS support	Windows® 10 IoT Enterprise 64-bit Windows® 11 PRO 64-bit Ubuntu 22.04.3 and above
Drive Bay	2.5" SATA-III Drive Bay x 2 (Swappable, RAID 0/1)
Front Control	Power On/Off, System Reset
Power Supply	
Power Requirement	Build in 1000W power supply
Mechanical	
Mounting	Rack Mount
Dimensions (W x H x D)	17" x 3.46" x 17.6" (431.8mm x 88mm x 448mm)
Gross Weight	31.52 lb (14.3kg)
Net Weight	24.25 lb (11kg)
Environmental	
Operating Temperature	32°F ~ 104°F (0°C ~ 40°C), according to IEC68-2 with 0.5 m/s AirFlow
Storage Temperature	-40°F ~ 176°F (-40°C ~ 80°C)
Storage Humidity	5 ~ 95% @ 40°C, non-condensing
Certification	CE/FCC class A





Dimension

Unit: mm

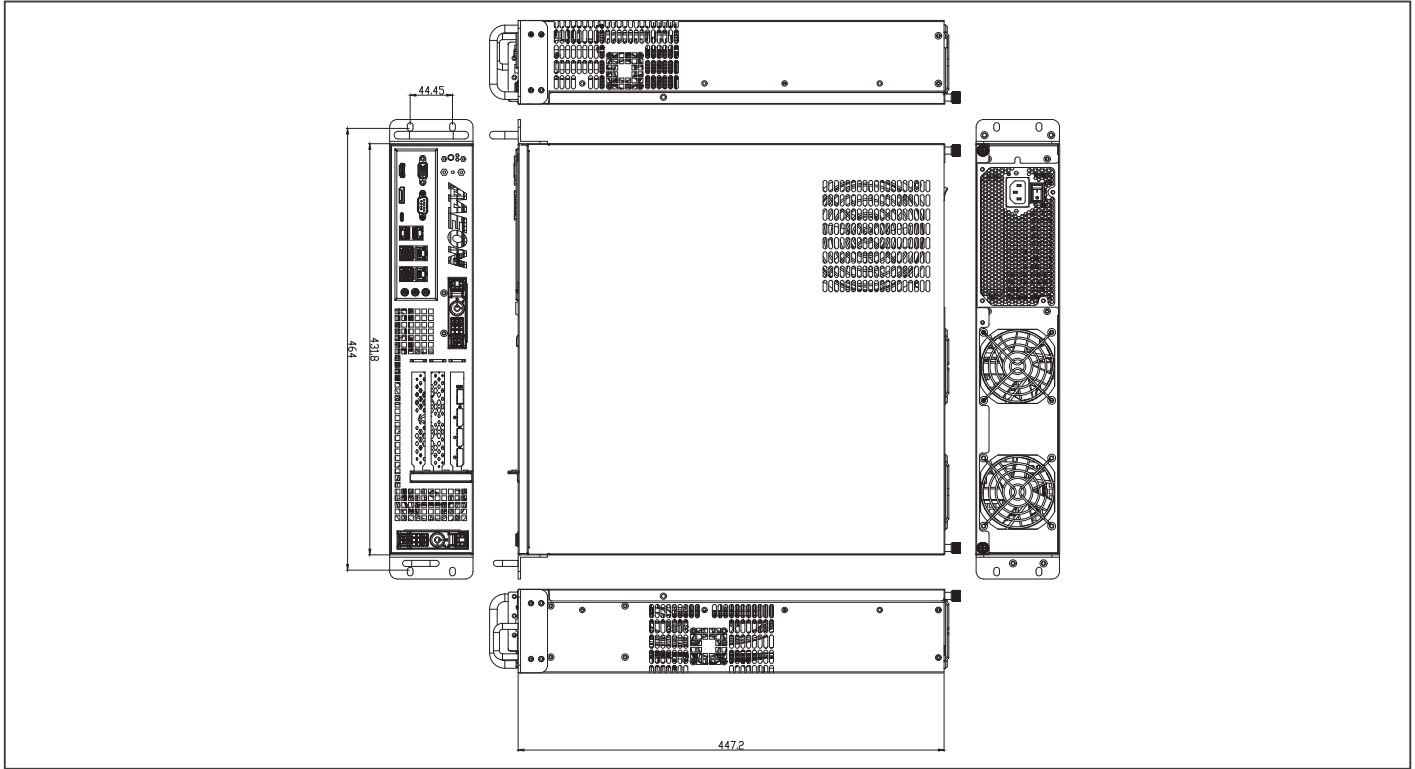

Ordering Information

Part Number	PCH	CPU	GPU	LAN	USB 3.2 Gen 2	RS- 232/422/485	Storage	Display	Expansion	Mounting	Power	Operation Temp.
MAXER-2100-Q670-A2-1010	Intel® Q670 Chipset	Please select required CPU before shipping	PCIe Gen 4 [x16] Slot x 1, GPU not included	4	4	1	M.2 2280 M-Key x 1 2.5 SATA Drive Bay x 2	HDMI x 1 DP x 1 VGA x 1	M.2 3042/3052/2242 B-Key x 1 M.2 2230 E-Key x 1	Rack Mount	1000W	32°F ~ 104°F (0°C ~ 40°C), according to IEC68-2 with 0.7 m/s AirFlow
MAXER-2100-Q670-A3-1010	Intel® Q670 Chipset	Intel® Core™ i9-13900	NVIDIA RTX™ 6000 Ada	4	4	1	M.2 2280 M-Key x 1 2.5 SATA Drive Bay x 2	HDMI x 1 DP x 1 VGA x 1	M.2 3042/3052/2242 B-Key x 1 M.2 2230 E-Key x 1	Rack Mount	1000W	32°F ~ 104°F (0°C ~ 40°C), according to IEC68-2 with 0.7 m/s AirFlow

Packing List

- MAXER-2100

Optional Accessories

- **170X000799**
Power Cord (US type)
- **170X000800**
Power Cord (European Type)
- **170X000803**
Power Cord (Japanese Type)
- **9741364A00**
M.2 2230 E Key Enli, QCNFA364A
- **9651520N00**
M.2 3052 B Key 5G Quectel RM520N-GL

MAXER-5100

AI Inference Server, Tower, 12th/13th/14th Gen Intel® Core™ CPU

Front View



Rear View

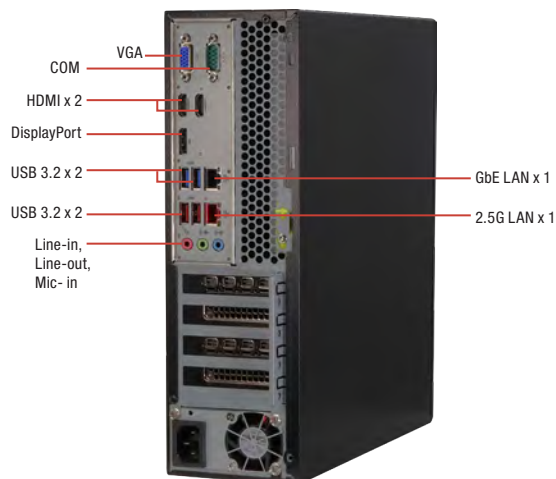

Features

- Supports NVIDIA RTX™ 2000 Ada GPU x 2
- 12/13th/14th Gen Intel® Core™ LGA1700 Socket Processors
- M.2 2242/2280 M-Key x 1
- SATA Drive Bay x 2
- Onboard TPM 2.0



Specifications

System	
CPU	12th/13th/14th Generation Intel® Core™ LGA1700 Socket Processors
GPU	NVIDIA RTX™ 2000 Ada GPU x 2 (Selected SKUs)
Chipset	Intel® Q670 Chipset
System Memory	DDR5 4800MHz U-DIMM x 4, Up to 128GB
Display Interface	VGA x 1 HDMI 2.0 x 2 DP 1.4 x 1
Storage Device	2.5" SSD x 1 3.5" HDD x 1
Ethernet	RJ-45, 1GbE x 1 RJ-45, 2.5GbE x 1
USB	USB 2.0 x 2 USB 3.2 x 6
Serial Port	DB-9 for COM Port (RS-232/422/485 & RI/5V/12V)
Audio	Audio Jack x 5 (Line-in, Mic-in x 2, Line-out x 2)
Expansion	PCIe Gen 4 [x16] x 1 PCIe Gen 4 [x8] x 1 PCIe Gen 3 [x1] x 1 PCIe Gen 3 [x4] x 1 M.2 2230 E-Key x 1 M.2 2280/2242 M-Key x 1 (PCIe Gen 4 [x4], SATA 6Gb/s)
TPM	TPM 2.0 Onboard
Indicator	—
OS support	Windows® 10/11 64bit
Drive Bay	2.5" SATA 6Gb/s Drive Bay x 1 3.5" SATA 6Gb/s Drive Bay x 1
Front Control	—
Power Supply	
Power Requirement	Build in ATX 450W AC/DC Power supply
Mechanical	
Mounting	Wallmount
Dimensions (W x H x D)	12" x 3.7" x 10.9" (305mm x 95mm x 276mm)
Gross Weight	12 lb (5.6kg)
Net Weight	11 lb (5kg)
Environmental	
Operating Temperature	32°F ~ 113°F (0°C ~ 45°C), according to IEC68-2 with 0.5 m/s AirFlow
Storage Temperature	-40°F ~ 185°F (-25°C ~ 85°C)
Storage Humidity	5 ~ 95% @ 40°C, non-condensing
Certification	CE/FCC class A





Dimension

Unit: mm

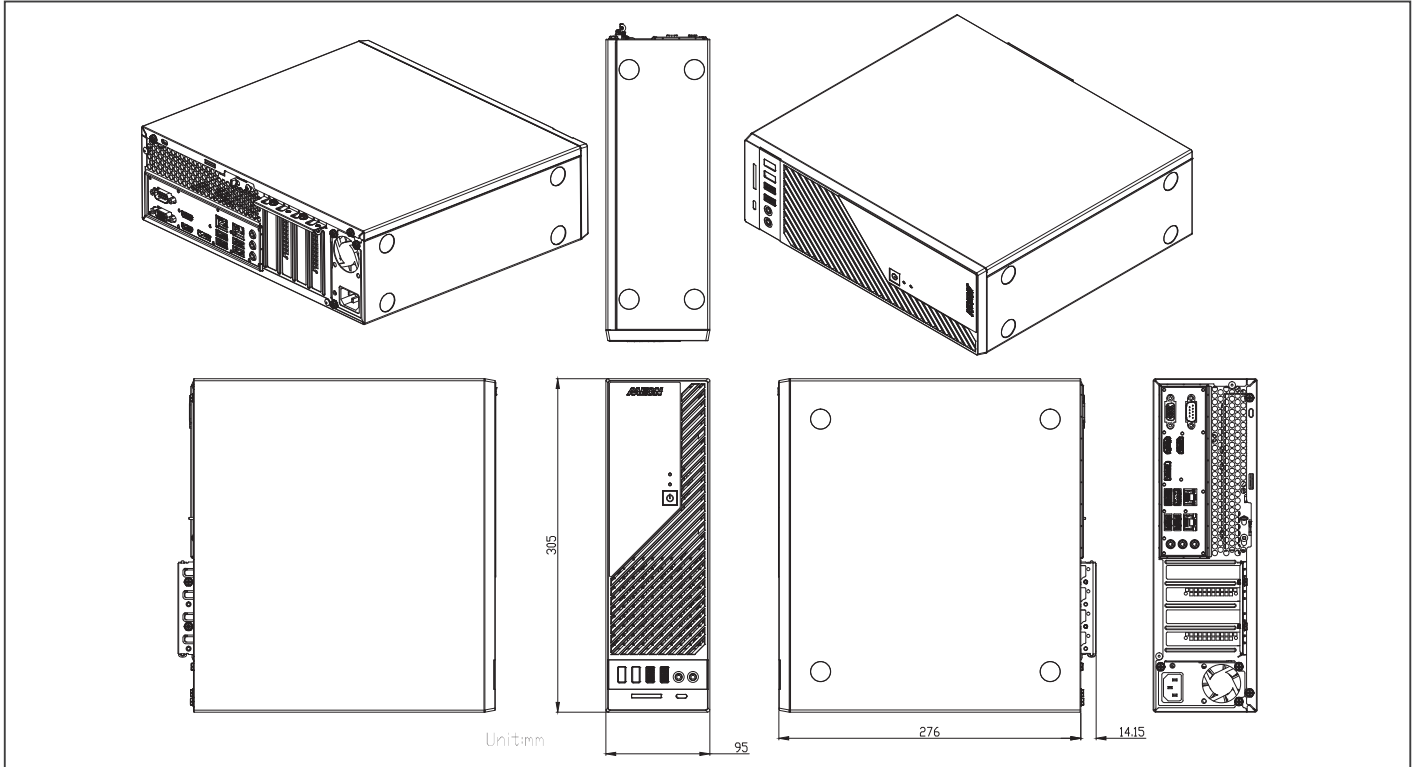

Ordering Information

Part Number	PCH	CPU	GPU	Giga LAN	2.5G LAN	USB 3.2 Gen 2	USB 2.0	Storage	Display	Mounting	Power	Operation Temp.
MAXER-5100-Q670-A1-1010	Intel Q670	Intel® Core™ i9 processor 14900	NVIDIA RTX™ 2000 Ada x 2	1	1	6	2	2.5" SSD x1 3.5" HDD x1	HDMI x 2 DP x 1 VGA x 1	Wallmount	Build in ATX 450W	32°F ~ 113°F (0°C ~ 45°C), according to IEC68-2 with 0.5 m/s AirFlow
MAXER-5100-Q670-A2-1010	Intel Q670	Please select the designated CPU before shipping.	Please select the designated GPU before shipping.	1	1	6	2	2.5" SSD x1 3.5" HDD x1	HDMI x 2 DP x 1 VGA x 1	Wallmount	Build in ATX 450W	32°F ~ 113°F (0°C ~ 45°C), according to IEC68-2 with 0.5 m/s AirFlow

Packing List

- MAXER-5100

Optional Accessories

- 170X000799
Power Cord (US type)
- 170X000800
Power Cord (European Type)
- 170X000803
Power Cord (Japanese Type)

MAXER-5310 PRELIMINARY

AI Inference Server with NVIDIA® Jetson T5000™

Front View

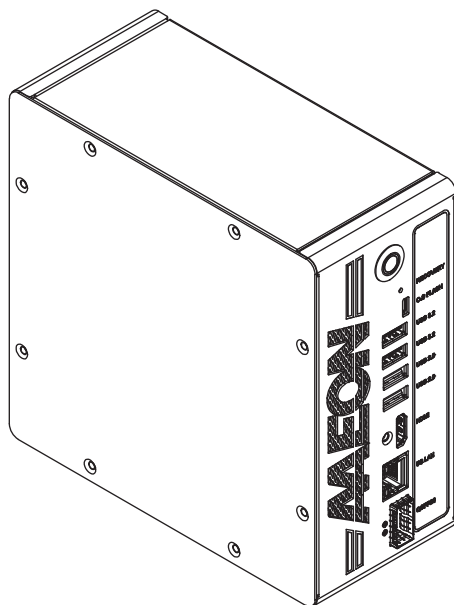

Rear View

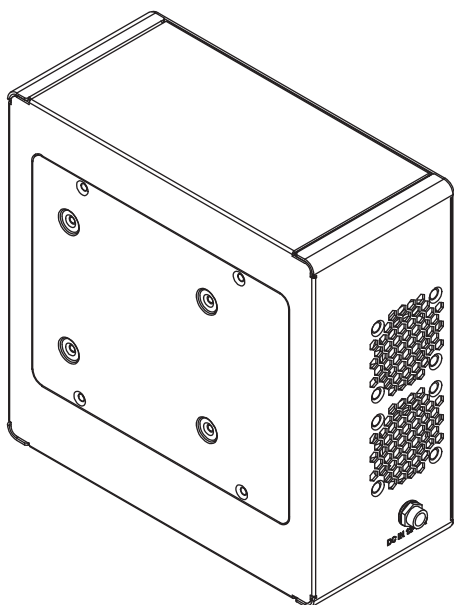

Features

- NVIDIA® Blackwell GPU with 2100 FP4 / 1050 FP8 TFLOPs AI performance
- 14-core Arm® Poseidon-AE CPU with 128GB LPDDR5X memory
- High-speed networking: 5GbE LAN + QSFP28 (4 × 25GbE)
- Flexible expansion: M.2 B-Key (5G/LTE), E-Key (WiFi 6/BT), M-Key (NVMe)
- Storage options: M.2 NVMe + 2.5" SATA drive
- Rich I/O: HDMI 2.0, USB 3.2 Gen2, USB 2.0, OS Flash port
- Supports NVIDIA JetPack™ 7.0"



Specifications

System	
CPU	12th/13th/14th Generation Intel® Core™ LGA1700 Socket Processors
GPU	NVIDIA RTX™ 2000 Ada GPU x 2 (Selected SKUs)
Chipset	Intel® Q670 Chipset
System Memory	DDR5 4800MHz U-DIMM x 4, Up to 128GB
Display Interface	VGA x 1 HDMI 2.0 x 2 DP 1.4 x 1
Storage Device	2.5" SSD x 1 3.5" HDD x 1
Ethernet	RJ-45, 1GbE x 1 RJ-45, 2.5GbE x 1
USB	USB 2.0 x 2 USB 3.2 x 6
Serial Port	DB-9 for COM Port (RS-232/422/485 & RI/5V/12V)
Audio	Audio Jack x 5 (Line-in, Mic-in x 2, Line-out x 2)
Expansion	PCIe Gen 4 [x16] x 1 PCIe Gen 4 [x8] x 1 PCIe Gen 3 [x1] x 1 PCIe Gen 3 [x4] x 1 M.2 2230 E-Key x 1 M.2 2280/2242 M-Key x 1 (PCIe Gen 4 [x4], SATA 6Gb/s)
TPM	TPM 2.0 Onboard
Indicator	—
OS support	Windows® 10/11 64bit
Drive Bay	2.5" SATA 6Gb/s Drive Bay x 1 3.5" SATA 6Gb/s Drive Bay x 1
Front Control	—
Power Supply	
Power Requirement	Build in ATX 450W AC/DC Power supply
Mechanical	
Mounting	Wallmount
Dimensions (W x H x D)	12" x 3.7" x 10.9" (305mm x 95mm x 276mm)
Gross Weight	12 lb (5.6kg)
Net Weight	11 lb (5kg)
Environmental	
Operating Temperature	32°F ~ 113°F (0°C ~ 45°C), according to IEC68-2 with 0.5 m/s AirFlow
Storage Temperature	-40°F ~ 185°F (-25°C ~ 85°C)
Storage Humidity	5 ~ 95% @ 40°C, non-condensing
Certification	CE/FCC class A





Dimension

Unit: mm

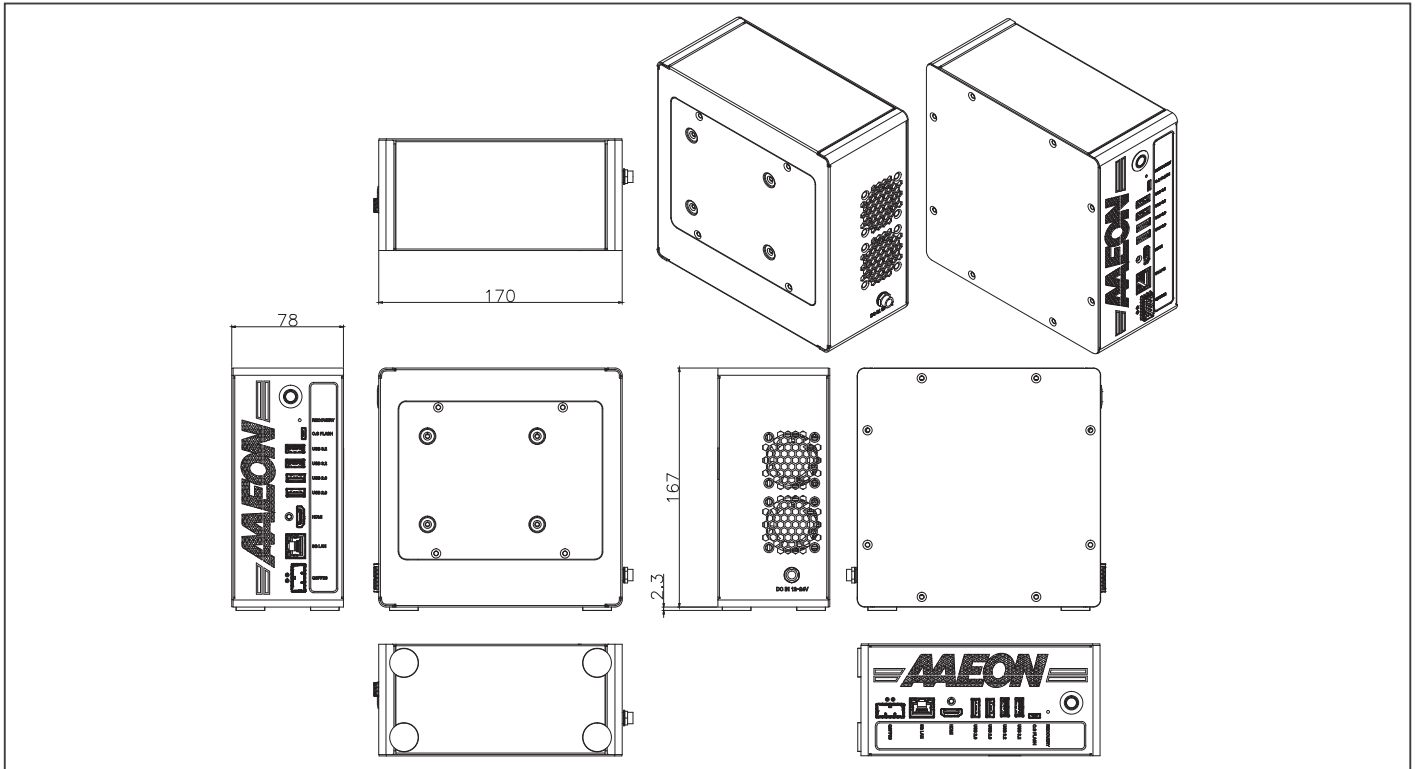

Ordering Information

- TBD

Optional Accessories

- TBD

Packing List

- MAXER-5310

02

02

RISC Gateway Solutions



SRG-IMX8P

Standard RISC Gateway with ARM i.MX8M Plus Quad-Core Cortex-A53 1.6GHz Processor

Front View

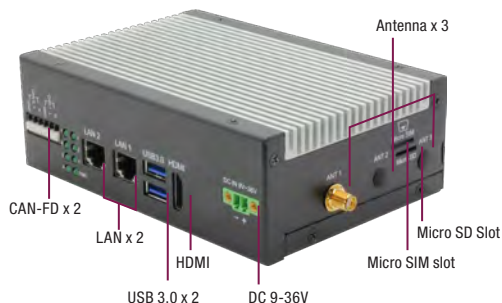

Rear View



With Antennas installed



(Antennas: Optional Accessories)

Pinout	PIN	CAN1 Definition	CAN2 Definition
1	1	H	H
2	2	L	L
3	3	GND	GND

Pinout	PIN	COM P1 Definition	COM P2 Definition
1	1	DCD1	DCD2
2	2	RXD1	RXD2
3	3	TXD1	TXD2
4	4	DTR1	DTR2
5	5	RTS1	RTS2
6	6	CTS1	CTS2
7	7	GND	GND

Features

- NXP i.MX8M Plus Quad Cortex-A53 1.6 GHz RISC Processor
- Onboard LPDDR4 2GB / eMMC 16GB (Optional 4GB RAM/ eMMC 32GB)
- HDMI 2.0a
- GbE x 2
- USB 3.0 x 2, Full size mPCIe x 2, CAN-FD x 2 CH, Micro SD Card Slot x 1, RTC, TPM 2.0
- Wide DC Input 9~36V
- Wide Temperature -20 °C ~ 70 °C
- UL61010 certificated; PLC and heavy industry IEC61000-6-2, IEC61000-6-4, IEC61131-2 qualified
- Pre-Install Linux Debian 11; Support Android 13, Win 10 IoT, Yocto
- Supports Modbus/ MQTT Library/ OPCUA/ Security boot/ GUI/ Machine learning eIQ (by request)



Specifications

System	
Processor	ARM NXP i.MX8M Plus Quad-Core Cortex-A53 1.6GHz Processor
Memory	Onboard LPDDR4 2GB (Optional 4GB)
Storage	eMMC 5.1 16GB (Optional 32GB)
Real Time Clock	RTC x 1, with 3V CR2032H Lithium battery
Security	TPM 2.0
Indicators	Programmable LED control x 7
Cellular	Mini PCIe Connector x 1 (USB signal)
Wireless Lan	Mini PCIe Connector x 1 (USB signal)
Operating System	Debian 11(Default, GUI is optional) Android 13 Win 10 IoT Yocto
Support Protocol	Modbus / MQTT Library (by request)
I/O Interfaces	
Serial Port	RS-232/422/485 switchable x 2, Phoenix Connector
Ethernet	Gigabit Ethernet x 2, RJ-45
Audio	—
USB	USB 3.0, Type-A x 2
ADC	—
DI/DO	—
CAN Bus	CAN-FD x 2 CH, Phoenix Connector
Display	HDMI 2.0a x 1
Power Connector	2 Pin 3.81mm Pitch Phoenix Connector
Debug Port	Micro USB x 1
Expansion Slot	SIM card slot x 1 Micro SD slot x 1
Other Interface	—
Power Supply	
Power Requirement	DC 9-36V
Power Consumption	9.36W (Full Loading)
MTBF (Hours)	479,374
Environmental and Mechanical	
Dimension	5.54" x 3.86" x 1.89" (140.76 x 98.2 x 48 mm)
Weight	2.6lb (1.18kg)
Mount Options	Wall Mount, Din Rail (Optional)
Operation Temperature	-4 °F ~ 158 °F (-20 °C ~ 70 °C)
Storage Temperature	-40 °F ~ 176 °F (-40 °C ~ 80 °C)
Operation Humidity	10% ~ 95% relative humidity, non-condensing
Certification	CE/FCC Class A UL61010/IEC61000-6-2/IEC61000-6-4/IEC61131-2

Packing List

- SRG-IMX8P x 1
- 2pin 3.81mm Power Terminal block w/lock AWG 28-14 x 1



ES France - Mobilité & Systèmes Embarqués
127 rue de Buzenval BP 26 - 92380 Garches



Tél. 01 47 95 99 80



e-mail : mse@es-france.com
Site Web : www.es-france.com



Dimension

Unit: mm

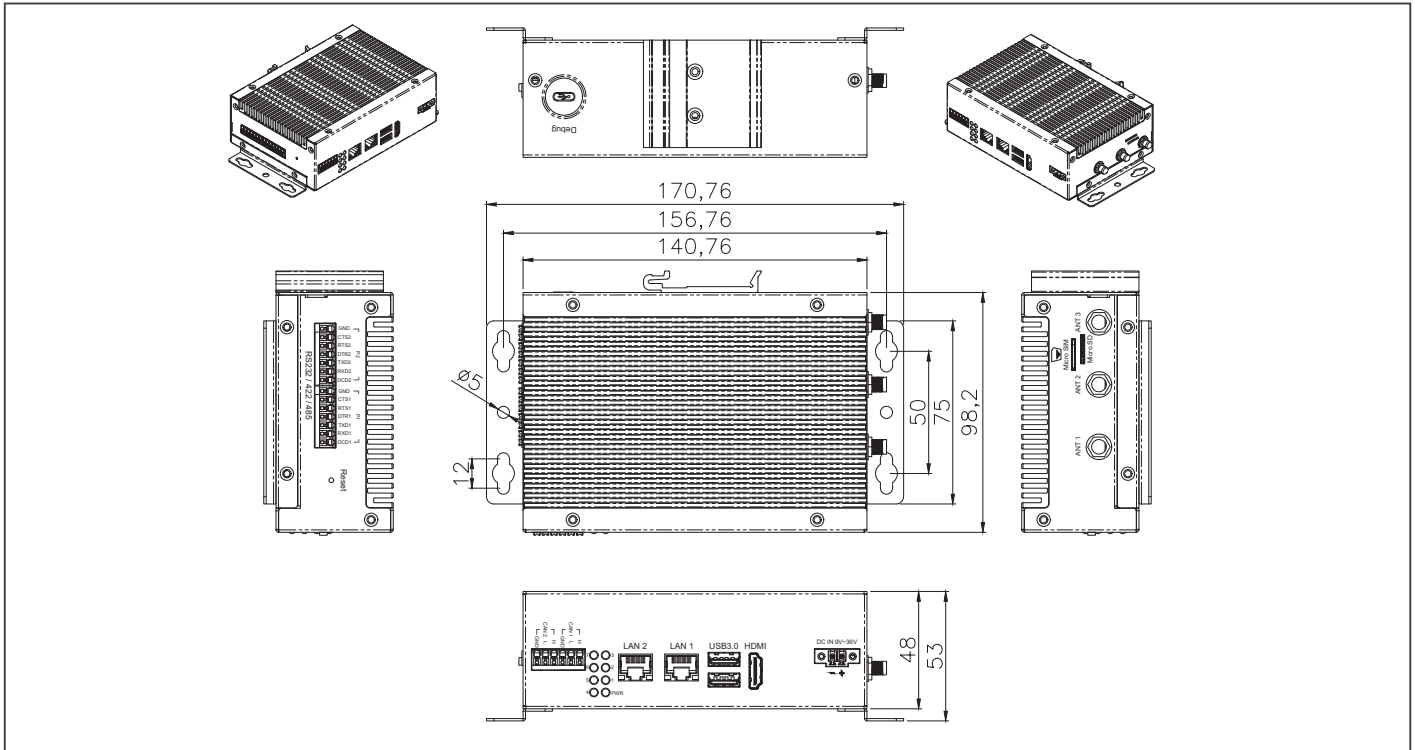

Ordering Information

Part Number	CPU	NPU	Memory	Display	Storage	LAN	USB	COM	Expansion Slot	Power	Operating Temp	Audio	Others	OS
SRG-IMX8P-A11-0216	ARM NXP i.MX8M Plus Quad-Core Cortex-A53 1.6GHz Processor	2.3 TOPs	Onboard LPDDR4 1866MHz 2GB	HDMI x 1	eMMC 16GB MicroSD x1	GbE x 2	USB 3.0 x 2	RS-232/422/485 x 2, Phoenix	Mini PCIe Slot x 2 SIM card socket x 1	DC 9-36V	-20°C ~ 70°C	—	CAN-FD x 2 CH, Phoenix 3G/4G LTE module Wifi/BT Module (optional)	Debian 11
SRG-IMX8P-A11-0432	ARM NXP i.MX8M Plus Quad-Core Cortex-A53 1.6GHz Processor	2.3 TOPs	Onboard LPDDR4 1866MHz 4GB	HDMI x 1	eMMC 32GB MicroSD x1	GbE x 2	USB 3.0 x 2	RS-232/422/485 x 2, Phoenix	Mini PCIe Slot x 2 SIM card socket x 1	DC 9-36V	-20°C ~ 70°C	—	CAN-FD x 2 CH, Phoenix 3G/4G LTE module Wifi/BT Module (optional)	Debian 11
SRG-IMX8P-A11-W432	ARM NXP i.MX8M Plus Quad-Core Cortex-A53 1.7GHz Processor	2.3 TOPs	Onboard LPDDR4 1866MHz 4GB	HDMI x 1	eMMC 32GB MicroSD x1	GbE x 2	USB 3.0 x 2	RS-232/422/485 x 2, Phoenix	Mini PCIe Slot x 2 SIM card socket x 1	DC 9-36V	-20°C ~ 70°C	—	CAN-FD x 2 CH, Phoenix 3G/4G LTE module Wifi/BT Module (optional)	Win 10 IOT for ARM64

Installation Scenario



DIN-Rail Mount Illustration

Wallmount Illustration

Optional Accessories

Part Number	Description
9741EG2560	PCIe mini card. 4G LTE. module kit. Global Band W/SIM holder. W/Cable & antenna. Quectel. EG25-G
9741EC25E0	PCIe mini card.4G LTE. module kit. W/Cable & Antenna. Quectel. EC25-E
9741236A00	Mini card Wifi Kit.802.11ac/a/b/g/n. BT4.2. W/Cable&Antenna.SparkLan.WPET-236ACN(BT)
9651IM8P00	Windows® 10 IoT Enterprise LTSC Base for Arm64 EPKEA (only for SRG-IMX8P 4G RAM SKU)
1255300611	Power Adapter.DC.100/240V.12V.5A.60W.2P Phoenix P=3.81mm.
170203180J	POWER CORD.3P-250V 13A.1.8M.UK
9651IMX802	DIN rail kit. SRG-IMX8P series
9651IMX801	Wall mount kit.SRG-IMX8P series

SRG-IMX8PL

Standard RISC Gateway with ARM i.MX8M Plus Quad-Core Cortex-A53 1.6GHz Processor

Front View

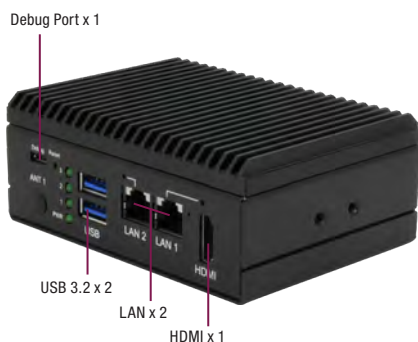

Rear View

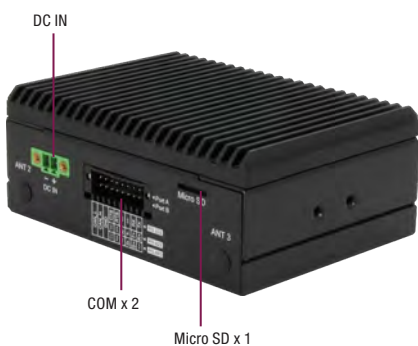

SRG-IMX8PL-A12



Installation Scenario

Phoenix Connector



Features

- ARM NXP i.MX8M Plus Quad-Core, Cortex-A53 1.6GHz
- LPDDR4, up to 4 GB, eMMC 5.1 x 1
- HDMI 2.0 x 1
- GbE x 2
- USB 3.0 Gen 1 x 2
- M.2 2230 E Key x 1, Full-sized minicard x 1
- COM x 2, CAN x 2, TPM 2.0



Specifications

System	
Processor	ARM NXP i.MX8M Plus Quad-Core Cortex-A53 1.6GHz Processor (Default w/NPU, optional w/o NPU)
Memory	Onboard LPDDR4 up to 4GB (8GB by request)
Storage	eMMC 5.1 16/32GB (Optional 64/128 GB) Micro SD Card slot x 1
Real Time Clock	RTC x 1, with 3V CR2032H Lithium battery
Security	TPM 2.0 (optional)
Indicators	Programmable LED control x 3
Cellular	Full Size Mini Card x 1 (USB signal)
Wireless Lan	M.2 2230 E-key x 1 (USB, PCIe)
Operating System	Debian 11 (Default, GUI is optional) Debian 12 (By request) Android 13 Yocto 4.0
Support Protocol	Modbus, MQTT, OPCUA
I/O Interfaces	
Serial Port	RS-232/422/485 switchable x 2, Phoenix Connector
Ethernet	Gigabit Ethernet x 2, RJ-45 support IEEE 1588, TSN, integrated RGMII
Audio	Line Out x 1 (optional)
USB	USB 3.0 Type-A x 2
ADC	—
DI/DO	—
CAN Bus	CAN-FD x 2 CH, Phoenix Connector
Display	HDMI 2.0 x 1
Power Connector	2 Pin 3.81mm Pitch Phoenix Connector
Debug Port	Micro USB x 1
Expansion Slot	M.2 2230 E-key x 1, support Wifi/BT module Full Size Mini Card x 1, support 4G module, etc) Power control available by software Nano SIM card slot x 1 (for SRG-IMX8PL-A12 only)
Other Interface	—
Power Supply	
Power Requirement	DC 9-36V (Optional: 12V)
Power Consumption	14.8W (Full Loading)
MTBF (Hours)	1,699,754 Hours
Environmental and Mechanical	
Dimension	4.25" x 3.12" x 1.69" (108mm x 79.5mm x 43mm)
Weight	1.01 lbs (0.46kg)
Mount Options	Wall Mount, Din Rail (Optional)
Operation Temperature	-40 °F ~ 176 °F (-40 °C ~ 80 °C), IEC60068-2 with 0.7 m/s AirFlow, with wide temperature Memory/Storage
Storage Temperature	-40 °F ~ 176 °F (-40 °C ~ 80 °C)
Operation Humidity	0% ~ 90% relative humidity, non-condensing
Certification	CE/FCC Class A

Packing List

- SRG-IMX8PL x 1
- 2pin 3.81mm Power Terminal block w/lock AWG 28~14 x 1
- 18pin 2.54mm Phoenix plug in Connector/lock AWG 30~20 x 1



Dimension

Unit: mm

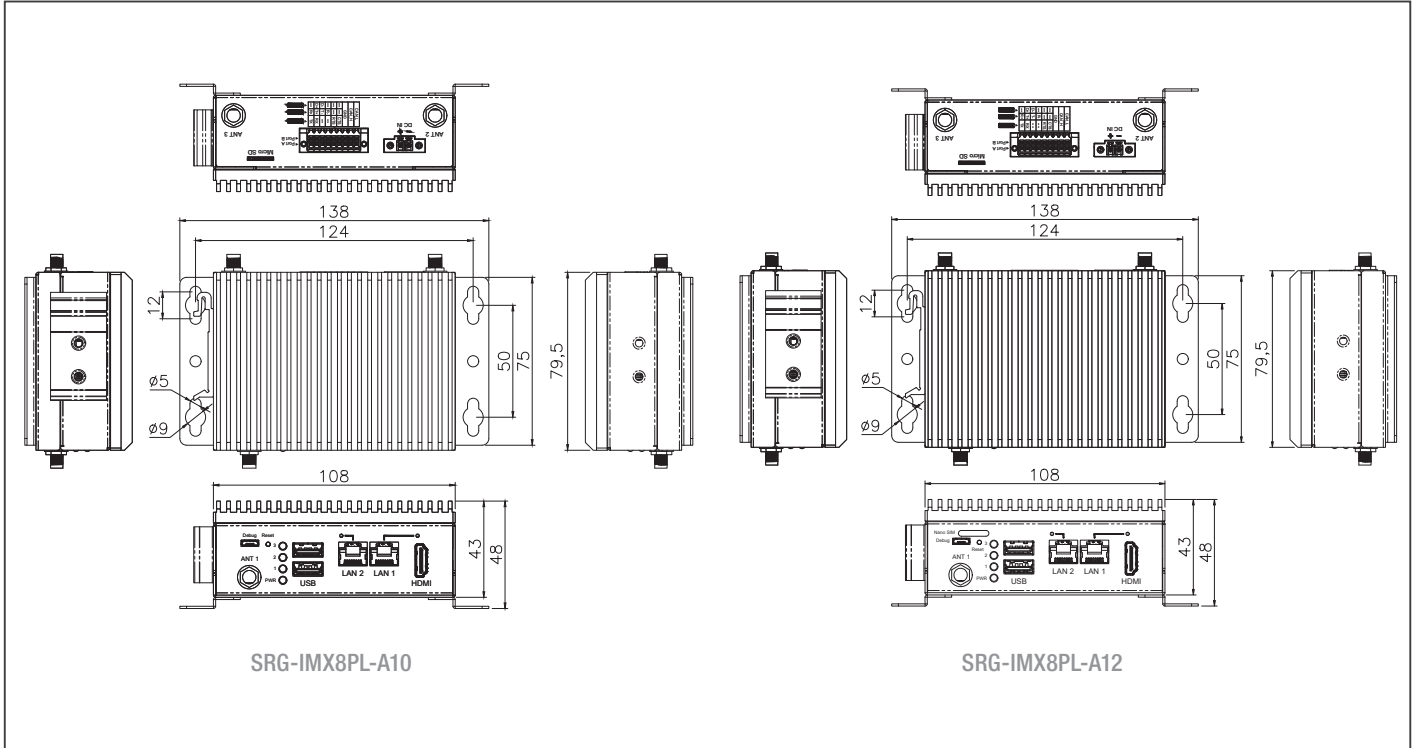

Optional Accessories

Part Number	Description
9741EG25G0	PCIe mini card. 4G LTE. module kit. Global Band W/ SIM holder. W/Cable & antenna. Quectel. EG25-G
9651882200	M.2 2230 E Key Wireless Kit.802.11 ac/a/b/g/n + BT 5.0.2T2R,Enli RTL-8822CE.w/2 sets of cable and antenna
9651276000	M.2 2230 E Key Wireless Kit.802.11a/b/g/n/ac.W/2 sets of antenna and cable.Chipset:NXP 88W8997.Azurewave.CM-276MA-PUR for Android
9651PX8L00	Power Adapter.DC.100/240V.12V.5A.60W.2p phoenix P=3.81mm.FSP.FSP060-DHAN3/9NA0608085.(for sample order), w/packaging box
1255300611	Power Adapter.DC.100/240V.12V.5A.60W.2p phoenix P=3.81mm.FSP.FSP060-DHAN3/9NA0608085
170203180J	POWER CORD.3P-250V 13A.1.8M.UK
170X000799	POWER CORD.3P-125V 10A.1.8M.USA
170X000800	POWER CORD.3P-250V 10A.1.8M.EU
170X000806	POWER CORD.3P-125V 7A.1.8M.TWN
170X000803	POWER CORD.3P-125V 7A.1.8M.JPN
9651IMX804	Wall mount kit. 75x27mm
9651IMX803	DIN rail kit.25mm

Ordering Information

Part Number	CPU	NPU	Memory	Display	Storage	LAN	USB	COM	Expansion Slot	Power	Operating Temp	Audio	Others	OS
SRG-IMX8PL-A10-0001	ARM NXP i.MX8M Plus Quad-Core Cortex-A53 1.6GHz Processor	2.3 TOPs	Onboard LPDDR4 2GB	HDMI x 1	eMMC 16GB MicroSD x1	GbE x 2	USB 3.0 Gen1 x 2	RS232(4-wire)/422/485 x 2	M.2 2230 E-key x 1 miniCard (Full) x 1	+12V (Lockable terminal block)	-40°C ~ 80°C	—	CAN 2.0 FD x 2	Debian 11
SRG-IMX8PL-A10-0002	ARM NXP i.MX8M Plus Quad-Core Cortex-A53 1.6GHz Processor	2.3 TOPs	Onboard LPDDR4 4GB	HDMI x 1	eMMC 32GB MicroSD x1	GbE x 2	USB 3.0 Gen1 x 2	RS232(4-wire)/422/485 x 2	M.2 2230 E-key x 1 miniCard (Full) x 1	+9 ~36 V (Lockable terminal block)	-40°C ~ 80°C	—	TPM x 1 CAN 2.0 FD x 2	Debian 11
SRG-IMX8PL-A12-0001	ARM NXP i.MX8M Plus Quad-Core Cortex-A53 1.6GHz Processor	2.3 TOPs	Onboard LPDDR4 2GB	HDMI x 1 (rear I/O)	eMMC 16GB, MicroSD x1	GbE x 2	USB 3.0 Gen1 x 2 (rear I/O)	RS232(4-wire)/422/485 x 2	M.2 2230 E-key x 1 miniCard (Full) x 1 Nano SIM card slot x 1	+12V (Lockable terminal block)	-40°C ~ 80°C	—	CAN 2.0 FD x 2	Debian 11
SRG-IMX8PL-A12-0002	ARM NXP i.MX8M Plus Quad-Core Cortex-A53 1.6GHz Processor	2.3 TOPs	Onboard LPDDR4 4GB	HDMI x 1 (rear I/O)	eMMC 32GB, MicroSD x1	GbE x 2	USB 3.0 Gen1 x 2 (rear I/O)	RS232(4-wire)/422/485 x 2	M.2 2230 E-key x 1 miniCard (Full) x 1 Nano SIM card slot x 1	+9 ~36 V (Lockable terminal block)	-40°C ~ 80°C	—	TPM x 1 CAN 2.0 FD x 2	Debian 11

SRG-AM62

Standard RISC Gateway with TI AM62x Sitara™ Processors



Phoenix Connector



Features

- ARM TI AM62x, up to Quad 64-bit Arm® Cortex®-A53
- DDR4, up to 4 GB, eMMC 5.1 x 1
- HDMI 1.4b x 1
- GbE x 2
- USB 2.0 x 2
- Minicard x 2 (half x 1, full x 1)
- COM x 2, CAN x 2, TPM 2.0



Specifications

System	
Processor	ARM TI AM62x, up to Quad 64-bit Arm® Cortex®-A53
Memory	Onboard DDR4 16 bit, up to 4 GB
Storage	eMMC 5.1 16 GB (Optional 32/64/128 GB) Micro SD Card slot x1
Real Time Clock	RTC x 1, with 3V CR2032H Lithium battery
Security	TPM 2.0 (optional)
Indicators	Programmable LED control x 3
Cellular	Full Size Mini Card x 1 (USB signal)
Wireless Lan	Half Size Mini Card x 1 (USB signal)
Operating System	Debian 12 (w/ GUI)
Support Protocol	—
I/O Interfaces	
Serial Port	RS-232/422/485 switchable x 2, Phoenix Connector
Ethernet	Gigabit Ethernet x 2, RJ-45 support IEEE 1588, TSN, integrated RGMII
Audio	Line Out x 1 (by request)
USB	USB 2.0 Gen1 x 2 -Host/device by image option, default: host x 1 -Host x 1
ADC	—
DI/DO	—
CAN Bus	CAN-FD x 2 CH, Phoenix Connector
Display	HDMI 1.4b up to 1080p x 1
Power Connector	2 Pin 3.81mm Pitch Phoenix Connector
Debug Port	Micro USB x 1
Expansion Slot	Half Size Mini Card (USB2.0) x 1, support Wifi/BT module, etc Full Size Mini Card (USB2.0) x 1, support 4G module, etc Power control available by software
Other Interface	—
Power Supply	
Power Requirement	DC 9-36V (Optional: 12V)
Power Consumption	5.76W (Full Loading)
MTBF (Hours)	1,279,408 Hours
Environmental and Mechanical	
Dimension	4.25" x 3.13" x 1.29" (108mm x 79.5mm x 33mm)
Weight	0.72 lbs (0.33 kg)
Mount Options	Wall Mount, Din Rail (Optional)
Operation Temperature	-40 °F ~ 185 °F (-40 °C ~ 85 °C) (Option: 0°C ~ 60°C)
Storage Temperature	-40 °F ~ 185 °F (-40 °C ~ 85 °C)
Operation Humidity	0% ~ 90% relative humidity, non-condensing
Certification	CE/FCC Class A

Packing List

- SRG-AM62 x 1
- 2pin 3.81mm Power Terminal block w/lock AWG 28~14 x 1
- 14pin 2.54mm Phoenix plug in Connector/lock AWG 30~20 x 1





Dimension

Unit: mm

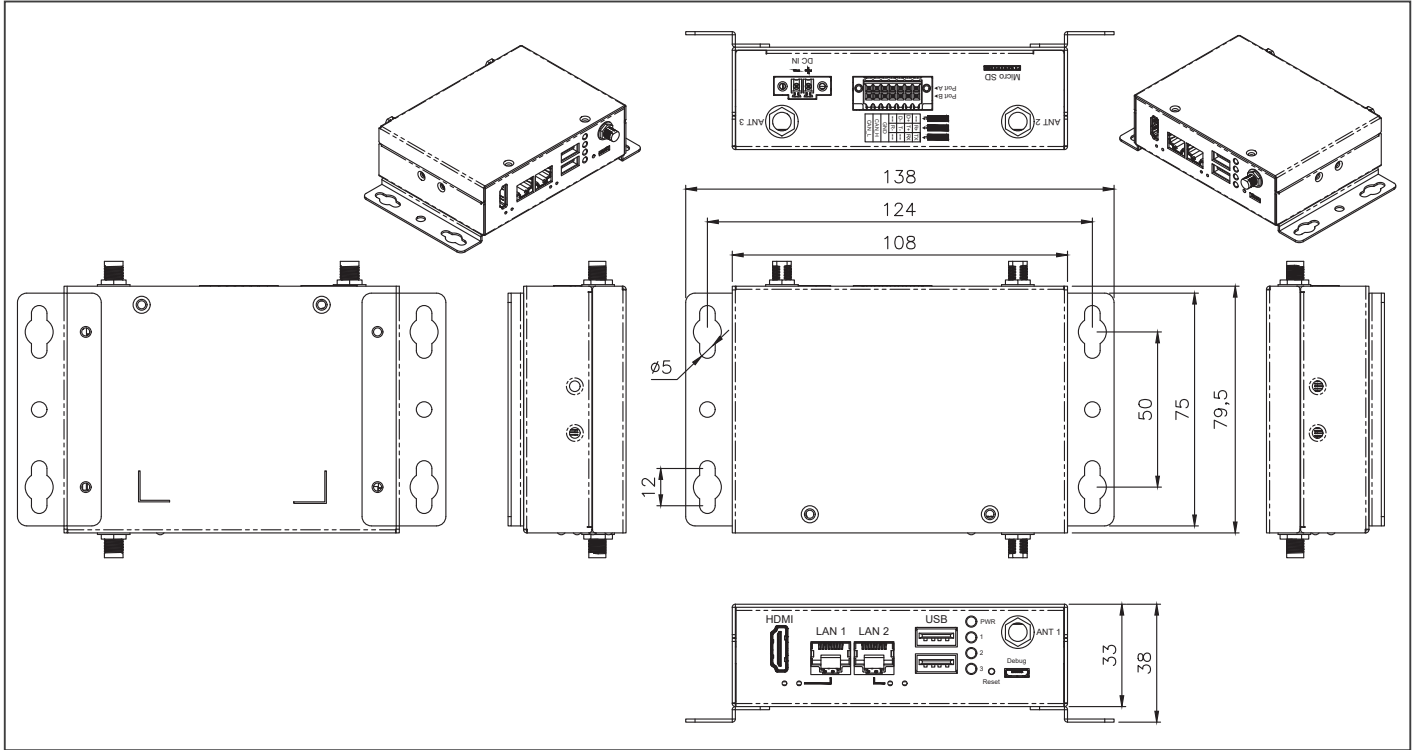

Optional Accessories

Part Number	Description
9741EG25G0	PCIe mini card. 4G LTE. module kit. Global Band W/ SIM holder. W/Cable & antenna. Quectel. EG25-G
9651239A00	Mini card WiFi Kit.802.11ac/a/b/g/n. BT5.0. W/ Cable&Antenna.SparkLan.WPET-239ACN(BT)
9651PX8L00	AC/DC Adapter.100V-240V.12VDC.40W.3.34A (for sample order), w/packaging box
170203180J	POWER CORD.3P-250V 13A.1.8M.UK
170X000799	POWER CORD.3P-125V 10A.1.8M.USA
170X000800	POWER CORD.3P-250V 10A.1.8M.EU
170X000806	POWER CORD.3P-125V 7A.1.8M.TWN
170X000803	POWER CORD.3P-125V 7A.1.8M.JPN
9651IMX803	DIN rail kit.25mm
9651IMX804	Wall mount kit. 75x27mm

Ordering Information

Part Number	CPU	NPU	Memory	Display	Storage	LAN	USB	COM	Expansion Slot	Power	Operating Temp	Audio	Others	OS
SRG-AM62-A10-0001	ARM TI AM6232, Dual-Core Cortex-A53 1.4GHz Processor	—	Onboard DDR4 2GB	—	eMMC 16GB, MicroSD x1	GbE x 1	USB 2.0 x 2	RS232(2-wire)/422/485 x 2	Half Size Mini Card x 1 Full Size Mini Card x 1	+12V (Lockable terminal block)	-40°C ~ 85°C	—	CAN 2.0 FD x 2	Debian 12
SRG-AM62-A10-0002	ARM TI AM6254, Quad-Core Cortex-A53 1.4GHz Processor	—	Onboard DDR4 2GB	HDMI x 1	eMMC 16GB, MicroSD x1	GbE x 2	USB 2.0 x 2	RS232(2-wire)/422/485 x 2	Half Size Mini Card x 1 Full Size Mini Card x 1	+ 9 ~ 36 V (Lockable terminal block)	-40°C ~ 85°C	—	TPM x 1 CAN 2.0 FD x 2	Debian 12

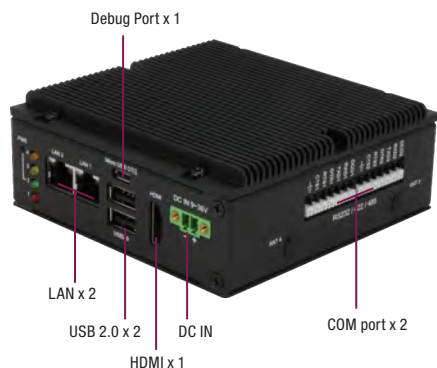

Phoenix Connector



Features

- Broadcom BCM2711 quad-core Cortex-A72 SoC @ 1.5GHz
- On board LPDDR4, up to 8 GB, eMMC 5.1 x 1
- HDMI 2.0 x 1
- GbE x 2, USB 2.0 x 2
- Full-sized mini card x 1
- RS-232/422/485 switchable x 2, RS-485 with isolation x 1
- CAN 2.0 A/B x 2, TPM 2.0, RTC
- Wide Voltage DC 9V ~ 36V
- Wide Temperature -20 °C ~ 70 °C



Specifications

System	
Processor	Broadcom BCM2711 Quad-Core Cortex-A72 SoC @1.5 Ghz
Memory	On board LPDDR4, up to 8 GB
Storage	eMMC 5.1, 8/16/32 GB (Optional) Micro SD Card x 1 (Optional w/o eMMC)
Real Time Clock	RTC x 1, with 3V CR2032H Lithium battery
Security	TPM 2.0 (Optional)
Indicators	Programmable LED control x 3
Cellular	—
Wireless Lan	—
Operating System	Raspberry Pi Desktop Debian 11
Support Protocol	—
I/O Interfaces	
Serial Port	RS-232/422/485 switchable x 2 RS-485 with isolation x 1 (Optional)
Ethernet	Gigabit Ethernet x 2, RJ45
Audio	—
USB	USB 2.0 x 2 USB 2.0 OTG x 1
ADC	—
DI/DO	DI x 2 / DO x 2 with Isolation (optional)
CAN Bus	CAN 2.0 A/B x 2
Display	HDMI 1.4, up to 4K30 (For SD card storage, up to 1080P)
Power Connector	2 pin 3.81mm pitch phoenix connector
Debug Port	UART x 1 (Internal Wafer Box)
Expansion Slot	Full-sized mini card x 1 (USB signal)
Other Interface	Software button x 1 Power button x 1 Reset button x 1
Power Supply	
Power Requirement	DC 9 ~36 V
Power Consumption	12.6 W
MTBF (Hours)	1,311,814 Hours
Environmental and Mechanical	
Dimension	4.11 " x 4.13" x 1.89" (104.4 x 105 x 41mm)
Weight	1.08 lb (0.49 kg)
Mount Options	Wall Mount, Din Rail (Optional)
Operation Temperature	-4°F ~ 158°F (-20 °C ~ 70°C)
Storage Temperature	-40°F ~ 176°F (-40°C ~ 80°C)
Operation Humidity	10% ~ 95% relative humidity, non-condensing
Certification	CE/FCC Class A

Packing List

- SRG-CM4 x 1 (Without CM4 module due to price fluctuations driven by market shortages)
- 2pin 3.81mm Power Terminal block w/lock AWG 28~14 x 1



Dimension

Unit: mm

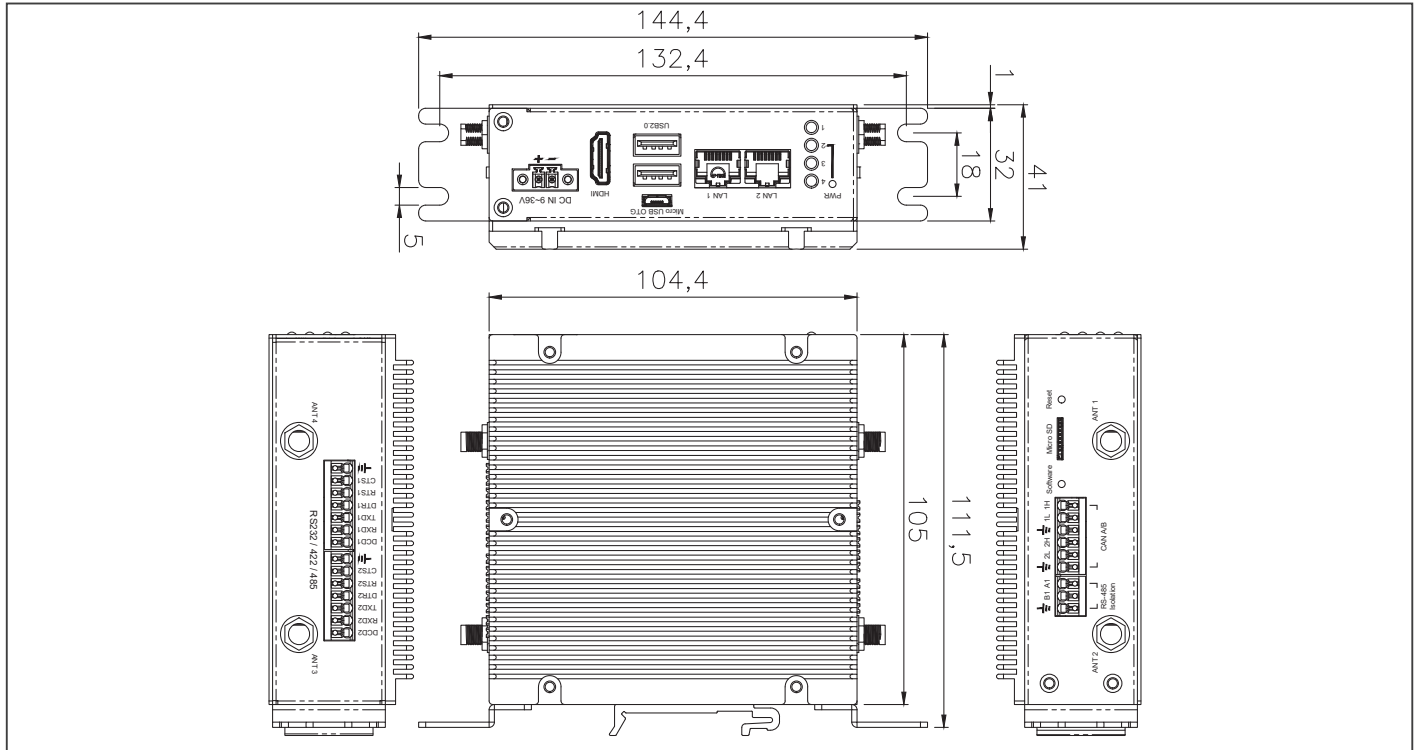

Optional Accessories

Part Number	Description
1255300611	Power Adapter.DC.100/240V.12V.5A.60W.2p phoenix P=3.81mm.
170203180J	POWER CORD.3P-250V 13A.1.8M.UK
170X000799	POWER CORD.3P-125V 10A.1.8M.USA
170X000800	POWER CORD.3P-250V 10A.1.8M.EU
170X000806	POWER CORD.3P-125V 7A.1.8M.TWN
170X000803	POWER CORD.3P-125V 7A.1.8M.JPN
9651SCM400	Wall mount kit. 32x32mm.SRG-CM4 series
9651352C02	DIN rail kit

Ordering Information

Part Number	CPU	NPU	Memory	Display	Storage	LAN	USB	COM	Expansion Slot	Power	Operating Temp	Audio	Others	OS
SRG-CM4-A10-0001	— (by CM4 module)	—	— (by CM4 module)	HDMI x 1	Micro SD card x 1 (or eMMC from CM4 module)	GbE x 2	USB 2.0 x 2, USB 2.0 OTG x 1	RS-232/422/485 switchable x 2, RS-485 with isolation x 1	Full-sized mini card x 1 (USB signal)	9V ~ 36V	-20 °C ~ 70 °C	—	CAN 2.0 A/B x 2 TPM 2.0	—

*The SRG-CM4 is a carrier board system and doesn't include the CM4 module due to price fluctuations driven by market shortages. Please contact our sales team if you would like AAEON to provide the module.

03

03

Compact Fanless BOX PC Solutions



ES France - Mobilité & Systèmes Embarqués
127 rue de Buzenval BP 26 - 92380 Garches



Tél. 01 47 95 99 80



e-mail : mse@es-france.com
Site Web : www.es-france.com

BOXER-6614

Fanless Embedded Box PC with Intel® Celeron® N2930 Quad Core 1.83 GHz/ Celeron® N2807 Dual Core 1.58 GHz

Front View



Rear View

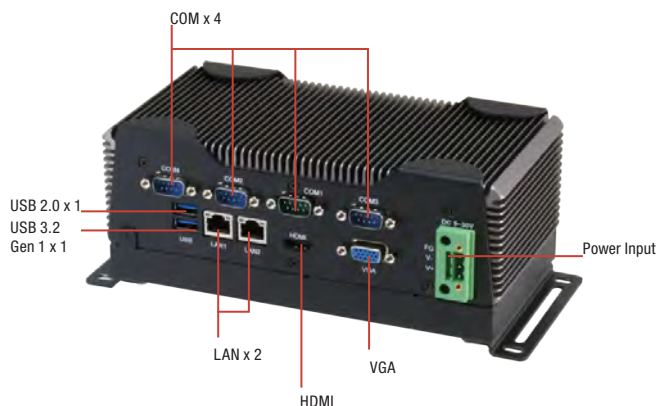

Features

- Intel® Celeron® N2930 Quad Core 1.83 GHz/ Celeron® N2807 Dual Core 1.58 GHz
- Intel® HD Graphics Engine
- DDR3L 1333 MHz SODIMM x 1, Memory up to 8 GB
- Intel® Gigabit Ethernet x 2
- VGA + HDMI Output, Supports Dual View/Simultaneous Display
- RS-232/422/485 x 2, RS-232 x 2, USB 3.2 Gen 1 x 1, USB 2.0 x 3
- Full-size Mini-Card with SIM Card Slot x 1, Half-size Mini-Card x 1 for Factory-Install
- Compact Size & Low Power
- Cost-Effective Design
- Fanless System Design
- AAЕON's Hi-Safe Support



Specifications

System	
CPU	Intel® Celeron® N2930, 1.83 GHz Intel® Celeron® N2807, 1.58GHz
Chipset	Intel® System on Chip
System Memory	DDR3L 1333 SODIMM slot x 1, up to 8 GB (N2930) or 4 GB (N2807)
Display Interface	VGA, HDMI
Storage Device	CFast™, HDD/SSD
Ethernet	Intel® I210/I211, 10/100/1000 Base-TX x 2
I/O	RS-232/422/485 x 2 RS-232 x 2 USB 2.0 x 3 USB 3.2 Gen 1 x 1 VGA x 1 HDMI x 1 Line-out x 1 LAN x 2 CFast slot x 1 Antenna holes x 2 Power switch Power input
Expansion	Full-size Mini-Card x 1 (PCI-E + USB, w/ SIM slot) Half-size Mini-Card x 1 (PCI-E + USB)
Indicator	Power LED HDD active LED
OS support	Windows® 10, Windows® 8.1 (32/64-bit), Windows® 7 (32/64-bit), WES7/WES8, Linux Ubuntu 14.04/ Kernel 3.13.0
Power Supply	
Power Requirement	9 - 30V with 3-pin terminal block, 12V with lockable DC jack
Mechanical	
Mounting	Wallmount DIN Rail (Mounting kit is optional)
Dimensions (W x H x D)	8.35" x 4.21" x 2.53" (212.15mm x 107mm x 64.2mm)
Gross Weight	6.6 lb (2.8 Kg)
Net Weight	4.4 lb (2 Kg)
Environmental	
Operating Temperature	-4°F ~ 131°F (-20°C ~ 55°C) with wide temperature CFast™ card -4°F ~ 140°F (-20°C ~ 60°C) with wide temperature HDD (according to IEC68-2-14 with 0.5 m/s AirFlow; with industrial devices)
Storage Temperature	-4°F ~ 158°F (-20°C ~ 70°C)
Storage Humidity	95% @ 40°C, non-condensing
Anti-Vibration	5 Grms/ 5 ~ 500Hz/ operation –CFast™ card 1 Grms/ 5 ~ 500Hz/ operation – HDD
Anti-Shock	—
Certification	CE/FCC class A, UL





Dimension

Unit: mm

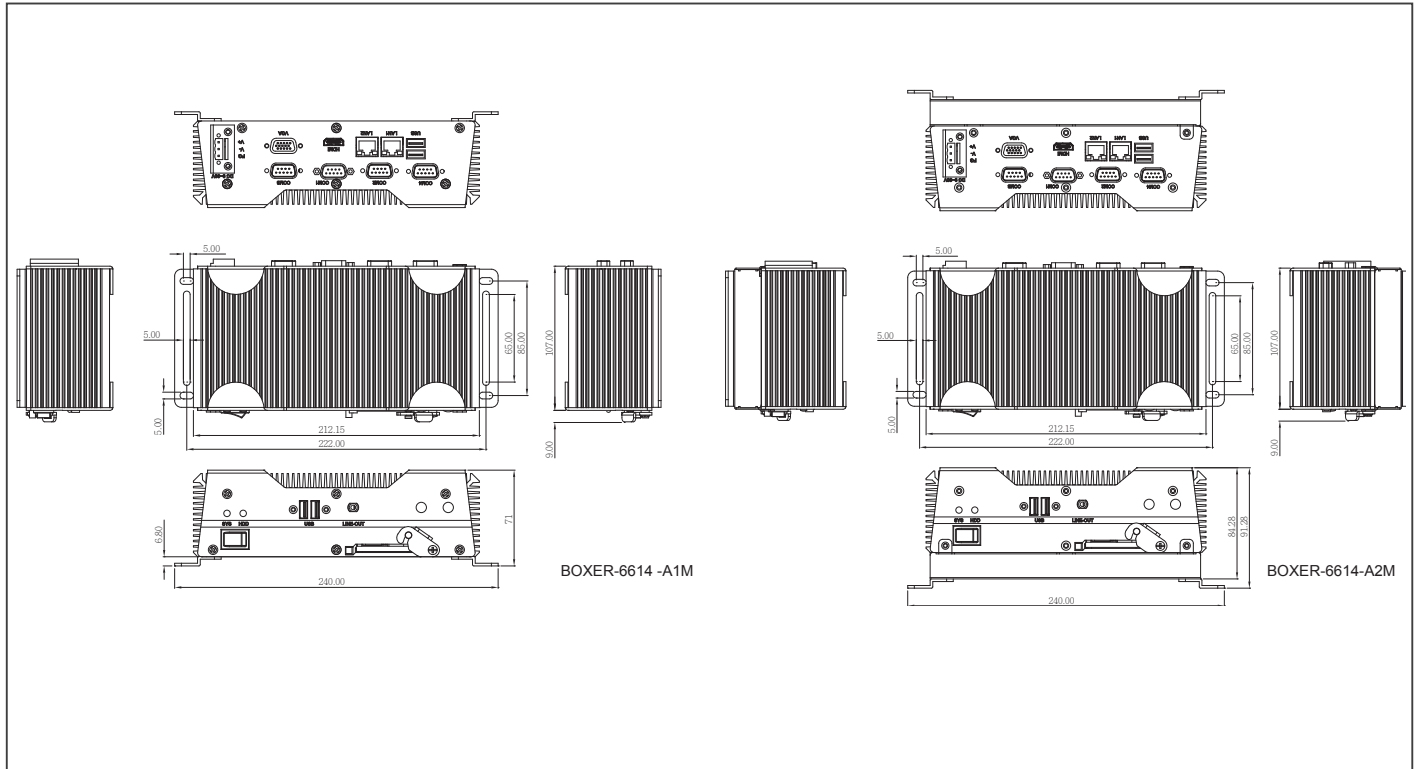

Ordering Information

Part Number	CPU	RAM	LAN	USB	RS-232	RS-232/422/485	Storage	Display	Expansion	Mounting	Power	Temp.
BOXER-6614-A1-1210	Intel® Celeron® SoC N2930	—	2	4	2	2	CFast Socket x 1 (Easy-to-swap)	VGA x 1 HDMI x 1	Full Size Mini-Card x 1 Half Size Mini-Card x 1	Wallmount/ Din Rail Mounting Kit (Optional)	DC 12V	-20°C~55°C with Wide Temp. CFast(with 0.5 m/s air flow, according to IEC68-2-14)
BOXER-6614-A1M-1210	Intel® Celeron® SoC N2930	—	2	4	2	2	CFast Socket x 1 (Easy-to-swap)	VGA x 1 HDMI x 1	Full Size Mini-Card x 1 Half Size Mini-Card x 1	Wallmount/ Din Rail Mounting Kit (Optional)	DC 9-30V	-20°C~55°C with Wide Temp. CFast(with 0.5 m/s air flow, according to IEC68-2-14)
BOXER-6614-A2-1210	Intel® Celeron® SoC N2930	—	2	4	2	2	CFast Socket x 1 (Easy-to-swap) SATA 2.5" HDD bay x 1	VGA x 1 HDMI x 1	Full Size Mini-Card x 1 Half Size Mini-Card x 1	Wallmount/ Din Rail Mounting Kit (Optional)	DC 12V	-20°C~55°C with Wide Temp. CFast(with 0.5 m/s air flow, according to IEC68-2-14)
BOXER-6614-A2M-1210	Intel® Celeron® SoC N2930	—	2	4	2	2	CFast Socket x 1 (Easy-to-swap) SATA 2.5" HDD bay x 1	VGA x 1 HDMI x 1	Full Size Mini-Card x 1 Half Size Mini-Card x 1	Wallmount/ Din Rail Mounting Kit (Optional)	DC 9-30V	-20°C~60°C with Wide Temp. HDD(with 0.5 m/s air flow, according to IEC68-2-14)
BOXER-6614-A11M-1210	Intel® Celeron® SoC N2807	—	2	4	2	2	CFast Socket x 1 (Easy-to-swap)	VGA x 1 HDMI x 1	Full Size Mini-Card x 1 Half Size Mini-Card x 1	Wallmount/ Din Rail Mounting Kit (Optional)	DC 9-30V	-20°C~55°C with Wide Temp. CFast(with 0.5 m/s air flow, according to IEC68-2-14)
BOXER-6614-A12-1210	Intel® Celeron® SoC N2807	—	2	4	2	2	CFast Socket x 1 (Easy-to-swap) SATA 2.5" HDD bay x 1	VGA x 1 HDMI x 1	Full Size Mini-Card x 1 Half Size Mini-Card x 1	Wallmount/ Din Rail Mounting Kit (Optional)	DC 12V	-20°C~55°C with Wide Temp. CFast(with 0.5 m/s air flow, according to IEC68-2-14) -20°C~60°C with Wide Temp. HDD(with 0.5 m/s air flow, according to IEC68-2-14)

Packing List

- Wallmount Bracket x 2
- Screw Package x 1
- RAM Thermal Pad x 1 (60mm x 25mm x 3mm) (For A1/A1M the SKU without HDD kit only)
- 3 Pin DC-In Power Connector x 1 (For A1M/A2M, for DC 9 ~30 V only)
- BOXER-6614

Optional Accessories

- 125530060Z - DC Jack for 6614-A1/A2
 - 170X000800
 - 1255900849 - 3 pin for 6614-A1M/A2M
 - 170X000803
 - 170X000799
 - 9741681003
- Power Adapter, AC, 100/240V, 12V/5A, 60W, W/ Lock, FSP, FSP060-DHAN3
- Power Adapter, AC, 100/240V, 12V/7A, 84W, FSP, FSP084-DHAN3
- Power Cord (European Type)
- Power Cord (Japanese Type)
- Din Rail Mount Kit
- Power Cord (US Type)

BOXER-6616

Fanless Embedded Box PC with Intel® Celeron® Processor N3350/N4200

Front View

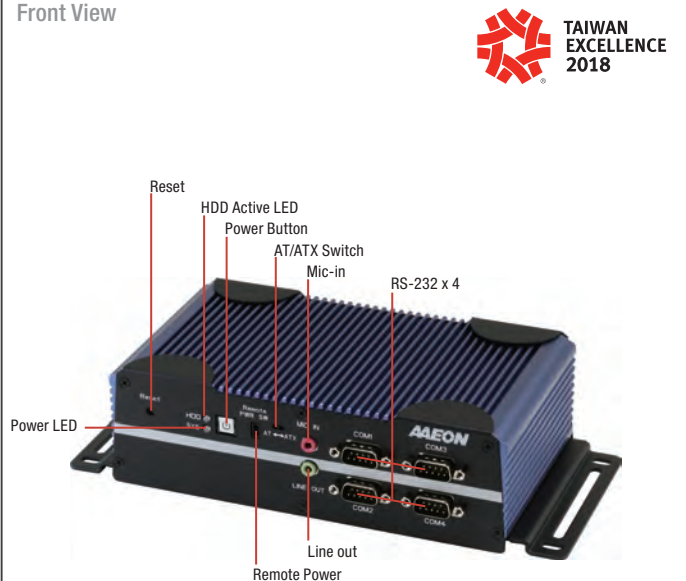

Rear View



Features

- Intel® Pentium® N4200 2.5 GHz/ Celeron® N3350 2.4 GHz
- DDR3L 1866, Single Channel SODIMM x 1, Non-ECC (Max.8GB, up to 1600MHz)
- COM x 6: RS-232/422/485 x 2 + RS-232 x 4
- USB 3.2 Gen 1 x 4
- VGA + HDMI Output, Support Dual View/ Simultaneous Display
- Supports 2.5" Drive Bay x 1, mSATA
- Supports 8 Channel TTL Level DIO x 1 (Optional)
- AAEON's Hi-Safe Support
- Supports DC 9~24V with Power Protection
- Wide Operating Temperature: -4°F ~ 158°F (-20°C ~ 70°C)
- AT/ATX Switch, Remote Power On/Off Switch



Specifications

System	
CPU	Intel® Pentium® N4200, 2.5 GHz Intel® Celeron® N3350, 2.4 GHz
Chipset	Intel® System on Chip
System memory	DDR3L 1866, Single Channel SODIMM x 1, Non-ECC (Max.8GB, up to 1600MHz)
Display Interface	HDMI (max. 2048 x 1152) VGA (max. 2048 x 1152)
Storage Device	mSATA, HDD/SSD
Ethernet	Intel® I211, 10/100/1000 Base-TX x 2
I/O	RS-232/422/485 x 2 RS-232 x 4 USB 3.2 Gen 1 x 4 VGA x 1 HDMI x 1 LAN x 2 Remote On/Off x 1 Reset Button x 1 AT/ATX DIP Switch Mic-In x 1 Line-Out x 1 Antenna holes x 1 Power button Power input
Expansion	Full-size Mini-Card x 1 (PCI-E + USB, w/ SIM slot) Half-size Mini-Card x 1 (A1:PCI-E + USB, A2: mSATA + USB)
Indicator	Power LED HDD active LED
OS Support	Windows® 10 IoT Ent LTSC 2019 64 bit Ubuntu 16.04 above
Power Supply	
Power Requirement	9-24V with 3-pin terminal block
Mechanical	
Mounting	Wallmount DIN Rail (Mounting kit is optional)
Dimensions (W x H x D)	7.76" x 2.17" x 4.33" (197mm x 55mm x 110mm)
Gross Weight	6.6 lb (2.8 Kg)
Net Weight	4.4 lb (2 Kg)
Environmental	
Operating Temperature	-4°F ~ 158°F (-20°C ~ 70°C) with W.T. SSD/HDD/mSATA (according to IEC682-14 with 0.5 m/s AirFlow; with industrial devices)
Storage Temperature	-4°F ~ 158°F (-20°C ~ 70°C)
Storage Humidity	95% @ 40°C, non-condensing
Anti-Vibration	3 Grms/ 5 ~ 500Hz/ operation – mSATA/SSD 1 Grms/ 5 ~ 500Hz/ operation – HDD
Anti-Shock	—
Certification	CE/FCC class A





Dimension

Unit: mm

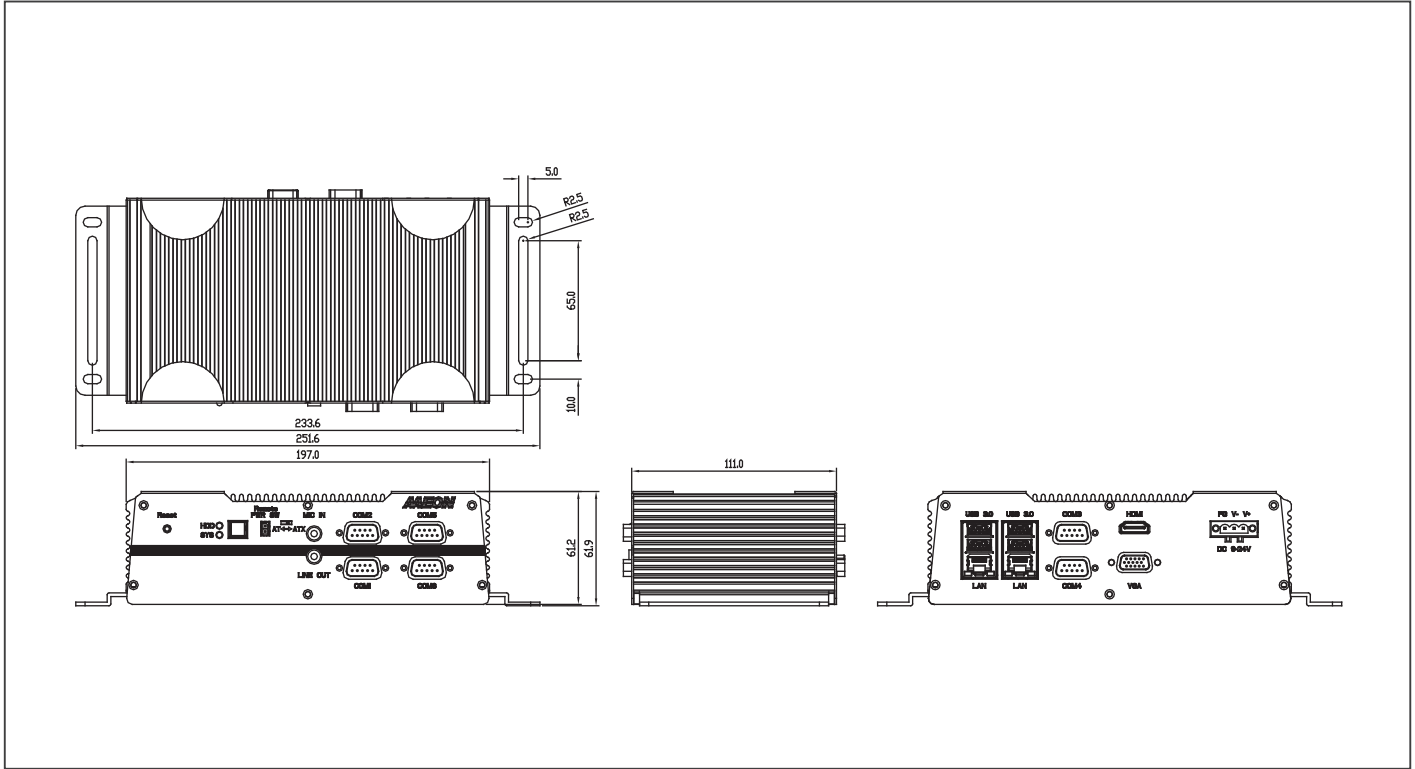

Ordering Information

Part Number	CPU	RAM	LAN	PoE	USB 3.2 Gen 1	USB 2.0	RS-232	RS-232/422/485	Digital I/O	Audio	Storage	Display	Expansion	Mounting	Power	Operation Temp.
BOXER-6616-A1-1110	Intel® Pentium® N4200 2.5 GHz	—	2	—	4	0	4	2	—	MIC-in x 1 Line-Out x 1	2.5" Drive Bay x 1	VGA x 1 HDMI x 1	Full-size Minicard x 1 Half-size Minicard x 1	Wallmount Optional Dinrail Optional VESA-Mount	9-24V DC In	-4°F ~ 158°F (-20°C ~ 70°C)
BOXER-6616-A2-1110	Intel® Celeron® N3350 2.4 GHz	—	2	—	4	0	4	2	—	MIC-in x 1 Line-Out x 1	2.5" Drive Bay x 1 mSATA x 1	VGA x 1 HDMI x 1	Full-size Minicard x 1 Half-size Minicard x 1	Wallmount Optional Dinrail Optional VESA-Mount	9-24V DC In	-4°F ~ 158°F (-20°C ~ 70°C)

Packing List

- Wallmount Bracket x 2
- Screw Package x 1
- 3 Pin DC-In Power Connector x 1
- BOXER-6616

Optional Accessories

- **1255900849**
12V 84W Power Adapter
- **170X000799**
Power Cord (US Type)
- **170X000800**
Power Cord (Europe)
- **170X000803**
Power Cord (Japan)
- **9741640404**
Din Rail Mount Kit

BOXER-6617-ADN

Fanless Compact Embedded Computer with Intel® Core™ i3 Processor N/Intel® Atom® Processor X/Intel® Processor N-series SoC (formerly Alder Lake-N)

Front View

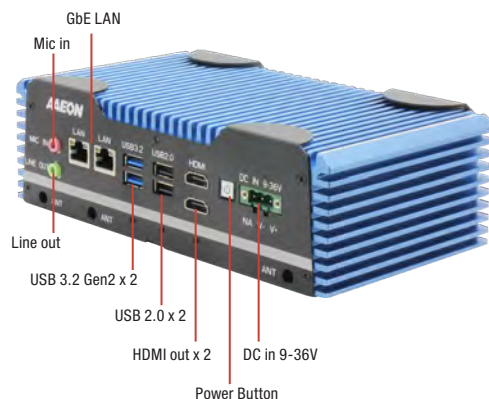

Rear View

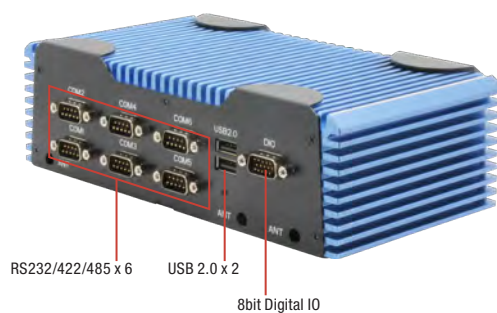

Features

- Intel® Core™ i3 Processor N/Intel® Atom® Processor X/Intel® Processor N-series SoC (formerly Alder Lake-N)
- DDR5 4800MHz SODIMM x 1
- 2.5GbE x 2
- M.2 2280 M-Key/M.2 2230 E-Key
- M.2 3052 B-Key for 5G
- SuperSpeed+ USB 3.2 Gen 2
- Onboard TPM 2.0
- Wide Range 9 ~ 36V DC input
- Super Wide Operating Temperature -20~70°C
- Hailo-8™ M.2 2280 AI Accelerator Module Support (Optional)



Specifications

System	
CPU	Intel® Processor N50 Intel® Processor N97 Intel® Core™ i3-N305 Intel Atom® x7211E
Chipset	Intel® SoC
System Memory	DDR5 4800MHz SODIMM x 1, up to 32GB
Display Interface	HDMI x 2
Storage Device	M.2 2280 M-Key x 1 (PCIe [x2]) 2.5" SATA HDD/SSD x 1
Ethernet	RJ-45 x 2 for 2.5GbE LAN (Intel® I226)
I/O	HDMI x 2 RJ-45 x 2 for 2.5GbE LAN (Intel® I226) USB 3.2 Gen 2 x 2 (Type-A) USB 2.0 x 4 (Type-A) DB-9 x 6 for RS-232/422/485 Mic-in/Line-out D-Sub connector for DIO 8 bit 3-Pin Terminal Block for DC In x 1 Reset Button x 1 Power Button with LED x 1
Expansion	M.2 2280 M-Key x 1 (PCIe [x2]) M.2 2230 E-Key x 1 (for Wi-Fi) M.2 3052 B-Key x 1 (for 5G/LTE) SIM Slot x 1
Indicator	Sys LED Storage active LED
OS support	Windows® 10 IoT Enterprise Windows® 11 IoT Enterprise Windows® 11 PRO Linux Ubuntu 22.04
Power Supply	
Power Requirement	DC-in 9-36V x 1 for 3-Pin Terminal Block
Mechanical	
Mounting	Wallmount (default), DIN Rail (mounting clip optional)
Dimensions (W x H x D)	8.42" x 4.54" x 2.59" (214mm x 115.5mm x 65.8mm) without brackets
Gross Weight	6.17 lb (2.8Kg)
Net Weight	4.4 lb (2Kg)
Environmental	
Operating Temperature	-4°F ~ 158°F (-20°C ~ 70°C), according to IEC68-2 with 0.5 m/s AirFlow (w/ Industrial wide Temp. SSD/RAM)
Storage Temperature	-40°F ~ 176°F (-40°C ~ 80°C)
Storage Humidity	5 ~ 95% @ 40°C, non-condensing
Anti-Vibration	3 Grms/ 5 ~ 500Hz/ operation (with SSD)
Anti-Shock	50G, IEC 68-2-27, half sine, 11 ms duration (with SSD)
Certification	CE/FCC Class A



Dimension

Unit: mm

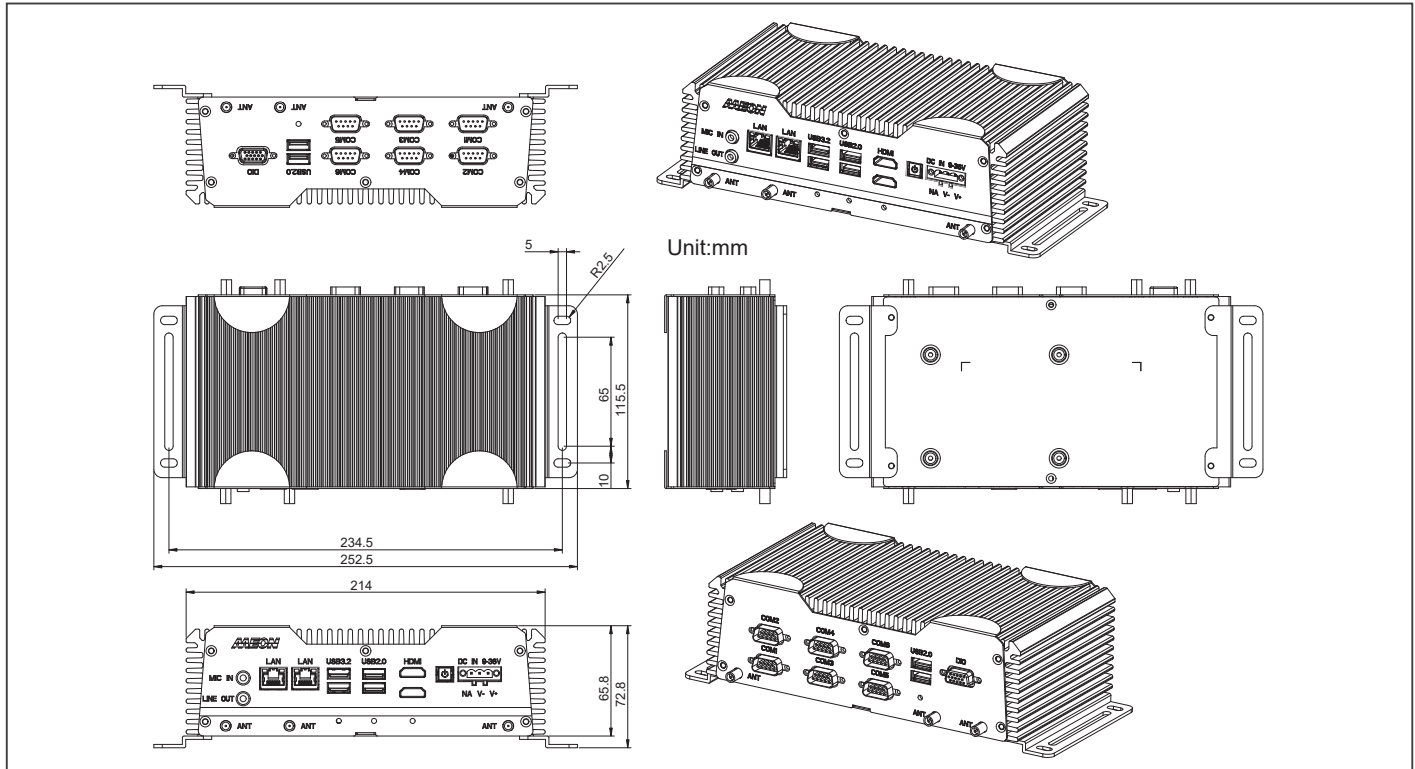

Ordering Information

Part Number	CPU	LAN	PCH	USB 3.2 Gen 2	USB 2.0	RS-232/422/485	Storage	Display	Expansion	Mounting	Power	Operation Temp.
BOXER-6617-ADN-A1-1010	Intel® Processor N50	2	Intel SoC	2	4	6	M.2 2280 M Key Slot x1 (PCIe x2) 2.5" SATA Drive Bay x 1	HDMI x2	M.2 2280 M-Key x 1 (PCIe x2) M.2 2230 E-Key x 1 M.2 3052 B-Key x 1 SIM Slot	Wallmount	9~36V DC in	-4°F ~ 158°F (-20°C ~ 70°C), according to IEC68-2 with 0.5 m/s AirFlow (w/ Industrial wide Temp. SSD/RAM)
BOXER-6617-ADN-A2-1010	Intel® Processor N97	2	Intel SoC	2	4	6	M.2 2280 M Key Slot x1 (PCIe x2) 2.5" SATA Drive Bay x 1	HDMI x2	M.2 2280 M-Key x 1 (PCIe x2) M.2 2230 E-Key x 1 M.2 3052 B-Key x 1 SIM Slot	Wallmount	9~36V DC in	-4°F ~ 158°F (-20°C ~ 70°C), according to IEC68-2 with 0.5 m/s AirFlow (w/ Industrial wide Temp. SSD/RAM)
BOXER-6617-ADN-A3-1010	Intel® Core™ i3-N305	2	Intel SoC	2	4	6	M.2 2280 M Key Slot x1 (PCIe x2) 2.5" SATA Drive Bay x 1	HDMI x2	M.2 2280 M-Key x 1 (PCIe x2) M.2 2230 E-Key x 1 M.2 3052 B-Key x 1 SIM Slot	Wallmount	9~36V DC in	-4°F ~ 158°F (-20°C ~ 70°C), according to IEC68-2 with 0.5 m/s AirFlow (w/ Industrial wide Temp. SSD/RAM)
BOXER-6617-ADN-A4-1010	Intel Atom® x7211E	2	Intel SoC	2	4	6	M.2 2280 M Key Slot x1 (PCIe x2) 2.5" SATA Drive Bay x 1	HDMI x2	M.2 2280 M-Key x 1 (PCIe x2) M.2 2230 E-Key x 1 M.2 3052 B-Key x 1 SIM Slot	Wallmount	9~36V DC in	-4°F ~ 158°F (-20°C ~ 70°C), according to IEC68-2 with 0.5 m/s AirFlow (w/ Industrial wide Temp. SSD/RAM)

Packing List

- Wallmount Bracket x 2
- Screw Package x 1
- 3 Pin DC-In Power Connector x 1
- BOXER-6617-ADN

Optional Accessories

- 1255900849
12V 84W Power Adapter
- 170X000799
Power Cord (US Type)
- 170X001024
Power Cord (Europe)
- 170X000803
Power Cord (Japan)
- 9741640404
Din Rail Mounting kit

BOXER-6617-ASL

Fanless Compact Embedded Computer with Intel Atom® Processor X-series (formerly Amston Lake)

Front View

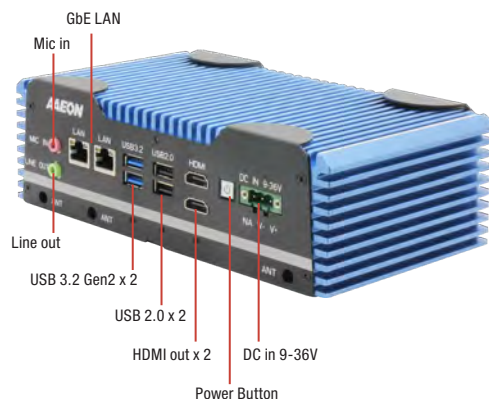

Rear View

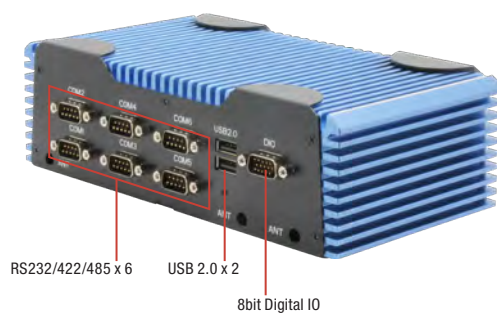

Features

- Intel Atom® Processor X-series (formerly Amston Lake)
- DDR5 4800MHz SODIMM x 1
- 2.5GbE x 2
- M.2 2280 M-Key/M.2 2230 E-Key
- M.2 3052 B-Key for 5G
- SuperSpeed+ USB 3.2 Gen 2
- Onboard TPM 2.0
- Wide Range 9 ~ 36V DC input
- Super Wide Operating Temperature -20~70°C
- Hailo-8™ M.2 2280 AI Accelerator Module Support (Optional)
- Industrial-class CPU for 24/7 operation



Specifications

System	
CPU	Intel® Processor N50 Intel® Processor N97 Intel® Core™ i3-N305 Intel Atom® x7211E Intel Atom® x7835RE Intel Atom® x7433RE Intel Atom® x7211RE
Chipset	Intel® SoC
System Memory	DDR5 4800MHz SODIMM x 1, up to 32GB
Display Interface	HDMI x 2
Storage Device	M.2 2280 M-Key x 1 (PCIe [x2]) 2.5" SATA HDD/SSD x 1
Ethernet	RJ-45 x 2 for 2.5GbE LAN (Intel® I226)
I/O	HDMI x 2 RJ-45 x 2 for 2.5GbE LAN (Intel® I226) USB 3.2 Gen 2 x 2 (Type-A) USB 2.0 x 4 (Type-A) DB-9 x 6 for RS-232/422/485 Mic-in/Line-out D-Sub connector for DIO 8 bit 3-Pin Terminal Block for DC In x 1 Reset Button x 1 Power Button with LED x 1
Expansion	M.2 2280 M-Key x 1 (PCIe [x2]) M.2 2230 E-Key x 1 (for Wi-Fi) M.2 3052 B-Key x 1 (for 5G/LTE) SIM Slot x 1
Indicator	Sys LED Storage active LED
OS support	Windows® 10 IoT Enterprise Windows® 11 IoT Enterprise Windows® 11 PRO Linux Ubuntu 22.04
Power Supply	
Power Requirement	DC-in 9-36V x 1 for 3-Pin Terminal Block
Mechanical	
Mounting	Wallmount (default), DIN Rail (mounting clip optional)
Dimensions (W x H x D)	8.42" x 4.54" x 2.59" (214mm x 115.5mm x 65.8mm) without brackets
Gross Weight	6.17 lb (2.8Kg)
Net Weight	4.4 lb (2Kg)
Environmental	
Operating Temperature	-4°F ~ 158°F (-20°C ~ 70°C), according to IEC68-2 with 0.5 m/s AirFlow (w/ Industrial wide Temp. SSD/RAM)
Storage Temperature	-40°F ~ 176°F (-40°C ~ 80°C)
Storage Humidity	5 ~ 95% @ 40°C, non-condensing
Anti-Vibration	3 Grms/ 5 ~ 500Hz/ operation (with SSD)
Anti-Shock	50G, IEC 68-2-27, half sine, 11 ms duration (with SSD)
Certification	CE/FCC Class A



Dimension

Unit: mm

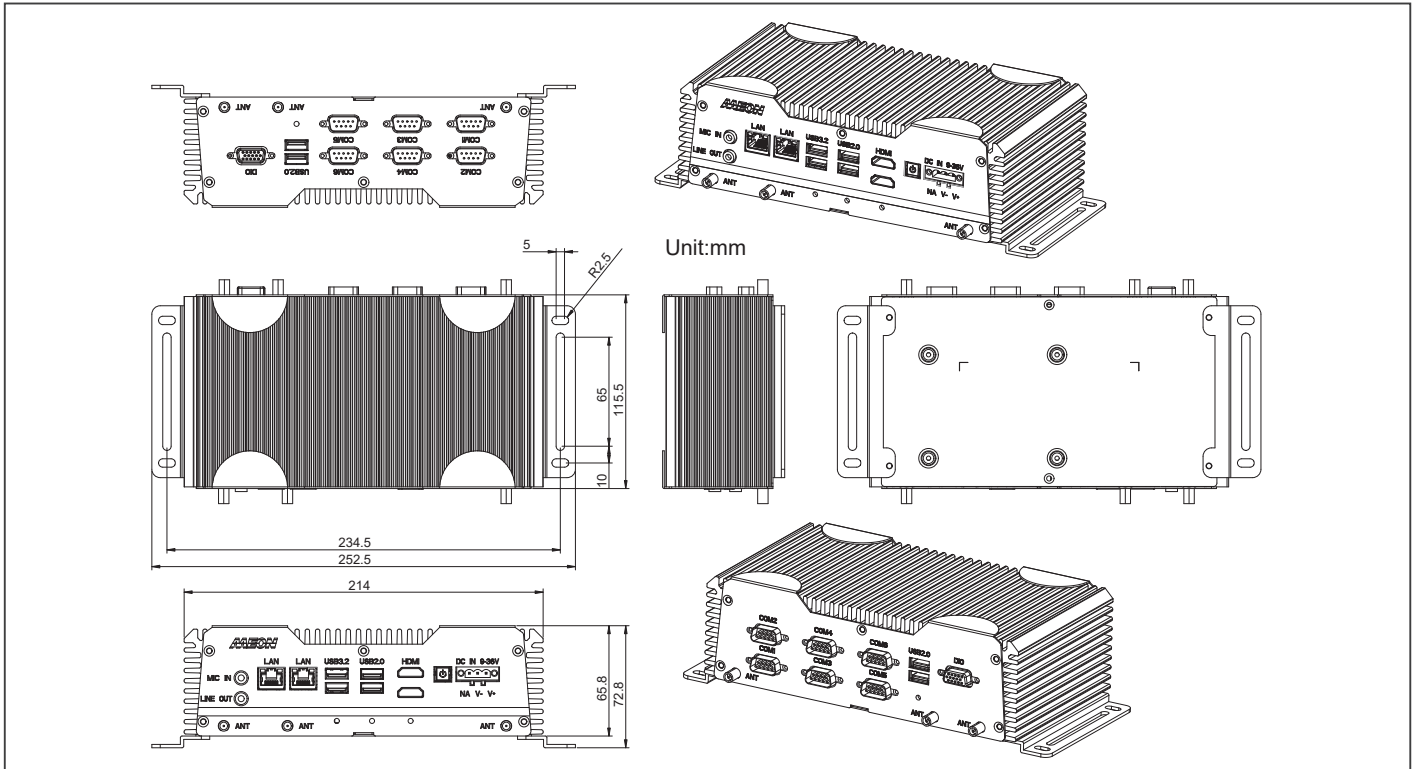

Ordering Information

Part Number	CPU	LAN	PCH	USB 3.2 Gen 2	USB 2.0	RS-232/422/485	Storage	Display	Expansion	Mounting	Power	Operation Temp.
BOXER-6617-ASL-A1-1010	Intel Atom® x7835RE	2	Intel SoC	2	4	6	M.2 2280 M Key Slot x1 (PCIe x2) 2.5" SATA Drive Bay x1	HDMI x2	M.2 2280 M-Key x1 (PCIe [x2]) M.2 2230 E-Key x1 M.2 3052 B-Key x1 SIM Slot	Wallmount	9~36V DC in	-4°F ~ 158°F (-20°C ~ 70°C), according to IEC68-2 with 0.5 m/s AirFlow (w/ Industrial wide Temp. SSD/RAM)
BOXER-6617-ASL-A2-1010	Intel Atom® x7433RE	2	Intel SoC	2	4	6	M.2 2280 M Key Slot x1 (PCIe x2) 2.5" SATA Drive Bay x1	HDMI x2	M.2 2280 M-Key x1 (PCIe [x2]) M.2 2230 E-Key x1 M.2 3052 B-Key x1 SIM Slot	Wallmount	9~36V DC in	-4°F ~ 158°F (-20°C ~ 70°C), according to IEC68-2 with 0.5 m/s AirFlow (w/ Industrial wide Temp. SSD/RAM)
BOXER-6617-ASL-A3-1010	Intel Atom® x7211RE	2	Intel SoC	2	4	6	M.2 2280 M Key Slot x1 (PCIe x2) 2.5" SATA Drive Bay x1	HDMI x2	M.2 2280 M-Key x1 (PCIe [x2]) M.2 2230 E-Key x1 M.2 3052 B-Key x1 SIM Slot	Wallmount	9~36V DC in	-4°F ~ 158°F (-20°C ~ 70°C), according to IEC68-2 with 0.5 m/s AirFlow (w/ Industrial wide Temp. SSD/RAM)

Optional Accessories

- **1255900849**
12V 84W Power Adapter
- **170X000799**
Power Cord (US Type)
- **170X001024**
Power Cord (Europe)
- **170X000803**
Power Cord (Japan)
- **9741640404**
Din Rail Mounting kit

Packing List

- Wallmount Bracket x 2
- Screw Package x 1
- 3 Pin DC-In Power Connector x 1
- BOXER-6617-ASL

BOXER-6619-TWL PRELIMINARY

Fanless Compact Embedded Computer with Intel® Processor Core™ 3 & N Series



Front View

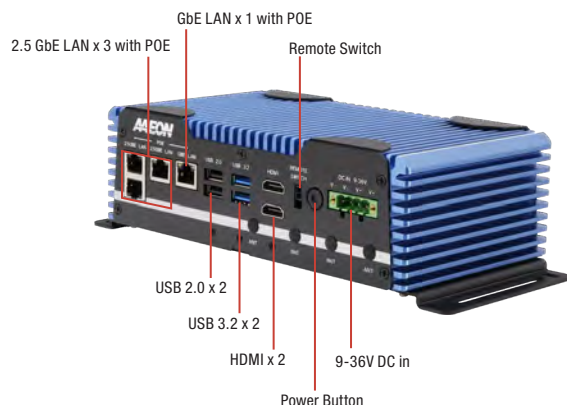

Rear View



Features

- Intel® Processor Core™ 3 & N Series (Formerly Twin Lake)
- DDR5 SODIMM up to 32GB
- Triple display with 1x VGA & 2x HDMI
- Support LAN x 4 with IEEE 802.3 at/af PoE (Total 80W)
- Wide Range 9~36V DC input with protection circuit
- Wide Operating Temperature -20~60°C
- Optional Out-of-Band support
- TPM 2.0 onboard



Specifications

System	
CPU	Intel® Processor Core™ 3 & N Series (formerly Twin Lake): N150 (4 cores/4 threads), TDP 6W Core™ 3 N355 (8 cores/5 threads), TDP 15W
Chipset	Intel® SoC
System Memory	DDR5 SODIMM slot x 1, up to 32GB
Display Interface	VGA x 1 (DB-15) HDMI x 2
Storage Device	Internal 2.5" SATA Drive Bay x 1
Ethernet	RJ-45 for 2.5GbE LAN x 3 (Intel® i226-LM) RJ-45 for GbE LAN x 1 (Intel® i210-IT)
I/O	IEEE 802.3 at/af PoE x 4 (total 80W, note: the system only supports total 20W PoE when input voltage is at or below 10V.) Type-A USB3.2 Gen1 x 2 Type-A USB2.0 x 2 DB-9 for RS-232/422/485 x 6 Mic in / Line out x 1 DB-15 for DIO 8bit x 1 2-pin remote power switch x 1 Power button with LED indicator x 1
Expansion	M.2 E key 2230 x 1 (PCIe [x1], USB 2.0) M.2 B Key 3052 x 1 (USB3.2) Nano SIM slot x 1
Indicator	—
OS support	Windows® 11 IoT LTSC Ubuntu 24.04 above
Power Supply	
Power Requirement	DC-in 9~36V 4-pin Terminal block connector With protection circuit
Mechanical	
Mounting	Wallmount (Optional, Din Rail mount)
Dimensions (W x H x D)	214 x 116 x 65mm (without brackets)
Gross Weight	6.2 lb (2.8 kg)
Net Weight	4.4 lb (2 kg)
Environmental	
Operating Temperature	-4°F ~140°F (-20°C ~ 60°C) with 0.7 m/s airflow (with wide temp. memory/storage)
Storage Temperature	-40°F ~ 176°F (-40°C ~ 80°C)
Storage Humidity	5 ~ 95% @ 40°C, non-condensing
Anti-Vibration	With SSD: Random, 3Grms, 5~500Hz
Anti-Shock	With SSD: 50G @ wallmount, half-sine, 11ms
Certification	CE/FCC class A





Dimension

Unit: mm

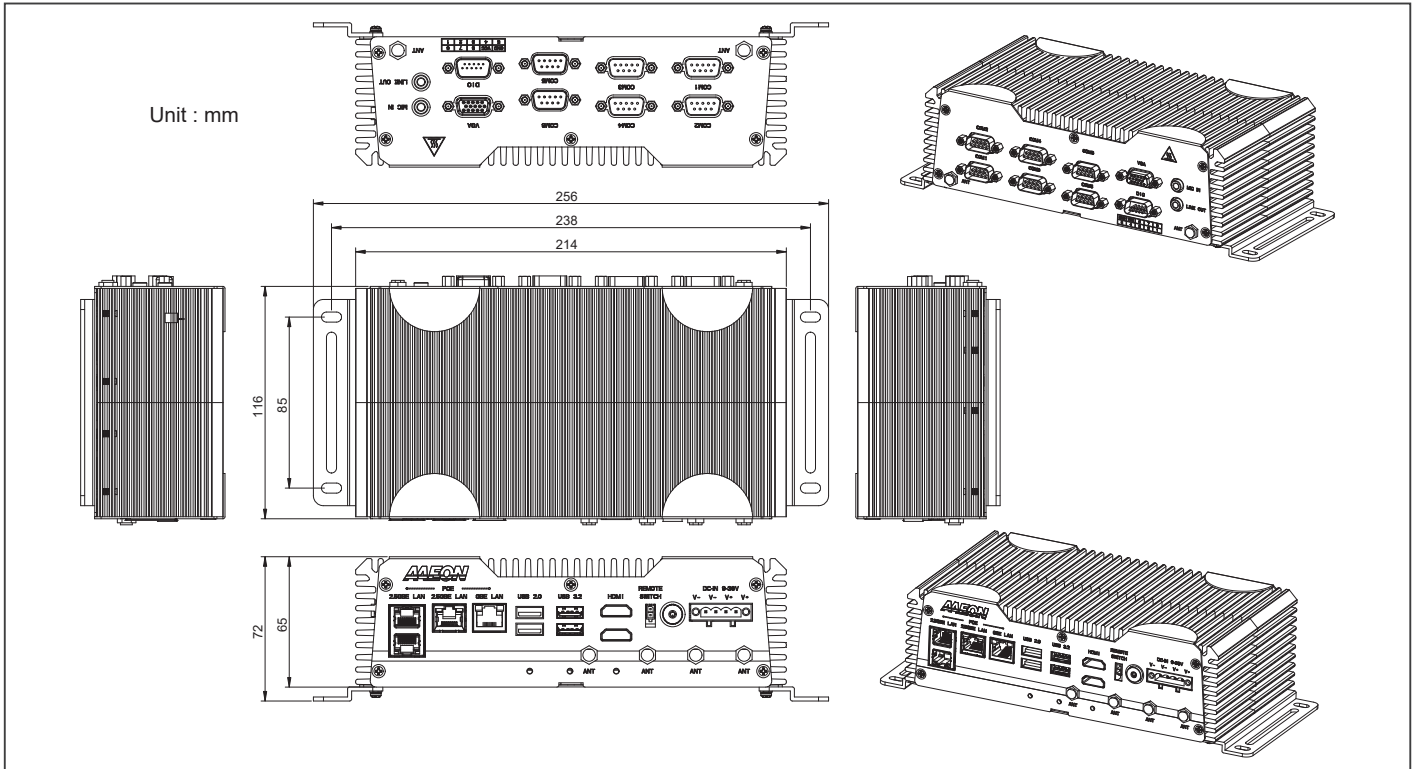

Ordering Information

Part Number	CPU	PCH	LAN	USB3.0	USB2.0	RS-232/422/485	Digital I/O	Audio	Storage	Display	Expansion	Mounting	Power	Operation Temp
BOXER-6619-TWL-A1-1010	Intel® Processor N150	SoC	GbE × 1 2.5 GbE × 3 (support IEEE802.3 at/af total 80W)	2	2	6	8	Mic in Line out	2.5" SATA-III Drive Bay x1	HDMI x 2 VGA x 1	M.2 E-Key x 1 (PCIe [x1]), USB 2.0 M.2 B Key x 1 (USB 3.2) Nano SIM Slot x 1	Wallmount, DIN Rail (optional)	9~36V DC in	4°F~113°F (-20°C~60°C) with 0.7 m/s airflow with wide temp.memory/storage
BOXER-6619-TWL-A2-1010	Intel® Core™ 3 Processor N355	SoC	GbE × 1 2.5 GbE × 3 (support IEEE802.3 at/af total 80W)	2	2	6	8	Mic in Line out	2.5" SATA-III Drive Bay x1	HDMI x 2 VGA x 1	M.2 E-Key x 1 (PCIe [x1]), USB 2.0 M.2 B Key x 1 (USB 3.2) Nano SIM Slot x 1	Wallmount, DIN Rail (optional)	9~36V DC in	4°F~113°F (-20°C~60°C) with 0.7 m/s airflow with wide temp.memory/storage

Optional Accessories

- **1255X00112**
180W Power Adapter
- **170X000799**
Power Cord (US Type)
- **170X001024**
Power Cord (Europe)
- **170X000803**
Power Cord (Japan)

Packing List

- **BOXER-6619-TWL x 1**
- **4-pin Terminal Block conntecor x 1 (for DC input)**
- **Screw Pack x 1**
- **Wallmount Kit x 1**
- **Remote Power On/Off connector x 1**

BOXER-6641

Fanless Embedded Box PC with Socket Type 8th Generation Intel® Processor

BOXER-6641-A1/A5-1010 (H310)

Front View

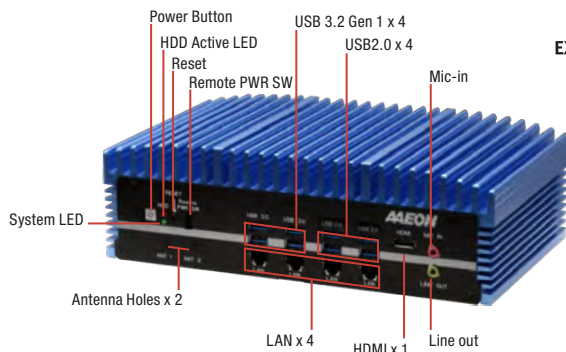

Rear View



BOXER-6641-A2/A6-1010 (C246)

Front View

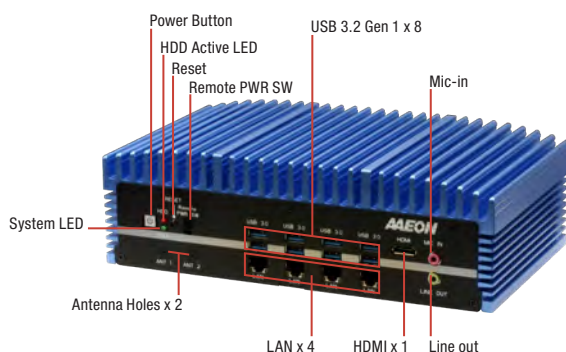

Rear View



Features

- Extreme Computing Power & Graphic Display Capability
- Desktop Grade Socket Type Core™ - i3/i5/i7/i9 Processor for A1 & A5 model (max. TDP up to 65W)
- Desktop Grade Socket Type Core™ - i3/i5/i7/i9/Xeon® Processor for A2 & A6 model (max. TDP up to 71W)
- Supports DDR4 ECC or Non-ECC SODIMM, Up to 64GB
- Supports Intel® GbE LAN x 4 (i211 x 3 + i219 x 1)
- Supports Intel® AMT (A2 & A6 Model)
- Supports HDMI x 2 Dual Display
- Supports USB 3.2 Gen 1 x 8 (A2 & A6 model)
- Supports BIOS Selectable RS-232/422/485 x 6
- Wide Range DC 10~35V Input



Specifications

System	
CPU	Intel® Xeon® E-2124G (for A2 & A6 model only) Intel® i9-9900T Intel® i7-9700TE Intel® i7-8700T Intel® i5-8500T Intel® i3-8100T Pentium® G5400T Celeron® G4900T
Chipset	Intel® C246/H310
System Memory	DDR4-2666 SODIMM slot x 2, Up to 64GB, ECC or Non-ECC Support
Display Interface	HDMI x 2
Storage Device	2.5" SATA HDD/SSD Bay x 1 (x 2 for A5 & A6 model, A6 supports RAID 0/1)
Ethernet	Intel® i211 x 3, i219 x 1
I/O	HDMI x 2 RJ-45 x 4 for GbE LAN (i211 x 3, i219 x 1) USB 3.2 Gen 1 x 4, USB 2.0 x 4 (A1 & A5 model) USB 3.2 Gen 1 x 8 (A2 & A6 model) DB-9 x 6 for RS-232/422/485 Audio x 1 (MIC-in, Line-out) 3 pin 10~35V Power Input x 1 Power Button x 1 Remote Power switch x 1 Reset Button x 1 HDD LED x 1 SYS LED x 1
Expansion	Full-size Mini PCIe x 1 Full-size Mini PCIe x 1 (PCIe/mSATA switch by BIOS, Default: mSATA) SIM slot x 1
Indicator	HDD LED x 1 SYS LED x 1
OS Support	Windows® 10 64-bit Linux Ubuntu 20.04
Power Supply	
Power Requirement	3-pin DC Input 10~35V
Mechanical	
Mounting	Wallmount
Dimensions (W x H x D)	10.4" x 3.19" x 6.15" (264.2mm x 80.92mm x 156.2mm)
Gross Weight	10.4 lb (4.7 Kg)
Net Weight	8.2 lb (3.7 Kg)
Environmental	
Operating Temperature	-4°F ~ 131°F (-20°C ~ 55°C) with 0.5 m/s airflow – with TDP ≤ 35W CPU -4°F ~ 113°F (-20°C ~ 45°C) with 0.5 m/s airflow – with TDP >35W CPU
Storage Temperature	-40°F ~ 176°F (-40°C ~ 80°C)
Storage Humidity	5 ~ 95% @ 40°C, non-condensing
Anti-Vibration	2 Grms/ 5 ~ 500Hz/ operation – SSD/mSATA 1 Grms/ 5 ~ 500Hz/ operation – HDD
Anti-Shock	—





Dimension

Unit: mm

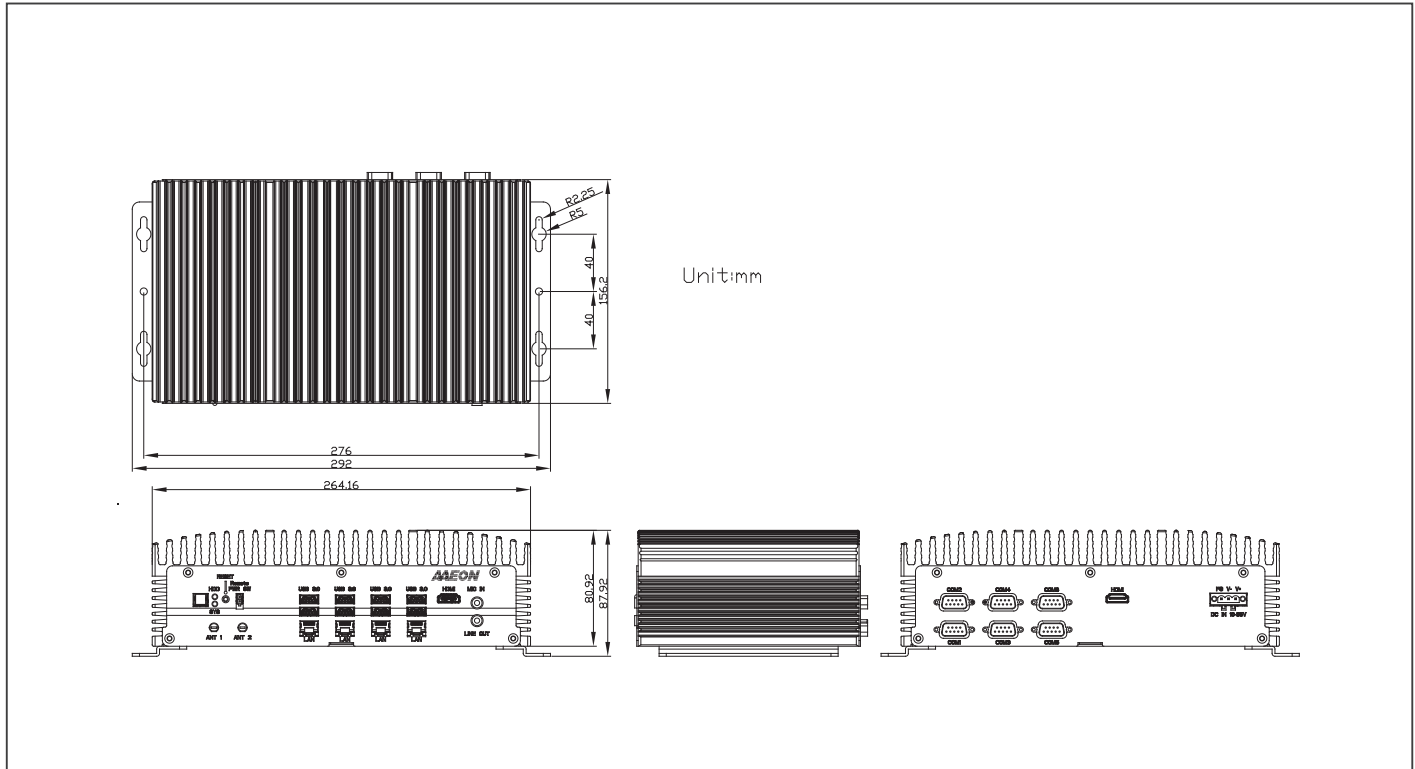

Ordering Information

Part Number	LAN	USB 3.2 Gen 1	USB 2.0	RS-232	RS-232/422/485	Audio	Storage	Display	Expansion	Mounting	Power	Operation temp.
BOXER-6641-A1-1210(H310)	4	4	4	—	RS-232/422/485 x 6	Mic-in Line-out	Internal 2.5" SATA Drive bay x 1	HDMI x 2	Full-size Mini-Card x 2 SIM x 1	Wallmount	10~35V	-4°F ~ 131°F (-20°C ~ 55°C) with 0.5 m/s airflow – with TDP ≤ 35W CPU -4°F ~ 113°F (-20°C ~ 45°C) with 0.5 m/s airflow – with TDP >35W CPU
BOXER-6641-A2-1210(C246)	4	8	—	—	RS-232/422/485 x 6	Mic-in Line-out	Internal 2.5" SATA Drive bay x 1	HDMI x 2	Full-size Mini-Card x 2 SIM x 1	Wallmount	10~35V	-4°F ~ 131°F (-20°C ~ 55°C) with 0.5 m/s airflow – with TDP ≤ 35W CPU -4°F ~ 113°F (-20°C ~ 45°C) with 0.5 m/s airflow – with TDP >35W CPU
BOXER-6641-A5-1210(H310)	4	4	4	—	RS-232/422/485 x 6	Mic-in Line-out	Internal 2.5" SATA Drive bay x 2	HDMI x 2	Full-size Mini-Card x 2 SIM x 1	Wallmount	10~35V	-4°F ~ 131°F (-20°C ~ 55°C) with 0.5 m/s airflow – with TDP ≤ 35W CPU -4°F ~ 113°F (-20°C ~ 45°C) with 0.5 m/s airflow – with TDP >35W CPU
BOXER-6641-A6-1210(C246)	4	8	—	—	RS-232/422/485 x 6	Mic-in Line-out	Internal 2.5" SATA Drive bay x 2 (RAID 0/1)	HDMI x 2	Full-size Mini-Card x 2 SIM x 1	Wallmount	10~35V	-4°F ~ 131°F (-20°C ~ 55°C) with 0.5 m/s airflow – with TDP ≤ 35W CPU -4°F ~ 113°F (-20°C ~ 45°C) with 0.5 m/s airflow – with TDP >35W CPU

Packing List

- Wallmount Bracket x 2
- 3 Pin DC-In Power Connector x 1
- Screw Package x 1
- BOXER-6641

Optional Accessories

- **1255X00059**
120W Power Adapter (Recommend for 35W CPU)
- **1255302300**
230W Power Adapter (Recommend for >35W CPU)
- **170X000799**
Power Cord (US Type)
- **170X000800**
Power Cord (Europe)
- **170X000803**
Power Cord (Japan)

BOXER-6641-PRO

Fanless Embedded Box PC with Socket Type 8th/9th Generation Intel® Processor

Front View



Rear View



Features

- Wide Operating Temperature -40~70°C with “Graphene” Chassis for Extreme Computing Power & Graphic Display Capability
- Desktop Grade Socket Type Core™ - i3/i5/i7 Processor (CPU TDP 35W)
- Supports DDR4 ECC or Non-ECC SODIMM, Up to 64GB
- Supports HDMI x 2 Dual Display
- Supports Intel® GbE LAN x 4 (i211 x 3 + i219 x 1)
- Supports Intel® AMT (A2 Model)
- Supports RAID 0/1 Function (A2 Model)
- Wide Range DC 10~35V Input



Specifications

System	
CPU	Intel® i7-9700TE Intel® i7-8700T Intel® i5-8500T Intel® i3-8100T Pentium® G5400T Celeron® G4900T
Chipset	Intel® C246/H310
System Memory	DDR4-2666 SODIMM slot x 2, Up to 64GB, ECC or Non-ECC Support
Display Interface	HDMI x 2
Storage Device	2.5" SATA HDD/SSD Bay x 2
Ethernet	Intel® i211 x 3, i219 x 1
I/O	HDMI x 2 RJ-45 x 4 for GbE LAN (i211 x 3, i219 x 1) USB 3.2 Gen 1 x 4, USB2.0 x 4 (A1 model) USB 3.2 Gen 1 x 8 (A2 model) DB-9 x 6 for RS-232/422/485 10 pin Terminal Block for 8-bit DIO Audio x 1 (MIC-in, Line-out) 3 pin 10~35V Power Input x 1 Power Button x 1 Remote Power switch x 1 Reset Button x 1
Expansion	Full-size Mini PCIe x 1 Full-size Mini Card x 1 (PCIe/mSATA switch by BIOS, Default: mSATA) SIM slot x 1
Indicator	HDD LED x 1 SYS LED x 1
OS support	Windows® 10 64-bit Linux Ubuntu 20.04.2
Power Supply	
Power Requirement	3-pin DC Input 10~35V
Mechanical	
Mounting	Wallmount kit
Dimensions (W x H x D)	10.4" x 3.19" x 6.15" (264.2mm x 80.92mm x 156.2mm)
Gross Weight	10.4 lb (4.7 Kg)
Net Weight	8.2 lb (3.7 Kg)
Environmental	
Operating Temperature	-40°F ~ 158°F (-40°C ~ 70°C), according to IEC68-2-14 with 0.5 m/s AirFlow
Storage Temperature	-40°C ~ 80°C
Storage Humidity	5 ~ 95% @ 40C, non-condensing
Anti-Vibration	2 Grms/ 5 ~ 500Hz/ operation (with SSD)
Anti-Shock	—
Certification	CE/FCC class A





Dimension

Unit: mm

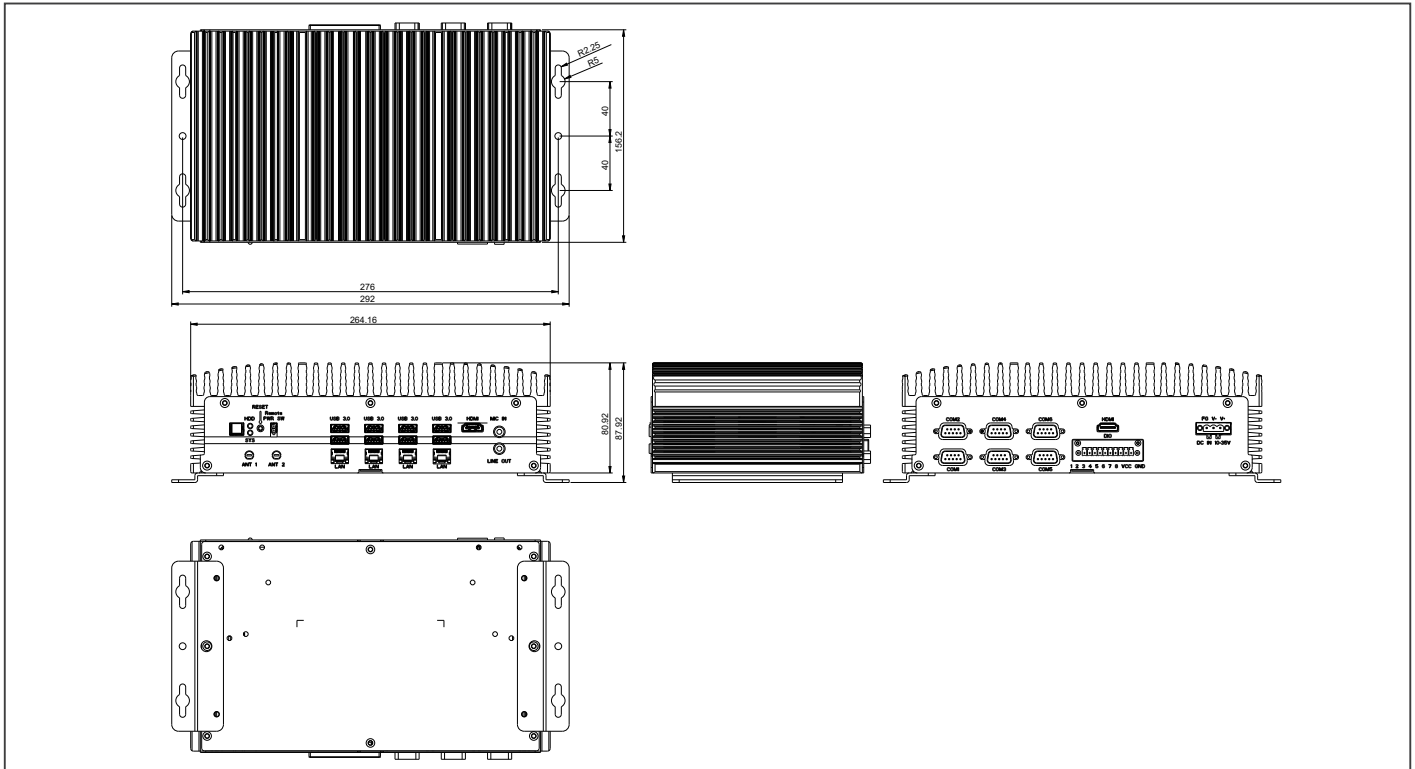

Ordering Information

Part Number	Chipset	LAN	USB 3.2 Gen 1	USB 2.0	DIO	RS-232/422/485	Audio	Storage	Display	Expansion	Mounting	Power	Operation temp.
BOXER-6641-PRO-A1-1010	H310	4	4	4	8bit	6	Mic-in Line-out	Internal 2.5" SATA Drive bay x 2	HDMI x 2	Full-size Mini-Card x 2 SIM x 1	Wallmount	10~35V	-40°F ~ 158°F (-40°C ~ 70°C), according to IEC68-2-14 with 0.5 m/s AirFlow
BOXER-6641-PRO-A2-1010	C246	4	8	—	8bit	6	Mic-in Line-out	Internal 2.5" SATA Drive bay x 2	HDMI x 2	Full-size Mini-Card x 2 SIM x 1	Wallmount	10~35V	-40°F ~ 158°F (-40°C ~ 70°C), according to IEC68-2-14 with 0.5 m/s AirFlow

Packing List

- Wallmount Bracket x 2
- 3 Pin DC-in Power Connector x 1
- 10 pin DIO Connector x 1
- Screw Package x 1
- BOXER-6641-PRO

Optional Accessories

- **125590120B**
120W Power Adapter
- **170X000799**
Power Cord (US)
- **170X000800**
Power Cord (EU)
- **170X000803**
Power Cord (JP)

BOXER-6642-CML

Fanless Embedded Box PC with Socket Type 10th Generation Intel® Core™ Processor

Front View

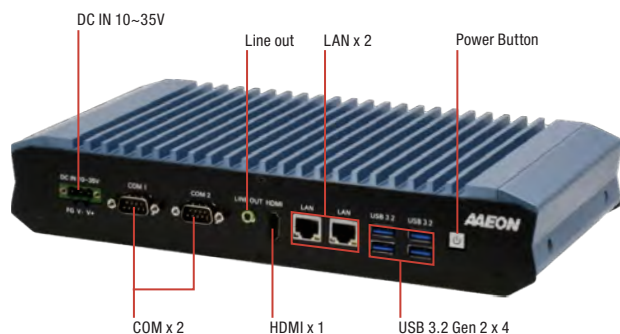

Rear View



Features

- Extreme Computing Power & Graphic Display Capability
- DDR4 slot x 2, up to 64GB
- Support High Speed NVMe storage (M.2 2280)
- GbE LAN x 2, RS232/422/485 x 4
- Supports Intel® AMT
- Supports TPM 2.0
- Wide Range 10-35V DC input
- Wide Range 0 ~ 45°C Operating Temperature



Specifications

System	
CPU	Intel® Core™ i9-10900TE Intel® Core™ i7-10700TE Intel® Core™ i5-10500TE Intel® Core™ i3-10100TE Intel® Celeron® G5900TE
Chipset	Intel® Q470E
System Memory	DDR4 SODIMM x 2, up to 64GB
Display Interface	HDMI 1.4 x 1
Storage Device	M.2 2280 slot x 1 (PCIe x4), 2.5" SATA SSD/HDD bay x 1
Ethernet	Intel® i211-AT x 1, i219-LM x 1
I/O	HDMI x 1 RJ-45 x 2 for GbE LAN (i211-AT x 1, i219-LM x 1) USB 3.2 Gen 2 x 4 USB 2.0 x 2 DB-9 x 4 for RS-232/422/485 DB15 x 1 for 8 channel DIO Line out x 1 3 pin 10-35V Power Input x 1 Power Button with LED x 1
Expansion	M.2 2230 E Key x 1 M.2 2280 M Key x 1 Full-Size Mini Card x1 (mSATA/PCIe switch by BIOS, default PCIe) SIM x 1
Indicator	Power LED
OS Support	Windows® 10 IoT Enterprise 64-bit Linux Ubuntu 20.04.2
Power Supply	
Power Requirement	10-35V DC-in with 3-pin terminal block
Mechanical	
Mounting	Wallmount
Dimensions (W x H x D)	11.58" x 5.98" x 2.11" (292.4mm x 152mm x 53.5mm)
Gross Weight	8.4lb (3.8Kg)
Net Weight	6.2lb (2.8Kg)
Environmental	
Operating Temperature	32°F ~ 113°F (0°C ~ 45°C) (35W CPU), according to IEC68-2-14 with 0.5 m/s AirFlow
Storage Temperature	-40°F ~ 176°F (-40°C ~ 80°C)
Storage Humidity	5 ~ 95% @ 40°C, non-condensing
Anti-Vibration	2 Grms/5 ~ 500Hz/operation (with SSD)
Anti-Shock	50G peak acceleration (11msec) (with SSD)
Certification	CE/FCC class A





Dimension

Unit: mm

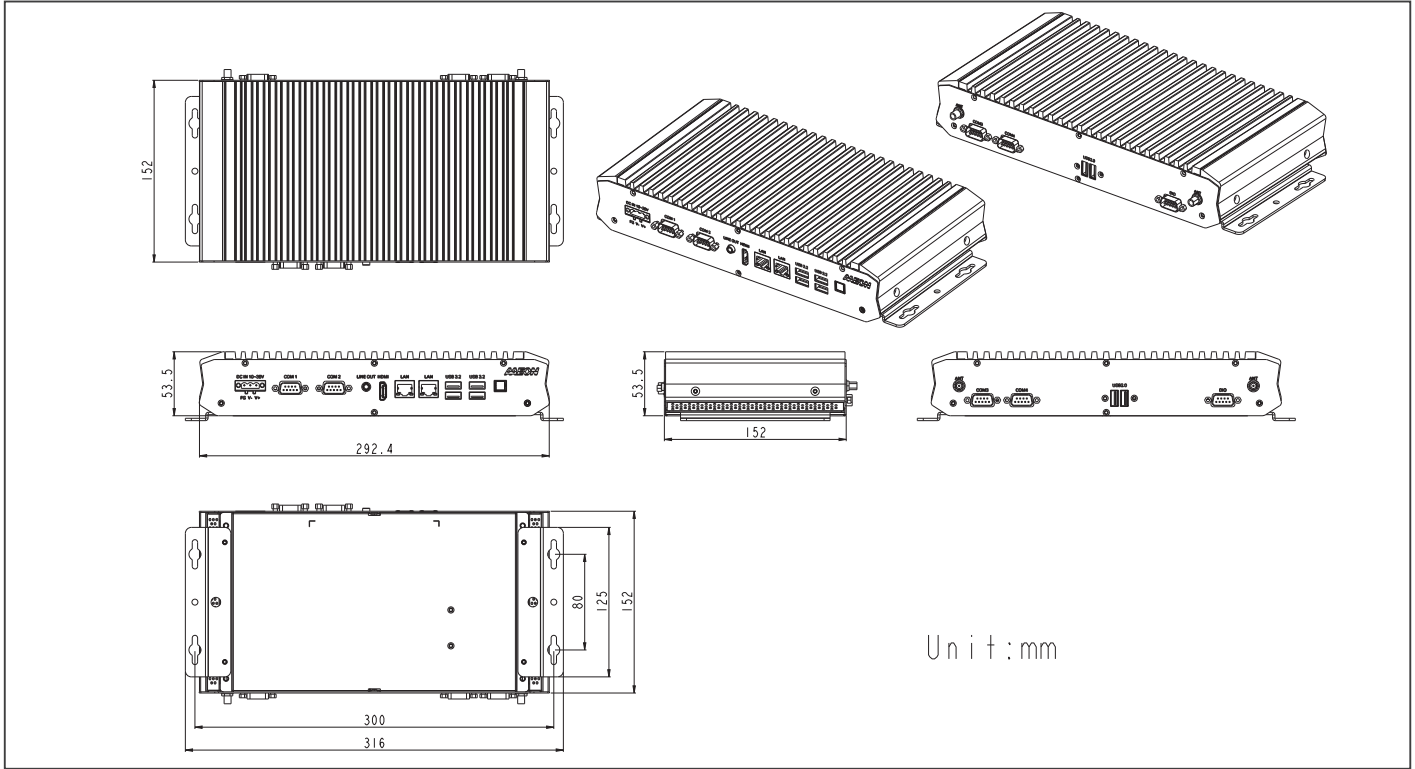

Ordering Information

Part Number	LAN	PCH	USB 3.2 Gen 2	USB 2.0	RS-232/422/485	Storage	Display	Expansion	Mounting	Power	Operation temp.
BOXER-6642-CML-A1-1010	2	Q470E	4	2	4	M.2 2280 M Key x 1 2.5" HDD/SSD Bay x 1	HDMI x 1	M.2 2230 E Key x 1 Full-Size Mini Card x 1	Wallmount kit	10-35V DC-in	0°C ~ 45°C with 0.5m/s airflow

Packing List

- Wallmount Bracket x 2
- 3 Pin DC-in Power Connector x 1
- Screw Package x 1
- BOXER-6642-CML x 1

Optional Accessories

- **1255X00059**
120W Power Adapter
- **1255302300**
230W Power Adapter
- **170X000799**
Power Cord (US Type)
- **170X000800**
Power Cord (Europe)
- **170X000803**
Power Cord (Japan)

BOXER-6643-TGU

Fanless Embedded Box PC 11th Generation Intel® Core™ SoC Processor

Front View

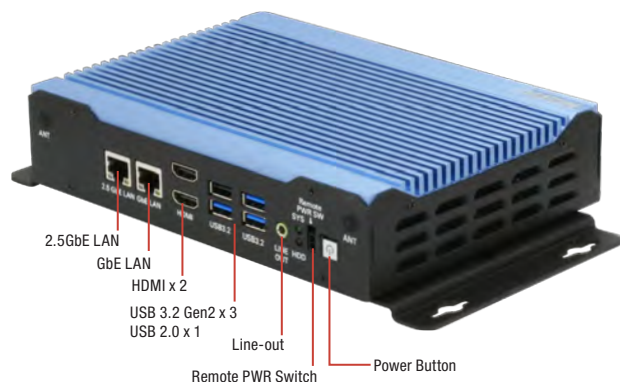

Rear View

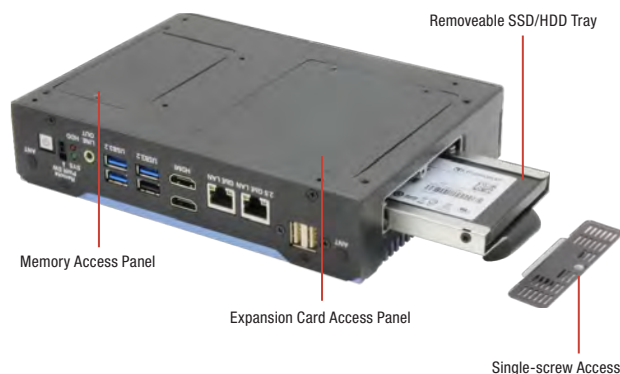
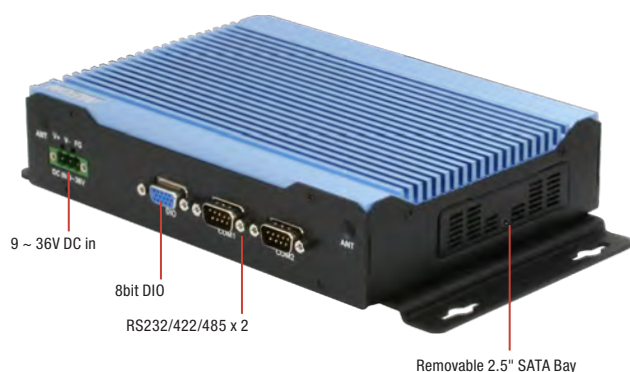

Features

- Extreme Computing Power with Intel® SoC Processor
- DDR4 slot x2, up to 64GB
- TPM 2.0 onboard
- Supports High Speed NVMe storage (M.2 2280)
- GbE LAN x 1 (Intel I219) + 2.5GbE LAN x 1 (Intel I225)
- Supports M.2 3052 B Key for 5G module
- Wide Range 9-36V DC input
- Wide Range -20~60 °C Operating Temperature



Specifications

System	
CPU	Intel® Core™ i7-1185G7E Intel® Core™ i5-1145G7E Intel® Core™ i3-1115G4E
Chipset	Intel® SoC
System Memory	DDR4 3200MHz SODIMM x 2, max 64GB
Display Interface	HDMI 2.0 x 2
Storage Device	M.2 2280 M Key NVMe Slot x1 (PCIex4) 2.5" SATA Drive Bay x1
Ethernet	RJ-45 x 2 for 1G/2.5GbE LAN (i219x1, i225x1)
I/O	HDMI 2.0 x 2 RJ-45 x 2 for 1G/2.5GbE LAN (i219 x 1, i225 x 1) USB Type-A x3 for USB3.2 Gen2 USB Type-A x1 for USB 2.0 DB-9 x 2 for RS-232/422/485 DB15 x1 Male for Digital I/O 8-channel Line out x 1 3 pin 9-36V Power Input x 1 Power Button with LED x 1
Expansion	M.2 3052 B Key x 1 (for 5G module) Full-Size Minicard x1 (PCIe + USB / SATA, Default PCIe + USB) SIM Slot x 1
Indicator	Power / System LED
OS Support	Windows® 10 IoT 64-bit Windows® 11 Pro 64-bit Linux Ubuntu 20.04.2
Power Supply	
Power Requirement	DC-in 9-36V x1 for 3-pin Terminal Block
Mechanical	
Mounting	Wallmount
Dimensions (W x H x D)	9.84" x 5.62" x 2.03" (250 x 143 x 51.5) with bracket 7.87" x 5.62" x 1.75" (200 x 143 x 44.5) w/o bracket
Gross Weight	4.4 lb (2.0 Kg)
Net Weight	3.3 lb (1.5 Kg)
Environmental	
Operating Temperature	-4°F ~ 140°F (-20°C ~ 60°C), according to IEC68-2 with 0.5 m/s AirFlow (w/ Industrial wide Temp. SSD/RAM)
Storage Temperature	-40°F ~ 176°F (-40°C ~ 80°C)
Storage Humidity	5 ~ 95% @ 40°C, non-condensing
Anti-Vibration	3 Grms/ 5 ~ 500Hz/ operation (with SSD)
Anti-Shock	50G, IEC 68-2-27, half sine, 11 ms duration (with SSD)
Certification	CE/FCC class A





Dimension

Unit: mm

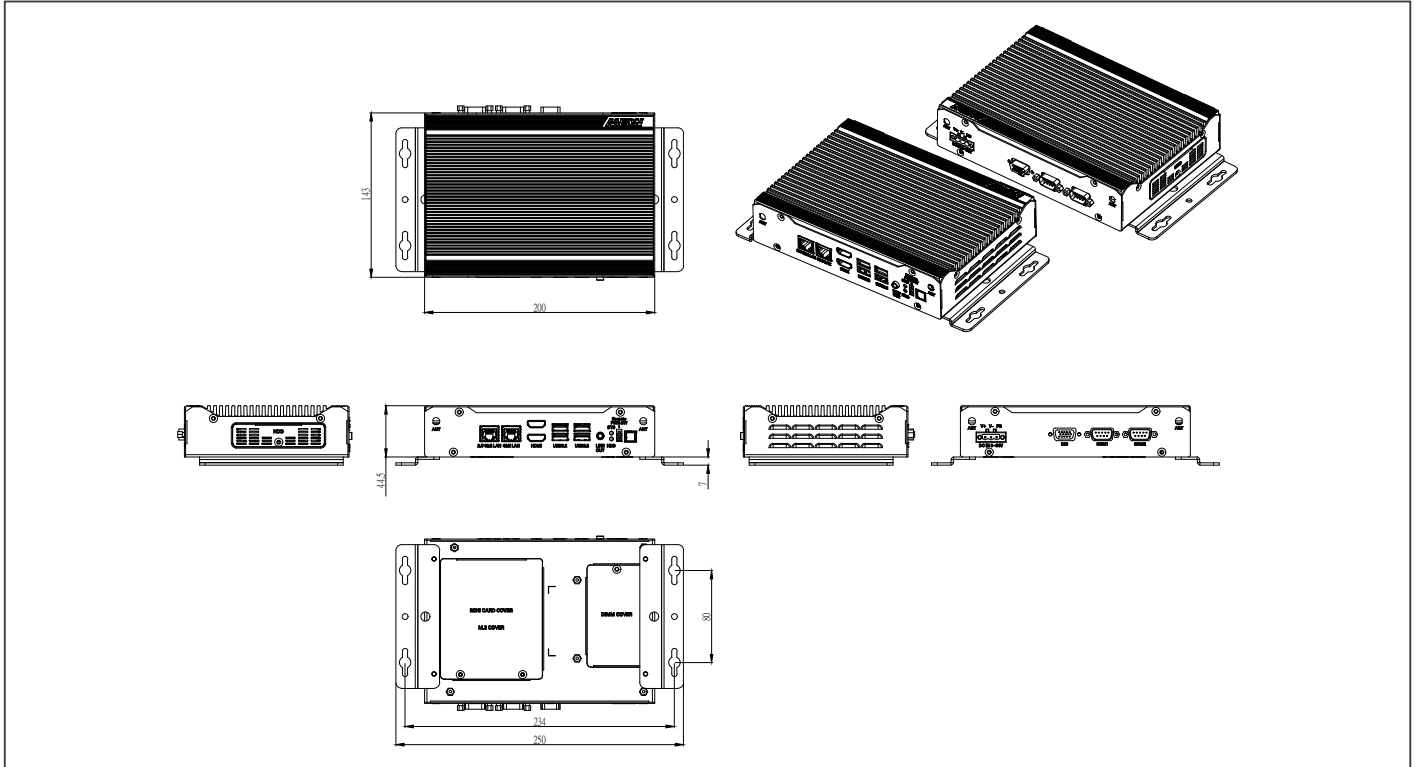

Ordering Information

Part Number	CPU	LAN	PCH	USB 3.2 Gen2	USB 2.0	RS 232/422/485	Storage	Display	Expansion	Mounting	Power	Operation Temp.
BOXER-6643-TGU-A1-1010	Intel® Core™ i3-1115G4E	2	Intel SoC	3	1	2	-M.2 2280 M Key NVMe Slot x1 (PCIex4) -2.5" SATA Drive Bay x1	HDMI x 2	-M.2 3052 B Key x 1 (for 5G module) -Full-Size MiniCard x1 (PCIe + USB / SATA, Default PCIe + USB) -SIM Slot x 1	Wallmount	9-36V DC in	-4°F ~ 140°F (-20°C ~ 60°C), according to IEC68-2 with 0.5 m/s AirFlow (w/ Industrial wide Temp. SSD/RAM)
BOXER-6643-TGU-A2-1010	Intel® Core™ i5-1145G7E	2	Intel SoC	3	1	2	-M.2 2280 M Key NVMe Slot x1 (PCIex4) -2.5" SATA Drive Bay x1	HDMI x 2	-M.2 3052 B Key x 1 (for 5G module) -Full-Size MiniCard x1 (PCIe + USB / SATA, Default PCIe + USB) -SIM Slot x 1	Wallmount	9-36V DC in	-4°F ~ 140°F (-20°C ~ 60°C), according to IEC68-2 with 0.5 m/s AirFlow (w/ Industrial wide Temp. SSD/RAM)
BOXER-6643-TGU-A3-1010	Intel® Core™ i7-1185G7E	2	Intel SoC	3	1	2	-M.2 2280 M Key NVMe Slot x1 (PCIex4) -2.5" SATA Drive Bay x1	HDMI x 2	-M.2 3052 B Key x 1 (for 5G module) -Full-Size MiniCard x1 (PCIe + USB / SATA, Default PCIe + USB) -SIM Slot x 1	Wallmount	9-36V DC in	-4°F ~ 140°F (-20°C ~ 60°C), according to IEC68-2 with 0.5 m/s AirFlow (w/ Industrial wide Temp. SSD/RAM)

Packing List

- Wallmount Bracket x 2
- 3 Pin DC-in Power Connector x 1
- Screw Package x 1
- BOXER-6643-TGU x 1

Optional Accessories

- 125590120B
120W Power Adapter
- 170X000799
Power Cord (US Type)
- 170X000800
Power Cord (Europe)
- 170X000803
Power Cord (Japan)

BOXER-6645-ADS

Fanless Embedded Box PC with Socket Type 12th/13th Generation Intel® Core™ Processors



Front View



Rear View



Features

- 12th/13th Gen Intel® Core™ Desktop Processors
- Built-in high performance Intel® UHD Graphic Engine
- Dual-Channel DDR5 SODIMM, Max. 64GB
- Four Independent Displays (A2 Model)
- SuperSpeed+ USB 3.2 Gen 2 (10Gbps) x 8 (A2 Model)
- M.2 3052 B-Key for 5G Module
- Quadruple LAN (GbE x 3, 2.5GbE x 1)
- Onboard TPM 2.0
- Hailo-8™ M.2 2280 AI Accelerator Module Support (Optional)



Specifications

System	
CPU	13th Generation Intel® Core™ Processors: Intel® Core™ i9-13900TE, Intel® Core™ i9-13900E, Intel® Core™ i7-13700TE, Intel® Core™ i7-13700E, Intel® Core™ i5-13500TE, Intel® Core™ i5-13500E, Intel® Core™ i3-13100TE, Intel® Core™ i3-13100E
	12th Generation Intel® Core™/Celeron® Processors: Intel® Core™ i9-12900E, Intel® Core™ i7-12700E, Intel® Core™ i7-12700E, Intel® Core™ i5-12500E, Intel® Core™ i5-12500E, Intel® Core™ i3-12100E, Intel® Core™ i3-12100E, Intel® Celeron® Processor G6900TE, Intel® Celeron® Processor G6900E
Chipset	Intel® H610E/Q670E
System Memory	DDR5 4800MHz SODIMM x 2, up to 64GB
Display Interface	HDMI 1.4b (Type-A) x 2 DP 1.4a x 2 *A2 model supports four simultaneous display outputs *A1 model supports three simultaneous display outputs
Storage Device	2.5" SATA 6Gb/s Drive Bay x 2 (A2 SKU supports RAID 0, 1) M.2 2280 M-Key x 1 (NVMe, extra heatsink required, refer to optional accessories) (A2 Model)
Ethernet	Intel® I210-AT, 10/100/1000 Base-TX x 2 Intel® I219-LM, 10/100/1000 Base-TX x 1 Intel® I226-LM, 2.5GbE Base-TX x 1
I/O	USB 3.2 Gen 2 (5Gbps) x 4 (A1 Model) USB 3.2 Gen 2 (10Gbps) x 8 (A2 Model) USB 2.0 x 4 (A1 Model) Audio x 1 (MIC-in, Line-out) DB-9 x 6 for RS-232/422/485 SMA Antenna Hole x 6 DIO x 8
Expansion	M.2 2230 E-Key x 1 for WiFi module M.2 3052 B-Key x 1 for 4G/5G module
Indicator	System LED x 1 HDD LED x 1
OS support	Windows® 10 IoT Enterprise 64-bit Windows® 11 PRO 64-bit Linux Ubuntu 20.04 (Kernel 15.5 or above)
Power Supply	
Power Requirement	3-pin DC Input 12~24V
Mechanical	
Mounting	Wallmount
Dimensions (W x H x D)	10.39" x 3.8" x 7.33" (264mm x 80.92mm x 186.2mm)
Gross Weight	11.7 lb (5.3 Kg)
Net Weight	9.5 lb (4.3 Kg)
Environmental	
Operating Temperature	-4°F ~ 122°F (-20°C ~ 50°C), IEC68-2 with 0.5 m/s AirFlow, with wide temperature memory/storage (TDP 65W CPU) -4°F ~ 140°F (-20°C ~ 60°C), IEC68-2 with 0.5 m/s AirFlow, with wide temperature memory (Max. 32GB)/Storage (TDP 35W CPU)
Storage Temperature	-40 °F ~ 176°F (-40°C ~ 80°C)
Storage Humidity	5 ~ 95% @ 40°C, non-condensing
Anti-Vibration	3 Grms/ 5 ~ 500Hz/ operation – SSD 1 Grms/ 5 ~ 500Hz/ operation – HDD
Anti-Shock	50G, IEC68-2-27, half sine, 11ms duration (with SSD)
Certification	CE/FCC class A





Dimension

Unit: mm

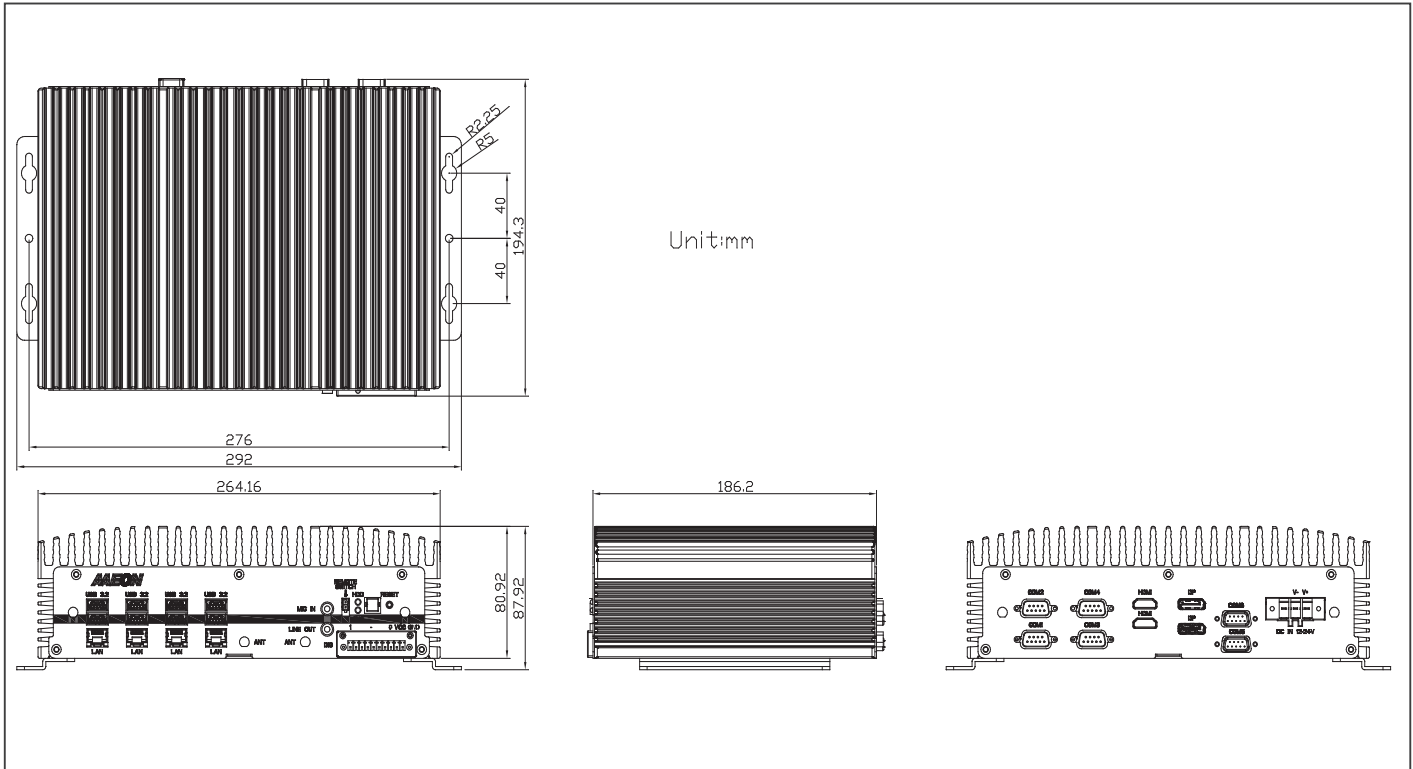

Ordering Information

Part Number	PCH	LAN	USB 3.0	USB 2.0	RS-232	RS-232/422/485	Digital I/O	Audio	Storage	Display	Expansion	Mounting	Power	Operation temp.
BOXER-6645-ADS-A1-1110	Intel® H610E	4	USB 3.2 (5Gbps) x 4	4	—	6	8 bit	Mic-in Line-out	2.5" SATA 6Gb/s Drive Bay x 2	HDMI x 2 DP x 2	M.2 2230 E-Key x 1 M.2 3052 B-Key x 1 w/ SIM Slot	Wallmount	12~24V	-4°F ~-122°F (-20°C ~ 50°C), IEC68-2 with 0.5 m/s AirFlow, with wide temperature Memory / Storage & TDP 65W CPU. -4°F ~-140°F (-20°C ~ 60°C), IEC68-2 with 0.5 m/s AirFlow, with wide temperature Memory (Max. 32G)/ Storage & TDP 35W CPU
BOXER-6645-ADS-A2-1110	Intel® Q670E	4	USB 3.2 (10Gbps) x 8	—	—	6	8 bit	Mic-in Line-out	2.5" SATA 6Gb/s Drive Bay x 2 (RAID 0, 1) M.2 2280 M-Key x 1 (NVMe)	HDMI x 2 DP x 2	M.2 2230 E-Key x 1 M.2 3052 B-Key x 1 w/ SIM Slot	Wallmount	12~24V	-4°F ~-122°F (-20°C ~ 50°C), IEC68-2 with 0.5 m/s AirFlow, with wide temperature Memory / Storage & TDP 65W CPU. -4°F ~-140°F (-20°C ~ 60°C), IEC68-2 with 0.5 m/s AirFlow, with wide temperature Memory (Max. 32G)/ Storage & TDP 35W CPU

Packing List

- BOXER-6645-ADS x1
- Wallmount Bracket x 2
- 3 Pin DC-In Power Connector x 1
- Remote ON/OFF Connector x 1
- Screw Package x 1

Optional Accessories

- **1255X00070**
180W Power Adapter (Recommended for 35W CPU)
- **170X000799**
Power Cord (US Type)
- **170X000800**
Power Cord (Europe)
- **170X000803**
Power Cord (Japan)
- **1255903300**
330W Power Adapter (Recommended for 65W CPU)
- **9C3256G007**
M.2 2280 M Key 256GB, PCIe Gen4 x 4, 3D TLC ,
-40°C~85°C, Transcend TS256GMTE710T-I
- **9C3512G006**
M.2 2280 M Key 512GB, PCIe Gen4 x 4, 3D TLC ,
-40°C~85°C, Transcend TS512GMTE710T-I
- **9C2001T007**
M.2 2280 M Key 1TB, PCIe Gen4 x 4, 3D TLC ,
-40°C~85°C, Transcend TS1TMTE710T-I
- **9C3002T002**
M.2 2280 M Key 2TB, PCIe Gen4 x 4, 3D TLC ,
-40°C~85°C, Transcend TS2TMTE710T-I
- **9641664500**
Heatsink pack for above PCIe Gen4x4 M.2 2280 NVMe SSD models

BOXER-6645U-RPL

Fanless Embedded Box PC with Socket Type 12/13/14th Generation Intel® Core™ Processor

Front View

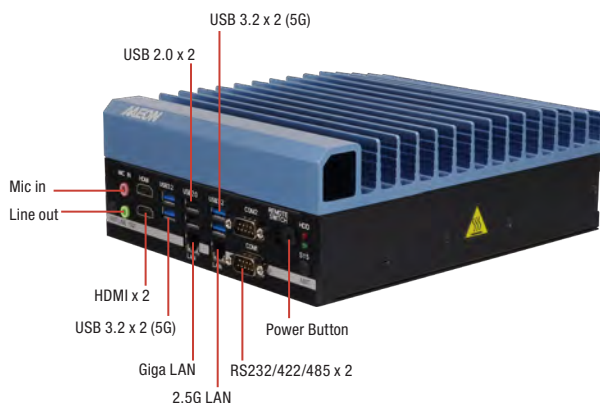

Rear View



Features

- 12/13/14th Generation Intel® Core™ LGA 1700 socket-type Processor with Intel® H610E Chipset
- Wide Operating Temperature (-25°C ~ 70°C)
- HDMI output x 2
- GbE LAN x 2
- USB Type-A x 6
- RS-232/422/485 x 2, RS-232 x 4 (Optional)
- Internal 2.5" SSD bay x 2
- 10 ~ 35 VDC power input range
- TPM 2.0 onboard



Specifications

System	
CPU	12/13/14th Generation Intel® Core™ LGA 1700 Socket-Type Processor, Max TDP 65W 13th Generation Intel® Core™ Processors: Intel® Core™ i9-13900TE/13900E Intel® Core™ i7-13700TE/13700E Intel® Core™ i5-13500TE/13500E Intel® Core™ i3-13100TE/13100E 14th Generation Intel® Core™ Processors: Intel® Core™ i9 processor 14900/14900T Intel® Core™ i7 processor 14700/14700T Intel® Core™ i5 processor 14500/14500T Intel® Core™ i3 processor 14100/14100T
Chipset	Intel® H610E Chipset
System Memory	DDR5 SODIMM x 2, up to 64GB
Display Interface	HDMI x 2, 4K x 2K @30Hz
Storage Device	2.5" SATA Drive Bay x 2 M.2 2280 M-Key x 1 (PCIe Gen 3 [x4]) for NVMe
Ethernet	Intel® Ethernet Connection I219-LM, GbE RJ-45 x 1 Intel® Ethernet Controller I226-LM, 2.5GbE RJ-45 x 1
I/O	USB 3.2 Gen 2 x 4, USB 2.0 x 2 DB-9 x 2 for RS-232/422/485 Audio x 1 (Mic-in/Line-out) Power Button with power LED x 1 Remote Power On/Off x 1
Expansion	M.2 2280 M-Key x 1 (NVMe) *Note: Additional heatsink required, please refer to optional accessories. M.2 2230 E-Key x 1 (for Wi-Fi/Bluetooth) Full Size MiniPCIe x 1 (optional for mSATA) Onboard TPM 2.0
Indicator	System / Storage
OS support	Windows® 10 IoT Enterprise 64-bit Windows® 11 PRO 64-bit Linux Ubuntu 22.04
Power Supply	
Power Requirement	3-pin DC Input 10~35V
Mechanical	
Mounting	Wallmount
Dimensions (W x H x D)	7.09" x 3.04" x 8.66" (180mm x 77.2mm x 220mm) 8.43" x 3.31" x 8.66" (214mm x 84.2mm x 220mm) with brackets
Gross Weight	8.59 lb (3.9 Kg)
Net Weight	6.39 lb (2.9 Kg)
Environmental	
Operating Temperature	-13°F ~ 131°F (-25°C ~ 55°C), IEC60068-2 with 0.7 m/s AirFlow, with wide temperature memory/storage (TDP 65W CPU) -13°F ~ 158°F (-25°C ~ 70°C), IEC60068-2 with 0.7 m/s AirFlow, with wide temperature memory/storage (TDP 35W CPU)
Storage Temperature	-40°F ~ 176°F (-40°C ~ 80°C)
Storage Humidity	5 ~ 95% @ 40°C, non-condensing
Anti-Vibration	IEC60068-2-64, 3 Grms/ 5 ~ 500Hz/ operation (with SSD)
Anti-Shock	50G, IEC60068-2-27, half sine, 11ms duration (with SSD)





Dimension

Unit: mm

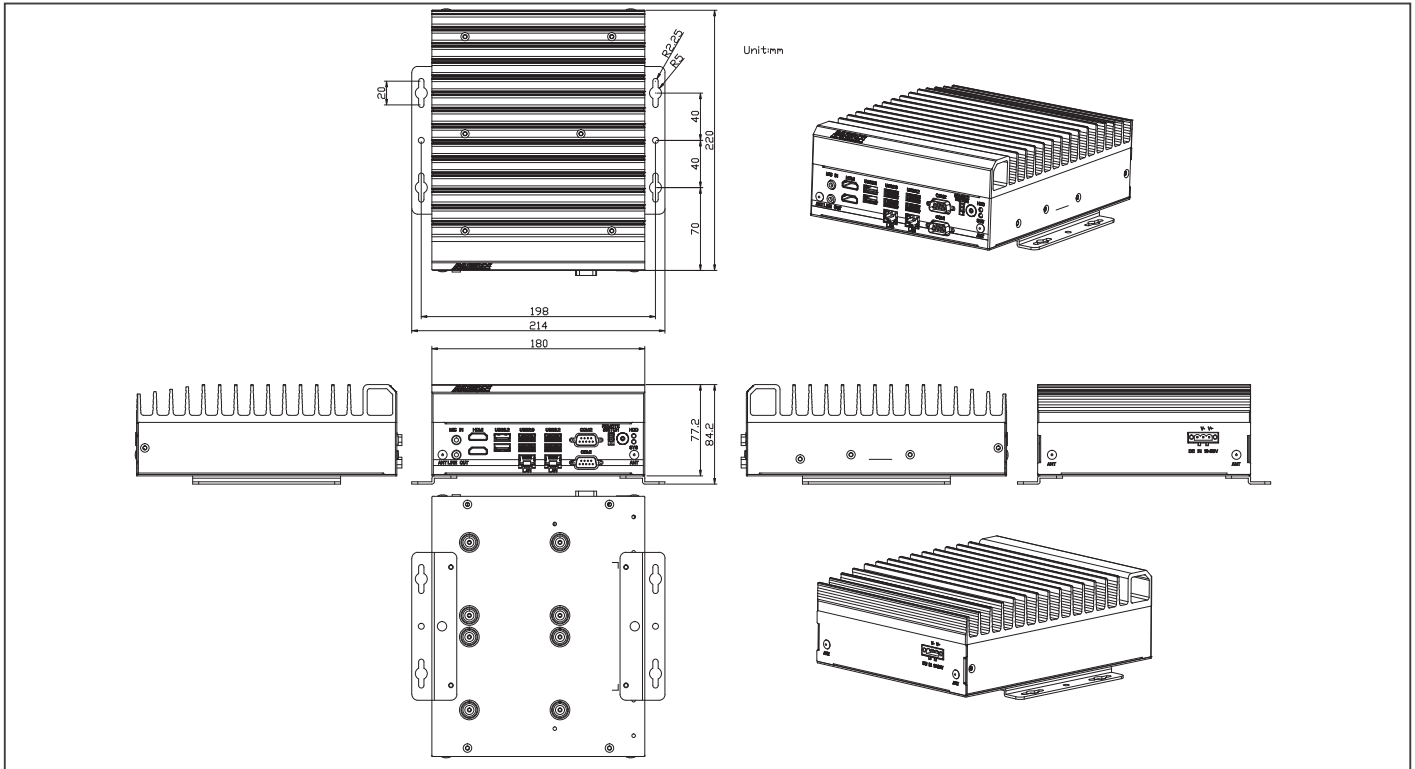

Packing List

- BOXER-6645U-RPL x1
- Wallmount Bracket x 2
- 3 Pin DC-In Power Connector x 1
- Remote ON/OFF cable x 1
- Screw Package x 1

Optional Accessories

- **1255302300**
19V 230W Power Adapter
- **170X000799**
Power Cord (US Type)
- **170X000800**
Power Cord (Europe)
- **170X000803**
Power Cord (Japan)
- **9C3256G007**
M.2 2280 M Key 256GB, PCIe Gen4 x 4, 3D TLC ,
-40°C~85°C, Transcend TS256GMTE710T-I
- **9C3512G006**
M.2 2280 M Key 512GB, PCIe Gen4 x 4, 3D TLC ,
-40°C~85°C, Transcend TS512GMTE710T-I
- **9C2001T007**
M.2 2280 M Key 1TB, PCIe Gen4 x 4, 3D TLC ,
-40°C~85°C, Transcend TS1TMTE710T-I
- **9C3002T002**
M.2 2280 M Key 2TB, PCIe Gen4 x 4, 3D TLC ,
-40°C~85°C, Transcend TS2TMTE710T-I
- **9641664501**
Heatsink pack for PCIe Gen4x4 M.2 2280 NVMe SSD

Ordering Information

Part Number	PCH	LAN	USB 3.2 Gen2	USB 2.0	RS232	RS232/422/485	Digital I/O	Audio	Storage	Display	Expansion	Mounting	Power	Operation Temp.
BOXER-6645U-RPL-A1-1010	Intel® H610E	2	4	2	—	2	—	Mic-in Line-out	M.2 2280 M Key Slot x1 (NVMe SSD) 2.5" SATA Drive Bay x2	HDMI x2	M.2 2230 E Key x 1 Full Size MiniPCIe x 1 SIM Slot x 1	Wallmount	10~35V	-13°F ~ 131°F (-25°C ~ 55°C), IEC60068-2 with 0.7 m/s AirFlow, with wide temperature memory/storage (TDP 65W CPU) -13°F ~ 158°F (-25°C ~ 70°C), IEC60068-2 with 0.7 m/s AirFlow, with wide temperature memory/storage (TDP 35W CPU)

BOXER-6646-ADP

Fanless Compact Embedded Computer with 12th/13th Generation Intel® Core™ i7/i5/i3 Processor



Front View

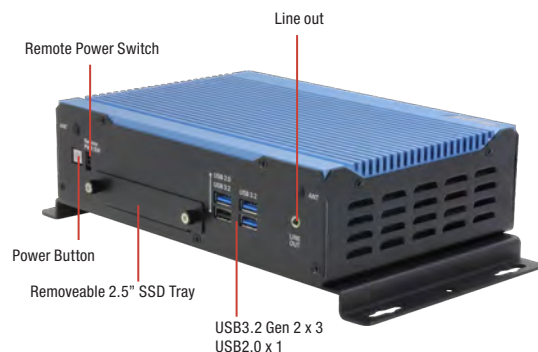

Rear View

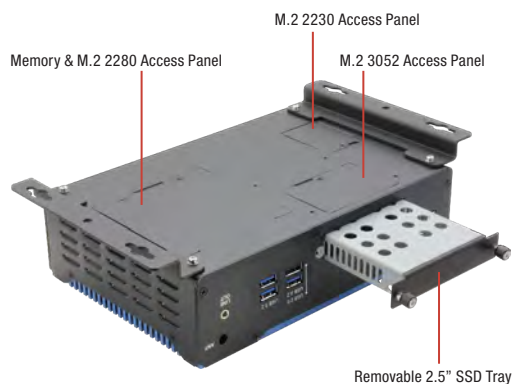
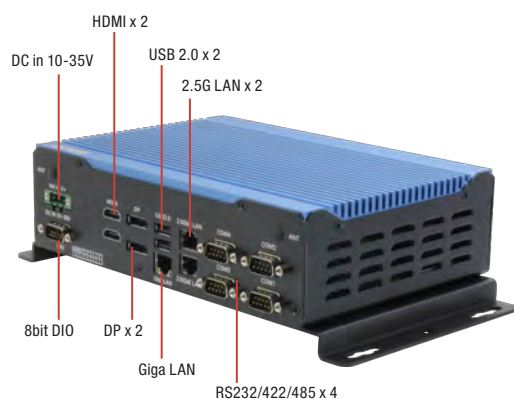

Features

- 12th/13th Gen Intel® Core™ i7/i5/i3 Processor SoC
- Dual-Channel DDR5 SODIMM slot
- Support Multi-LAN including 2.5GbE Ethernet
- Support M.2 2280 M Key High speed NVMe SSD
- SuperSpeed+ USB 3.2 Gen2
- Wide Range 10~35V DC input
- Wide Operating Temperature -20~60°C
- Compact Size
- Onboard TPM 2.0
- Hailo-8™ M.2 2280 AI Accelerator Module Support (Optional)



Specifications

System	
CPU	13th Generation Intel® Core™ Processors: Intel® Core™ i7-1370PE Intel® Core™ i5-1350PE Intel® Core™ i3-1320PE 12th Generation Intel® Core™ Processors: Intel® Core™ i7-1270PE Intel® Core™ i5-1250PE Intel® Core™ i3-1220PE
Chipset	Intel® System on Chip
System Memory	DDR5 SODIMM slot x 2, max. 64GB
Display Interface	HDMI x2, Display Port x 2
Storage Device	Removeable 2.5" SATA Drive Bay x 1 M.2 2280 M Key NVMe Slot x 1
Ethernet	RJ-45 x 2 for 2.5GbE LAN i225-LM x 2 RJ-45 x 1 for GbE LAN i219-LM x 1
I/O	USB Type-A x 3 for USB3.2 Gen2 (10Gbps) USB Type-A x 3 for USB 2.0 DB-9 x 4 for RS-232/422/485 Line out SMA Antenna Holes x 6 10-pin D-Sub connector for DIO 8 bit x 1 Power Button with LED indicator x 1 Remote Power on/off 2pin connector x 1
Expansion	M.2 E key 2230 x 1 M.2 B Key 3052 x 1 (for 5G/LTE module)
Indicator	System Power LED x 1
OS support	Windows® 10 IoT Ent LTSC, Windows® 11 PRO, Ubuntu 22.04
Power Supply	
Power Requirement	DC-in 10~35V in 3pin Terminal block connector
Mechanical	
Mounting	Wallmount
Dimensions (W x H x D)	8.66" x 6.06" x 2.42" (220 mm x 154 mm x 61.6 mm)
Gross Weight	6.6 lb (3.0 Kg)
Net Weight	4.9 lb (2.2 Kg)
Environmental	
Operating Temperature	-4°F ~140°F (-20°C ~ 60°C), IEC68-2 with 0.5 m/s AirFlow, with wide temperature Memory/Storage
Storage Temperature	-40°F ~ 176°F (-40°C ~ 80°C)
Storage Humidity	5 ~ 95% @ 40°C, non-condensing
Anti-Vibration	SSD: Random, 3Grms, 5~500Hz
Anti-Shock	SSD: 50G @ wallmount, Half-sine, 11ms
Certification	CE/FCC class A





Dimension

Unit: mm

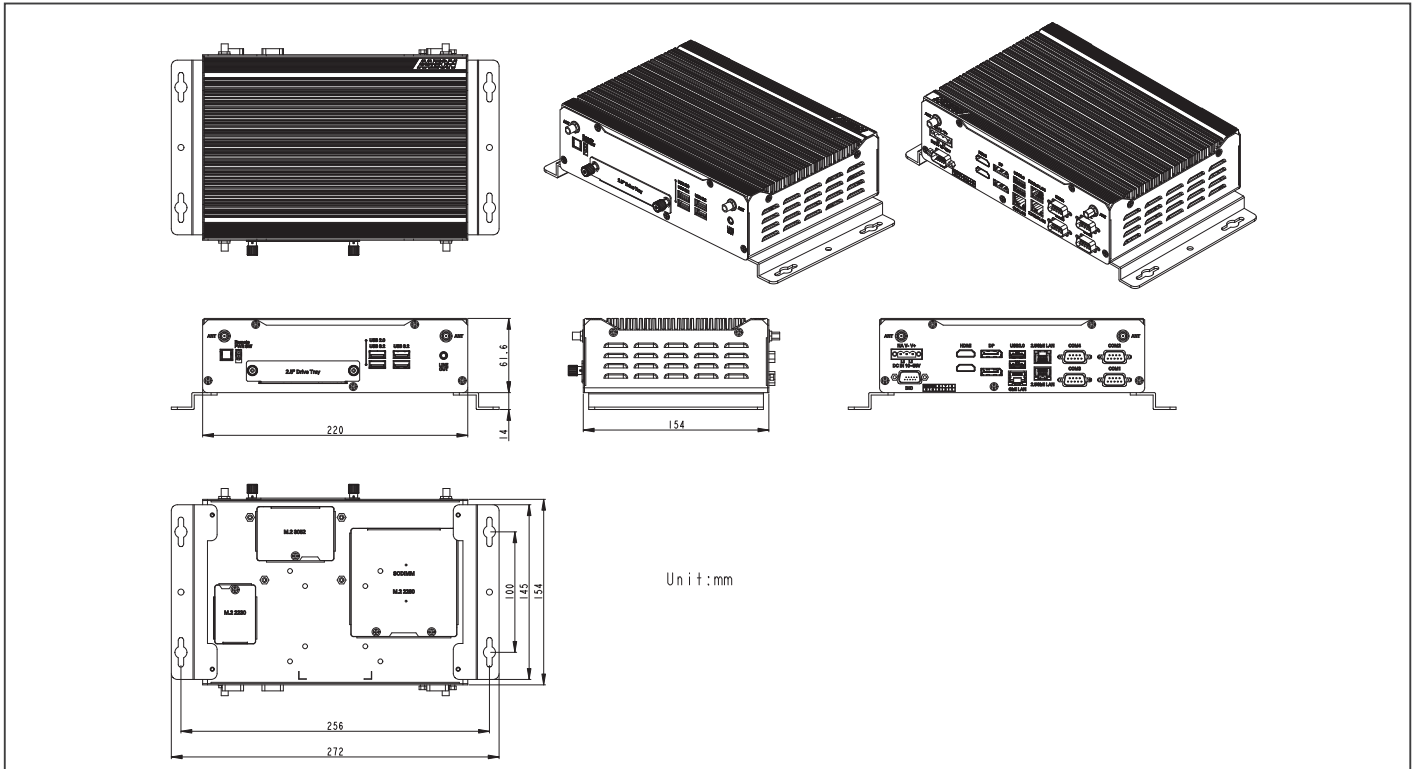

Ordering Information

Part Number	CPU	PCH	LAN	USB 3.0	USB 2.0	RS-232	RS-232/422/485	Digital I/O	Audio	Storage	Display	Expansion	Mounting	Power	Operation temp.
BOXER-6646-ADP-A1-1010	Intel® Core™ i3-1220PE	SoC	3	USB 3.2 (10Gbps) x3	3	—	4	8bit	Line-out	2.5" SATA-III Drive bay x 1 M.2 2280 M Key NVMe Slot x 1	HDMI x 2 DP x 2	M.2 E-Key 2230 x1 M.2 B-Key 3052 x1 w/ SIM Slot x1	Wallmount	10~35V	-4°F ~ 140°F (-20°C ~ 60°C) with 0.5 m/s airflow, with wide temperature Memory/Storage
BOXER-6646-ADP-A2-1010	Intel® Core™ i5-1250PE	SoC	3	USB 3.2 (10Gbps) x3	3	—	4	8bit	Line-out	2.5" SATA-III Drive bay x 1 M.2 2280 M Key NVMe Slot x 1	HDMI x 2 DP x 2	M.2 E-Key 2230 x1 M.2 B-Key 3052 x1 w/ SIM Slot x1	Wallmount	10~35V	-4°F ~ 140°F (-20°C ~ 60°C) with 0.5 m/s airflow, with wide temperature Memory/Storage
BOXER-6646-ADP-A3-1010	Intel® Core™ i7-1270PE	SoC	3	USB 3.2 (10Gbps) x3	3	—	4	8bit	Line-out	2.5" SATA-III Drive bay x 1 M.2 2280 M Key NVMe Slot x 1	HDMI x 2 DP x 2	M.2 E-Key 2230 x1 M.2 B-Key 3052 x1 w/ SIM Slot x1	Wallmount	10~35V	-4°F ~ 140°F (-20°C ~ 60°C) with 0.5 m/s airflow, with wide temperature Memory/Storage
BOXER-6646-ADP-A4-1010	Intel® Core™ i3-1320PE	SoC	3	USB 3.2 (10Gbps) x3	3	—	4	8bit	Line-out	2.5" SATA-III Drive bay x 1 M.2 2280 M Key NVMe Slot x 1	HDMI x 2 DP x 2	M.2 E-Key 2230 x1 M.2 B-Key 3052 x1 w/ SIM Slot x1	Wallmount	10~35V	-4°F ~ 140°F (-20°C ~ 60°C) with 0.5 m/s airflow, with wide temperature Memory/Storage
BOXER-6646-ADP-A5-1010	Intel® Core™ i5-1350PE	SoC	3	USB 3.2 (10Gbps) x3	3	—	4	8bit	Line-out	2.5" SATA-III Drive bay x 1 M.2 2280 M Key NVMe Slot x 1	HDMI x 2 DP x 2	M.2 E-Key 2230 x1 M.2 B-Key 3052 x1 w/ SIM Slot x1	Wallmount	10~35V	-4°F ~ 140°F (-20°C ~ 60°C) with 0.5 m/s airflow, with wide temperature Memory/Storage
BOXER-6646-ADP-A6-1010	Intel® Core™ i7-1370PE	SoC	3	USB 3.2 (10Gbps) x3	3	—	4	8bit	Line-out	2.5" SATA-III Drive bay x 1 M.2 2280 M Key NVMe Slot x 1	HDMI x 2 DP x 2	M.2 E-Key 2230 x1 M.2 B-Key 3052 x1 w/ SIM Slot x1	Wallmount	10~35V	-4°F ~ 140°F (-20°C ~ 60°C) with 0.5 m/s airflow, with wide temperature Memory/Storage

Packing List

- BOXER-6646-ADP x1
- Wallmount Bracket x 2
- 3 Pin DC-In Power Connector x 1
- Remote ON/OFF Connector x 1
- Screw Package x 1

Optional Accessories

- 125590120B
19V 120W AC to DC Adapter
- 170X000799
Power Cord (US Type)
- 170X000800
Power Cord (Europe)
- 170X000803
Power Cord (Japan)

BOXER-6647-MTH

Fanless Compact Embedded Computer with Intel® Core™ Ultra 7/5 Processors

Front View



Rear View

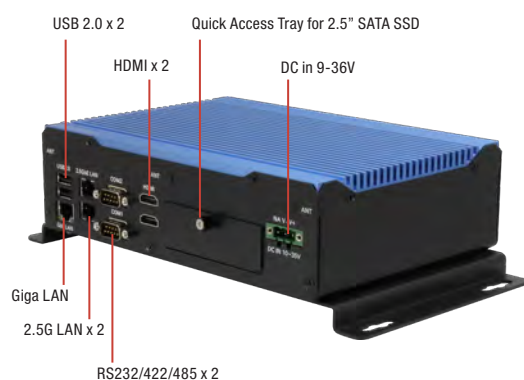

Features

- Intel® Core™ Ultra 5/7 Processor
- DDR5 5600 MT/s SODIMM x2, up to 64GB (Note: One DIMM slot can be user-populated via rear chassis access. Second DIMM slot is not user-accessible, but module preinstallation is available upon request.)
- Accessible M.2 2280 NVMe SSD Tray + 2.5" SSD Tray
- M.2 3052 B-Key for 5G
- USB 3.2 Gen 2 (Type-A) x 4
- Onboard TPM 2.0
- Wide 9V ~ 36V DC Input Range
- Wide -20°C ~ 60°C Operating Temperature



Specifications

System	
CPU	Intel® Core™ Ultra 5 processor 125H Intel® Core™ Ultra 7 processor 155H
Chipset	Intel® SoC
System Memory	DDR5 5600 MT/s SODIMM x2, up to 64GB *Note: One DIMM slot can be user-populated via rear chassis access. Second DIMM slot is not user-accessible, but module preinstallation is available upon request.
Display Interface	HDMI x 2 (Support 4K @60Hz)
Storage Device	M.2 2280 M-Key x 1 (NVMe PCIe SSD, quick access tray design) 2.5" SATA HDD/SSD x 1 (quick access tray design)
Ethernet	RJ-45 x 2 for 2.5GbE LAN (Intel® Ethernet Controller I226) RJ-45 x 1 for GbE LAN (Intel® Ethernet Connection I219)
I/O	HDMI x 2 USB 3.2 Gen 2 (Type-A) x 4 USB 2.0 (Type-A) x 2 DB-9 Male x 2 for RS-232/422/485 3.5mm Jack x 1 for Mic-in/Line-out DB-15 male x1 for 8-bit DIO Remote Power x 1 Power Button with LED x 1 Antenna holes x 6
Expansion	M.2 2280 M-Key x 1 (PCIe [x4] for NVMe Storage) M.2 2230 E-Key x 1 (for Wi-Fi) M.2 3052 B-Key x 1 (for 5G/LTE) SIM Slot x 1
Indicator	Sys LED Storage active LED
OS support	Windows® 11 Pro, Windows® 11 IoT Enterprise, Linux Ubuntu 24.04.01 and above
Power Supply	
Power Requirement	DC-in 9~36V in 3-pin Terminal block connector
Mechanical	
Mounting	Wallmount
Dimensions (W x H x D)	8.66" x 6.06" x 2.42" (220mm x 154mm x 62.1mm) w/o bracket 10.7" x 6.1" x 3.0" (272mm x 154mm x 76.1mm) with bracket
Gross Weight	6.6 lb (3.2 Kg)
Net Weight	4.9 lb (2.4 Kg)
Environmental	
Operating Temperature	-4°F ~140°F (-20°C ~ 60°C), IEC60068-2 with 0.7 m/s AirFlow, with wide temperature Memory/Storage
Storage Temperature	-40°F ~ 176°F (-40°C ~ 80°C)
Storage Humidity	5 ~ 95% @ 40°C, non-condensing
Anti-Vibration	2 Grms/ 5 ~ 500Hz/ operation (with SSD)
Anti-Shock	30G, IEC60068-2-27, half sine, 11 ms duration (with SSD)
Certification	CE/FCC class A





Dimension

Unit: mm

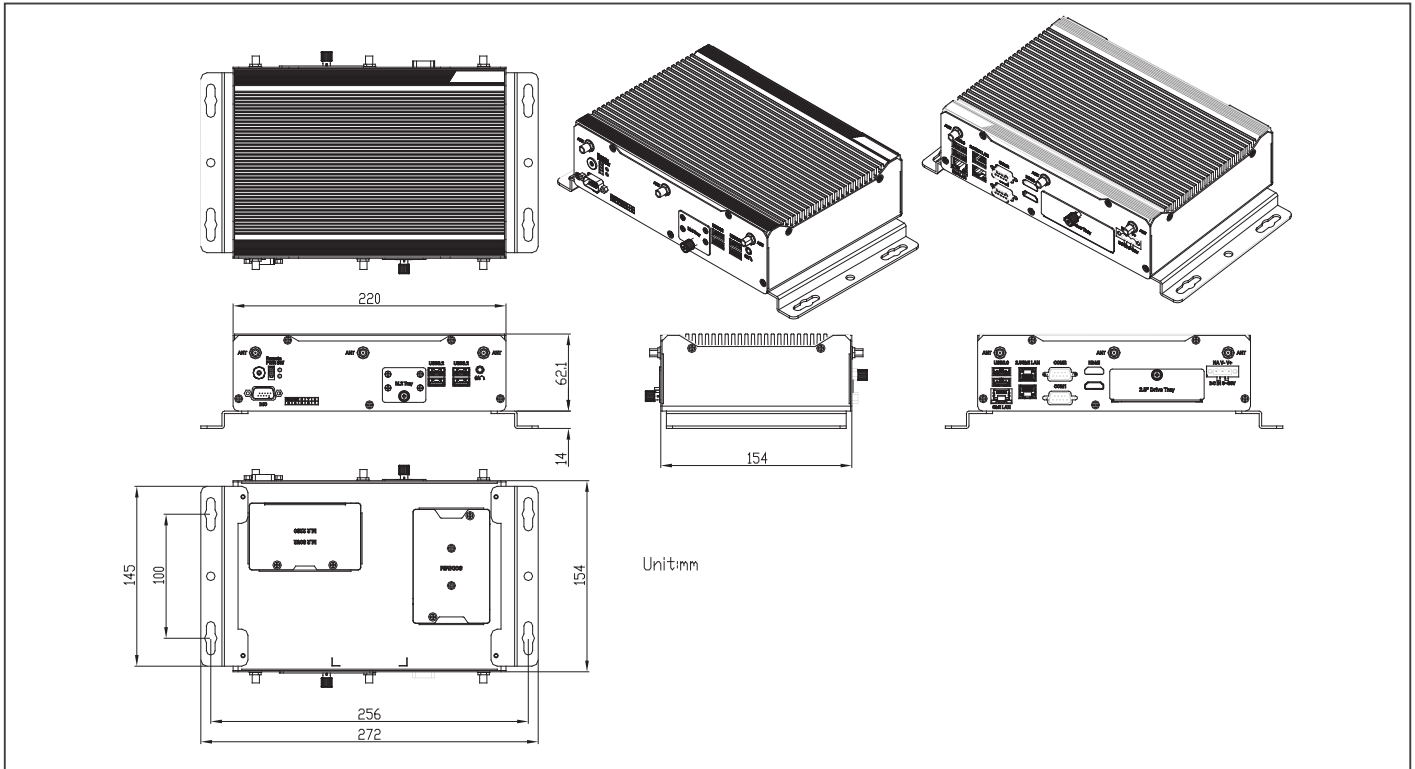

Ordering Information

Part Number	CPU	LAN	PCH	USB 3.2 Gen2	USB 2.0	RS232/422/485	Storage	Display	Expansion	Mounting	Power	Operation Temp.
BOXER-6647-MTH-A1-1010	Intel® Core™ Ultra 5 processor 125H	3	Intel SoC	4	2	2	M.2 2280 M Key Slot x 1 (NVMe SSD) 2.5" SATA Drive Bay x 1	HDMI x 2	M.2 2230 E Key x 1 M.2 3052 B Key x 1 SIM Slot x 1	Wallmount	9~36V DC in	-4°F ~ 140°F (-20°C ~ 60°C), according to IEC60068-2 with 0.7 m/s AirFlow (w/ Industrial wide Temp. SSD/RAM) SSD: -20 ~ 85C RAM: -20 ~ 95C
BOXER-6647-MTH-A2-1010	Intel® Core™ Ultra 7 processor 155H	3	Intel SoC	4	2	2	M.2 2280 M Key Slot x 1 (NVMe SSD) 2.5" SATA Drive Bay x 1	HDMI x 2	M.2 2230 E Key x 1 M.2 3052 B Key x 1 SIM Slot x 1	Wallmount	9~36V DC in	-4°F ~ 140°F (-20°C ~ 60°C), according to IEC60068-2 with 0.7 m/s AirFlow (w/ Industrial wide Temp. SSD/RAM) SSD: -20 ~ 85C RAM: -20 ~ 95C

Packing List

- BOXER-6647-MTH
- Wallmount Bracket x 2
- 3Pin DC-in Power connector x 1
- Remote Power on/off cable x 1
- Thermal pad for memory
- Screw Pack x 1

Optional Accessories

- **125590120B**
19V 120W AC to DC Adapter
- **170X000799**
Power Cord (US Type)
- **170X000800**
Power Cord (Europe)
- **170X000803**
Power Cord (Japan)

BOXER-6648-ARS

Fanless Compact Embedded Computer with Intel® Core™ Ultra Processors (Series 2)

Front View

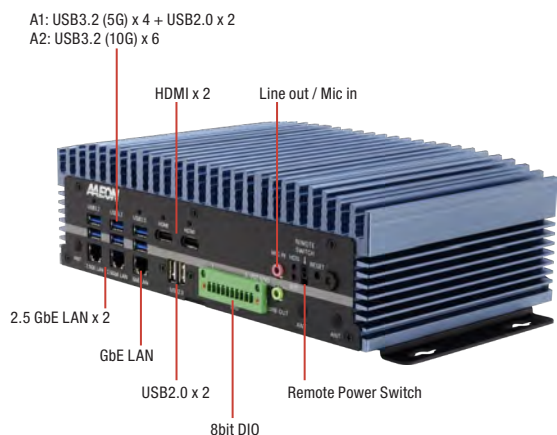

Rear View



Features

- Intel® Core™ Ultra Processors (Series 2)
- Intel® Xe LPG Graphic Engine
- Dual-Channel DDR5 SODIMM x 2, up to 64GB
- HDMI 2.0 x 2
- Intel® Ethernet Controller I226-LM, 2.5GbE LAN x 2 / Intel® Ethernet Connection I219-LM, 1GbE LAN x 1
- Wide Range 10V ~ 35V DC input with Circuit Protection
- Wide -25°C ~ 50°C Operating Temperature
- Onboard TPM 2.0
- Supports iAMT (only for A2 SKU)



Specifications

System	
CPU	Intel® Core™ Ultra 9 Processor 285/285T Intel® Core™ Ultra 7 Processor 265/265T Intel® Core™ Ultra 5 Processor 225/225T
Chipset	A1 SKU: Intel® H810 Chipset A2 SKU: Intel® Q870 Chipset
System Memory	DDR5 SODIMM Slot x 2, up to 64GB
Display Interface	HDMI 2.0 x 2
Storage Device	Internal 2.5" SATA Drive Bay x 2 (RAID 0, 1 supported on A2 SKU) M.2 2280 M-Key x 1 (PCIe Gen 4 [x4]) for NVMe
Ethernet	Intel® Ethernet Controller I226-LM, 2.5GbE LAN x 2 / Intel® Ethernet Connection I219-LM, 1GbE LAN x 1 (Intel® Active Management Technology on 2.5GbE LAN on A2 Model SKU only)
I/O	A1 SKU: USB 3.2 Gen 1 (5Gbps) Type-A x 4, USB 2.0 x 4 A2 SKU: USB 3.2 Gen 2 (10Gbps) Type-A x 6, USB 2.0 x 2 DB-9 x 6 for RS-232/422/485 Mic-in / Line-out 10-pin Terminal Block for 8-bit DIO Power Button with LED Indicator x 1 2-pin Remote Power On/Off Connector x 1
Expansion	M.2 2230 E-Key x 1 (PCIe) M.2 2280 M-Key x 1 (PCIe Gen 4 [x4])
Indicator	System Power / Storage LED
OS support	Windows® 11 Pro Windows® 11 IoT Enterprise LTSC 2024 Ubuntu 24.04 or later
Power Supply	
Power Requirement	DC-in 10V ~ 35V via 4-pin Terminal Block Connector
Mechanical	
Mounting	Wallmount, DIN Rail (optional)
Dimensions (W x H x D)	10.39" x 3.2" x 6.1" (264mm x 81mm x 156mm)
Gross Weight	9.9 lb (4.5kg)
Net Weight	7.7 lb (3.5kg)
Environmental	
Operating Temperature	-13°F ~ 122°F (-25°C ~ 50°C) with 65W TDP CPU, IEC60068-2 with 0.7 m/s AirFlow, with wide temp. memory/storage
Storage Temperature	-40°F ~ 176°F (-40°C ~ 80°C)
Storage Humidity	5 ~ 95% @ 40°C, non-condensing
Anti-Vibration	SSD: Random, 3Grms, 5~500Hz
Anti-Shock	SSD: 50G @ Wallmount, Half-sine, 11ms
Certification	CE/FCC class A





Dimension

Unit: mm

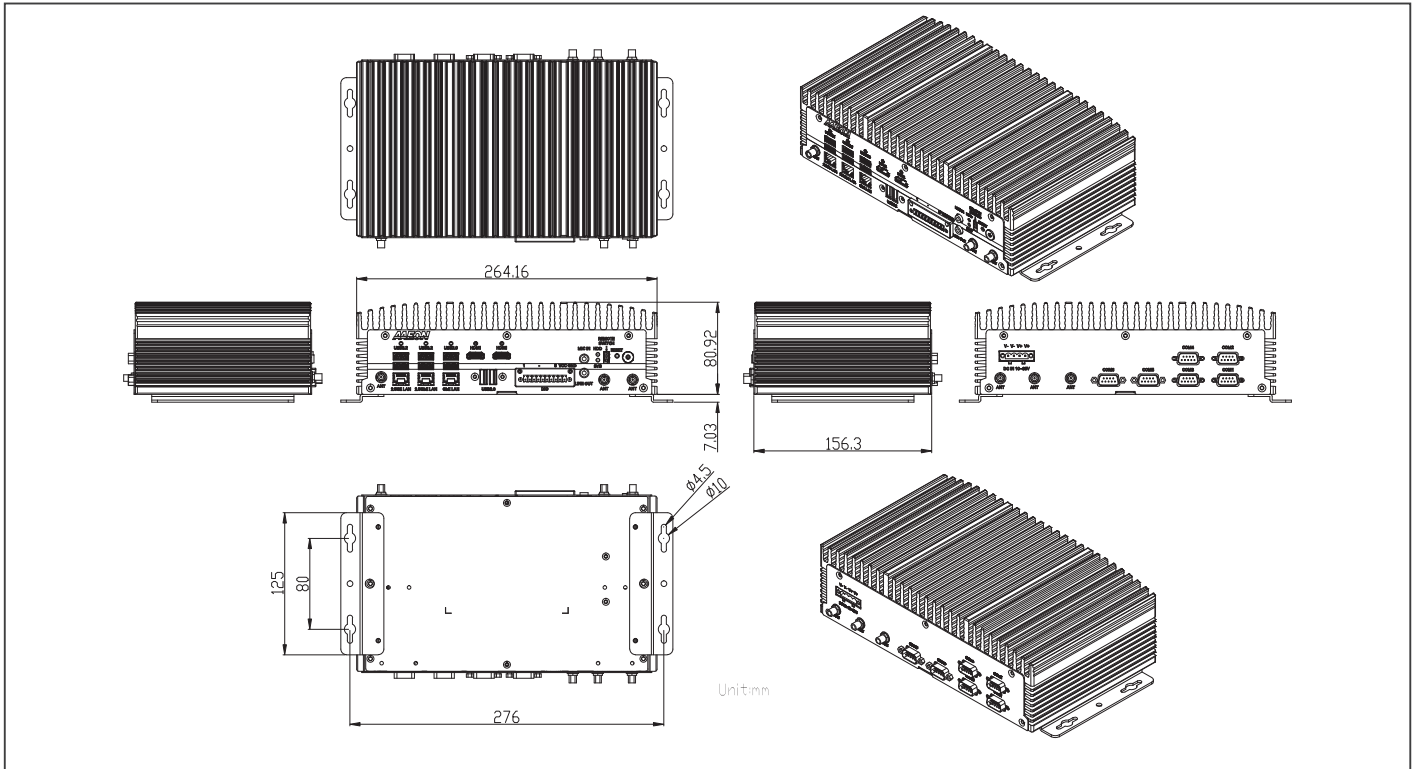

Ordering Information

Part Number	PCH	LAN	USB 3.0	USB 2.0	RS-232/422/485	Digital I/O	Audio	Storage	Display	Expansion	Mounting	Power	Operation Temp.
BOXER-6648-ARS-A1-1010	Intel® H810	GbE LAN x 1 2.5GbE LAN x 2	USB3.2 (5Gbps) x 4	4	6	8	Line Out Mic in	M.2 2280 M Key Slot x 1 (NVMe SSD) 2.5" SATA Drive Bay x 2	HDMI x 2	M.2 E key 2230 x 1 (PCIe) M.2 M key 2280 x 1 (PCIe Gen4 [x4])	Wallmount, DIN Rail (optional)	10~35V DC in	-13°F ~ 122°F (-25°C ~ 50°C) with 65W TDP CPU, IEC60068-2 with 0.7 m/s AirFlow, with wide temp. memory/storage
BOXER-6648-ARS-A2-1010	Intel® Q870	GbE LAN x 1 2.5GbE LAN x 2	USB3.2 (10Gbps) x 6	2	6	8	Line Out Mic in	M.2 2280 M Key Slot x 1 (NVMe SSD) 2.5" SATA Drive Bay x 2 (support RAID 0/1)	HDMI x 2	M.2 E key 2230 x 1 (PCIe) M.2 M key 2280 x 1 (PCIe Gen4 [x4])	Wallmount, DIN Rail (optional)	10~35V DC in	-13°F ~ 122°F (-25°C ~ 50°C) with 65W TDP CPU, IEC60068-2 with 0.7 m/s AirFlow, with wide temp. memory/storage

Packing List

- BOXER-6648-ARS x 1
- Wallmount Kit x 1
- Screw Pack x 1
- 4pin Terminal Block Connector x 1 (for DC input)

Optional Accessories

- 1255X00112
180W AC to DC Power Adapter
- 170X000799
Power Cord (US Type)
- 170X000800
Power Cord (Europe)
- 170X000803
Power Cord (Japan)

BOXER-6649-RAP

Fanless Compact Embedded Computer with 13th Gen Intel® Core™ i7/i5/i3 Processors



Front View



Rear View

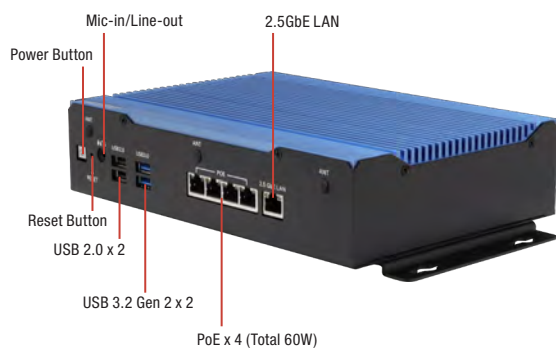

Features

- 13th Generation Intel® Core™ i7/i5/i3 Processors (28W)
- Intel® Iris® Xe Graphics
- Dual-Channel DDR5 SODIMM, up to 96GB
- Dual HDMI
- 2.5GbE LAN x 5 (IEEE 802.3 at PSE x 4)
- 9V-36V DC input with protection circuit
- Wide -25°C-60°C Operating Temperature
- Onboard TPM 2.0



Specifications

System	
CPU	13th Generation Intel® Core™ i7/i5/i3 Processors (28W): Intel® Core™ i3-1320PE Intel® Core™ i5-1340PE Intel® Core™ i7-1370PE
Chipset	Intel® SoC
System Memory	DDR5 SODIMM slot x 2, up to 96GB
Display Interface	HDMI x 2
Storage Device	Internal 2.5" SATA Drive Bay x 1 M.2 2280 M-Key x 1 (PCIe Gen 4 [x4]) for NVMe
Ethernet	Intel® Ethernet Controller I226-LM, 2.5GbE, RJ-45 x 5 (IEEE 802.3 at PoE PSE x 4) Note: PoE Power Budget: 20W (≥12V DC Input) 60W (≥19V DC Input)
I/O	USB 3.2 Gen 2 (Type-A) x 2 (10Gbps) USB 2.0 x 4 DB-9 for RS-232/422/485 x 2 Audio Jack x 1 for Mic-in/Line-out DB-15 for DIO 8-bit Power Button with LED Indicator x 1
Expansion	M.2 2230 E-Key x 1 (PCIe) M.2 3052 B-Key x 1 (USB 3.2/USB 2.0) SIM Slot x 1
Indicator	System Power
OS support	Windows® 10 IoT Enterprise LTSC 2021 Windows® 11 PRO Windows® 11 IoT Enterprise LTSC 2024 Ubuntu 24.04 above
Power Supply	
Power Requirement	9V – 36V DC input via 3-pin Terminal Block Connector with protection circuit
Mechanical	
Mounting	Wallmount, DIN Rail (optional)
Dimensions (W x H x D)	9.5" x 6.6" x 2.2" (242mm x 167mm x 56mm) w/o brackets
Gross Weight	7.1 lb (3.2 Kg)
Net Weight	5.3 lb (2.4 Kg)
Environmental	
Operating Temperature	-13°F ~140°F (-25°C ~ 60°C), IEC60068-2 with 0.7 m/s AirFlow, with wide temp. memory/storage
Storage Temperature	-40°F ~ 176°F (-40°C ~ 80°C)
Storage Humidity	5 ~ 95% @ 40°C, non-condensing
Anti-Vibration	SSD: Random, 3Grms, 5~500Hz
Anti-Shock	SSD: 50G @ wallmount, Half-sine, 11ms
Certification	CE/FCC class A





Dimension

Unit: mm

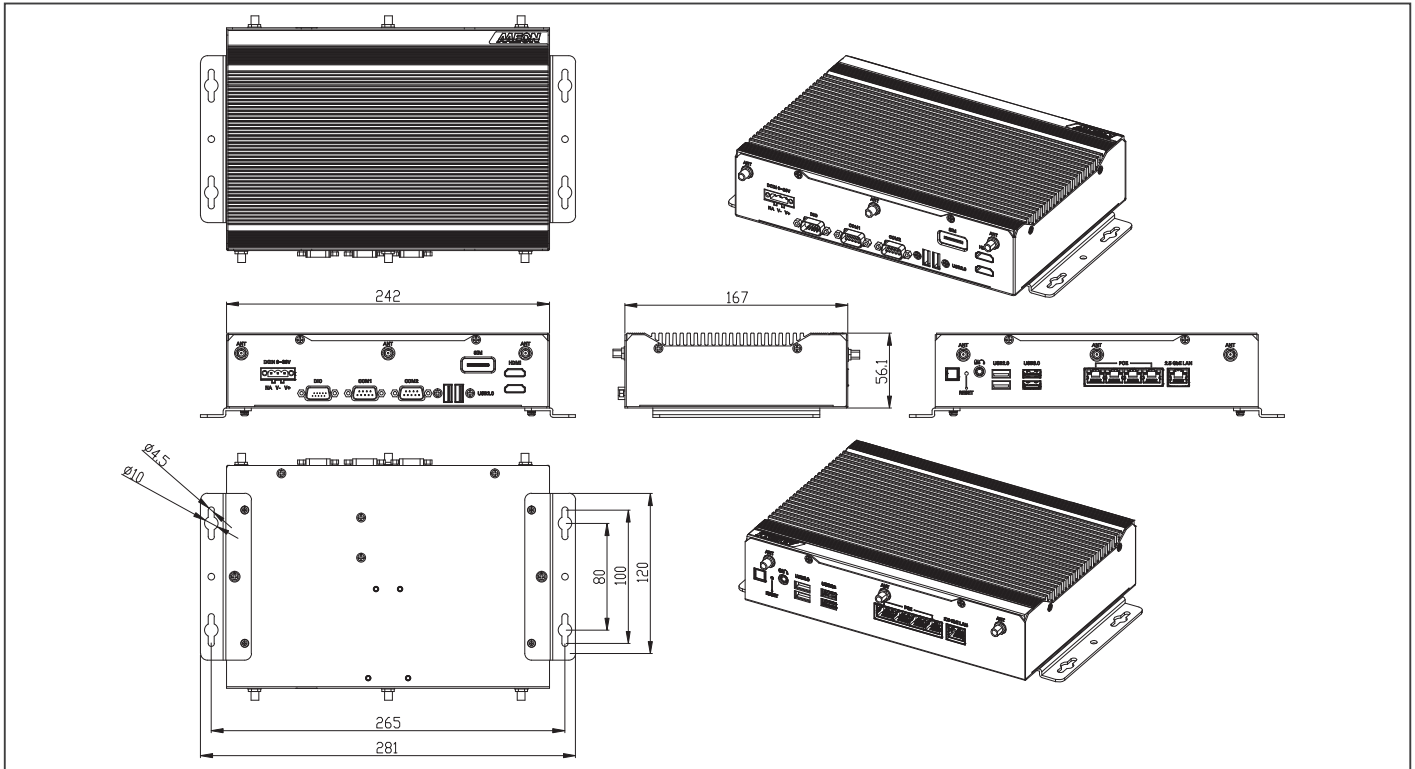

Ordering Information

Part Number	CPU	PCH	LAN	USB 3.2	USB 2.0	RS-232/422/485	Storage	Display	Expansion	Mounting	Power	Operation Temp.
BOXER-6649-RAP-A1-1010	Intel® Core™ i3-1320PE	SoC	2.5GbE LAN x 5 (IEEE802.3 at PoE PSE x 4)	2	4	2	M.2 2280 M Key Slot x 1 (NVMe SSD) 2.5" SATA Drive Bay x 1	HDMI x 2	M.2 2230 E-Key x 1 (PCIe) M.2 3052 B-Key x 1 (USB3.2/USB2.0) SIM Slot x 1	Wallmount, DIN Rail (optional)	9~36V DC in	-13°F ~140°F (-25°C ~ 60°C), IEC60068-2 with 0.7 m/s AirFlow, with wide temp. memory/storage
BOXER-6649-RAP-A2-1010	Intel® Core™ i5-1340PE	SoC	2.5GbE LAN x 5 (IEEE802.3 at PoE PSE x 4)	2	4	2	M.2 2280 M Key Slot x 1 (NVMe SSD) 2.5" SATA Drive Bay x 1	HDMI x 2	M.2 2230 E-Key x 1 (PCIe) M.2 3052 B-Key x 1 (USB3.2/USB2.0) SIM Slot x 1	Wallmount, DIN Rail (optional)	9~36V DC in	-13°F ~140°F (-25°C ~ 60°C), IEC60068-2 with 0.7 m/s AirFlow, with wide temp. memory/storage
BOXER-6649-RAP-A3-1010	Intel® Core™ i7-1370PE	SoC	2.5GbE LAN x 5 (IEEE802.3 at PoE PSE x 4)	2	4	2	M.2 2280 M Key Slot x 1 (NVMe SSD) 2.5" SATA Drive Bay x 1	HDMI x 2	M.2 2230 E-Key x 1 (PCIe) M.2 3052 B-Key x 1 (USB3.2/USB2.0) SIM Slot x 1	Wallmount, DIN Rail (optional)	9~36V DC in	-13°F ~140°F (-25°C ~ 60°C), IEC60068-2 with 0.7 m/s AirFlow, with wide temp. memory/storage

Packing List

- BOXER-6649-RAP x 1
- 3pin Terminal Block conntecor x 1 (for DC input)
- Screw Pack x 1
- Wallmount Kit x 1

Optional Accessories

- 1255X00102
180W AC to DC Power Adapter
- 170X000799
Power Cord (US Type)
- 170X001024
Power Cord (Europe)
- 170X000803
Power Cord (Japan)

04

04

Ultra Slim Fanless BOX PC Solutions



ES France - Mobilité & Systèmes Embarqués
127 rue de Buzenval BP 26 - 92380 Garches



Tél. 01 47 95 99 80



e-mail : mse@es-france.com
Site Web : www.es-france.com

BOXER-6404U

Compact Embedded Box PC with Intel® Celeron® Processor SoC

Front View



Rear View



Features

- Dual GbE LAN Port for Industrial Network Appliance
- 2.5" HDD/SDD Bay x 1
- USB 3.2 Gen 1 Port Connectivity
- 8-bit Programmable Digital Input/Output
- 12 ~ 24V DC-in Support



Specifications

System	
CPU	Intel® Celeron® J1900, 2.0 GHz Intel® Celeron® N2807, 1.58 GHz
Chipset	Intel® System on Chip
System Memory	DDR3L 1333 SODIMM slot x 1, up to 8 GB (J1900) or 4 GB (N2807)
Display Interface	VGA
Storage Device	mSATA, HDD/SSD
Ethernet	Intel® I211-AT x 2
I/O	RS-232 x 1 USB 2.0 x 1 USB 3.2 Gen 1 x 1 VGA x 1 LAN x 2 Digital I/O x 8 bit Antenna holes x 3 Power switch Power input
Expansion	Full-size Mini-Card x 1 Half Mini-Card x 1 (for mSATA) SIM card slot x 1
Indicator	Power LED HDD active LED
OS support	Windows® 10, Windows® 8.1, Windows® 7, Windows® Embedded 8, Windows® Embedded 7, Linux Fedora
Power Supply	
Power Requirement	12 - 24V with 3-pin terminal block
Mechanical	
Mounting	Wallmount VESA (Mounting kit is optional) DIN rail (Mounting kit is optional)
Dimensions (W x H x D)	6.53" x 4.20" x 1.63" (166 mm x 106.6 mm x 41.5 mm)
Gross Weight	3.6 lb (1.6 kg)
Net Weight	1.76 lb (0.8 kg)
Environmental	
Operating Temperature	-13°F ~ 140°F (-25°C ~ 60°C) with wide temperature HDD/mSATA (according to IEC68-2-14 with 0.5 m/s AirFlow; with industrial devices)
Storage Temperature	-22°F ~ 176°F (-30°C ~ 80°C)
Storage Humidity	95% @ 40°C, non-condensing
Anti-Vibration	5 Grms/ 5 ~ 500Hz/ operation –mSATA
Anti-Shock	—
Certification	CE/FCC class A





Dimension

Unit: mm

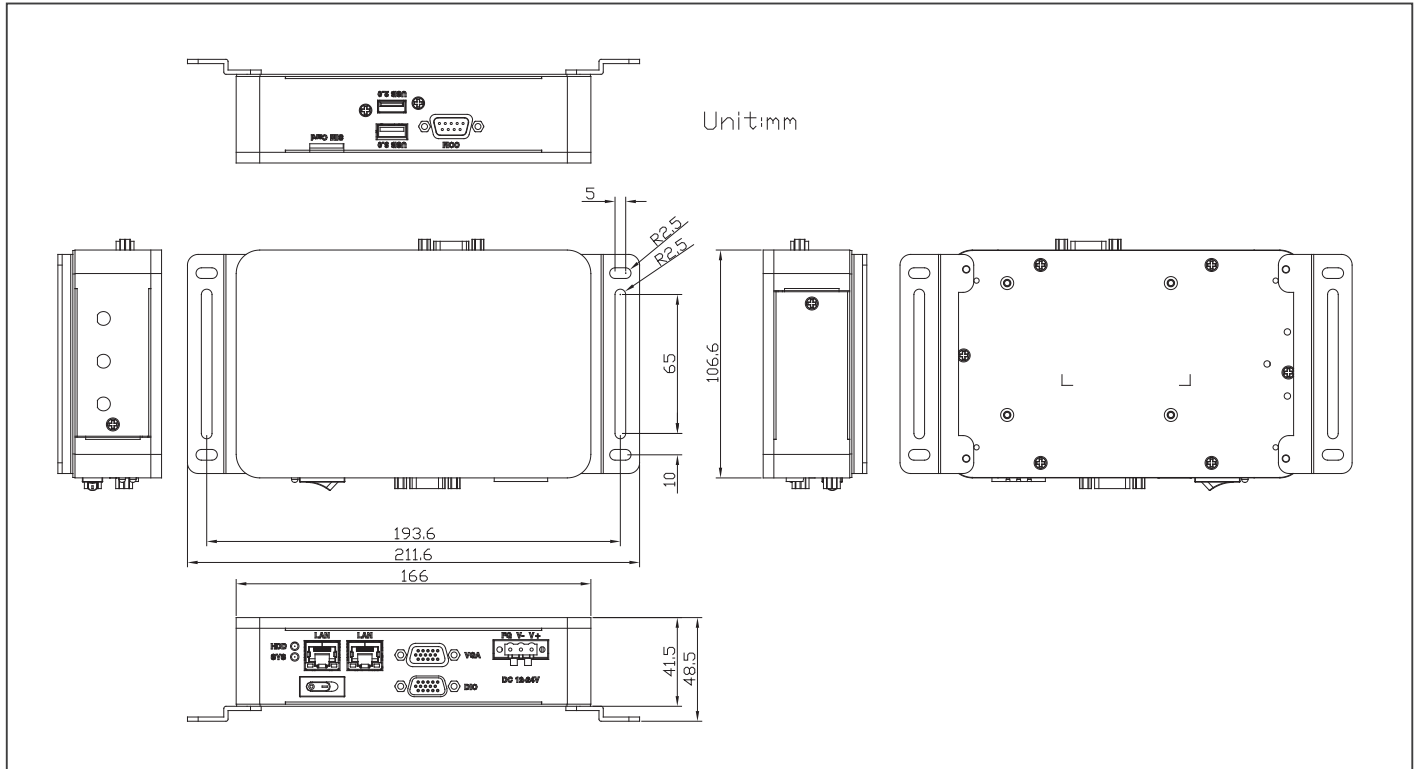

Ordering Information

Part Number	CPU	RAM	LAN	USB 3.2 Gen 1	USB 2.0	RS-232	Digital I/O	Storage	Display	Expansion	Mounting	Power	Operation Temp.
BOXER-6404U-A1-1011	Intel® J1900	—	2	1	1	1	8 bit	2.5" Drive Bay x 1, Half-size mSATA bay x 1	VGA x 1	Full-size Minicard x 1, Half-size Minicard x 1	Wallmount/Din Rail/ VESA 75	DC in 12~24V	-13°F ~ 140°F (-25°C ~ 60°C)
BOXER-6404U-A2-1011	Intel® N2807	—	2	1	1	1	8 bit	2.5" Drive Bay x 1, Half-size mSATA bay x 1	VGA x 1	Full-size Minicard x 1, Half-size Minicard x 1	Wallmount/Din Rail/ VESA 75	DC in 12~24V	-13°F ~ 140°F (-25°C ~ 60°C)

Packing List

- Wallmount Bracket x 2
- Phoenix Power Connector x 1
- BOXER-6404U

Optional Accessories

- 125530040F
Power Adapter
- 170X000799
Power Cord (US type)
- 170X000800
Power Cord (European Type)
- 170X000803
Power Cord (Japanese Type)
- 9741238H00
WiFi Module & Antenna
- 9741EG25G0
4G Module & Antenna (for global)
- 9741640403
VESA Mount Kit
- 9741640404
Din rail Mount Kit

BOXER-6404

Compact Embedded Box PC with LAN x 4, HDMI x 2, Intel® Celeron® J1900/N2807 Processor SoC

Front View

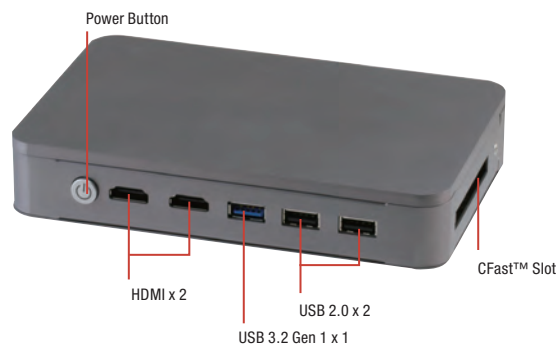

Rear View

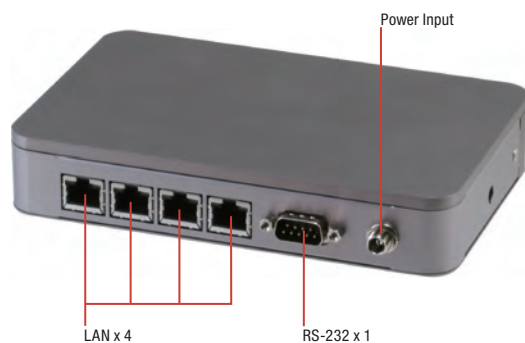

Features

- Slim Boxer Design: 30mm
- RJ-45 LAN Port x 4, HDMI Port x 2
- Operating in -22°F ~ 149°F (-30°C ~ 65°C) Environment



Specifications

System	
CPU	Intel® Celeron® J1900, 2.0 GHz Intel® Celeron® N2807, 1.58 GHz
Chipset	Intel® System on Chip
System Memory	DDR3L 1333 SODIMM slot x 1, up to 8 GB (J1900) or 4 GB (N2807)
Display Interface	HDMI (max. 1920 x 1080)
Storage Device	CFast™
Ethernet	Intel® I210AT, 10/100/1000Base-TX x 4
I/O	RS-232 x 1 USB 2.0 x 2 USB 3.2 Gen 1 x 1 HDMI x 2 LAN x 4 CFast slot x 1 Antenna holes x 1 Power button Power input
Expansion	Full-size Mini-Card (USB interface only) x 1
Indicator	Power LED on power button
OS support	Windows® 10, Windows® 8.1, Windows® 7, Windows® Embedded 8, Windows® Embedded 7, Linux Fedora
Power Supply	
Power Requirement	12V - 24V with lockable DC jack
Mechanical	
Mounting	VESA (Mounting kit is optional) DIN rail (Mounting kit is optional)
Dimensions (W x H x D)	6.53" x 4.20" x 1.18" (166 mm x 106.6 mm x 30 mm)
Gross Weight	2.9 lb (1.3 kg)
Net Weight	1.9 lb (0.86 kg)
Environmental	
Operating Temperature	-22°F ~ 149°F (-30°C ~ 65°C) with wide temperature CFast™ card (according to IEC68-2-14 with 0.5 m/s AirFlow; with industrial devices)
Storage Temperature	-22°F ~ 176°F (-30°C ~ 80°C)
Storage Humidity	95% @ 40°C, non-condensing
Anti-Vibration	5 Grms/ 5 ~ 500Hz/ operation -CFast™ card
Anti-Shock	—
Certification	CE/FCC class A





Dimension

Unit: mm

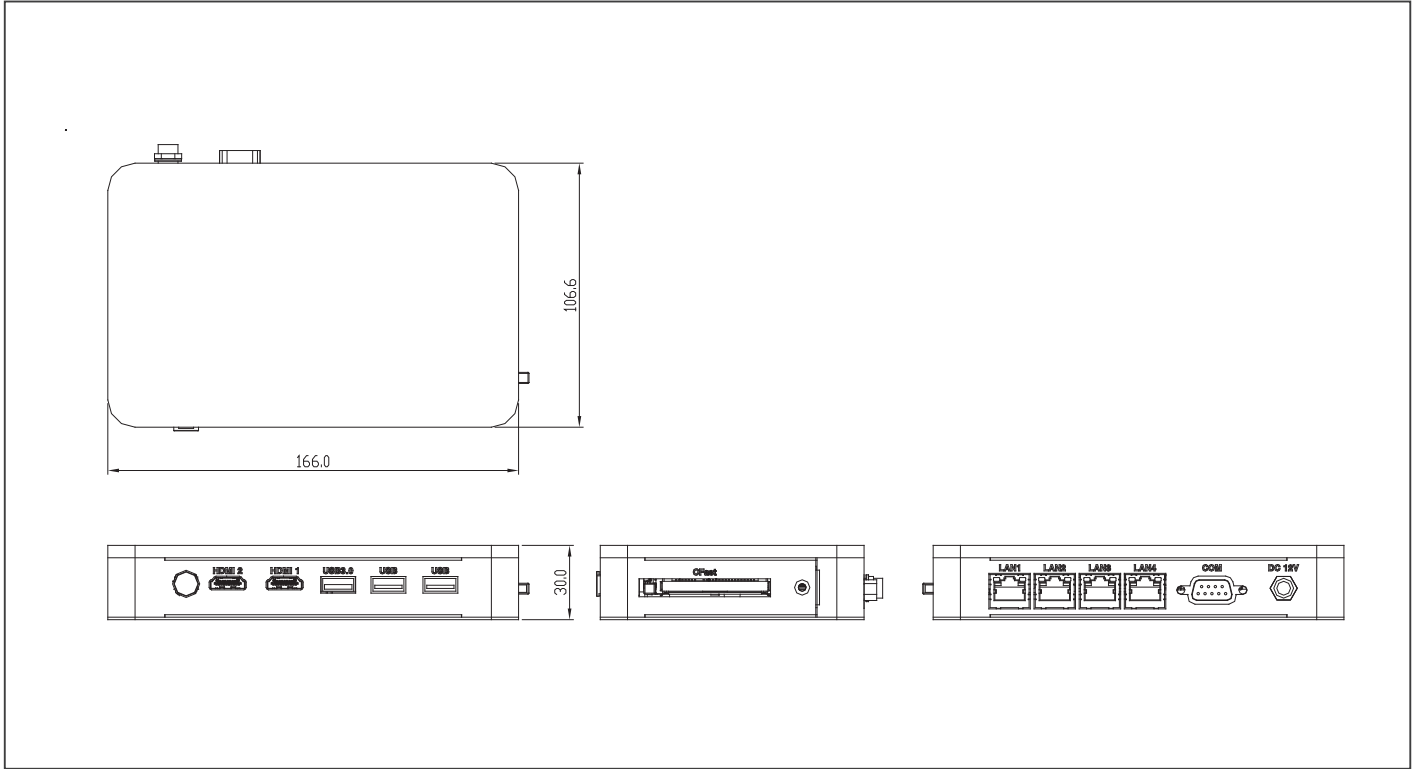

Ordering Information

Part Number	CPU	RAM	LAN	Display	USB 3.2 Gen 1	USB 2.0	RS-232	Storage	Expansion	Power	Operating Temp.
BOXER-6404-A1-1210	Intel® J1900	—	4	HDMI x 2	1	2	1	CFast™	Mini-Card x 1 (USB Interface)	12V - 24V DC in	-30 ~ 65°C with 0.5 m/s airflow
BOXER-6404-A2-1210	Intel® J1900	—	2	HDMI x 1	1	2	1	CFast™	Mini-Card x 1 (USB Interface)	12V - 24V DC in	-30 ~ 65°C with 0.5 m/s airflow
BOXER-6404-A3-1210	Intel® N2807	—	4	HDMI x 2	1	2	1	CFast™	Mini-Card x 1 (USB Interface)	12V - 24V DC in	-30 ~ 65°C with 0.5 m/s airflow
BOXER-6404-A4-1210	Intel® N2807	—	2	HDMI x 1	1	2	1	CFast™	Mini-Card x 1 (USB Interface)	12V - 24V DC in	-30 ~ 65°C with 0.5 m/s airflow

Packing List

- 125530040C
Power Adapter
- BOXER-6404

Optional Accessories

- 170X000799
Power Cord (US type)
- 170X000800
Power Cord (European Type)
- 170X000803
Power Cord (Japanese Type)
- 9741236A00
WiFi Module & Antenna
- 9741EG25G0
4G Module & Antenna (for global)
- 9741640400
VESA Mount Kit
- 9741640401
DIN Rail Mount Kit
- 9741640402
CFast™ Cover Kit

BOXER-6404WT

Wide Temperature Compact Embedded Box PC with Intel® Celeron® J1900/ N2807 Processor SoC

Front View

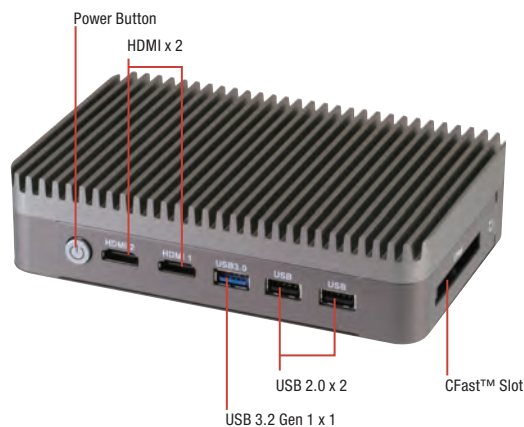

Rear View

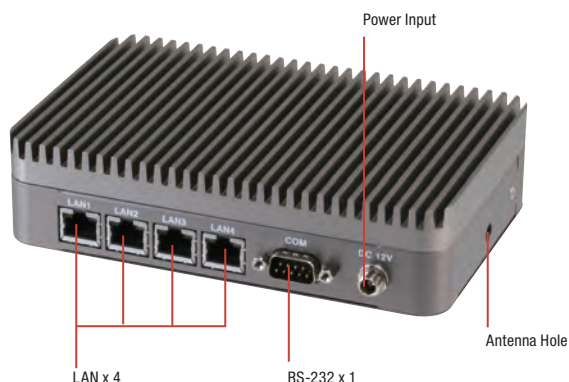

Features

- Quad GbE LAN Port for Industrial Network Appliance
- Dual HDMI Port
- USB 3.2 Gen 1 Port Connectivity
- Easy Access Storage Bay
- Operating in -22°F ~ 167°F (-30°C ~ 75°C) Environment



Specifications

System	
CPU	Intel® Celeron® J1900, 2.0 GHz Intel® Celeron® N2807, 1.58 GHz
Chipset	Intel® System on Chip
System Memory	DDR3L 1333 SODIMM slot x 1, up to 8 GB (J1900) or 4 GB (N2807)
Display Interface	HDMI
Storage Device	CFast™
Ethernet	Intel® I210AT, 10/100/1000Base-TX x 4
I/O	RS-232 x 1 USB 2.0 x 2 USB 3.2 Gen 1 x 1 HDMI x 2 LAN x 4 CFast™ slot x 1 Antenna holes x 1 Power button Power input
Expansion	Full-size Mini-Card (USB interface only) x 1
Indicator	Power LED on power button
OS support	Windows® 10, Windows® 8.1, Windows® 7, Windows® Embedded 8, Windows® Embedded 7, Linux Fedora
Power Supply	
Power Requirement	12V - 24V with lockable DC jack
Mechanical	
Mounting	VESA (Mounting kit is optional) DIN rail (Mounting kit is optional)
Dimensions (W x H x D)	6.53" x 4.20" x 1.59" (166mm x 106.6mm x 40.5mm)
Gross Weight	3.59 lb (1.63 kg)
Net Weight	2.6 lb (1.17 kg)
Environmental	
Operating Temperature	-22°F ~ 167°F (-30°C ~ 75°C) with wide temperature CFast™ card (according to IEC68-2-14 with 0.5 m/s AirFlow; with industrial devices)
Storage Temperature	-22°F ~ 176°F (-30°C ~ 80°C)
Storage Humidity	95% @ 40°C, non-condensing
Anti-Vibration	5 Grms/ 5 ~ 500Hz/ operation -CFast™ card
Anti-Shock	—
Certification	CE/FCC class A





Dimension

Unit: mm

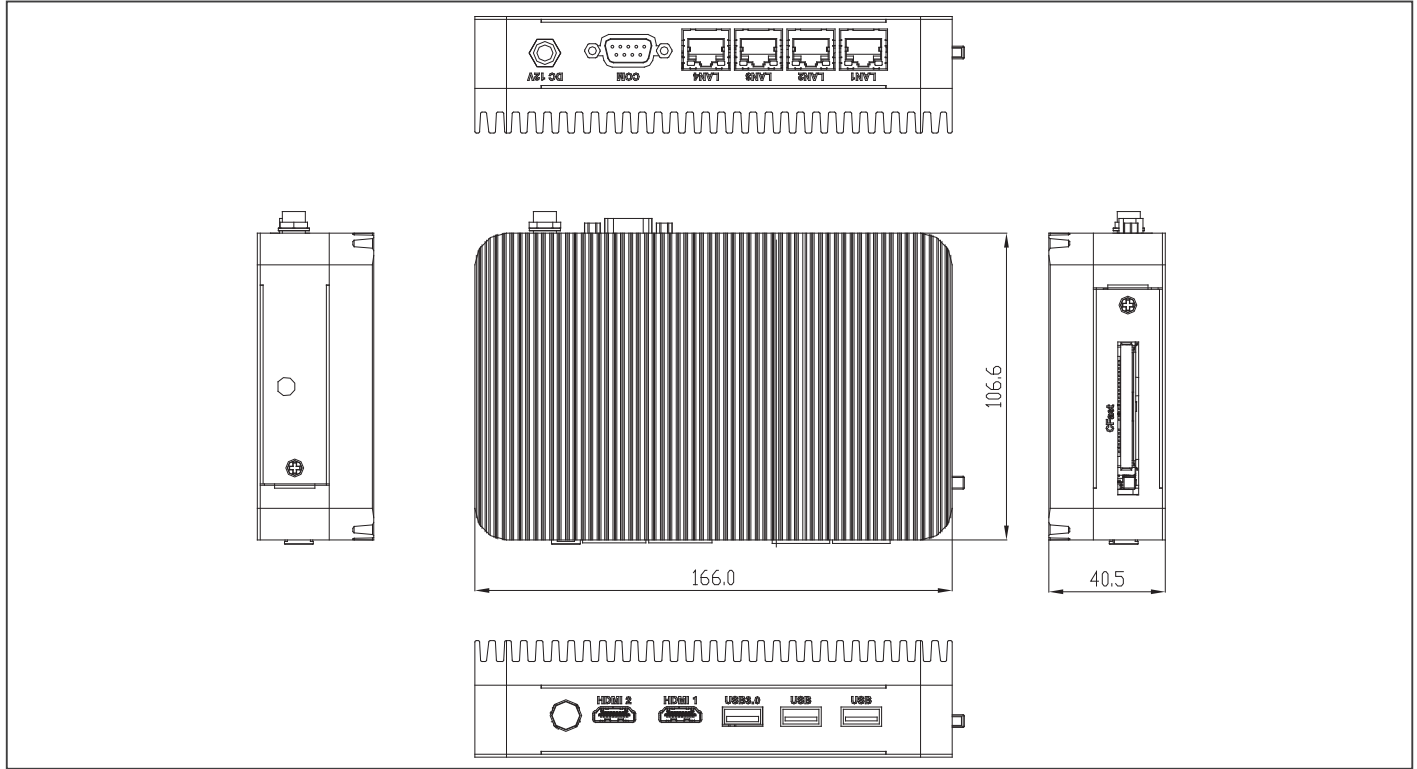

Ordering Information

Part Number	CPU	RAM	LAN	USB 3.2 Gen 1	USB 2.0	RS-232	Storage	Display	Expansion	Mounting	Power	Operating Temp.
BOXER-6404WT-A1-1210	Intel® J1900	—	4	1	2	1	CFast™ bay x 1	HDMI x 2	Full size Mini-card slot x 1 (USB signal)	Din Rail/VESA 75	12V - 24V DC in	-22°F ~ 167°F (-30°C ~ 75°C) with 0.5m/s airflow
BOXER-6404WT-A2-1210	Intel® N2807	—	2	1	2	1	CFast™ bay x 1	HDMI x 1	Full size Mini-card slot x 1 (USB signal)	Din Rail/VESA 75	12V - 24V DC in	-22°F ~ 167°F (-30°C ~ 75°C) with 0.5m/s airflow

Packing List

- 125530040C
Power Adapter
- BOXER-6404WT

Optional Accessories

- 170X000799
Power Cord (US type)
- 170X000800
Power Cord (European Type)
- 170X000803
Power Cord (Japanese Type)
- 9741236A00
WiFi Module & Antenna
- 9741EG25G0
4G Module & Antenna (for global)
- 9741640400
VESA Mount Kit
- 9741640401
DIN Rail Mount Kit
- 9741640402
CFast™ Cover Kit

BOXER-6404M

Wide Temperature Compact Embedded Box PC with LAN x 4, HDMI x 2, Intel® Celeron® J1900/N2807 Processor SoC

Front View

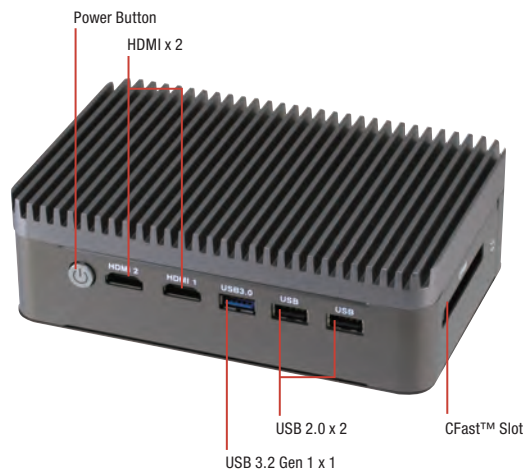

Rear View

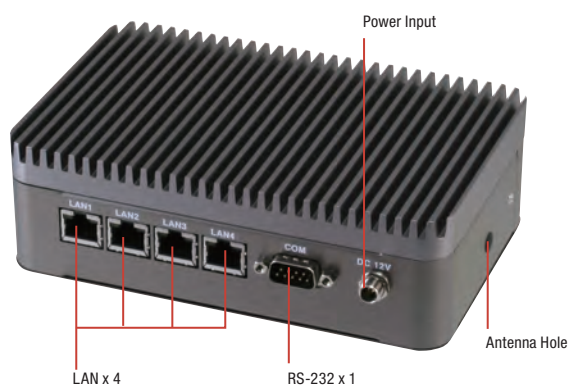

Features

- Quad GbE LAN Port for Industrial Network Appliance
- 2.5" HDD/SSD Bay x 1
- Dual HDMI Port
- USB 3.2 Gen 1 Port Connectivity
- Easy Access Storage Bay
- Operating in -22°F ~ 167°F (-30°C ~ 75°C) Environment



Specifications

System	
CPU	Intel® Celeron® J1900, 2.0 GHz Intel® Celeron® N2807, 1.58 GHz
Chipset	Intel® System on Chip
System Memory	DDR3L 1333 SODIMM slot x 1, up to 8 GB (J1900) or 4 GB (N2807)
Display Interface	HDMI
Storage Device	CFast™, HDD/SSD
Ethernet	Intel® I210AT, 10/100/1000Base-TX x 4
I/O	RS-232 x 1 USB 2.0 x 2 USB 3.2 Gen 1 x 1 HDMI x 2 LAN x 4 CFast slot x 1 Antenna hole x 1 Power button Power input
Expansion	Full-size Mini-Card (USB interface only) x 1
Indicator	Power LED on power button
OS support	Windows® 10, Windows® 8.1, Windows® 7, Windows® Embedded 8, Windows® Embedded 7, Linux Fedora
Power Supply	
Power Requirement	12V - 24V with lockable DC jack
Mechanical	
Mounting	VESA (Mounting kit is optional) DIN rail (Mounting kit is optional)
Dimensions (W x H x D)	6.53" x 4.20" x 2.05" (166mm x 106.6mm x 52mm)
Gross Weight	3.81 lb (1.73 kg)
Net Weight	2.8 lb (1.27 kg)
Environmental	
Operating Temperature	-22°F ~ 167°F (-30°C ~ 75°C) with wide temperature CFast™ card (according to IEC68-2-14 with 0.5 m/s AirFlow; with industrial devices)
Storage Temperature	-22°F ~ 176°F (-30°C ~ 80°C)
Storage Humidity	95% @ 40°C, non-condensing
Anti-Vibration	5 Grms/ 5 ~ 500Hz/ operation -CFast™ card or SSD 1 Grms/ 5 ~ 500Hz/ operation -HDD
Anti - Shock	—
Certification	CE/FCC class A





Dimension

Unit: mm

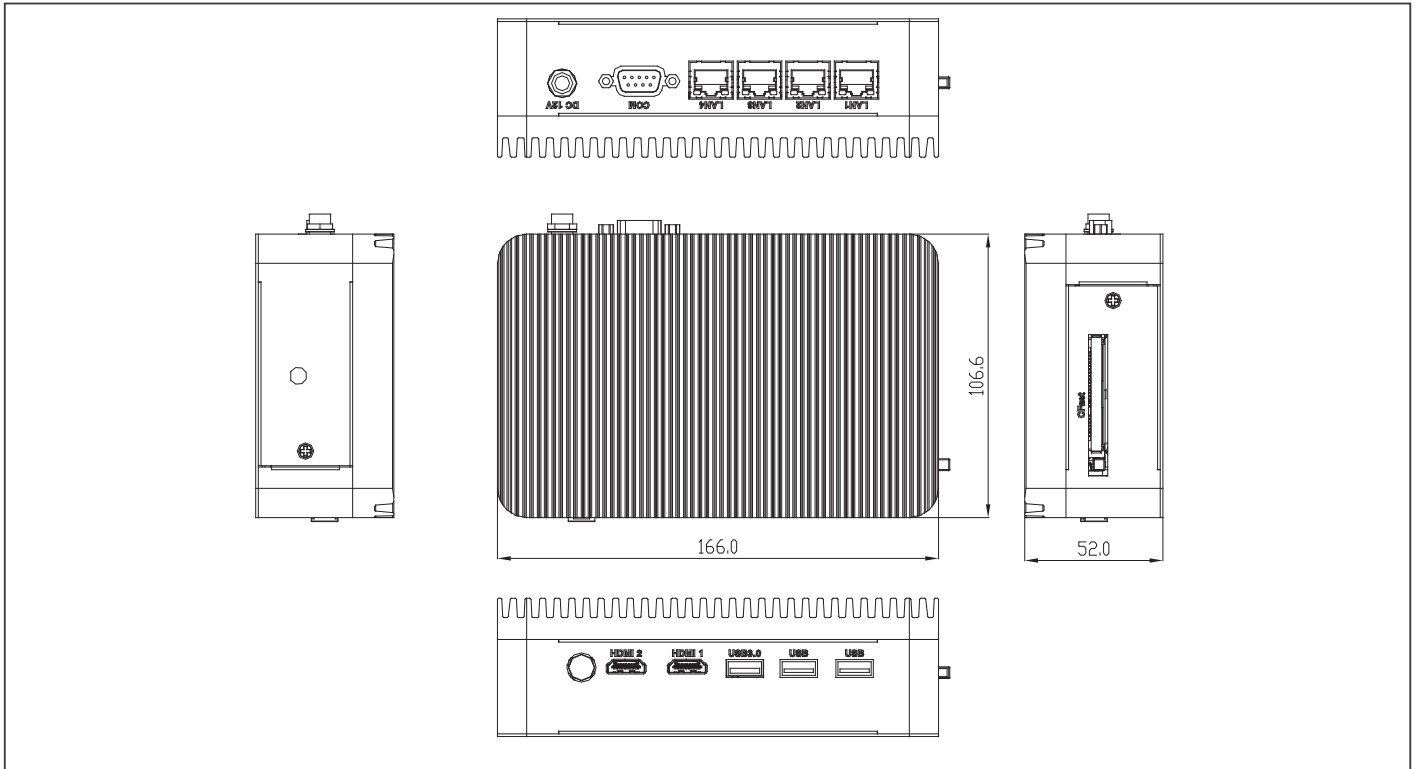

Ordering Information

Part Number	CPU	RAM	LAN	USB 3.2 Gen 1	USB 2.0	RS-232	Storage	Display	Expansion	Mounting	Power	Operating Temp.
BOXER-6404M-A1-1210	Intel® J1900	—	4	1	2	1	CFast™ bay x 1 2.5" HDD/SSD bay x 1	HDMI x 2	Full size Mini-card slot x 1 (USB signal)	Din Rail/VESA 75	12V - 24V DC in	-30°C ~ 75°C (-22°F ~ 167°F) with 0.5m/s airflow
BOXER-6404M-A2-1210	Intel® N2807	—	2	1	2	1	CFast™ bay x 1 2.5" HDD/SSD bay x 1	HDMI x 1	Full size Mini-card slot x 1 (USB signal)	Din Rail/VESA 75	12V - 24V DC in	-30°C ~ 75°C (-22°F ~ 167°F) with 0.5m/s airflow

Packing List

- 125530040C
Power Adapter
- BOXER-6404M

Optional Accessories

- 170X000799
Power Cord (US type)
- 170X000800
Power Cord (European Type)
- 170X000803
Power Cord (Japanese Type)
- 9741236A00
WiFi Module & Antenna
- 9741EG25G0
4G Module & Antenna (for global)
- 9741640400
VESA Mount Kit
- 9641640401
DIN Rail Mount Kit
- 9741640402
CFast™ Cover Kit

BOXER-6405

Fanless Compact Embedded Computer with Intel® Celeron®/Pentium® Processor

Front View

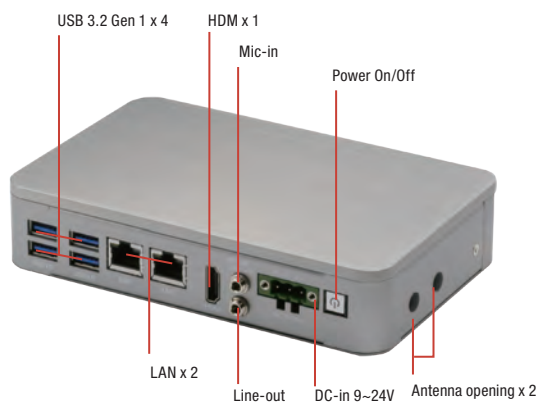

Rear View

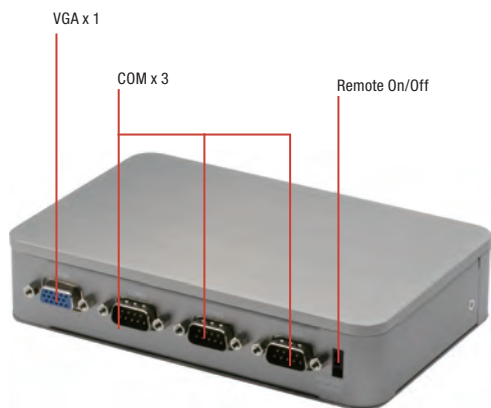

Features

- Slim Boxer Design: 37mm
- Rich I/O, Design for Auto System Control
- Wide Operating Temperature -20°C ~ 60°C
- Gigabit Ethernet x 2, USB x 4
- Support Wallmount



Specifications

System	
CPU	Intel® Celeron®/Pentium® processor
Chipset	Intel® System on Chip
System Memory	DDR3L 1866, Single Channel SODIMM x 1, Non-ECC (Max.8GB, up to 1600MHz)
Display Interface	HDMI (max. 1920 x 1080)
Storage Device	mSATA
Ethernet	Intel® i211-AT x 2
I/O	Power Button x 1 USB Type A x 4 for USB 3.2 Gen 1 HDMI type A x 1 for HDMI v1.4b RJ-45 x 2 for GbE LAN with LED indicator (i211-AT x 2) Power input x 1 3-pin terminal block in default (+, -, GND) Co-layout 3-pin terminal block & lockable DC-in jack, Co-layout internal DC Mic-in x 1, Line-out x 1 RS-232/422/485 x 3 with automatic flow control (switch by BIOS) VGA x 1 Remote On/Off Antenna opening x 2 DC-in 3-pin terminal block(9~24V) x 1
Expansion	Full-size Mini PCIe slot x 1 (PCIe/USB/SIM slot), one screw Half-size Minicard slot x 1 (mSATA only)
Indicator	Power LED x1, HDD active LED x1
OS Support	Windows® 10, Windows® 10 IoT, Linux
Power Supply	
Power Requirement	9-24V with 3-pin terminal block
Mechanical	
Mounting	Wallmount
Dimensions (W x H x D)	6.54" x 4.2" x 1.45" (166mm x 106.6mm x 37mm)
Gross Weight	3.6 lb (1.6kg)
Net Weight	1.76 lb (0.8 kg)
Environmental	
Operating Temperature	-4°F ~ 140°F (-20°C ~ 60°C) with W.T. mSATA (according to IEC68-2-14 with 0.5 m/s AirFlow; with industrial decives)
Storage Temperature	-22°F ~ 140°F (-30°C ~ 60°C)
Storage Humidity	95% @ 40°C, non-condensing
Anti-Vibration	3 Grms/ 5 ~ 500Hz/ operation – mSATA 1 Grms/ 5 ~ 500Hz/ operation - HDD
Anti-Shock	—
Certification	CE/FCC class A





Dimension

Unit: mm

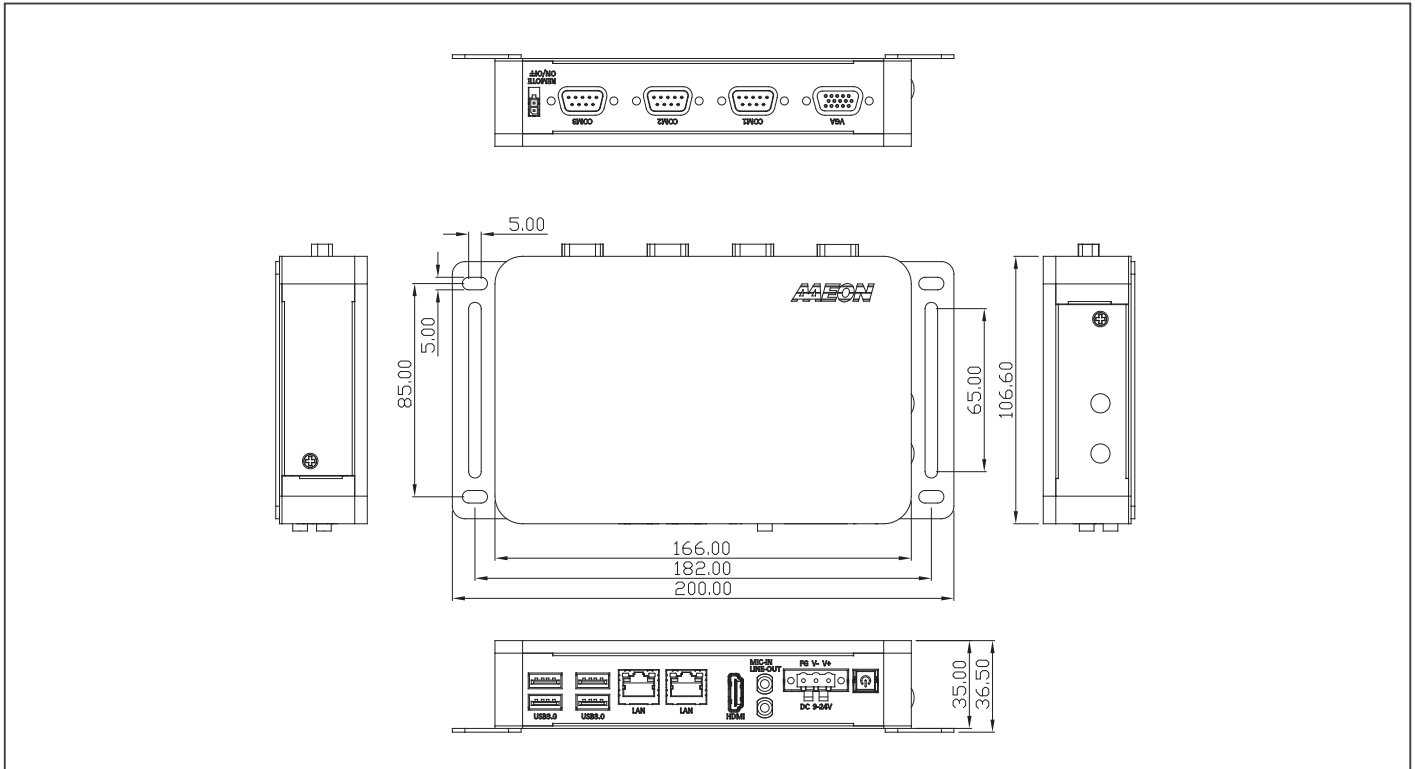

Ordering Information

Part Number	CPU	PCH	RAM	LAN	USB 3.2 Gen 1	USB 2.0	RS-232	RS-232/422/485	Digital I/O	Audio	Storage	Display	Expansion	Mounting	Power	Operation temp.
BOXER-6405-A1-1011	N3350	SoC	—	2	4	—	—	3	—	MIC-in, Line-out	mSATA x 1	VGA/ HDMI x1	Full-size Minitcard x 1 Half-size Minitcard x 1	Wallmount	9~24V	-20°C ~ 60°C
BOXER-6405-A2-1011	N4200	SoC	—	2	4	—	—	3	—	MIC-in, Line-out	mSATA x 1	VGA/ HDMI x1	Full-size Minitcard x 1 Half-size Minitcard x 1	Wallmount	9~24V	-20°C ~ 60°C

Packing List

- Wallmount Bracket x 2
- 3 Pin DC-In Power Connector x 1
- BOXER-6405

Optional Accessories

- **125530040F**
Power Adapter
- **170X000799**
Power Cord (US type)
- **170X000800**
Power Cord (European Type)
- **170X000803**
Power Cord (Japanese Type)
- **9741238H00**
WiFi Module & Antenna
- **9741EG25G0**
4G Module & Antenna (for global)
- **9741640404**
Din Rail Mount Kit

BOXER-6405M

Fanless Compact Embedded Computer with Intel® Celeron®/Pentium® Processor

Front View

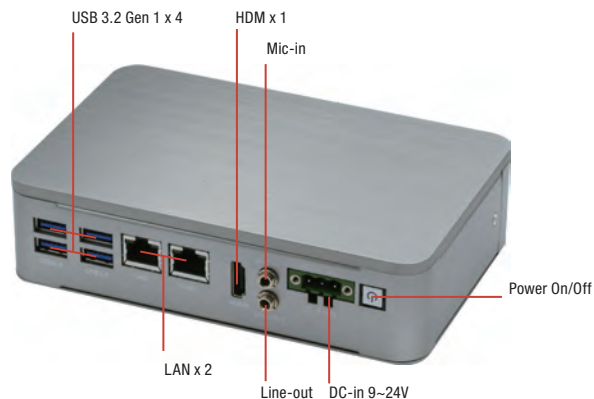

Rear View

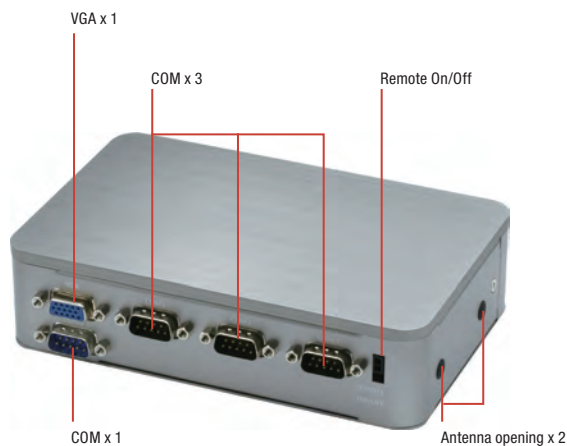

Features

- Slim Boxer Design: 42mm
- Rich I/O, Design for Auto System Control
- Wide Operating Temperature -20°C ~ 60°C
- Gigabit Ethernet x 2, USB x 4
- Support Wallmount



Specifications

System	
CPU	Intel® Celeron®/Pentium® processor
Chipset	Intel® System on Chip
System Memory	DDR3L 1866, Single Channel SODIMM x 1, Non-ECC (Max.8GB, up to 1600MHz)
Display Interface	HDMI type A x 1 for HDMI v1.4b VGA x 1
Storage Device	HDD/SSD, (mSATA BOM option)
Ethernet	Intel® i211-AT x 2
I/O	Power Button x 1 USB Type A x 4 for USB 3.2 Gen 1 HDMI type A x 1 for HDMI v1.4b RJ-45 x 2 for GbE LAN with LED indicator (i211-AT x 2) Power input x 1 3-pin terminal block in default (+, -, GND) Co-layout 3-pin terminal block & lockable DC-in jack.) Co-layout internal DC Mic-in x 1, Line-out x 1 RS-232/422/485 x 4 with automatic flow control (switch by BIOS) VGA x 1 Remote On/Off Antenna opening x 2
Expansion	Full-size Mini PCIe slot x 1 (PCIe/USB/SIM slot), one screw Half-size Minicard slot x 1 (optional for mSATA,PCIe/mSATA)
Indicator	Power LED x 1, HDD active LED x 1
OS Support	Windows® 10, Windows® 10 IoT, Linux
Power Supply	
Power Requirement	3-pin Phoenix DC Input 9~24V without power protection
Mechanical	
Mounting	Wallmount
Dimensions (W x H x D)	6.54" x 4.2" x 1.65" (166mm x 106.6mm x 42mm)
Gross Weight	3.6 lb (1.6kg)
Net Weight	1.7 lb (0.8 kg)
Environmental	
Operating Temperature	-4°F ~ 140°F (-20°C ~ 60°C) with W.T. mSATA (according to IEC68-2-14 with 0.5 m/s AirFlow; with industrial decives)
Storage Temperature	-22°F ~ 140°F (-30°C ~ 60°C)
Storage Humidity	95% @ 40°C, non-condensing
Anti-Vibration	3 Grms/ 5 ~ 500Hz/ operation – mSATA 1 Grms/5 ~ 500Hz/ operation - HDD
Anti - Shock	—
Certification	CE/FCC class A





Dimension

Unit: mm

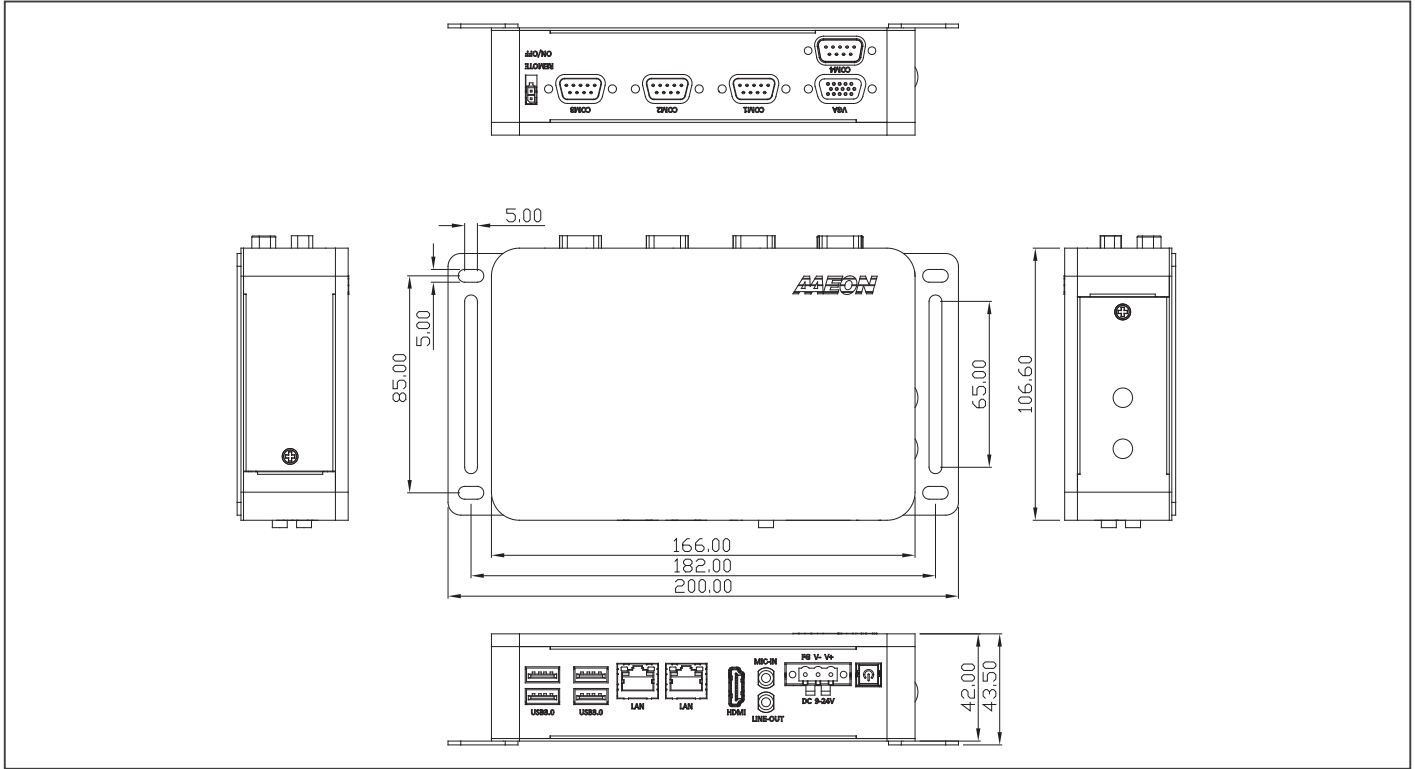

Ordering Information

Part Number	CPU	RAM	LAN	USB 3.2 Gen 1	USB 2.0	RS-232	RS-232/422/485	Digital I/O	Audio	Storage	Display	Expansion	Mounting	Power	Operation temp.
BOXER-6405M-A1-1011	Intel® N3350	—	2	4	—	—	4	—	MIC-in, Line-out	SSD/HDD x 1	VGA/HDMI x1	Full-size Minicard x1 Half-size Minicard x 1	Wallmount	9~24V	-20°C ~ 60°C
BOXER-6405M-A2-1011	Intel® N4200	—	2	4	—	—	4	—	MIC-in, Line-out	SSD/HDD x 1	VGA/HDMI x1	Full-size Minicard x1 Half-size Minicard x 1	Wallmount	9~24V	-20°C ~ 60°C

Packing List

- Wallmount Bracket x 2
- 3 Pin DC-In Power Connector x 1
- BOXER-6405M

Optional Accessories

- 125530040F
Power Adapter
- 170X000799
Power Cord (US type)
- 170X000800
Power Cord (European Type)
- 170X000803
Power Cord (Japanese Type)
- 9741238H00
WiFi Module & Antenna
- 9741EG25G0
4G Module & Antenna (for global)
- 9741640404
Din Rail Mount Kit

BOXER-6406-ADN

Fanless Compact Embedded Computer with Intel Atom® Processor X-series/N-series (formerly Alder Lake-N)

Front View

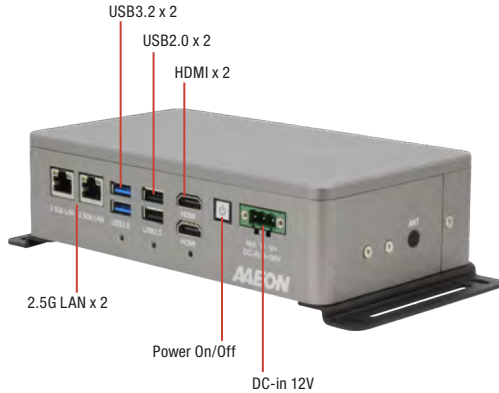

Rear View

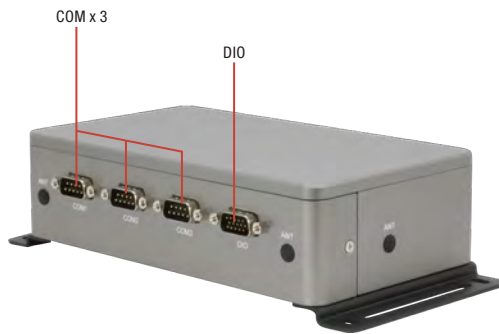

Features

- Intel Atom® Processor X-series/N-series (formerly Alder Lake-N)
- DDR5 4800Mhz SODIMM
- 2.5GbE x 2
- M.2 2280 M-Key x 1, M.2 2230 E-Key x 1
- USB 3.2 Gen 2 x 2 (Type-A)
- Onboard TPM 2.0
- Wide Range 9 ~ 36V DC input
- Wide Operating Temperature -20 ~ 60°C
- Compact Size



Specifications

System	
CPU	Intel® Processor N200 Intel® Processor N50 Intel Atom® x7211E
Chipset	Intel® SoC
System Memory	DDR5 4800Mhz SODIMM x 1, up to 32GB
Display Interface	HDMI x 2
Storage Device	M.2 2280 M-Key x 1 (PCIe Gen 3 x 2) 2.5" SATA HDD/SSD x 1
Ethernet	RJ-45 x 2 for 2.5GbE LAN (Intel® I226-LM)
I/O	HDMI x 2 RJ-45 x 2 for 2.5GbE LAN (Intel® I226-LM) USB 3.2 Gen 2 x 2 (Type-A) USB 2.0 x 2 (Type-A) DB-9 x 3 for RS-232/422/485 DB-15 x 1 Male for Digital I/O 8-Channel 3-pin Terminal Block for DC In x 1 Power Button with LED x 1
Expansion	M.2 2280 M-Key x 1 (PCIe [x2]) M.2 2230 E-Key x 1 Full-Size Mini Card x 1 (PCIe + USB) SIM Slot x 1
Indicator	—
OS support	Windows® 10 IoT Enterprise Windows® 11 IoT Enterprise Windows® 11 Pro Linux Ubuntu 22.04
Power Supply	
Power Requirement	9 ~ 36V DC-In x 1 for 3-pin Terminal Block
Mechanical	
Mounting	Wallmount
Dimensions (W x H x D)	7.32" x 4.12" x 1.93" (186mm x 104.6mm x 49.1mm) without bracket 8.74" x 4.12" x 2.21" (222mm x 104.6mm x 56.1mm) with bracket
Gross Weight	4.32 lb (1.96 Kg)
Net Weight	2.56 lb (1.16 Kg)
Environmental	
Operating Temperature	-4°F ~ 140°F (-20°C ~ 60°C), according to IEC68-2 with 0.5 m/s AirFlow (w/ Industrial wide Temp. SSD/RAM)
Storage Temperature	-40°F ~ 176°F (-40°C ~ 80°C)
Storage Humidity	5 ~ 95% @ 40°C, non-condensing
Anti-Vibration	3 Grms/ 5 ~ 500Hz/ operation (with SSD)
Anti-Shock	50G, IEC 68-2-27, half sine, 11 ms duration (with SSD)
Certification	CE/FCC Class A





Dimension

Unit: mm

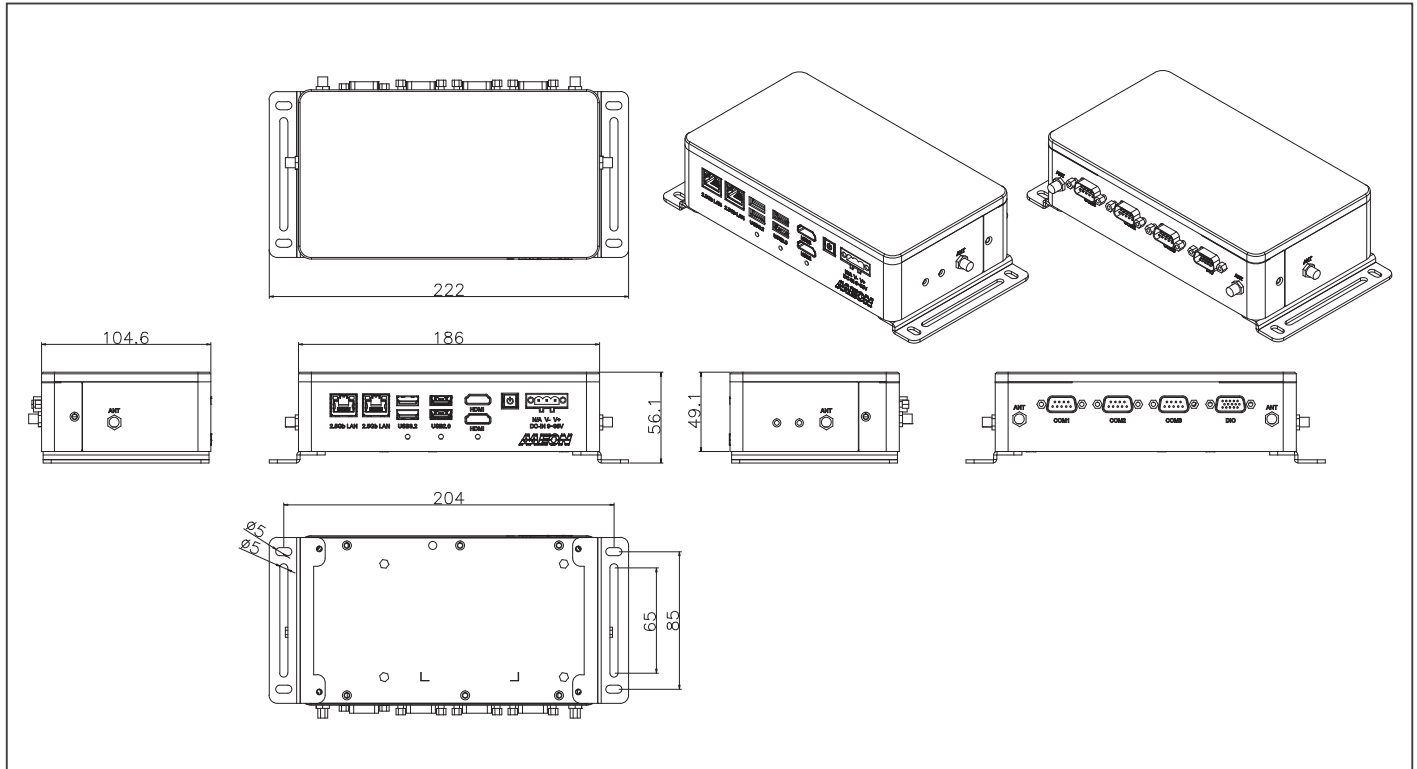

Ordering Information

Part Number	CPU	LAN	PCH	USB 3.2 Gen 2	USB 2.0	RS-232/422/485	Storage	Display	Expansion	Mounting	Power	Operation Temp.
BOXER-6406-ADN-A1-1010	Intel® Processor N200	2	Intel SoC	2	2	3	M.2 2280 M-Key x 1 (PCIe Gen 3 [x2]) 2.5" SATA Drive Bay x 1	HDMI x 2	M.2 2280 M-Key x 1 (PCIe Gen 3 [x2]) M.2 2230 E-Key x 1 Full-Size Mini Card x 1 (PCIe + USB) SIM Slot x 1	Wallmount	9-36V DC in	-4°F ~ 140°F (-20°C ~ 60°C), according to IEC68-2 with 0.5 m/s AirFlow (w/ Industrial wide Temp. SSD/RAM)
BOXER-6406-ADN-A2-1010	Intel® Processor N50	2	Intel SoC	2	2	3	M.2 2280 M-Key x 1 (PCIe Gen 3 [x2]) 2.5" SATA Drive Bay x 1	HDMI x 2	M.2 2280 M-Key x 1 (PCIe Gen 3 [x2]) M.2 2230 E-Key x 1 Full-Size Mini Card x 1 (PCIe + USB) SIM Slot x 1	Wallmount	9-36V DC in	-4°F ~ 140°F (-20°C ~ 60°C), according to IEC68-2 with 0.5 m/s AirFlow (w/ Industrial wide Temp. SSD/RAM)
BOXER-6406-ADN-A3-1010	Intel Atom® x7211E	2	Intel SoC	2	2	3	M.2 2280 M-Key x 1 (PCIe Gen 3 [x2]) 2.5" SATA Drive Bay x 1	HDMI x 2	M.2 2280 M-Key x 1 (PCIe Gen 3 [x2]) M.2 2230 E-Key x 1 Full-Size Mini Card x 1 (PCIe + USB) SIM Slot x 1	Wallmount	9-36V DC in	-4°F ~ 140°F (-20°C ~ 60°C), according to IEC68-2 with 0.5 m/s AirFlow (w/ Industrial wide Temp. SSD/RAM)

Packing List

- Wallmount Bracket x 2
- Screw Package x 1
- 3 Pin DC-In Power Connector x 1
- BOXER-6406-ADN x 1

Optional Accessories

- 1255900849
12V 84W Power Adapter
- 170X000799
Power Cord (US type)
- 170X001024
Power Cord (European Type)
- 170X000803
Power Cord (Japanese Type)
- 0741EG25G0

BOXER-6406-ASL

Fanless Compact Embedded Computer with Intel Atom® Processor X-series (formerly Amston Lake)



Front View

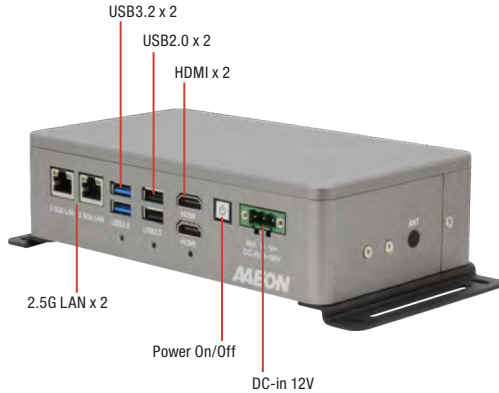

Rear View

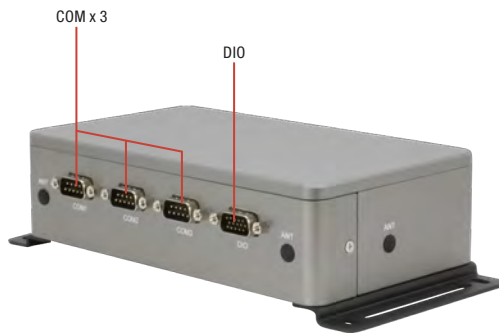

Features

- Intel Atom® Processor X-series (formerly Amston Lake)
- Industrial-Class CPU for 24/7 operation
- DDR5 4800Mhz SODIMM
- 2.5GbE x 2
- M.2 2280 M-Key x 1, M.2 2230 E-Key x 1
- USB 3.2 Gen 2 x 2 (Type-A)
- Onboard TPM 2.0
- Wide Range 9 ~ 36V DC input
- Wide Operating Temperature -20 ~ 60°C
- Compact Size



Specifications

System	
CPU	Intel Atom® x7433RE Intel Atom® x7213RE Intel Atom® x7211RE
Chipset	Intel® SoC
System Memory	DDR5 4800Mhz SODIMM x 1, up to 32GB
Display Interface	HDMI x 2
Storage Device	M.2 2280 M-Key x 1 (PCIe Gen 3 x 2) 2.5" SATA HDD/SSD x 1
Ethernet	RJ-45 x 2 for 2.5GbE LAN (Intel® I226-LM)
I/O	HDMI x 2 RJ-45 x 2 for 2.5GbE LAN (Intel® I226-LM) USB 3.2 Gen 2 x 2 (Type-A) USB 2.0 x 2 (Type-A) DB-9 x 3 for RS-232/422/485 DB-15 x 1 Male for Digital I/O 8-Channel 3-pin Terminal Block for DC In x 1 Power Button with LED x 1
Expansion	M.2 2280 M-Key x 1 (PCIe [x2]) M.2 2230 E-Key x 1 Full-Size Mini Card x 1 (PCIe + USB) SIM Slot x 1
Indicator	—
OS support	Windows® 10 IoT Enterprise Windows® 11 IoT Enterprise Windows® 11 Pro Linux Ubuntu 22.04
Power Supply	
Power Requirement	9 ~ 36V DC-In x 1 for 3-pin Terminal Block
Mechanical	
Mounting	Wallmount
Dimensions (W x H x D)	7.32" x 4.12" x 1.93" (186mm x 104.6mm x 49.1mm) without bracket 8.74" x 4.12" x 2.21" (222mm x 104.6mm x 56.1mm) with bracket
Gross Weight	4.32 lb (1.96 Kg)
Net Weight	2.56 lb (1.16 Kg)
Environmental	
Operating Temperature	-4°F ~ 140°F (-20°C ~ 60°C), according to IEC68-2 with 0.7 m/s AirFlow (w/ Industrial wide Temp. SSD/RAM)
Storage Temperature	-40°F ~ 176°F (-40°C ~ 80°C)
Storage Humidity	5 ~ 95% @ 40°C, non-condensing
Anti-Vibration	3 Grms/ 5 ~ 500Hz/ operation (with SSD)
Anti-Shock	50G, IEC 68-2-27, half sine, 11 ms duration (with SSD)
Certification	CE/FCC Class A





Dimension

Unit: mm

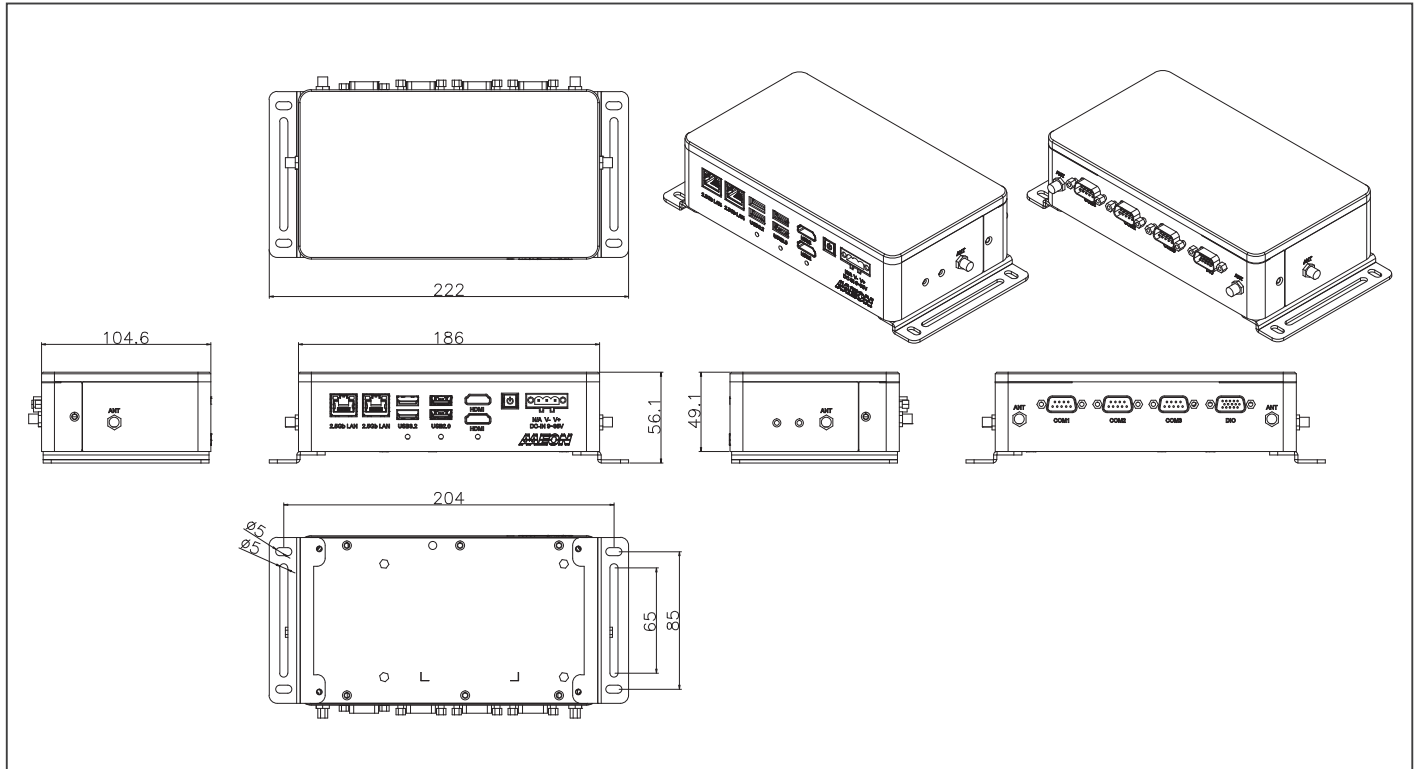

Ordering Information

Part Number	CPU	LAN	PCH	USB 3.2 Gen 2	USB 2.0	RS-232/422/485	Storage	Display	Expansion	Mounting	Power	Operation Temp.
BOXER-6406-ASL-A1-1010	Intel Atom® x7433RE	2	Intel SoC	2	2	3	M.2 2280 M-Key x 1 (PCIe Gen 3 [x2]) 2.5" SATA Drive Bay x 1	HDMI x 2	M.2 2280 M-Key x 1 (PCIe Gen 3 [x2]) M.2 2230 E-Key x 1 Full-Size Mini Card x 1 (PCIe + USB) SIM Slot x 1	Wallmount	9-36V DC in	-4°F ~ 140°F (-20°C ~ 60°C), according to IEC68-2 with 0.7 m/s AirFlow (w/ Industrial wide Temp. SSD/RAM)
BOXER-6406-ASL-A2-1010	Intel Atom® x7213RE	2	Intel SoC	2	2	3	M.2 2280 M-Key x 1 (PCIe Gen 3 [x2]) 2.5" SATA Drive Bay x 1	HDMI x 2	M.2 2280 M-Key x 1 (PCIe Gen 3 [x2]) M.2 2230 E-Key x 1 Full-Size Mini Card x 1 (PCIe + USB) SIM Slot x 1	Wallmount	9-36V DC in	-4°F ~ 140°F (-20°C ~ 60°C), according to IEC68-2 with 0.7 m/s AirFlow (w/ Industrial wide Temp. SSD/RAM)
BOXER-6406-ASL-A3-1010	Intel Atom® x7211RE	2	Intel SoC	2	2	3	M.2 2280 M-Key x 1 (PCIe Gen 3 [x2]) 2.5" SATA Drive Bay x 1	HDMI x 2	M.2 2280 M-Key x 1 (PCIe Gen 3 [x2]) M.2 2230 E-Key x 1 Full-Size Mini Card x 1 (PCIe + USB) SIM Slot x 1	Wallmount	9-36V DC in	-4°F ~ 140°F (-20°C ~ 60°C), according to IEC68-2 with 0.7 m/s AirFlow (w/ Industrial wide Temp. SSD/RAM)

Packing List

- Wallmount Bracket x 2
- Screw Package x 1
- 3 Pin DC-In Power Connector x 1
- BOXER-6406-ASL x 1

Optional Accessories

- 1255900849
12V 84W Power Adapter
- 170X000799
Power Cord (US type)
- 170X001024
Power Cord (European Type)
- 170X000803
Power Cord (Japanese Type)
- 0741EG25G0

BOXER-6406U-ADN

Fanless Compact Embedded Computer with Intel Atom® Processor X-series/N-series (formerly Alder Lake-N)

Front View

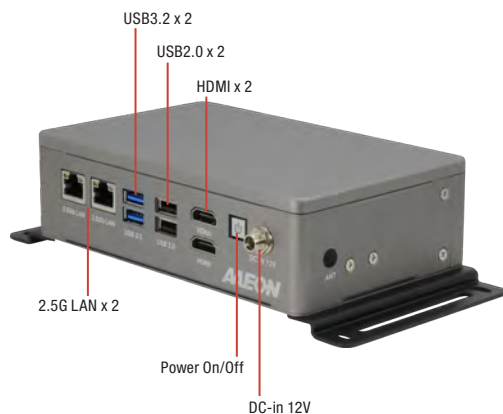

Rear View

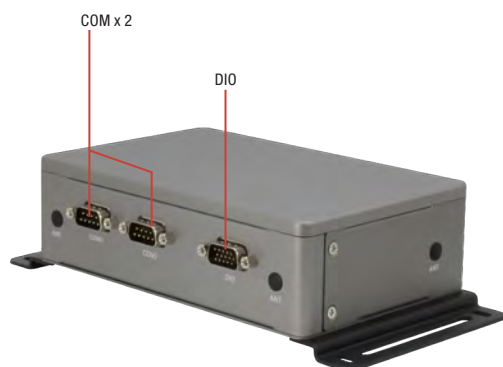

Features

- Intel Atom® Processor X-series/N-series (formerly Alder Lake-N)
- DDR5 4800MHz via SODIMM
- 2.5GbE x 2
- M.2 2280 M-Key x 1, M.2 2230 E-Key x 1
- USB 3.2 Gen 2 (Type-A) x 2
- Onboard TPM 2.0
- Wide -20°C ~ 60°C Operating Temperature
- Compact Size



Specifications

System	
CPU	Intel® Processor N200 Intel® Processor N50 Intel Atom® x7211E
Chipset	Intel® SoC
System Memory	DDR5 4800MHz SODIMM x 1, up to 32GB
Display Interface	HDMI x 2
Storage Device	M.2 2280 M-Key x 1 (PCIe Gen 3 [x2]) 2.5" SATA HDD/SSD x 1
Ethernet	RJ-45 x 2 for 2.5GbE LAN (Intel® Ethernet Controller I226-LM)
I/O	HDMI x 2 RJ-45 x 2 for 2.5GbE LAN (Intel® Ethernet Controller I226-LM) USB 3.2 Gen 2 (Type-A) x 2 USB 2.0 (Type-A) x 2 DB-9 x 2 for RS-232/422/485 DB-15 x 1 Male for 8-Channel Digital I/O 12V DC Jack Input Power Button with LED x 1 Antenna Opening x 4
Expansion	M.2 2280 M-Key x 1 (PCIe [x2]) M.2 2230 E-Key x 1 Full-Size Mini Card x 1 (PCIe + USB) SIM Slot x 1
Indicator	Power Button with LED
OS support	Windows® 10 IoT Enterprise Windows® 11 IoT Enterprise Windows® 11 Pro Ubuntu 22.04
Power Supply	
Power Requirement	Lockable DC Jack x 1 for 12V DC-in
Mechanical	
Mounting	Wallmount
Dimensions (W x H x D)	6.46" x 4.11" x 1.85" (164mm x 104.5mm x 47mm) without bracket 8.74" x 4.11" x 2.13" (222mm x 104.5mm x 54mm) with bracket
Gross Weight	3.8 lb. (1.73Kg)
Net Weight	2 lb. (0.93Kg)
Environmental	
Operating Temperature	-4°F ~ 140°F (-20°C ~ 60°C), according to IEC68-2 with 0.7 m/s AirFlow (w/ Industrial wide Temp. SSD/RAM)
Storage Temperature	-40°F ~ 176°F (-40°C ~ 80°C)
Storage Humidity	5 ~ 95% @ 40°C, non-condensing
Anti-Vibration	With SSD: Random, 3 Grms, 5~500Hz
Anti-Shock	With SSD: 50 G, IEC 60068-2-27, half sine, 11 ms duration
Certification	CE/FCC class A





Dimension

Unit: mm

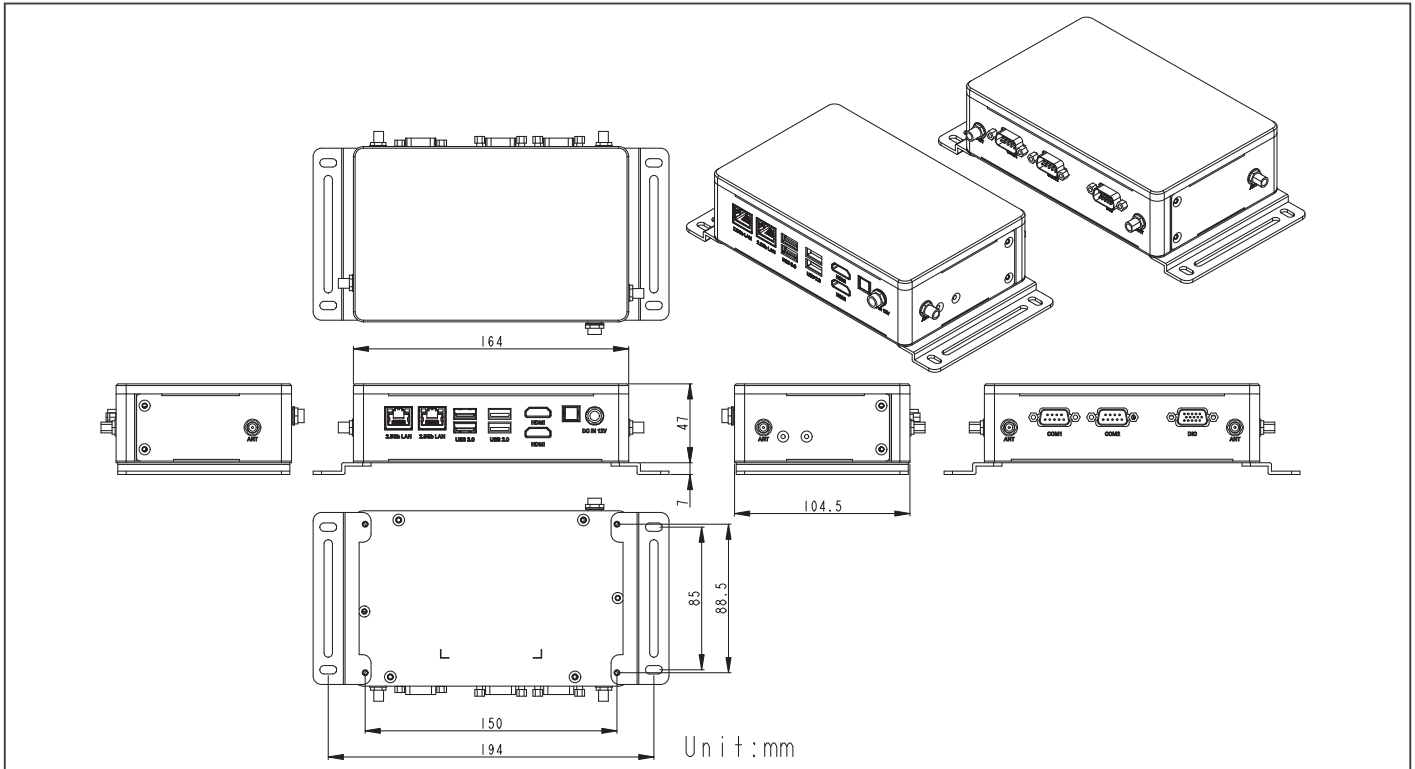

Unit: mm

Ordering Information

Part Number	CPU	LAN	PCH	USB 3.2 Gen 2	USB 2.0	RS-232/422/485	Storage	Display	Expansion	Mounting	Power	Operation Temp.
BOXER-6406U-ADN-A1-1010	Intel® Processor N200	2	Intel SoC	2	2	2	M.2 2280 M-Key x 1 (PCIe Gen 3 [x2]) 2.5" SATA Drive Bay x 1	HDMI x 2	M.2 2280 M-Key x 1 (PCIe Gen 3 [x2]) M.2 2230 E-Key x 1 Full-Size Mini Card x 1 (PCIe + USB) SIM Slot x 1	Wallmount	12V	-4°F ~ 140°F (-20°C ~ 60°C), according to IEC68-2 with 0.7 m/s AirFlow (w/ Industrial wide Temp. SSD/RAM)
BOXER-6406U-ADN-A2-1010	Intel® Processor N50	2	Intel SoC	2	2	2	M.2 2280 M-Key x 1 (PCIe Gen 3 [x2]) 2.5" SATA Drive Bay x 1	HDMI x 2	M.2 2280 M-Key x 1 (PCIe Gen 3 [x2]) M.2 2230 E-Key x 1 Full-Size Mini Card x 1 (PCIe + USB) SIM Slot x 1	Wallmount	12V	-4°F ~ 140°F (-20°C ~ 60°C), according to IEC68-2 with 0.7 m/s AirFlow (w/ Industrial wide Temp. SSD/RAM)
BOXER-6406U-ADN-A3-1010	Intel Atom® x7211E	2	Intel SoC	2	2	2	M.2 2280 M-Key x 1 (PCIe Gen 3 [x2]) 2.5" SATA Drive Bay x 1	HDMI x 2	M.2 2280 M-Key x 1 (PCIe Gen 3 [x2]) M.2 2230 E-Key x 1 Full-Size Mini Card x 1 (PCIe + USB) SIM Slot x 1	Wallmount	12V	-4°F ~ 140°F (-20°C ~ 60°C), according to IEC68-2 with 0.7 m/s AirFlow (w/ Industrial wide Temp. SSD/RAM)

Packing List

- BOXER-6406U-ADN x 1
- Wallmount Bracket x 2
- Screw Package x 1
- 60W 12V Power Adapter x 1

Optional Accessories

- 170X000799
Power Cord (US type)
- 170X001024
Power Cord (European Type)
- 170X000803
Power Cord (Japanese Type)
- 9741EG25G0
4G Module & Antenna (for global)

BOXER-6406U-ASL

Fanless Compact Embedded Computer with Intel Atom® Processor X-series (formerly Amston Lake)

Front View

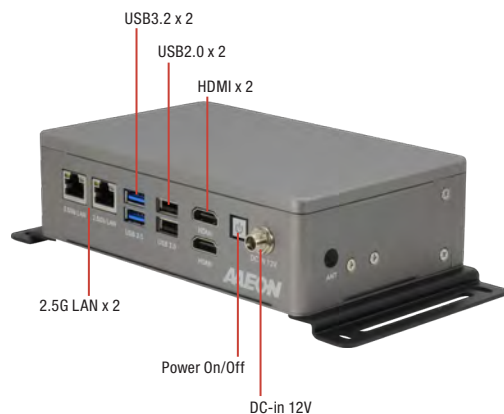

Rear View

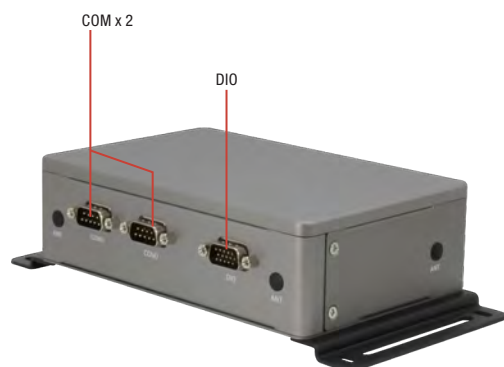

Features

- Intel Atom® Processor X-series (formerly Amston Lake)
- Industrial-Class CPU for 24/7 operation
- DDR5 4800MHz via SODIMM
- 2.5GbE x 2
- M.2 2280 M-Key x 1, M.2 2230 E-Key x 1
- USB 3.2 Gen 2 (Type-A) x 2
- Onboard TPM 2.0
- Wide -20°C ~ 60°C Operating Temperature
- Compact Size



Specifications

System	
CPU	Intel Atom® x7433RE Intel Atom® x7213RE Intel Atom® x7211RE
Chipset	Intel® SoC
System Memory	DDR5 4800MHz SODIMM x 1, up to 32GB
Display Interface	HDMI x 2
Storage Device	M.2 2280 M-Key x 1 (PCIe Gen 3 [x2]) 2.5" SATA HDD/SSD x 1
Ethernet	RJ-45 x 2 for 2.5GbE LAN (Intel® Ethernet Controller I226-LM)
I/O	HDMI x 2 RJ-45 x 2 for 2.5GbE LAN (Intel® Ethernet Controller I226-LM) USB 3.2 Gen 2 (Type-A) x 2 USB 2.0 (Type-A) x 2 DB-9 x 2 for RS-232/422/485 DB-15 x 1 Male for 8-Channel Digital I/O 12V DC Jack Input Power Button with LED x 1 Antenna Opening x 4
Expansion	M.2 2280 M-Key x 1 (PCIe [x2]) M.2 2230 E-Key x 1 Full-Size Mini Card x 1 (PCIe + USB) SIM Slot x 1
Indicator	Power Button with LED
OS support	Windows® 10 IoT Enterprise Windows® 11 IoT Enterprise Windows® 11 Pro Ubuntu 22.04
Power Supply	
Power Requirement	Lockable DC Jack x 1 for 12V DC-in
Mechanical	
Mounting	Wallmount
Dimensions (W x H x D)	6.46" x 4.11" x 1.85" (164mm x 104.5mm x 47mm) without bracket 8.74" x 4.11" x 2.13" (222mm x 104.5mm x 54mm) with bracket
Gross Weight	3.8 lb. (1.73Kg)
Net Weight	2 lb. (0.93Kg)
Environmental	
Operating Temperature	-4°F ~ 140°F (-20°C ~ 60°C), according to IEC68-2 with 0.7 m/s AirFlow (w/ Industrial wide Temp. SSD/RAM)
Storage Temperature	-40°F ~ 176°F (-40°C ~ 80°C)
Storage Humidity	5 ~ 95% @ 40°C, non-condensing
Anti-Vibration	With SSD: Random, 3 Grms, 5~500Hz
Anti-Shock	With SSD: 50 G, IEC 60068-2-27, half sine, 11 ms duration
Certification	CE/FCC class A





Dimension

Unit: mm

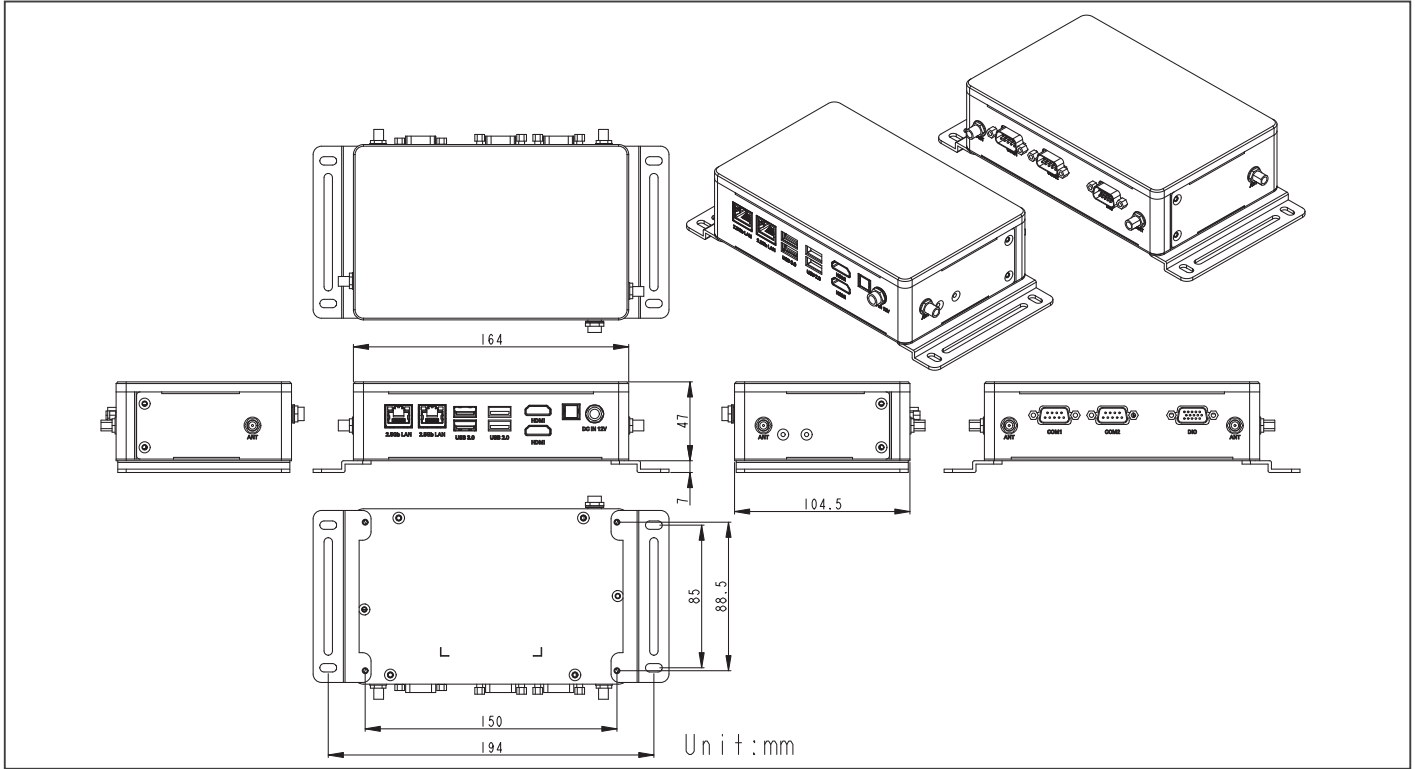

Ordering Information

Part Number	CPU	LAN	PCH	USB 3.2 Gen 2	USB 2.0	RS-232/422/485	Storage	Display	Expansion	Mounting	Power	Operation Temp.
BOXER-6406U-ASL-A1-1010	Intel Atom® x7433RE	2	Intel SoC	2	2	2	M.2 2280 M-Key x 1 (PCIe Gen 3 [x2]) 2.5" SATA Drive Bay x 1	HDMI x 2	M.2 2280 M-Key x 1 (PCIe Gen 3 [x2]) M.2 2230 E-Key x 1 Full-Size Mini Card x 1 (PCIe + USB) SIM Slot x 1	Wallmount	12V	-4°F ~ 140°F (-20°C ~ 60°C), according to IEC68-2 with 0.7 m/s AirFlow (w/ Industrial wide Temp. SSD/RAM)
BOXER-6406U-ASL-A2-1010	Intel Atom® x7213RE	2	Intel SoC	2	2	2	M.2 2280 M-Key x 1 (PCIe Gen 3 [x2]) 2.5" SATA Drive Bay x 1	HDMI x 2	M.2 2280 M-Key x 1 (PCIe Gen 3 [x2]) M.2 2230 E-Key x 1 Full-Size Mini Card x 1 (PCIe + USB) SIM Slot x 1	Wallmount	12V	-4°F ~ 140°F (-20°C ~ 60°C), according to IEC68-2 with 0.7 m/s AirFlow (w/ Industrial wide Temp. SSD/RAM)
BOXER-6406U-ASL-A3-1010	Intel Atom® x7211RE	2	Intel SoC	2	2	2	M.2 2280 M-Key x 1 (PCIe Gen 3 [x2]) 2.5" SATA Drive Bay x 1	HDMI x 2	M.2 2280 M-Key x 1 (PCIe Gen 3 [x2]) M.2 2230 E-Key x 1 Full-Size Mini Card x 1 (PCIe + USB) SIM Slot x 1	Wallmount	12V	-4°F ~ 140°F (-20°C ~ 60°C), according to IEC68-2 with 0.7 m/s AirFlow (w/ Industrial wide Temp. SSD/RAM)

Packing List

- BOXER-6406U-ASL x 1
- Wallmount Bracket x 2
- Screw Package x 1
- 60W 12V Power Adapter x 1

Optional Accessories

- 170X000799
Power Cord (US type)
- 170X001024
Power Cord (European Type)
- 170X000803
Power Cord (Japanese Type)
- 9741EG25G0
4G Module & Antenna (for global)

BOXER-6407-TWL PRELIMINARY

Fanless Compact Embedded Computer with Intel® Processor N-series

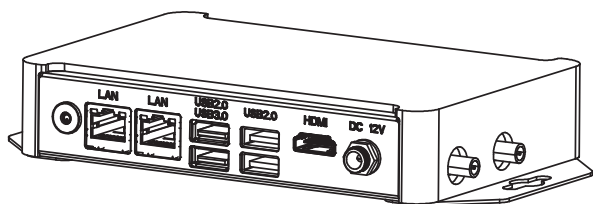
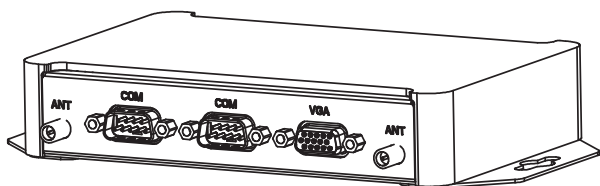

Features

- Ultra Slim Chassis Design
- Intel® Processor N250/N150 (formerly Twin Lake)
- DDR5 4800MHz SODIMM x 1, up to 32GB
- Display support HDMI + VGA
- GbE LAN x 2
- M.2 2230 E-Key, M.2 3052 B-Key, M.2 2280 M-Key
- Onboard TPM 2.0



Specifications

System	
CPU	Intel® Processor N series: Intel® Processor N250 (4C/4T, 6W) Intel® Processor N150 (4C/4T, 6W)
Chipset	Intel® SoC
System Memory	DDR5 4800MHz S0-DIMM x1, max. up to 32GB
Display Interface	HDMI x 1 VGA x1
Storage Device	M.2 2280 M Key x1 (PCIe Gen3 x2)
Ethernet	RJ-45 x 2 for GbE LAN (Intel® I210-AT)
I/O	USB3.2 Gen1 x1 USB2.0 x 3 DB-9 x 2 for RS-232/422/485 Power button with power LED x 1 Antenna opening x 4
Expansion	M.2 E-Key 2230 x1 (PCIex1) M.2 B-Key 3052 x 1 (USB3 + PCIe) TPM2.0 (Onboard)
Indicator	Power button with LED
OS support	Windows® 10 IoT Windows® 11 PRO/IoT Linux Ubuntu 24.04 and above
Power Supply	
Power Requirement	DC-in 12V with lockable DC jack
Mechanical	
Mounting	Wallmount
Dimensions (W x H x D)	6.02" x 3.98" x 1.18" (153mm x 101mm x 30mm) w/o brackets
Gross Weight	TBD
Net Weight	TBD
Environmental	
Operating Temperature	-4°F ~ 122°F (-20°C ~ 50°C), IEC60068-2 with 0.7 m/s AirFlow, with wide temp. memory/storage
Storage Temperature	-40°F ~ 176°F (-40°C ~ 80°C)
Storage Humidity	5 ~ 95% @ 40°C, non-condensing
Anti-Vibration	Random, 3 Grms, 5~500Hz, with SSD
Anti-Shock	With SSD: 50 G, IEC 60068-2-27, half sine, 11 ms duration
Certification	CE / FCC class A





Dimension

Unit: mm

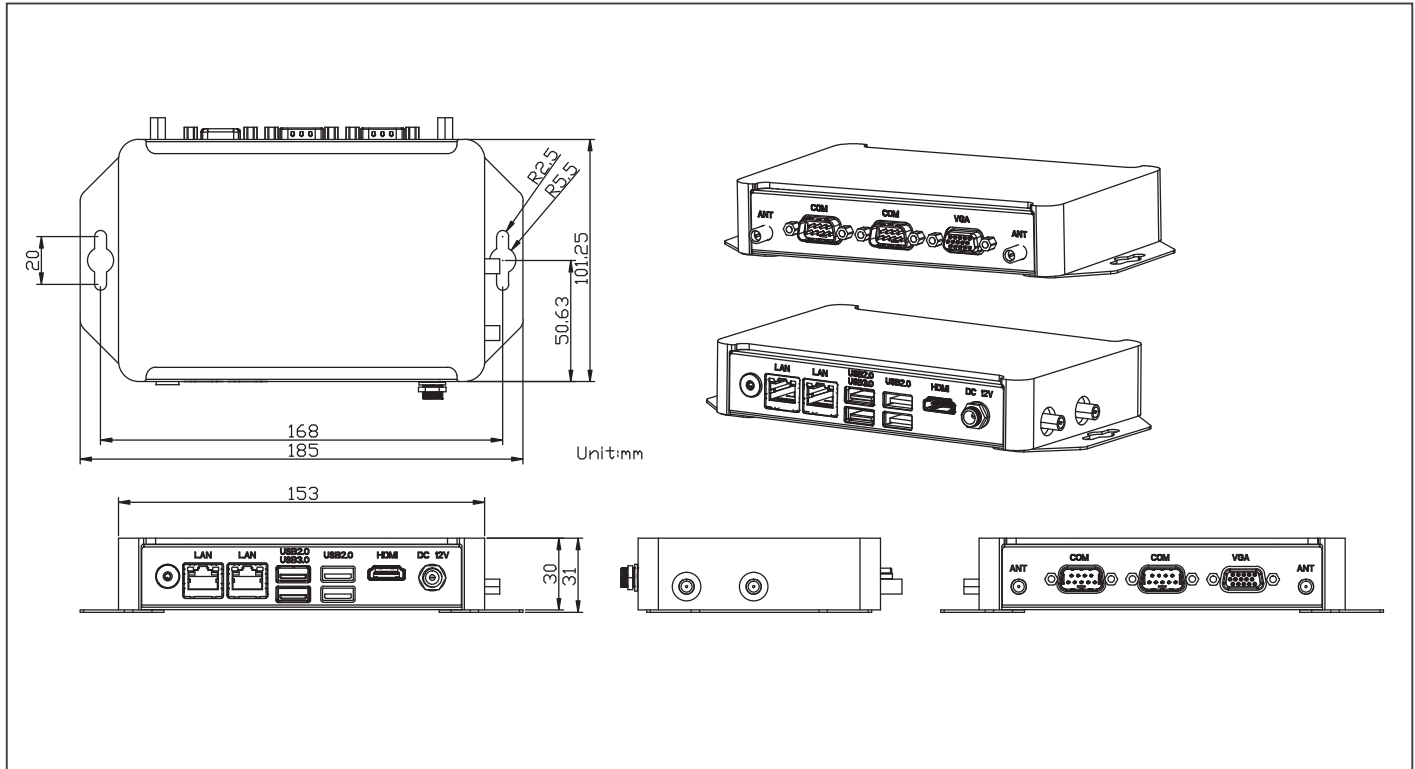

Ordering Information

- TBD

Optional Accessories

- **170X000799**
Power Cord (US type)
- **170X001024**
Power Cord (European Type)
- **170X000803**
Power Cord (Japanese Type)

Packing List

- BOXER-6407-TWL x 1
- DC Jack Power Adapter x 1
- Wallmount Bracket x 2
- Screw Package x 1

BOXER-6451-ADP

Fanless Compact Embedded Computer with 12th Generation Intel® Core™ Processors

Front View



Rear View



Features

- Compact Computer with 12th Gen Intel® Core™ Processors
- DDR4 SODIMM, Max. 32GB
- USB 3.2 Gen 2 x 3 (10Gbps) + USB 2.0 x 1
- 2.5GbE LAN x 1 (Intel® I226-LM) + GbE LAN x 1 (Intel® I219-LM)
- M.2 3052 B-Key for 5G Support
- Wide Operating Temperature
- Onboard TPM 2.0



Specifications

System	
CPU	Intel® Core™ i7-1265UE Intel® Core™ i5-1245UE Intel® Core™ i3-1215UE
Chipset	Intel® SoC
System Memory	DDR4 SODIMM x 1, up to 32GB
Display Interface	HDMI 1.4b x 2 (Type-A)
Storage Device	2.5" SATA Drive Bay x 1 M.2 2280 M-Key x 1 (PCIe [x4])
Ethernet	RJ-45 x 1 for 2.5GbE (Intel® I226-LM) RJ-45 x 1 for GbE (Intel® I219-LM)
I/O	USB 3.2 Gen 2 x 3 (Type-A) USB 2.0 x 1 (Type-A) DB-9 x 4 for RS-232/422/485 HDMI 1.4b x 2 (Type-A) Power Button x 1 DC Jack 12V Input Antenna Opening x 6
Expansion	M.2 2230 E-Key x 1 (Wi-Fi/BT) M.2 3052 B-Key w/ SIM x 1 (LTE/5G) M.2 2280 M-Key x 1 (NVMe)
Indicator	Power Button with LED
OS support	Windows® 10 IoT Ent LTSC Windows® 11 PRO Ubuntu 22.04
Power Supply	
Power Requirement	DC-in 12V x 1 for Lockable DC Jack
Mechanical	
Mounting	Wallmount
Dimensions (W x H x D)	7.68" x 4.37" x 2.5" (195mm x 111mm x 63.5mm) w/o bracket
Gross Weight	4.4 lb. (2Kg)
Net Weight	3.3 lb. (1.5Kg)
Environmental	
Operating Temperature	-4°F ~ 140°F (-20°C ~ 60°C), IEC68-2 with 0.5 m/s AirFlow with Wide Temperature Memory/Storage
Storage Temperature	-40°F ~ 176°F (-40°C ~ 80°C)
Storage Humidity	5 ~ 95% @ 40°C, non-condensing
Anti-Vibration	SSD: Random, 3Grms, 5~500Hz
Anti-Shock	SSD: 50G @ wallmount, Half-sine, 11ms
Certification	CE/FCC Class A





Dimension

Unit: mm

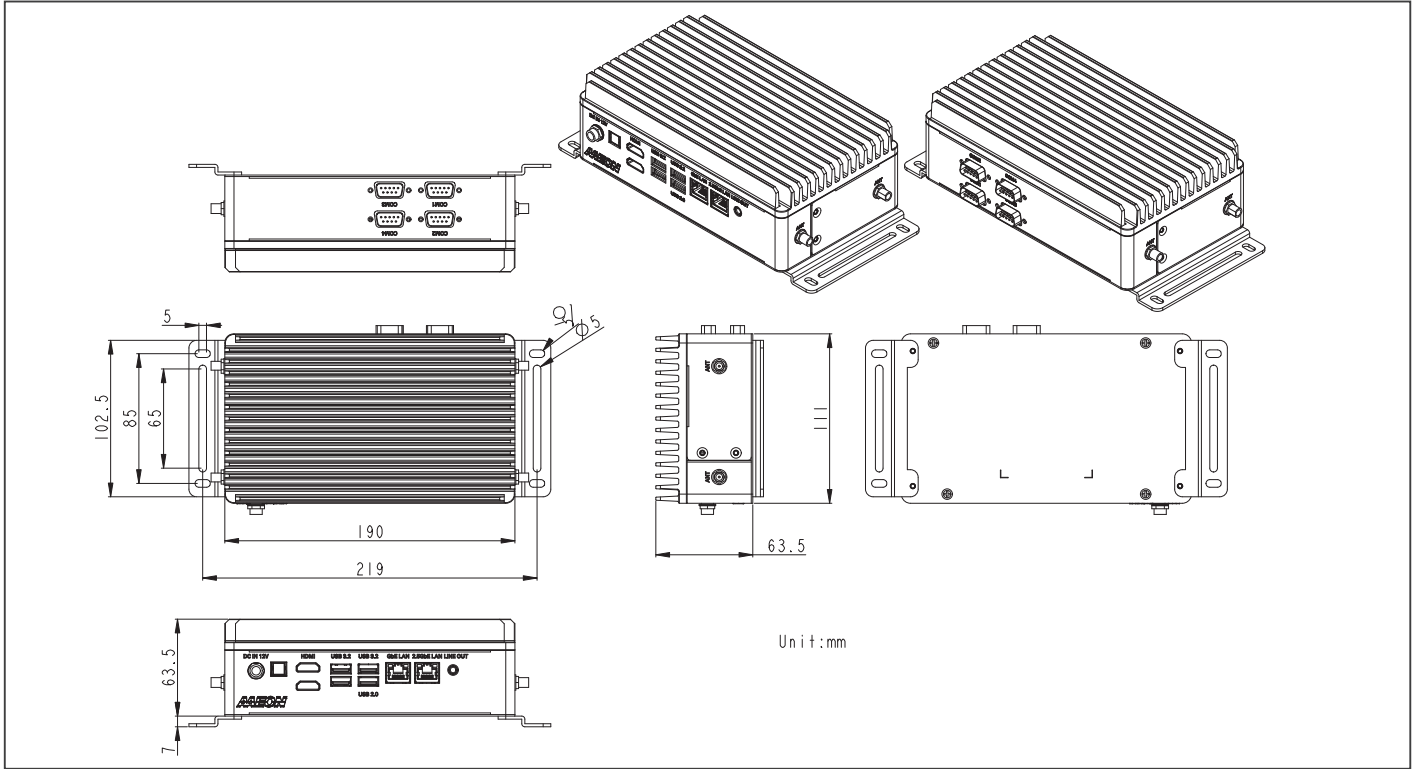

Unit: mm

Ordering Information

Part Number	CPU	PCH	LAN	USB 3.0	USB 2.0	RS-232/422/485	Audio	Storage	Display	Expansion	Mounting	Power	Operation temp.
BOXER-6451-ADP-A1-1010	i3-1215UE	SoC	2	USB 3.2 x 3 (10Gbps)	1	4	Line-out	2.5" SATA Drive Bay x 1 M.2 2280 M-Key x 1 (NVMe)	HDMI x 2	M.2 2230 E-Key x 1 M.2 3052 B-Key w/ SIM Slot x 1	Wallmount	12V	-4°F ~ 140°F (-20°C ~ 60°C) with 0.5 m/s airflow, with wide temperature Memory/Storage
BOXER-6451-ADP-A2-1010	i5-1245UE	SoC	2	USB 3.2 x 3 (10Gbps)	1	4	Line-out	2.5" SATA Drive Bay x 1 M.2 2280 M-Key x 1 (NVMe)	HDMI x 2	M.2 2230 E-Key x 1 M.2 3052 B-Key w/ SIM Slot x 1	Wallmount	12V	-4°F ~ 140°F (-20°C ~ 60°C) with 0.5 m/s airflow, with wide temperature Memory/Storage
BOXER-6451-ADP-A3-1010	i7-1265UE	SoC	2	USB 3.2 x 3 (10Gbps)	1	4	Line-out	2.5" SATA Drive Bay x 1 M.2 2280 M-Key x 1 (NVMe)	HDMI x 2	M.2 2230 E-Key x 1 M.2 3052 B-Key w/ SIM Slot x 1	Wallmount	12V	-4°F ~ 140°F (-20°C ~ 60°C) with 0.5 m/s airflow, with wide temperature Memory/Storage

Packing List

- Wallmount Bracket x 2
- Screw Package x 1
- 84W 12V Power Adapter
- BOXER-6451-ADP

Optional Accessories

- 170X000799
Power Cord (US type)
- 170X000800
Power Cord (European Type)
- 170X000803
Power Cord (Japanese Type)

05



ES France - Mobilité & Systèmes Embarqués
127 rue de Buzenval BP 26 - 92380 Garches



Tél. 01 47 95 99 80



e-mail : mse@es-france.com
Site Web : www.es-france.com

05

Din Rail Fanless BOX PC



ES France - Mobilité & Systèmes Embarqués
127 rue de Buzenval BP 26 - 92380 Garches



Tél. 01 47 95 99 80



e-mail : mse@es-france.com
Site Web : www.es-france.com

BOXER-6751-ADP

DIN Rail Fanless Embedded BOX PC with 12th Generation Intel® Core™ Processors

Front View

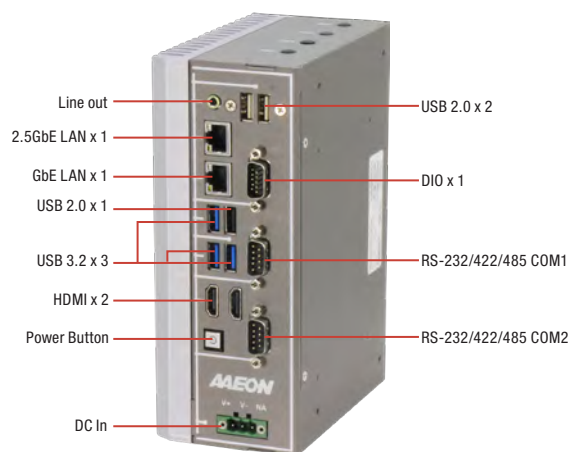

Rear View



Features

- 12th Gen Intel® Core™ Processors
- DDR4 SODIMM, Max. 32GB
- USB 3.2 Gen 2 x 3 + USB 2.0 x 3
- 2.5GbE x 1 (Intel® I226-LM) + GbE x 1 (Intel® I219-LM)
- RS-232/422/485 x 2
- HDMI x 2 Dual Display Output
- 8-bit Digital Input and Output x 1
- M.2 3052 B-Key for 5G
- Onboard TPM 2.0
- Wide 9 ~ 36V DC Input Range With Power Protection
- Wide -20°C ~ 60°C Temperature Range
- DIN Rail Mount Design



Specifications

System	
CPU	Intel® Core™ i7-1265UE Intel® Core™ i5-1245UE Intel® Core™ i3-1215UE
Chipset	Intel® SoC
System Memory	DDR4 SODIMM x 1, up to 32GB
Display Interface	HDMI 1.4b (Type-A) x 2
Storage Device	2.5" SATA III Drive Bay x 1 M.2 2280 M-Key x 1 (PCIe [x4])
Ethernet	RJ-45 x 1 for Intel® I226-LM, 2.5GbE RJ-45 x 1 for Intel® I219-LM, GbE
I/O	USB 3.2 Gen 2 (Type-A) x 3 USB 2.0 (Type-A) x 3 DB-9 x 2 for RS-232/422/485 DB-15 x 1 for DIO 8-bit HDMI 1.4b (Type-A) x 2 Audio x 1 for Line-Out Power Button x 1 3-pin Terminal Block for DC-in x 1 Antenna Opening x 4
Expansion	M.2 2230 E-Key x 1 (Wi-Fi/BT) M.2 3052 B-Key w/ SIM x 1 (LTE/5G) M.2 2280 M-Key x 1 (NVMe)
Indicator	Power Button with LED
OS Support	Windows® 10 IoT Ent LTSC Windows® 11 PRO Ubuntu 22.04
Power Supply	
Power Requirement	DC 9 - 36V with 3-pin terminal block
Mechanical	
Mounting	DIN Rail Mount Wallmount (Mounting kit is optional)
Dimensions (W x H x D)	2.93" x 7.32" x 5.0" (74.3mm x 186mm x 127mm)
Gross Weight	5.3 lb (2.41 Kg)
Net Weight	3.9 lb (1.77 Kg)
Environmental	
Operating Temperature	-4°F ~ 140°F (-20°C ~ 60°C), IEC68-2 with 0.5 m/s AirFlow
Storage Temperature	-40°F ~ 176°F (-40°C ~ 80°C)
Storage Humidity	5 ~ 95% @ 40°C, non-condensing
Anti-Vibration	With SSD: Random, 3 Grms, 5~500Hz
Certification	CE/FCC class A





Dimension

Unit: mm

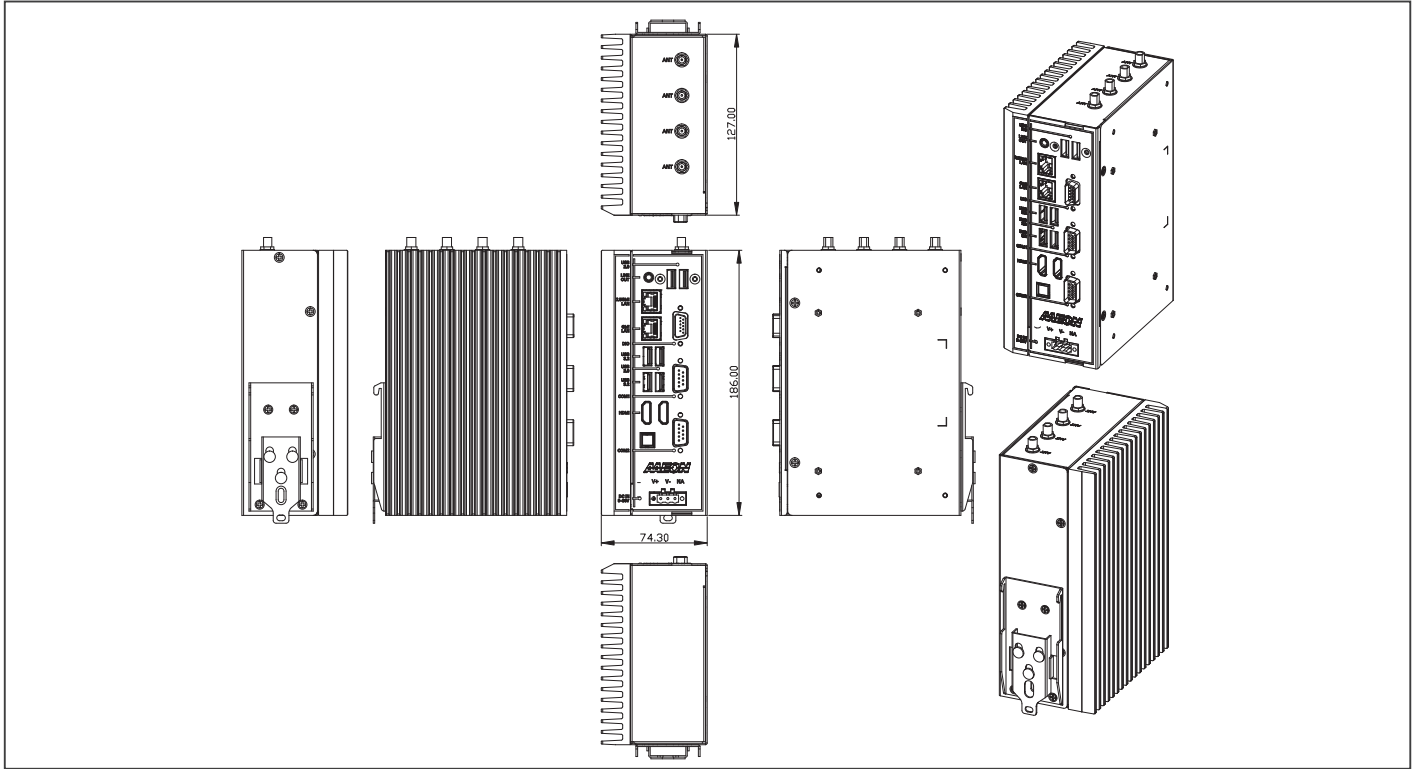

Ordering Information

Part Number	CPU	PCH	LAN	USB	RS-232	RS-232/422/485	Digital I/O	Audio	Storage	Display	Expansion	Mounting	Power	Operation Temp
BOXER-6751-ADP-A1-1010	Intel® Core™ i3-1215UE	Soc	2	USB 3.2 Gen 2 x 3 USB 2.0 x 3	—	2	8-Bit DIO	Line-Out	2.5" SATA-III Drive bay x 1 M.2 2280 M Key NVMe Slot x 1	HDMI x 2	M.2 E-Key 2230 x 1 M.2 B-Key 3052 x 1 w/ SIM Slot x 1	DIN Rail Wallmount (Optional)	9~36V	-20°C ~ 60°C
BOXER-6751-ADP-A2-1010	Intel® Core™ i5-1245UE	Soc	2	USB 3.2 Gen 2 x 3 USB 2.0 x 3	—	2	8-Bit DIO	Line-Out	2.5" SATA-III Drive bay x 1 M.2 2280 M Key NVMe Slot x 1	HDMI x 2	M.2 E-Key 2230 x 1 M.2 B-Key 3052 x 1 w/ SIM Slot x 1	DIN Rail Wallmount (Optional)	9~36V	-20°C ~ 60°C
BOXER-6751-ADP-A3-1010	Intel® Core™ i7-1265UE	Soc	2	USB 3.2 Gen 2 x 3 USB 2.0 x 3	—	2	8-Bit DIO	Line-Out	2.5" SATA-III Drive bay x 1 M.2 2280 M Key NVMe Slot x 1	HDMI x 2	M.2 E-Key 2230 x 1 M.2 B-Key 3052 x 1 w/ SIM Slot x 1	DIN Rail Wallmount (Optional)	9~36V	-20°C ~ 60°C

Packing List

- BOXER-6751-ADP x 1
- DIN Rail Kit x 1
- Screw Package x 1
- 3 Pin DC-In Power Connector x 1

Optional Accessories

- **170X000799**
Power Cord (US type)
- **170X000803**
Power Cord (Japanese Type)
- **170X000800**
Power Cord (European Type)
- **1255X00059**
120W Power Adapter

BOXER-6711-ADN

DIN Rail Mount Embedded BOX PC with Intel Atom® x7211E/Intel® Processor N-Series Processors

Front View

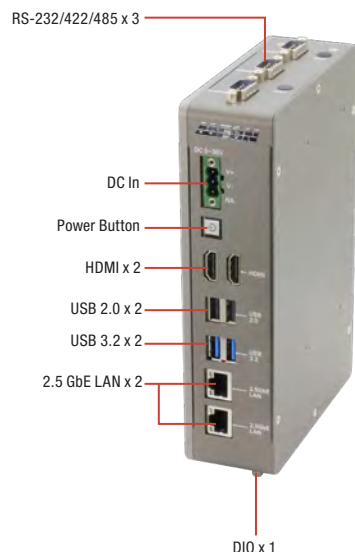

Rear View



Features

- DIN Rail Mount Support
- Intel Atom® x7211E/Intel® Processor N-Series
- DDR5 4800 MT/s SODIMM slot
- Onboard TPM 2.0
- Wide Range 9~36V DC input
- Wide Operating Temperature -20°C~60°C



Specifications

System	
CPU	Intel Atom® x7211E Intel® Processor N200 Intel® Processor N50
Chipset	Intel® SoC
System Memory	DDR5 4800 MT/s SO-DIMM slot x 1, up to 32GB
Display Interface	HDMI 1.4 x 2
Storage Device	M.2 2280 M-Key x 1 (PCIe [x2]) 2.5" SATA HDD/SSD x 1
Ethernet	RJ-45 x 2 for 2.5GbE LAN (Intel® Ethernet Controller I226)
I/O	HDMI 1.4 x 2 RJ-45 x 2 for 2.5GbE LAN (Intel® Ethernet Controller I226) USB 3.2 Gen 2 (Type-A) x 2 USB 2.0 (Type-A) x 2 DB-9 x 3 for RS-232/422/485 DB-15 x 1 for 8-bit DIO 3-pin Terminal Block for DC in x 1 Power Button with LED x 1
Expansion	M.2 2280 M-Key x 1 (PCIe [x2]) M.2 2230 E-Key x 1 Full Size Mini Card x1 (PCIe + USB) SIM Slot x 1
Indicator	—
OS Support	Windows® 10 IoT Enterprise Windows® 11 Pro Linux Ubuntu 22.04
Power Supply	
Power Requirement	DC-in 9-36V x1 for 3-pin Terminal Block
Mechanical	
Mounting	DIN Rail Mount
Dimensions (W x H x D)	1.89" x 7.48" x 4.88" (48mm x 190mm x 124mm)
Gross Weight	3.50 lb (1.59 Kg)
Net Weight	2.40 lb (1.09 Kg)
Environmental	
Operating Temperature	-4°F ~ 140°F (-20°C ~ 60°C), according to IEC68-2 with 0.5 m/s AirFlow (w/ Industrial wide Temp. SSD/RAM)
Storage Temperature	-40°F ~ 176°F (-40°C ~ 80°C)
Storage Humidity	5 ~ 95% @ 40°C, non-condensing
Anti-Vibration	3 Grms/ 5 ~ 500Hz/ operation (with SSD)
Certification	CE/FCC class A





Dimension

Unit: mm

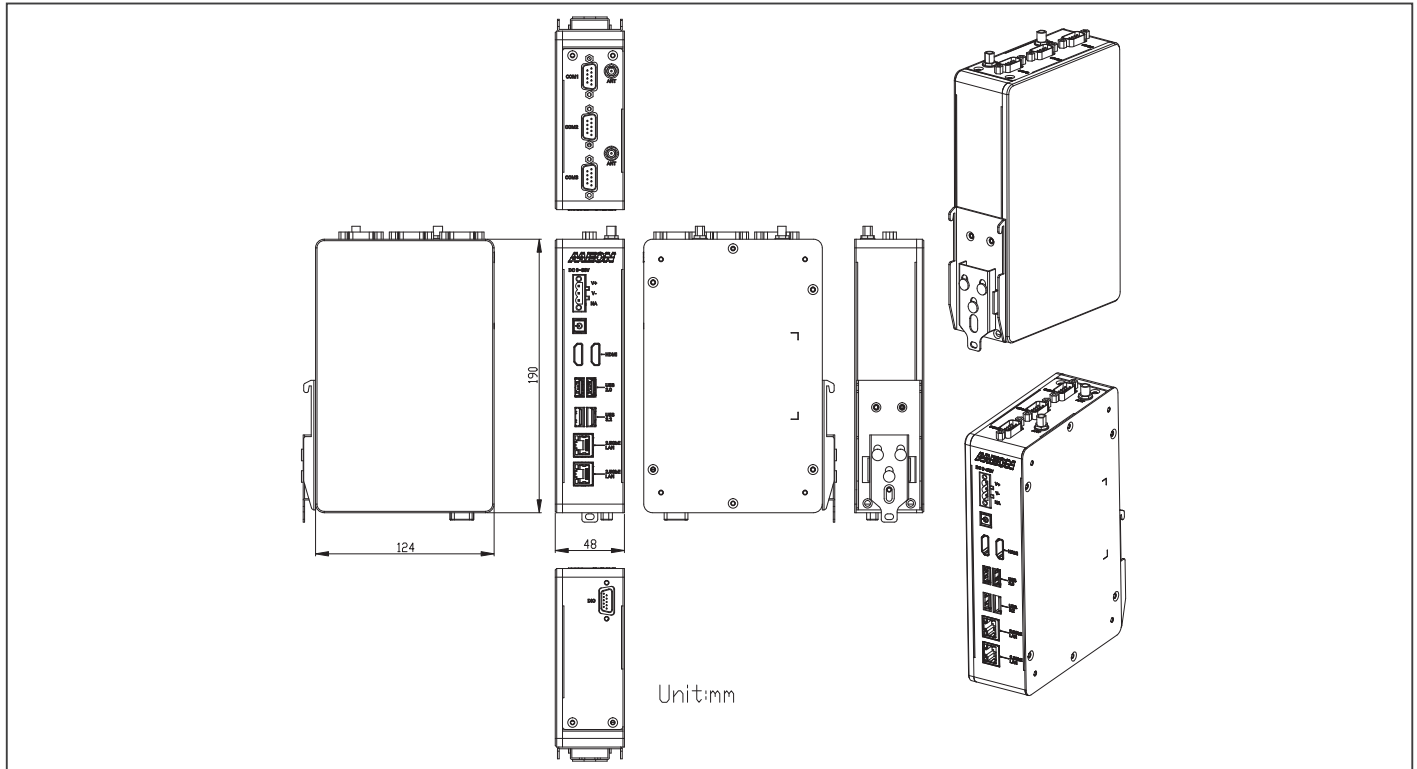

Ordering Information

Part Number	CPU	LAN	PCH	USB 3.2 Gen2	USB 2.0	RS-232/422/485	Storage	Display	Expansion	Mounting	Power	Operation Temp.
BOXER-6711-ADN-A1-1010	Intel® Processor N200	2	Intel SoC	2	2	3	M.2 2280 M Key Slot x1 (PCIex2) 2.5" SATA Drive Bay x1	HDMI x2	M.2 2280 M Key x 1 (PCIex2) M.2 2230 E Key x 1 Full-Size M.2 MiniCard x1 (PCIe + USB) SIM Slot	DIN Rail Mount	9-36V DC in	-4°F ~ 140°F (-20°C ~ 60°C), according to IEC68-2 with 0.5 m/s AirFlow (w/ Industrial wide Temp. SSD/RAM)
BOXER-6711-ADN-A2-1010	Intel® Processor N50	2	Intel SoC	2	2	3	M.2 2280 M Key Slot x1 (PCIex2) 2.5" SATA Drive Bay x1	HDMI x2	M.2 2280 M Key x 1 (PCIex2) M.2 2230 E Key x 1 Full-Size M.2 MiniCard x1 (PCIe + USB) SIM Slot	DIN Rail Mount	9-36V DC in	-4°F ~ 140°F (-20°C ~ 60°C), according to IEC68-2 with 0.5 m/s AirFlow (w/ Industrial wide Temp. SSD/RAM)
BOXER-6711-ADN-A3-1010	Intel Atom® x7211E	2	Intel SoC	2	2	3	M.2 2280 M Key Slot x1 (PCIex2) 2.5" SATA Drive Bay x1	HDMI x2	M.2 2280 M Key x 1 (PCIex2) M.2 2230 E Key x 1 Full-Size M.2 MiniCard x1 (PCIe + USB) SIM Slot	DIN Rail Mount	9-36V DC in	-4°F ~ 140°F (-20°C ~ 60°C), according to IEC68-2 with 0.5 m/s AirFlow (w/ Industrial wide Temp. SSD/RAM)

Packing List

- DIN Rail Bracket x 1
- Screw Package x 1
- 3 Pin DC-In Power Connector x 1
- BOXER-6711-ADN x 1

Optional Accessories

- **1255900849**
12V 84W Power Adapter
- **170X000799**
Power Cord (US type)
- **170X001024**
Power Cord (European Type)
- **170X000803**
Power Cord (Japanese Type)
- **9741EG25G0**
4G Module & Antenna (for global)

BOXER-6710

Din Rail Mount Embedded BOX PC with Intel® Atom® Processor N4200 or N3350

Front View

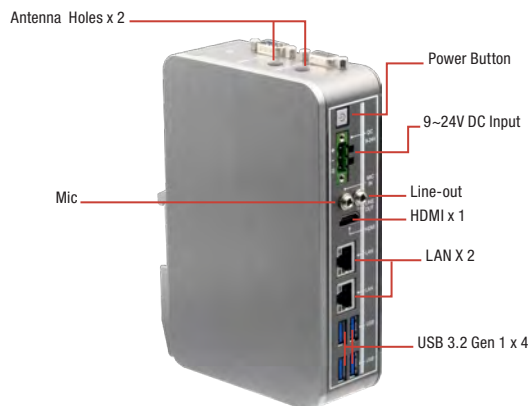

Rear View



Features

- Slim Design: Min. width 44mm
- Designed for Embedded Automation Controller
- Gigabit Ethernet x 2, USB x 4
- Operate in -20°C ~ 60°C Environment
- Support Din Rail Mount



Specifications

System	
CPU	Intel® Pentium® processor N4200 Intel® Celeron® processor N3350
Chipset	Intel® System on Chip
System Memory	DDR3L 1866, Single Channel SODIMM x 1, Non-ECC (Max.8GB, up to 1600MHz)
Display Interface	HDMI, VGA
Storage Device	HDD/SSD, optional mSATA
Ethernet	Intel® i211-AT x 2
I/O	VGA x 1 HDMI x 1 RJ-45 x 2 for GbE LAN USB Type A x 4 for USB 3.2 Gen 1 Mic-in x 1 Line-out x 1 RS-232/422/485 x 3 with automatic flow control Power On/Off Button x 1 DC-in 3-pin terminal block (9~24V) x 1
Expansion	Full-size Minicard x 1 w/ SIM Slot Half-size Minicard x 1 (optional for mSATA)
Indicator	Power LED on power button
OS Support	Windows® 10 (64-bit) Windows® 10 IoT (64-bit) Linux Ubuntu 16.04.4
Power Supply	
Power Requirement	9 - 24V with 3-pin terminal block
Mechanical	
Mounting	DIN Rail Mount
Dimensions (W x H x D)	1.73" x 6.54" x 4.17" (44mm x 166mm x 106mm)
Gross Weight	3.08lb (1.4kg)
Net Weight	1.32lb (0.6kg)
Environmental	
Operating Temperature	-4°F ~ 140°F (-20°C ~ 60°C) with W.T. SSD/HDD/mSATA (according to IEC68-2-14 with 0.5 m/s AirFlow ; with industrial devices)
Storage Temperature	-49°F ~ 176°F (-45°C ~ 80°C)
Storage Humidity	95% @ 40°C, non-condensing
Anti-Vibration	3 Grms/ 5 ~ 500Hz/ operation – mSATA/SSD 1 Grms/ 5 ~ 500Hz/ operation – HDD
Certification	CE/FCC class A





Dimension

Unit: mm

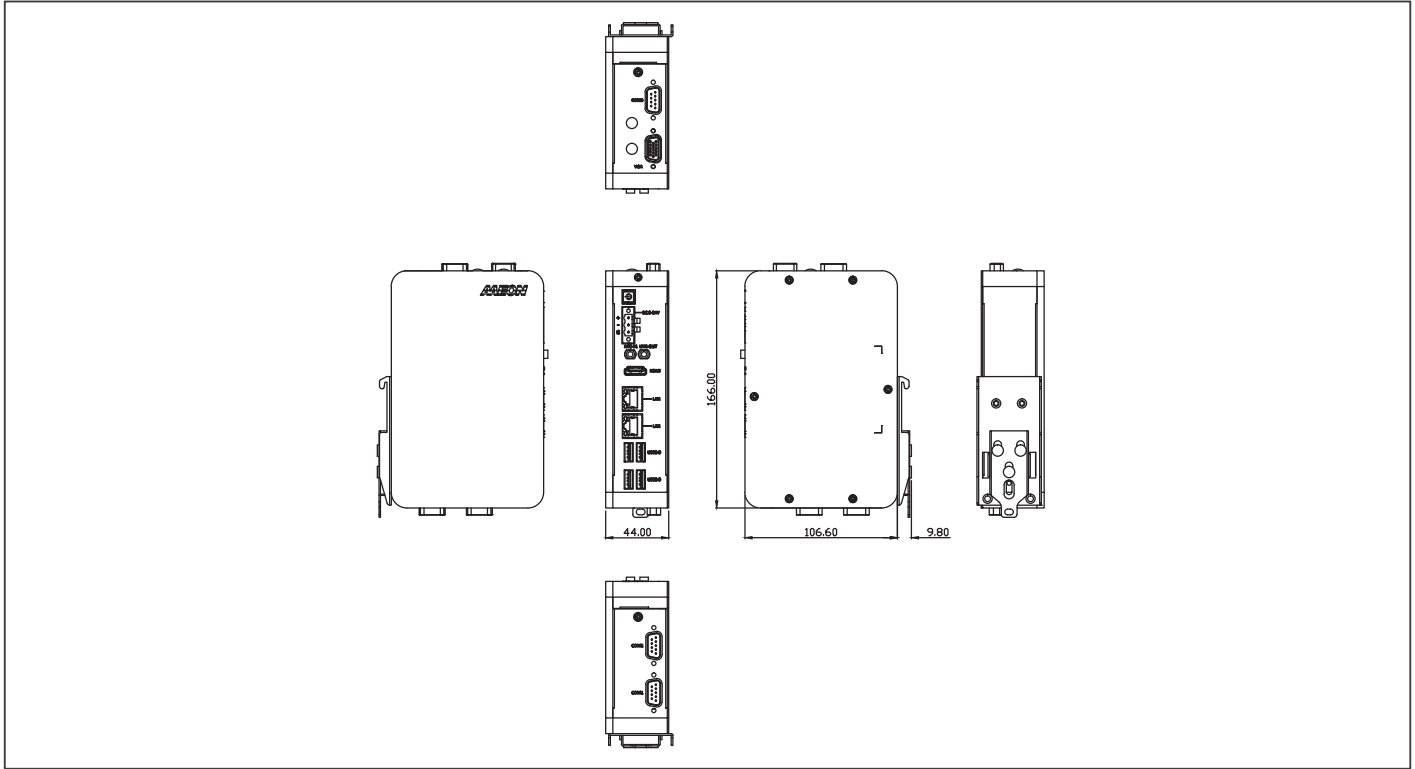

Ordering Information

Part Number	CPU	PCH	RAM	LAN	USB 3.2 Gen 1	USB 2.0	RS-232	RS-232/422/485	Digital I/O	Audio	Storage	Display	Expansion	Mounting	Power	Operation temp.
BOXER-6710-A1-1011	N3350	SoC	—	2	4	—	—	3	—	MIC-in, Line-out	2.5" SATA Drive bay x 1 Optional mSATA x1	VGA x 1 HDMI x 1	Full-size Minicard x 1 Half-size Minicard x 1	Din Rail Mount	9~24V	-20°C ~ 60°C
BOXER-6710-A2-1011	N4200	SoC	—	2	4	—	—	3	—	MIC-in, Line-out	2.5" SATA Drive bay x 1 Optional mSATA x1	VGA x 1 HDMI x 1	Full-size Minicard x 1 Half-size Minicard x 1	Din Rail Mount	9~24V	-20°C ~ 60°C

Packing List

- DIN Rail Bracket x 1
- Screw Package x 1
- 3 Pin DC-In Power Connector x 1
- BOXER-6710

Optional Accessories

- **125530040F**
Power Adapter
- **170X000799**
Power Cord (US Type)
- **170X000800**
Power Cord (Europe)
- **170X000803**
Power Cord (Japan)
- **9741238H00**
WiFi Module & Antenna
- **9741EC20E0**
4G Module & Antenna(for Europe)

06



ES France - Mobilité & Systèmes Embarqués
127 rue de Buzenval BP 26 - 92380 Garches



Tél. 01 47 95 99 80



e-mail : mse@es-france.com
Site Web : www.es-france.com

06

Expandable Fanless BOX PC Solutions



BOXER-6801-RAP

Fanless Embedded Computer with 13th Gen Intel® Core™ i7/i5/i3 Mobile Processors

Front View

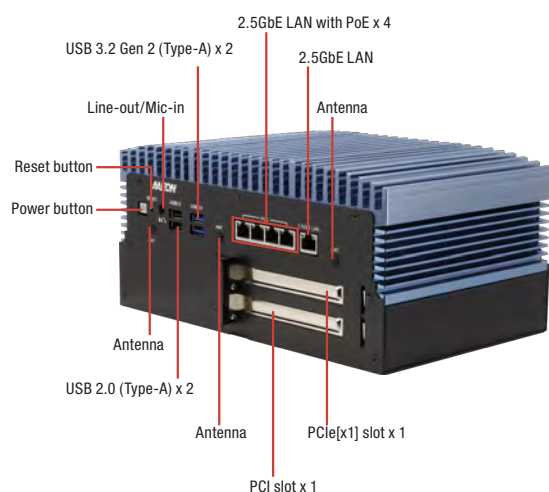

Rear View

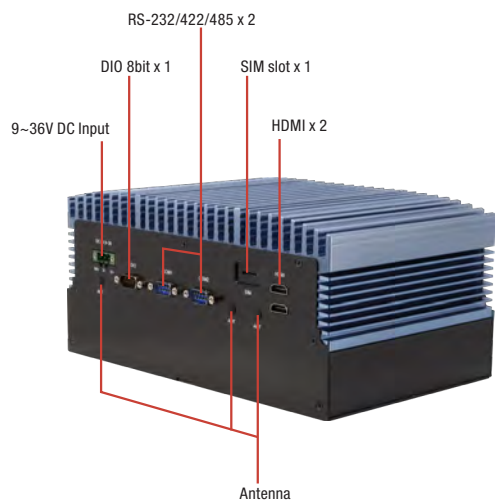

Features

- 13th Gen Intel® Core™ i7/i5/i3 Mobile Processors
- DDR5 SODIMM x 2, up to 96GB
- 2.5 GbE LAN x 5 (4 with PoE Functionality, Sharing 60W In Total)
- PCIe [x1] Slot x 1 & PCI Slot x 1
- 9V-36V DC Input with Protection Circuit
- Wide -20°C-60°C Operating Temperature
- Onboard TPM 2.0



Specifications

System	
CPU	13th Gen Intel® Core™ Processors, Max. 28W: Intel® Core™ i7-1370PE Processor Intel® Core™ i5-1340PE Processor Intel® Core™ i3-1320PE Processor
Chipset	Intel® SoC
System Memory	DDR5 SODIMM x 2, up to 96GB
Display Interface	HDMI x 2
Storage Device	2.5" SATA Drive Bay x 1 M.2 2280 M-Key x 1 (PCIe Gen 4 [x4])
Ethernet	2.5GbE x 5 (Intel® Ethernet Controller I226-LM)
I/O	2.5GbE x 4 (IEEE 802.3af/at PoE support, providing a total power budget of 60W across all ports) Note: When the input voltage is ≤12V, the system supports PoE with a maximum combined output of <20W. USB 3.2 Gen 2 (Type-A) x 2 USB 2.0 (Type-A) x 2 DB-9 x 2 for RS-232/422/485 DB-15 x 1 for DIO 8-bit Front-access SIM Slot x 1 3.5mm Jack x 1 for Line-out/Mic-in Antenna Opening x 6 Reset Button x 1 Power Button x 1
Expansion	M.2 2280 M-Key x 1 M.2 2230 E-Key x 1 (PCIe) M.2 3052 B-Key x 1 (USB) with SIM slot PCIe [x1] Slot x 1 (Max size: 150mm x 110mm x 20mm) PCI Slot x 1 (Max size: 150mm x 110mm x 20mm)
Indicator	—
OS Support	Windows® 10 IoT 2021 LTSC Windows® 11 IoT LTSC Ubuntu 24.04 above
Power Supply	
Power Requirement	9V-36V DC Input via 3-pin Terminal Block, with built-in protection circuit
Mechanical	
Mounting	Wallmount (Optional: DIN Rail Mount)
Dimensions (W x H x D)	10.3" x 7" x 4.8" (264mm x 179mm x 124mm) w/o Brackets
Gross Weight	13.89 lb (6.3 Kg)
Net Weight	10.80 lb (4.9 Kg)
Environmental	
Operating Temperature	-4°F ~140°F (-20°C ~ 60°C) with 0.7 m/s airflow (with wide temp. memory/storage)
Storage Temperature	-40°F ~ 176°F (-40°C ~ 80°C)
Storage Humidity	5 ~ 95% @ 40°C, non-condensing
Anti-Vibration	With SSD: Random, 3Grms, 5~500Hz
Anti-Shock	With SSD: 50G @ wallmount, Half-sine, 11ms
Certification	CE/FCC Class A





BOXER-6801-RAP

Dimension

Unit: mm

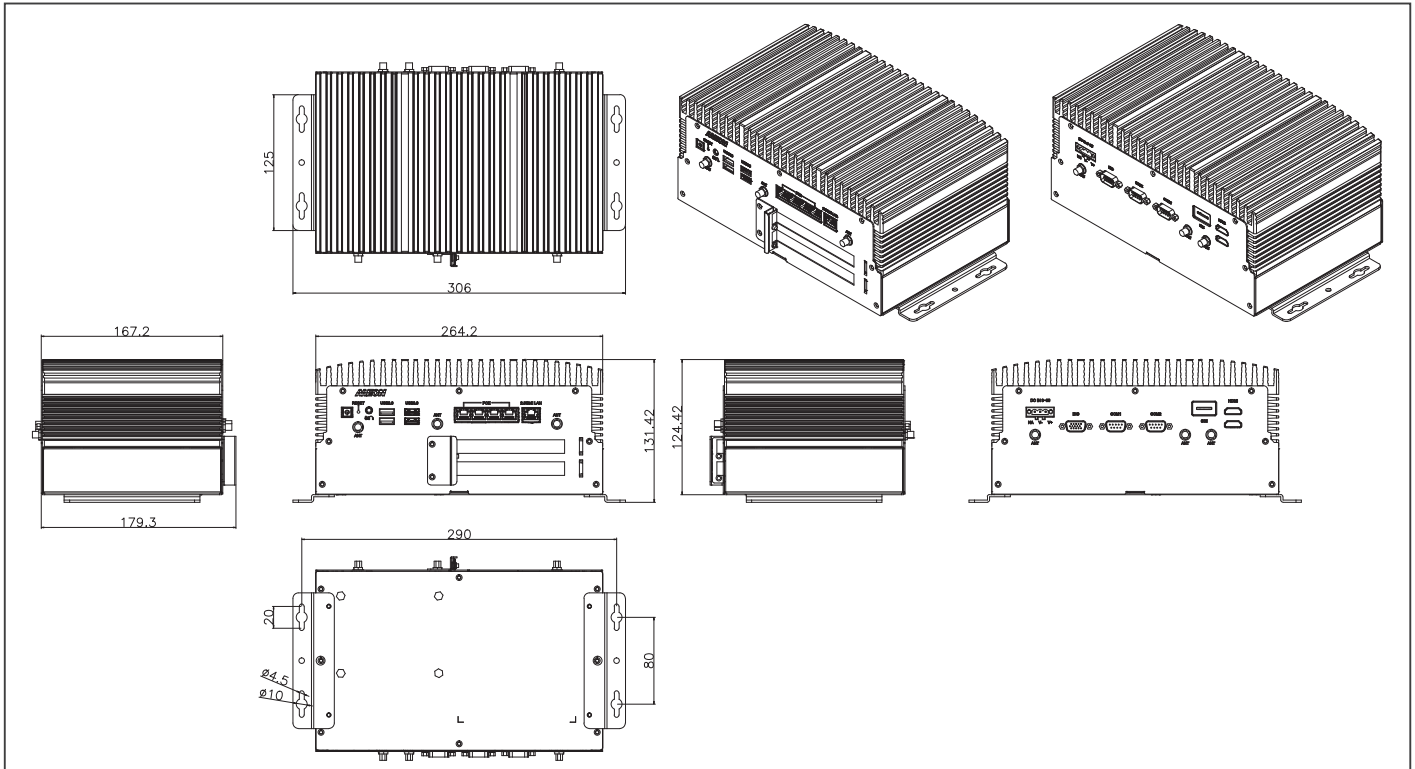

Part Number	Chipset	Cooler	Storage	Display	LAN	USB	RS-232/422/485	Expansion Slot	Power
BOXER-6801-RAP-A1-1010	Intel® Core™ i3-1320PE Processor	Fanless	2.5" SATA Drive Bay x 1 M.2 2280 M-key x 1	HDMI x 2	2.5GbE x 5	USB 3.2 Gen 2 (Type-A) x 2 USB 2.0 (Type-A) x 2	2	M.2 2280 M-key x 1 M.2 2230 E-key x 1 (PCIe) M.2 3052 B-Key x 1 (USB) with SIM slot PCIe[x1] slot x1 PCI slot x1	DC-in 9-36V
BOXER-6801-RAP-A2-1010	Intel® Core™ i5-1340PE Processor	Fanless	2.5" SATA Drive Bay x 1 M.2 2280 M-key x 1	HDMI x 2	2.5GbE x 5	USB 3.2 Gen 2 (Type-A) x 2 USB 2.0 (Type-A) x 2	2	M.2 2280 M-key x 1 M.2 2230 E-key x 1 (PCIe) M.2 3052 B-Key x 1 (USB) with SIM slot PCIe[x1] slot x1 PCI slot x1	DC-in 9-36V
BOXER-6801-RAP-A3-1010	Intel® Core™ i7-1370PE Processor	Fanless	2.5" SATA Drive Bay x 1 M.2 2280 M-key x 1	HDMI x 2	2.5GbE x 5	USB 3.2 Gen 2 (Type-A) x 2 USB 2.0 (Type-A) x 2	2	M.2 2280 M-key x 1 M.2 2230 E-key x 1 (PCIe) M.2 3052 B-Key x 1 (USB) with SIM slot PCIe[x1] slot x1 PCI slot x1	DC-in 9-36V

Packing List

- BOXER-6801-RAP x 1
- Wallmount Bracket x 2
- Screw Package x 1
- 3 Pin DC-in Power Connector x 1

Optional Accessories

- 170X001024
Power Cord (European Type)
- 170X000799
Power Cord (US type)
- 170X000803
Power Cord (Japanese Type)
- 1255X00102
19V 180W Power Adapter

BOXER-6839-CFL

Fanless Embedded Box PC with Socket Type 8th/9th Generation Intel® Processor

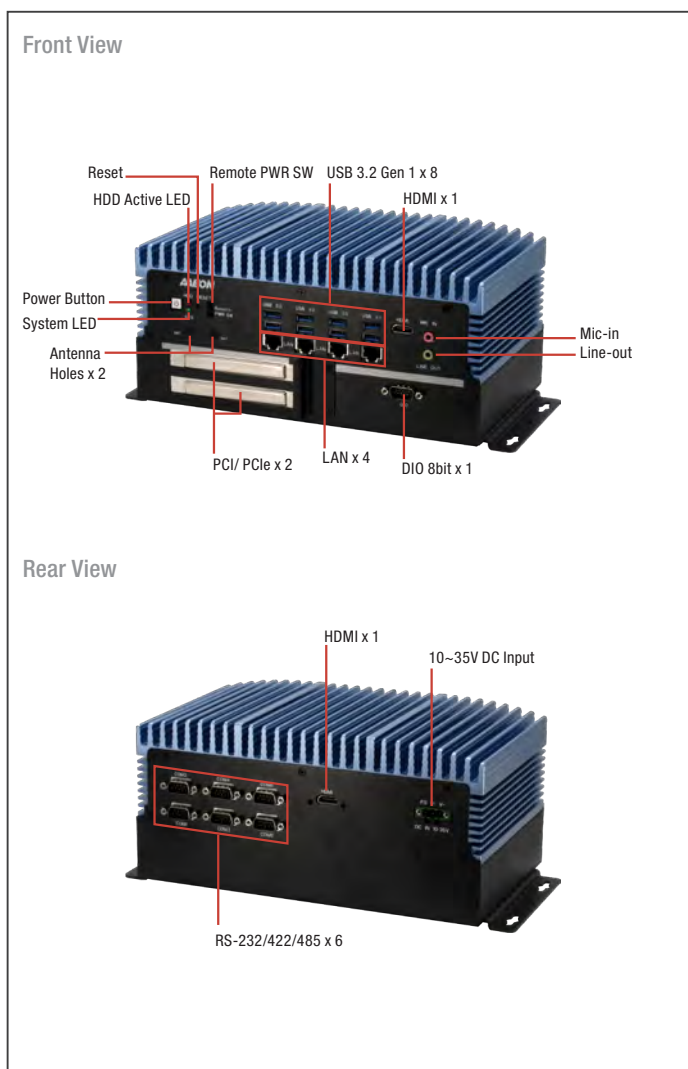

Features

- High Computing Power
- Intel Coffee Lake-S LGA 1151 Desktop Processor
- Support DDR4 ECC or Non-ECC SODIMM, Up to 64GB
- Support HDMI x 2 Double Display
- Support USB 3.2 Gen 1 x 8
- PCIe [x4] & PCI [x1] Expansion



I/O	HDMI x 2 RJ-45 x 4 for GbE LAN (i211 x 3, i219 x 1) USB 3.2 Gen 1 x 8 DB-9 x 6 for RS-232/422/485 Audio x 1 (MIC-in, Line-out) DB-15 for DIO 8 bit x 1 3 pin 10~35V Power Input x 1 Power Button x 1 Remote Power switch x 1 Reset Button x 1
Expansion	Full-size Mini card x 1 (PCIe) Full-size Mini card x 1 ((PCIe/mSATA switch by BIOS, Default: mSATA) SIM slot x 1 PCIe slot : Riser card type 1: PCIe[x4] slot x 1 & PCIe[x1] x 1 (A1) Riser card type 2: PCIe[x4] slot x 1 & PCI x 1 (A2) Riser card type 3: PCI x 2 (A3) Max. size of expansion card 150 x 105 x 40 mm
Indicator	HDD LED x 1 System LED x 1
OS Support	Windows® 10 64-bit, Linux Ubuntu 20.04
Power Supply	
Power Requirement	3-pin Phoenix DC Input 10~35V
Mechanical	
Mounting	Wallmount
Dimensions (W x H x D)	264mm x 156mm x 125mm
Gross Weight	13.2 lb (6.0 kg)
Net Weight	9.9 lb (4.5 kg)
Environmental	
Operating Temperature	-4°F ~131°F (-20°C ~ 55°C) with 0.5 m/s airflow (with TDP ≤ 35W CPU) -4°F~113°F (-20°C ~45°C) with 0.5 m/s airflow (with TDP > 35W CPU)
Storage Temperature	-49°F ~ 176°F (-45°C ~ 80°C)
Storage Humidity	5~95% @ 40°C, non-condensing
Anti-Vibration	5 Grms/ 5 ~ 500Hz/ operation -SSD
Anti-Shock	SSD: 50G @ wallmount, Half-sine, 11ms
Certification	CE/FCC class A

Specifications

System	
CPU	Intel® Xeon® E-2124G Intel® i9-9900T Intel® i7-9700TE Intel® i7-8700T Intel® i5-8500T Intel® i3-8100T Pentium® G5400T Celeron® G4900T
Chipset	C246
System Memory	DDR4-2666 SO-DIMM slot x 2 Up to 64GB, ECC or Non-ECC Support
Display Interface	HDMI x 2
Storage Device	2.5" SATA HDD/SSD Bay x 2
Ethernet	RJ-45 x 4 for GbE LAN (i211-AT x 3, i219-LM x 1)





Dimension

Unit: mm

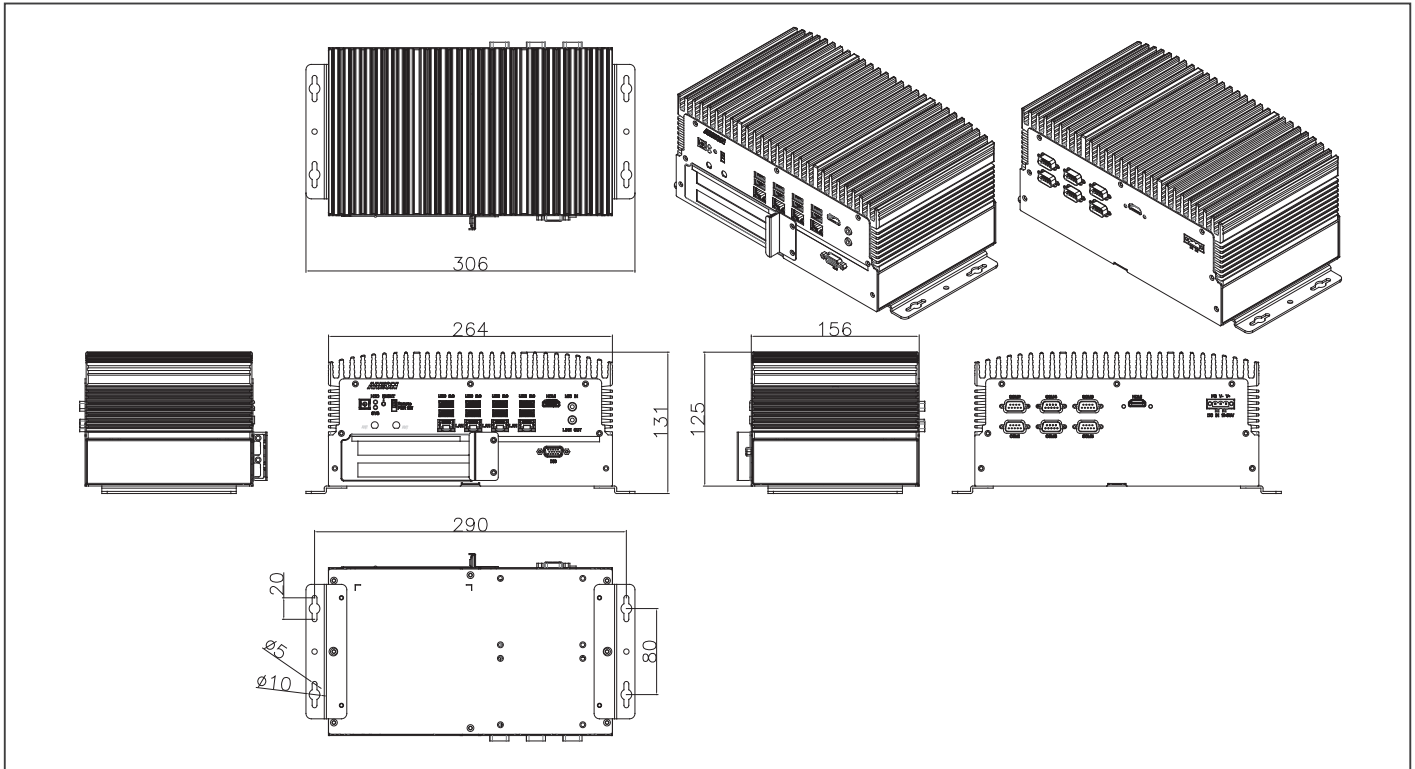

Ordering Information

Part Number	CPU	PCH	LAN	USB 3.2 Gen1	RS-232/422/485	Digital I/O	Audio	Storage	Display	Expansion	Mounting	Power	Operation temp.
BOXER-6839-CFL-A1-1110	—	C246	4	8	6	8 bit	Mic-in x 1 Line-out x 1	2.5" SATA Drive Bay x 2	HDMI x 2	PCIe [x4] x 1 + PCIe[k1] x 1 Full-size Minicard x 2	Wallmount	DC-in 10-35V x 1 for 3-pin Terminal Block	-4°F ~131°F (-20°C ~ 55°C), IEC68-2 with 0.5 m/s AirFlow (with TDP ≤ 35W CPU) * -4°F ~113°F (-20°C ~ 45°C), IEC68-2 with 0.5 m/s AirFlow (with TDP 35W > CPU)
BOXER-6839-CFL-A2-1110	—	C246	4	8	6	8 bit	Mic-in x 1 Line-out x 1	2.5" SATA Drive Bay x 2	HDMI x 2	PCIe [x4] x 1 + PCI x 1 Full-size Minicard x 2	Wallmount	DC-in 10-35V x 1 for 3-pin Terminal Block	-4°F ~131°F (-20°C ~ 55°C), IEC68-2 with 0.5 m/s AirFlow (with TDP ≤ 35W CPU) * -4°F ~113°F (-20°C ~ 45°C), IEC68-2 with 0.5 m/s AirFlow (with TDP 35W > CPU)
BOXER-6839-CFL-A3-1110	—	C246	4	8	6	8 bit	Mic-in x 1 Line-out x 1	2.5" SATA Drive Bay x 2	HDMI x 2	PCI x 2 Full-size Minicard x 2	Wallmount	DC-in 10-35V x 1 for 3-pin Terminal Block	-4°F ~131°F (-20°C ~ 55°C), IEC68-2 with 0.5 m/s AirFlow (with TDP ≤ 35W CPU) * -4°F ~113°F (-20°C ~ 45°C), IEC68-2 with 0.5 m/s AirFlow (with TDP 35W > CPU)

Packing List

- Wallmount Bracket x 2
- Screw Package x 1
- Thermal Pad x 3
- Phoenix Power Connector x 1
- BOXER-6839-CFL

Optional Accessories

- 125590120B
120W Power Adapter
- 1255302300
230W Power Adapter
- 170X000799
Power Cord (US Type)
- 170X000800
Power Cord (Europe Type)
- 170X000803
Power Cord (Japan Type)
- 9741324A00
WiFi/Bluetooth Module & Antenna
- 9741EG25G0
4G Module & Antenna (For Global)

BOXER-6839-RPL PRELIMINARY

Fanless Embedded Controller with 12th, 13th, 14th Gen Intel® Core™ LGA 1700 Socket-Type Processors



Front View

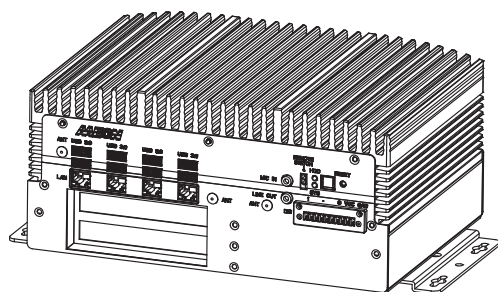

Rear View

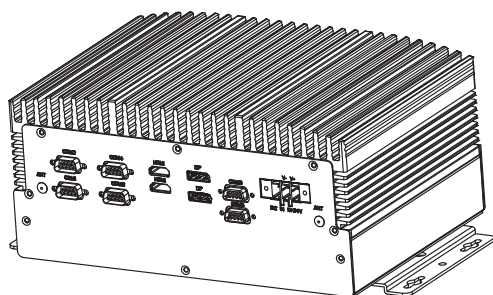

Features

- 14th Gen Intel® Core™ LGA 1700 Socket-Type Processors
- PCIe [x4] + PCIe [x1] / PCIe [x4] + PCI
- Four Simultaneous Displays: HDMI x 2 + DP x 2
- -20°C ~ 55°C Operating Temperature
- USB 3.2 Gen 2 (Type-A) x 8
- 2.5" SATA Drive Bay x 2, Support RAID 0,1 (Optional)



Specifications

System	
CPU	12/13/14th Generation Intel® Core™ LGA 1700 Socket-Type Processors, Max TDP 65W
Chipset	Intel® Q670E Chipset
System Memory	DDR5 4800, SODIMM x 2, up to 64GB
Display Interface	HDMI Type A x 2 Display Port x 2
Storage Device	2.5" SATA Drive Bay x 2 M.2 2280 M-Key x 1 (PCIe Gen 4 [x4]) for NVMe*Note: extra heatsink is required, refer to optional accessories.
Ethernet	RJ-45 for 2.5GbE LAN x 1 RJ-45 for GbE LAN x 3
I/O	USB 3.2 Gen 2 (Type-A) x 8 DB-9 for RS-232/422/485 x 6 Mic-in / Line-out x 1 10-pin Terminal Block for 8-bit DIO x 1 Remote Power on/off x 1 2-pin Remote Power Switch x 1 Power Button with LED Indicator x 1

Expansion	M.2 2230 E-Key x 1 (Wi-Fi) M.2 3052 B-Key x 1 with Nano SIM (LTE/5G) M.2 2280 M-Key x 1 (NVMe) Model A1: PCIe [x4] x 1 + PCIe [x1] x 1 (Total Power Consumption: 25W) Model A2: PCIe [x4] x 1 + PCI x 1 (Total Power Consumption: 25W) Maximum Expansion Card Size: 150mm x 105mm x 40mm (applicable to both slots)
Indicator	TBD
OS Support	Windows 10 IoT LTSC 2021 Windows 11 IoT LTSC 2024 Ubuntu 24.04 and later
Power Supply	
Power Requirement	12V ~ 24V DC-in via 3-pin Terminal Block Connector with protection circuit
Mechanical	
Mounting	Wallmount
Dimensions (W x H x D)	10.3" x 7.3" x 4.8" (264mm x 186mm x 122mm) w/o Brackets
Gross Weight	TBD
Net Weight	TBD
Environmental	
Operating Temperature	-4°F ~ 131°F (-20°C ~ 55°C) with 0.7 m/s airflow (with wide temp. memory/storage)
Storage Temperature	-40°F ~ 176°F (-40°C ~ 80°C)
Storage Humidity	5 ~ 95% @ 40°C, non-condensing
Anti-Vibration	With SSD: Random, 3Grms, 5~500Hz
Anti-Shock	With SSD: 50G @ wallmount, half-sine, 11ms
Certification	CE/FCC class A



BOXER-6842M

Fanless Embedded Controller with 8th/9th Generation Intel® Processor

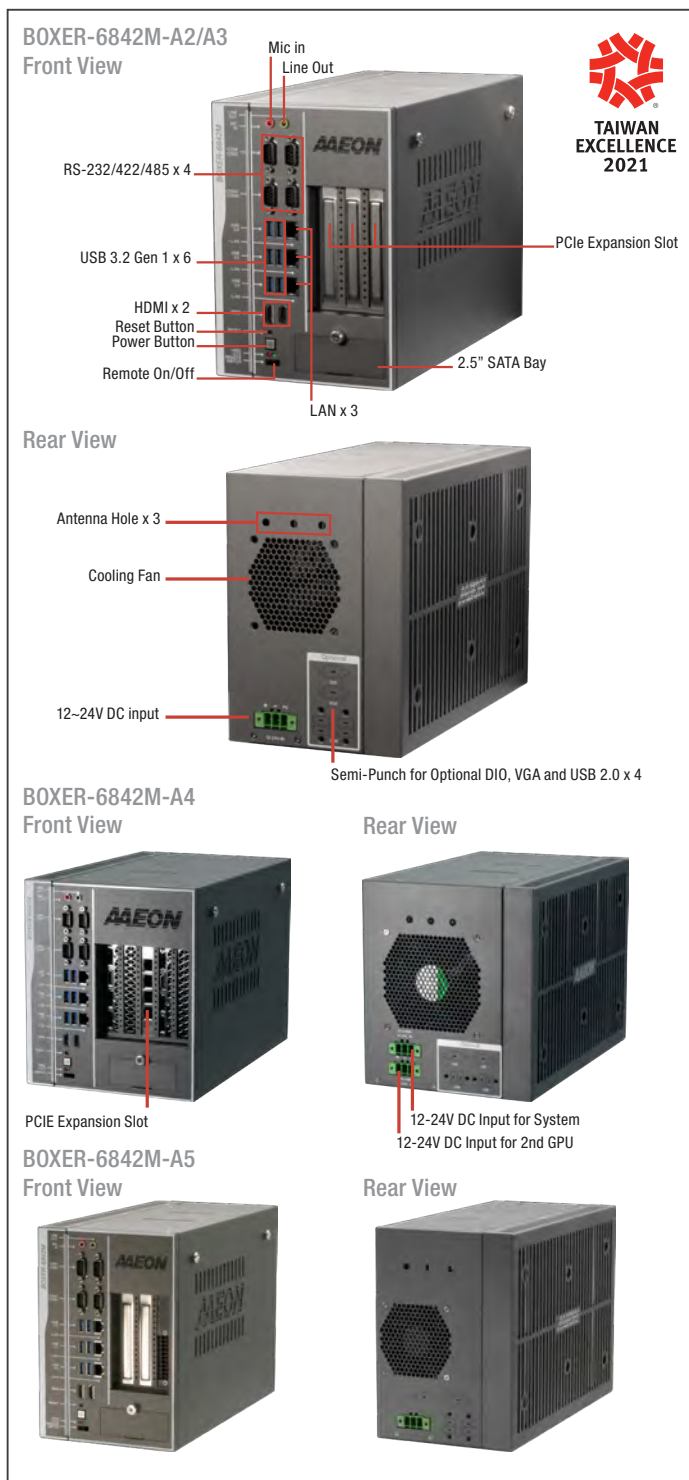

Features

- High Computing Power
- Intel® Coffee Lake-S LGA 1151 Desktop Processor
- HDMI x 2 for Dual Display
- Support C246 PCH
- Support PCIe16 + PCIe4/ 2PCIe x8 (in x16 slot) + PCIe x4
- Single Power Input (for both System & one Graphics Card)
- Fanless System (A3) or Fan System with PWM function (A2/A4/A5)
- Support dual Graphics Cards with Two Power Inputs (A4)



Storage Device	2.5" SATA Drive Bay x2 (4 SATA Port w/ RAID Function) mSATA x 1 (optional) M.2 2280 NVMe SSD slot x 1
Ethernet	RJ-45 x 3 for GbE (Intel i211AT x 2, i219LM x 1)
I/O	HDMI x 2 Audio (Mic-in, Line-out) USB 3.2 Gen1 x 6 DB-9 x4 for RS-232/422/485 with automatic flow control 3 pin DC Power input x 1 (+, -, GND) Power ON/OFF switch x 1 2 pin Remote power on/off connector Reset switch
Expansion	A2/A3/A4/A5 Full-size Minicard x 1 (PCIe + USB with 1 SIM Slot) Half-size Minicard x 1 (PCIe + USB, optional for mSATA) M.2 M key (2280) x 1 (PCIe4) - Max. Power Consumption of GPU card 250W - Max. Size of GPU card 280mm x150mm x 40mm A2 PCIe [x4] x 1 + PCIe [x16] x 1 A3 PCIe [x4] x 1 + PCIe [x8] (in x16 slot) x 2 A4 PCIe [x4] x 1 + PCIe [x8] (in x16 slot) x2 Support dual Graphics Cards with two power inputs A5 Built in Nvidia A2 x1 PCIe [x4] x 1 + PCIe [x8] x 1 (in x16 slot) Note: A3 is fanless system. A2 & A4 & A5 is fan system with PWM function.
Reserved Connector	Internal, SATA x 2; Internal, 8bit DIO x 1; Internal, USB 2.0 x 4; Internal, LPC x 1; Internal, Secondary System Fan Connector x 1
Indicator	System Power LED x 1 (Green), Storage Active LED x 1 (Red)
OS Support	Windows® 10 Enterprise 64 bit, Ubuntu 18.04.4
Power Supply	
Power Requirement	A2/A3/A4 DC In 12~24V with 3-pin terminal block No Graphics Card: CPU 35W->120W Adapter x 1, CPU 71W->240W Adapter x 1 With 250W Graphics Card x1: 480W Adapter x 1 A4 DC In 12~24V with 3-pin terminal block With 250W Graphics Card x2: 330W Adapter x 1 + 480W Adapter x 1 A5 DC In 12~24V with 3-pin terminal block With A2 x 1: 240W Power Adapter x 1 With A2 x 2: 330W Power Adapter x 1
Mechanical	
Mounting	Wallmount
Dimensions (W x H x D)	A2/A3/A5: 6.17" x 8.92" x 12.8" (156.7mm x 226.5mm x 325mm) A4: 7.77" x 8.92" x 12.8" (197.3mm x 226.5mm x 325mm)
Gross Weight	A2/A3: 18.52 lb (8.4 Kg); A4: 20.72 lb (9.4 Kg); A5: 20.5 lb (9.3 Kg)
Net Weight	A2/A3: 15.65 lb (7.1 Kg); A4: 17.86 lb (8.1 Kg); A5: 17.64 (8 Kg)
Environmental	
Operating Temperature	Without Graphics Cards: -4°F ~ 149°F (-20°C ~ 65°C) with 0.5m/s airflow With 250W Graphics Card: 32°F ~ 113°F (0°C ~ 45°C) with 0.5m/s airflow A5: 32°F ~ 113°F (0°C ~ 40°C) with 0.5m/s airflow
Storage Temperature	-49°F ~ 176°F (-45°C ~ 80°C)
Storage Humidity	5 ~ 95% @ 40°C, non-condensing
Anti-Vibration	HDD: Random, 1Grm, 5~500Hz
Anti - Shock	—
Certification	CE / FCC class A

Specifications

System	
CPU	Intel® Xeon® E-2124G; Intel® Core™ i9-9900T; Intel® Core™ i7-8700T; Intel® Core™ i5-9500TE; Intel® Core™ i5-8500T; Intel® Core™ i3-8100T; Intel® Pentium® G5400T; Intel® Celeron® G4900T Note: Support max. TPD 71W Processor
Chipset	C246, No H310 downward support
System Memory	DDR4 SO-DIMM socket x4 (double deck) Support max. 2666MHz up to 128GB Support un-buffered and ECC / non-ECC type SODIMM



ES France - Mobilité & Systèmes Embarqués
127 rue de Buzenval BP 26 - 92380 Garches



Tél. 01 47 95 99 80



e-mail : mse@es-france.com
Site Web : www.es-france.com



Dimension

Unit: mm

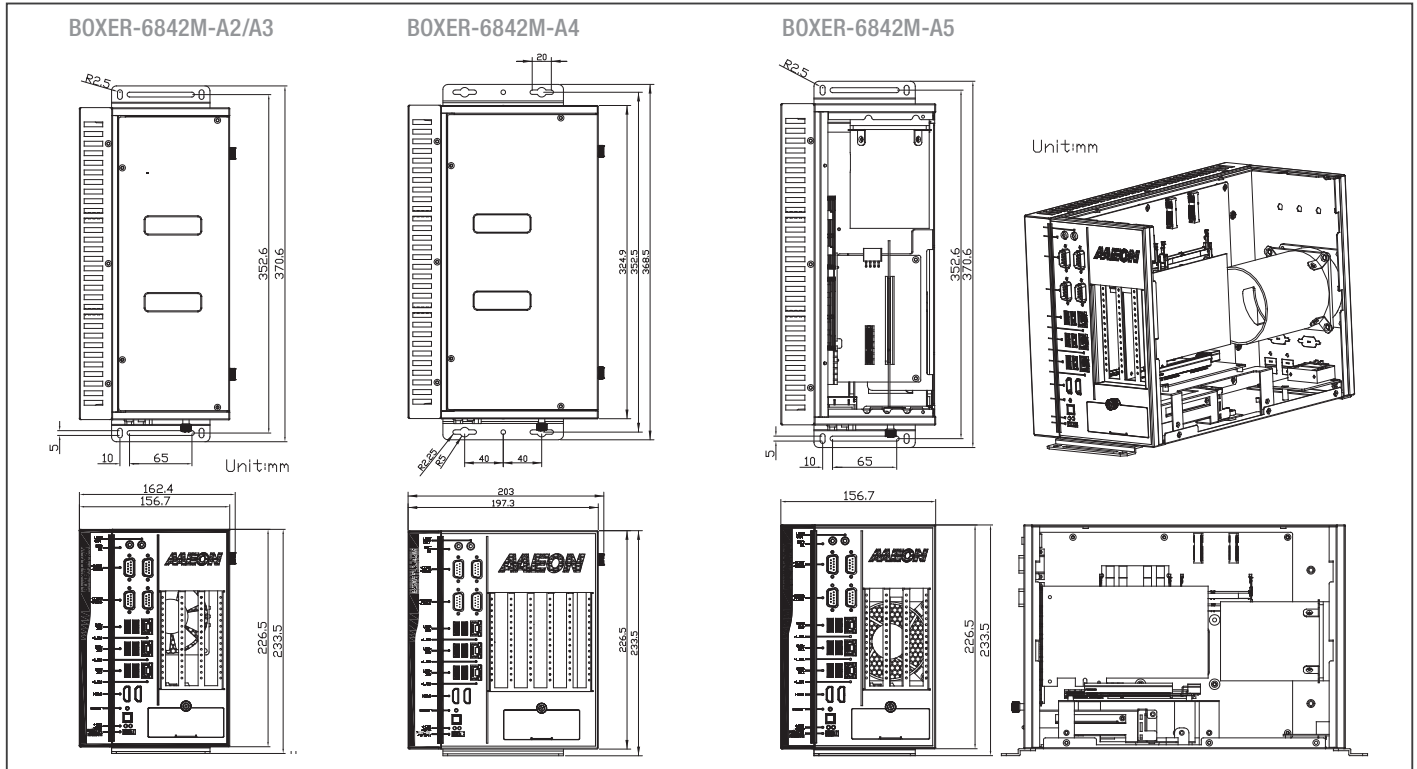

Ordering Information

Part Number	CPU	PCH	LAN	Fan	USB 3.2 Gen1	RS-232/422/485	RS-232	Digital I/O	Audio	Storage	Display	Expansion	Mounting	Power	Operation temp.
BOXER-6842M-A2-1011	—	C246	3	Fan System	6	4	—	—	Mic-in Line-out x 1	2.5" SATA Drive bay x 2 mSATA x 1 (optional) M.2 2280 NVMe SSD slot x 1	HDMI x 2	Full-size Minicard x 1, Half-size Minicard x 1, M.2 M key (2280) x 1, PCIe [x4] x 1, PCIe [x16] x 1	Wallmount	DC In 12-24V with 3-pin terminal block	-20°C ~ 65°C with 0.5m/s airflow
BOXER-6842M-A3-1011	—	C246	3	Fanless System	6	4	—	—	Mic-in Line-out x 1	2.5" SATA Drive bay x 2 mSATA x 1 (optional) M.2 2280 NVMe SSD slot x 1	HDMI x 2	Full-size Minicard x 1, Half-size Minicard x 1, M.2 M key (2280) x 1, PCIe [x4] x 1, PCIe [x8] x 2 (in x16 slot)	Wallmount	DC In 12-24V with 3-pin terminal block	-20°C ~ 65°C with 0.5m/s airflow
BOXER-6842M-A4-1011	—	C246	3	Fan System	6	4	—	—	Mic-in Line-out x 1	2.5" SATA Drive bay x 2 mSATA x 1 (optional) M.2 2280 NVMe SSD slot x 1	HDMI x 2	Full-size Minicard x 1, Half-size Minicard x 1, M.2 M key (2280) x 1, PCIe [x4] x 1, PCIe [x8] x 2 (in x16 slot)	Wallmount	DC In 12-24V with 3-pin terminal block	-20°C ~ 65°C with 0.5m/s airflow

Packing List

- Wallmount Bracket x 2
- 3 Pin DC-in Power Connector x 1
- Screw Package x 1
- Thermal Pad Package x 1
- BOXER-6842M

Optional Accessories

- **1255901209**
120W Power Adapter
- **1255902400**
240W Power Adapter
- **1255903300**
330W Power Adapter
- **170X000799**
Power Cord (US type)
- **170X000800**
Power Cord (European Type)
- **170X000803**
Power Cord (Japanese Type)
- **9741238H00**
WiFi Module & Antenna
- **9741EG25G0**
4G Module & Antenna (for global)
- **9741EC25A0**
4G Module & Antenna (for USA-AT&T)
- **9741EC25V0**
4G Module & Antenna (for USA-Verizon)
- **9697T60101-D**
Riser card with 1 PCIe x 16 + 1 PCIe x 4
- **9697T62100-D**
Riser card with 2PCIe x 8 (in x 16 slot) +1PCIe x 4
- **1255X00021**
480W Power Adapter (DIN Rail)

BOXER-6843-ADS

Embedded Controller with 12th/13th/14th Generation Intel® Core™/Celeron® Processor G Series



Front View



Rear View



Features

- 12th/13th/14th Generation Intel® Core™/Celeron® Processor G Serie
- DDR5 U-DIMM x 4
- HDMI x 2 + DP x 2
- PCIe [x16] + PCIe [x4] or Dual PCIe [x8] (in [x16] slot) + PCIe [x4]
- Support NVIDIA L4



Specifications

System	
CPU	12th Generation Intel® Core™, TDP Max. 65W Intel® Core™ i9-12900TE/i9-12900E Intel® Core™ i7-12700TE/i7-12700E Intel® Core™ i5-12500TE/i5-12500E Intel® Core™ i3-12100TE/i3-12100E 13th Generation Intel® Core™, TDP Max. 65W Intel® Core™ i9-13900TE/i9-13900E Intel® Core™ i7-13700E Intel® Core™ i5-13500E Intel® Core™ i3-13100TE 14th Generation Intel® Core™, TDP Max. 65W Intel® Core™ i9-14900/i9-14900T Intel® Core™ i7-14700/i7-14700T Intel® Core™ i5-14500 Intel® Core™ i3-14100/i3-14100T
Chipset	Q670E
System Memory	DDR5 4800Mhz U-DIMM x 4, up to 128GB
Display Interface	HDMI x 2 (Type-A) Display Port x 2
Storage Device	2.5" SATA Drive Bay x 2 (external, swappable) M.2 2280 M-Key x 2 (PCIe Gen 4 [x4]) 3.5" SATA Drive Bay (internal, non-swappable, optional)
Ethernet	2.5GbE x 3 (Intel® I226-IT) GbE x 1 with LED Indicator (Intel® I219-LM)
I/O	HDMI x 2, Display Port x 2 RJ-45 x 4 3.2 Gen 2 x 8 (Type-A) DB-9 Male x 6 for RS-232/422/485 (Autoflow, Programmable) DB-15 Male x 1 for 8-bit DIO Audio (Mic-in/Line-out) DC 19 ~ 36V 3-pin Terminal Block Connector Power Button with LED x 1 Remote Power On/Off x 1 Reset Button x 1
Expansion	M.2 2230 E-Key x 1 M.2 3052 B-Key w/SIM x 1 M.2 2280 M-Key/B+M-Key x 2 Full-Size Mini Card x 1 (PCIe + USB) A1: PCIe [x4] x 1 + PCIe [x16] x 1 A2: PCIe [x4] x 1 + PCIe [x8] (in x16 slot) x 2 Max. Power Consumption of GPU card 300W Max. Size of GPU card 305mm x 120mm x 50mm
Indicator	—
OS Support	Windows® 10 IoT Enterprise LTSC 2021 Windows® 11 Pro Linux Ubuntu 22.04
Power Supply	
Power Requirement	DC 19~36V 3-pin Terminal Block
Mechanical	
Mounting	Wallmount
Dimensions (W x H x D)	7.35" x 8.92" x 14.76" (186.8 x 226.5 x 375 mm)(Without brackets) 7.35" x 9.19" x 16.50" (186.8 x 233.5 x 419 mm)(With brackets)
Gross Weight	20.9 lb (9.5Kg)
Net Weight	18.1 lb (8.2 Kg)
Environmental	
Operating Temperature	-4°F ~ 113°F (-20°C ~ 45°C), according to IEC68-2 with 0.5 m/s AirFlow (w/ Industrial wide Temp. SSD/RAM)
Storage Temperature	-40°F ~ 176°F (-40°C ~ 80°C)
Storage Humidity	5 ~ 95% @ 40°C, non-condensing
Anti-Vibration	3 Grms/ 5 ~ 500Hz/ operation (with SSD)
Anti-Shock	50G IEC 68-2-27_half sine_11 ms duration (with SSD)



BOXER-6845-BTL PRELIMINARY

Compact Embedded Computer with 15th Gen Bartlett Lake Intel® Core™ Processors



Front View

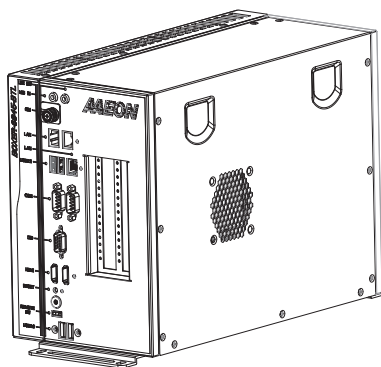

Rear View

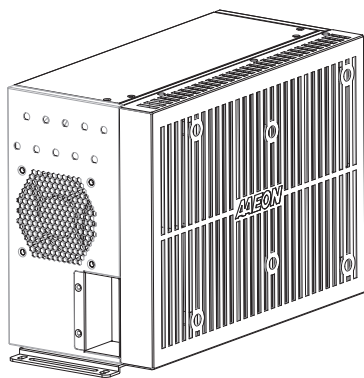

Features

- 15th Gen Bartlett Lake Intel® Core™ Processors, TDP Max. 65W (Intel® Core™ Processors Series 2)
- Compact Size of 310mm x 225mm x 150mm
- DDR5 ECC SODIMM x2 up to 64GB
- 1x SATA Drive Bay & 2x M.2 2280 M-key for Storage
- Support 2x M.2 3052 B-key
- Wide Range 12~24V DC Input with Protection Circuit
- Wide Operating Temperature -20~45°C
- Riser-Card Expansion Slot 1x PCIe[x16] & 1x PCIe[x4]
- Support NVIDIA L4 Graphics Card
- TPM 2.0 onboard



Specifications

System	
CPU	15th Gen Bartlett Lake Intel® Core™ Processors, TDP max. 65W (Intel® Core™ Processors Series 2)
Chipset	W680
System Memory	DDR5 ECC Unbuffered SODIMM x2 up to 64GB
Display Interface	HDMI Type A x2 (Lockable)
Storage Device	2.5" SATA Drive Bay x1 M.2 M-key 2280 x2 (NVMe Gen 4)
Ethernet	RJ-45 for GbE LAN x3 (Lockable, i219-LM x1 & i210-IT x2)
I/O	Type A USB 3.2 (10Gbps) x 2 Type A USB 2.0 x 2 DB-9 for RS-232/422/485 x2 Mic-in/Line-out x1 DB-15 for DIO 8bit x1 Remote power switch x1 Power button with LED indicator x1 Antenna opening x 10 OOB function (optional) Reset button x1
Expansion	M.2 E-key 2230 x 1 (for WiFi) M.2 B-Key 3052 x 2 (for LTE/5G) M.2 M-key 2280 x2 (NVMe Gen 4) Front-access Nano SIM slot x 1 with a cover Riser-card slot 1x PCIe[x16] (75W) & 1x PCIe[x4] (25W), max. size of GPU card: TBD, depth < 26cm
Indicator	—
OS Support	Windows® 10 IoT 2021 LTSC Windows® 11 IoT LTSC Linux Ubuntu 22.04
Power Supply	
Power Requirement	DC-in 12~24V 4-pin terminal block connector With protection circuit
Mechanical	
Mounting	Wall mount
Dimensions (W x H x D)	310 x 225 x 150mm (without brackets)
Gross Weight	TBD
Net Weight	TBD
Environmental	
Operating Temperature	-4°F ~113°F (-20°C ~ 45°C) with 0.7 m/s airflow (with industrial wide temp. memory/storage)
Storage Temperature	-40°F ~ 176°F (-40°C ~ 80°C)
Storage Humidity	5 ~ 95% @ 40°C, non-condensing
Anti-Vibration	3 Grms/ 5 ~ 500Hz/ operation (with SSD)
Anti-Shock	50G @ wallmount, half sine, 11 ms duration (with SSD)
Certification	CE/FCC Class A





Dimension

Unit: mm

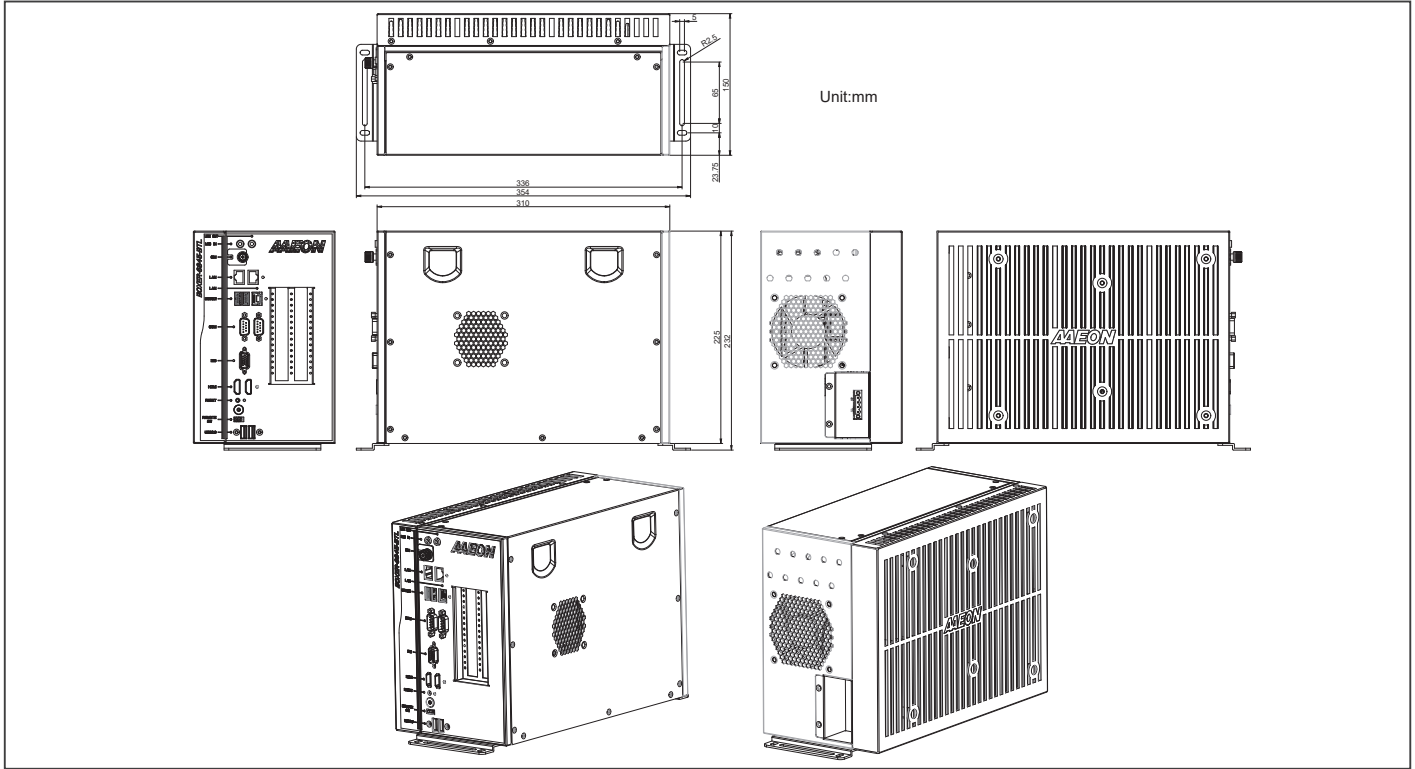

Ordering Information

- TBD

Optional Accessories

- TBD

Packing List

- TBD

PER-T479

4-Port USB 3.2 Gen 1 PCI-E [x4] Frame Grabber Card



Features

- PCI-Express® [x4] Gen. 2 Compliant
- 4 Independent USB 3.2 Gen 1 Host Controller
- Supports Bandwidth 5 Gb/s for Each Port
- Supports Lockable USB Connector



Specifications

System	
Bus Interface	PCI-Express® [x4], Gen 2 PCI-Express Specification Revision 2.1 at 5GT/s
USB	4 independent USB 3.2 Gen 1 host controllers 900mA @ 5V for each port Compliant with USB 3.2 Gen 1 Specification Revision 1.0 4 downstream USB ports support SS/HS/FS/LS data rates (5Gbps/480Mbps/12Mbps/1.5Mbps)
USB Connector	4 USB 3.2 Gen 1 Type-A connectors with lockable screw threads
OS Support	Windows® 10, Windows® 8.1 (32/64-bit), Windows® 7(32/64-bit) Linux
Power Supply	
Power Requirement	12V from external IDE 4-pin power connector
Mechanical	
Dimensions (W x D)	4.72" x 4.21" (120mm x 107mm)
Environmental	
Operating Temperature	32°F ~ 140°F (0°C ~ 60°C) (according to IEC68-2-14 with 0.5 m/s AirFlow ; with industrial devices)
Storage Temperature	-49°F ~ 176°F (-45°C ~ 80°C)
Storage Humidity	5 ~ 95% @ 40°C, non-condensing

Ordering Information

- PER-T479-A11-00
4-Port USB 3.2 Gen 1 PCI-E [x4] Frame Grabber Card





PER-T481-A10 / LAN

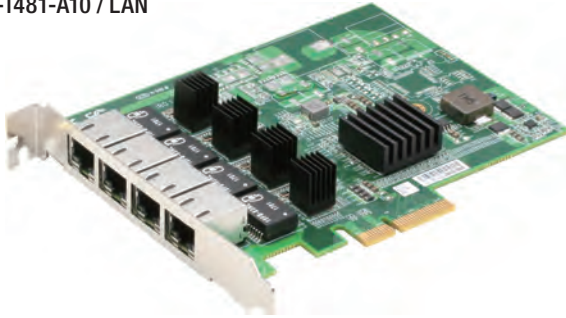

PER-T481-A20 / LAN



PER-T481-A30 / POE

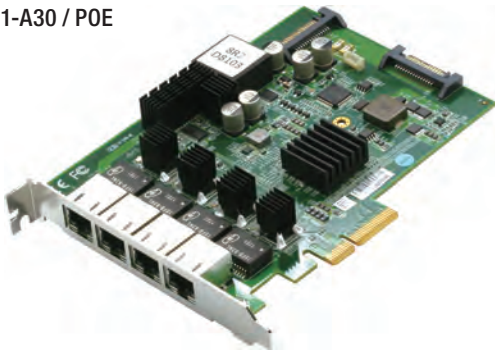

PER-T481-A40 / POE



Features

LAN:

- PCI-Express® [x4] Gen. 2 Compliant
- Gigabit Ethernet Controller, Intel® I210-IT
- Supports Bandwidth 1Gb/s for Each Port
- Supports for Link Aggregation/Jumbo Frames (9 KByte)

POE:

- PCI-Express® [x4] Gen 2 Compliant
- Gigabit Ethernet Controller, Intel® I210-IT
- Supports Bandwidth 1Gb/s for Each Port
- Supports for Link Aggregation/Jumbo Frames (9 KByte)



Specifications

System	
Bus Interface	PCI-Express® [x4], Gen 2 PCI-Express Specification Revision 2.0 at 5GT/s
USB	—
USB Connector	—
Ethernet	LAN: Intel® I210-IT Ethernet Controller x 4 (A10) Intel® I210-IT Ethernet Controller x 2 (A20) Fully compliant with IEEE 802.3 and IEEE 802.3u Support IEEE 1588 precision time synchronization POE: I210-IT Ethernet Controller x 4 (A30) Intel® I210-IT Ethernet Controller x 2 (A40) Fully compliant with IEEE 802.3 and IEEE 802.3u Support IEEE 1588 precision time synchronization Support IEEE 802.3 at
OS Support	LAN: Windows® 10(32/64-bit), Windows® 8.1 (32/64-bit), Windows® 7(32/64-bit), Linux POE: Windows® 10(32/64-bit), Windows® 8.1 (32/64-bit), Windows® 7(32/64-bit) (Linux not Supported)
Power Supply	
Power Requirement	LAN: Max. 10W POE: 4POE DUAL SATA Power (15 pin) DC Input 12~24V,Max. 90W for 4ports (A30) 2POE DUAL SATA Power (15 pin) DC Input 12~24V,Max. 60W for 2ports (A40)
Mechanical	
Dimensions (W x D)	LAN: 4.33" x 5.35" (110mm x 136mm) POE: 4.41" x 5.91" (112mm x 150mm)
Environmental	
Operating Temperature	LAN: -4°F ~ 140°F(-20°C ~ 60°C) (according to IEC68-2-14 with 0.5 m/s AirFlow; with industrial devices) POE: -4°F ~ 131°F(-20°C ~ 55°C) (according to IEC68-2-14 with 0.5 m/s AirFlow; 90W loading) (A30) -4°F ~ 131°F(-20°C ~ 55°C) (according to IEC68-2-14 with 0.5 m/s AirFlow; 60W loading) (A40)
Storage Temperature	-49°F ~ 176°F (-45°C ~ 80°C)
Storage Humidity	5 ~ 95% @ 40°C, non-condensing

Ordering Information

- PER-T481-A10-00
4-Port Intel GbE LAN PCIE x4 Lane Frame Grabber Card
- PER-T481-A20-00
2-Port Intel GbE LAN PCIE x4 Lane Frame Grabber Card
- PER-T481-A30-00
4-Port Intel POE PCI-E [x4] Frame Grabber Card
- PER-T481-A40-00
2-Port Intel POE PCI-E [x4] Frame Grabber Card

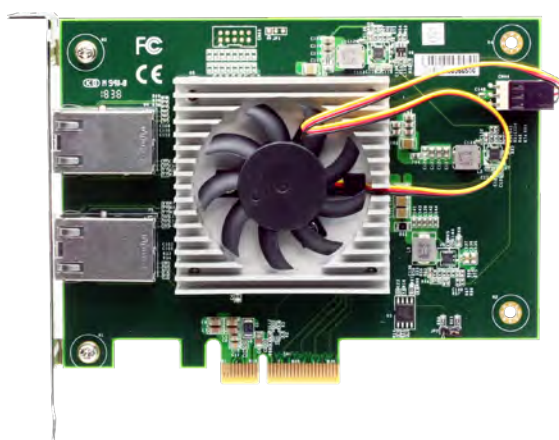

Features

- PCI-Express® [x4] Gen 2 Compliant
- 2 10Gigabit Ethernet Controller, Intel® x550
- Supports CAT-6/6a RJ45 cable
- Supports NBASE-T and 1000BASE-T with CAT-5/ 5e cable
- Supports 15.5 KB Jumbo Frame, NIC teaming and IEEE 1588



Specifications

System	
Bus Interface	PCI-Express® [x4], Gen 2 PCI-Express Specification Revision 2.1 at 5GT/s
USB	—
USB Connector	—
Ethernet	2 Ports 10GbE Ethernet w/ Intel X550 Controller Fully compliant with IEEE 802.3 and IEEE 802.3u Support IEEE 1588 precision time synchronization Support 15.5 KB Jumbo Frame, teaming Support IEEE 802.3 Ethernet interface for 10GBASE-T (IEEE 802.3an) Support NBASE-T (IEEE 802.3bz) and 1000BASE-T (IEEE 802.3ab)
OS Support	Windows® 10(64-bit), Windows® 8.1 (64-bit), Windows® 7(64-bit), Linux 18.04.1
Power Supply	
Power Requirement	Max. 7.84W
Mechanical	
Dimensions (W x D)	3.94" x 5.35" (100mm x 136mm)
Environmental	
Operating Temperature	32°F ~ 140°F(0°C ~ 60°C) (according to IEC68-2-14 with 0.5 m/s AirFlow ; with industrial devices)
Storage Temperature	-49°F ~ 176°F (-45°C ~ 80°C)
Storage Humidity	5 ~ 95% @ 40°C, non-condensing

Ordering Information

- PER-T514-A10-00
2 Ports Intel® 10GbE LAN PCI-E [x4] Frame Grabber Card



Focus - Agility - Competitiveness



ES France - Mobilité & Systèmes Embarqués
127 rue de Buzenval BP 26 - 92380 Garches



Tél. 01 47 95 99 80



e-mail : mse@es-france.com
Site Web : www.es-france.com

07

07

Smart In-vehicle & AMR BOX PC



ES France - Mobilité & Systèmes Embarqués
127 rue de Buzenval BP 26 - 92380 Garches



Tél. 01 47 95 99 80



e-mail : mse@es-france.com
Site Web : www.es-france.com

VPC-3350S

Multi-PoE & Fanless Appliance with Intel® Pentium®/ Celeron®/ Atom® Processor

Front View

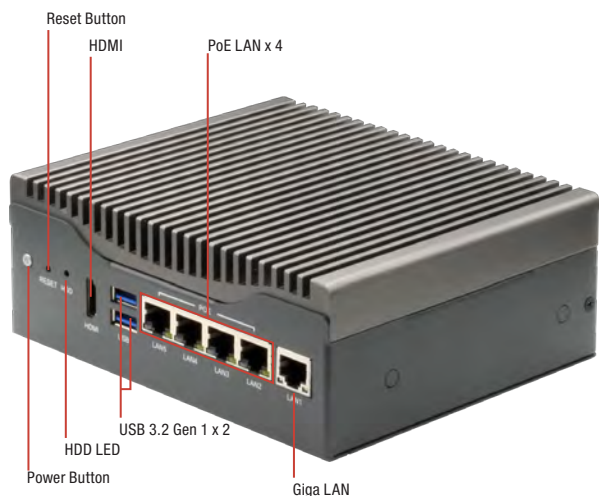

Rear View

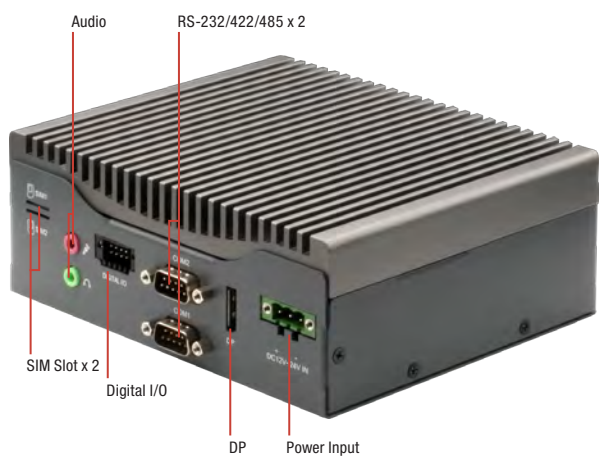

Features

- Mobile Industrial Platform
- DDR3L 1866, Single-Channel SODIMM x 1, Non-ECC (Max. 8GB, up to 1600MHz)
- Intel® Integrated Graphics Engine Supports Two Displays via HDMI & DP
- Intel® Ethernet Connection x 5 (Inc. PoE x 4)
- Full-size Mini PCIe x 2 (USB + PCIe, up to Mini PCIe x 4, in-vehicle platform)
- Built-in CANBus, GPS & G-Sensor (in-vehicle platform)



Specifications

System	
Form Factor	Multi-PoE & Fanless Appliance
Processor	Intel® Pentium®/ Celeron®/ Atom® Processor (Default: Intel Atom® x5-E3940 Processor)
Chipset	—
Main Memory	DDR3L 1866, Single-Channel SODIMM x 1, Non-ECC (Max. 8GB, up to 1600MHz)
Display	HDMI x 1, DP x 1
Ethernet	Intel® Ethernet Controller I211 (co-lay I210)
Smart PoE	4 ports, sharing 60W of power budget for every four PoE ports
RAID support	—
Expansion Slot	Full-size Mini Card Slot x 2 (USB 2.0 + PCIe, up to 4 slots, in-vehicle platform) SATA x 1 Built-in CANBus (in-vehicle platform)
GPS, G-Sensor	Built-in GPS & G-Sensor (In-vehicle platform)
Front I/O Panel	Power Button x 1 Reset Button x 1 Power/HDD, LED x 2 USB 3.2 Gen 1 x 2 GbE port (RJ-45) x 1 PoE LAN x 4 (IEEE 802.3 at/af) HDMI x 1 CanBus connector x 1 (In-vehicle platform) RS-232 x 3 (In-vehicle platform)
Rear I/O Panel	DC Power Input x 1 8-bit DIO x 1, 4-ch Digital Input, 4-ch Digital Output RS-232/422/485 x 2 DP x 1 Audio Line-out x 1, Mic-In x 1 Micro SIM Slot x 2
Storage	
HDD Tray	2.5" HDD/SSD Bay x 1
CF/CFast/mSATA Slot	—
Environmental	
Operating Temperature	-4°F ~ 158°F (-20°C ~ 70°C)
Storage Temperature	-40°F ~ 185°F (-40°C ~ 85°C)
Storage Humidity	10%~80% @40°C, non-condensing
Vibration/Shock	MIL-STD-810G
Certification	CE & FCC Class A
Power Requirement	
Power Supply	DC 12V-24V, DC 9V-36V with power ignition (in-vehicle platform)
Mechanical	
Removable HDD Tray	—
Internal System HDD Bay	—
Dimension	6.3" x 5.28" x 2.44" (160mm x 134mm x 62mm) 6.3" x 5.28" x 2.95" (160mm x 134mm x 75mm), In-vehicle platform.
Gross Weight	3.96 lb. (1.8 Kg)
Note	—





Dimension

Unit: mm

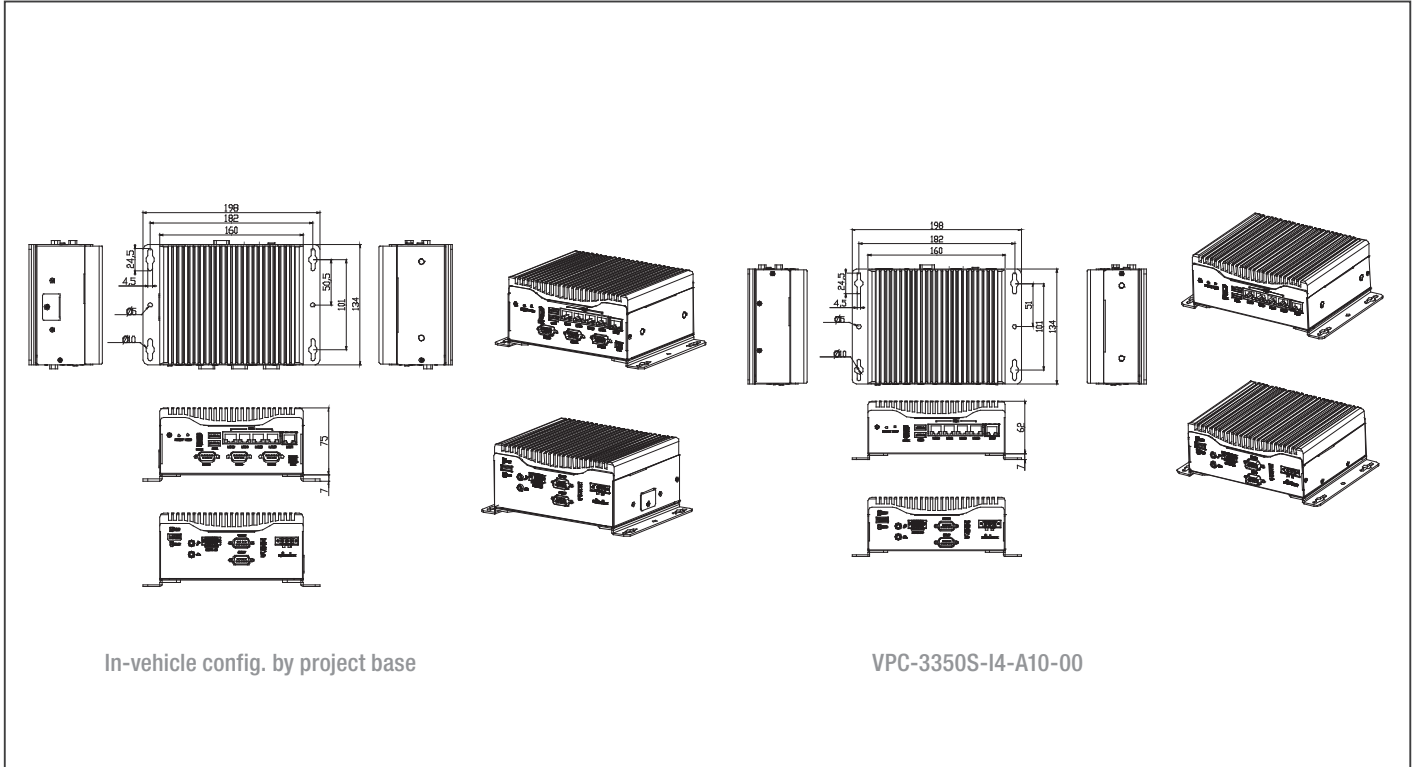

Ordering Information

Part Number	Processor	RAM	Cooler	Storage	RAID Support	Display	LAN	PoE	USB	RS-232	RS-232/422/485	Expansion Slot	Form Factor	Power
VPC-3350S-IS-A12-00	Intel Atom® x5-E3940	DDR3L 204-pin SODIMM	Fanless	2.5" SSD Bay x 1	—	DP x 1, HDMI x 1	GbE x 1	4 Ports	USB 3.2 Gen 1 x 2	—	2	Mini-Card x 2	Desktop	DC 12-24V

Packing List

- SATA Cable x 1
- Power Cable x 1 (for SATA)
- VPC-3350S

Optional Accessories

- **9741236A00**
WiFi module kit, 802.11ac/a/b/g/n.BT4.2.USB Signal.SparkLan.WPET-236ACN(BT).W/2 sets of cable&antenna
- **978966660G**
GPS Antenna
- **9741EG25G0**
PCle mimi card 4G LTE module kit Global Band W/SIM holder w/ Cable & antenna
- **170X000800**
Power Cord (European Type)
- **170X000799**
Power Cord (US Type)
- **170X000803**
Power Cord (Japanese Type)
- **9651335001**
Package of VPC-3350S mating connectors
- **1255X00059**
(TF)AC/DC Power Supply.input AC100-240V output DC 19V.6.32A.120W.3P phoenix.5.08mm.FSP.FSP120-ABAN3.9NA1208542

VPC-5600S

Multi-PoE & Fanless Appliance with 7th Generation Intel® Core™ Processors

Front View

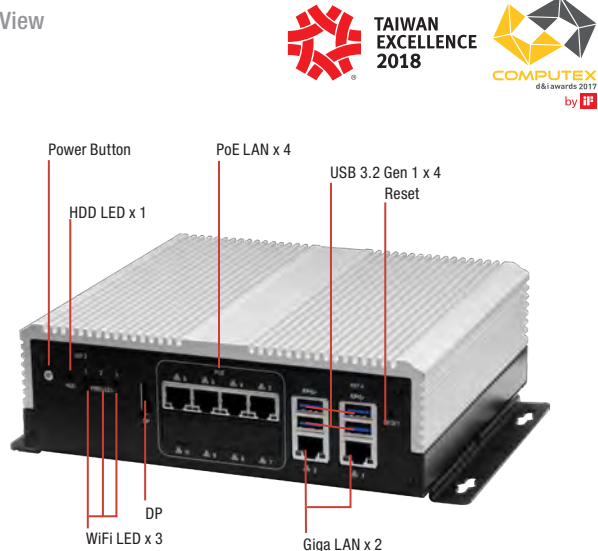

TAIWAN
EXCELLENCE
2018



Features

- In-Vehicle Platform
- 260-pin DDR4 2133MHz SODIMM x 2, up to 32GB
- Intel® Integrated Graphics Engine Supports HDMI x 1 + DP x 1
- Realtek® Ethernet x 6 (PoE x 4, LAN x 2)
- Mini-PCIe x 3 (Full Size x 2, Half Size x 1), mSATA x 1 (Optional)
- Built-in CAN 2.0B. Optional OBDII Function (SAE J1939/J1708) (UART Interface)
- E-Mark Certified



Rear View

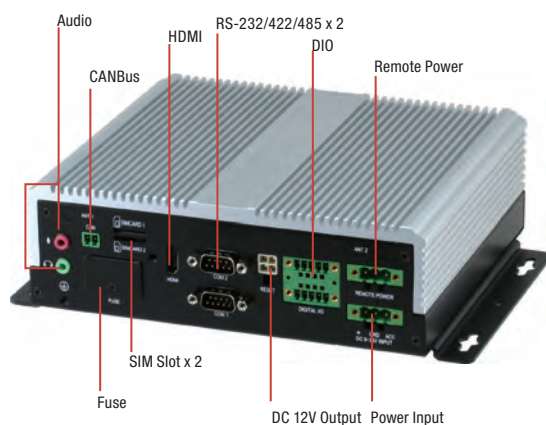

Specifications

System	
Form Factor	Multi-PoE & Fanless Appliance
Processor	7th Generation Intel® Core™ i3/i5/i7 Processors Default: Intel® Core™ i3-7100U Project Base: Intel® Core™ i5-7300U, Intel® Core™ i7-7600U
Chipset	—
Main Memory	DDR4 2133MHz SODIMM x 2, up to 32GB
Display	HDMI x 1, DP x 1
Ethernet	PoE x 4, LAN x 2, RTL8111E 10/100/1000 Base-T
Smart PoE	4 ports, sharing 60W of power budget for every four PoE ports.
RAID support	RAID 0, RAID 1
Expansion Slot	Mini-Card x 3 (USB 2.0 x 2 + PCIe & USB 2.0 x 1) Built-in CAN 2.0B x 1
GPS, G-Sensor	On board (GPS/GLONASS), G Sensor
Front I/O Panel	Power Button x 1 3G/4G/WIFI LED x 3 USB 3.2 Gen 1 x 4 RJ-45 x 2 for GbE PoE LAN x 4 (IEEE 802.3 at/af) DP x 1 Reset Button x 1
Rear I/O Panel	DC-in Power x 1 Remote Power x 1 8-bit DIO x 1, 4-CH Digital Input (Wet/dry contact with Isolation Protection 3,000VDC), 4-CH Digital Output (Compatible 5V/TTL, 31mA Max. per Channel) 12V/1A DC Output x 1 RS-232/422/485 x 2 HDMI x 1 CanBus x 1, Audio Line-out x 1, Mic-In x 1 SIM Slot x 2
Storage	
HDD Tray	2.5" SATA SSD x 2
CF/CFast/mSATA Slot	mSATA Slot x 1 (Optional, If mSATA x 1 used, then only one SATA available)
Environmental	
Operating Temperature	-4°F ~ 158°F (-20°C ~ 70°C)
Storage Temperature	-40°F ~ 185°F (-40°C ~ 85°C)
Storage Humidity	10%~80% @40°C, non-condensing
Vibration/Shock	MIL-STD-810G
Certification	CE & FCC Class A, EMARK
Power Requirement	
Power Supply	DC 10-36V, with ignition pin
Mechanical	
Removable HDD Tray	Hot swappable 2.5" SSD x 2 (Project base) via extension module
Internal System HDD Bay	2.5" HDD x 2
Dimension	6.85" x 7.87" x 2.52" (174mm x 200mm x 64mm)
Gross Weight	5.7 lb. (2.6Kg)





Dimension

Unit: mm

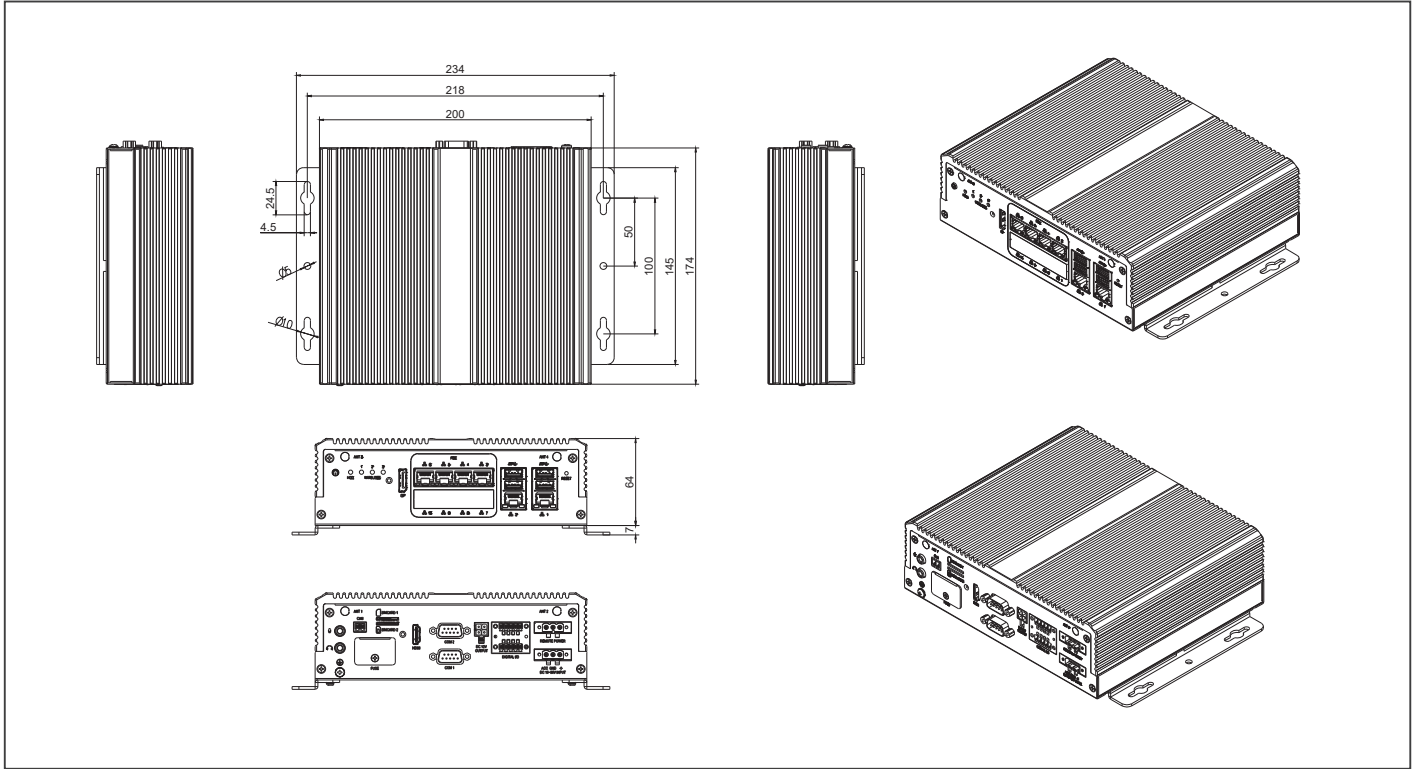

Ordering Information

Part Number	Chipset	RAM	Cooler	Storage	RAID Support	Display	LAN	PoE	USB	RS-232	RS-232/422/485	Expansion Slot	Form Factor	Power
VPC-5600S-143-A11-W1	Intel® Core™ i3-7100U	32GB DDR4 SODIMM x 2	Fanless	2.5" SSD x 2	RAID 0, 1	DP x 1, HDMI x 1	GbE x 2	4 Ports	USB 3.2 Gen 1 x 4	—	2	Mini-Card x 3 Built-in CAN2.0B x 1	Desktop	DC 10-36V

Packing List

- Wall mount bracket
- SATA cable x 2
- SATA Power Cable x 2
- VPC-5600S

Optional Accessories

- **9741236A00**
WiFi module kit, 802.11ac/a/b/g/n.BT4.2.USB Signal.SparkLan.WPET-236ACN(BT).W/2 sets of cable&antenna
- **978966660G**
GPS Antenna
- **9741EG25G0**
PCIe mimi card 4G LTE module kit Global Band W/SIM holder w/ Cable & antenna
- **170X000800**
Power Cord (European Type)
- **170X000799**
Power Cord (US Type)
- **170X000803**
Power Cord (Japanese Type)
- **9651560001**
Package of VPC-5600S mating connectors
- **1255X00059**
(TF)AC/DC Power Supply.input AC100-240V output DC 19V.6.32A.120W.3P phoenix.5.08mm.FSP.FSP120-ABAN3.9NA1208542

VPC-5640S

Multi-PoE & Fanless Appliance with 12th Generation Intel® Core™ i7 Processor

Front View

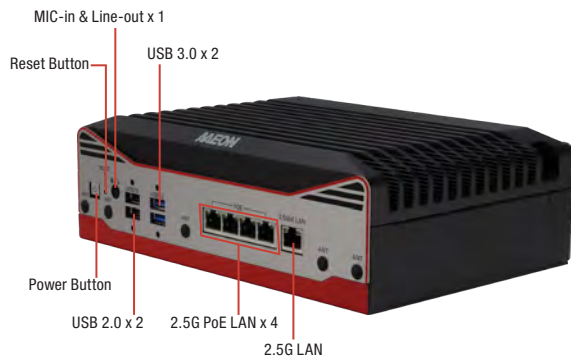

Rear View

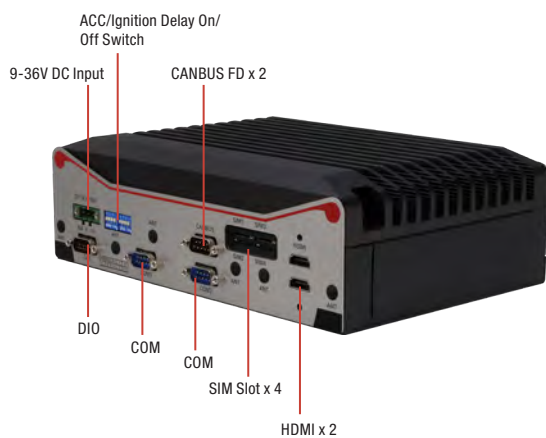

Features

- 12th Gen Intel® Core™ i7 Processor
- DDR5 SODIMM x 2, Max 64GB
- 2.5GbE POE/PSE 802.3 af/at x 4
- Dual LTE Module with SIM Slots x 4, 5G Supported
- M.2 2280 M-Key (PCIe [x4])/M.2 2230 E-Key)
- M.2 3052 B-Key x 2 (USB 2.0, USB 3.0)
- Onboard TPM 2.0
- 9 ~ 36V DC-in with protection circuit and ignition delay on/off
- -40°C ~ 70°C Operating Temperature
- MIL-STD-810H and E-Mark Certified



Specifications

System	
Form Factor	Multi-PoE & Fanless Appliance
Processor	Default: 12th Generation Intel® Core™ i7-1265UE Processor Project Based: Intel® Core™ i5-1245UE Intel® Core™ i3-1215UE
Chipset	—
Main Memory	DDR5 SODIMM x 2, up to 64GB
Display	HDMI x 2
Ethernet	2.5GbE x 1 (Intel® I226-LM)
Smart PoE	2.5GbE x 4 (Intel® Ethernet Controller I226-LM) (IEEE 802.3 at/af, sharing total 60W of power budget for all four PoE ports) *Note: The system only supports total 20W PoE when input voltage is at or below 10V
RAID support	—
Expansion Slot	M.2 2230 E-Key x 1 (PCIe [x1] + USB 2.0, for WiFi/Bluetooth Module) M.2 3052 B-Key w/ Dual-SIM x 2 (USB 3.0 + USB 2.0, for LTE/5G Module) M.2 2280 M-Key x 1 (PCIe [x4]), support NVME PCIe [x4] SSD)
GPS, G-Sensor	VS: Built-in GPS, NEO-M9V & G-Sensor
Front I/O Panel	USB 3.2 Gen 2 (Type-A) x 2 USB 2.0 (Type-A) x 2 2.5GbE LAN x 1 2.5GbE PoE LAN x 4 (IEEE802.3 at/af) Jack x 1 for Line-out & MIC-in Reset Button x 1 Power Button x 1
Rear I/O Panel	DB-9 Male x 2 for RS-232/422/485 DB-9 Male x 1 for Isolated CANBus FD x 2 DB-15 Male x 1 for DIO 8 bit HDMI 1.4b x 2 3-pin Terminal Block x 1 DIP Switch x 1 SIM Slot x 4
Storage	
HDD Tray	2.5" HDD/SSD Bay x 1
CF/CFast/mSATA Slot	—
Environmental	
Operating Temperature	-40°F ~ 158°F (-40°C ~ 70°C), IEC68-2 with 0.5 m/s AirFlow
Storage Temperature	-40°F ~ 176°F (-40°C ~ 80°C)
Storage Humidity	5 ~ 95% @ 40°C, non-condensing
Vibration/Shock	MIL-STD-810H
Certification	CE/FCC Class A, UKCA, E-Mark
Power Requirement	
Power Supply	IS: DC-in 9~36V x 1 for 3-pin Terminal Block VS: DC-in 9~36V x 1 for 3-pin Terminal Block with power ignition
Mechanical	
Removable HDD Tray	—
Internal System HDD Bay	2.5" HDD/SSD Bay x 1
Dimension	9.45" x 6.58" x 2.99" (240mm x 167.1mm x 76mm) Without brackets 11.69" x 6.58" x 3.27" (297mm x 167.1mm x 83mm) With brackets





Dimension

Unit: mm

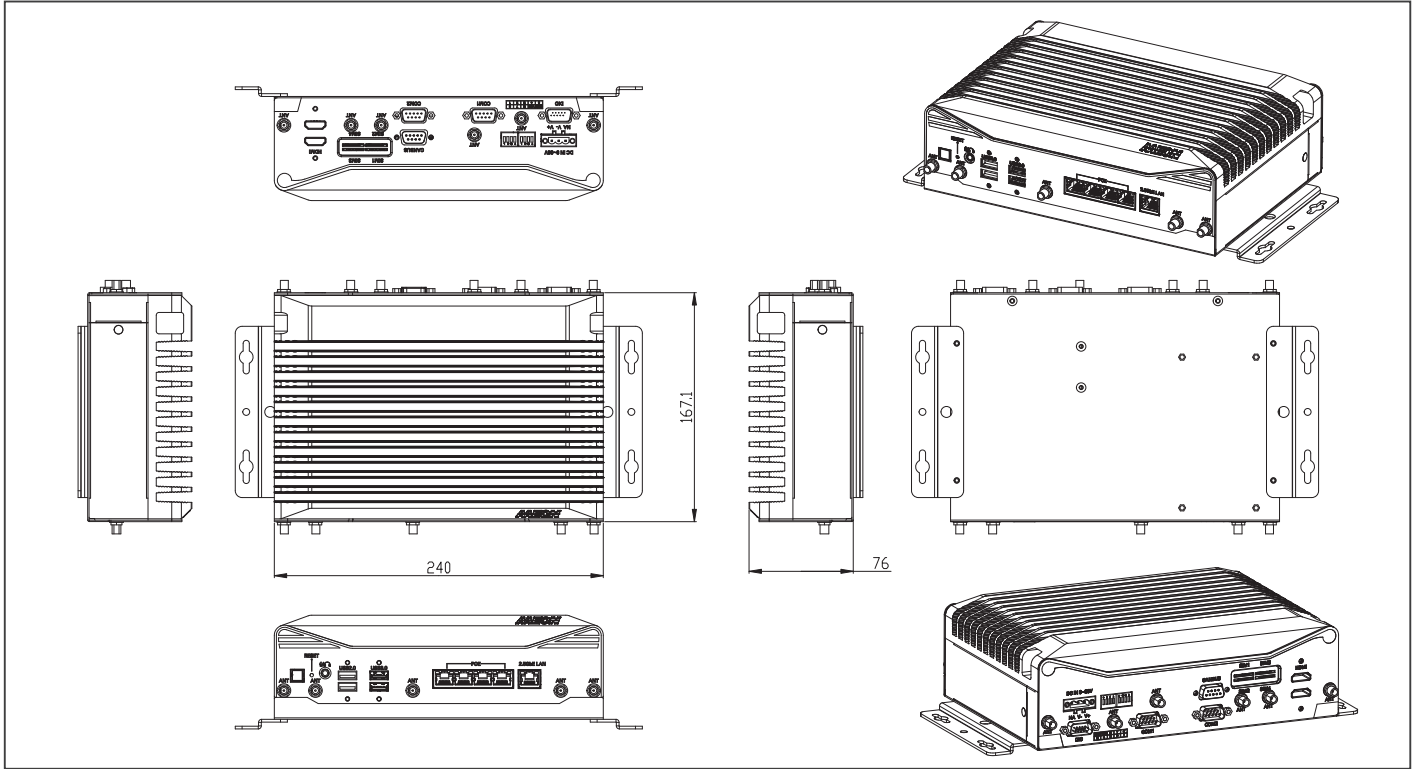

Ordering Information

Part Number	Chipset	RAM	Cooler	Storage	RAID Support	Display	LAN	PoE	USB	RS-232	RS-232/422/485	Expansion Slot	Power
VPC-5640S-IS-A10-00	Intel® Core™ i7-1265UE	—	Fanless	M.2 2280 M-Key x 1 (PCIe [x4]) 2.5" SATA Drive Bay x 1	—	HDMI x 2	2.5GbE x 1	2.5GbE POE/PSE 802.3 af/at x 4 (Max. 60W)	USB 3.2 Gen 2 x 2 USB 2.0 x 2	—	2	M.2 2280 M-Key x 1 M.2 2230 E-Key x 1 M.2 3052 B-Key x 2 w/ Dual-SIM	DC 9-36V
VPC-5640S-VS-A10-00	Intel® Core™ i7-1265UE	—	Fanless	M.2 2280 M-Key x 1 (PCIe [x4]) 2.5" SATA Drive Bay x 1	—	HDMI x 2	2.5GbE x 1	2.5GbE POE/PSE 802.3 af/at x 4 (Max. 60W)	USB 3.2 Gen 2 x 2 USB 2.0 x 2	—	2	M.2 2280 M-Key x 1 M.2 2230 E-Key x 1 M.2 3052 B-Key x 2 w/ Dual-SIM Built-In GPS NEO-M9V module	DC 9-36V ignition

Packing List

- VPC-5640S x 1
- Wallmount Bracket x 2
- Screw Package x 1
- 3 Pin DC-in Power Connector x 1

Optional Accessories

- 170X000800
Power Cord (European Type)
- 170X000799
Power Cord (US Type)
- 170X000803
Power Cord (Japanese Type)
- 1255X00059
120W Power Adapter

08

08

UP Systems



UP 4000 Edge

UP 4000 System with Intel® Pentium® N4200/ Celeron® N3350/ Atom® E3950 Processor SoC

Front View

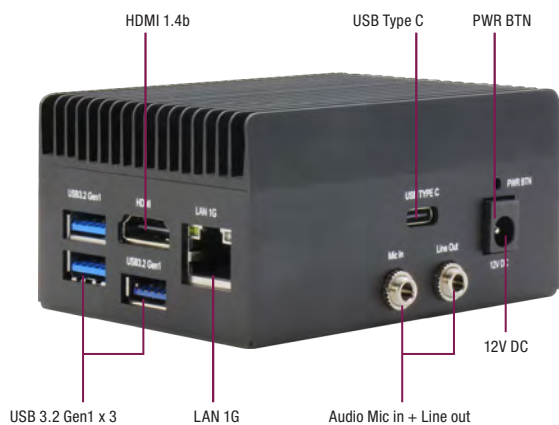

Rear View



Features

- Intel® Pentium® N4200/ Celeron® N3350/ Atom® E3950 Processor SoC
- Onboard LPDDR4 Memory up to 8GB
- Onboard eMMC Storage up to 64GB
- Dual displays up to 4K at 30Hz
- Gigabit LAN x 1, HDMI x 1, USB 3.2 Gen 1 (Type A) x 3
- Audio Jack x 1 (Line out + Mic in)
- 12V DC-in, 5A
- TPM 2.0



Specifications

System	
CPU	Intel® Celeron® Processor N3350 Intel® Pentium® Processor N4200 Intel Atom® x7-E3950
Memory	Up to 8GB onboard LPDDR4
Graphics	Intel® HD Graphics
Storage	Up to 64GB onboard eMMC
Ethernet	1GbE RJ-45 x 1 (Realtek RTL8111-CG)
WiFi/BT	—
Expansion Slot	—
Security	Onboard TPM 2.0
OS Support	Windows 10/11 (64-bit) Linux Ubuntu 22.04 Linux Yocto 4.0
I/O Placements	
USB	USB 3.2 Gen 1 (Type-A) x 3 USB 3.0 OTG (via USB Type-C) x 1
Display Port	HDMI 1.4b x 1 DP x 1 (via USB Type-C)
Ethernet	RJ45 x 1
COM	—
Audio	Audio wafer x 1 (Mic-in+Line-out)
GPIO	—
Power Supply	
Power requirement	12V DC-in
Power supply type	AT/ATX (AT as default)
Power Consumption (Typical)	19W~25W
Mechanical	
Mounting	VESA Mount (optional) / Wallmount (optional) / DIN Rail (optional)
Dimensions (WxHxD)	3.62" x 2.52" x 1.78" (92mm x 64mm x 45.2mm)
Net Weight	0.64lb (0.29kg)
Gross Weight	1.21lb (0.55kg)
Environment	
Operating Temperature	32°F ~ 140°F (0°C ~ 60°C) with air flow 0.5m/s
Operating Humidity	10% ~ 80% relative humidity, non-condensing
Storage Temperature	-4°F ~ 158°F (-20°C ~ 70°C)
MTBF	538,629 hrs @ 30°C
Certification	CE/FCC Class A, RoHS Compliant, REACH





Dimension

Unit: mm

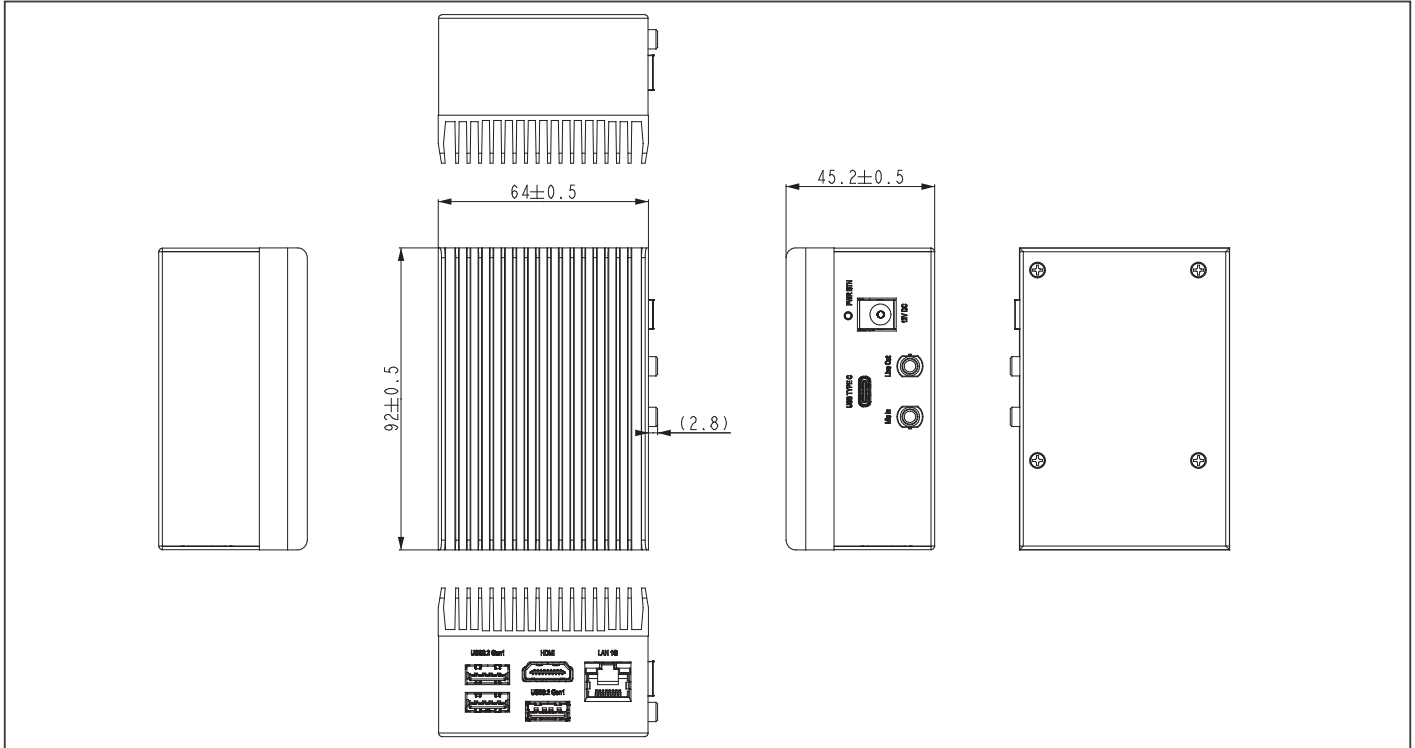

Ordering Information

Part number	CPU	Memory	Storage	TPM 2.0	Gbe	LAN	Audio wafer
UP-EDGE-APL03C2F-A10-0232	Apollo Lake N3350(F1)	2GB	32GB	yes	Realtek	RTL8111H	yes
UP-EDGE-APL03C2F-A10-0432	Apollo Lake N3350(F1)	4GB	32GB	yes	Realtek	RTL8111H	yes
UP-EDGE-APL03P4F-A10-0432	Apollo Lake N4200(F1)	4GB	32GB	yes	Realtek	RTL8111H	yes
UP-EDGE-APL03P4F-A10-0864	Apollo Lake N4200(F1)	8GB	64GB	yes	Realtek	RTL8111H	yes
UP-EDGE-APL03X7F-A10-0464	Apollo Lake E3950(F1)	4GB	64GB	yes	Realtek	RTL8111H	yes

Packing List

- UP 4000 Edge

Optional Accessories

Part Number	Description
1255X00114	(TF)AC/DC Adapter.12V.65W.5.42A.MEANWELL.NGE65112-P1J.Wallmount.W/O AC PLUG
9741364A00	(TF).M.2 2230 Wireless.802.11 ac/a/b/g/n + BT 5.0.2T2R,Enli OCNFA364A.w/2 sets of cable and antenna
9651926001	(TF).M.2 2230 WiFi Kit.802.11ac.2.4G/5G,W/BT Intel.9260.NG.WG. NV.958867 w/2 cable & antenna
9689Y00122	(TF).AC PLUG.5 keys.EU/US/UK/AU/CN.MEANWELL.AC PLUG-MIX4
UP-MNT-A10-0000	Wallmount+DinRail Kit for UP4000Edge/UP7000Edge
9651UPED00	(TF).VESA kit.UP4000-EDGE, A.1

UP 7000 Edge

UP 7000 System with Intel® Processor N-series Processor (formerly Alder Lake N)

Front View



Rear View



Features

- Intel® Processor N-series
- Onboard LPDDR5 Memory, up to 8GB
- Onboard eMMC Storage, up to 64GB
- 1Gigabit LAN x 1
- HDMI 1.4b x 1
- USB 3.2 Gen 2 (Type-A) x 3
- 12V DC-in, 5A
- TPM 2.0



Specifications

System	
CPU	Intel® Processor N200 Intel® Processor N97 Intel® Processor N100 Intel® Processor N50 (formerly Alder Lake-N)
Memory	Up to 8GB LPDDR5
Graphics	Intel® UHD Graphics for 12th Gen Intel® Processors
Storage	Up to 64GB eMMC
Ethernet	1GbE RJ-45 x 1 (Realtek RTL8111H CG)
WiFi/BT	—
Expansion Slot	HDMI 1.4b/USB 3.2 Gen 2 STACK Connector x 1 (Type-A) Power Button x 1
Security	Onboard TPM 2.0
OS Support	Windows 10/11 (64-bit) Linux: Ubuntu 22.04 LTS/Kernel 5.15, Yocto 4.0
I/O Placements	
USB	USB 3.2 Gen 2 (Type-A) x 3
Display Port	HDMI 1.4b x 1
Ethernet	1GbE RJ-45 x 1 (Realtek RTL8111H CG)
COM	—
Audio	—
GPIO	—
Power Supply	
Power requirement	12V DC-in, 5A
Power supply type	AT/ATX (ATX as default)
Power Consumption (Typical)	30W~36W
Mechanical	
Mounting	VESA Mount (optional)/Wallmount (optional) / DIN Rail (optional)
Dimensions (WxHxD)	3.62" x 2.52" x 1.78" (92mm x 64mm x 45.2mm)
Net Weight	0.68 lbs (0.31kg)
Gross Weight	1.04 lbs (0.47kg)
Environment	
Operating Temperature	32°F ~ 131°F (0°C ~ 55°C) with 0.5m/s air flow
Operating Humidity	10% ~ 80% relative humidity, non-condensing
Storage Temperature	-4°F ~ 158°F (-20°C ~ 70°C)
MTBF	685,218 Hours
Certification	CE/FCC Class A, RoHS Compliant, REACH





Dimension

Unit: mm

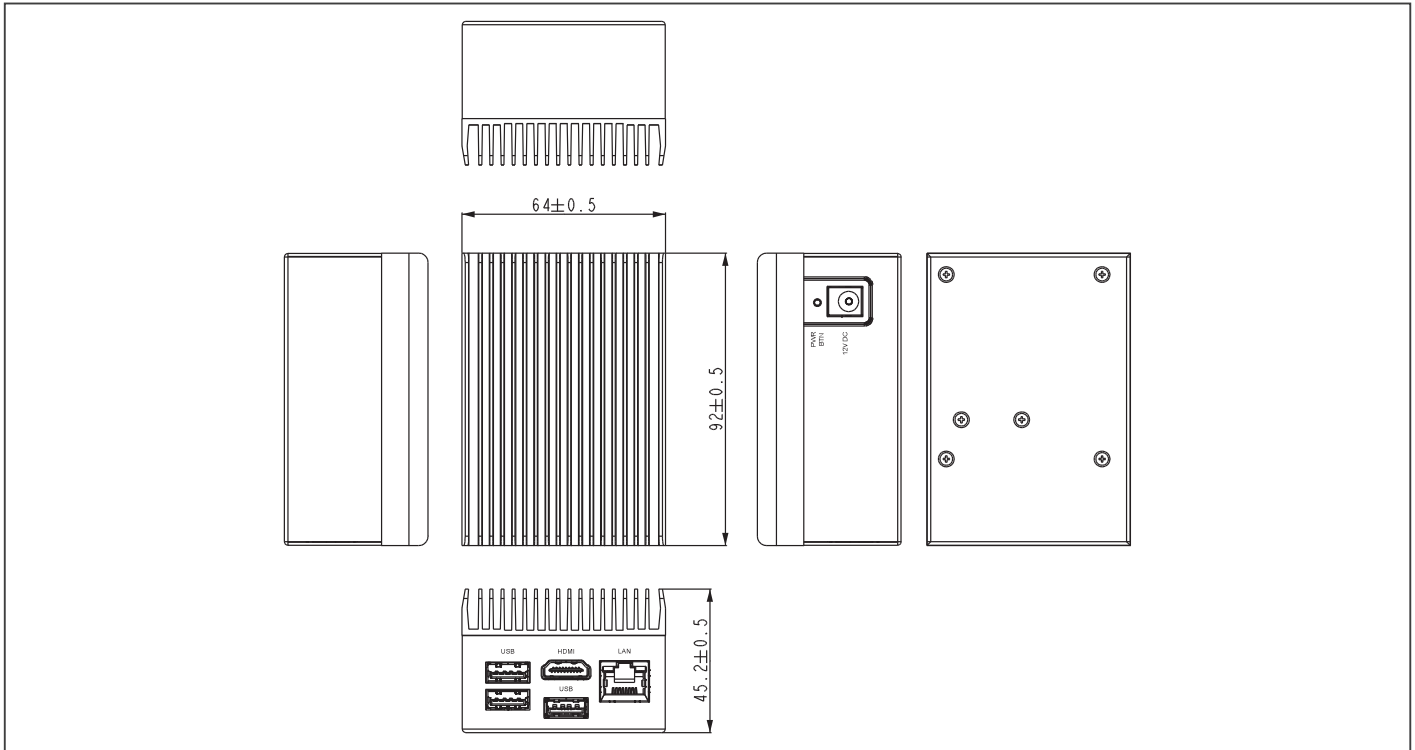

Ordering Information

Part Number	CPU	Core	Memory	Storage
UP-EDGE-ADLN50-A10-0432-A11	Intel® Processor N50	2	4GB	32GB
UP-EDGE-ADLN100-A10-0432-A11	Intel® Processor N100	4	4GB	32GB
UP-EDGE-ADLN100-A10-0864-A11	Intel® Processor N100	4	8GB	64GB
UP-EDGE-ADLN97-A10-0864-A11	Intel® Processor N97	4	8GB	64GB
UP-EDGE-ADLN200-A10-0864-A11	Intel® Processor N200	4	8GB	64GB
UP-EDGE-ADLN97-A10-0432-A11	Intel® Processor N97	4	4GB	32GB

Optional Accessories

Part Number	Description
1255X00114	(TF)AC/DC Adapter.12V.65W.5.42A.MEANWELL.NGE65112-P1J.Wallmount.W/O AC PLUG
170010015G	(TF)USB Cable.10P 1.0mm Housing.USB A(F). 15cm
9689Y00122	(TF).AC PLUG.5 keys.EU/US/UK/AU/CN.MEANWELL.AC PLUG-MIX4
9651UPED00	(TF).VESA kit.UP4000-EDGE
UP-MNT-A10-0000	Wallmount+DinRail Kit for UP4000Edge/UP7000Edge

Packing List

- UP 7000 Edge

UP 710S Edge

UP 710S System with Intel® Processor N-series Processor (formerly Alder Lake N)

Front View



Rear View



Features

- Intel® Processor N-series
- Onboard LPDDR5 Memory, up to 8GB
- Onboard eMMC Storage, up to 64GB
- 1 GbE LAN x 1
- HDMI 1.4b x 1
- USB 3.2 Gen 2 (Type-A) x 3
- 12V DC-in, 5A
- TPM 2.0
- M.2 2230 E-Key
- GPIO x 8, COM x 1



Specifications

System	
CPU	Intel® Processor N200 Intel® Processor N97 Intel® Processor N100 Intel® Processor N50 (formerly Alder Lake-N)
Memory	Up to 8GB LPDDR5
Graphics	Intel® UHD Graphics for 12th Gen Intel® Processors
Storage	Up to 64GB eMMC
Ethernet	1GbE RJ-45 x 1
WiFi/BT	Optional with M.2 2230 E-key x 1
Expansion Slot	M.2 2230 E-Key x 1 (PCIe x1, USB2.0 x1)
Security	Onboard TPM 2.0
OS Support	Microsoft Windows 10/11 Ubuntu 22.04 LTS Yocto 5.1
I/O Placements	
USB	USB 3.2 Gen 2 (Type-A) x 3
Display Port	HDMI 1.4b x 1
Ethernet	1GbE RJ-45 x 1
COM	RS-232/422/485 x 1
Audio	—
GPIO	GPIO x 8 (Optional: PWM x 1, I2C x 1, SPI x 1; by project base, please contact AAEON sales)
Power Supply	
Power requirement	12V DC-in, 5A
Power supply type	AT/ATX
Power Consumption (Typical)	30W~36W
Mechanical	
Mounting	DIN Rail, VESA
Dimensions (WxHxD)	3.62" x 3.03" x 1.51" (92mm x 77mm x 38.5mm)
Net Weight	0.67 lb. (0.30Kg)
Gross Weight	0.78 lb. (0.35Kg)
Environment	
Operating Temperature	23°F ~ 140°F (-5°C ~ 60°C) with 0.5m/s air flow
Operating Humidity	10% ~ 80% relative humidity, non-condensing
Storage Temperature	-4°F ~ 158°F (-20°C ~ 70°C)
MTBF	685,218
Certification	CE/FCC Class A, RoHS Compliant, REACH





Dimension

Unit: mm

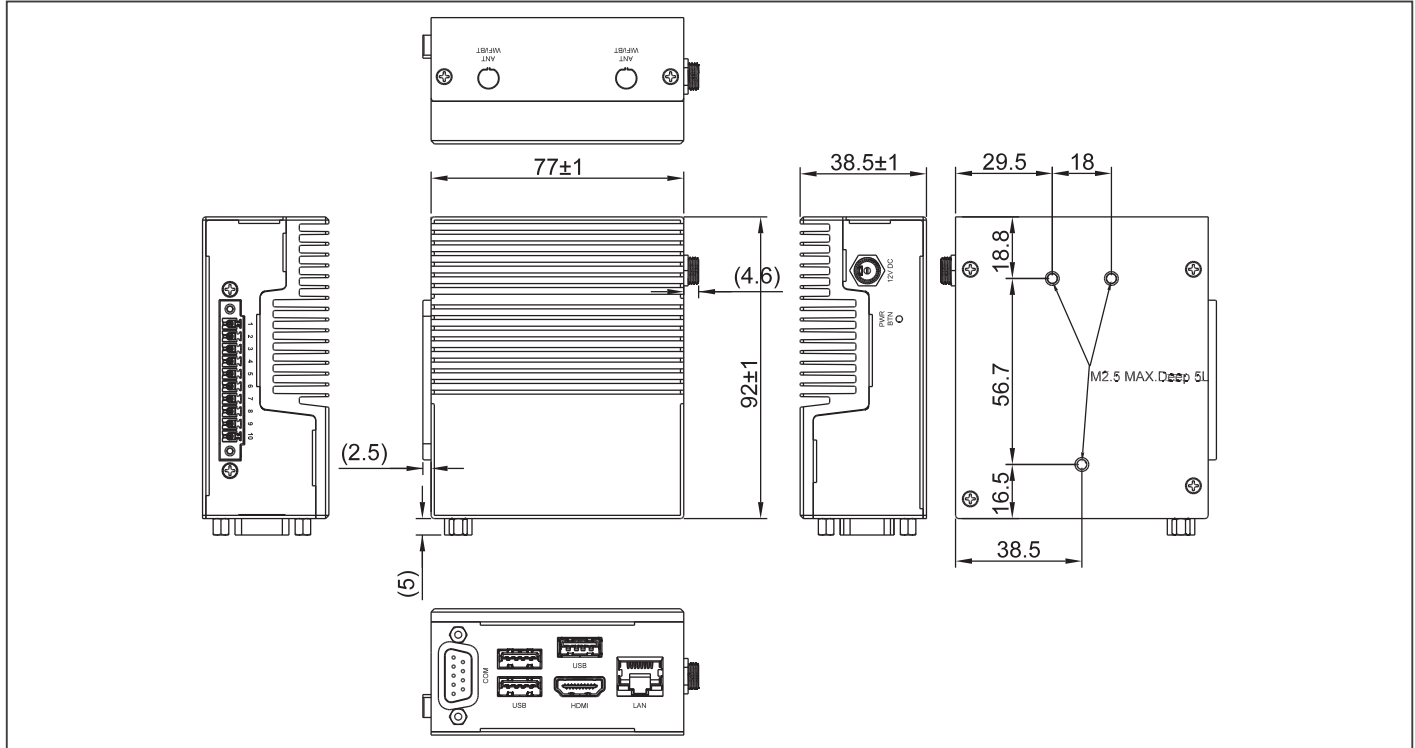

Ordering Information

Part Number	CPU	Core	Memory	Storage
UP-EDGE-ASL02N100-A10-0432	Intel® Processor N100	4	4GB	32GB
UP-EDGE-ASL02N100-A10-0864	Intel® Processor N100	4	8GB	64GB
UP-EDGE-ASL02N97-A10-0864	Intel® Processor N97	4	8GB	64GB

Optional Accessories

Part Number	Description
1255X00032	(TF)AC/DC Adapter.Input AC.100~240V.Output DC.12V.MAX 72W.6.0A.180D.W/ LOCK.EDAC. EA10681U(120)
170X000799	(TF)Power Cord. 3P. 125V. 10A. 180D. USA. 1. 8M. I-SHENG. SP305B/IS-14N SVT 18/3 60C CT-12 Black
170X000800	(TF)Power Cord. 3P. 250V. 10A. VDE. 1. 8M. I-SHENG. SP23/IS-14N H05VV-F 3G 0.75 CT-12 Black
170X000815	(TF)Power Cord. 3P. 250V. 10A. 180D. CHINA. 1. 8M. I-SHENG. SP506A/IS-14N RVV 300/500V 3X0.75 CT-12 Black
170X000806	(TF)Power Cord. 3P. 125V. 7A. 1. 8M. I-SHENG. U4NCB3T6B1218002. SP305B/IS-14N VCTF. Black. BSMI
170X000803	(TF)Power Cord.3P.125V/7A.PSE Certificate.1.8M.I-SHENG.U4NCB3P6C1218002.SP305B/IS-14N VCTF 0.75/3 Black 1.8M
170X000810	(TF)Power Cord.3P.250V.16A.Korea.1.8M.I-SHENG.SP23/IS-14N H05VV-F 3G 0.75 CT-12 Black
170X000805	(TF)Power Cord.3P.250V.10A.SWISS.1.8M.I-SHENG.SP-027C/IS-14N H05VV-F 3G 0.75mm CT-12 Black
9651210000	Wireless LAN Kit M.2 2230 802.11ax/ac/a/b/g/n + BT5.2,2.4G/5G/6G,with 2 sets of cable & antenna (Intel AX210)
9651885200	Wireless LAN Kit M.2 2230 802.11ax/ac/a/b/g/n + BT5.2,2T2R,with 2 sets of cable & antenna (Eni.ENL-8852CE)
170010015G	(TF)USB Cable.10P 1.0mm Housing.USB A(F). 15cm
UP-ASL02VESAKIT-A10-0001	VESA KIT for UP-EDGE-ASL02
UP-DRKIT-A10-0001	DIN Rail KIT for UP Series

Packing List

- UP 710S Edge

Front View



Rear View



Features

- Intel® Processor N-series
- Onboard LPDDR5 Memory, up to 8GB
- Onboard eMMC Storage, up to 64GB
- 1Gigabit LAN x 1
- HDMI 1.4b x 1
- USB 3.2 Gen 2 (Type-A) x 3
- 12V DC-in, 5A
- TPM 2.0



Specifications

System	
CPU	Intel® Core™ 3 Processor N355 Intel® Processor N250 Intel® Processor N150 (formerly Twin Lake)
Memory	Up to 8GB LPDDR5
Graphics	Intel® UHD Graphics for 12th Gen Intel® Processors
Storage	Up to 64GB eMMC
Ethernet	1GbE RJ-45 x 1 (Realtek RTL8111H CG)
WiFi/BT	—
Expansion Slot	HDMI 1.4b/USB 3.2 Gen 2 STACK Connector x 1 (Type-A) Power Button x 1
Security	Onboard TPM 2.0
OS Support	Windows® 11 LTSC Ubuntu: 24.04 LTS Yocto: 5.1
I/O Placements	
USB	USB 3.2 Gen 2 (Type-A) x 3
Display Port	HDMI 1.4b x 1
Ethernet	1GbE RJ-45 x 1 (Realtek RTL8111H CG)
COM	—
Audio	—
GPIO	—
Power Supply	
Power requirement	12V DC-in, 5A
Power supply type	AT/ATX (ATX as default)
Power Consumption (Typical)	30W~36W
Mechanical	
Mounting	VESA Mount (optional)
Dimensions (WxHxD)	3.62" x 2.52" x 1.78" (92mm x 64mm x 45.2mm)
Net Weight	0.68 lbs (0.31kg)
Gross Weight	1.04 lbs (0.47kg)
Environment	
Operating Temperature	-4°F ~ 140°F (-20°C ~ 60°C) with 0.7m/s air flow
Operating Humidity	10% ~ 80% relative humidity, non-condensing
Storage Temperature	-4°F ~ 158°F (-20°C ~ 70°C)
MTBF	685,218 Hours
Certification	CE/FCC Class A, RoHS Compliant, REACH





Dimension Unit: mm

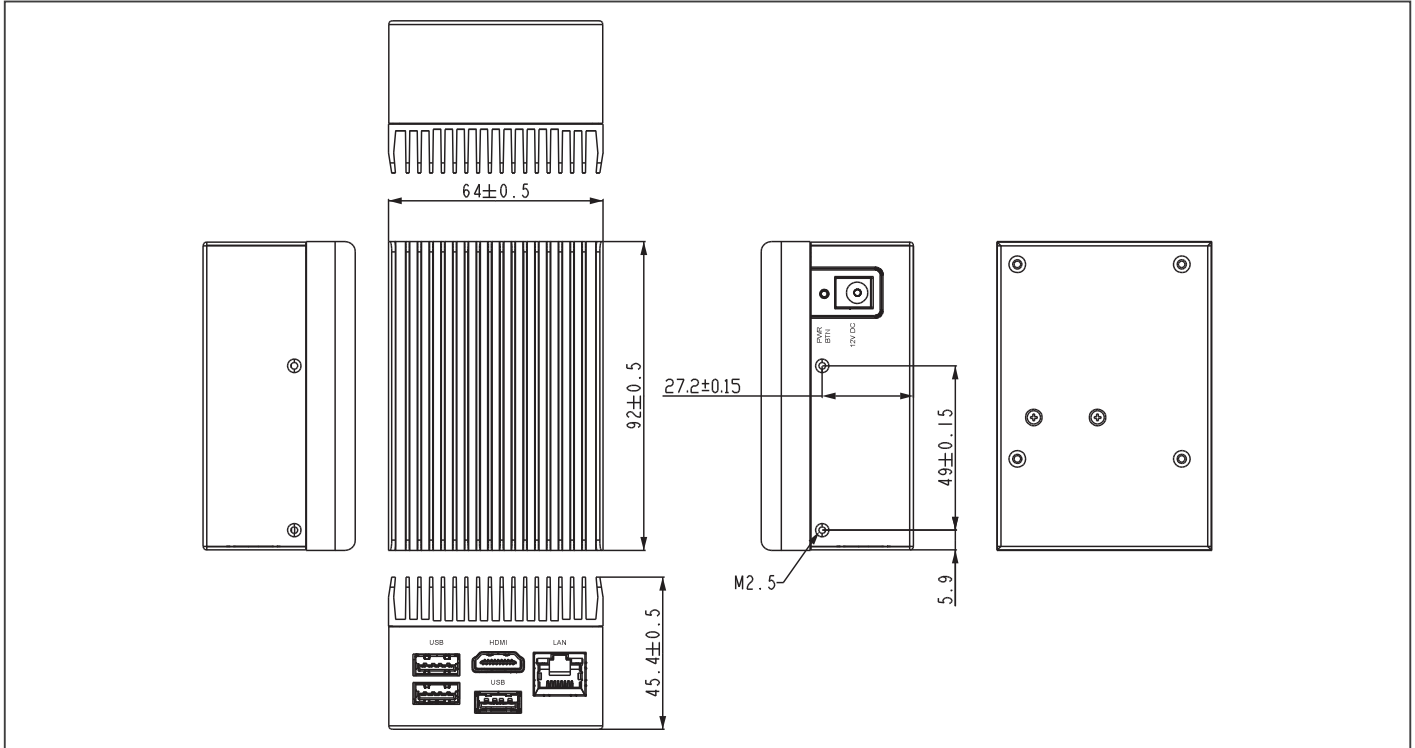

Ordering Information

Part Number	CPU	Core	Memory	Storage	Heatsink
UP-EDGE-TWLN150-A10-0864	Intel® Processor N150	4	8GB	64GB	64GB

Optional Accessories

Part Number	Description
125530060L	PowerAdapter (TF)PowerAdapter.DC.100/240V.12V.5A.60W.Powertron.PS1065-120IB500.
170010015G	(TF)USB Cable.10P 1.0mm Housing.USB A(F). 15cm
UP-EDGE-APL03-VESA-A01	UP 4000 EDGE VESA kit

Packing List

- UP TWL Edge

Front View

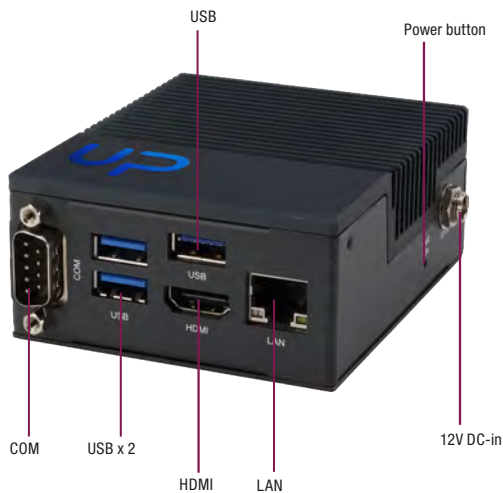

Rear View

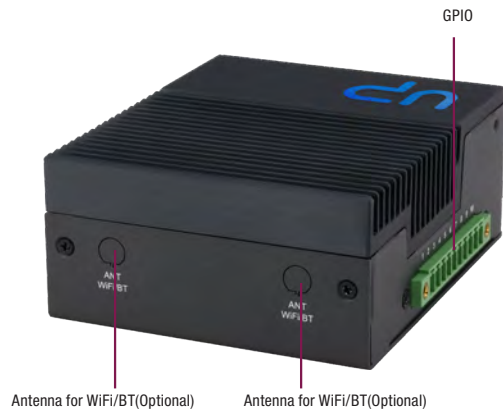

Features

- Intel® Processor N-series
- Onboard LPDDR5 Memory, up to 8GB
- Onboard eMMC Storage, up to 64GB
- 1 GbE LAN x 1
- HDMI 1.4b x 1
- USB 3.2 Gen 2 (Type-A) x 3
- 12V DC-in, 5A
- TPM 2.0
- M.2 2230 E-Key
- GPIO x 8, COM x 1



Specifications

System	
CPU	Intel® Core™ 3 Processor N355 Intel® Processor N250 Intel® Processor N150 (formerly Twin Lake)
Memory	Up to 8GB LPDDR5
Graphics	Intel® UHD Graphics for 12th Gen Intel® Processors
Storage	Up to 64GB eMMC
Ethernet	1GbE RJ-45 x 1
WiFi/BT	Optional with M.2 2230 E-key x 1
Expansion Slot	M.2 2230 E-Key x 1 (PCIe x1, USB2.0 x1)
Security	Onboard TPM 2.0
OS Support	Windows® 11 LTSC Ubuntu: 24.04 LTS Yocto: 5.1
I/O Placements	
USB	USB 3.2 Gen 2 (Type-A) x 3
Display Port	HDMI 1.4b x 1
Ethernet	1GbE RJ-45 x 1
COM	RS-232/422/485 x 1
Audio	—
GPIO	GPIO x 8 (Optional: PWM x 1, I2C x 1, SPI x 1; by project base, please contact AAEO sales)
Power Supply	
Power requirement	12V DC-in, 5A
Power supply type	AT/ATX
Power Consumption (Typical)	30W~36W
Mechanical	
Mounting	DIN Rail, VESA
Dimensions (WxHxD)	3.62" x 3.03" x 1.51" (92mm x 77mm x 38.5mm)
Net Weight	0.67 lb. (0.30Kg)
Gross Weight	0.78 lb. (0.35Kg)
Environment	
Operating Temperature	-4°F ~ 140°F (-20°C ~ 60°C) with 0.7m/s air flow
Operating Humidity	10% ~ 80% relative humidity, non-condensing
Storage Temperature	-4°F ~ 158°F (-20°C ~ 70°C)
MTBF	685,218
Certification	CE/FCC Class A, RoHS Compliant, REACH



Dimension

Unit: mm

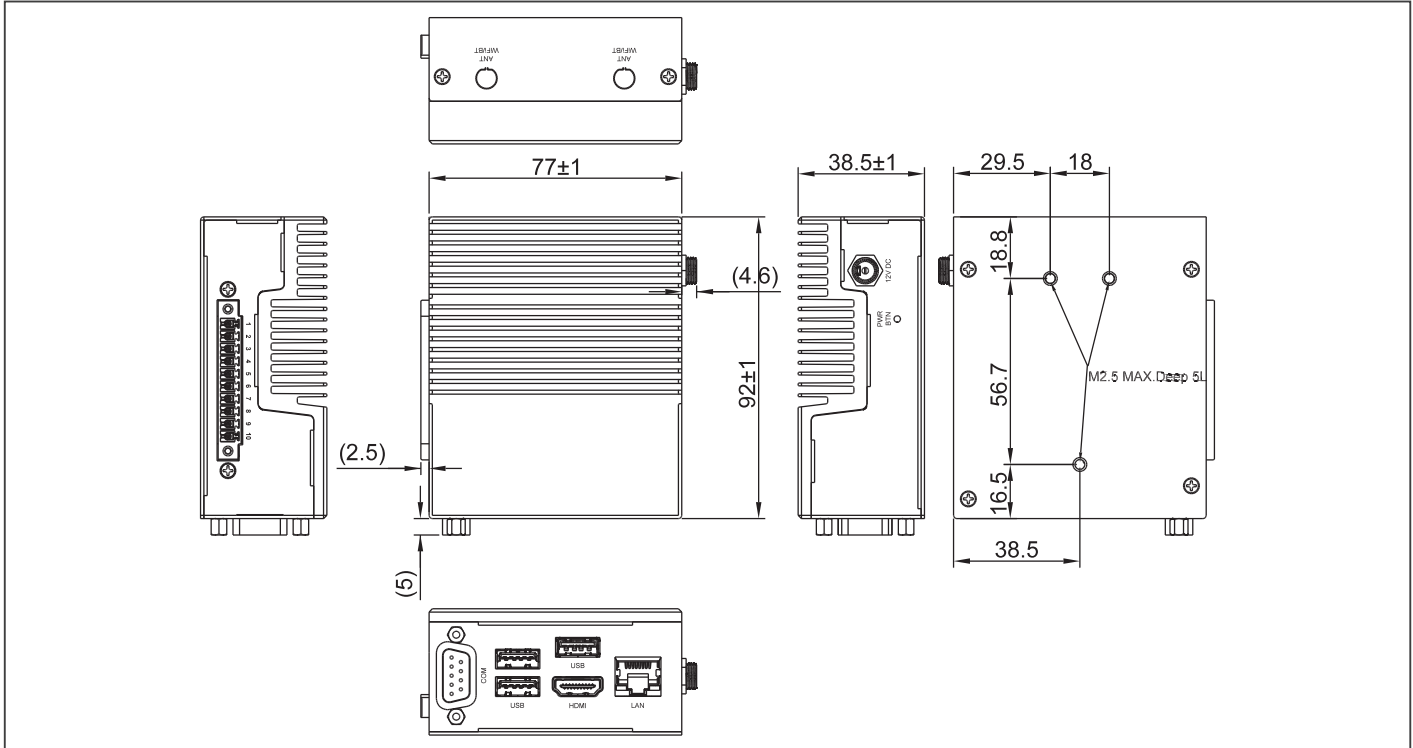

Ordering Information

Part Number	CPU	Core	Memory	Storage
UP-EDGE-TWL02N150-A10-0864	Intel® Processor N150	4	8GB	64GB

Optional Accessories

Part Number	Description
1255X00032	(TF)AC/DC Adapter.Input AC.100~240V.Output DC.12V.MAX 72W.6.0A.180D.W/ LOCK.EDAC. EA10681U(120)
170X000799	(TF)Power Cord. 3P. 125V. 10A. 180D. USA. 1. 8M. I-SHENG. SP305B/IS-14N SVT 18/3 60C CT-12 Black
170X000800	(TF)Power Cord. 3P. 250V. 10A. VDE. 1. 8M. I-SHENG. SP23/IS-14N H05VV-F 3G 0.75 CT-12 Black
170X000815	(TF)Power Cord. 3P. 250V. 10A. 180D. CHINA. 1. 8M. I-SHENG. SP506A/IS-14N RVV 300/500V 3X0.75 CT-12 Black
170X000806	(TF)Power Cord. 3P. 125V. 7A. 1. 8M. I-SHENG. U4NCB3T6B1218002. SP305B/IS-14N VCTF. Black. BSMI
170X000803	(TF)Power Cord.3P.125V/7A.PSE Certificate.1.8M.I-SHENG.U4NCB3P6C1218002.SP305B/IS-14N VCTF 0.75/3 Black 1.8M
170X000810	(TF)Power Cord.3P.250V.16A.Korea.1.8M.I-SHENG.SP23/IS-14N H05VV-F 3G 0.75 CT-12 Black
170X000805	(TF)Power Cord.3P.250V.10A.SWISS.1.8M.I-SHENG.SP-027C/IS-14N H05VV-F 3G 0.75mm CT-12 Black
9651210000	Wireless LAN Kit M.2 2230 802.11ax/ac/a/b/g/n + BT5.2,2.4G/5G/6G,with 2 sets of cable & antenna (Intel AX210)
9651885200	Wireless LAN Kit M.2 2230 802.11ax/ac/a/b/g/n + BT5.2,2T2R,with 2 sets of cable & antenna (Eni.ENL-8852CE)
170010015G	(TF)USB Cable.10P 1.0mm Housing.USB A(F). 15cm
UP-ASL02VESAKIT-A10-0001	VESA KIT for UP-EDGE-ASL02
UP-DRKIT-A10-0001	DIN Rail KIT for UP Series

Packing List

- UP TWLS Edge

Front View

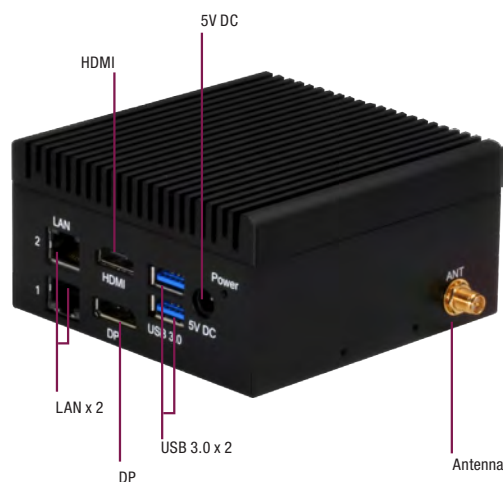

Rear View



Features

- Intel® Pentium® N4200/ Celeron® N3350 Processor SoC/Atom® E3950
- Onboard LPDDR4 Memory, eMMC Storage
- Gigabit LAN x 2
- HDMI x 1, DP x 1
- USB 3.0 x 3, USB 3.0 OTG x 1
- 3G/ WiFi/ BT(Optional)



Specifications

System	
CPU	Intel® Celeron® Processor N3350 Intel® Pentium® Processor N4200 Intel Atom® x7-E3950
Memory	Up to 8GB onboard LPDDR4
Graphics	Intel® HD Graphics
Storage	Up to 128GB onboard eMMC
Ethernet	GbE x 2 (Realtek 8111H CG)
WiFi/BT	Optional with M.2 2230 E-key x 1
Expansion Slot	40-pin GPIO x 1 Full-sized mPCIe x 1 (PCIe & SATA [x1] , USB2.0 [x1]) M.2 2230 E-Key x 1 (PCIe [x1], USB2.0 [x1]) SATA III x 1
Security	fTPM
OS Support	Windows® 10 IoT Enterprise LTSC 2021 Windows IoT Core Linux Ubuntu 20.04 LTS Linux Yocto 3.1
I/O Placements	
USB	USB 2.0 x 2 (via 10 Pin Header x 1) USB 3.2 Gen 1 x 3 (Type-A) USB 3.2 Gen 1 OTG x 1 (Micro B)
Display Port	HDMI 1.4b x 1 DP 1.2 x 1
Ethernet	Realtek® 8111G x 2
COM	—
Audio	—
GPIO	—
Power Supply	
Power requirement	5V DC-in
Power supply type	AT/ATX (AT as default)
Power Consumption (Typical)	15.05W
Mechanical	
Mounting	VESA Mounting
Dimensions (WxHxD)	3.74" x 3.58" x 1.46" (95mm x 91mm x 37mm)
Net Weight	0.99lb (450g)
Gross Weight	1.32lb (600g)
Environment	
Operating Temperature	32°F ~ 113°F (0°C ~ 45°C)
Operating Humidity	0% ~ 90% relative humidity non-condensing
Storage Temperature	-4°F ~ 158°F (-20°C ~ 70°C)
MTBF	179,902 Hours
Certification	CE, FCC Class A, UL





Dimension

Unit: mm

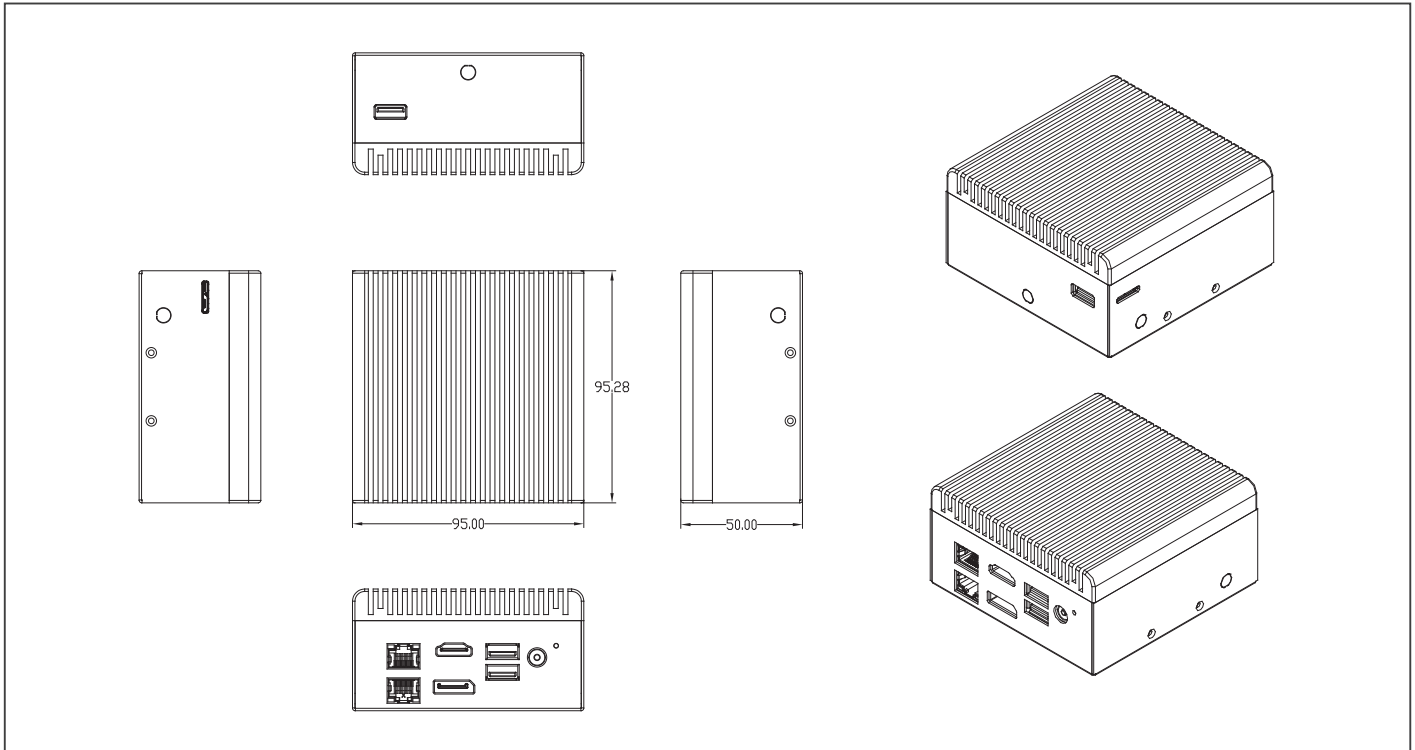

Ordering Information

Part Number	CPU	CORE	MEMORY	STORAGE	HEATSINK
UPS-GWS01C2F-A20-0232	Intel® Celeron® Processor N3350	2 Core	2GB	32GB	FANLESS
UPS-GWS01C2F-A20-0432	Intel® Celeron® Processor N3350	2 Core	4GB	32GB	FANLESS
UPS-GWS01C2F-A20-1232	Intel® Celeron® Processor N3350	2 Core	2GB	32GB	FANLESS
UPS-GWS01C2F-A20-1432	Intel® Celeron® Processor N3350	2 Core	4GB	32GB	FANLESS
UPS-GWS01P4F-A20-0432	Intel® Pentium® Processor N4200	4 Core	4GB	32GB	FANLESS
UPS-GWS01P4F-A20-0864	Intel® Pentium® Processor N4200	4 Core	8GB	64GB	FANLESS
UPS-GWS01P4F-A20-1432	Intel® Pentium® Processor N4200	4 Core	4GB	32GB	FANLESS
UPS-GWS01P4F-A20-1864	Intel® Pentium® Processor N4200	4 Core	8GB	64GB	FANLESS
UPS-GWS01X7F-0464-AI	Intel Atom® x7-E3950	4 Core	4GB	64GB	FANLESS
UPS-GWS01X7F-A20-0864	Intel Atom® x7-E3950	4 Core	8GB	64GB	FANLESS

Optional Accessories

Part Number	Description
1255300362	(TF)AC/DC Adapter.5VDC.30W.6A.SUNWARD.AD36AM050600
1702020911	(TF)POWER CORD.SP12N 2P.C8 2P.91cm.NISP-2 for US
9651926001	(TF).M.2 2230 WiFi Kit.802.11ac.2.4G/5G,W/BT Intel.9260.NG.WG.NV.958867 w/2 cable & antenna
9741364A00	(TF).M.2 2230 Wireless.802.11 ac/a/b/g/n + BT 5.0.2T2R,Enli OCNFA364A.w/2 sets of cable and antenna

Packing List

- UPS-GWS01

UP Squared V2 Edge

UP Squared V2 System with Intel® Pentium® Celeron® Processor SoC



Front View



Rear View



Features

- Intel® Pentium® Celeron® Processor SoC
- Onboard LPDDR4 Memory up to 16GB
- Onboard eMMC Storage up to 64GB
- Gb Ethernet (full speed) RJ-45 x 2
- USB 3.2 Type A x 3
- DP 1.2 / HDMI 1.4b
- COM x 1
- Audio Jack (Line out x 1 + Mic in x 1)
- M.2 2230 E-Key x 1
- M.2 2280 M-Key x 1
- SATA3 x 1
- TPM 2.0
- 12V DC-in, 5A



Specifications

System	
CPU	Intel® Celeron® N6210 Processor SoC Intel® Celeron® J6412 Processor SoC Intel® Pentium® J6426 Processor SoC
Memory	Up to 16GB LPDDR4
Graphics	Intel® UHD Graphics
Storage	Up to 64GB eMMC
Ethernet	Gb Ethernet (full speed) RJ-45 x 2
WiFi/BT	Optional with M.2 2230 E-key x 1
Expansion Slot	M.2 2230 E-Key x 1 (PCIe Gen 3.0 [x2], USB 2.0 [x1]) M.2 2280 M-key x 1 (PCIe Gen 3.0 [x2]) SATA 6Gb/s x 1
Security	Onboard TPM 2.0
OS Support	Microsoft Windows 10 (full) Windows IOT Core Ubuntu 20.04 LTS Yocto 3.1
I/O Placements	
USB	USB 2.0 x 2 (via 10 Pin Header x 1) USB 3.2 Gen 2 x 3 (Type-A)
Display Port	HDMI 1.4b x 1 DP 1.2 x 1
Ethernet	Gb Ethernet (full speed) RJ-45 x 2
COM	RS-232/422 x 1
Audio	Line out x 1 Mic in x 1
GPIO	—
Power Supply	
Power requirement	12V DC-in, 5A
Power supply type	AT/ATX (AT as default)
Power Consumption (Typical)	30~38W
Mechanical	
Mounting	VESA Mounting
Dimensions (WxHxD)	3.74" x 3.74" x 2.16" (95 x 95 x 55 mm)
Net Weight	0.99lb (450g)
Gross Weight	1.32lb (600g)
Environment	
Operating Temperature	32°F ~ 140°F (0°C ~ 60°) / 0.5 airflow
Operating Humidity	0% ~ 90% relative humidity, non-condensing
Storage Temperature	-4°F ~ 158°F (-20°C ~ 70°C)
MTBF	465,586
Certification	CE/FCC Class A, RoHS Compliant, REACH



UP Squared i12 Edge

UP Squared i12 system with 12th/13th generation Intel® Core™ i7/i5/i3/Celeron® Processor SoC

Front View

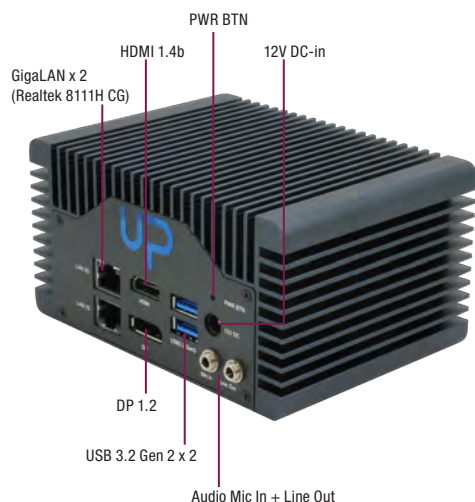

Rear View

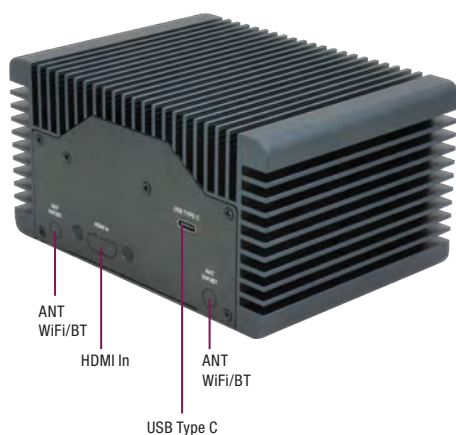

Features

- 12th/13th Generation Intel® Core™ i7/i5/i3/Celeron® Processor SoC
- Up to 16GB Onboard LPDDR5
- Up to 128GB SSD
- M.2 2230 E-Key/M.2 2280 M-Key/SATA 6Gb/s x 1
- 1GbE x 2
- HDMI 1.4b x 1, DP 1.2 x 1, DP 1.4a via USB Type-C x 1
- USB 3.2 x 3 (Type A x 2, Type C x 1)
- Audio Jack x 1 (Line out + Mic in)
- 12V DC-in
- TPM 2.0



Specifications

System	
CPU	12th Gen Intel® Core™ Processor SoC Intel® Core™ i7-1270PE Intel® Core™ i7-1260P Intel® Core™ i5-1250PE Intel® Core™ i5-1240P Intel® Core™ i3-1220PE Intel® Celeron® Processor 7305E 13th Gen Intel® Core™ Processor SoC Intel® Core™ i7-1370PE Intel® Core™ i7-1360P Intel® Core™ i5-1340PE Intel® Core™ i3-1320PE
Memory	Up to 16GB Onboard LPDDR5 (Single-Channel)
Graphics	Intel® UHD Graphics
Storage	M.2 2280 M-Key NVMe x 1 (PCIe Gen 4.0 [x4]) SATA 6Gb/s x 1
Ethernet	1GbE RJ-45 x 2 (Realtek RTL8111H-CG)
WiFi/BT	Optional: M.2 2230 E-Key
Expansion Slot	M.2 2230 E-Key x 1 (CNVI & PCIe Gen 3.0 [x1]) M.2 2280 M-Key NVMe x 1 (PCIe Gen 4.0 [x4]) SATA 6Gb/s x 1
Security	Onboard TPM 2.0
OS Support	Windows® 10 IoT Enterprise Ubuntu 22.04 LTS Yocto 4
I/O Placements	
USB	USB 3.2 Gen 2 (Type A) x 2 USB 3.2 Gen2 (Type C) x 1
Display Port	HDMI 1.4b/DP 1.2 STACK Connector x 1 DP 1.4a x 1 (via USB Type-C)
Ethernet	1GbE RJ45 x 2 (Dual Stacked) (Realtek 8111H CG)
COM	—
Audio	Audio Jack (Line out + MIC in) x 1
GPIO	—
Power Supply	
Power requirement	12V DC-in
Power supply type	AT (default) /ATX
Power Consumption (Typical)	Intel® Core™ i7-1270PE, LPDDR5 4800MHz 16GB, 5.86A@+ 12V (Typical) Intel® Core™ i7-1270PE, LPDDR5 4800MHz 16GB, 8.05A@+ 12V (Max)
Mechanical	
Mounting	VESA Mount/Wallmount(Optional)
Dimensions (WxHxD)	5.12" x 3.7" x 2.68" (130mm x 94mm x 68mm)
Net Weight	1.87 lbs (0.85kg)
Gross Weight	2.36 lbs (1.07kg)
Environment	
Operating Temperature	32°F ~ 140°F (0°C ~ 60°C) / 0.5 airflow
Operating Humidity	0% ~ 90% relative humidity, non-condensing
Storage Temperature	-4°F ~ 158°F (-20°C ~ 70°C)
MTBF	522,716
Certification	CE/FCC Class A, RoHS Compliant, REACH





Dimension

Unit: mm

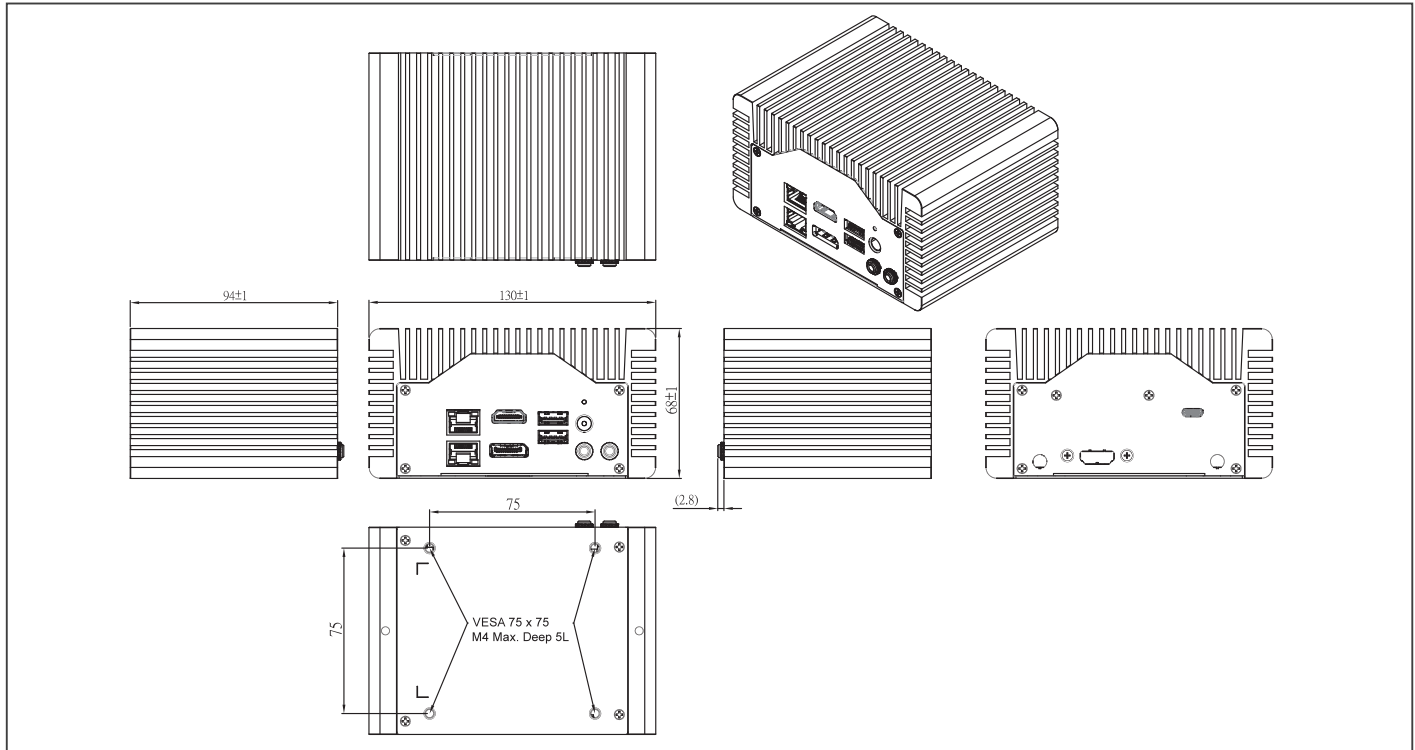

Ordering Information

PART NUMBER	CPU	CORE	MEMORY	STORAGE	HEATSINK
UPS-EDGE-ADLPCR-A10-0864	Intel® Celeron® Processor 7305E	1P+4E	8GB	64GB	FANLESS
UPS-EDGE-ADLP13-A10-08128	Intel® Core™ i3-1220PE	4P+4E	8GB	128GB	FANLESS
UPS-EDGE-ADLP15-A10-08128	Intel® Core™ i5-1250PE	4P+8E	8GB	128GB	FANLESS
UPS-EDGE-ADLP15C-A10-16128	Intel® Core™ i5-1240P	4P+8E	16GB	128GB	FANLESS
UPS-EDGE-ADLP17-A10-16128	Intel® Core™ i7-1270PE	4P+8E	16GB	128GB	FANLESS
UPS-EDGE-ADLP17C-A10-16128	Intel® Core™ i7-1260P	4P+8E	16GB	128GB	FANLESS
UPS-EDGE-RAP13-A10-08128	Intel® Core™ i3-1320PE	4P+4E	8GB	128GB	FANLESS
UPS-EDGE-RAP15-A10-08128	Intel® Core™ i5-1340PE	4P+8E	8GB	128GB	FANLESS
UPS-EDGE-RAP17-A10-16128	Intel® Core™ i7-1370PE	4P+8E	16GB	128GB	FANLESS
UPS-EDGE-RAP17C-A10-16128	Intel® Core™ i7-1360P	4P+8E	16GB	128GB	FANLESS

Optional Accessories

Part Number	Description
1255X00088	(TF)AC/DC Adapter.100-240VAC.120W.12VDC/10A.W/O Lock.DC plug 2.1*5.5*12mm.FSP.FSP120-AHAN3/9NA1206756
170X000800	Power cord for EU.(TF)POWER CORD.3P-250V 10A 180D.1.8M.VDE.FAN-JET.YP-22/YC-12
170X000799	Power cord for US.(TF)POWER CORD.3P-125V 10A 180D.1.8M.USA.FANJET.YP12/YC-12
170203180J	Power cord for UK.(TF)Power Cord.3P.250V 10A.UK type.1830mm
170X000803	Power cord for Japan.(TF)Power cord.3P.125V/7A.1.8M.PSE YP12/YC12 Certificat
170X000815	Power cord for China.(TF)POWER CORD.3P(M).3P(F).1.8m.250V 10A 180D.CHINA.FAN-JET.YP-03/YC-12
170X000806	Power cord for Taiwan.(TF)Power Cord.3P-125VP.7A.180D.1.8M.TWN/BSMI.FANJET.YP-12/YC-12
1709070500	SATA cable.(TF)SATA CABLE.7P Pitch 1.27mm.50cm
1702150155	SATA power cable(15cm).(TF)Power Cable.15P SATA(F).2P 2.0mm Housing(PH).15cm
1702150306	SATA power cable(30cm).(TF)Power Cable.15P SATA(F).2P 2.0mm Housing(PH).30cm
170010015G	UART to USB cable.(TF)USB Cable.10P 1.0mm Housing.USB A(F)
9741364A00	(TF).M.2 2230 Wireless.802.11 ac/a/b/g/n + BT 5.0.2T2R,Enli QCNFA364A.w/2 sets of cable and antenna
9651926001	Wireless BT Kit (TF).M.2 2230 WiFi Kit.802.11ac.2.4G/5G.W/BT Intel.9260.NGW6.NV.958867w/2 cable & antenna

Packing List

- UP Squared i12 Edge

UP Squared 7100 Edge

UP Squared 7100 edge system with Intel® Processor N-series SoC

Front View

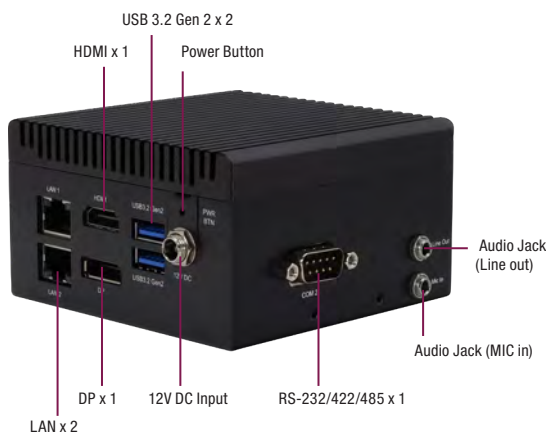

Rear View



Features

- Intel® Processor N-series SoC
- Onboard LPDDR5 Memory up to 16GB
- Onboard eMMC Storage up to 128GB
- Gb Ethernet (full speed) RJ-45 x 2
- USB 3.2 Type A x 3
- DP 1.2 / HDMI 2.0b / eDP 1.3
- RS232/422/485 x 2
- M.2 2230 E-Key x 1
- M.2 2280 M-Key x 1
- TPM 2.0
- 12V DC-in



Specifications

System	
CPU	Intel® Processor N97 Intel® Processor N100
Memory	Up to 16GB LPDDR5
Graphics	Intel® UHD Graphics for 12th Gen Intel® Processors
Storage	Up to 128GB eMMC
Ethernet	Gb Ethernet (full speed) RJ-45 x 2
WiFi/BT	Optional with M.2 2230 E-key x 1
Expansion Slot	M.2 2230 E-Key x 1 (PCIe x1, USB2.0 x1) M.2 2280 M-key x 1 (PCIe x2)
Security	Onboard TPM 2.0
OS Support	Microsoft Windows 10/11 Ubuntu 22.04 LTS Yocto 5.1
I/O Placements	
USB	USB 2.0 x 2 (via 10 Pin Header x 1) USB 3.2 Gen 2 x 3 (Type-A)
Display Port	HDMI 2.0b x 1 DP 1.2 x 1
Ethernet	Gb Ethernet (full speed) RJ-45 x 2
COM	RS-232/422/485 x 2
Audio	Line out x 1 Mic in x 1
GPIO	—
Power Supply	
Power requirement	12V DC-in, 5A
Power supply type	AT/ATX
Power Consumption (Typical)	15W~37W
Mechanical	
Mounting	VESA Mounting
Dimensions (WxHxD)	3.74" x 3.74" x 2.16" (95 x 95 x 55 mm)
Net Weight	0.99lb (450g)
Gross Weight	1.32lb (600g)
Environment	
Operating Temperature	32°F ~ 140°F (0°C ~ 60°C) / 0.5 airflow
Operating Humidity	0% ~ 90% relative humidity, non-condensing
Storage Temperature	-4°F ~ 158°F (-20°C ~ 70°C)
MTBF	1,224,238
Certification	CE/FCC Class A, RoHS Compliant, REACH





UP Squared 7100 Edge

Dimension

Unit: mm

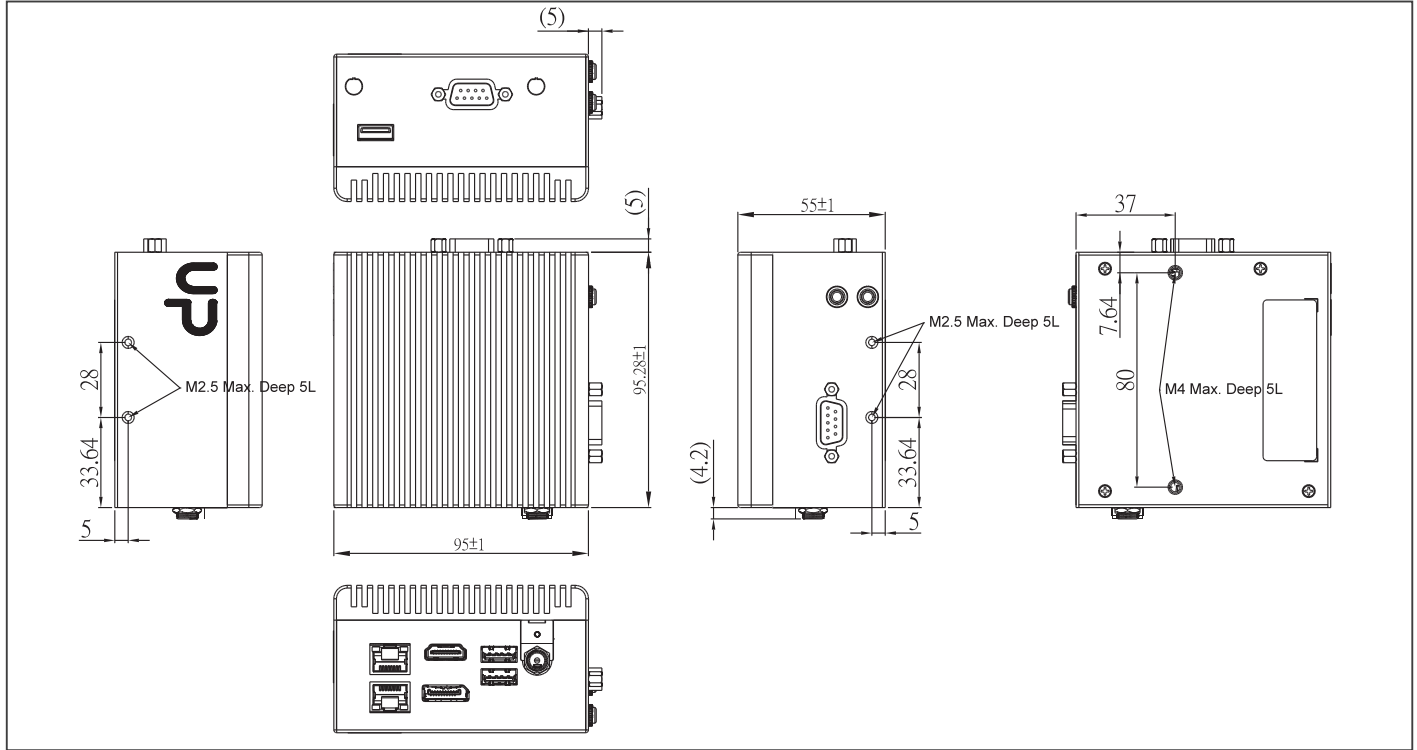

Ordering Information

Part number	CPU	Memory	Storage
UPS-EDGE-ASLN100-A10-0432	Intel® Processor N100	4GB	32GB
UPS-EDGE-ASLN100-A10-0864	Intel® Processor N100	8GB	64GB
UPS-EDGE-ASLN97-A10-0432	Intel® Processor N97	4GB	32GB
UPS-EDGE-ASLN97-A10-0864	Intel® Processor N97	8GB	64GB
UPS-EDGE-ASLN97-A10-16128	Intel® Processor N97	16GB	128GB

Optional Accessories

Part Number	Description
1255X00032	(TF)AC/DC Adapter.Input AC.100~240V.Output DC.12V.MAX 72W.6.0A.180D.W/ LOCK.EDAC. EA10681U(120)
170X000799	(TF)Power Cord. 3P. 125V. 10A. 180D. USA. 1. 8M. I-SHENG. SP305B/IS-14N SVT 18/3 60C CT-12 Black
170X000800	(TF)Power Cord. 3P. 250V. 10A. VDE. 1. 8M. I-SHENG. SP23/IS-14N H05VV-F 3G 0.75 CT-12 Black
170X000815	(TF)Power Cord. 3P. 250V. 10A. 180D. CHINA. 1. 8M. I-SHENG. SP506A/IS-14N RVV 300/500V 3X0.75 CT-12 Black
170X000806	(TF)Power Cord. 3P. 125V. 7A. 1. 8M. I-SHENG. U4NCB3T6B1218002. SP305B/IS-14N VCTF. Black. BSMI
170X000803	(TF)Power Cord. 3P.125V/7A.PSE Certificate.1.8M.I-SHENG.U4NCB3P6C1218002.SP305B/IS-14N VCTF 0.75/3 Black 1.8M
170X000810	(TF)Power Cord. 3P.250V.16A.Korea.1.8M.I-SHENG.SP23/IS-14N H05VV-F 3G 0.75 CT-12 Black
170X000805	(TF)Power Cord. 3P.250V.10A.SWISS.1.8M.I-SHENG.SP-027C/IS-14N H05VV-F 3G 0.75mm CT-12 Black
9651210000	Wireless LAN Kit M.2 2230 802.11ax/ac/a/b/g/n + BT5.2,2.4G/5G/6G,with 2 sets of cable & antenna (Intel AX210)
9651885200	Wireless LAN Kit M.2 2230 802.11ax/ac/a/b/g/n + BT5.2,2T2R,with 2 sets of cable & antenna (Enli,ENL-8852CE)

Packing List

- UP Squared 7100 Edge

UP Squared TWL Edge

UP Squared TWL system with Intel® Processor N-series SoC (formerly Twin Lake)

Front View

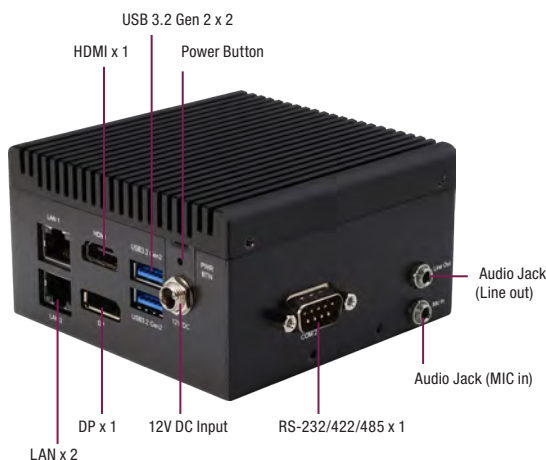

Rear View



Features

- Intel® Processor N-series SoC (formerly Twin Lake)
- Onboard LPDDR5 Memory up to 16GB
- Onboard eMMC Storage up to 128GB
- Gb Ethernet (full speed) RJ-45 x 2
- USB 3.2 Type A x 3
- DP 1.2 / HDMI 2.0b / eDP 1.3 x 1
- RS232/422/485 x 2
- M.2 2230 E-Key x 1
- M.2 2280 M-Key x 1
- TPM 2.0
- 12V DC-in



Specifications

System	
CPU	Intel® Core™ 3 Processor N355 Intel® Processor N250 Intel® Processor N150 (formerly Twin Lake)
Memory	Up to 16GB LPDDR5
Graphics	Intel® UHD Graphics for 12th Gen Intel® Processors
Storage	Up to 128GB eMMC
Ethernet	Gb Ethernet (full speed) RJ-45 x 2
WiFi/BT	Optional with M.2 2230 E-key x 1
Expansion Slot	M.2 2230 E-Key x 1 (PCIe x1, USB2.0 x1) M.2 2280 M-key x 1 (PCIe x2)
Security	Onboard TPM 2.0
OS Support	Windows® 11 LTSC Ubuntu: 24.04 LTS Yocto: 5.1
I/O Placements	
USB	USB 2.0 x 2 (via 10 Pin Header x 1) USB 3.2 Gen 2 x 3 (Type-A)
Display Port	HDMI 2.0b x 1 DP 1.2 x 1
Ethernet	Gb Ethernet (full speed) RJ-45 x 2
COM	RS-232/422/485 x 2
Audio	Line out x 1 Mic in x 1
GPIO	—
Power Supply	
Power requirement	12V DC-in, 5A
Power supply type	AT/ATX
Power Consumption (Typical)	15W~37W
Mechanical	
Mounting	VESA Mounting
Dimensions (WxHxD)	3.74" x 3.74" x 2.16" (95 x 95 x 55 mm)
Net Weight	0.99lb (450g)
Gross Weight	1.32lb (600g)
Environment	
Operating Temperature	-4°F ~ 140°F (-20°C ~ 60°) / 0.7 airflow
Operating Humidity	0% ~ 90% relative humidity, non-condensing
Storage Temperature	-4°F ~ 158°F (-20°C ~ 70°C)
MTBF	1,224,238
Certification	CE/FCC Class A, RoHS Compliant, REACH





Dimension

Unit: mm

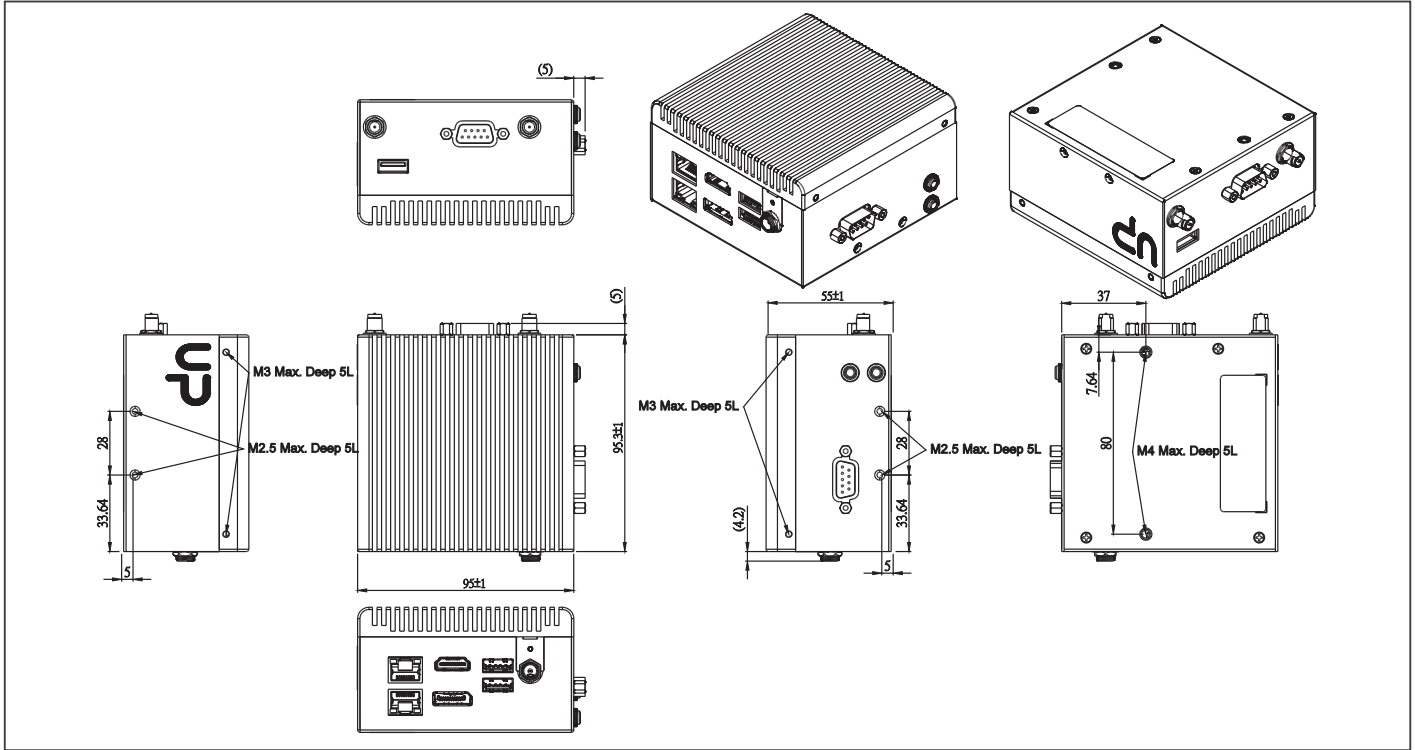

Ordering Information

Part number	CPU	Memory	Storage
UPS-EDGE-TWLN150-A10-0864	Intel® Processor N150	8GB	64GB

Optional Accessories

Part Number	Description
1255X00032	(TF)AC/DC Adapter.Input AC.100~240V.Output DC.12V.MAX 72W.6.0A.180D.W/ LOCK.EDAC. EA10681U(120)
170X000799	(TF)Power Cord. 3P. 125V. 10A. 180D. USA. 1. 8M. I-SHENG. SP305B/IS-14N SVT 18/3 60C CT-12 Black
170X000800	(TF)Power Cord. 3P. 250V. 10A. VDE. 1. 8M. I-SHENG. SP23/IS-14N H05VV-F 3G 0.75 CT-12 Black
170X000815	(TF)Power Cord. 3P. 250V. 10A. 180D. CHINA. 1. 8M. I-SHENG. SP506A/IS-14N RVV 300/500V 3X0.75 CT-12 Black
170X000806	(TF)Power Cord. 3P. 125V. 7A. 1. 8M. I-SHENG. U4NCB3T6B1218002. SP305B/IS-14N VCTF. Black. BSM)
170X000803	(TF)Power Cord.3P.125V/7A.PSE Certificate.1.8M.I-SHENG.U4NCB3P6C1218002.SP305B/IS-14N VCTF 0.75/3 Black 1.8M
170X000810	(TF)Power Cord.3P.250V.16A.Korea.1.8M.I-SHENG.SP23/IS-14N H05VV-F 3G 0.75 CT-12 Black
170X000805	(TF)Power Cord.3P.250V.10A.SWISS.1.8M.I-SHENG.SP-027C/IS-14N H05VV-F 3G 0.75mm CT-12 Black
9651210000	Wireless LAN Kit M.2 2230 802.11ax/ac/a/b/g/n + BT5.2,2.4G/5G/6G,with 2 sets of cable & antenna (Intel AX210)
9651885200	Wireless LAN Kit M.2 2230 802.11ax/ac/a/b/g/n + BT5.2,2T2R,with 2 sets of cable & antenna (Enli,ENL-8852CE)
UPS-VESAKIT-A10-0000	VESA KIT for UPS-GWS/UPS-EDGE-EHL/UPS-EDGE-ASL/UPS-EDGE-TWL

Packing List

- UP Squared TWL Edge

UPN-Edge Pro

UP Squared Pro EDGE System with Intel® Pentium® N4200/ Celeron® N3350/ Atom® E3950 Processor SoC

Front View



Rear View



Features

- Intel® Pentium® N4200/ Celeron® N3350/ Atom® E3950 Processor SoC
- Onboard LPDDR4 Memory up to 8GB
- Onboard eMMC Storage up to 64GB
- Gigabit LAN x 2, USB 3.2 Gen 1 (Type A) x 3
- 12-24 VDC-in, 5A
- 16pin GPIO connector for 40 pin HAT
- Audio Jack x 1 (line out + Mic)
- SATA3 x 1



Specifications

System	
CPU	Intel® Apollo Lake N4200/N3350/E3950 Processor SoC
Memory	onboard DDR4, Max 8GB Single Channel:2GB Dual Channel:4GB,8GB
Graphics	Intel® Graphic , Gen 9
Storage	Emmc 32G/64G
Ethernet	Intel i210 x2
WiFi/BT	Optional
Audio	Line out+mic in x1
USB	USB 3.2 Gen 1 OTG x 1 USB 3.2 Gen 1 (Type A) x 3
Expansion Slot	40 pin GPIO x 1 M.2 2230 E-key x 1 M.2 2280 M-key x 1 M.2 3052/3042 B-key x 1 (support with SIM) SATA3 connector x 1 (support 2.5" HDD/SSD expansion)
I/O Placements	
Power	DC-in Jack x 1, Power Button x 1
USB	USB3.2 Gen1 OTG x 1 USB3.2 Gen1 (Type A) x 3
Display Port	HDMIx1, DP x1
Ethernet	Gb Ethernet (full speed) RJ-45 x 2 (Intel i210)
COM	RS422/RS232/RS485 x 2
Environment	
Power	12-24VDC
Form Factor	4.61" x4.19" x3.5" (117mm x 106.5mm x 88.8mm)
Gross Weight	2.17 lb (982.5g)
Operating Temperature	32°F ~ 140°F (0°C ~ 55°C) with air flow 0.5m/s
Operating Humidity	0% ~ 90% relative humidity, non-condensing
Certification	CE/FCC Class A, RoHS Compliant , REACH
OS Support	Microsoft Windows 10 (full), Windows IoT Core Linux: Ubuntu 18.04.5 & Ubuntu 20.04.1 Yocto 3.1





Dimension

Unit: mm

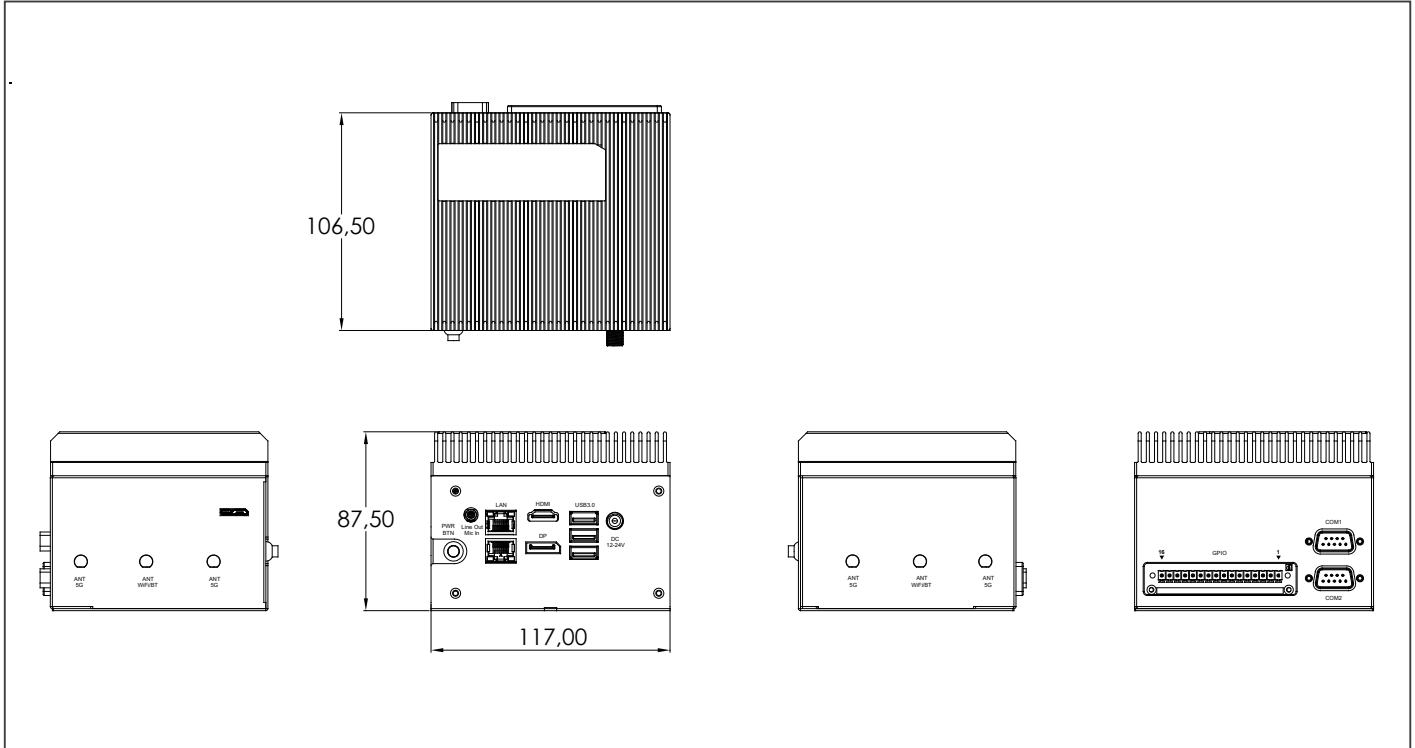

Ordering Information

Product SKU	Description
UPN-EDGE-APLC2F-A10-0232	UPN-EDGE-APL01.CPU N3350(F1).Memory 2GB.eMMC 32GB.REV.A1.0
UPN-EDGE-APLC2F-A10-0432	UPN-EDGE-APL01.CPU N3350(F1).Memory 4GB.eMMC 32GB.REV.A1.0
UPN-EDGE-APLP4F-A10-0432	UPN-EDGE-APL01.CPU N4200(F1).Memory 4GB.eMMC 32GB.REV.A1.0
UPN-EDGE-APLP4F-A10-0864	UPN-EDGE-APL01.CPU N4200(F1).Memory 8GB.eMMC 64GB.REV.A1.0
UPN-EDGE-APLX7F-A10-0464	UPN-EDGE-APL01.CPU E3950(F1).Memory 4GB.eMMC 64GB.REV.A1.0

Optional Accessories

Part Number	Description
1255X00032	12VDC/6A Adapter
170X000800	Power cord for EU
170X000799	Power cord for US
9651926001	M.2 2230 WiFi Kit.802.11ac.2.4G/5G,W/BT w/2 cable & antenna
9741364A00	Wireless LAN Kit M.2 2230 802.11ac/a/b/g/n + BT4.0,2T2R,with 2 sets of cable & antenna

Packing List

- UPN-EDGE PRO

UP Squared Pro 7000 Edge

UP Squared Pro 7000 System with Intel Atom® x7000E Series, Intel® Processor N-series, and Intel® Core™ i3-N305 Processor



Features

- Intel Atom® x7000E Series, Intel® Processor N-series, and Intel® Core™ i3-N305 Processor
- Onboard LPDDR5 Memory up to 16GB
- Onboard eMMC Storage up to 64GB
- 2.5GbE x 2 (Intel® I226-IT)
- USB 3.2 x 3 (Type A x 2, Type C x 1)
- 40 pin GPIO x 1
- DP 1.2 x 1/DP 1.4a x 1/HDMI 2.0b
- RS-232/422/485 x 2
- M.2 2230 E-Key/M.2 2280 M-Key/M.2 3052 B-Key
- SATA 6Gb/s x 1
- TPM 2.0
- 12V DC-in, 6A



Specifications

System	
CPU	Intel® Core™ i3-N305 Intel Atom® x7425E Intel® Processor N97 Intel® Processor N50
Memory	Up to 16GB onboard LPDDR5
Graphics	Intel® UHD Graphics for 12th Gen Intel® Processors VPU: Halo-8™ M.2 2280 B+M key AI module via m.2 2280 (Optional by SKU from ordering information)
Storage	Up to 64GB onboard eMMC
Ethernet	2.5GbE x 2 (Intel® I226-IT)
WiFi/BT	Optional with M.2 2230 E-key x 1
Expansion Slot	M.2 2230 E-Key x 1 (CNVI, PCIe Gen 3 [x1], USB 2.0) M.2 2280 M-Key x 1 (PCIe Gen 3 [x2], USB 2.0) M.2 3052 B-Key x 1 (USB 3.2 Gen 2) with Nano SIM slot (USB 3.0) SATA 6Gb/s x 1
Security	Onboard TPM 2.0
OS Support	Windows® 10 IoT Enterprise Ubuntu 22.04 LTS Yocto 4.0
I/O Placements	
USB	USB 3.2 Gen 2 x 2 (Type-A) USB 3.2 Gen 2 x 1 (Type-C)
Display Port	HDMI 2.0b x 1 DP 1.2 x 1 DP 1.4a via USB Type C
Ethernet	2.5GbE x 2 (Intel® I226-IT)
COM	RS-232/422/485 x 2
Audio	Audio Jack x 1 (Mic-in+Line-out)
GPIO	40 Pin GPIO x 1
Power Supply	
Power requirement	12V DC-in (Lockable plug)
Power supply type	AT/ATX (ATX as default)
Power Consumption (Typical)	26W~35W
Mechanical	
Mounting	—
Dimensions (WxHxD)	5.27" x 4.13" x 2.56" (134mm x 105mm x 65mm)
Net Weight	2 lbs (0.95kg)
Gross Weight	2.8 lbs (1.3kg)
Environment	
Operating Temperature	32°F ~ 140°F (0°C ~ 60°C) / 0.5 airflow
Operating Humidity	0% ~ 90% relative humidity, non-condensing
Storage Temperature	-4°F ~ 158°F (-20°C ~ 70°C)
MTBF	422,053 Hours





UP Squared Pro 7000 Edge

Dimension

Unit: mm

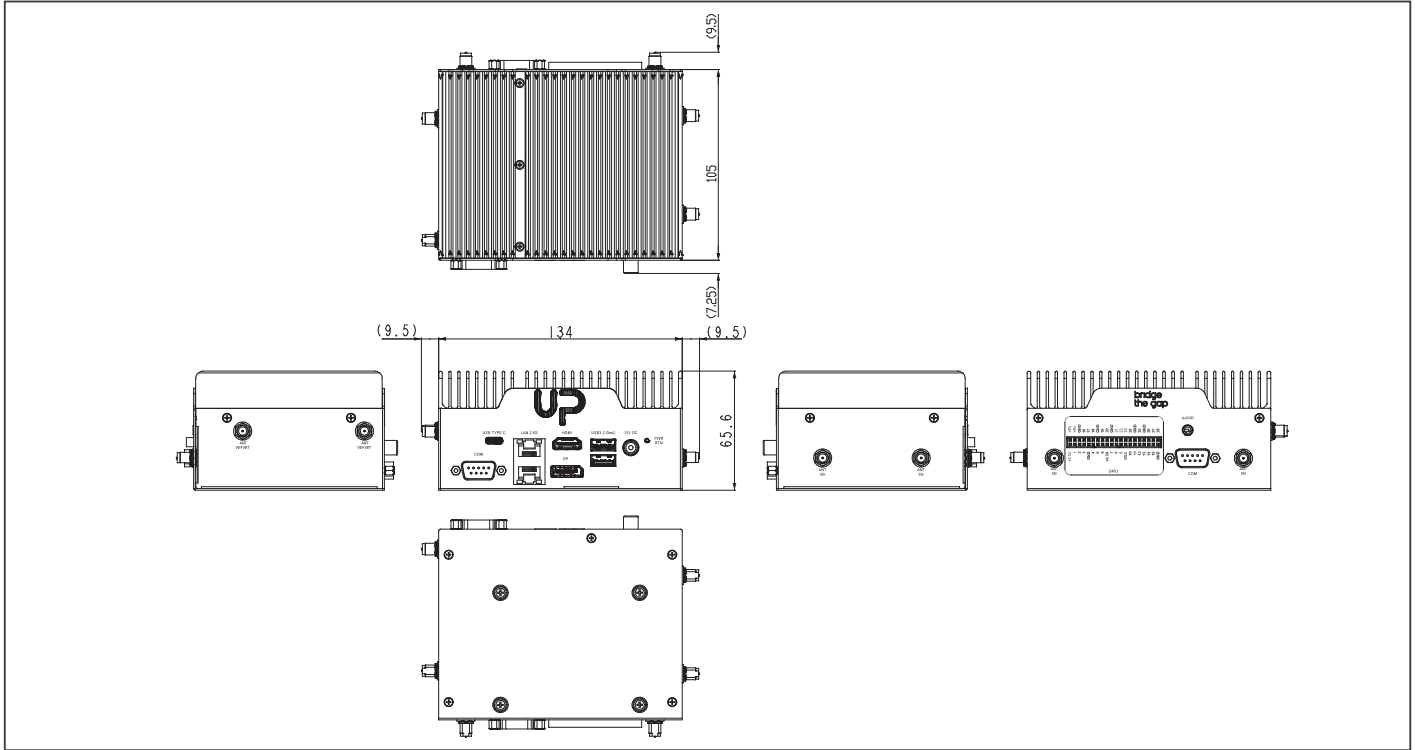

Ordering Information

Part number	CPU	CORE	MEMORY	STORAGE	HEATSINK	VPU
UPN-EDGE-ADLN50-A10-0432	Intel® Processor N50	2 Core	4GB	32GB	FANLESS	—
UPN-EDGE-ADLN97-A10-0432	Intel® Processor N97	4 Core	4GB	32GB	FANLESS	—
UPN-EDGE-ADLN97-A10-0864	Intel® Processor N97	4 Core	8GB	64GB	FANLESS	—
UPN-EDGE-ADLN13-A10-1664	Intel® Core™ i3-N305	8 Core	16GB	64GB	FANLESS	—
UPN-EDGE-ADLNX25E-A10-0864	Intel Atom® x7425E	4 Core	8GB	64GB	FANLESS	—
UPN-EDGE-ADLN97-A10-0864-HAILO	Intel® Processor N97	4 Core	8GB	64GB	FANLESS	Hailo-8™ M.2 2280 B+M key AI module via m.2 2280
UPN-EDGE-ADLNX25E-A10-0864-HAILO	Intel Atom® x7425E	4 Core	8GB	64GB	FANLESS	Hailo-8™ M.2 2280 B+M key AI module via m.2 2280

Optional Accessories

Part Number	Description
1255X00032	(TF)AC/DC Adapter.Input AC:100~240V.Output DC:12V.MAX 72W.6.0A.180D.W/ LOCK.EDAC.EA10681U(120)
170X000800	(TF)POWER CORD.3P-250V 10A 180D.1.8M.VDE.FAN-JET.YP-22/YC-12 (for EU)
170X000799	(TF)POWER CORD.3P-125V 10A 180D.1.8M.USA.FAN.JET.YP12/YC-12 (for USA)
170203180J	(TF)Power Cord.3P.250V 10A.UK type.1830mm (for UK)
170X000803	(TF)Power cord.3P.125V/7A.1.8M.PSE YP12/YC12 Certificat (for Japan)
170X000815	(TF)POWER CORD.3P(M).3P(F).1.8m.250V 10A 180D.CHINA.FAN-JET.YP-03/YC-12 (for China)
170X000806	(TF)Power Cord.3P-125VP.7A.180D.1.8M.TWN/BSML.FANJET.YP-12/YC-12 (for Japan)
9651926001	M.2 2230 WiFi Kit.802.11ac.2.4G/5G,W/BT w/2 cable & antenna
9741364A00	Wireless LAN Kit M.2 2230 802.11ac/a/b/g/n + BT4.0,2T2R,with 2 sets of cable & antenna
UP-SATAKIT-A10-0001	SATA KIT for UPN-EDGE-APL01/UPN-EDGE-EHL01/UPN-EDGE-ADLN01

Packing List

- UP Squared Pro 7000 Edge

UP Squared Pro 710H Edge

UP Squared Pro 710H Edge System with Intel Atom® x7000 RE Series, Intel® Processor N Series, and Intel® Core™ i3-N305 Processors



Front View



Rear View



Features

- Intel Atom® x7000 RE Series, Intel® Processor N Series, and Intel® Core™ i3-N305 Processors
- Onboard Hailo-8™ edge AI processor
- Onboard LPDDR5 Memory, up to 16GB
- Onboard eMMC Storage, up to 128GB
- 2.5GbE x 2 (Intel® I226-IT)
- USB 3.2 (Type-A) x 2
- 40-pin GPIO x 1
- DP 1.2 x 1/HDMI 2.0b x 1
- RS-232/422/485 x 2
- M.2 2230 E-Key/M.2 2280 M-Key (Optional: M.2 3052 B-Key x 1)
- Onboard TPM 2.0
- 12V~36V DC-in with Phoenix Connector



Specifications

System	
CPU	Intel® Core™ i3-N305 (8C, 1.80 GHz, 15W) Intel® Processor N97 (4C, 2.00 GHz, 12W) Onboard Hailo-8™ edge AI processor
Memory	Up to 16GB onboard LPDDR5
Graphics	Intel® UHD Graphics for 12th Gen Intel® Processors
Storage	Up to 128GB onboard eMMC
Ethernet	2.5GbE x 2 (Intel® I226-IT)
WiFi/BT	Optional with M.2 2230 E-key x 1
Expansion Slot	M.2 2230 E-Key x 1 (CNVI, PCIe Gen 3 [x1], USB 2.0) M.2 2280 M-Key x 1 (PCIe Gen 3 [x2]), Optional: M.2 3052 B-Key with Nano SIM slot (USB 3.0)
Security	Onboard TPM 2.0
OS Support	Windows® 10 IoT Enterprise Ubuntu 22.04 LTS
I/O Placements	
USB	USB 3.2 Gen 2 x 2 (Type-A)
Display Port	HDMI 2.0b x 1 DP 1.2 x 1
Ethernet	2.5GbE x 2 (Intel® I226-IT)
COM	RS-232/422/485 x 2
Audio	—
GPIO	40-pin GPIO x 1
Power Supply	
Power requirement	12V-36V DC-in Phoenix connector (Optional: Lockable plug)
Power supply type	AT/ATX (AT as default)
Power Consumption(Typical)	50W~55W
Mechanical	
Mounting	VESA Mount/Wallmount/DIN RAIL (Optional)
Dimensions (WxHxD)	5.28" x 4.13" x 2.36" (134mm x 105mm x 60mm)
Net Weight	1.8 lbs (0.69kg)
Gross Weight	2.2 lbs (0.97kg)
Environment	
Operating Temperature	32°F ~ 140°F (0°C ~ 60°C) / 0.5 airflow
Operating Humidity	0% ~ 90% relative humidity, non-condensing
Storage Temperature	-4°F ~ 158°F (-20°C ~ 70°C)
MTBF	422,053 Hours
Certification	CE/FCC Class A, RoHS Compliant, REACH





UP Squared PRO 710H Edge

Dimension

Unit: mm

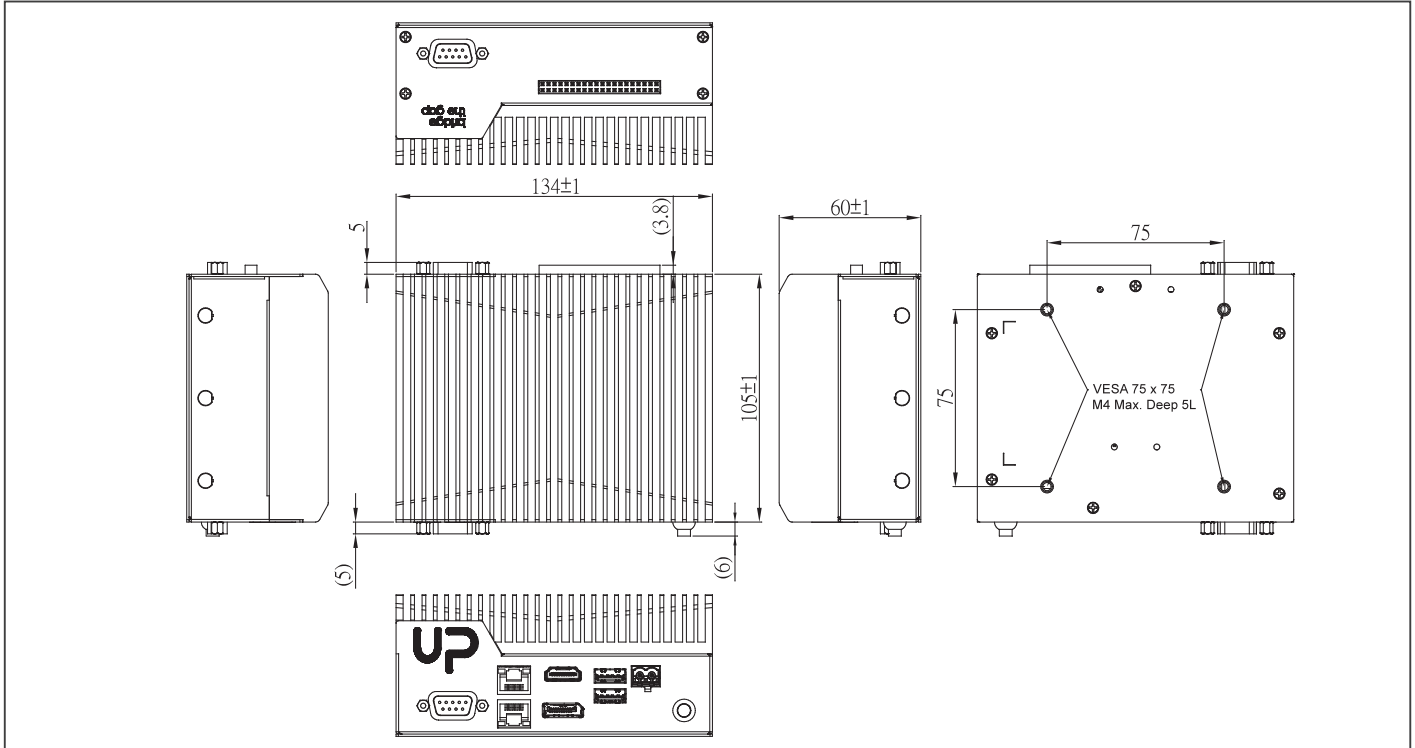

Ordering Information

PART NUMBER	CPU	CORE	MEMORY	STORAGE	HEATSINK	VPU	OPERATING TEMPERATURE
UPN-EDGE-ASLHN97-A10-0864	Intel® Processor N97	4 Core	8GB	64GB	Fanless	Onboard Hailo-8™ edge AI processor	32°F ~ 140°F (0°C ~ 60°C) / 0.5 airflow
UPN-EDGE-ASLHI3-A10-16128	Intel® Core™ i3-N305	8 Core	16GB	128GB	Fanless	Onboard Hailo-8™ edge AI processor	32°F ~ 140°F (0°C ~ 60°C) / 0.5 airflow

Packing List

- UP Squared Pro 710H Edge x 1
- DC in Phoenix Connector x 1

Optional Accessories

Part Number	Description
1255X00091	(TF)AC/DC Adapter.Input AC:100~240V.Output DC:12V.MAX 72W.6.0A.Wire Stripping and Tinning. EDAC.EA10681U(T19)
170203180J	Power Cord for UK
170X000799	Power Cord for USA
170X000800	Power Cord for EU
170X000815	Power Cord for China
170X000806	Power Cord for Taiwan
170X000803	Power Cord for Japan
170X000810	Power Cord for South Korea
170X000805	Power Cord for Switzerland
M206614000	Mounting Clip for DIN RAIL

UP Squared Pro TWL Edge

UP Squared Pro TWL System with Intel® Processor N-series, and Intel® Core™ i3-N355 Processor (formerly Twin Lake)



Features

- Intel® Processor N-series, and Intel® Core™ i3-N355 Processor (formerly Twin Lake)
- Onboard LPDDR5 Memory up to 16GB
- Onboard eMMC Storage up to 64GB
- 2.5GbE x 2 (Intel® I226-IT)
- USB 3.2 x 3 (Type A x 2, Type C x 1)
- 40 pin GPIO x 1
- DP 1.2 x 1/DP 1.4a x 1/HDMI 2.0b x 1
- RS-232/422/485 x 2
- M.2 2230 E-Key/M.2 2280 M-Key/M.2 3052 B-Key x 1
- SATA 6Gb/s x 1
- TPM 2.0
- 12V DC-in, 6A



Specifications

System	
CPU	Intel® Core™ 3 Processor N355 Intel® Processor N250 Intel® Processor N150 (formerly Twin Lake)
Memory	Up to 16GB onboard LPDDR5
Graphics	Intel® UHD Graphics for 12th Gen Intel® Processors
Storage	Up to 64GB onboard eMMC
Ethernet	2.5GbE x 2 (Intel® I226-IT)
WiFi/BT	Optional with M.2 2230 E-key x 1
Expansion Slot	M.2 2230 E-Key x 1 (CNVI, PCIe Gen 3 [x1]) M.2 2280 M-Key x 1 (PCIe Gen 3 [x2], USB 2.0) M.2 3052 B-Key x 1 (USB 3.2 Gen 2) with Nano SIM slot (USB 3.0) SATA 6Gb/s x 1
Security	Onboard TPM 2.0
OS Support	Windows® 11 LTSC Ubuntu: 24.04 LTS Yocto: 5.1
I/O Placements	
USB	USB 3.2 Gen 2 x 2 (Type-A) USB 3.2 Gen 2 x 1 (Type-C)
Display Port	HDMI 2.0b x 1 DP 1.2 x 1 DP 1.4a via USB Type C
Ethernet	2.5GbE x 2 (Intel® I226-IT)
COM	RS-232/422/485 x 2
Audio	Audio Jack x 1 (Mic-in+Line-out)
GPIO	40 Pin GPIO x 1
Power Supply	
Power requirement	12V DC-in (Lockable plug)
Power supply type	AT/ATX (ATX as default)
Power Consumption (Typical)	26W~35W
Mechanical	
Mounting	—
Dimensions (WxHxD)	5.27" x 4.13" x 2.56" (134mm x 105mm x 65mm)
Net Weight	2 lbs (0.95kg)
Gross Weight	2.8 lbs (1.3kg)
Environment	
Operating Temperature	-4°F ~ 140°F (-20°C ~ 60°C) / 0.7 airflow
Operating Humidity	0% ~ 90% relative humidity, non-condensing
Storage Temperature	-4°F ~ 158°F (-20°C ~ 70°C)
MTBF	422,053 Hours
Certification	CE/FCC Class A, RoHS Compliant, REACH





UP Squared Pro TWL Edge

Dimension

Unit: mm

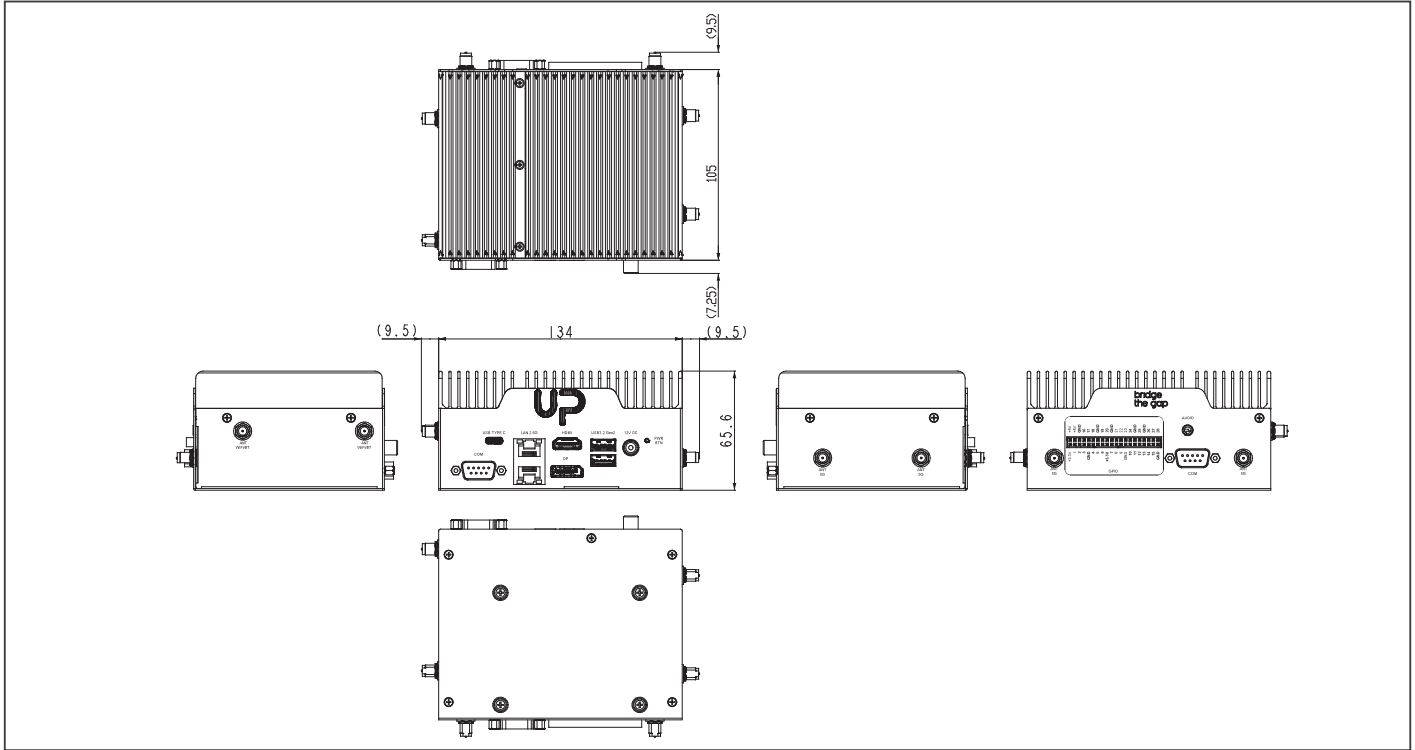

Ordering Information

Part number	CPU	CORE	MEMORY	STORAGE	HEATSINK
UPN-EDGE-TWLN150-A10-0864	Intel® Processor N150	4 Core	8GB	64GB	FANLESS
UPN-EDGE-TWL13-A10-0864	Intel® Core™ 3 Processor N355	4 Core	8GB	64GB	FANLESS
UPN-EDGE-TWL13-A10-1664	Intel® Core™ 3 Processor N355	4 Core	16GB	64GB	FANLESS
UPN-EDGE-TWLN150-A12-0864	Intel® Processor N150	4 Core	8GB	64GB	FANLESS

Optional Accessories

Part Number	Description
1255X00032	(TF)AC/DC Adapter.Input AC:100~240V.Output DC:12V.MAX 72W.6.0A.180D.W/ LOCK.EDAC.EA10681U(120)
170X000800	(TF)POWER CORD.3P-250V 10A 180D.1.8M.VDE.FAN-JET.YP-22/YC-12 (for EU)
170X000799	(TF)POWER CORD.3P-125V 10A 180D.1.8M.USA.FAN.JET.YP12/YC-12 (for USA)
170203180J	(TF)Power Cord.3P.250V 10A.UK type.1830mm (for UK)
170X000803	(TF)Power cord.3P.125V/7A.1.8M.PSE YP12/YC12 Certificat (for Japan)
170X000815	(TF)POWER CORD.3P(M).3P(F).1.8m.250V 10A 180D.CHINA.FAN-JET.YP-03/YC-12 (for China)
170X000806	(TF)Power Cord.3P-125VP.7A.180D.1.8M.TWN/BSMI.FANJET.YP-12/YC-12 (for Japan)
9651926001	M.2 2230 WiFi Kit.802.11ac.2.4G/5G,W/BT w/2 cable & antenna
9741364A00	Wireless LAN Kit M.2 2230 802.11ac/a/b/g/n + BT4.0,2T2R,with 2 sets of cable & antenna
UP-SATAKIT-A10-0001	SATA KIT for UPN-EDGE-APL01/UPN-EDGE-EHL01/UPN-EDGE-ADLN01

Packing List

- UP Squared Pro TWL Edge

UP Xtreme i11 Edge

UP System powered by 11th Generation Intel® Core™ i7/i5/i3/Celeron® Processor SoC

Front View

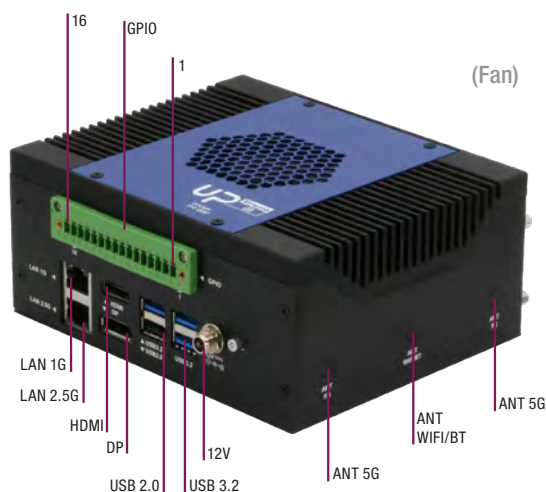
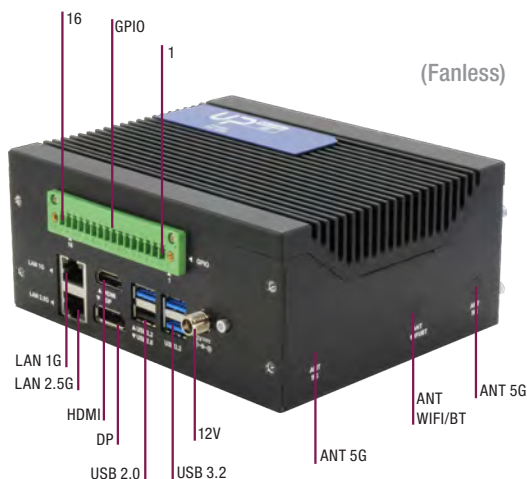

Rear View

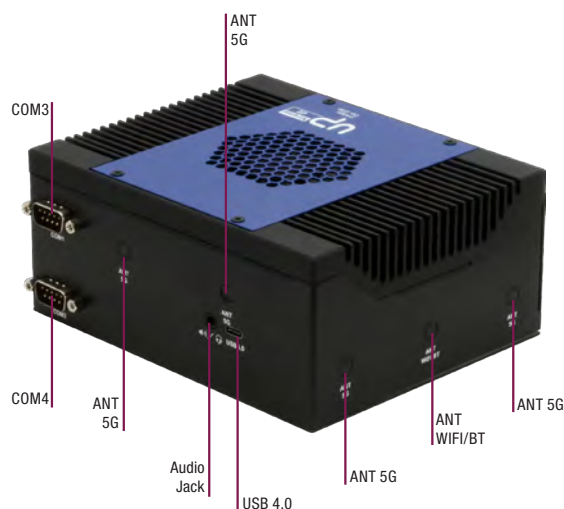

Features

- 11th Generation Intel® Core™ i7/i5/i3/Celeron® Processor SoC
- DDR4 SODIMM Slot x 2 (up to 64GB)
- 16-pin GPIO Connector x 1
- SATA Storage
- M.2 2230 E-Key x 1 (Wi-Fi 6)
- M.2 2280 M-Key x 1 (AI)
- M.2 3052 B-Key x 1 (5G)
- USB 4.0
- 2.5GbE x 1, GbE x 1
- Fanless/Fan design available



Specifications

System	
CPU	11th Gen Intel® Core™/Celeron® Processor SoC Intel® Core™ i7-1185G7E Intel® Core™ i7-1185GRE Intel® Core™ i5-1145G7E Intel® Core™ i5-1145GRE Intel® Core™ i3-1115GRE Intel® Celeron® 6305E
Memory	DDR4 SODIMM Slot x 2 (up to 64GB)
Graphics	Intel UHD Intel® Iris® Xe graphics: i5/i7 sku with 128bit (dual channel) memory VPU: Hailo-8™ M.2 2280 B+M key AI module via m.2 2280 (Optional by SKU from ordering information)
Storage	M.2 2280 M-Key x 1 for NVMe (PCIe x [2]) SATA 6Gb/s x 1
Ethernet	Intel® I225-IT x 1 Intel® I219 x 1 (Intel vPro®)
WiFi/BT	Optional via M.2 2230 E-Key x 1
Expansion Slot	40-pin GPIO x 1 M.2 2230 E-Key x 1 M.2 2280 M-Key x 1 M.2 3052 B-Key x 1 SATA 6Gb/s x 1 PCIe [x4] Slot
Security	Onboard TPM 2.0
OS Support	Microsoft Windows 10 and Windows IoT Linux Ubuntu 22.04 Linux Yocto 3.1
I/O Placements	
USB	USB 2.0 (Type-A) x 1 USB 3.2 Gen 2 (Type-A) x 3 USB 4.0 (Type-C) x 1
Display Port	HDMI 2.0 x 1 DP 1.4 x 1 (via USB Type-C) eDP x 1
Ethernet	RJ45 x 2
COM	RS232/422/485 x 2
Audio	Audio Jack x 1 (Mic-in+Line-out)
GPIO	16-pin terminal block connector x1
Power Supply	
Power requirement	12V DC-in (Lockable plug)
Power supply type	AT/ATX (ATX as default)
Power Consumption(Typical)	Balance: 32.4W, Max current: 66W
Mechanical	
Mounting	VESA Mount/Wallmount (optional)
Dimensions (WxHxD)	5.98" x 4.88" x 2.62" (152mm x 123.9mm x 66.5mm)
Net Weight	2.76 lbs (1.25kg)
Gross Weight	3.68 lbs (1.67kg)
Environment	
Operating Temperature	32°F ~ 140°F (0°C ~ 60°C) Fanless Sku memory and Storage requirement: DRAM Module : 0°C ~ 85°C, 2.5" SSD: -45°C ~ 85°C
Operating Humidity	0% ~ 90% relative humidity, non-condensing
Storage Temperature	-40°F ~ 176°F (-40°C ~ 80°C)





Dimension

Unit: mm

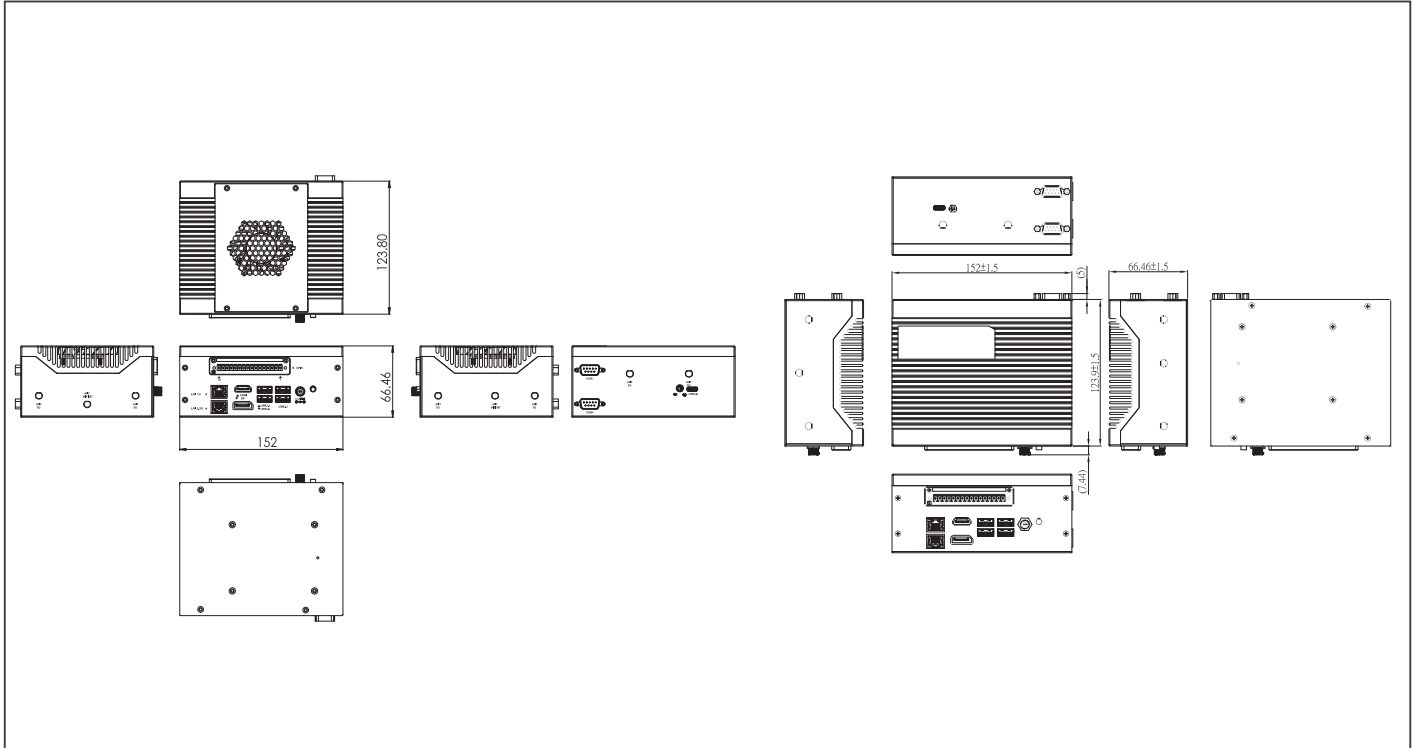

Ordering Information

Part Number	CPU	Memory	Storage	Heatsink	VPU
UPX-EDGE-TGLCR-A10-0000	Intel® Celeron® 6305E	SO-DIMM	—	FAN	—
UPX-EDGE-TGLI3-A10-0000	Intel® Core™ i3-1115G7E	SO-DIMM	—	FAN	—
UPX-EDGE-TGLI5-A10-0000	Intel® Core™ i5-1145G7E	SO-DIMM	—	FAN	—
UPX-EDGE-TGLI5G7E-A10-0000	Intel® Core™ i5-1145G7E	SO-DIMM	—	FAN	—
UPX-EDGE-TGLI7-A10-0000	Intel® Core™ i7-1185G7E	SO-DIMM	—	FAN	—
UPX-EDGE-TGLI7G7E-A10-0000	Intel® Core™ i7-1185G7E	SO-DIMM	—	FAN	—
UPX-EDGEFL-TGLCR-A10-0000	Intel® Celeron® 6305E	SO-DIMM	—	FANLESS	—
UPX-EDGEFL-TGLI3-A10-0000	Intel® Core™ i3-1115G7E	SO-DIMM	—	FANLESS	—
UPX-EDGEFL-TGLI5-A10-0000	Intel® Core™ i5-1145G7E	SO-DIMM	—	FANLESS	—
UPX-EDGEFL-TGLI5G7E-A10-0000	Intel® Core™ i5-1145G7E	SO-DIMM	—	FANLESS	—
UPX-EDGEFL-TGLI7-A10-0000	Intel® Core™ i7-1185G7E	SO-DIMM	—	FANLESS	—
UPX-EDGEFL-TGLI7G7E-A10-0000	Intel® Core™ i7-1185G7E	SO-DIMM	—	FANLESS	—
UPX-EDGE-TGLI5-A10-16128-HAILO	Intel® Core™ i5-1145G7E	16GB	128GB	FAN	Hailo-8™ M.2 2280 B+M key AI module via m.2 2280

Optional Accessories

Part Number	Description
1255X00032	(TF)AC/DC Adapter.Input AC.100~240V.Output DC.12V.MAX 72W.6.0A.180D.W/ LOCK.EDAC. EA10681U(120)
1255300960	(TF)Power Adapter.100-240VAC~50/60Hz.12W/8A.96W.DC jack W/lock.FSP.FSP096-AHAN3/9NA0961403 *Use this adapter if select AI Core XM
170X000799	(TF)POWER CORD.3P-125V 10A 180D.1.8M.USA.FANJET.YP12/YC-12 (for USA)
170X000800	(TF)POWER CORD.3P-250V 10A 180D.1.8M.VDE.FAN-JET.YP-22/YC-12 (for EU)
170X000803	(TF)Power cord.3P.125V/7A.1.8M.PSE YP12/YC12 Certificat (for Japan)
9741364A00	Wireless LAN Kit M.2 2230 802.11ac/a/b/g/n + BT4.0,2T2R,with 2 sets of cable & antenna (Enli,OCNFA364A)
9651926001	(TF).M.2 2230 WiFi Kit.802.11ac.2.4G/5G,W/BT Intel.9260.NG.WG.NV.958867 w/2 cable & antenna

Packing List

- SATA cable
- SATA power cable
- UP Xtreme i11 EDGE

UP Xtreme i11 Edge Compute Enabling Kit

11th Generation Intel® Core™ i7/i5 Processor SoC (formerly Tiger Lake UP3)



Front View

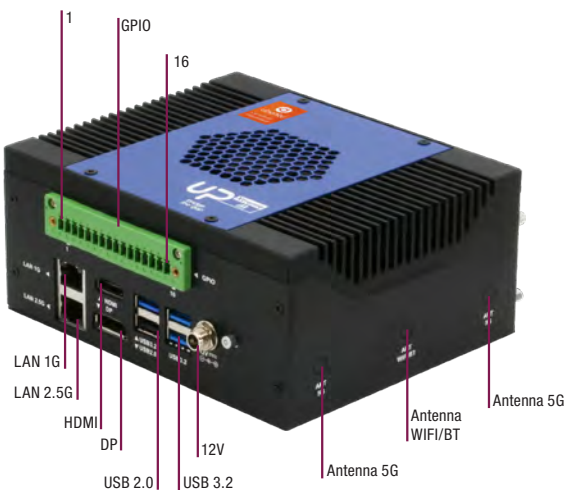

Rear View

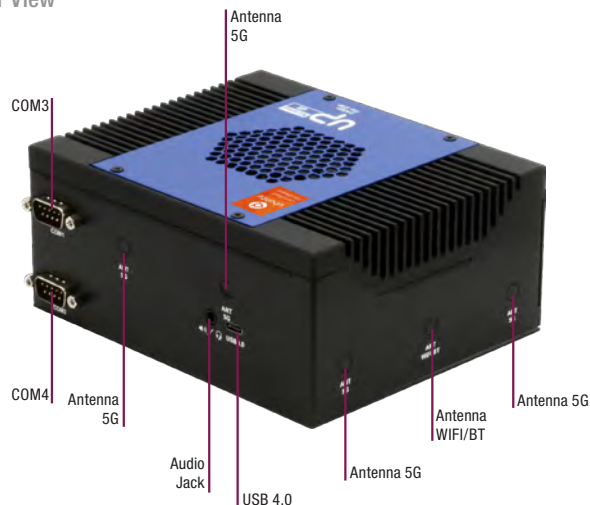

Features

- 11th generation Intel® Core™ i7/i5 Processor SoC (formerly Tiger Lake UP3)
- 16-pin GPIO connector x 1
- Pre-load Software
- Supports 5G via M.2 3052
- Supports AI Accelerator via M.2 2280
- Supports WiFi 6
- Supports USB 4.0
- Supports LAN up to 2.5Gbps



Specifications

System	
CPU	11th Gen Intel® Core™ Processor SoC Core i7-1185GRE Core i5-1145GRE
Memory	8GB 3200MHz SODIMM modules x 2
Graphics	Intel® Iris® Xe graphics
Storage	128GB 2.5" SSD x 1
Ethernet	Intel® i225IT (TSN) x 1, Intel® i219 (vPRO) x 1
WiFi/BT	Optional
Audio	Realtek ALC888s x 1 (Mic /Line out)
USB	USB 3.2 Gen2 x 3 USB 2.0 x 1 (Type A) USB 4.0 via USB type C
Expansion Slot	M.2 2230 E-Key x 1 M.2 2280 M-Key x 1 M.2 3052 B-Key x 1 with SIM
I/O Placements	
Power	12V DC-in (Lockable plug)/ Phoenix connector
USB	USB3.2 Gen2 x 3 USB2.0 x 1 (Type A) USB4.0 via USB type C
Display Port	HDM 2.0 x 1 /DP 1.4 x 1 eDP x 1, 4K at 60hz panel
Ethernet	Intel® i225IT x 1, Intel® i219 (vPRO) x 1
COM	RS232/422/485 x 2
Environment	
Power	12V (AT & ATX)
Form Factor	4.88"x 5.98" x 2.62" (124mm x 152mm x 66.5mm)
Gross Weight	5.07 lb (2.3kg)
Operating Temperature	32°F ~ 140°F (0°C ~ 60°C)
Operating Humidity	0% ~ 90% relative humidity, non-condensing
Certification	CE, FCC Class A
OS Support	Preinstalled Software Ubuntu 20.04 LTS and 5.11 Kernel Intel® Distribution of OpenVINO™ toolkit 2021 R1 Intel® Media SDK Intel® Distribution for Python* MRAA and UPM I/O and sensor libraries for C++, Python*, Java*, and JavaScript* Docker-CE k3s Kubernetes ONNX AWS Greengrass SQLite 3 Node.js cmake gcc Openssl Openssh-server/client git vim tmux



UP Xtreme i11 Edge Compute Enabling Kit

Dimension

Unit: mm

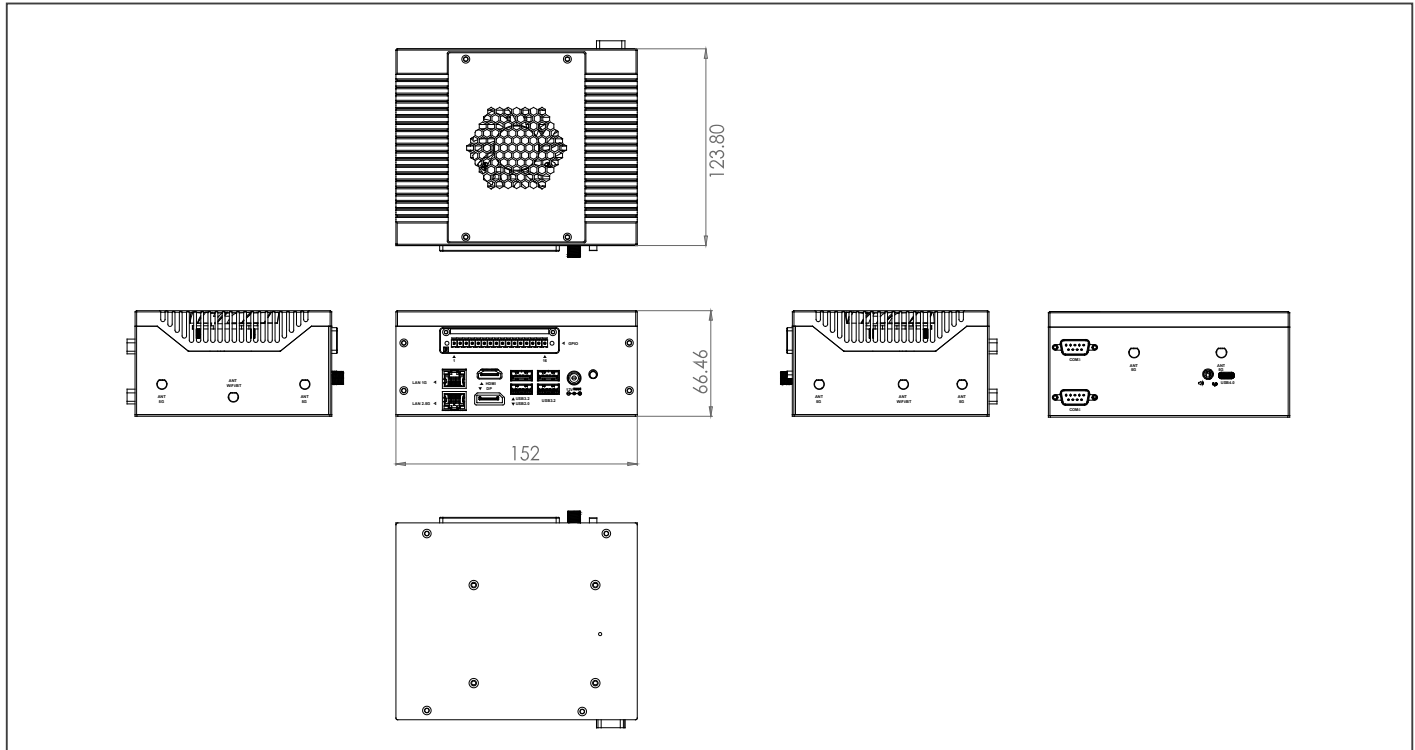

Ordering Information

Part Number	CPU	Core	LAN	Memory	Storage	USB	COM Ports	Expansion slot	AI Core XM 2280	GPIO	Display	Power	Operation temp	Preload Software
UPX-EDGE-TGLi7-A10-16128-FDKT	Intel Core i7-1185GRE	4	GbE x 2 (Intel i225 IT up to 2.5Gbps, Intel i219 up to 1Gbps)	8GB*2 3200MHz SODIMM	2.5" SATA SSD 128GB	USB 3.2 Gen 2 x 3 USB 2.0 x 1 USB4.0 x 1	2	M.2 2280 M key x 1, M.2 2230 E key x 1, M.2 3052 B key x 1 SATA 3 x 1 PCIe 4.0 x 1 (need customized chassis)	NO	16pin x 1	HDMI, DP, eDP, DP via USB type C	12V	32°F ~140°F (0°C ~ 60°C)	Ubuntu 20.04 LTS and 5.11 Kernel Intel® Distribution of OpenVINO™ toolkit 2021 R1 Intel® Media SDK Intel® Distribution for Python® MRAA and UPM I/O and sensor libraries for C++, Python®, Java®, and JavaScript® Docker-CE k3s Kubernetes ONNX AWS Greengrass SQLite 3 Node.js cmake gcc Openssl Openssh-server/client git vim tmux
UPX-EDGE-TGLi5-A10-16128-FDKT	Intel Core i5-1145GRE	2	GbE x 2 (Intel i225 IT up to 2.5Gbps, Intel i219 up to 1Gbps)	8GB*2 3200MHz SODIMM	2.5" SATA SSD 128GB	USB 3.2 Gen 2 x 3 USB 2.0 x 1 USB4.0 x 1	2	M.2 2280 M key x 1, M.2 2230 E key x 1, M.2 3052 B key x 1 SATA 3 x 1 PCIe 4.0 x 1 (need customized chassis)	NO	16pin x 1	HDMI, DP, eDP, DP via USB type C	12V	32°F ~140°F (0°C ~ 60°C)	
UPX-EDGE-TGLi7-A10-16128-FDAI	Intel Core i7-1185GRE	4	GbE x 2 (Intel i225 IT up to 2.5Gbps, Intel i219 up to 1Gbps)	8GB*2 3200MHz SODIMM	2.5" SATA SSD 128GB	USB 3.2 Gen 2 x 3 USB 2.0 x 1 USB4.0 x 1	2	M.2 2280 M key x 1, M.2 2230 E key x 1, M.2 3052 B key x 1 SATA 3 x 1 PCIe 4.0 x 1 (need customized chassis)	x1	16pin x 1	HDMI, DP, eDP, DP via USB type C	12V	32°F ~140°F (0°C ~ 60°C)	
UPX-EDGE-TGLi5-A10-16128-FDAI	Intel Core i5-1145GRE	2	GbE x 2 (Intel i225 IT up to 2.5Gbps, Intel i219 up to 1Gbps)	8GB*2 3200MHz SODIMM	2.5" SATA SSD 128GB	USB 3.2 Gen 2 x 3 USB 2.0 x 1 USB4.0 x 1	2	M.2 2280 M key x 1, M.2 2230 E key x 1, M.2 3052 B key x 1 SATA 3 x 1 PCIe 4.0 x 1 (need customized chassis)	x1	16pin x 1	HDMI, DP, eDP, DP via USB type C	12V	32°F ~140°F (0°C ~ 60°C)	

Packing List

- UPX-EDGE i11 x 1
- 8GB 3200MHz SODIMM modules x 2
- 128GB 2.5" SSD x 1
- PER-TAIX2-A20-2280 x 1 (for UPX-EDGE-TGLi7- A10-16128-FDAI & UPX-EDGE-TGLi5- A10-16128-FDAI only)
- Ubuntu License sticker x 1
- 1255300960

(TF)Power Adapter:100-240VAC~50/60Hz.12V/8A.96W.DC jack W/lock.FSP.FSP096-AHAN3/9NA0961403
(Use this adapter if select AI Core XM)

- 170X000799

(TF)POWER CORD.3P-125V 10A 180D.1.8M.USA.FANJET.YP12/YC-12

- 170X000800

(TF)POWER CORD.3P-250V 10A 180D.1.8M.VDE.FAN-JET.YP-22/YC-12

Optional Accessories

Part Number	Description
170X000803	(TF)Power cord.3P.125V/7A.1.8M.PSE YP12/YC12 Certificate
9741364A00	Wireless LAN Kit M.2 2230 802.11ac/a/b/g/n + BT4.0,2T2R,with 2 sets of cable & antenna (Enli,OCNFA364A)
9651926001	(TF).M.2 2230 WiFi Kit.802.11ac.2.4G/5G,W/BT Intel.9260.NGWS.NV.958867 w/2 cable & antenna



UP Xtreme i12 Edge

UP Xtreme i12/13 system with 12th/13th Generation Intel® Core™ i7/i5/i3/Celeron® Processor SoC

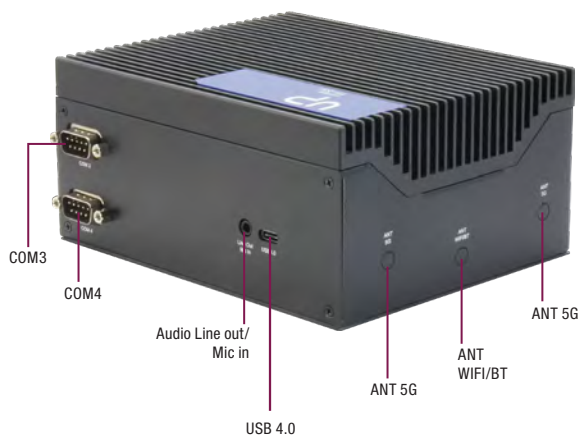
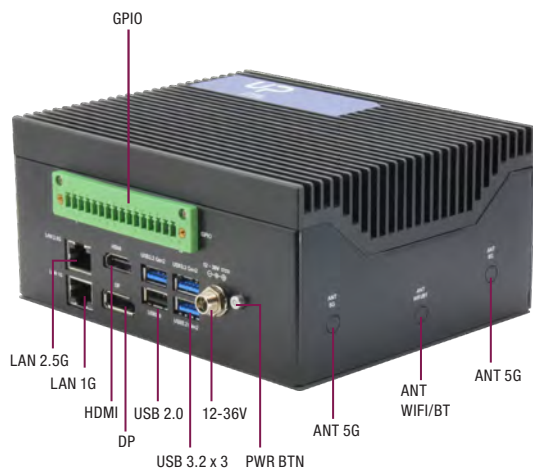

Features

- 12th/13th Generation Intel® Core™ i7/i5/i3/Celeron® Processor SoC
- Onboard Dual Channel LPDDR5, up to 32GB
- Support 4 independent displays up to 4K @60Hz
- M.2 2280 M-Key x 2 (PCIe Gen 4)
- M.2 3052 B-Key x 1
- Intel® AX210 WiFi 6 support
- TPM 2.0
- USB 4.0
- Up to 2.5GbE LAN speed
- Wide Range 12V~36V Power Input



Specifications

System	
CPU	12th Gen Intel® Core™ Processor SoC Intel® Core™ i7-1270PE, Intel® Core™ i7-1260P, Intel® Core™ i5-1250PE, Intel® Core™ i5-1240P, Intel® Core™ i3-1220PE, Intel® Celeron® 7305E 13th Gen Intel® Core™ Processor SoC Intel® Core™ i7-1370PE, Intel® Core™ i7-1360P, Intel® Core™ i5-1340PE, Intel® Core™ i3-1320PE
Memory	Up to 32GB onboard LPDDR5
Graphics	Intel® Iris® Xe graphics VPU: Hailo-8™ M.2 2280 B+M key AI module via m.2 2280 (Optional by SKU from ordering information)
Storage	M.2 2280 M-Key x 2 (PCIe Gen 4.0 [x4]) (an additional thermal kit is required when SSD is installed) SATA 6Gb/s x 1
Ethernet	Intel® I226-IT x 1 (TSN), Intel® I219 x 1 (vPRO)
WiFi/BT	Optional with M.2 2230 E-key x 1
Expansion Slot	40-pin GPIO x 1 M.2 2230 E-Key x 1 M.2 2280 M-Key x 2 (PCIe Gen 4.0 [x4]) SATA 6Gb/s x 1 M.2 3052 B-Key x 1 (an additional thermal kit is required when 5G module is installed) Nano SIM Slot x 1
Security	Onboard TPM 2.0
OS Support	Windows® 10 Enterprise 2021 LTSC, Ubuntu 22.04, Yocto 4.0
I/O Placements	
USB	USB 2.0 (Type-A) x 1, USB 3.2 Gen 2 (Type-A) x 3, USB 4.0 (Type-C) x 1
Display Port	HDMI 2.0b x 1 DP 1.4a x 1 DP 1.4a x 1 (via USB Type-C) eDP 1.4b x 1
Ethernet	RJ45 x 2
COM	RS-232/422/485 x 2
Audio	Audio Jack x 1 (Mic-in+Line-out)
GPIO	16-pin terminal block connector x1
Power Supply	
Power requirement	12-36V DC-in (Lockable plug)
Power supply type	AT/ATX (ATX as default)
Power Consumption(Typical)	Intel® Core™ i7-1270PE, LPDDR5 4800MHz 16GB, 5.86A@+ 12V (Typical) Intel® Core™ i7-1270PE, LPDDR5 4800MHz 16GB, 8.05A@+ 12V (Max)
Mechanical	
Mounting	VESA Mount/Wallmount(optional)
Dimensions (WxHxD)	5.98" x 4.87" x 2.81" (152mm x 123.8mm x 71.5mm)
Net Weight	2.95 lbs (1.34kg)
Gross Weight	3.88 lbs (1.76kg)
Environment	
Operating Temperature	With Cooler: 32°F ~ 140°F (0°C ~ 60°C), 0.5m/s airflow
Operating Humidity	0% ~ 90% relative humidity, non-condensing
Storage Temperature	-40°F ~ 176°F (-40°C ~ 80°C)
MTBF	366,810 Hours
Certification	CE/FCC Class A, RoHS Compliant, REACH





Dimension

Unit: mm

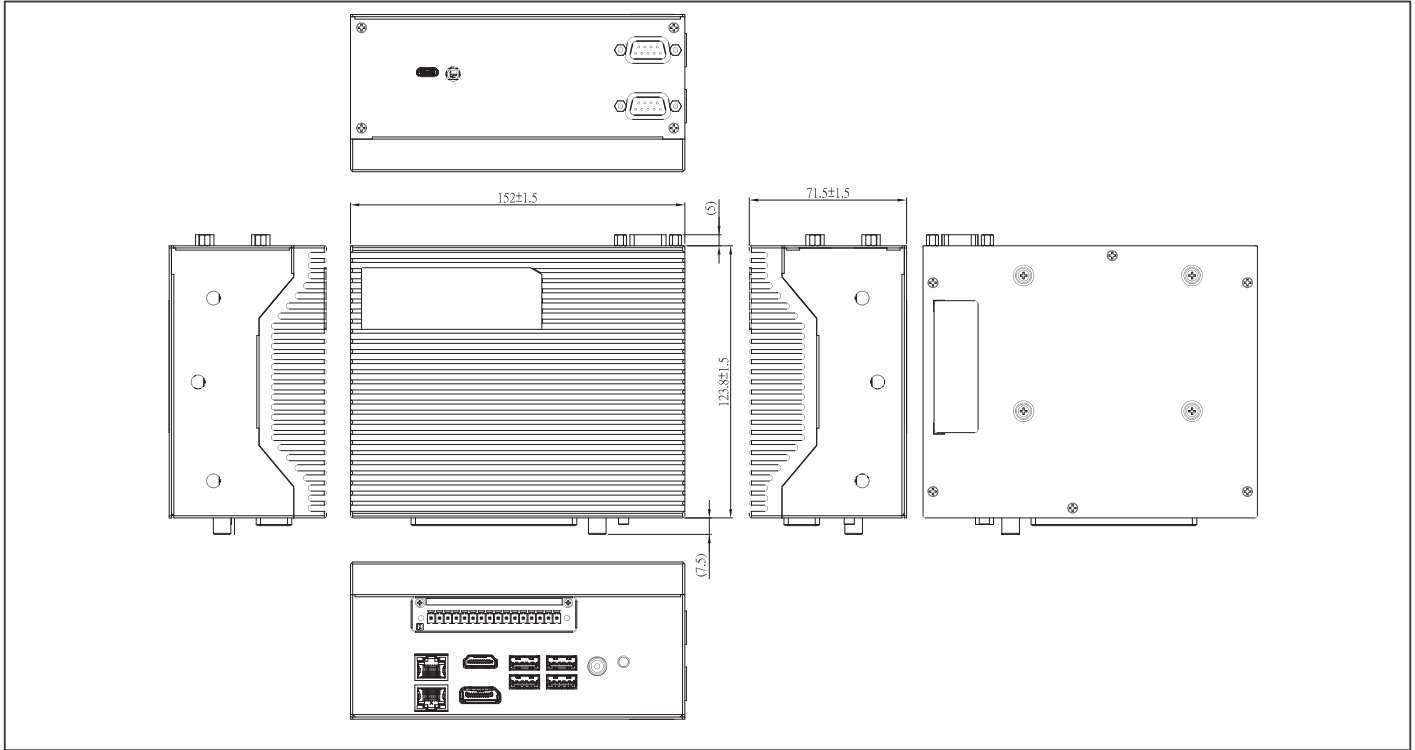

Ordering Information

Part Number	CPU	Core	Memory	Storage	Heatsink	VPU
UPX-EDGE-ADLPCR-A10-0864	Intel® Celeron® 7305E	1P+4E	8GB	64GB 2.5" SSD	FANLESS	—
UPX-EDGE-ADLPI3-A10-08128	Intel® Core™ i3-1220PE	4P+4E	8GB	128GB 2.5" SSD	FANLESS	—
UPX-EDGE-ADLPI5-A10-16128	Intel® Core™ i5-1250PE	4P+8E	16GB	128GB 2.5" SSD	FANLESS	—
UPX-EDGE-ADLPI7-A10-16128	Intel® Core™ i7-1270PE	4P+8E	16GB	128GB 2.5" SSD	FANLESS	—
UPX-EDGE-ADLPI5C-A10-16128	Intel® Core™ i5-1240P	4P+8E	16GB	128GB 2.5" SSD	FANLESS	—
UPX-EDGE-ADLPI7C-A10-16128	Intel® Core™ i7-1260P	4P+8E	16GB	128GB 2.5" SSD	FANLESS	—
UPX-EDGE-RAPI3-A11-16128	Intel® Core™ i3-1320PE	4P+4E	8GB	128GB 2.5" SSD	FANLESS	—
UPX-EDGE-RAPI5-A11-16128	Intel® Core™ i5-1340PE	4P+8E	16GB	128GB 2.5" SSD	FANLESS	—
UPX-EDGE-RAPI7-A11-16128	Intel Core i7-1370PE	6P+8E	16GB	128GB 2.5" SSD	FANLESS	—
UPX-EDGE-RAPI7C-A11-16128	Intel Core i7-1360P	4P+8E	16GB	128GB 2.5" SSD	FANLESS	—
UPX-EDGE-ADLPI5-A10-16128-HAILO	Intel® Core™ i5-1250PE	4P+8E	16GB	128GB 2.5" SSD	FANLESS	Hailo-8™ M.2 2280 B+M key AI module via m.2 2280

Optional Accessories

Part Number	Description
1255X00071	(TF)AC/DC Adapter.Input 100V~240V.output DC 19V.120W.6.32A.DC JACK w/Lock.FSP. FSP120-ABAN3/9NA1208548
170X000799	Power Cord for USA
170X000800	Power Cord for EU
170X000803	Power Cord for Japan
9741364A00	Wireless LAN Kit M.2 2230 802.11ac/a/b/g/n + BT4.0,2T2R,with 2 sets of cable & antenna (Enli,QCNFA364A)
9651926001	(TF).M.2 2230 WiFi Kit.802.11ac.2.4G/5G,W/BT Intel.9260.NG.WG.NV.958867 w/2 cable & antenna
9651210000	Wireless LAN Kit M.2 2230 802.11ac/a/b/g/n + BT5.2,2.4G/5G/6G,with 2 sets of cable & antenna (Intel AX210)
UPX-VESAKIT-A10-0001	VESA/Wallmount kit for UPX-EDGE-ADLP

*an additional thermal kit is required when SSD or 5G module is installed.

Packing List

- UP Xtreme i12 Edge
- SATA cable
- SATA power cable

UP Xtreme i14 Edge

UP Xtreme i14 system with Intel® Core™ Ultra Processor SoC

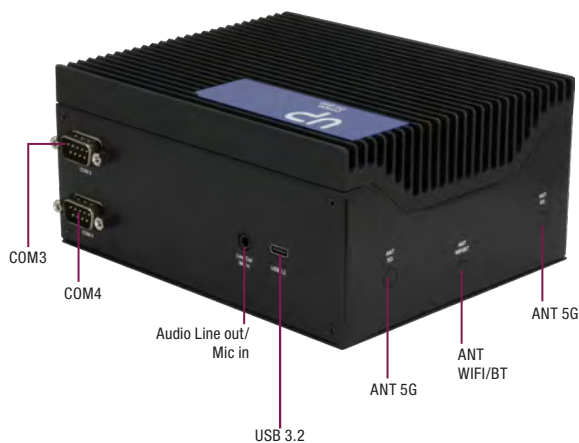
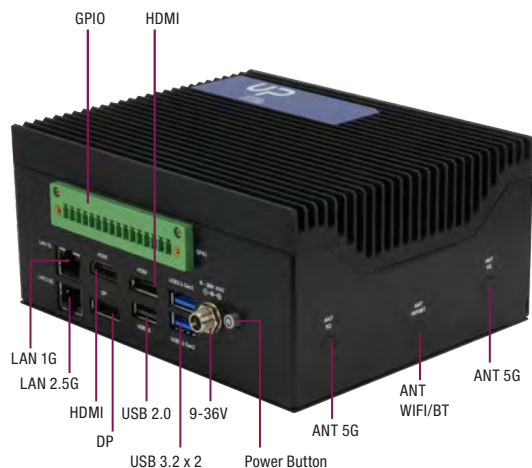

Features

- Intel® Core™ Ultra 5/7 Processors
- Onboard Dual Channel LPDDR5 6400, up to 64GB
- Up to 4 Simultaneous Displays
- M.2 2280 M-Key x 2
- M.2 3052 B-Key x 1 (5G)
- M.2 2230 E-Key x 1 (Wi-Fi/BT)
- 2.5GbE x 1, GbE x 1
- USB 3.2 Gen 2 (Type A x 2, Type C x 1)
- Onboard TPM 2.0
- Wide DC Input 9-36V



Specifications

System	
CPU	Intel® Core™ Ultra 5 processor 125U (12M Cache, up to 4.30 GHz) Intel® Core™ Ultra 5 processor 125H (18M Cache, up to 4.50 GHz) Intel® Core™ Ultra 7 processor 155H (24M Cache, up to 4.80 GHz) Intel® Core™ Ultra 7 processor 165H (24M Cache, up to 5.00 GHz)
Memory	Up to 64GB onboard LPDDR5 (Dual-Channel)
Graphics	Intel® Arc™ graphics
Storage	M.2 2280 M-Key x 2 SATA 6Gb/s x 1
Ethernet	2.5GbE x 1 (via Intel® Ethernet Controller I226-IT) GbE x 1 (Intel® Ethernet Connection I219)
WIFI/BT	M.2 2230 E-key x 1
Expansion Slot	40-pin GPIO x 1 M.2 2230 E-Key x 1 (PCIe Gen 3 [x1], USB 2.0) M.2 2280 M-Key x 2 (PCIe Gen 4 [x4]) M.2 3052 B-Key x 1 (PCIe Gen 3 [x1], USB 3.2 Gen 2 [x1]) with Nano SIM slot (USB 3.0) SATA 6Gb/s x 1
Security	Onboard TPM 2.0
OS Support	Windows 10/11 (64bit) Ubuntu 22.04/Kernel 6.5 up
I/O Placements	
USB	USB 2.0 x 2 (from 10 pin header x 1) USB 2.0 (Type-A) x 1 USB 3.2 Gen 2 (Type-A) x 2 USB 3.2 Gen 2 (Type-C) x 1
Display Port	HDMI 2.1 x 2 DP 2.1 x 1 DP 1.4 via USB Type-C x 1
Ethernet	2.5GbE x 1 (via Intel® Ethernet Controller I226-IT), GbE x 1 (Intel® Ethernet Connection I219)
COM	RS-232/422/485 10-pin header x 2
Audio	Audio Jack x 1 (Mic-in+Line-out)
GPIO	16-pin terminal block connector x 1
Power Supply	
Power requirement	9-36V DC-in (Lockable plug)
Power supply type	AT/ATX (ATX as default)
Power Consumption(Typical)	67-80W
Mechanical	
Mounting	VESA Mount/Wallmount(optional)
Dimensions (WxHxD)	5.98" x 4.87" x 2.81" (152mm x 123.8mm x 71.5mm)
Net Weight	2.95 lbs (1.34kg)
Gross Weight	3.88 lbs (1.76kg)
Environment	
Operating Temperature	32°F ~ 140°F (0°C ~ 60°C), 0.5m/s airflow
Operating Humidity	0% ~ 90% relative humidity, non-condensing
Storage Temperature	-40°F ~ 176°F (-40°C ~ 80°C)
MTBF	1,014,016
Certification	CE/FCC Class A, RoHS Compliant, REACH





Dimension

Unit: mm

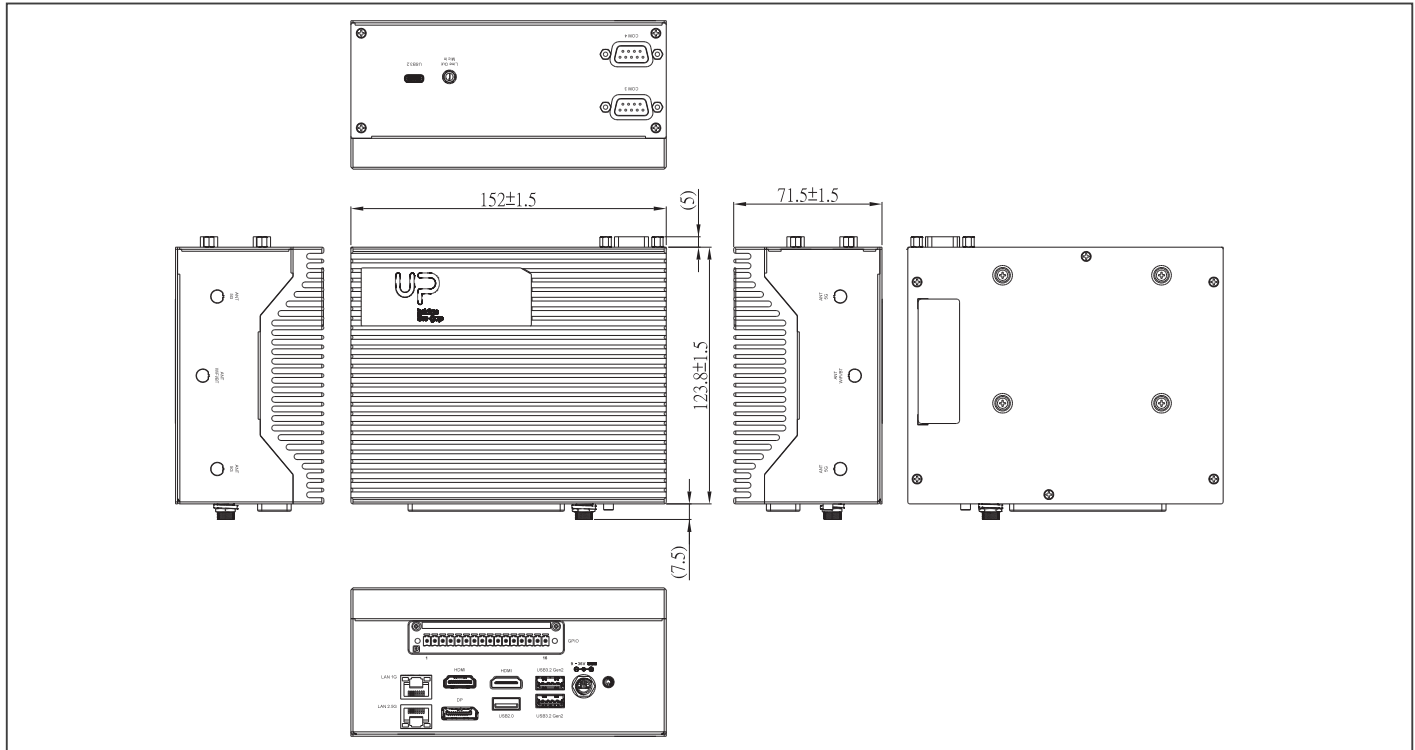

Ordering Information

Part Number	CPU	Core	Memory	Storage	Heatsink
UPX-EDGE-MTL125H-A10-1600	Intel Core Ultra 125H	4P+8E+2LPE	16GB	—	Fanless
UPX-EDGE-MTL125U-A10-3200	Intel Core Ultra 125U	2P+8E+2LPE	32GB	—	Fanless
UPX-EDGE-MTL125H-A10-3200	Intel Core Ultra 125H	4P+8E+2LPE	32GB	—	Fanless
UPX-EDGE-MTL155H-A10-3200	Intel Core Ultra 155H	6P+8E+2LPE	32GB	—	Fanless
UPX-EDGE-MTL165H-A10-6400	Intel Core Ultra 165H	6P+8E+2LPE	64GB	—	Fanless

Packing List

- UP Xtreme i14 Edge
- UPX-M2 THERMAL-A10-0002

Optional Accessories

Part Number	Description
1255X00071	(TF)AC/DC Adapter.Input 100V~240V.output DC 19V.120W.6.32A.DC JACK w/Lock.FSP.FSP120-ABAN3/9NA1208548
170203180J	Power Cord for UK
170X000799	Power Cord for USA
170X000800	Power Cord for EU
170X000815	Power Cord for China
170X000806	Power Cord for Taiwan
170X000803	Power Cord for Japan
170X000810	Power Cord for South Korea
170X000805	Power Cord for Switzerland
1702150155	Power Cable.15P SATA(F).2P 2.0mm, Housing(PH).15cm
1700070200	SATA CABLE.7P 180D(F) w/lock.to 7P 90D(F) w/o, lock SATA.20cm
9651210000	Wireless LAN Kit M.2 2230 802.11ac/a/b/g/n + BT5.2,2.4G/5G/6G.with 2 set of cable & antenna (Intel AX210)
UPX-M2THERMAL-A10-0002	M.2 2280 IO side thermal Kit for UPX-EDGE-ADLP01/ UPX-EDGE-MTL01

*an additional thermal kit is required when SSD or 5G module is installed.
 *SATA cable and SATA power cable is required when using a SATA SSD

UP Xtreme ARL Edge

UP Xtreme ARL system with Intel® Core™ Ultra 5/7 Processors

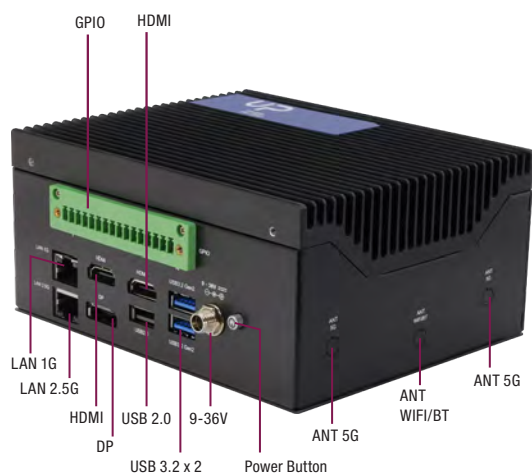

Features

- Intel® Core™ Ultra 5/7 Processors
- Onboard Dual Channel LPDDR5 6400, up to 64GB
- Up to 4 Simultaneous Displays
- M.2 2280 M-Key x 2
- M.2 3052 B-Key x 1 (5G)
- M.2 2230 E-Key x 1 (Wi-Fi/BT)
- 2.5GbE x 1, GbE x 1
- USB 3.2 Gen 2 (Type A x 2)
- Onboard TPM 2.0
- Wide DC Input 9-36V



Specifications

System	
CPU	Intel® Core™ Ultra 5 processor 225H (18M Cache, up to 4.90 GHz) Intel® Core™ Ultra 7 processor 255H (24M Cache, up to 5.10 GHz) Intel® Core™ Ultra 7 processor 265H (24M Cache, up to 5.30 GHz)
Memory	Up to 64GB onboard LPDDR5 (Dual-Channel)
Graphics	Intel® Arc™ graphics
Storage	M.2 2280 M-Key x 2 SATA 6Gb/s x 1
Ethernet	2.5GbE x 1 (via Intel® Ethernet Controller I226-IT) GbE x 1 (Intel® Ethernet Connection I219)
WIFI/BT	M.2 2230 E-key x 1
Expansion Slot	40-pin GPIO x 1 M.2 2230 E-Key x 1 (PCIe Gen 3 [x1], USB 2.0) M.2 2280 M-Key x 2 (PCIe Gen 4 [x4]) M.2 3052 B-Key x 1 (PCIe Gen 3 [x1], USB 3.2 Gen 2 [x1]) with Nano SIM slot (USB 3.0) SATA 6Gb/s x 1
Security	Onboard TPM 2.0
OS Support	Windows® 11 LTSC Ubuntu: 24.04 LTS Yocto: 5.1
I/O Placements	
USB	USB 2.0 x 2 (from 10 pin header x 1) USB 2.0 (Type-A) x 1 USB 3.2 Gen 2 (Type-A) x 2
Display Port	HDMI 2.1 x 2 DP 2.1 x 1
Ethernet	2.5GbE x 1 (via Intel® Ethernet Controller I226-IT), GbE x 1 (Intel® Ethernet Connection I219)
COM	RS-232/422/485 10-pin header x 2
Audio	Audio Jack x 1 (Mic-in+Line-out)
GPIO	16-pin terminal block connector x 1
Power Supply	
Power requirement	9-36V DC-in (Lockable plug)
Power supply type	AT/ATX (ATX as default)
Power Consumption(Typical)	57.6W ~ 86.4W
Mechanical	
Mounting	VESA Mount/Wallmount(optional)
Dimensions (WxHxD)	5.98" x 4.87" x 2.81" (152mm x 123.8mm x 71.5mm)
Net Weight	2.95 lbs (1.34kg)
Gross Weight	3.88 lbs (1.76kg)
Environment	
Operating Temperature	-4°F ~ 140°F (-20°C ~ 60°C), 0.7m/s airflow
Operating Humidity	0% ~ 90% relative humidity, non-condensing
Storage Temperature	-40°F ~ 176°F (-40°C ~ 80°C)
MTBF	1,014,016
Certification	CE/FCC Class A, RoHS Compliant, REACH





Dimension

Unit: mm

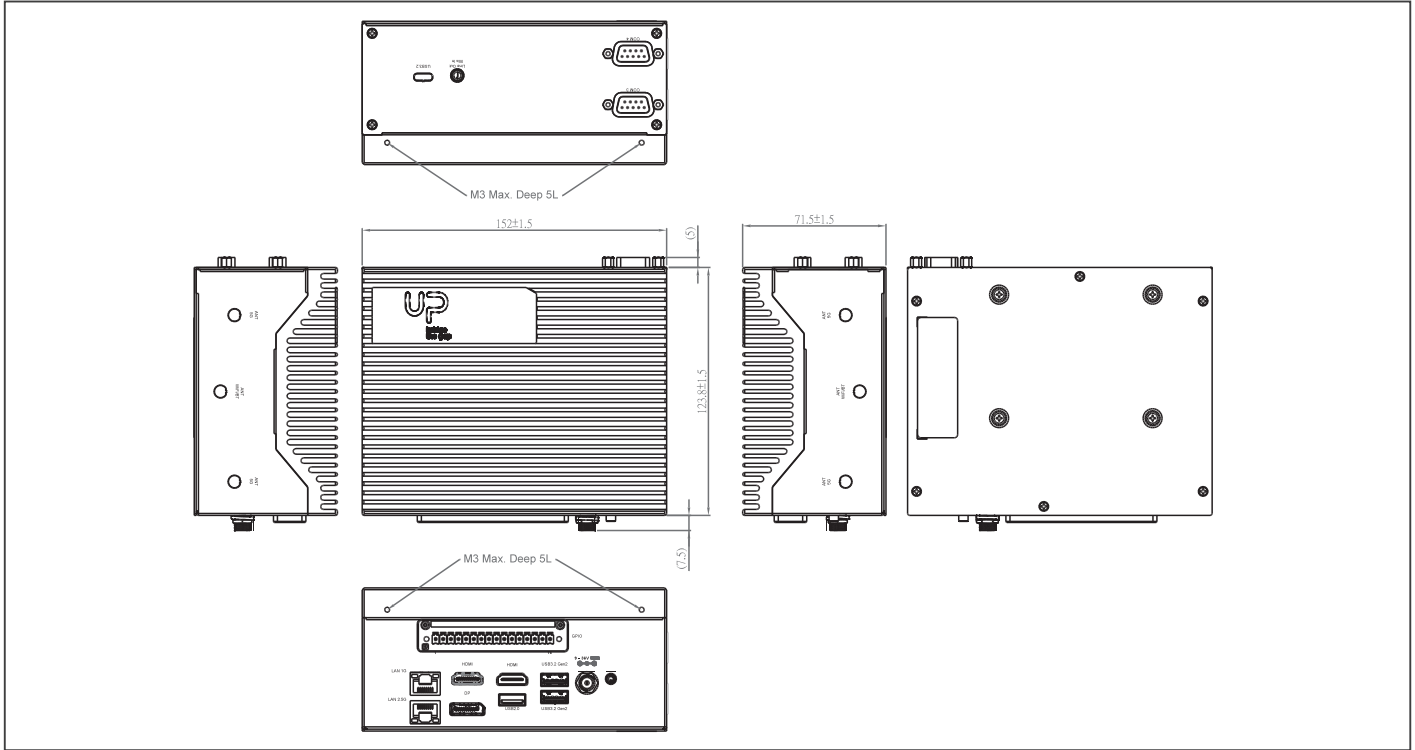

Ordering Information

Part Number	CPU	Core	Memory	Heatsink
UPX-EDGE-ARL225H-A10-1600	Intel® Core™ Ultra 5 processor 225H (18M Cache, up to 4.90 GHz)	4P+8E+2LPE	16GB	Fanless
UPX-EDGE-ARL225H-A10-3200	Intel® Core™ Ultra 5 processor 225H (18M Cache, up to 4.90 GHz)	4P+8E+2LPE	32GB	Fanless
UPX-EDGE-ARL255H-A10-3200	Intel® Core™ Ultra 7 processor 255H (24M Cache, up to 5.10 GHz)	6P+8E+2LPE	32GB	Fanless
UPX-EDGE-ARL265H-A10-6400	Intel® Core™ Ultra 7 processor 265H (24M Cache, up to 5.30 GHz)	6P+8E+2LPE	64GB	Fanless

Optional Accessories

Part Number	Description
1255X00071	(TF)AC/DC Adapter.Input 100V~240V.output DC 19V.120W.6.32A.DC JACK w/Lock.FSP.FSP120-ABAN3/9NA1208548
170203180J	Power Cord for UK
170X000799	Power Cord for USA
170X000800	Power Cord for EU
170X000815	Power Cord for China
170X000806	Power Cord for Taiwan
170X000803	Power Cord for Japan
170X000810	Power Cord for South Korea
170X000805	Power Cord for Switzerland
1702150155	Power Cable.15P SATA(F).2P 2.0mm, Housing(PH).15cm
1700070200	SATA CABLE.7P 180D(F) w/lock.to 7P 90D(F) w/o, lock SATA.20cm
9651210000	Wireless LAN Kit M.2 2230 802.11ac/a/b/g/n + BT5.2,2.4G/5G/6G.with 2 set of cable & antenna (Intel AX210)
UPX-M2THERMAL-A10-0002	M.2 2280 IO side thermal Kit for UPX-EDGE-ADLP01/ UPX-EDGE-MTL01
UPX-VESAKIT-A10-0001	VESA/Wallmount kit for UPX-EDGE-ADLP/UPX-EDGE-MTL/ UPX-EDGE-ARL

Packing List

- UP Xtreme ARL Edge
- UPX-M2 THERMAL-A10-0002

*an additional thermal kit is required when SSD or 5G module is installed.
 *SATA cable and SATA power cable is required when using a SATA SSD

UP Xtreme PTL Edge PRELIMINARY

UP Xtreme PTL system with Intel® Core Ultra Series 3 Processor SoC



Features

- Intel® Core Ultra Series 3 Processors
- DDR5 7200 Dual Channel SODIMM x 2 Max. 64GB
- Up to 4 Simultaneous Displays
- M.2 2280 M-Key x 2
- M.2 2230 E-Key x 1 (Wi-Fi/BT)
- 2.5GbE x 2
- USB 3.2 Gen 2 (Type-A) x 2, USB 4.0 (Type-C) x 2
- Onboard TPM 2.0
- Wide DC Input 19-36V



Specifications

System	
CPU	Intel® Core™ Ultra 7 processor 358H (4.8 GHz) Intel® Core™ Ultra 5 processor 338H (4.7 GHz)
Memory	DDR5 7200 Dual Channel SODIMM x 2 Max. 64GB
Graphics	Intel® Xe Graphics
Storage	M.2 2280 M-Key x 2
Ethernet	2.5GbE x 2 (via Intel® Ethernet Controller I226-IT)
WiFi/BT	M.2 2230 E-key x 1
Expansion Slot	40-pin GPIO x 1 M.2 2230 E-Key x 1 (PCIe Gen 3 [x1], USB 2.0) M.2 2280 M-Key x 2 (PCIe Gen 4 [x4])
Security	Onboard TPM 2.0
OS Support	Windows 11 IoT Enterprise Ubuntu 24.04 LTS
I/O Placements	
USB	USB 3.2 Gen 2 (Type-A) x 2 USB 4.0 (Type-C) x 2
Display Port	HDMI 2.1 x 2 DP 1.4 x 2 via USB4.0 Type-C
Ethernet	2.5GbE x 2 (via Intel® Ethernet Controller I226-IT)
COM	RS-232/422/485 x 2
Audio	Audio Jack x 1 (Mic-in+Line-out)
GPIO	40-pin GPIO x 1
Power Supply	
Power requirement	19-36V DC-in
Power supply type	AT/ATX
Power Consumption(Typical)	TBD
Mechanical	
Mounting	VESA Mount/Wallmount(optional)
Dimensions (WxHxD)	8.6" x 5.1" x 2" (218mm x 129mm x 49.5mm)
Net Weight	TBD
Gross Weight	TBD
Environment	
Operating Temperature	32°F ~ 140°F (0°C ~ 60°C), 0.7m/s airflow
Operating Humidity	0% ~ 90% relative humidity, non-condensing
Storage Temperature	-40°F ~ 176°F (-40°C ~ 80°C)
MTBF	TBD
Certification	CE/FCC Class A, RoHS Compliant, REACH





Dimension

Unit: mm

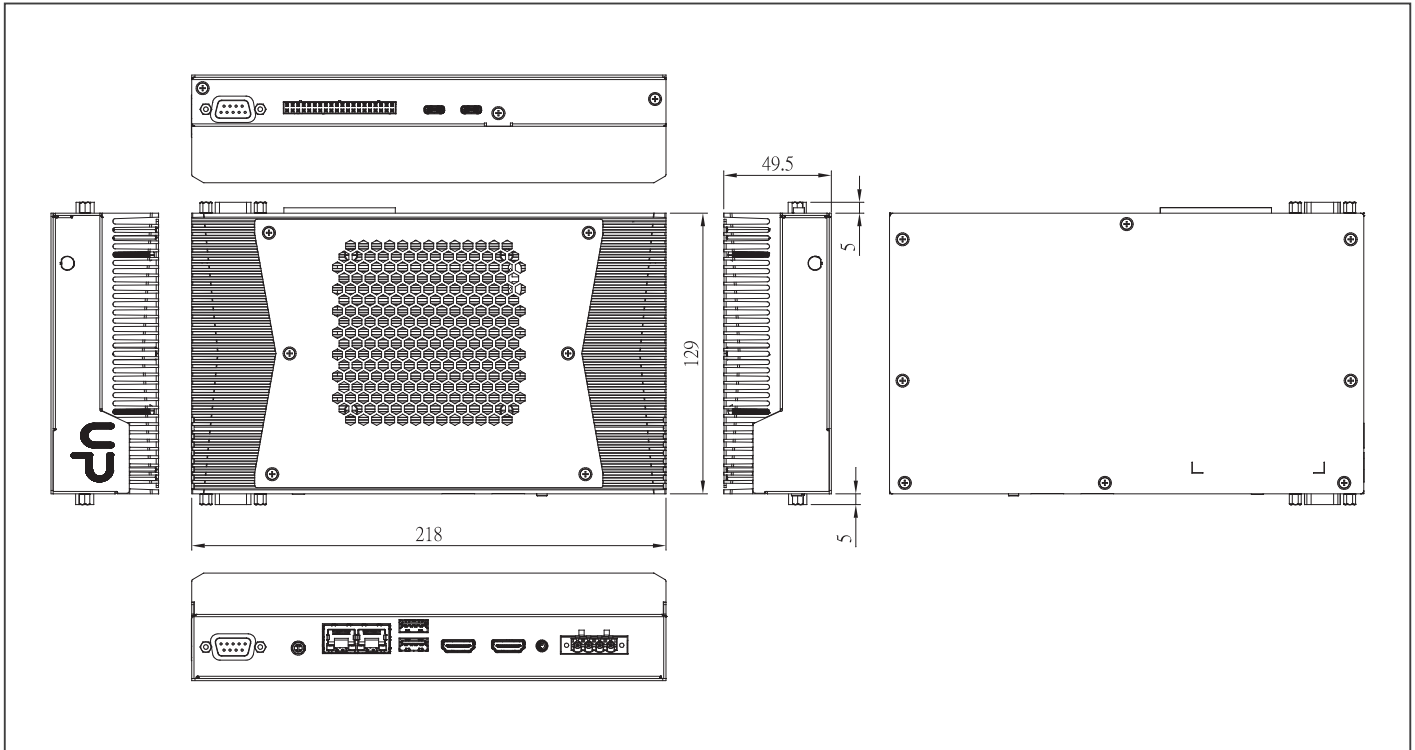

Ordering Information

- TBD

Optional Accessories

- TBD

Packing List

- UP Xtreme PTL Edge

UP Xtreme 7100 Edge

UP Xtreme 7100 System powered by Intel® Processor N-series, and Intel® Core™ i3-N305 Processor

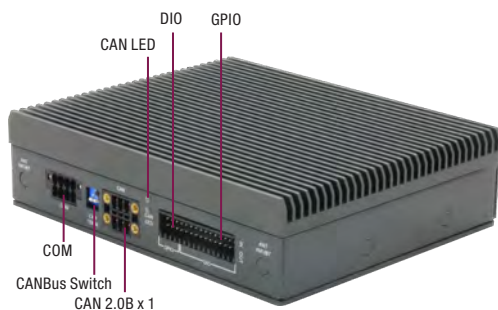
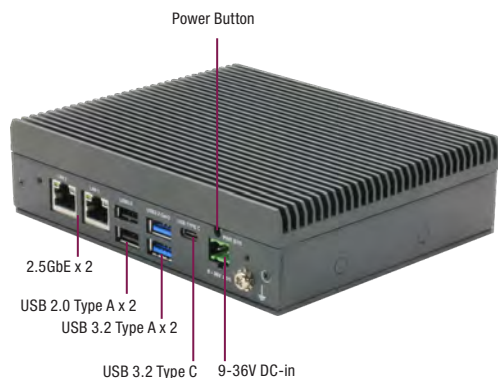

Features

- Intel® Processor N-series and Intel® Core™ i3-N305 Processor SoC
- Low power consumption
- 2.5GbE x 2 (Intel® I226-IT)
- 2-channel CAN 2.0B x 1
- Watchdog timer, Onboard TPM 2.0
- DIO/GPIO via Terminal Block
- Cable-free design
- Wide 9V~36V power input
- Fanless design



Specifications

System	
CPU	Intel® Core™ i3-N305 Intel® Processor N97
Memory	Up to 16GB LPDDR5
Graphics	Intel® UHD Graphics for 12th Gen Intel® Processors
Storage	Up to 64GB eMMC
Ethernet	2.5GbE x 2 (Intel® I226-IT)
WIFI/BT	Optional with M.2 2230 E-key x 1
Expansion Slot	M.2 3052 B-Key x 1 with Nano SIM slot (USB 3.0) M.2 2230 E-Key x 1 (USB 2.0/PCIe) M.2 2280 M-Key x 1 (PCIe Gen 3 [x2]) 24V 8-in/8-out Digital I/O x 1 via Terminal Block (Output current: 500mA per channel) 6 pin 2-channel CAN 2.0B x 1 via Terminal Block (10 ~ 1000 kbps) DIP Switch for CANBus function x 1 CAN LED indicator x 2 SATA III x 1
Security	Onboard TPM 2.0
OS Support	Ubuntu 22.04 LTS (Kernel 5.15 and kernel 5.19)
I/O Placements	
USB	USB 2.0 (Type-A) x 2 USB 3.2 (Type-A) x 2 USB 3.2 Gen 2 (Type-C) x 1 (Supports DP alt mode)
Display Port	DP 1.4a x 1 (via USB Type-C)
Ethernet	RJ45 x 2
COM	RS-232/422/485 x 1 (Terminal Block) (Default RS232)
Audio	—
GPIO	6 pin GPIO x 1 via Terminal Block
POWER Supply	
Power requirement	9-36V
Power supply type	AT/ATX (AT as default)
Power Consumption(Typical)	52W~55W
MECHANICAL	
Mounting	75mm x 75mm VESA mount, optional Wallmount kit
Dimensions (WxHxD)	5.98" x 4.8" x 1.7" (152mm x 124mm x 40mm)
Net Weight	2.21lb (1.0Kg)
Gross Weight	3.31lb (1.5Kg)
Environment	
Operating Temperature	32°F ~ 131°F (0°C ~ 55°C)/0.5m/s airflow
Operating Humidity	0% ~ 90% relative humidity, non-condensing
Storage Temperature	-4°F ~ 158°F (-20°C ~ 70°C)
MTBF	421,998
Certification	CE/FCC Class A, RoHS Compliant, REACH





Dimension

Unit: mm

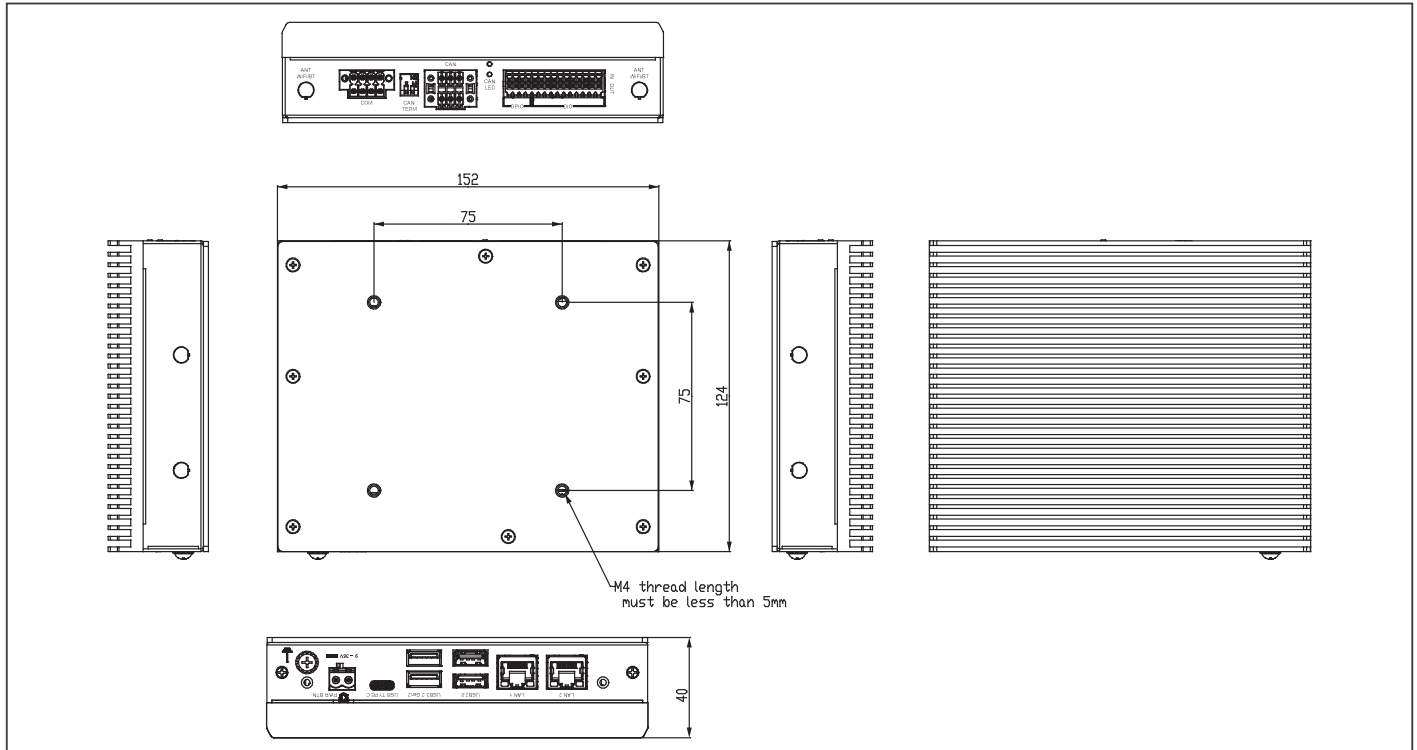

Ordering Information

Part Number	CPU	Memory	Storage
UPX-EDGE-ASLN97-A10-0864	Intel® Processor N97	8GB	64GB
UPX-EDGE-ASLNi3-A10-1664	Intel® Core™ i3-N305	16GB	64GB

Optional Accessories

Part Number	Description
1255X00091	12VDC/6A Adapter
170X000800	Power cord for EU
170X000799	Power cord for US
170203180J	Power cord for UK
170X000803	Power cord for Japan
170X000815	Power cord for China
170X000806	Power cord for Taiwan
9651210000	Wireless LAN Kit M.2 2230 802.11ax/ac/a/b/g/n + BT5.2,2.4G/5G/6G,with 2 sets of cable & antenna
9651UPEG00	Wallmount Bracket kit 183*125*4mm
9651UPEG01	Shock Absorbers kit

Packing List

- UP Xtreme 7100 Edge x 1
- DC in Phoenix
- Block Connector x 1
- RS232/422/485 Block x 1
- DIO/GPIO Phoenix Connector x 1
- CAN Phoenix Connector x 2

Intelli i14 Edge

Vision System Embedded Box PC with 14th Generation Intel® Core™ Processors (Socket Type)

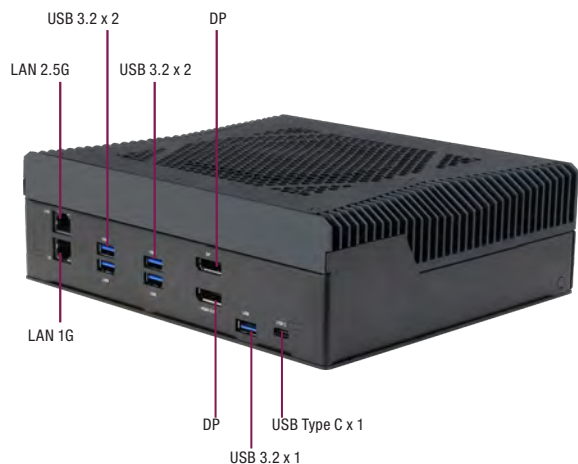

Features

- Intel® Core™ i9 Processors (14th Gen), up to 65W
- Integrated NVIDIA RTX™ A2000/NVIDIA® RTX™ A4500 MXM Module
- Compact 205mm x 190mm x 70mm design
- M.2 2280 M-Key x 2 (NVMe)
- DDR5 SODIMM x 2, up to 32GB, 4800 MT/s, ECC supported

Specifications

System	
CPU	Intel® Core™ Processors (14th Gen), up to 65W LGA 1700 socket Default: Intel® Core™ i9-14900T
Memory	DDR5 SODIMM x 2, up to 96GB, 4800 MT/s, ECC supported
Graphics	NVIDIA RTX™ A2000/NVIDIA® RTX™ A4500 MXM Module Support MXM 3.1 Type A/ B/ B+, Max 115W, PCIe Gen4x16 Only support validated MXM GPU module
Storage	via M.2 2280 M-Key x 2 (NVMe)
Ethernet	2.5GbE x 1 (Intel® Ethernet Controller I226-IT) 1GbE x 1 (Intel® Ethernet Connection I219-LM)
WiFi/BT	via M.2 2230 E-Key
Expansion Slot	M.2 2230 E-key x 1 M.2 2280 M-key x 2
Security	TPM 2.0
OS Support	Windows 10/ 11 IoT Enterprise; Linux 64-bit
I/O Placements	
USB	USB 3.2 Gen 1 (Type A) x 5 USB 3.2 Gen 2 (Type C) x 1
Display Port	Display Port x 2 from MXM GPU Display Port (USB Type C) x1 from MXM GPU (A4500 SKU Max: 7680x4320 @ 60Hz)
Ethernet	2.5GbE x 1 (Intel® Ethernet Controller I226-IT) 1GbE x 1 (Intel® Ethernet Connection I219-LM)
COM	—
Audio	—
GPIO	—
Power Supply	
Power requirement	12V DC-In
Power supply type	AT(default)/ATX
Power Consumption(Typical)	300W
Mechanical	
Mounting	—
Dimensions (WxHxD)	8.07" x 7.48" x 2.76" (205mm x 190mm x 70mm)
Net Weight	6.57 lbs (2.99 kg)
Gross Weight	6.72 lbs (3.05 kg)
Environment	
Operating Temperature	32°F ~122°F (0°C ~ 50°C)/0.5m/s airflow
Operating Humidity	0% ~ 90% relative humidity, non-condensing
Storage Temperature	-4°F to 158°F (-20°C to 70°C)
MTBF	1,373,882
Certification	CE/FCC Class A, RoHS Compliant, REACH





Dimension

Unit: mm

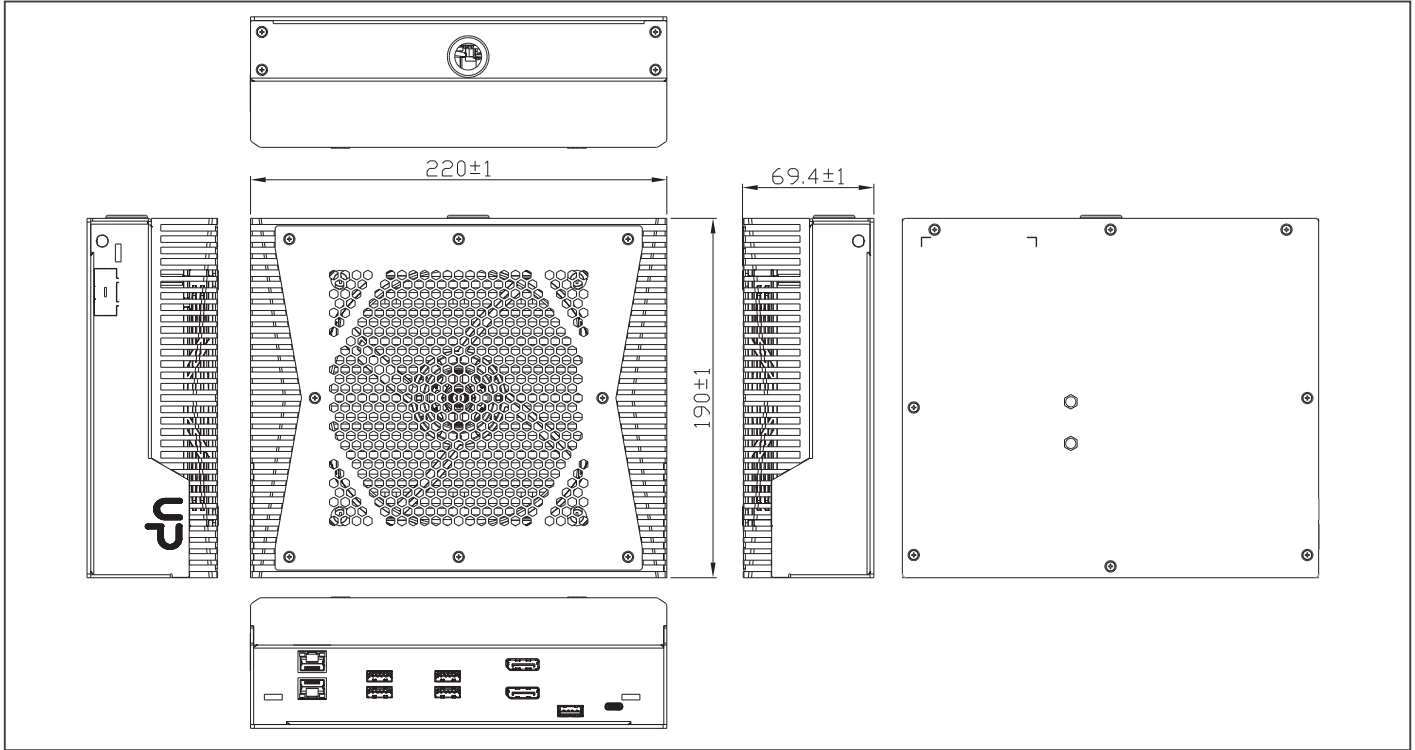

Packing List

- Intelli i14 Edge x 1
- 330W AC/DC power Adapter
- Power cord for US x 1

Ordering Information

Part Number	CPU	Memory	Storage	Graphics
ITL-ADLSI9-A10-NVA2-32512	Intel® Core™ i9-14900T	32GB	512GB	Nvidia M3A2000-VY1-A1
ITL-ADLSI9-A10-NV45-32512	Intel® Core™ i9-14900T	32GB	512GB	Nvidia M3A4500-WP1-A3

Intelli STX TWL PRELIMINARY

Intelli STX TWL with Intel® Processor N-series SoC (formerly Twin Lake)

Front View



Rear View



Features

- Intel® Processor N-series SoC (formerly Twin Lake)
- Onboard LPDDR5 Memory up to 16GB
- Onboard eMMC Storage up to 128GB
- Gb Ethernet RJ-45 x 2
- USB 3.2 Type A x 4
- HDMI 2.0b x 2
- RS232/422/485 x 1
- M.2 2230 E-Key x 1
- M.2 2280 M-Key x 1
- TPM 2.0
- 9V~36V DC-in



Specifications

System	
CPU	Intel® Core™ 3 Processor N355 Intel® Processor N250 Intel® Processor N150 Intel® Processor N97
Memory	Up to 16GB LPDDR5
Graphics	Intel® UHD Graphics for 12th Gen Intel® Processors
Storage	Up to 128GB eMMC
Ethernet	Gb Ethernet RJ-45 x 2
WIFI/BT	Optional with M.2 2230 E-key x 1
Expansion Slot	M.2 2230 E-Key x 1 (PCIe x1, USB2.0 x1) M.2 2280 M-key x 1 (PCIe x2)
Security	Onboard TPM 2.0
OS Support	Windows® 11 LTSC Ubuntu: 24.04 LTS Yocto: 5.1
I/O Placements	
USB	USB 3.2 Gen 2 x 4 (Type-A)
Display Port	HDMI 2.0b x 2
Ethernet	Gb Ethernet RJ-45 x 2
COM	RS-232/422/485 x 1
Audio	Line out x 1 Mic in x 1
GPIO	—
Power Supply	
Power requirement	9V~36V DC-in, 5A
Power supply type	AT/ATX
Power Consumption (Typical)	15W~37W
Mechanical	
Mounting	DIN Rail, Wallmount, VESA mount
Dimensions (WxHxD)	5.98" x 4.9" x 1.54" (152 x 124 x 39 mm)
Net Weight	TBD
Gross Weight	TBD
Environment	
Operating Temperature	32°F ~ 122°F (0°C ~ 50°) / 0.5 airflow
Operating Humidity	0% ~ 90% relative humidity, non-condensing
Storage Temperature	-4°F ~ 158°F (-20°C ~ 70°C)
MTBF	TBD
Certification	CE/FCC Class A, RoHS Compliant, REACH





Dimension

Unit: mm

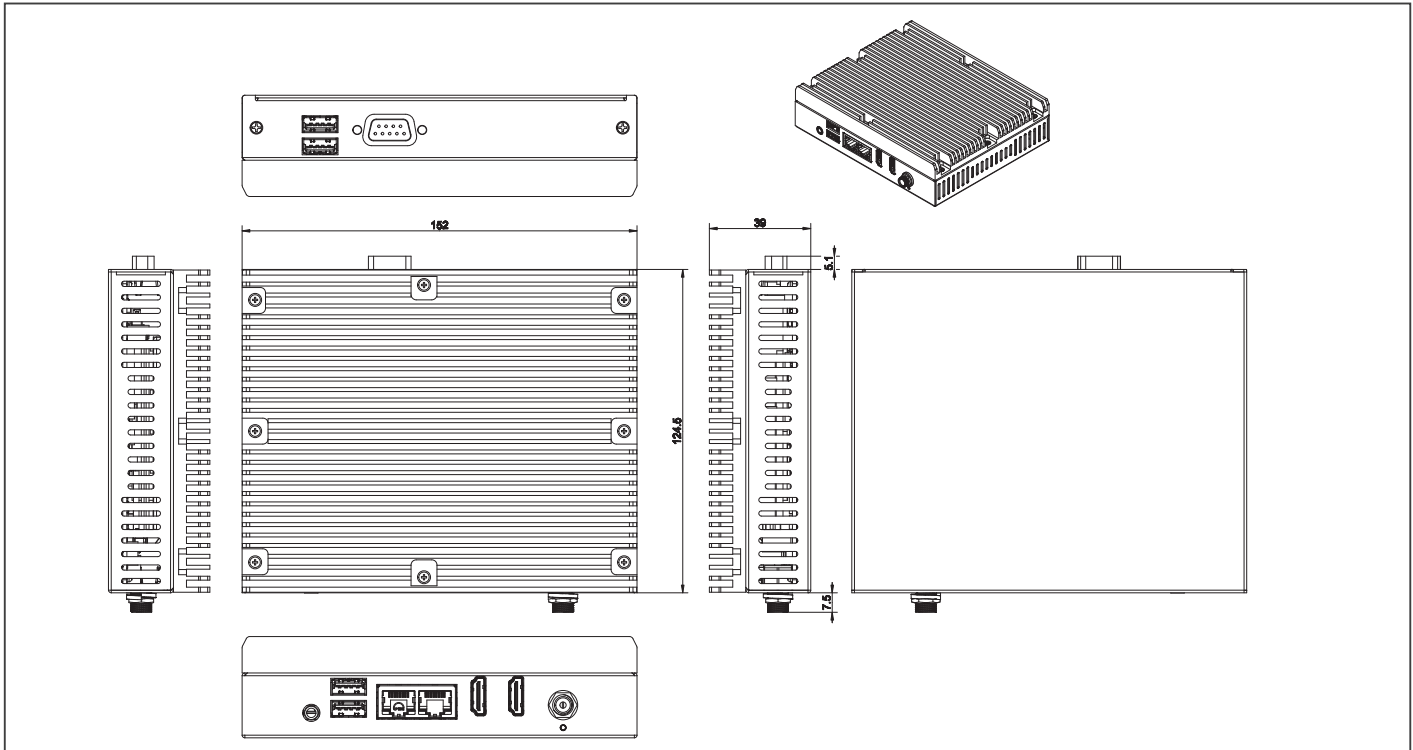

Ordering Information

Part number	CPU	Memory	Storage
ITL-TWL01-A10-STX01	Intel® Processor N150	8GB	64GB

Optional Accessories

Part Number	Description
1255X00032	(TF)AC/DC Adapter.Input AC.100~240V.Output DC.12V.MAX 72W.6.0A.180D.W/ LOCK.EDAC. EA10681U(120)
170X000799	(TF)Power Cord. 3P. 125V. 10A. 180D. USA. 1. 8M. I-SHENG. SP305B/IS-14N SVT 18/3 60C CT-12 Black
170X000800	(TF)Power Cord. 3P. 250V. 10A. VDE. 1. 8M. I-SHENG. SP23/IS-14N H05VV-F 3G 0.75 CT-12 Black
170X000815	(TF)Power Cord. 3P. 250V. 10A. 180D. CHINA. 1. 8M. I-SHENG. SP506A/IS-14N RVV 300/500V 3X0.75 CT-12 Black
170X000806	(TF)Power Cord. 3P. 125V. 7A. 1. 8M. I-SHENG. U4NCB3T6B1218002. SP305B/IS-14N VCTF. Black. BSMI
170X000803	(TF)Power Cord.3P.125V/7A.PSE Certificate.1.8M.I-SHENG.U4NCB3P6C1218002.SP305B/IS-14N VCTF 0.75/3 Black 1.8M
170X000810	(TF)Power Cord.3P.250V.16A.Korea.1.8M.I-SHENG.SP23/IS-14N H05VV-F 3G 0.75 CT-12 Black
170X000805	(TF)Power Cord.3P.250V.10A.SWISS.1.8M.I-SHENG.SP-027C/IS-14N H05VV-F 3G 0.75mm CT-12 Black
9651210000	Wireless LAN Kit M.2 2230 802.11ax/ac/a/b/g/n + BT5.2,2.4G/5G/6G,with 2 sets of cable & antenna (Intel AX210)
9651885200	Wireless LAN Kit M.2 2230 802.11ax/ac/a/b/g/n + BT5.2,2T2R,with 2 sets of cable & antenna (Enli,ENL-8852CE)
UPS-VESAKIT-A10-0000	VESA KIT for UPS-GWS/UPS-EDGE-EHL/UPS-EDGE-ASL/UPS-EDGE-TWL

Packing List

- Intelli STX TWL

09

09

Turn-Key Chassis Solutions



ES France - Mobilité & Systèmes Embarqués
127 rue de Buzenval BP 26 - 92380 Garches



Tél. 01 47 95 99 80



e-mail : mse@es-france.com
Site Web : www.es-france.com

ACS-1U01-BT4

Fanless Solution with Intel® Atom® J1900/ N2807 Processor

Front View

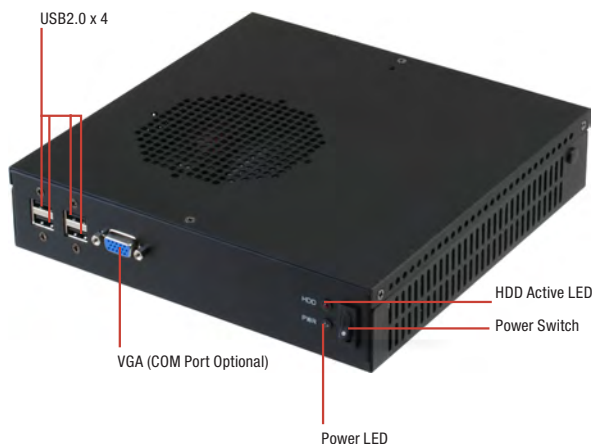

Rear View

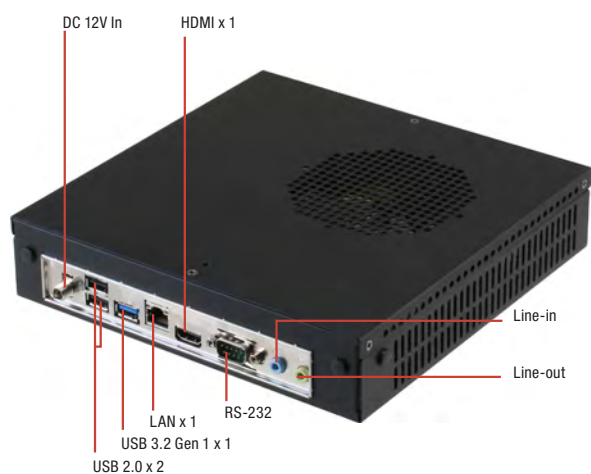

Features

- Intel® Atom® J1900/ N2807 Processor
- DDR3L 1333 SODIMM x 2, Up to 16GB (J1900), DDR3L 1333 SODIMM x 1, Up to 4GB (N2807)
- Dual Independent Display: VGA + HDMI
- Rich IO Supported: USB 3.2 Gen 1 x 1, USB 2.0 x 4~7
- Compact Size, Low Power & Fanless Solution



Specifications

System		
CPU	Intel® Atom® J1900 Processor (4C @ 2.00 GHz CPU, 688/854 MHz GFX, 10W TDP), Intel® Atom™ N2807 Processor (2C @ 1.58 GHz CPU, 313/750 MHz GFX, 4.3W TDP)	
Chipset	—	
System Memory	204-pin SODIMM x 2 up to 8 GB (for J1900) 204-pin SODIMM x 1 up to 4 GB (for N2807) DDR3L 1333 MHz, Non-ECC, un-buffered memory, Dual-channel memory architecture	
I/O Chipset	Fintech 81866D	
Display Interface	Chipset Intel® Graphics Media Accelerator	
	DP VGA x 1, Up to 1920 x 1200 @60 Hz ; HDMI x 1, Up to 1920 x 1200 @60 Hz	
Storage Devices	2.5" HDD, Full-Size Mini-Card (optional)	
Network	LAN Realtek® PCIe Gb LAN 8111G x 1	
I/O		
Front I/O	USB	USB 2.0 port x 4
	Audio	—
	Display	VGA x 1
	Others	On/Off Button x 1, Power LED + HD LED x 1, (COM port optional if not use VGA port)
Rear I/O	USB	USB 3.2 Gen 1/2.0 port x 1, USB 2.0 port x 2
	Audio	Line-out (green) x 1, Line-in (blue) x 1
	Display	HDMI x 1
	LAN	RJ-45 connector x 1
	Power	DC Power x 1
Expansion	Others	RS-232 connector x 1
	Mini PCIe	Full-size Mini-Card (PCIe +USB or mSATA) + SIM Card (mSATA default) x 1, Half-size Mini-Card (PCIe +USB) x 1
	Storage	Full-size Mini-Card slot (mSATA default) x 1, SATA3 (6.0Gb/s) x 1, SATA2 (3.0Gb/s) x 1, SATA power connector x 1
Indicator	Others	RS-232 9-pin int. box header x 1, RS-232/422/485 9-pin box header x 1, 5-pin USB 2.0 header (p=2.00mm) x 2
	Front	Power LED x 1, HDD Active LED x 1
Rear	—	
Power		
Battery	Lithium battery	
Power Requirement	DC: 12V	
Mechanical		
Dimension (WxHxD)	8" x 8" x 1.75" (203.20mm x 203.20mm x 44.45mm)	
VESA Mounting	Wallmount	
Anti-Vibration	0.5 Grms/ 5~ 500Hz/ operation – HDD	
Anti-Shock	10 G peak acceleration (11 msec. duration)	
Environmental		
Operating temperature	32°F ~ 122°F (0°C ~ 50°C)	
Certificate	CE & FCC Class A	
Operating System		
MS Windows	Windows® 7 32/64-bit, Windows® 8.1 32/64-bit	
Linux	Fedora	





Dimension

Unit: mm

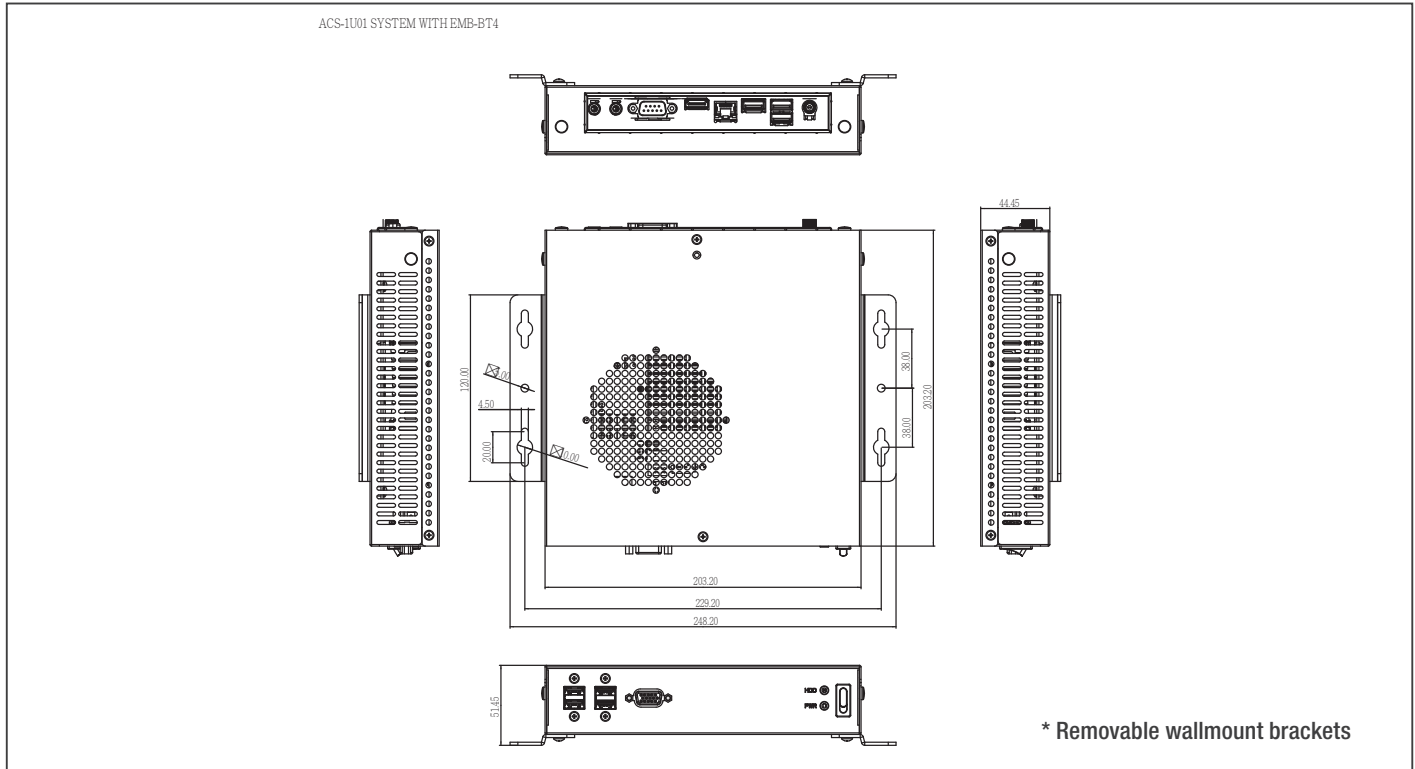

Ordering Information

Part Number	CPU	RAM Module	Display	Cooler	Storage	LAN	USB	Serial Port	Expansion Slot	Power	Mounting
ACS-1U01-BT4-1900-V10	J1900 2.42G/2M	—	VGA x 1 HDMI x 1	Fanless w/ CPU heatsink	2.5" HDD shelf, Full-Size Mini-Card (mSATA) x 1	GbE x 1	USB 3.2 Gen 1 x 1 USB 2.0 x 7	RS-232 x 1, RS-232/422/485 x 1 (W/O VGA)	Half-size Mini-Card x 1 w/o SIM Slot	DC12V	wallmount

Packing List

- Wallmount Kit
- 2.5" HDD tray
- ACS-1U01-BT4 (1U Chassis w/ EMB-BT4)

Optional Accessories

- **1702031802**
Power Cord (US & Taiwan Type)
- **1702031803**
Power Cord (European Type)
- **170203180B**
Power Cord (China Type)
- **170203180E**
Power Cord (Japanese Type)
- **1255300607**
60W Power Adapter

ACS-1U01-H110B

Mini-ITX 1U Chassis with 6th Generation Intel® Processor

Front View

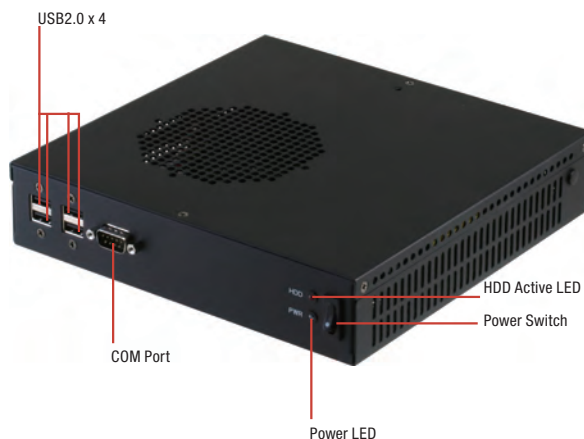

Rear View

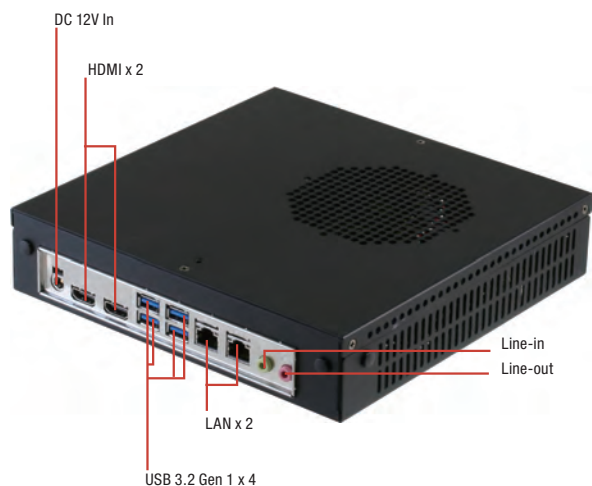

Features

- LGA 1151 Socket For 6th Generation Intel® 14 nm Processor
- Intel® H110
- DDR4 2133/1867 MHz SODIMM x 2, Up to 32GB
- Dual Independent Display: HDMI x 2, BOM Changeable to DP
- Rich IO Supported: USB 3.2 Gen 1 x 4, USB 2.0 x 4
- Compact Size, Low Profile



Specifications

System		
CPU Board	EMB-H110B-A10-HH	
CPU	Intel® Skylake 14nm LGA 1151 socket Processor, Max. 65W TDPs (follow thin mini-ITX)	
Chipset	Intel® H110	
System Memory	2 x SODIMM, Max. 32GB, DDR4 2133/1867 MHz, Non-ECC, Un-buffered	
I/O Chipset	NCT6791D	
Display Interface	Intel® HD Graphics DP(BOM Change, default HDMI): Up to 1920 x 1200 @60Hz, with Digital Audio HDMI: Up to 4096 x 2304 @24Hz / 2560 x 1600 @60Hz, with Digital Audio LVDS: Up to 1920 x 1200 @60Hz, Dual Channel 18/24-bit coloy eDP: Up to 4096 x 2304 @60Hz	
Storage Devices	2.5" HDD x 1, Full-Size Mini-Card(mSATA default, PCIe + USB optional) x 1	
LAN	Realtek® PCIe Gb LAN 8111G x 2	
I/O		
Front I/O Ports	USB 2.0 port x 4 Power S/W x 1 COM port x 1 HDD LED x 1 POWER LED x 1	
Rear I/O Ports	USB 3.2 Gen 1 port x 4 Mic-In (pink) x 1 Line-Out (green) x 1 HDMI x 2 (BOM Changeable to DP) RJ-45 Connector x 2 DC Power jack x 1	
Expansion	Mini PCIe	Half-Size Mini-Card slot (PCIe + USB) x 1, Full-Size Mini-Card (Default mSATA, PCIe + USB optional) x 1
	Storage	Full-size Mini-Card slot (mSATA default) x 1, SATA3(6.0Gb/s) x 1, SATA power connector x 1
	Others	RS-232 9-pin int. box header x 1, RS/232/422/485 9-pin box header x 1, 5-pin USB 2.0 header(p=2.00mm) x 2
Power		
Battery	Lithium battery	
Power Requirement	DC: 12V	
Mechanical		
Dimension (WxHxD)	8" x 8" x 1.75" (203.20mm x 203.20mm x 44.45mm)	
VESA Mounting	Wallmount	
Anti-Vibration	0.5 Grms/ 5~ 500Hz/ operation – HDD	
Anti-Shock	10 G peak acceleration (11 msec. duration)	
Environmental		
Operating temperature	32°F ~ 122°F (0°C ~ 50°C)	
Certificate	CE & FCC Class A	
Operating System		
MS Windows	Windows® 7 32 / 64-bit, Windows® 8.1 32 / 64-bit, Windows® 10 32 / 64-bit	
Linux	Ubuntu 16.04.02/Kernal 4.8.0	





Features

- Supports Low-profile Mini-ITX Motherboard
- Supports 1 x 2.5" Internal HDD Bays
- Supports Wallmount Bracket

Specifications

System	
M/B	Mini-ITX
Dimension (W x D x H)	8" x 8" x 1.75" (203.20mm x 203.20mm x 44.45mm)
Color	Black
Processor Support	TDP < 65W
Drive Bay	2.5" internal HDD bracket x 1
Front I/O	USB 2.0 Port x 4 COM/VGA Port
Button	Power Switch x 1
LED	Power LED x 1 HDD LED x 1
Other	Antenna Hole x 4
Environmental	
Operating temperature	32°F~122°F (0°C~50°C)

Packing List

- Screw Bag
- Wallmount Kit
- SATA 7P Cable
- SATA Power Cable
- USB 2.0 Cable 2.0MM
- USB 2.0 Cable 2.54MM
- COM Cable
- ACS-1U01





ES France - Mobilité & Systèmes Embarqués
127 rue de Buzenval BP 26 - 92380 Garches



Tél. 01 47 95 99 80



e-mail : mse@es-france.com
Site Web : www.es-france.com

10



ES France - Mobilité & Systèmes Embarqués
127 rue de Buzenval BP 26 - 92380 Garches



Tél. 01 47 95 99 80



e-mail : mse@es-france.com
Site Web : www.es-france.com

10

Industrial Chassis



ES France - Mobilité & Systèmes Embarqués
127 rue de Buzenval BP 26 - 92380 Garches



Tél. 01 47 95 99 80



e-mail : mse@es-france.com
Site Web : www.es-france.com

Front View

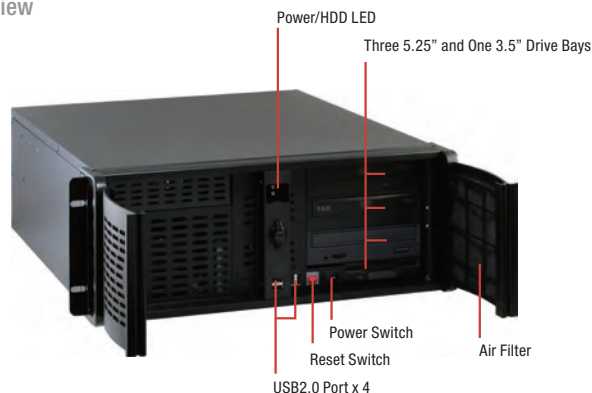

Front View



Top View

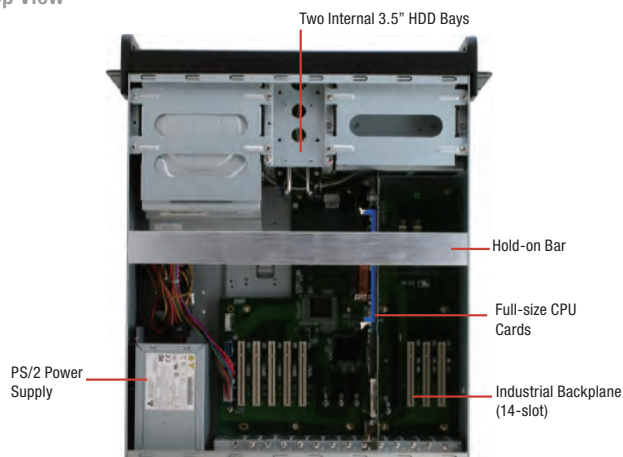

Rear View



Features

- 4U Height 19" Rackmount Chassis
- 14-Slot ISA/ PICMG Bus Passive Backplanes
- Standard PS2 AT/ATX
- 5.25" x 4 and 3.5" x 1 Front Access Drive Bays
- 3.5" x 2 Internal Drive Bays
- Dual Lockable Front Doors For Added Protection
- USB2.0 x 4 On Front Panel



Specifications

System	
Construction	1.2 mm SECC Zinc-coated Steel
Storage	External: 3.5" Drive Bay x 1 5.25" Drive Bay x 4 Internal: 3.5" Drive Bay x 2
System Fan	12 cm Ball Bearing Fan with Removable Filter x 1
Front Panel	Power ON/OFF Switch x 1 Reset Button x 1 Power ON LED x 1 Hard Disk Drive Active LED x 1 USB Port x 4
Rear Panel	AT Keyboard Cut-out x 1 14 Slots (including system slot), supports max. 339 mm (length) for expansion card
Color	Black
Dimensions	19" (W) x 20.8" (D) x 7" (H) (482mm x 528mm x 177mm)
Carton Size	21.6" (W) x 27" (D) x 12.4" (H) (548mm x 685mm x 315mm)
Net Weight	26.4 lb (12 kg)
Gross Weight	30.8 lb (14 kg)
Environmental	
Operating Temperature	32°F ~ 122°F (0°C ~ 50°C)
Storage Temperature	-4°F ~ 176°F (-20°C ~ 80°C)
Storage Humidity	10 ~ 90% @ 40°C, non-condensing
Vibration	0.5 Grms/ 5 ~ 500Hz/ operation (2.5" Hard Disk Drive) 1.5 Grms/ 5 ~ 500Hz/ non operation
Shock	15 G peak acceleration (11 m sec. duration), operation 30 G peak acceleration (11 m sec. duration), non operation
EMC	CE/FCC Class A





Dimension

Unit: mm

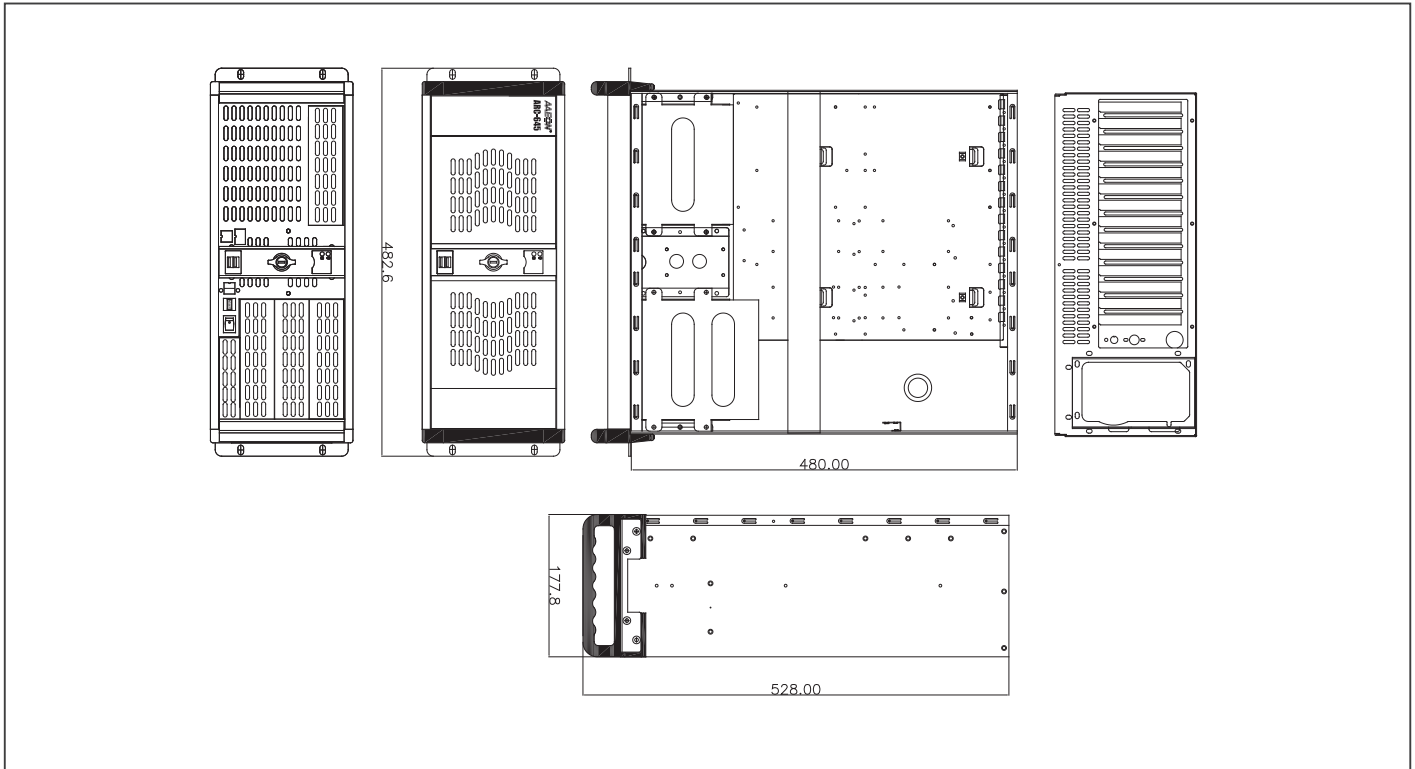

Power Supply Options

P/N	TYPE	PFC Support	Input Voltage	Watt	Size
1255304003	ATX	Active PFC	Auto 90 ~ 264V	400W	PS2
AP-PS1255305000	ATX	Active PFC	Auto 90 ~ 264V	500W	PS2

Passive Backplane Options

P/N	Description	Master Interface	Slots	Power Connector, ATX Extend Function
BP-214SH-P3E2I6	Rackmount, PICMG 1.3, 14-Slot Backplane, 3 PCI, 2 PCI-E, 6 ISA, Single Segment, ATX	PICMG 1.3	3/2/6/2 (PCI/PCI-E/ISA/PICMG 1.3)	ATX
BP-214SH-P8E4	Rackmount, PICMG 1.3, 14-Slot Backplane, 8 PCI, 4 PCI-E, Single Segment, ATX	PICMG 1.3	8/4/2 (PCI/PCI-E/PICMG1.3)	ATX
BP-214SG-P4	Rackmount, PICMG 14-Slot Backplane, 4 PCI/ 8 ISA, Single Segment, AT/ATX, Bulk Pack	PICMG 1.0	4/9/2 (PCI/ ISA/ PICMG)	AT, ATX, 3-pin ATX extend
BP-214SG-P7	Rackmount, PICMG 14-Slot Backplane, 7 PCI/ 5 ISA, Single Segment, AT/ATX, Bulk Pack	PICMG 1.0	7/6/2 (PCI/ ISA/ PICMG)	ATX
BP-214SG-P12	Rackmount, PICMG 14-Slot Backplane, 12 PCI/ 1 ISA, Single Segment, AT/ATX, Bulk Pack	PICMG 1.0	12/1/2 (PCI/ ISA/ PICMG)	AT, ATX, 3-pin ATX extend

CPU Card Options

Model/Name	CPU Level	Master Interface
FSB-B75G	Socket LGA 1155, Intel® 3rd Generation Core™ i3/i5/i7	PICMG 1.0

Ordering Information

Model/Name	Description
TF-ARC-645-B02	Rackmount 4U Chassis, Bare for 14-Slot Backplane, PS2 Power, PS_SW (ATX), Black

CPU Cooler Options

Model/Name	Description
175920000D	LGA1155/1150 CPU Cooler (2U)
1759218000	LGA1155/1150 CPU Cooler (1.5U)
175920000G	LGA775 CPU Cooler
1759200335	LGA775 CPU Cooler



Always Agile, Always Ahead.

MKT-2202601

AAEON Technology Inc.

6F., No. 28, Baogao Rd., Xindian Dist., New Taipei City 231029, Taiwan R.O.C.
Tel: +886-2-8919-1234 Fax: +886-2-8919-1056 E-mail: sales@aaeon.com.tw

LITERATURE ORDERING

Contact your local office for literature requests.

USA

USA

California Office

324 W. Blueridge Ave, Orange, CA 92865
Toll Free: +1-877-TO-AAEON (1-877-862-2366)
TEL: +1-714-996-1800
FAX: +1-714-996-1811
E-mail: sales@aaeon.com
Tech Support: tech@aaeon.com

New Jersey Office

11 Crown Plaza, Hazlet, NJ 07730-2441
TEL: +1-732-203-9300
FAX: +1-732-203-9311
E-mail: sales@aaeon.com
Tech Support: tech@aaeon.com

EUR

Netherlands

AAEON EUROPE

Beatrix de Rijkweg 8, 5657 EG Eindhoven
TEL: +31(0)499-745200
FAX: +31(0)499-462010
E-mail: sales@aaeon.eu

Germany

AAEON Technology GmbH

Monzastrasse 4e, 63225 Langen
TEL: +49(0)61033 74 79 00
FAX: +49(0)61033 74 79 49
E-mail: sales@aaeon.eu

France

AAEON France Office

Gare de Lyon, 37/39 Avenue Ledru-Rollin,
CS 11237, 75012 Paris Cedex 12
TEL: +33 (0) 156 95 16 40
E-mail: sales@aaeon.eu

Italy

AAEON Italy Office

Viale Masini 12/14, 40126 Bologna
TEL: + 39 051 0923582
E-mail: sales@aaeon.eu

ASIA

China

AAEON Technology (Su Zhou) Inc.

Room 12, 2F, Building B, No.5 Xing Han Street,
Suzhou Industrial Park, Jiang Su Province
TEL: +86-512-6762-5700
FAX: +86-512-6761-7337
E-mail: sales@aaeon.com.cn

Shanghai Branch Office

20F, Unit D, GEM Building, No.487 Tianlin Road,
Xuhui District, Shanghai
TEL: +86-21-3367-5511
FAX: +86-21-3367-4238
E-mail: sales@aaeon.com.cn

Beijing Branch Office

Room 710, Tower D, Jiahua Building, No.9,
Shangdi Third Street, Haidian District, Beijing
TEL: +86-10-8278-0904
FAX: +86-10-8278-0214
E-mail: sales@aaeon.com.cn

Wuhan Branch Office

Room 06, 17/ F, Building C, Phase I, Modern International
Design City, Optics Valley Avenue, East Lake New
Technology Development Zone, Wuhan
TEL: +86-027-87003780
E-mail: sales@aaeon.com.cn

China

Chengdu Branch Office

Room 1801/1810, China (Sichuan) ASEAN Free
Trade Cooperation Center, No.1165 Shuangxing
Avenue, Shuangliu District, Chengdu
TEL: +86-028-85120523
E-mail: sales@aaeon.com.cn

Shenzhen Branch Office

518, 5th floor, Guoxin Investment Building,
Gaoxin South Seventh Road,
Nanshan District, Shenzhen
TEL: +86-755-8304-7277
FAX: +86-755-8304-7272
E-mail: sales@aaeon.com.cn

Hangzhou Branch Office

A411 Haichuang Building, No. 1338 Wenyi
West Road, Yuhang District, Hangzhou
TEL: +86-0571-8609-7652
E-mail: sales@aaeon.com.cn

Singapore

AAEON Technology Singapore PTE LTD.

57 Genting Lane, #07-00, Singapore 349564
TEL: +65-6749-8749
FAX: +65-6746-1595
E-mail: sales@aaeon.com.sg



ES France - Mobilité & Systèmes Embarqués
127 rue de Buzenval BP 26 - 92380 Garches



Tél. 01 47 95 99 80



e-mail : mse@es-france.com
Site Web : www.es-france.com