

HL9465 Broadband Z-matched Pick-off Tee (50 GHz)

Key Features and Technical Specifications¹

Bandwidth	DC to 50 GHz, thru and pick-off lines
Insertion Loss	3.5 ± 0.5 dB, thru line 10.5 ± 1 dB, pick-off line See Fig. 1
Amplitude Match (opt. -M only)	± 0.1 dB See Figs. 3-4
Phase Match (opt. -M only)	± 2°, f = 10 GHz ± 5°, f = 20 GHz
Return Loss	< 12.5 dB, f ≤ 35 GHz, thru line < 10 dB, f > 35 GHz, thru line < 20 dB, f ≤ 25 GHz, pick-off line < 15 dB, f > 25 GHz, pick-off line See Fig. 5
Group Delay	≈ 125 ps, thru line (opt. -JJJ) ≈ 115 ps, thru line (opt. -JPJ) ≈ 125 ps, pick-off line (all opts.) See Fig. 2
Connectors	2.4 mm jack, all ports (opt. -JJJ) 2.4 mm jack, Thru 1 and Pick-off; 2.4 mm plug, Thru 2 (opt. -JPJ)
Unit Dimensions	32.69 x 24.23 x 13.59 mm 1.29" x 0.95" x 0.54"
RoHS Compliant	Yes
REACH Compliant	Yes

NOTE 1 - The specification in this table are typical. Full specifications are available on Page 2 of this datasheet.

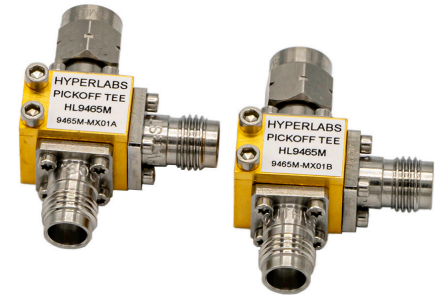

HL9465, option -M-JPJ shown

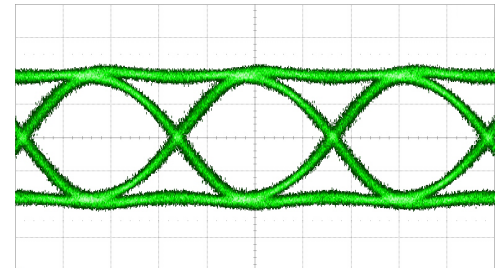

28 Gbps PRBS31 pattern on the Thru Out port of HL9465-JPJ; see also Figs. 7-12

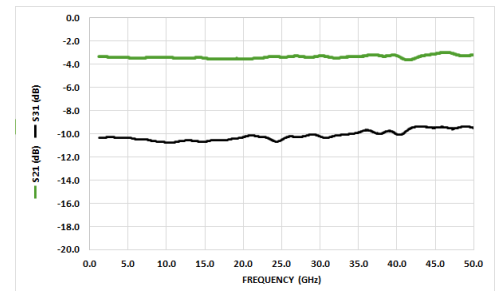

Typical Insertion Loss on thru and pick-off lines of HL9465 (opt. -JPJ); see also Fig. 1

PRODUCT SUMMARY

The HL9465 is an impedance-matched pick-off tee with a flat frequency response from DC to 50 GHz on both the thru and pick-off lines.

It is suitable as a trigger source with minimum perturbation of the thru signal path.

Digital oscilloscope applications include pre-scaler triggering, synchronization, and clock/data recovery.

DEPLOYMENT NOTES

Some of the specifications in this datasheet are only applicable to matched pairs of devices and are labeled accordingly.

S-PARAMETERS

S-parameters are available on our website.

AVAILABLE OPTIONS

The following options and configurations are available for this product:

- M, matched pair
- U, unmatched part(s)

-JJJ, jack (female), all ports

-JPJ, jack (female) thru in and pick-off; plug (male) thru out

DEVICE PORT ASSIGNMENTS

For the purposes of this datasheet, the below port assignments are used.

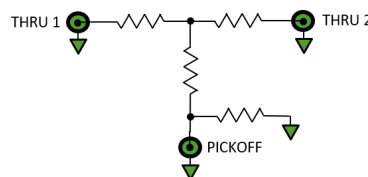



HL9465 Full Specifications

Parameter	Minimum	Typical	Maximum	Comments
Bandwidth		DC to 50 GHz, thru and pick-off		3 dB roll-off point, relative to nominal insertion loss
Insertion Loss		3.5 ± 0.5 dB, thru 10.5 ± 1 dB, pick-off		All options
Amplitude Match		± 0.1 dB		Matched pair (opt. -M) only
Phase Match		± 2.5°, f = 10 GHz ± 5°, f = 20 GHz		Matched pair (opt. -M) only
Return Loss, Thru		< 12.5 dB, f ≤ 35 GHz < 10 dB, f > 35 GHz		
Return Loss, Pick-off		< 20 dB, f ≤ 25 GHz < 15 dB, f > 25 GHz		
Rise Time		7.0 ps, thru and pick-off		
Group Delay		125 ps, thru (opt. -JJ) 115 ps, thru (opt. -JPJ) 125 ps, pick-off (all options)		
Max Input Power		+30 dBm		
Impedance		50 Ω, all ports		
Connectors		2.4 mm jack/jack/jack (opt. -JJJ) 2.4 mm jack/plug/jack (opt. -JPJ)		Thru 1 / Thru 2 / Pick-off
Dimensions (W x D x H)		32.69 x 24.23 x 13.59 mm 1.29" x 0.95" x 0.54"		Single unit (opt. -U)
Weight		13.5 g 0.48 oz		Single unit (opt. -U)
Operating Temperature	-40° C		+85° C	Case temperature
Storage Temperature	-40° C		125° C	
RoHS Compliant	Yes, assembled with lead-free solder			
REACH Compliant	Yes			
Warranty	1 year, repair or replacement; see website for details			



HL9465 Insertion Loss

Figure 1 shows the typical insertion loss of the HL9465 along the thru and pick-off lines from DC to 50 GHz.

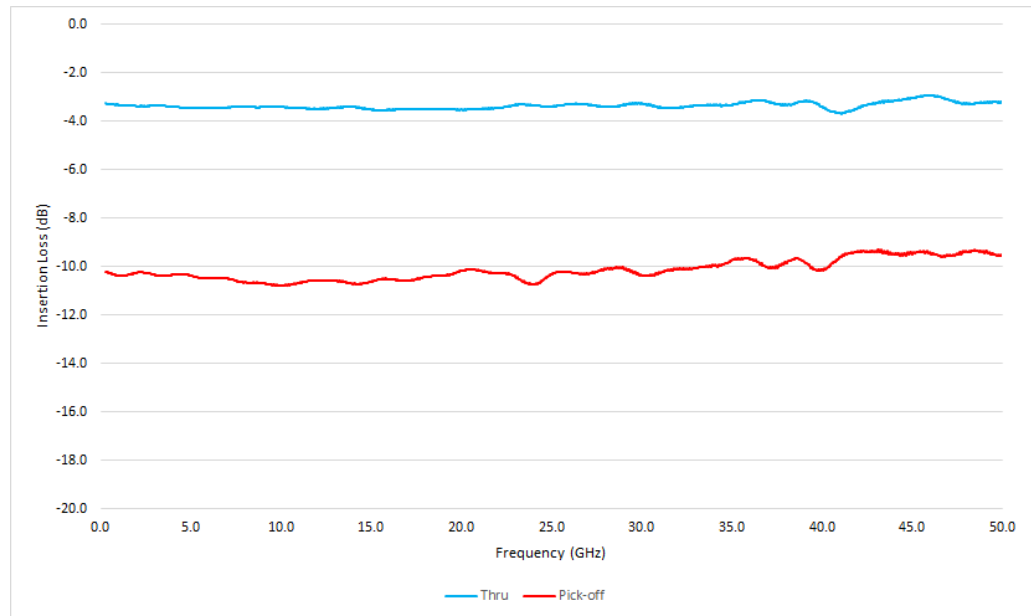

Figure 1: HL9465 Insertion Loss (opt. -JPJ)

HL9465 Group Delay

Figure 2 shows the typical group delay of the HL9465 along the thru and pick-off lines to 50 GHz.

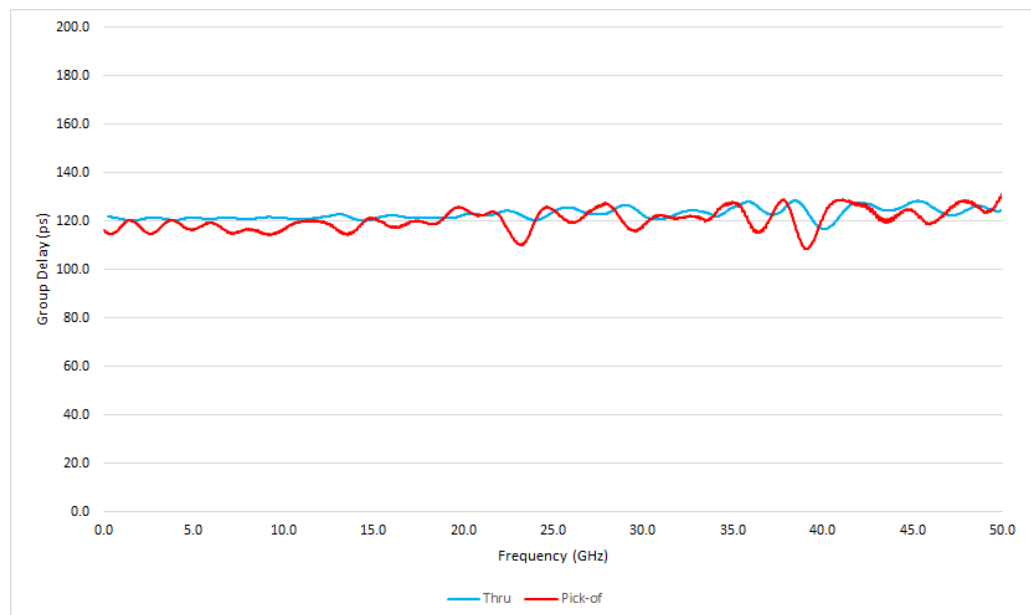

Figure 2: HL9465 Group Delay (opt. -JPJ)

HL9465 Amplitude Match

Figures 3-4 show the amplitude match of two matched HL9465 devices along the thru and pick-off lines, respectively, from DC to 50 GHz.

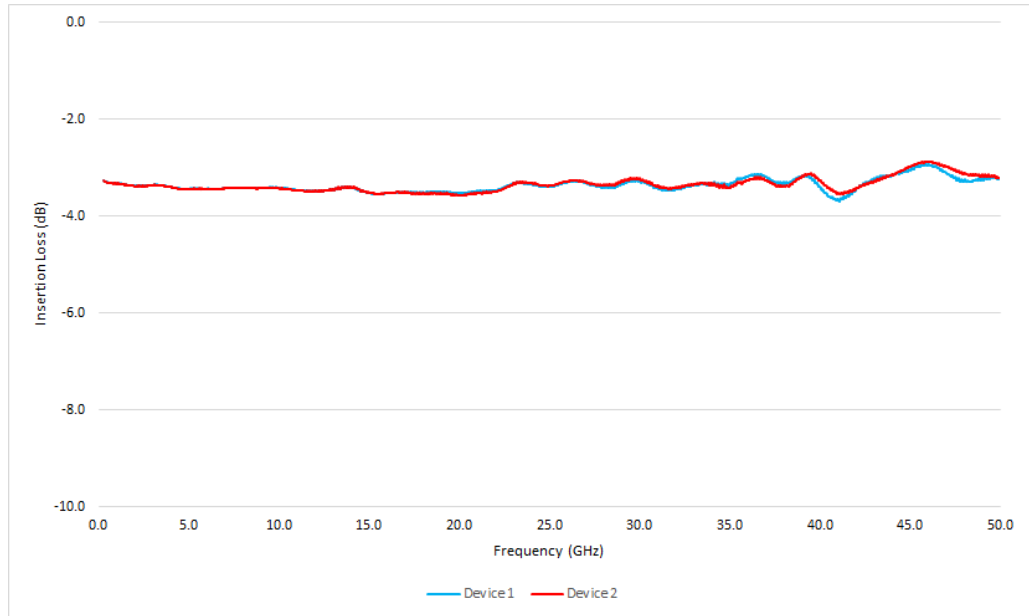

Figure 3: HL9465 Thru Amplitude Match (opt. -M-JPJ)

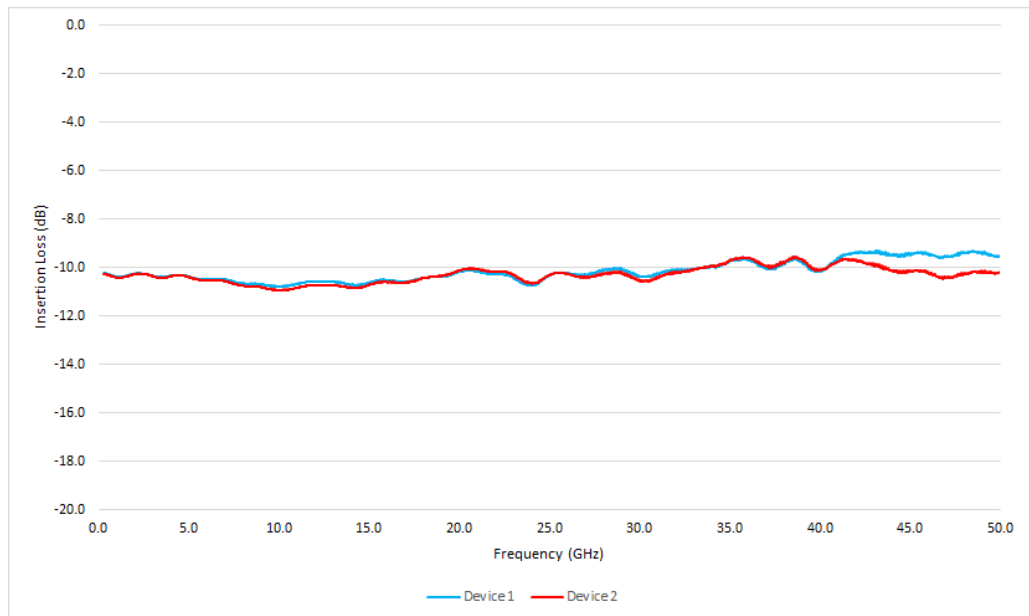

Figure 4: HL9465 Pick-off Amplitude Match (opt. -M-JPJ)

HL9465 Return Loss and VSWR

Figure 5 shows typical return loss on all ports of an HL9465 from DC to 50 GHz. Figure 6 shows the corresponding Voltage Standing Wave Ratio (VSWR).

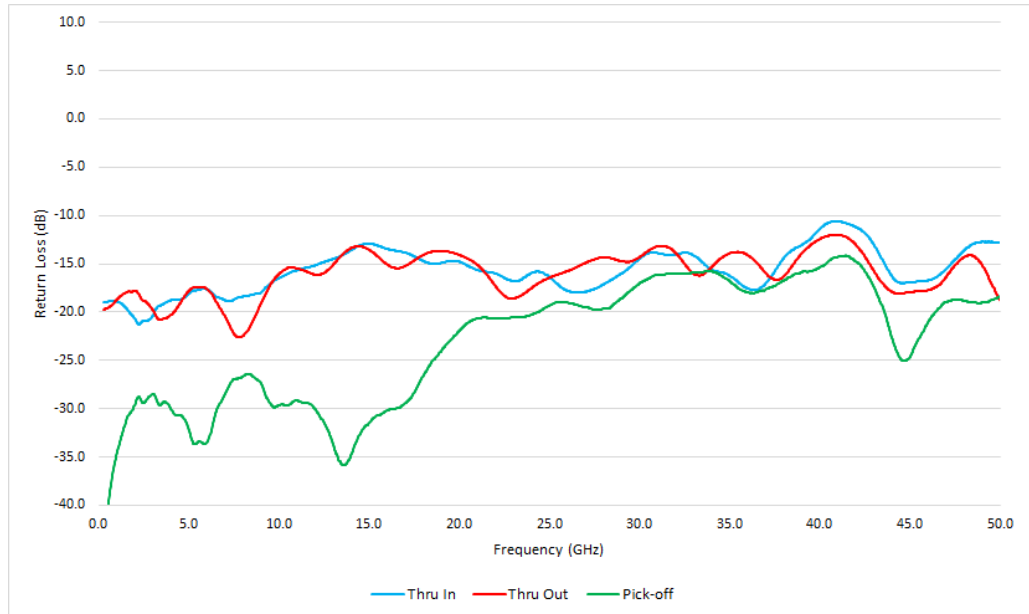

Figure 5: HL9465 Return Loss (opt. -JPJ)

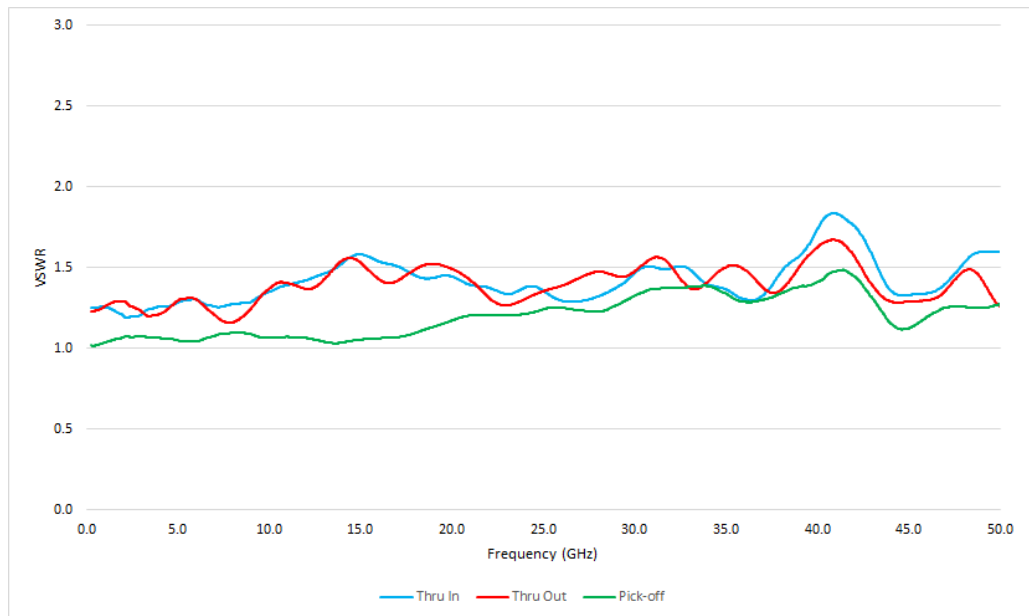

Figure 6: HL9465 VSWR (opt. -JPJ)



HL9465 Eye Diagrams

The eye diagrams in *Figures 7-9* show a PRBS31 pattern at 28 Gbps. The input signal has a 1.53 V amplitude and is shown at 450 mV/div. The thru and pick-off outputs are shown at 275 mV/div.

Figures 10-12 were generated by a PRBS31 pattern at 12.5 Gbps. The input signal has amplitude of 1.49 V and is shown at 450 mV/div. The thru and pick-off outputs are shown at 275 mV/div.

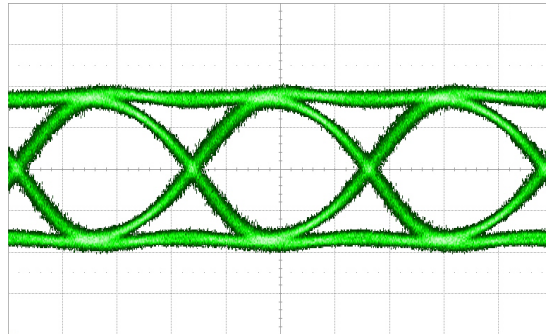

Figure 7: 28 Gbps PRBS31 pattern on RF In

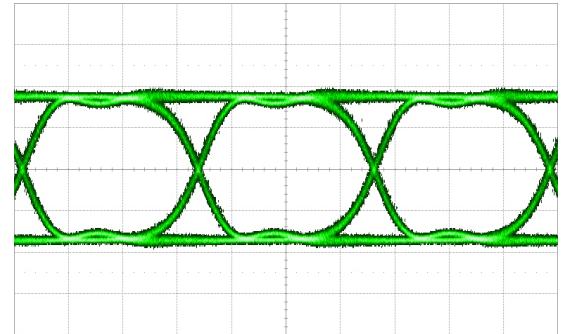

Figure 10: 12.5 Gbps PRBS31 pattern on RF In

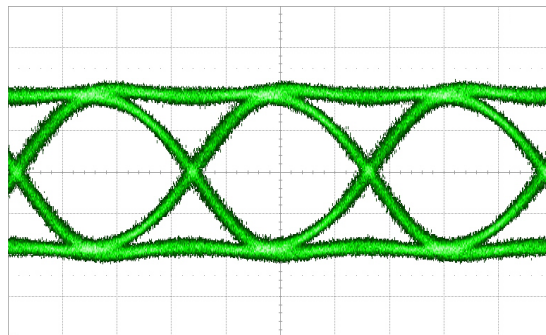

Figure 8: 28 Gbps PRBS31 pattern on Thru Out

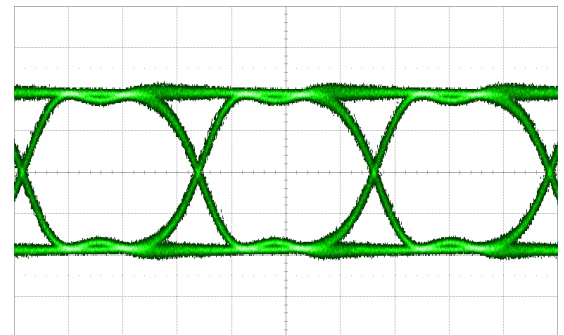

Figure 11: 12.5 Gbps PRBS31 pattern on Thru Out

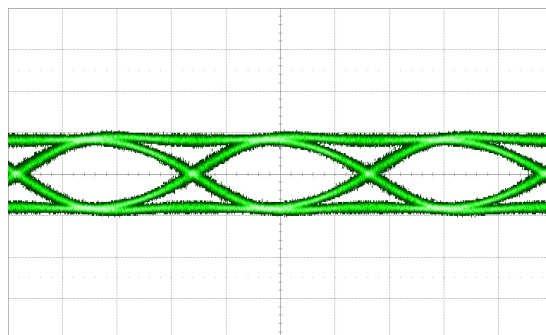

Figure 9: 28 Gbps PRBS31 pattern on Pick-off Out

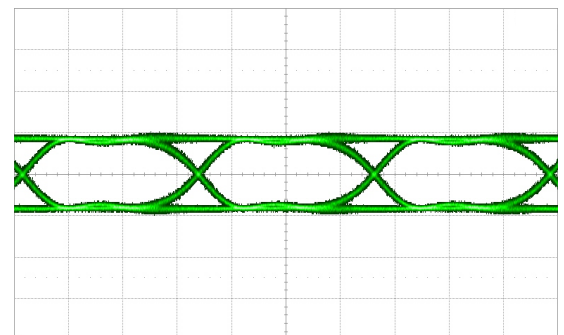

Figure 12: 12.5 Gbps PRBS31 pattern on Pick-off Out



HL9465 Dimensional Drawing

Figure 10 shows a mechanical drawing of an HL9465, option -JPJ. Unless otherwise noted, all units are in inches.

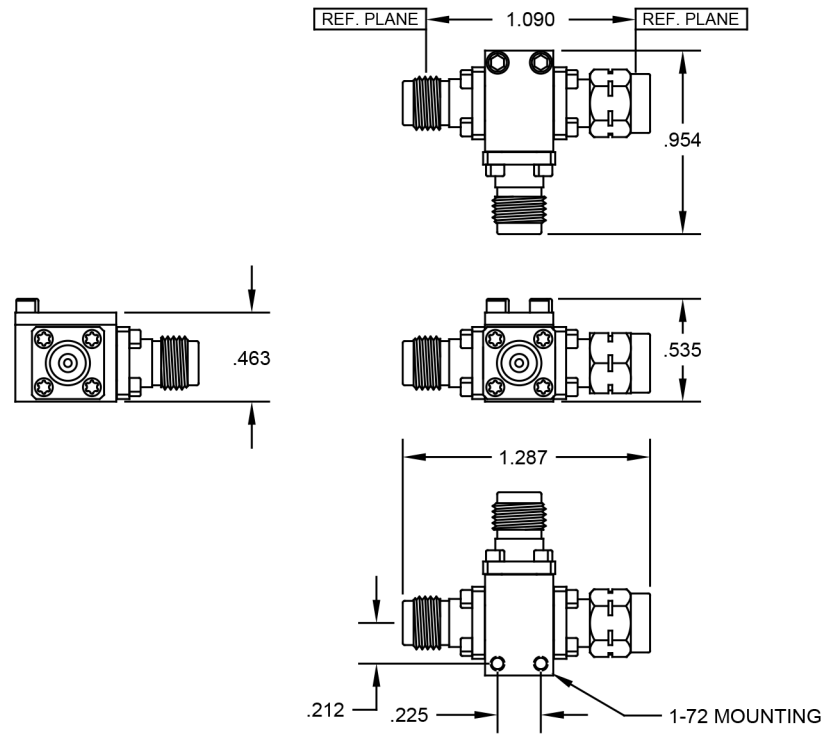

Figure 10: HL9465 mechanical drawing (opt. -JPJ)