

IHC Series, 600-Watt

AC-DC Harsh Environment Industrial Power Supplies



The 600-Watt IHC is a new series of AC-DC harsh environment industrial power supplies. The IHC series is aimed at ruggedized and special applications that require operation in extreme industrial environmental conditions such as, elevators, external road signs, electrolysis equipment, food processing and other outdoor applications.

The product enclosure is an IP67 sealed convection/conduction cooled assembly that can be baseplate mounted to a thermal (cold) plate or natural convection cooled.

Intended for ease of connection, the I/O and signal connectors are ruggedized to allow operation over a wide -40°C to +85°C baseplate operating temperature range.

The output overload protection employs a constant current characteristic that allows use with high transient capacitive and inductive loads found in applications such as motor drives, incandescent lamps, LED drivers and battery charging sources. A BMU/BMS is required if used as a constant current source for Li-ion battery charging.

Safety

- Safety acc. to IEC/EN/UL 62368-1 (pending)
- CE Marking to LVD 2014/35/EU

Features

- Universal AC input 100 to 240Vac
- Single 12V, 24V and 48V output
- -5%/+15% output voltage adjustment
- Delivers up to 600W conduction cooled, no fan at +85°C max
- High efficiency of 95%
- Active PFC meets EN61000-3-2 class A
- Active inrush current protection
- DC output via studs; AC input and signals each via circular connectors
- Droop characteristic current sharing
- True zero load output operation; no minimum load requirement
- MTBF exceeds 1.4M hours (Telcordia SR-332, Issue 3, M1C3, +40°C).
- RoHS3 Directive 2015/863 compliant
- Five-year standard warranty

Mechanical

- Compact high-density design with excellent thermal performance
- IP67
- Overall dimensions (excluding connectors and mounting feature):
- 233.7mm x 128.1mm x 39.9mm, 9.20" x 5.04" x 1.57"

Table of Contents

Operational Overview.....	2
Electrical Characteristics	3
Current Limit Curve	4
Output Power Derating Curve	6
EMI Performance	7

Voltage Adjustment Resistor Values	9
Typical Performance	
ACS12.600IHC (12Vout model)	11
ACS24.600IHC (24Vout model)	13
ACS48.600IHC (48Vout model)	15
Mechanical Data	17
Shipping Information	19



IHC Series, 600-Watt

AC-DC Harsh Environment Industrial Power Supplies

Operational Overview

Input			Output			Efficiency	Ripple & Noise	Regulation	Capacitive Load	Model Number
Vin Range (VAC)	No Load (mA)	Max Load (Arms)	Vo Nom (VDC)	Io Max (A)	Po Max (W)	Typical at Max Load 230 VAC (%)	Typical (mVp-p)	Transient Max (%)	Max. C External (μ F)	
90 - 264	15	8	12	50	600	95.5	120	\pm 5	6000	ACS12.600IHC
90 - 264	15	8	12	50	600	95.5	120	\pm 5	6000	ACS12.600IHC-R
90 - 264	15	8	24	25	600	95	240	\pm 5	1200	ACS24.600IHC
90 - 264	15	8	24	25	600	95	240	\pm 5	1200	ACS24.600IHC-R
90 - 264	15	8	48	12.5	600	93.5	480	\pm 5	500	ACS48.600IHC
90 - 264	15	8	48	12.5	600	93.5	480	\pm 5	500	ACS48.600IHC-R

Optional ORing function available for redundancy.

Add "-R" to the part number when ordering. ie. ACS12.600IHC-R.

Electrical Characteristics

General Conditions: All specifications are at full load with nominal input and output voltage and $T_A + 25^\circ\text{C}$ unless otherwise noted.

Input Characteristics					
Parameter	Conditions	Min	Nom	Max	Units
Input voltage AC Operating Range	Single Phase	90	100-240	264	Vac
Input Frequency		47	50/60	63	Hz
AC Source Voltage	Input Start Up Threshold	75		90	Vac
	Input Shutdown Threshold	65		80	Vac
Maximum input current	$V_{in} = 90\text{VAC}$; Full Load (600W FL)			8.0	Arms
Inrush Current	230Vac,			40	Apk
Power Factor	At 115/230Vac. 100% load	0.95			W/VA
Hold-up Time	90Vac; 600W	16			msec
Typical Efficiency of IHC Models	Full Load; 230Vac		95		%
No Load Input Current	Output on, $I_{out} = 0$ (burst mode)		0.100	0.15	A

Output Characteristics (All Models Except Where Noted)					
Parameter	Conditions	Min	Nom	Max	Units
Overall Regulation	Main Output ¹			± 5	%
Output Adjustment		-5		+15	
Minimum Load Capability	Stable Operation	0			A
Output Ripple	10% Load to Full Load ^{2,3}			1%	mVP-P
Load Capacitance	ACS12.600IHC			6000	μF
	ACS24.600IHC			1200	
	ACS48.600IHC			500	
Transient Response ³	50% load step, (25-75%) 1A/ μsec slew rate and min 10% load			± 5	%
Settling Time	Settling Time to 1% of Nominal		2		msec
Turn on Delay	After application of input power, PS_ON enabled, 90Vac Full Load			1	sec
Output Voltage Rise	From PS_ON enable; AC source present		500		msec

1 Overall regulation includes "droop" regulation over the zero to full load range; initial setting, line regulation, and temperature drift; output adjustment is a percentage of the nominal set voltage.

2 Ripple and noise are measured with 0.1 μF ceramic capacitor and 10 μF tantalum capacitor. A short coaxial cable with 50 Ohm termination is used. When load is less than 10% of full load, ripple and noise may increase up to 5% mVp-p.

3 Requires 1 second minimum time between consecutive transients and requires 10% minimum load.

Protection Characteristics					
Parameter	Conditions	Min	Nom	Max	Units
Over Voltage Protection	Output latching (re-cycle AC input)	120		135	%
Overload and Short Circuit Protection	Constant Current	105		120	%Amax
Over Temperature Protection	Baseplate temperature		90		$^\circ\text{C}$

Current Limit Curve

The Constant Current characteristic of the 12V model is shown in the following curve below. This feature enables the 600W IHC-series converter to effectively start into any application demanding large inrush current, including motors, solenoids, large capacitive loads, incandescent lamps, etc.

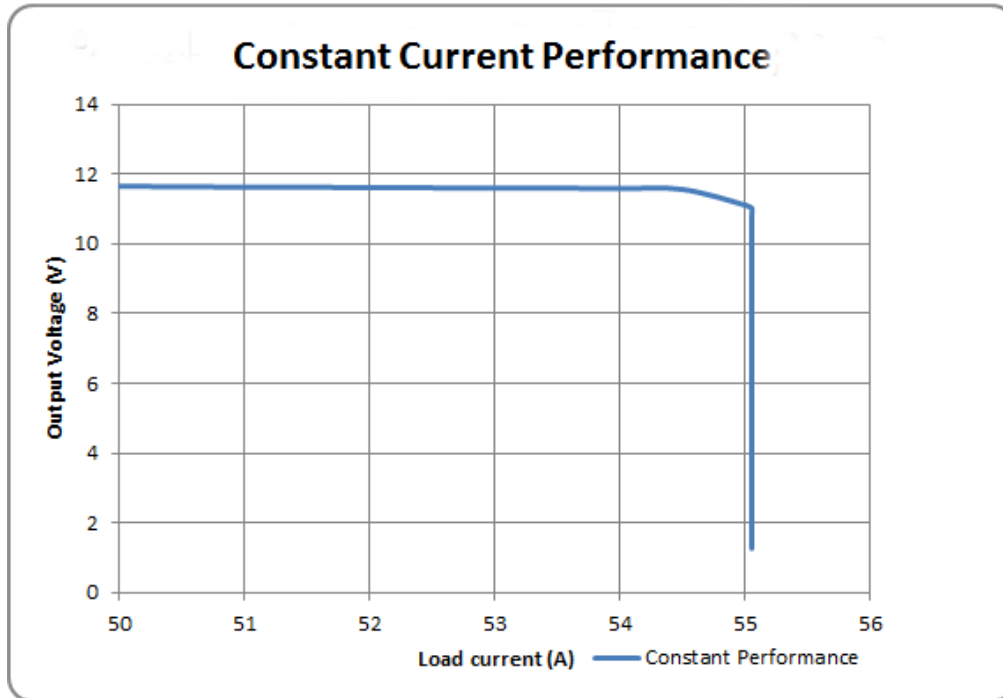

- Notes:
1. The above curve demonstrates the characteristics of the ACS12.600IHC by loading the output with an incremental load current above its rated full load capability (constant resistance equivalent to $\sim 0.5A_{dc}$ increments; converter in Constant Voltage, CV operation).
 2. If the load resistance is further decreased, the resultant current will remain constant. The constant current overload remains within the demonstrated limit, irrespective of the adjustment of VNOM
 3. The End User must rate all parts interconnection in their system in accordance to this constant current (CC) mode.



IHC Series, 600-Watt

AC-DC Harsh Environment Industrial Power Supplies

Environmental Characteristics					
Parameter	Conditions	Min	Typ.	Max	Units
Storage Temperature Range	Up to 10000m	-40		85	°C
Operating Baseplate Temperature Range	No Derating with AC Line Voltage see curves below	-40		85	°C
	Start up; At 100Vac minimum input	-40		85	°C
Operating Humidity	IEC 60068-2-30; +25°C to 55°C: relative humidity	10		93	%
Operating Altitude		-200		5000	m
MTBF	Telcordia SR-332 Issue 3; M1C3 @ 40°C		1.4M		Hours
Shock	IEC 60068-2-27, Test, 30g, 11msec, Half-sine 3 shocks per axis 6 axis				Complies
Operational Vibration	IEC 60068-2-64; Sine sweep; 5-150Hz, 2g; Random vibration, 5-500Hz, 1.11g				Complies
Safety – Audio/video, equip. for information and communication technology	IEC/EN/UL62368-1 CE Marking per LVD 2014/35/EU				
Ingress Protection Rating	IP67				
Fuses	Single (Line) Fuse; 12.5A; Fast Acting; 250V (Non-Replaceable Internal)				
Outside Dimensions	233.7mm x 128.1mm x 39.9mm (9.20" x 5.04" x 1.57")				
Weight (typ.)	1.85 / 4.08				kg / lbs.

Isolation Characteristics					
Parameter	Conditions	Min	Typ	Max	Units
Isolation test voltage	Primary to Chassis	2500			Vdc
	Primary to Secondary	4242			
	Secondary to Chassis	1500			
Earth Leakage Current (Under Normal Conditions)	264Vac, 60Hz, 25°C	--	3	3.5	mA

Current Sharing Droop Feature and ORing Option	
Model Number	Description
Refer to ACAN-xx for additional details	<p>Output current sharing is achieved by the “droop” method. The nominal output voltage is set at 50% load and the output voltage increases/decreases ±3% approx. with change in load current. This does not include any tolerance for line, temp., long-term stability etc.</p> <p>Startup of two (or more) power supplies in parallel is not internally synchronized. If the total combined output power exceeds 600W, external synchronization must be provided by the system using a common PS_ON signal.</p> <p>To compensate for a ±10% full load current sharing accuracy, as well as for the output voltage droop reduction, the total combined output power must be reduced/derated by at least 15% for a reliable parallel operation.</p> <p>ORing Option: The option with ORING protection is recommended, especially for redundant operation (see Application notes, ACAN-xx for additional details); consult factory for details.</p>



Output Power Derating Curve

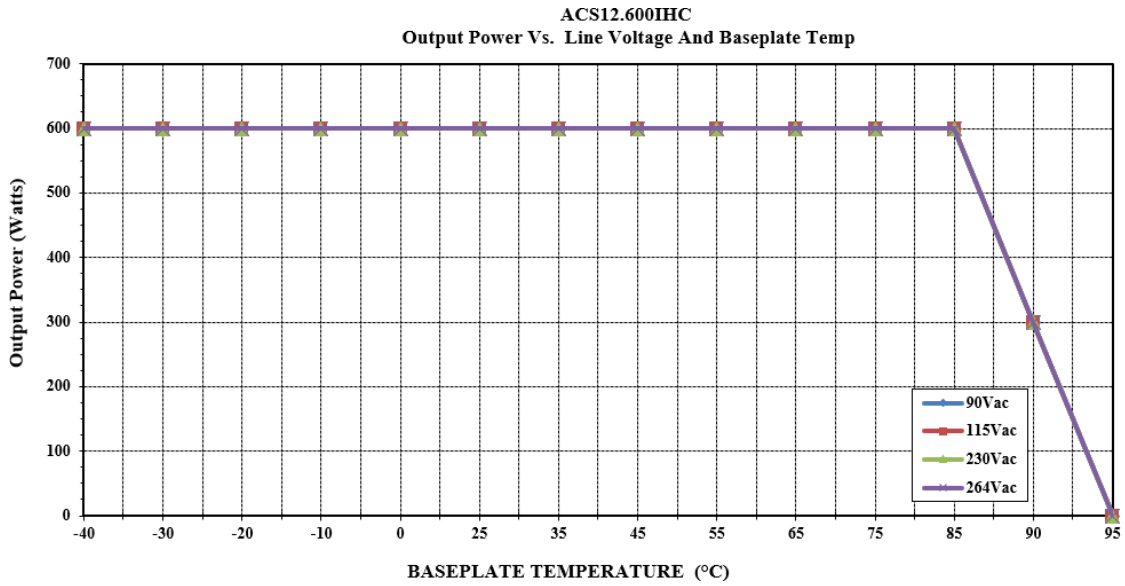

EMI Performance

Emissions and Immunity		
Characteristic	Standard	Compliance
Input Current Harmonics	IEC/EN 61000-3-2	Class A Limits apply
Voltage Fluctuation and Flicker	IEC/EN 61000-3-3	Complies
Conducted Emissions	EN 55032	Class B
	FCC Part 15	
Radiated Emissions	CISPR 22 – 3 meters	Class A
	FCC 15.109 – 3 meters	
ESD Immunity	IEC/EN 61000-4-2	±8kV Contact, ±15kV air discharge, Criteria A performance
Radiated Field Immunity	IEC/EN 61000-4-3	10V/m, 1kHz, 80% AM, 80MHz to 1GHz Criteria A
Electrical Fast Transient Immunity	IEC/EN 61000-4-4	2kV; 100kHz repetition, Criteria A Performance
Surge Immunity	IEC/EN 61000-4-5	Common Mode: 2kV 12 Ohm, Diff. Mode: 1kV, 20Ohm), 1.2/50µs (8/20µs), Criteria A Performance
Radiated Field Conducted Immunity	IEC/EN 61000-4-6	Level 3, 10V/m, Criteria A Performance
Magnetic Field Immunity	IEC/EN 61000-4-8	Level 3, Criterion A
Voltage dips, interruptions	IEC/EN 61000-4-11	Level 3; Criteria A performance for all dips @230Vac input. Criteria B performance for voltage interruptions.

Typical conducted EMI for ASC24.600IHC at 230Vac in, 24A output load, PK (blue) and AV (brown):

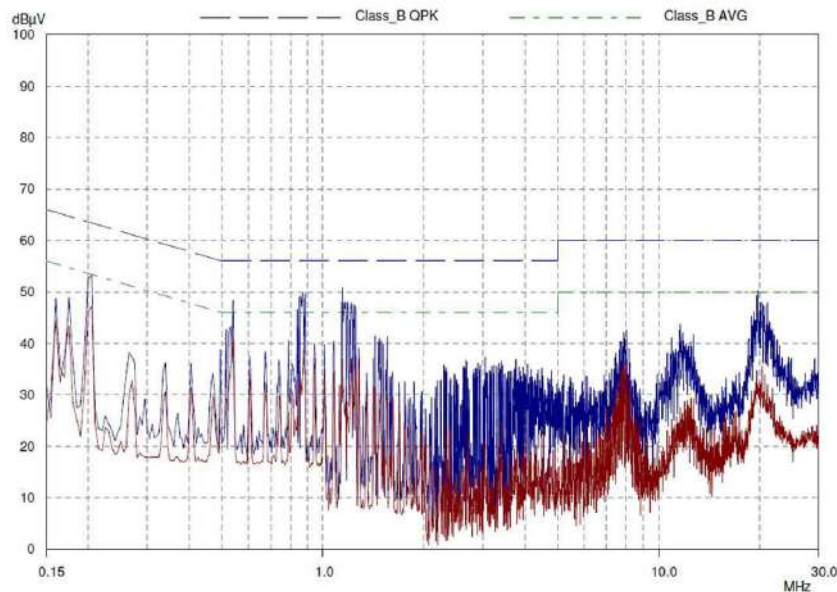

Status and Control Signals		
Parameter	Connector and Pin Assignment	Operating conditions
AC_OK	J2 Pin 1	The signal output is and uncommitted opto- isolated bi-polar transistor. The transistor is driven "on" (saturated) when the incoming AC source is available and within acceptable limits.
AC_OK_GND	J2 Pin 2	The transistor is driven "off" to indicate loss (or out of range) of the incoming AC source. There shall be a minimum of 0.5ms pre- warning time prior to the DC output falling out of regulation limits. An external pull up/pull down resistor is required (deployment is End User dependent). The maximum allowable sink current is 2mAdc and the maximum open circuit voltage is 20Vdc.
PS_ON	J2 Pin 6	The PS_ON signal is intended to turn on (enable)/turn off (disable) the Main DC output. The default is that the signal is unterminated; in this condition, the Main Output shall turn on when the incoming AC source is applied. Conversely if it is required to turn "off" (disable) the Main output the PS_ON shall be pulled low, The signal is internally pulled up to 3.3Vdc via a 3.3Kohm resistor (sink current 1mA) to SGND.
SGND	J2 Pin 4	Connection to signal ground within power module to provide return for PS_ON signals and trim function
TRIM_UP	J2 Pin 3	Providing trim up function by connecting external resistor between TRIM pin and TRIM_UP pin
TRIM	J2 Pin 5	An analogue DC input from a fixed external resistor that shall "adjust" the Main Output within the range of VNOM -5% to VNOM+15%. The external resistor connected between TRIM pin and TRIM_UP pin to adjust the Main Output within the range VNOM to VNOM+15%; The external resistor connected between TRIM pin to SGND pin to adjust the Main Output within the range VNOM -5% to VNOM; The external resistor value shall vary according to the following table to achieve the adjustment range:

Voltage Adjustment Resistor Values

Trim Down:

Use this equation for an external TRIM resistor at J2 connector to decrease VNOM:

$$R_{dn}(x) = \frac{-240 \cdot x + 15.5}{0.2 + 48 \cdot x} \cdot 10^3$$

Trim Up:

Use this equation for an external TRIM resistor at J2 connector to increase VNOM:

$$R_{up}(x) = \frac{V_{out} - 8 \cdot x - 1.75}{0.2 + 16 \cdot x} \cdot 10^4 - 20 \times 10^3$$

Note: Vout is the desired output voltage. It is 11.4V min (12V model), 22.8V min (24V model), and 45.6V min (48V model) for decreasing Vout. It is 13.8V max (12V model), 27.6V max (24V model), and 55.2V max (48V model) for increasing Vout. "x" = Is the desired output voltage delta value (i.e. 0 to 0.05 for decreasing Vout and 0 to 0.15 for increasing Vout).

Typical Trim Resistor Value for ACS12.600IHC

IHC; TYPICAL RESISTOR "TRIM DOWN" VALUES; 50% FULL LOAD														
Trim Ratio (%)	0.00	-0.21	-0.63	-1.04	-1.46	-1.88	-2.29	-2.71	-3.13	-3.54	-3.96	-4.38	-4.79	-5.00
Ideal VOUT(V)	12.00	11.98	11.93	11.88	11.83	11.78	11.73	11.68	11.63	11.58	11.53	11.48	11.43	11.40
R_TRIM (kΩ)	77.50	50.00	28.00	18.57	13.33	10.00	7.69	6.00	4.71	3.68	2.86	2.17	1.60	1.35
IHC; TYPICAL RESISTOR "TRIM UP" VALUES; 50% FULL LOAD														
Trim Ratio (%)	0	0.63	1.88	3.13	4.38	5.63	6.88	8.13	9.38	10.63	11.88	13.13	14.38	15.00
Ideal VOUT(V)	12.00	12.08	12.23	12.38	12.53	12.68	12.83	12.98	13.13	13.28	13.43	13.58	13.73	13.80
R_TRIM (kΩ)	492.50	322.50	186.50	128.21	95.83	75.23	60.96	50.50	42.50	36.18	31.07	26.85	23.30	21.73

Typical Trim Resistor Value for ACS24.600IHC

IHC; TYPICAL RESISTOR "TRIM DOWN" VALUES; 50% FULL LOAD														
Trim Ratio (%)	0.00	-0.21	-0.63	-1.04	-1.46	-1.88	-2.29	-2.71	-3.13	-3.54	-3.96	-4.38	-4.79	-5.00
Ideal VOUT(V)	24.00	23.95	23.85	23.75	23.65	23.55	23.45	23.35	23.25	23.15	23.05	22.95	22.85	22.80
R_TRIM (kΩ)	77.50	50.00	28.00	18.57	13.33	10.00	7.69	6.00	4.71	3.68	2.86	2.17	1.60	1.35
IHC; TYPICAL RESISTOR "TRIM UP" VALUES; 50% FULL LOAD														
Trim Ratio (%)	0.00	0.63	1.88	3.13	4.38	5.63	6.88	8.13	9.38	10.63	11.88	13.13	14.38	15.00
Ideal VOUT(V)	24.00	24.15	24.45	24.75	25.05	25.35	25.65	25.95	26.25	26.55	26.85	27.15	27.45	27.60
R_TRIM (kΩ)	1092.5	725.0	431.0	305.0	235.0	190.45	159.62	137.0	119.71	106.05	95.0	85.87	78.20	74.81



IHC Series, 600-Watt

AC-DC Harsh Environment Industrial Power Supplies

Typical Trim Resistor Value for ACS48.600IHC

IHC; TYPICAL RESISTOR "TRIM DOWN" VALUES; 50% FULL LOAD														
Trim Ratio (%)	0.00	-0.21	-0.63	-1.04	-1.46	-1.88	-2.29	-2.71	-3.13	-3.54	-3.96	-4.38	-4.79	-5.00
Ideal VOUT(V)	48.00	47.90	47.70	47.50	47.30	47.10	46.90	46.70	46.50	46.30	46.10	45.90	45.70	45.60
R_TRIM (kΩ)	77.50	50.00	28.00	18.57	13.33	10.00	7.69	6.00	4.71	3.68	2.86	2.17	1.60	1.35
IHC; TYPICAL RESISTOR "TRIM UP" VALUES; 50% FULL LOAD														
Trim Ratio (%)	0.00	0.63	1.88	3.13	4.38	5.63	6.88	8.13	9.38	10.63	11.88	13.13	14.38	15.00
Ideal VOUT(V)	48.00	48.30	48.90	49.50	50.10	50.70	51.30	51.90	52.50	53.10	53.70	54.30	54.90	55.20
R_TRIM (kΩ)	2292.5	1530.0	920.0	658.6	513.3	420.9	356.9	310.0	274.1	245.8	222.9	204.0	188.0	181.0



ACS12.600IHC Typical Performance (12Vout model)

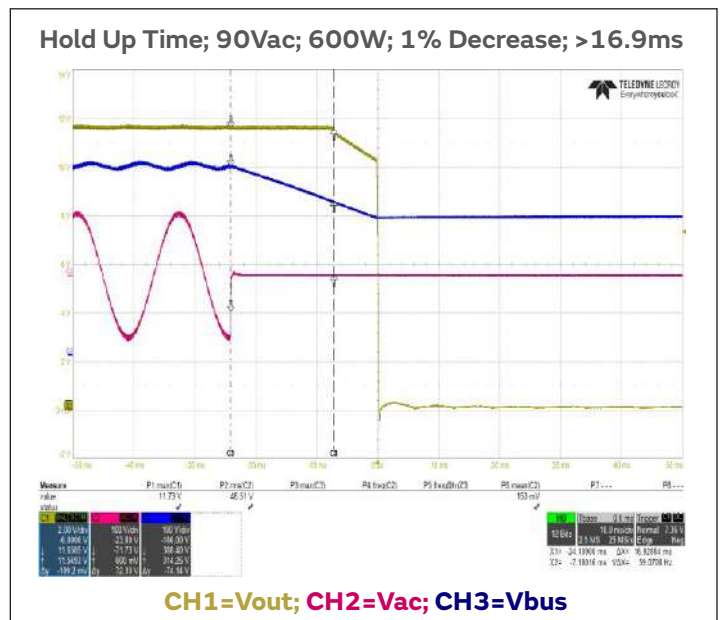
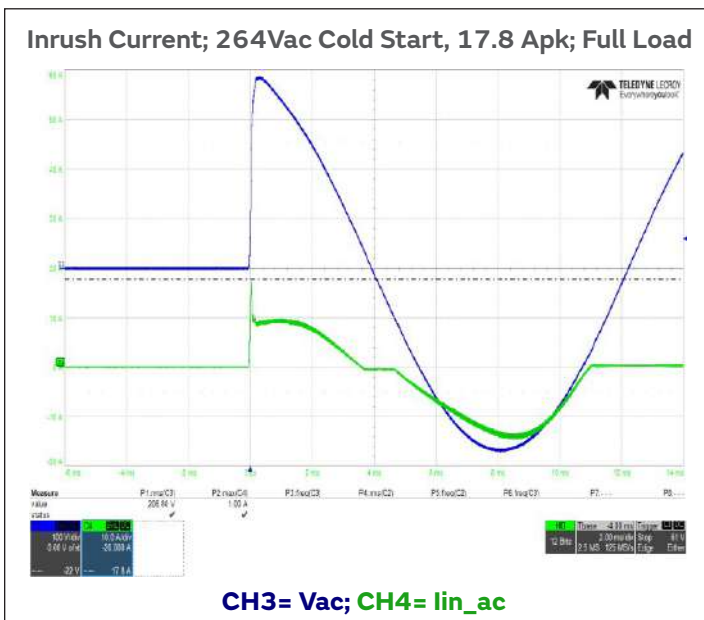
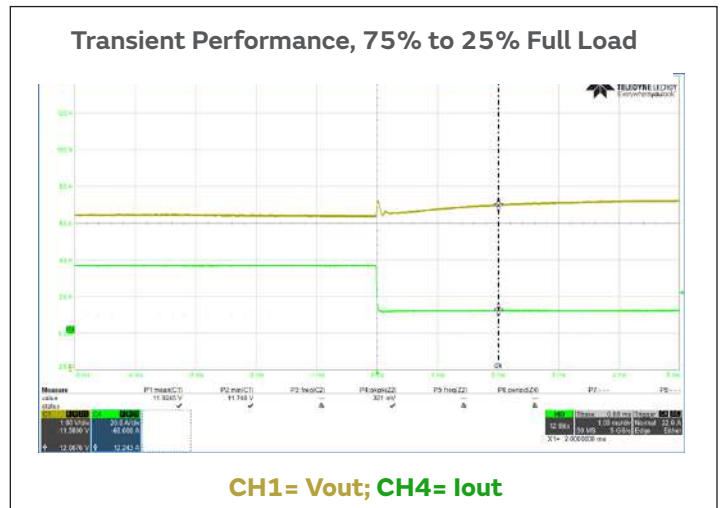
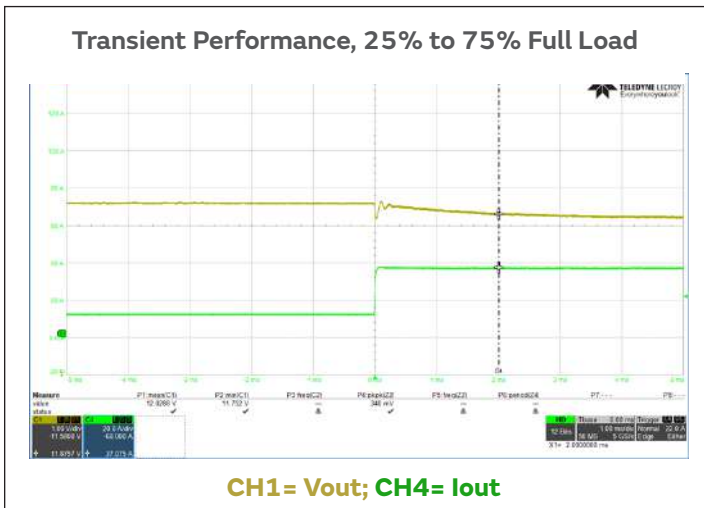
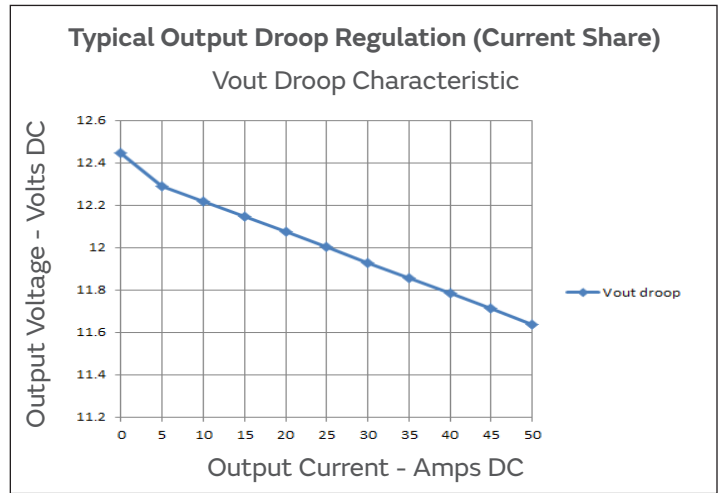
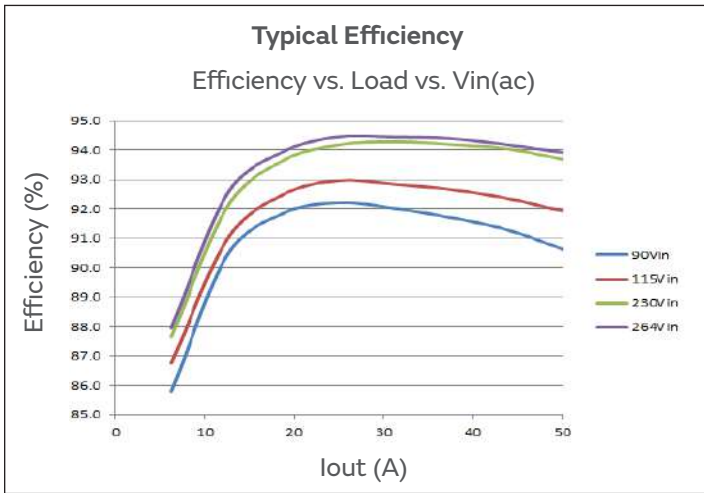

ACS12.600IHC Typical Performance (12Vout cont.)

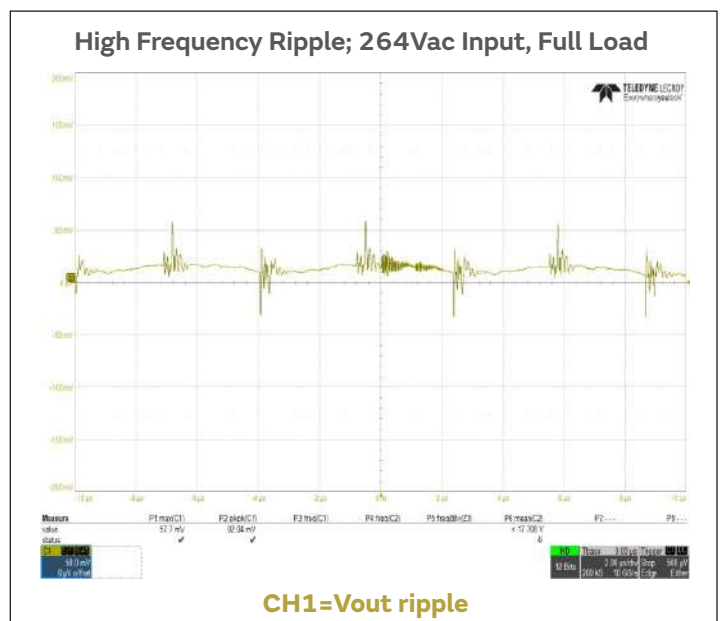
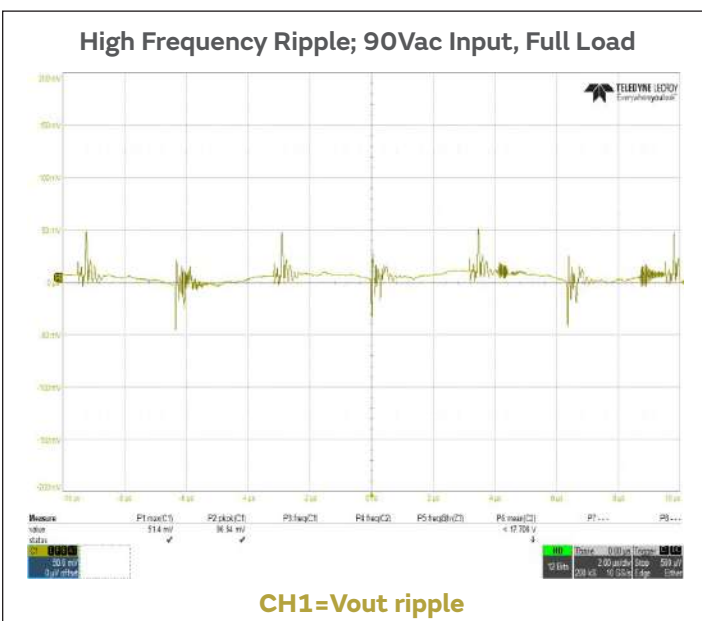
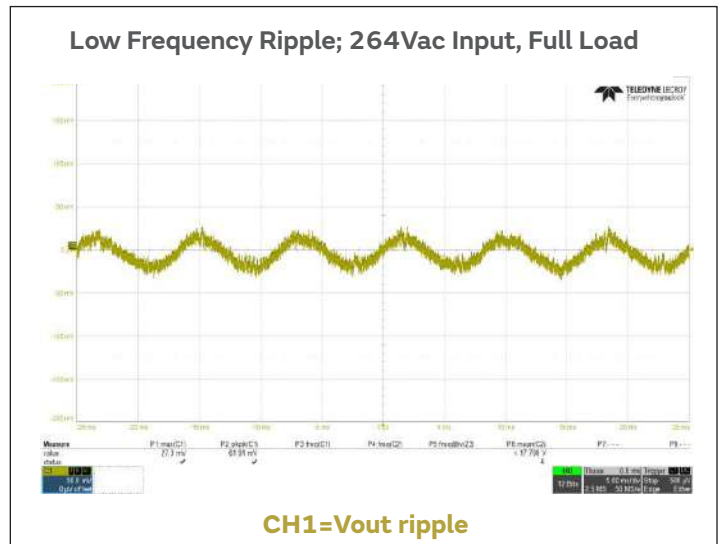
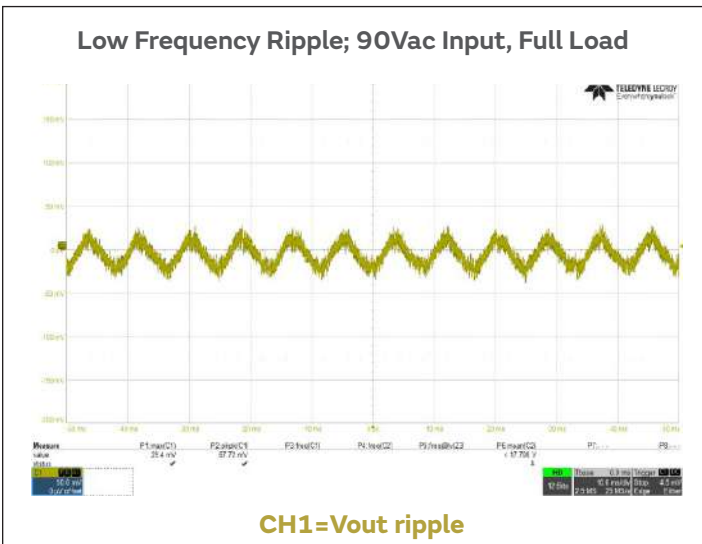
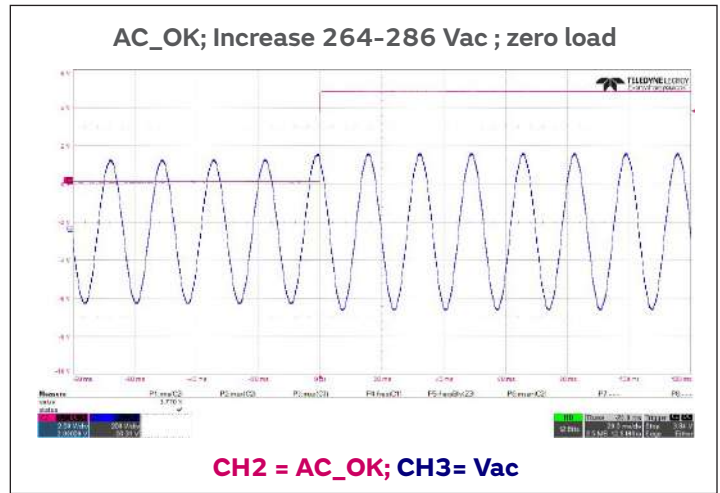
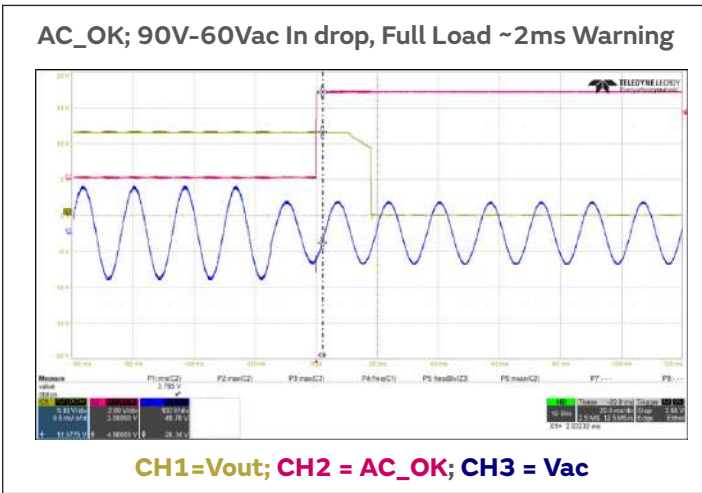

ACS24.600IHC Typical Performance (24Vout model)

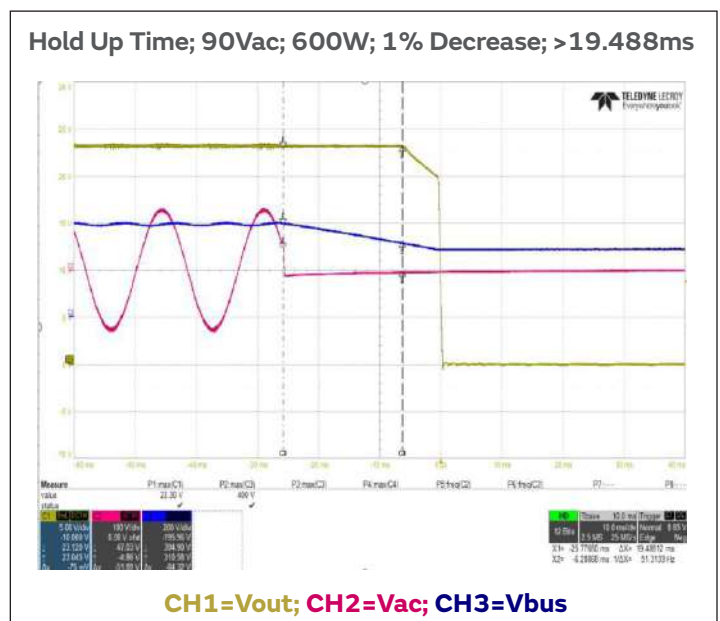
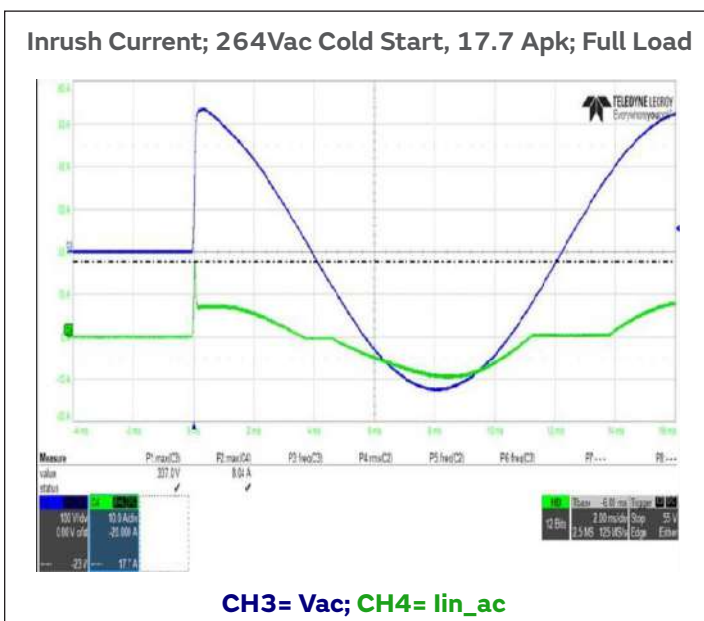
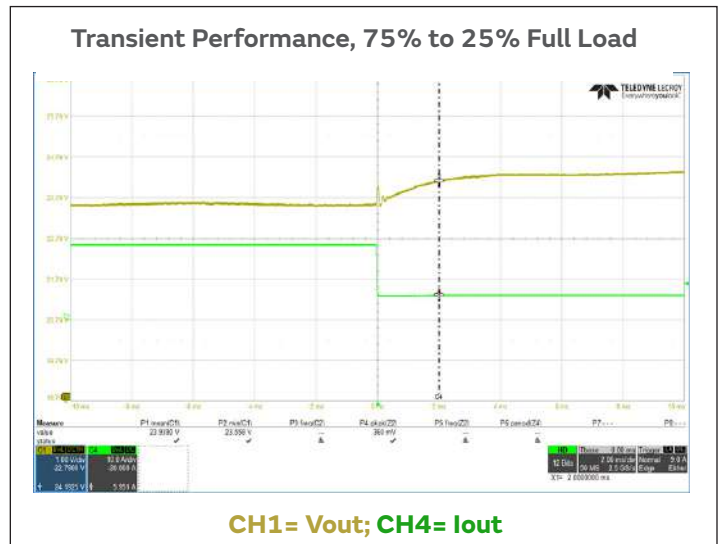
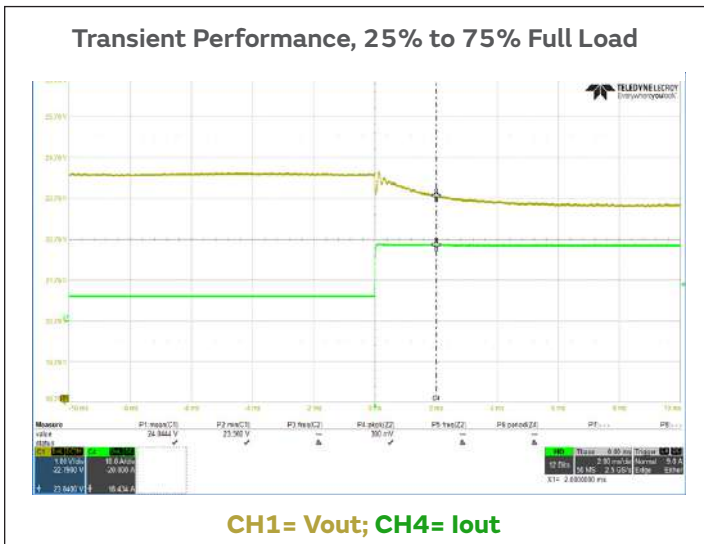
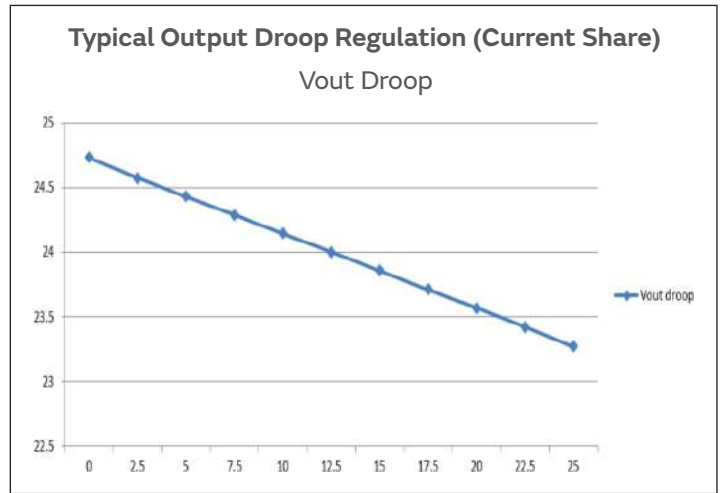
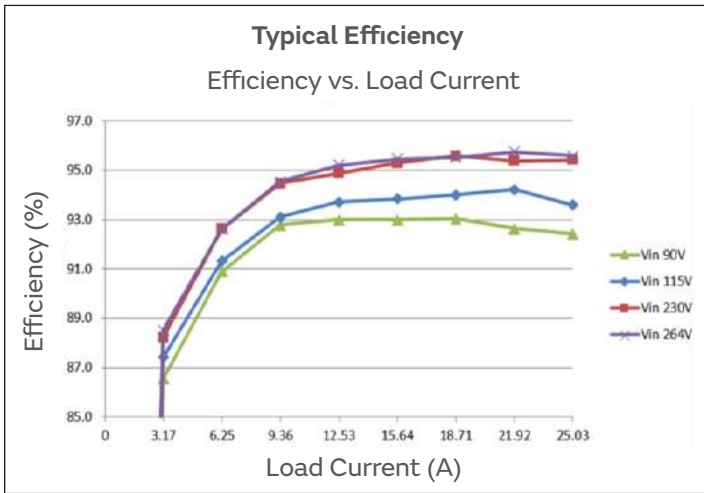

ACS24.600IHC Typical Performance (24Vout cont.)

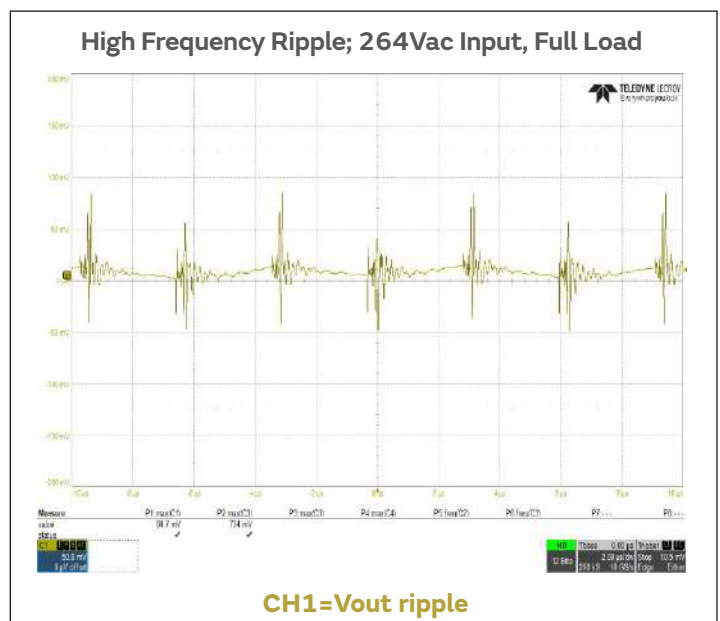
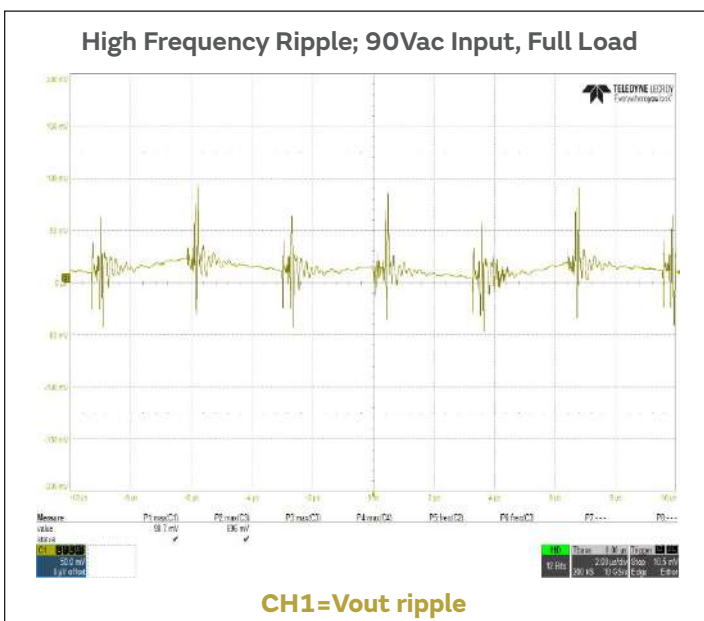
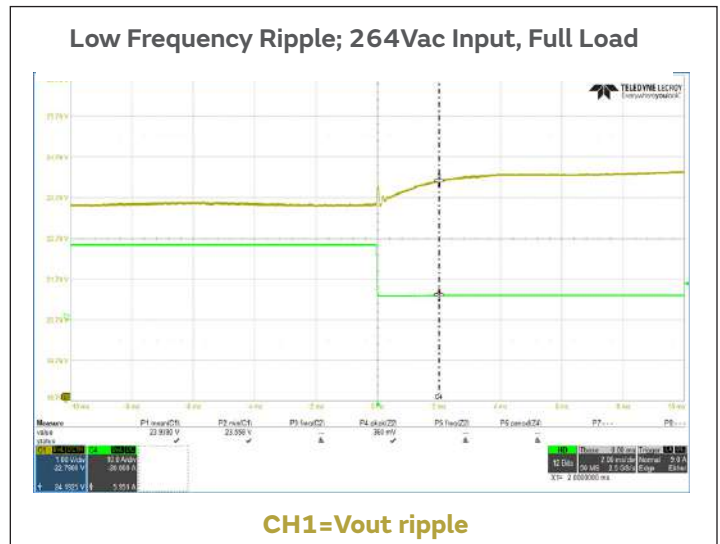
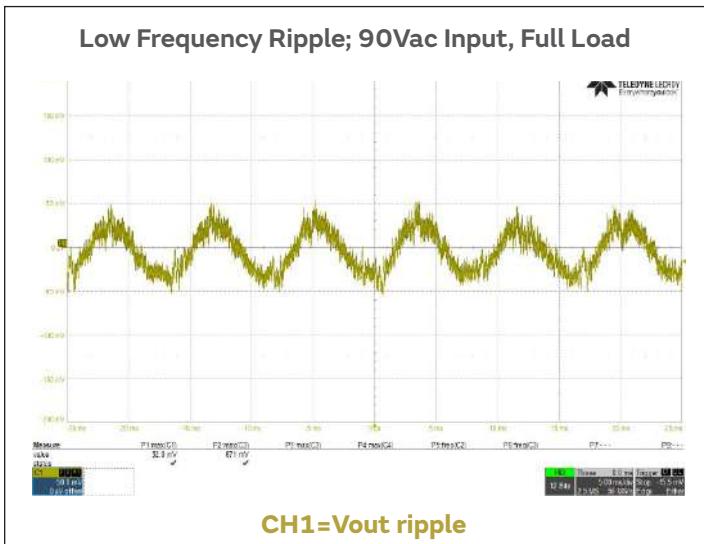
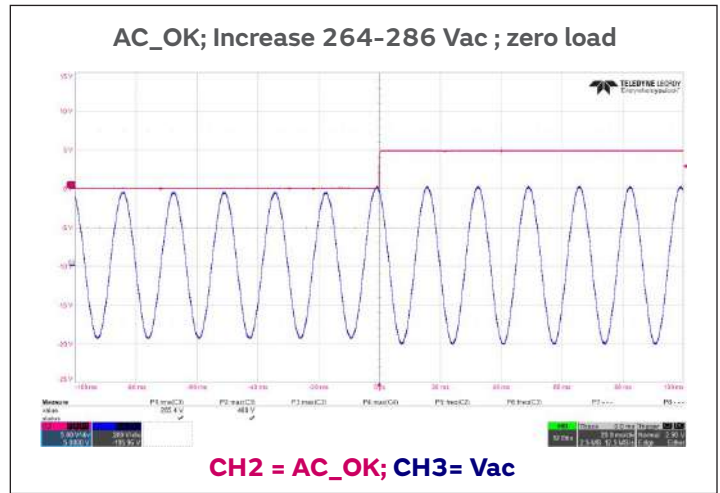
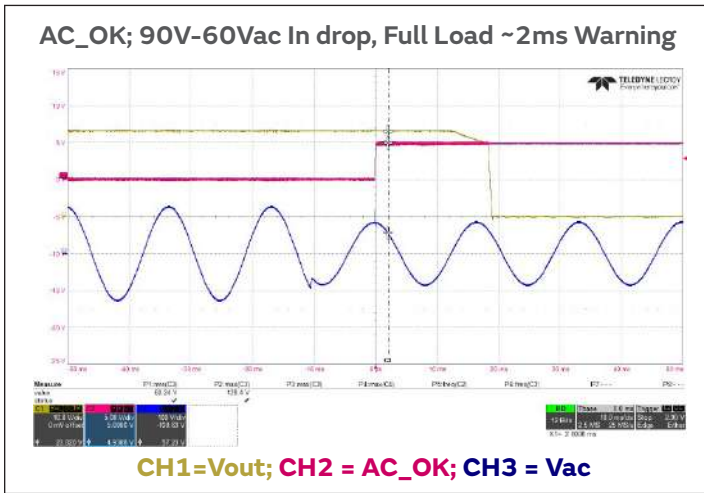

ACS48.600IHC Typical Performance (48Vout model)

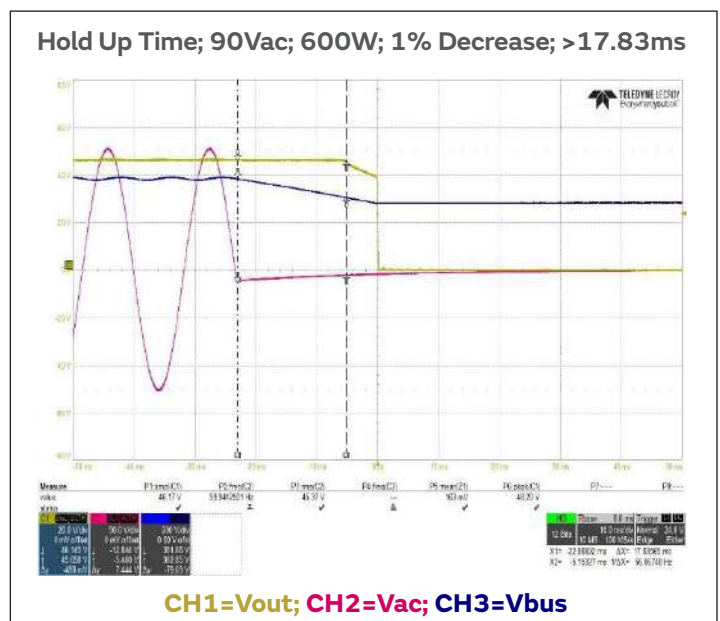
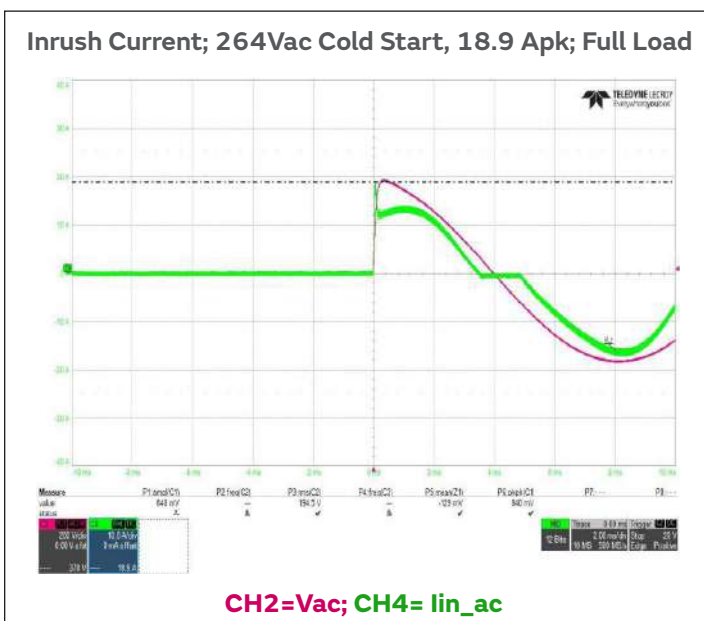
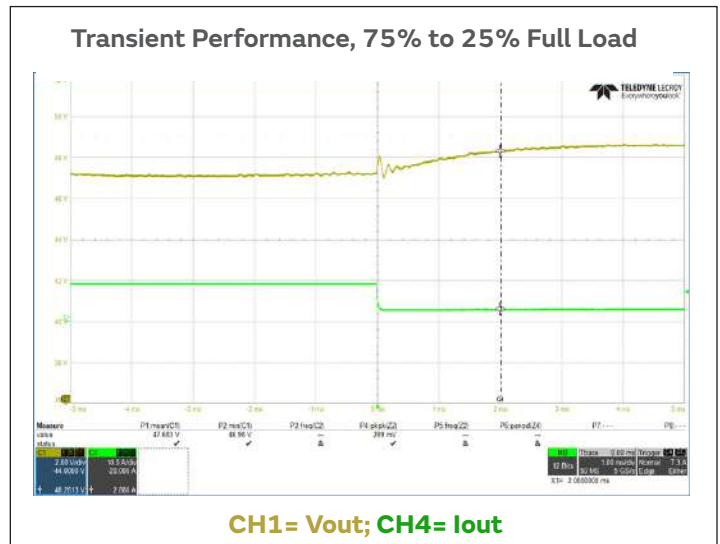
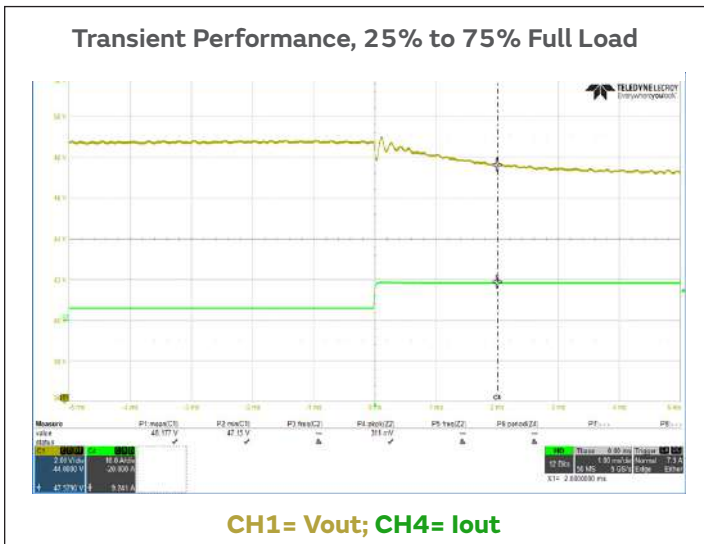
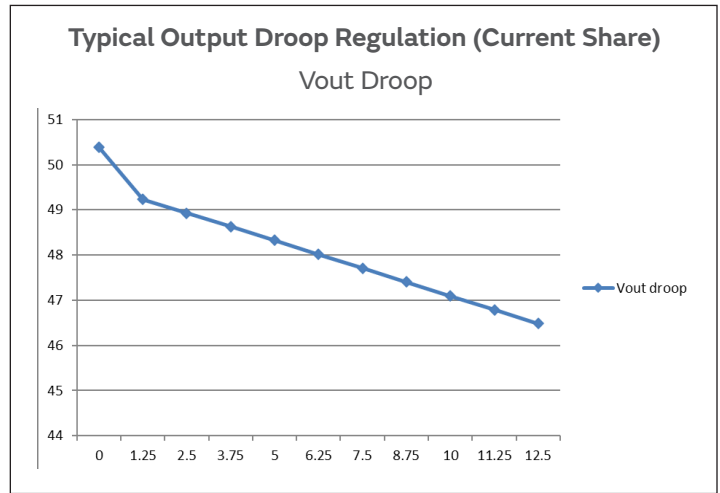
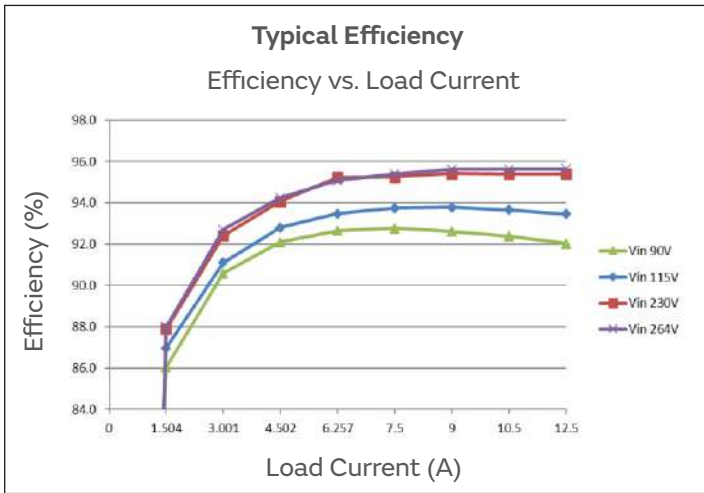

ACS48.600IHC Typical Performance (48Vout cont.)

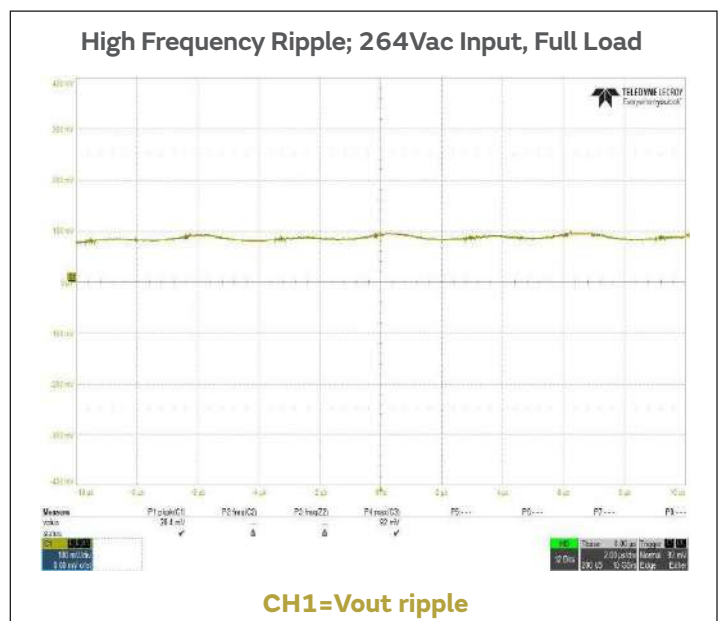
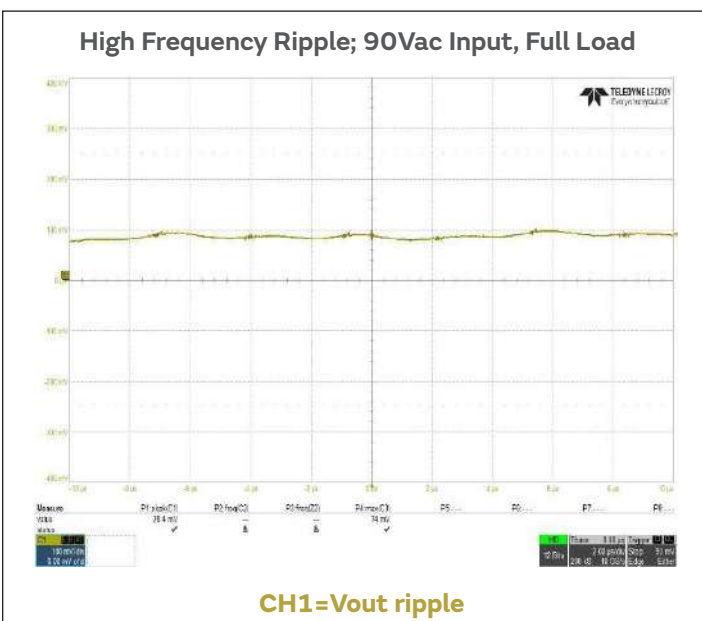
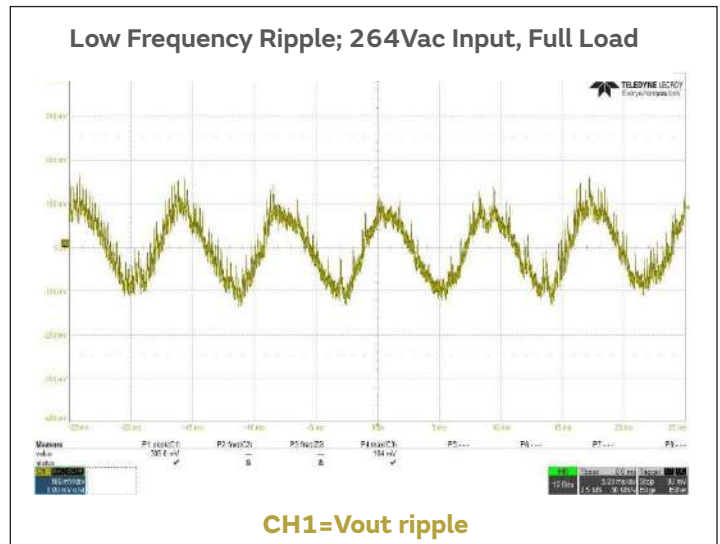
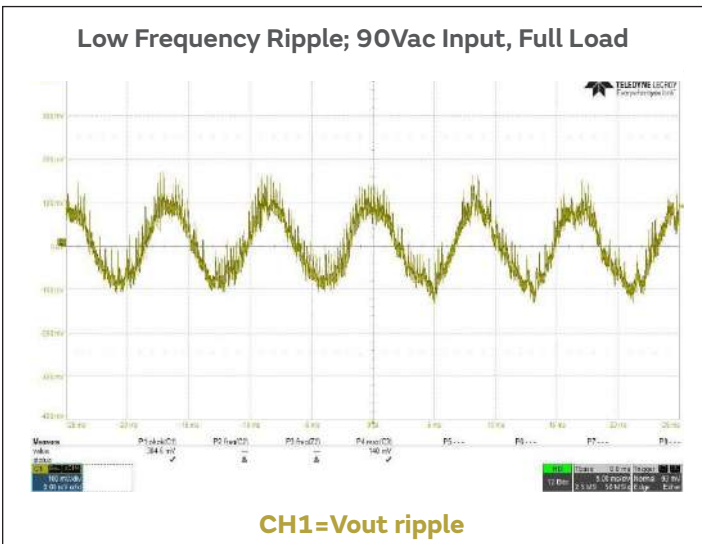
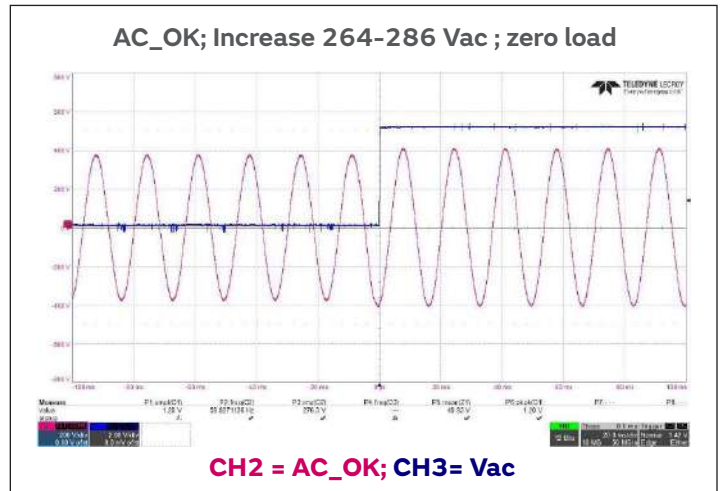
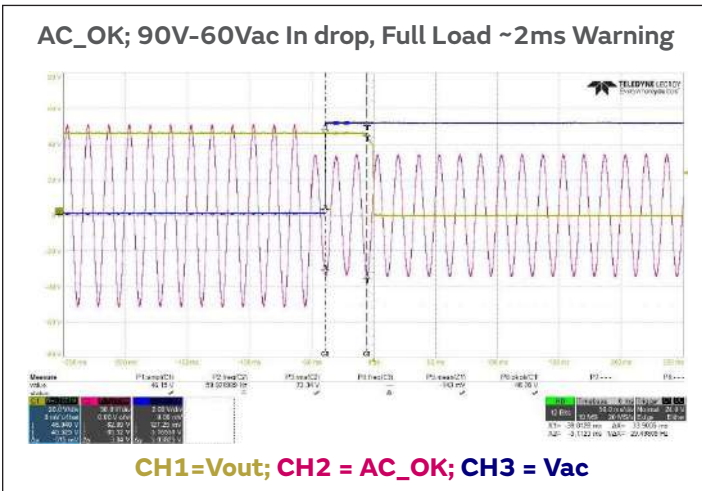

Mechanical Data

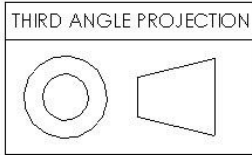

DIMENSIONS SHOWN IN INCHES
WITH [mm] SHOWN FOR REFERENCE

TOLERANCES (UOS)
X.XX ±0.02 [0.5]
X.XXX ±0.010 [0.25]

E2
M8 STUD
"-OUT"

E1
M8 STUD
"+OUT"

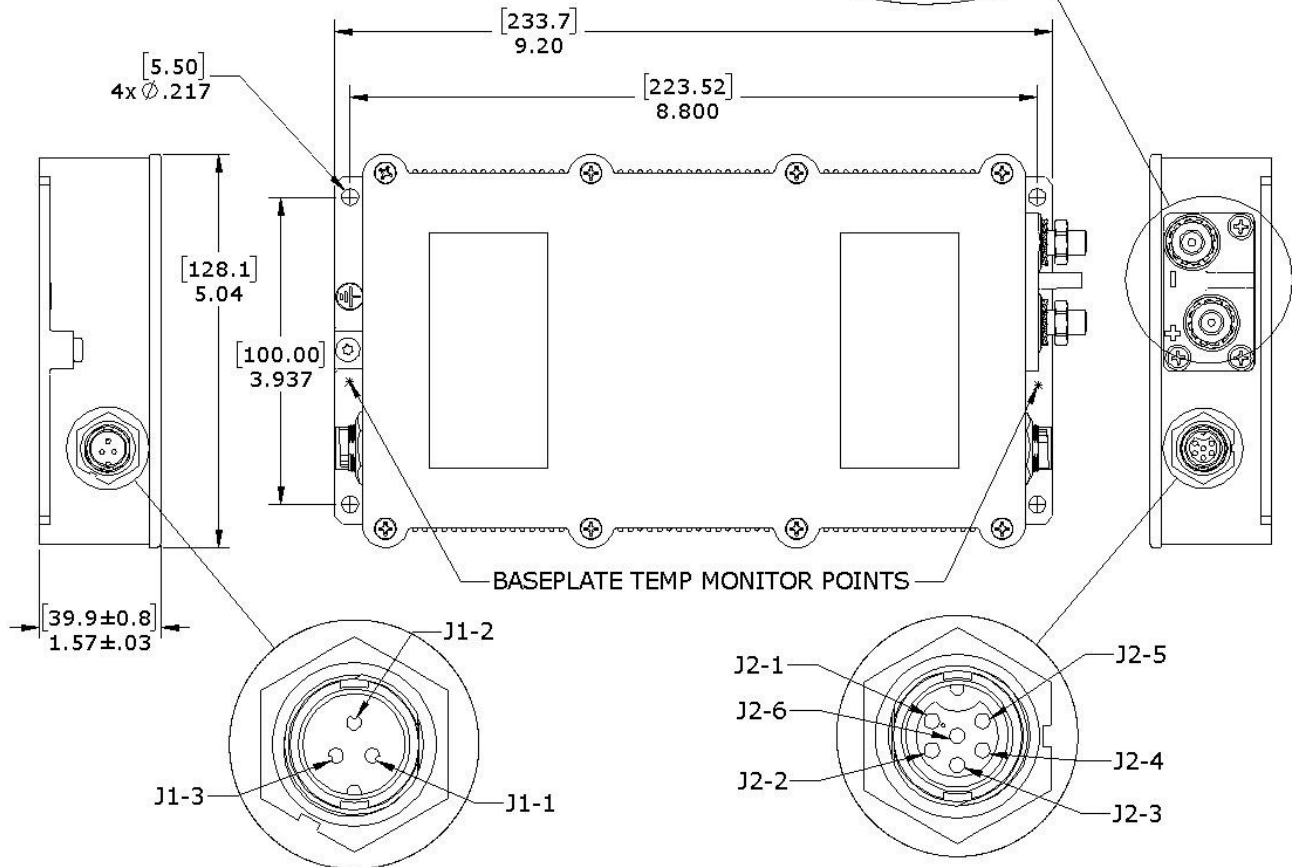

J1 INPUT	
Switchcraft #7382-3PG-300	
PIN #	FUNCTION
1	AC_HI
2	AC_LO
3	GND

J2 SIGNAL	
Switchcraft #7282-6SG-300	
PIN #	FUNCTION
1	AC_OK
2	AC_OK_GND
3	TRIM_UP
4	S_GND
5	TRIM
6	PS_ON

INPUT AND SIGNAL CONNECTORS incl. MATING COUNTERPARTS ¹				
Connector	PIN	Description	PSU Module	Mating Connector
Input Connector J1	1	AC_HI (Line)	Switchcraft 7382-3PG-300	Switchcraft 6382-3SG-522
	2	AC_LO (Neutral)		
	3	GND/PE (Ground, Protective Earth)		
Signal Connector J2	1	AC_OK	Switchcraft 7282-6SG-300	Switchcraft 6282-6PG-522
	2	AC_OK_GND		
	3	TRIM_UP		
	4	S GND		
	5	TRIM		
	6	PS_ON		

¹ In order to meet IP67 requirement, the mating input and signal connectors must be in place and securely connected.

OUTPUT CONNECTIONS					
Connector	PIN#	Description	Recommended Cable Gauge (minimum)	Stud Terminal Thread	Connector Image
Studs	E1	+DC_OUT (positive)	6AWG/13.3mm ²	M8 X 1.25 PHOSPHOR BRONZE, TIN PLATED OUTPUT STUDS (HEX NUTS AND EXT TOOTH LOCKWASHERS SUPPLIED)	
	E2	-DC_OUT (negative)			

Shipping Information

