PXIe-6381

Specifications

2026-03-10



Contents

PXle-6381 Specifications..... 3

PXIe-6381 Specifications

PXIe-6381 Specifications

These specifications apply to the PXIe-6381.

Revision History

Version	Date changed	Description
327974A-01	December 2025	Initial release.

Looking For Something Else?

For information not found in the specifications for your product, such as operating instructions, browse ***Related Information***.

Related information:

- [PXIe-6381 User Manual](#)
- [Software and Driver Downloads](#)
- [Dimensional Drawings](#)
- [Product Certifications](#)
- [Letter of Volatility](#)
- [Discussion Forums](#)
- [NI Learning Center](#)

Definitions

Warranted specifications describe the performance of a model under stated operating conditions and are covered by the model warranty.

Characteristics describe values that are relevant to the use of the model under stated operating conditions but are not covered by the model warranty.

- ***Typical*** specifications describe the performance met by a majority of models.



- **Nominal** describes an attribute that is based on design, conformance testing, or supplemental testing.

Specifications are **Typical** unless otherwise noted.

Conditions

Specifications are valid at 25 °C unless otherwise noted.

PXIe-6381 Pinout

AI 0 (AI 0+)	68	34	AI 8 (AI 0-)
AI GND	67	33	AI 1 (AI 1+)
AI 9 (AI 1-)	66	32	AI GND
AI 2 (AI 2+)	65	31	AI 10 (AI 2-)
AI GND	64	30	AI 3 (AI 3+)
AI 11 (AI 3-)	63	29	AI GND
AI SENSE	62	28	AI 4 (AI 4+)
AI 12 (AI 4-)	61	27	AI GND
AI 5 (AI 5+)	60	26	AI 13 (AI 5-)
AI GND	59	25	AI 6 (AI 6+)
AI 14 (AI 6-)	58	24	AI GND
AI 7 (AI 7+)	57	23	AI 15 (AI 7-)
AI GND	56	22	AO 0
AO GND	55	21	AO 1
AO GND	54	20	APFI 0
D GND	53	19	P0.4
P0.0	52	18	D GND
P0.5	51	17	P0.1
D GND	50	16	P0.6
P0.2	49	15	D GND
P0.7	48	14	+5 V
P0.3	47	13	D GND
PFI 11/P2.3	46	12	D GND
PFI 10/P2.2	45	11	PFI 0/P1.0
D GND	44	10	PFI 1/P1.1
PFI 2/P1.2	43	9	D GND
PFI 3/P1.3	42	8	+5 V
PFI 4/P1.4	41	7	D GND
PFI 13/P2.5	40	6	PFI 5/P1.5
PFI 15/P2.7	39	5	PFI 6/P1.6
PFI 7/P1.7	38	4	D GND
PFI 8/P2.0	37	3	PFI 9/P2.1
D GND	36	2	PFI 12/P2.4
D GND	35	1	PFI 14/P2.6

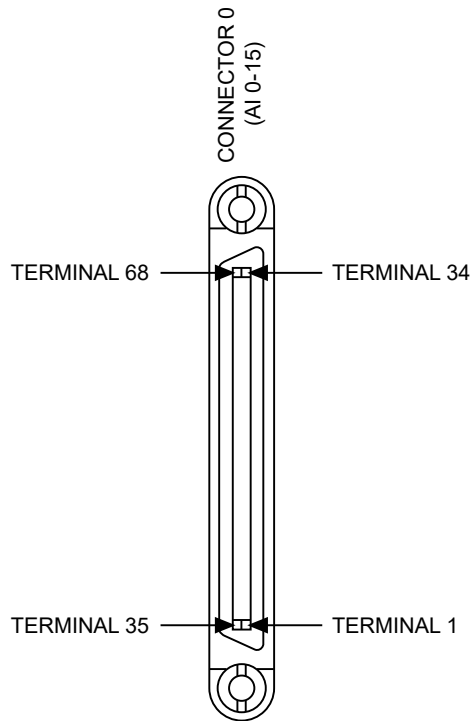

Table 1. Default Counter/Timer Terminals

Counter/Timer Signal	Default PFI Terminal
CTR 0 SRC	PFI 8
CTR 0 GATE	PFI 9
CTR 0 AUX	PFI 10
CTR 0 OUT	PFI 12
CTR 0 A	PFI 8

Counter/Timer Signal	Default PFI Terminal
CTR 0 Z	PFI 9
CTR 0 B	PFI 10
CTR 1 SRC	PFI 3
CTR 1 GATE	PFI 4
CTR 1 AUX	PFI 11
CTR 1 OUT	PFI 13
CTR 1 A	PFI 3
CTR 1 Z	PFI 4
CTR 1 B	PFI 11
CTR 2 SRC	PFI 0
CTR 2 GATE	PFI 1
CTR 2 AUX	PFI 2
CTR 2 OUT	PFI 14
CTR 2 A	PFI 0
CTR 2 Z	PFI 1
CTR 2 B	PFI 2
CTR 3 SRC	PFI 5
CTR 3 GATE	PFI 6
CTR 3 AUX	PFI 7
CTR 3 OUT	PFI 15
CTR 3 A	PFI 5
CTR 3 Z	PFI 6
CTR 3 B	PFI 7
FREQ OUT	PFI 14



Table 2. Signal Descriptions

Signal	Reference	Description
AI GND	—	Analog Input Ground—These terminals are the reference point for single-ended AI measurements in RSE mode and the bias current return point for DIFF measurements. All ground references—AI GND, AO GND, and D GND—are connected on the device. Though AI GND, AO GND, and D GND are connected on the device, they are connected by small traces to reduce crosstalk between subsystems. Each ground has a slight difference in potential.
AI <0..15>	Varies	Analog Input Channels—For single-ended measurements, each signal is an analog input voltage channel. In RSE mode, AI GND is the reference for these signals. In NRSE mode, the reference for each AI signal is an AI SENSE. For differential measurements, AI 0 and AI 8 are the positive and negative inputs of differential analog input channel 0. Similarly, the following signal pairs also form differential input channels: AI <1,9>, AI <2,10>, and so on.
AI SENSE	—	Analog Input Sense—In NRSE



Signal	Reference	Description
		mode, the reference for each AI <0..15> signal is AI SENSE.
AO <0,1>	AO GND	Analog Output Channels—These terminals supply voltage output.
AO GND	—	Analog Output Ground—AO GND is the reference for AO. All ground references—AI GND, AO GND, and D GND—are connected on the device. Though AI GND, AO GND, and D GND are connected on the device, they are connected by small traces to reduce crosstalk between subsystems. Each ground has a slight difference in potential.
D GND	—	Digital Ground—D GND supplies the reference for port 0, port 1, port 2 digital channels, PFI, and +5 V. All ground references—AI GND, AO GND, and D GND—are connected on the device. Though AI GND, AO GND, and D GND are connected on the device, they are connected by small traces to reduce crosstalk between subsystems. Each ground has a slight difference in potential.



Signal	Reference	Description
P0.<0..7>	D GND	Port 0 Digital I/O Channels—You can configure each signal individually as an input or output.
APFI 0	AO GND or AI GND	Analog Programmable Function Interface Channels—Each APFI signal can be used as AO external reference inputs for AO, or as an analog trigger input. APFI are referenced to AI GND when they are used as analog trigger inputs. APFI are referenced to AO GND when they are used as AO external offset or reference inputs.
+5 V	D GND	+5 V Power Source—These terminals provide a fused +5 V power source.
PFI <0..7>/P1.<0..7>, PFI <8..15>/P2.<0..7>	D GND	<p>Programmable Function Interface or Digital I/O Channels—Each of these terminals can be individually configured as a PFI terminal or a digital I/O terminal.</p> <p>As an input, each PFI terminal can be used to supply an external source for AI, AO, DI, and DO timing signals or counter/timer inputs. As a PFI output, you can route many different internal AI, AO, DI, or DO timing signals to each PFI</p>



Signal	Reference	Description
		terminal. You can also route the counter/timer outputs to each PFI terminal. As a port 1 or port 2 digital I/O signal, you can individually configure each signal as an input or output.

Analog Input

Number of channels	08 differential or 16 single ended
ADC resolution	18 bits
DNL	No missing codes guaranteed
INL	Refer to AI Absolute Accuracy.
Sample rate	
Single channel maximum	625 kS/s
Multichannel maximum (aggregate)	500 kS/s
Minimum	No minimum
Timing resolution	10 ns
Timing accuracy	50 ppm of sample rate
Input coupling	DC
Input range	± 0.1 V, ± 0.2 V, ± 0.5 V, ± 1 V, ± 2 V, ± 5 V, ± 10 V
Maximum working voltage for analog inputs (signal + common mode)	± 11 V of AI GND
CMRR (DC to 60 Hz)	110 dB
Input impedance	
Device on	
AI+ to AI GND	>10 G Ω in parallel with 100 pF
AI- to AI GND	>10 G Ω in parallel with 100 pF

Device off	
AI+ to AI GND	820 Ω
AI- to AI GND	820 Ω
Input bias current	± 100 pA
Crosstalk (at 100 kHz)	
Adjacent channels	-75 dB
Non-adjacent channels	-95 dB
Small signal bandwidth (-3 dB)	750 kHz filter off, 40 kHz filter on
Input FIFO size	2,047 samples
Scan list memory	4,095 entries
Data transfers	DMA (scatter-gather), programmed I/O
Overvoltage protection for all analog input and sense channels	
Device on	± 25 V for up to eight AI pins
Device off	± 15 V for up to eight AI pins
Input current during overvoltage condition	± 20 mA maximum/AI pin

Settling Time for Multichannel Measurements

Table 3. Settling Time for Multichannel Measurements

Range	Filter Off ± 15 ppm of Step (± 4 LSB for Full-Scale Step)	Filter Off ± 4 ppm of Step (± 1 LSB for Full-Scale Step)	Filter On ± 4 ppm of Step (± 1 LSB for Full-Scale Step)
± 5 V, ± 10 V	2 μ s	8 μ s	50 μ s
± 0.5 V, ± 1 V, ± 2 V	2.5 μ s	8 μ s	50 μ s
± 0.1 V, ± 0.2 V	3 μ s	8 μ s	50 μ s



Typical Performance Graphs

Figure 1. AI Settling Error versus Time for Different Source Impedances

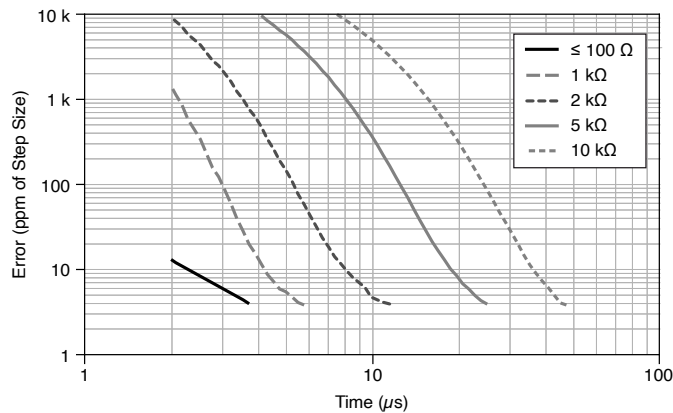

Figure 2. AI Small Signal Bandwidth

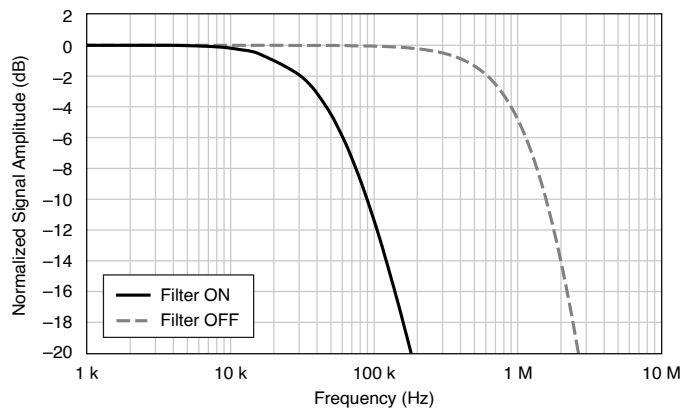
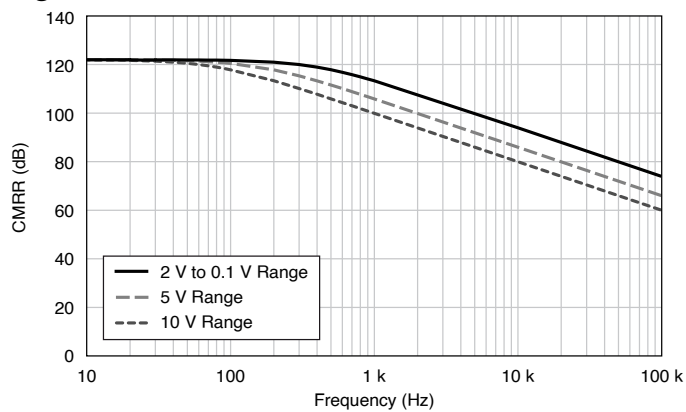

Figure 3. AI CMRR



AI Absolute Accuracy

AI Absolute Accuracy (Filter On)



Note Accuracies listed are valid for up to two years from the device external calibration.

Table 4. AI Absolute Accuracy (Filter On)

Nominal Range Positive Full Scale	Nominal Range Negative Full Scale	Residual Gain Error (ppm of Reading)	Residual Offset Error (ppm of Range)	Offset Tempco (ppm of Range/°C)	Random Noise, σ (μVrms)	Absolute Accuracy at Full Scale (μV)	Sensitivity (μV)
10	-10	40	8	11	60	980	24
5	-5	45	8	11	30	510	12
2	-2	45	8	13	12	210	4.8
1	-1	55	15	15	7	120	2.8
0.5	-0.5	55	30	20	4	70	1.6
0.2	-0.2	75	45	35	3	39	1.2
0.1	-0.1	120	60	60	2	28	0.8



Note Sensitivity is the smallest voltage change that can be detected. It is a function of noise.

Table 5. AI Absolute Accuracy Values (Filter On)

Gain tempco	17 ppm/°C
Reference tempco	1 ppm/°C
INL error	10 ppm of range

AI Absolute Accuracy (Filter Off)



Note Accuracies listed are valid for up to two years from the device external calibration.



Table 6. AI Absolute Accuracy (Filter Off)

Nominal Range Positive Full Scale	Nominal Range Negative Full Scale	Residual Gain Error (ppm of Reading)	Residual Offset Error (ppm of Range)	Offset Tempco (ppm of Range/°C)	Random Noise, σ (μVrms)	Absolute Accuracy at Full Scale (μV)	Sensitivity (μV)
10	-10	45	10	11	70	1,050	28.0
5	-5	50	10	11	35	550	14.0
2	-2	50	10	13	15	230	6.0
1	-1	60	17	15	12	130	4.8
0.5	-0.5	60	32	20	10	80	4.0
0.2	-0.2	80	47	35	9	43	3.6
0.1	-0.1	120	62	60	9	31	3.6



Note Sensitivity is the smallest voltage change that can be detected. It is a function of noise.

Table 7. AI Absolute Accuracy Values (Filter Off)

Gain tempco	17 ppm/°C
Reference tempco	1 ppm/°C
INL error	10 ppm of range

AI Absolute Accuracy Equation

AbsoluteAccuracy = Reading · (GainError) + Range · (OffsetError) + NoiseUncertainty

- ***GainError = ResidualAIGainError + GainTempco · (TempChangeFromLastInternalCal) + ReferenceTempco · (TempChangeFromLastExternalCal)***
- ***OffsetError = ResidualAIOffsetError + OffsetTempco · (TempChangeFromLastInternalCal) + INLError***

- **NoiseUncertainty** =

$$\frac{\text{Random Noise} \cdot 3}{\sqrt{100}}$$

for a coverage factor of 3σ and averaging 100 points.

AI Absolute Accuracy Example

Absolute accuracy at full scale on the analog input channels is determined using the following assumptions:

- TempChangeFromLastExternalCal = 10 °C
- TempChangeFromLastInternalCal = 1 °C
- number_of_readings = 100
- CoverageFactor = 3σ

For example, on the 10 V range of the Filter On accuracy table, the absolute accuracy at full scale is as follows:

- GainError = 40 ppm + 17 ppm · 1 + 1 ppm · 10 = 67 ppm
- OffsetError = 8 ppm + 11 ppm · 1 + 10 ppm = 29 ppm
- NoiseUncertainty = $\frac{60 \mu\text{V} \cdot 3}{\sqrt{100}}$
= 18 μV
- AbsoluteAccuracy = 10 V · (GainError) + 10 V · (OffsetError) + NoiseUncertainty = 980 μV

Analog Triggers

Number of triggers	1
Source	AI <0..15>, APFI 0
Functions	Start Trigger, Reference Trigger, Pause Trigger, Sample Clock, Convert Clock, Sample Clock Timebase
Resolution	16 bits
Modes	Analog edge triggering, analog edge triggering with hysteresis, and analog window triggering
Accuracy	$\pm 1\%$ of range

Table 8. Source Level

AI <0..15>	±Full scale
APFI 0	±10 V

Table 9. Bandwidth (-3 db)

AI <0..15>	700 kHz filter off, 40 kHz filter on
APFI 0	5 MHz

Table 10. APFI 0 characteristics

Input impedance	10 kΩ
Coupling	DC
Protection, power on	±30 V
Protection, power off	±15 V

Analog Output

Number of channels	2
DAC resolution	16 bits
DNL	±1 LSB
Monotonicity	16 bit guaranteed
Accuracy	Refer to the AO Absolute Accuracy table.
Maximum update rate	
1 channel	2.86 MS/s
2 channels	2.00 MS/s
Timing accuracy	50 ppm of sample rate
Timing resolution	10 ns
Output range (offset ± reference)	
Calibrated range	±1 V, ±2 V, ±5 V, ±10 V
Offset sources	0 V, 5 V, APFI 0, AO <0,1> ¹

1. An AO channel cannot be a reference or offset to itself.

Reference sources	1 V, 2 V, 5 V, 10 V, APFI 0, AO <0,1> ²
Maximum output level	±11 V
Output coupling	DC
Output impedance	0.2 Ω
Output current drive	±5 mA
Overdrive protection	±25 V
Overdrive current	20 mA
Power-on state	±5 mV
Power-on/off glitch	1.25 V peak for 3.5 μs
Output FIFO size	8,191 samples shared among channels used
Data transfers	DMA (scatter-gather), programmed I/O
AO waveform modes	Non-periodic waveform, periodic waveform regeneration mode from onboard FIFO, periodic waveform regeneration from host buffer including dynamic update
Settling time, full-scale step, 15 ppm (1 LSB)	3 μs
Slew rate	20 V/μs
Glitch energy at midscale transition, ±10 V range	15 mV magnitude, 0.5 μs duration

External Reference

Table 11. APFI 0 characteristics

Input impedance	10 kΩ
Coupling	DC
Protection, device on	±30 V
Protection, device off	±15 V
Range	±11 V
Slew rate	20 V/μs

2. An AO channel cannot be a reference or offset to itself.

Figure 4. AO External Reference Bandwidth

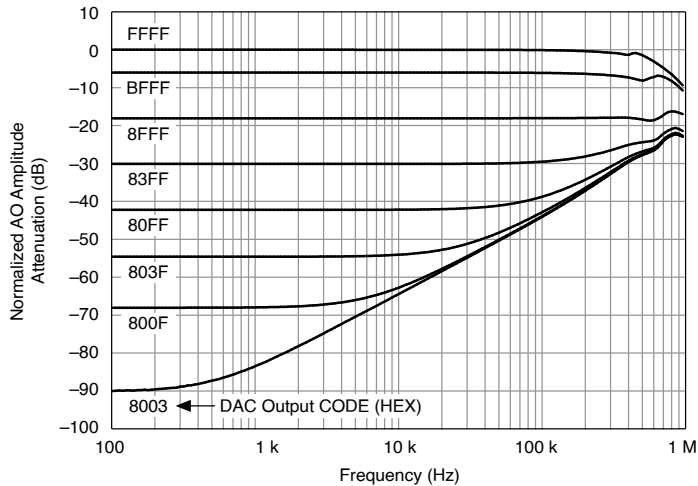

AO Absolute Accuracy

Absolute accuracy at full-scale numbers is valid immediately following internal calibration and assumes the device is operating within 10 °C of the last external calibration.



Note Accuracies listed are valid for up to two years from the device external calibration.

Table 12. AO Absolute Accuracy

Nominal Range Positive Full Scale	Nominal Range Negative Full Scale	Residual Gain Error (ppm of Reading)	Gain Tempco (ppm/°C)	Residual Offset Error (ppm of Range)	Offset Tempco (ppm of Range/°C)	Absolute Accuracy at Full Scale (μV)
10	-10	55	15	30	12	1,540
5	-5	60	15	30	17	820
2	-2	65	25	40	30	404
1	-1	85	25	57	50	259

Table 13. AO Absolute Accuracy Values

Reference tempco	1 ppm/°C
INL error	32 ppm of range



AO Absolute Accuracy Equation

$$\text{AbsoluteAccuracy} = \text{OutputValue} \cdot (\text{GainError}) + \text{Range} \cdot (\text{OffsetError})$$

- $\text{GainError} = \text{ResidualGainError} + \text{GainTempco} \cdot (\text{TempChangeFromLastInternalCal}) + \text{ReferenceTempco} \cdot (\text{TempChangeFromLastExternalCal})$
- $\text{OffsetError} = \text{ResidualOffsetError} + \text{AOffsetTempco} \cdot (\text{TempChangeFromLastInternalCal}) + \text{INLError}$

Digital I/O/PFI

Static Characteristics

Number of channels	24 total, 8 (P0.<0..7>), 16 (PFI <0..7>/P1, PFI <8..15>/P2)
Ground reference	D GND
Direction control	Each terminal individually programmable as input or output
Pull-down resistor	50 kΩ typical, 20 kΩ minimum
Input voltage protection	±20 V on up to two pins



Notice Stresses beyond those listed under the **Input voltage protection** specification may cause permanent damage to the device.

Waveform Characteristics (Port 0 Only)

Terminals used	Port 0 (P0.<0..7>)
Port/sample size	Up to 8 bits
Waveform generation (DO) FIFO	2,047 samples
Waveform acquisition (DI) FIFO	255 samples



DI or DO Sample Clock source ³	Any PFI, AI Sample or Convert Clock, AO Sample Clock, Counter Internal Output, and many other signals
DI Sample Clock Frequency	0 MHz to 10 MHz, system and bus activity dependent
Regenerate from FIFO	0 MHz to 10 MHz
Streaming from memory	0 to 10 MHz, system and bus activity dependent
Data Transfers	DMA (scatter-gather), interrupts, programmed I/O
Digital line filter settings	160 ns, 10.24 μ s, 5.12 ms, disable

PFI/Port 1/Port 2 Functionality

Functionality	Static digital input, static digital output, timing input, timing output
Timing output sources	Many AI, AO, counter, DI, DO timing signals
Debounce filter settings	90 ns, 5.12 μ s, 2.56 ms, custom interval, disable; programmable high and low transitions; selectable per input

Recommended Operating Conditions

Input high voltage (V_{IH})	
Minimum	2.2 V
Maximum	5.25 V
Input low voltage (V_{IL})	
Minimum	0 V
Maximum	0.8 V
Output high current (I_{OH})	
P0.<0..7>	-24 mA maximum

3. The digital subsystem does not have its own dedicated internal timing engine. Therefore, a sample clock must be provided from another subsystem on the device or an external source.

PFI <0..15>/P1/P2	-16 mA maximum
Output low current (I_{OL})	
P0.<0..7>	24 mA maximum
PFI <0..15>/P1/P2	16 mA maximum

Digital I/O Characteristics

Positive-going threshold (V_{T+})	2.2 V maximum
Negative-going threshold (V_{T-})	0.8 V minimum
Delta VT hysteresis ($V_{T+} - V_{T-}$)	0.2 V minimum
I_{IL} input low current ($V_{IN} = 0$ V)	-10 μ A maximum
I_{IH} input high current ($V_{IN} = 5$ V)	250 μ A maximum

Figure 5. P0.<0..7>:: I_{OH} versus V_{OH}

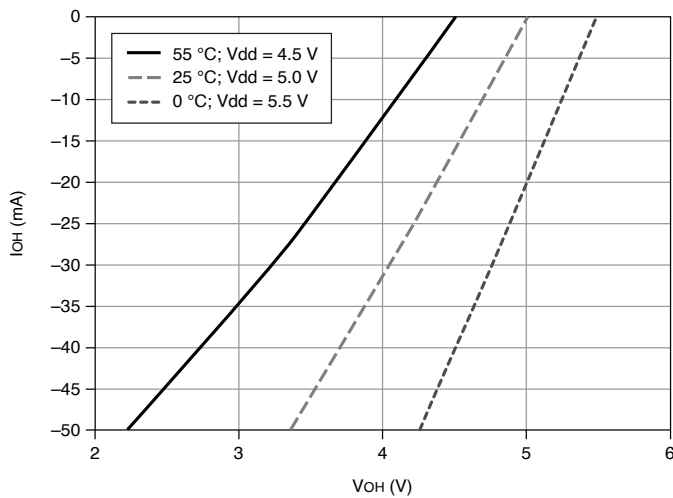

Figure 6. P0.<0..7>: I_{OL} versus V_{OL}

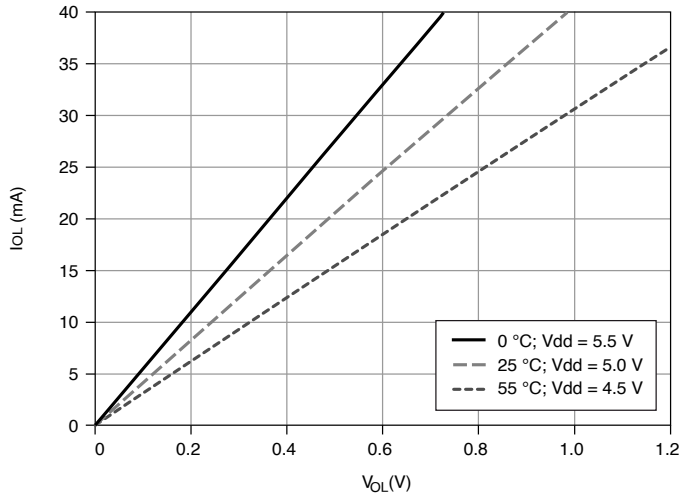

Figure 7. PFI <0..15>/P1/P2: I_{OH} versus V_{OH}

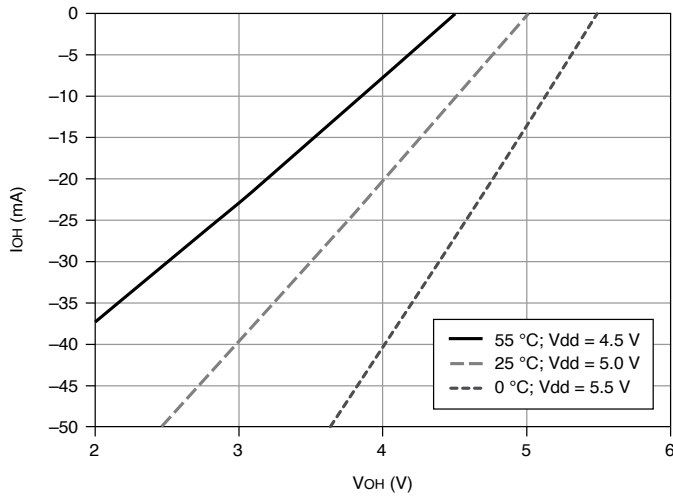
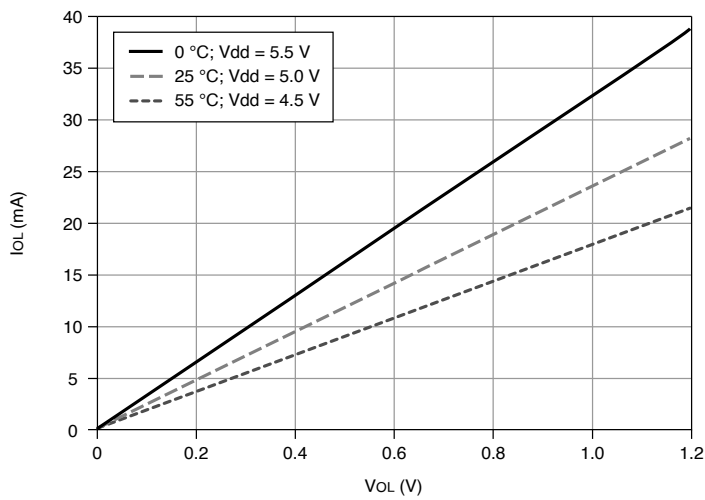

Figure 8. PFI <0..15>/P1/P2: I_{OL} versus V_{OL}



General-Purpose Counters

Number of counter/timers	4
Resolution	32 bits
Counter measurements	Edge counting, pulse, pulse width, semi-period, period, two-edge separation
Position measurements	X1, X2, X4 quadrature encoding with Channel Z reloading; two-pulse encoding
Output applications	Pulse, pulse train with dynamic updates, frequency division, equivalent time sampling
Internal base clocks	100 MHz, 20 MHz, 100 kHz
External base clock frequency	0 MHz to 25 MHz; 0 MHz to 100 MHz on PXIe_DSTAR <A,B>
Base clock accuracy	50 ppm
Inputs	Gate, Source, HW_Arm, Aux, A, B, Z, Up_Down, Sample Clock
Routing options for inputs	Any PFI, PXIe_DSTAR<A,B>, PXI_TRIG<0..7>, PXI_STAR, analog trigger, many internal signals
FIFO	127 samples per counter
Data transfers	Dedicated scatter-gather DMA controller for each counter/timer, programmed I/O

Frequency Generator

Number of channels	1
Base clocks	20 MHz, 10 MHz, 100 kHz
Divisors	1 to 16
Base clock accuracy	50 ppm

Phase-Locked Loop (PLL)

Number of PLLs	1
----------------	---

Output of PLL	100 MHz Timebase; other signals derived from 100 MHz Timebase including 20 MHz and 100 kHz Timebases.
---------------	---

Table 14. Reference Clock Locking Frequencies

Reference Signal	PXI Express Locking Input Frequency (MHz)
PXIe_DSTAR<A,B>	10, 20, 100
PXI_STAR	10, 20
PXIe_CLK100	100
PXI_TRIG <0..7>	10, 20
PFI <0..15>	10, 20

External Digital Triggers

Source	Any PFI, PXIe_DSTAR<A,B>, PXI_TRIG<0..7>, PXI_STAR
Polarity	Software-selectable for most signals
Analog input function	Start Trigger, Reference Trigger, Pause Trigger, Sample Clock, Convert Clock, Sample Clock Timebase
Analog output function	Start Trigger, Pause Trigger, Sample Clock, Sample Clock Timebase
Counter/timer functions	Gate, Source, HW_Arm, Aux, A, B, Z, Up_Down, Sample Clock
Digital waveform generation (DO) function	Start Trigger, Pause Trigger, Sample Clock, Sample Clock Timebase
Digital waveform acquisition (DI) function	Start Trigger, Reference Trigger, Pause Trigger, Sample Clock, Sample Clock Timebase

Device-to-Device Trigger Bus

Input source	PXI_TRIG <0..7>, PXI_STAR, PXIe_DSTAR<A,B>
--------------	--

Output destination	PXI_TRIG <0..7>, PXIe_DSTARC
Output selections	10 MHz Clock, frequency generator output, many internal signals
Debounce filter settings	90 ns, 5.12 μ s, 2.56 ms, custom interval, disable; programmable high and low transitions; selectable per input

Bus Interface

Form factor	x1 PXI Express peripheral module, specification rev. 1.0 compliant
Slot compatibility	x1 and x4 PXI Express or PXI Express hybrid slots
DMA channels	8: analog input, analog output, digital input, digital output, counter/timer 0, counter/timer 1, counter/timer 2, counter/timer 3

Devices may be installed in PXI Express slots or PXI Express hybrid slots.

Power Requirements

Table 15. Power Specifications

PXIe Bus	Voltage/current rating	0.49 A at 3.3 V DC 2.20 A at 12 V DC
	Power rating	26.4 W

Physical Characteristics

Table 16. Dimensions and Weight

Device dimensions	3U, one-slot, PXI Express/Compact PCI Express module
Weight	177 g (6.3 oz)

Calibration

Recommended warm-up time	15 minutes
Calibration interval	2 years

Current Limits

+5 V terminal (connector 0)	1 A max
P0/PFI/P1/P2 and +5 V terminals combined	1.5 A max

Safety Voltages

Table 17. Rated Voltages

AI+ or AI- to GND	± 10 V DC
AO to GND	± 10 V DC
DIO-to-GND	+5 V DC
+5V pin to GND	+5 V DC



Caution Any external sources must be limited to not exceed these maximum rated voltages.



Attention Les sources externes doivent être limitées pour ne pas dépasser ces tensions nominales maximales.

Current Ratings

DIO Maximum continuous current	Per channel	± 10 mA
	Sum of all channels	± 160 mA
AO Maximum continuous current	Per channel	2 mA



Caution

Any external sources must be limited to not exceed these maximum rated currents.



Attention

Les sources externes doivent être limitées pour ne pas dépasser ces tensions nominales maximales.

Environmental Guidelines



Notice Failure to follow the mounting instructions in the product documentation can cause temperature derating.



Notice This product is intended for use in indoor applications only.

Environmental Characteristics

Temperature	Operating	0 °C to 55 °C
	Storage	-40 °C to 71 °C
Humidity	Operating	10% RH to 90% RH, noncondensing
	Storage	5% RH to 95% RH, noncondensing
Pollution Degree		2
Maximum altitude		2000 m

Shock and Vibration

Operational shock	30 g peak, half-sine, 11 ms pulse (Tested in
-------------------	--

	accordance with IEC 60068-2-27. Test profile developed in accordance with MIL-PRF-28800F.)
--	--

Table 18. Random vibration

Operating	5 Hz to 500 Hz, 0.3 g RMS
Nonoperating	5 Hz to 500 Hz, 2.4 g RMS (Tested in accordance with IEC 60068-2-64. Nonoperating test profile exceeds the requirements of MIL-PRF-28800F, Class 3.)

Measurement Category

This product is rated for Measurement Category I (or other non-MAINS circuits).



Caution Do not connect the product to signals or use for measurements within Measurement Categories II, III, or IV.



Attention Ne pas connecter le produit à des signaux dans les catégories de mesure II, III ou IV et ne pas l'utiliser pour effectuer des mesures dans ces catégories.

Measurement Category I is for measurements performed on circuits not directly connected to the electrical distribution system referred to as **MAINS** voltage. MAINS is a hazardous live electrical supply system that powers equipment. This category is for measurements of voltages from specially protected secondary circuits. Such voltage measurements include signal levels, special equipment, limited-energy parts of equipment, circuits powered by regulated low-voltage sources, and electronics.



Note Measurement Categories CAT I and CAT O are equivalent. These test and measurement circuits are for other circuits not intended for direct connection to the MAINS building installations of Measurement Categories CAT II, CAT III, or CAT IV.