

IDC-20



Overview

The lab-scale **IDC-20 dip coater** is a designed piece of equipment highly accurate and ergonomic for a wide range of thin film coating film to substrate through an easy and controllable process.

IDC-20 is engineering for use in research and development setting, for a plethora of applications like **material science, nanotechnology, biomedical engineering and surface treatment engineering.**

Owing up to 5 membrane load capacity, the integrated software offers an ease of use by an automatic and manual programming option, controlling separately both speed and process times for more thickness and coating control and.

Also, a save of parameters and recall option is integrated up to **20 recipes** and cycles **up to 1000 times facilitating** the accessibility and flexibility of use this device that can be controlled safely from a separated unit interface and conceived with highly durable materials suitable for different chemicals environments.

Key Features:

Built to withstand tough environments:

- **Customizable dipping profiles**
Set multiple dipping stages, dwell times, and speeds.
- **Chemical compatibility**
Built with corrosion-resistant, solvent-safe materials.
- **Accurate and smooth motion control**
Dipping speed range 0-10 mm/sec
Withdrawal speed range: 0-10 mm/sec
- **Compact and ergonomic design:** Small footprint for lab benches or fume hoods.
440 x 330 mm x 446 mm(h)
- **Warranty**
- **Programmable cycles**
20 programmable cycles (up to 1000 repeatability)
- **User friendly interface:**
4,3-inch colour touch screen



Lab-scale Dip Coater IDC-20

Compatible with various tubing sizes to match your application:

Origin: Turkey

Technical Specs:

- **Actuator:** DC stepping motor
- **Drive Mechanism:** Lead screw
- **Speed Control:** Available
- **Power Inputs:** 110-220V, 50/60Hz
- **PC Connectivity:** Available
- **Stroke Length Max:** 200 mm
- **Drawing Speed Min:** 0,0015 mm/min
- **Drawing Speed Max:** 600 mm/min
- **Dimensions:** 440 x 330 mm x 446 mm(h)
- **User Interface:** 4.3-inch LCD colour screen
- **Program Memory:** 20 programs x 999 cycle
- **Power Consumption Max:** 36W (3amp@220V)
- **Maximum Load Capacity:** 2 kg
- **Weight:** 9 Kg

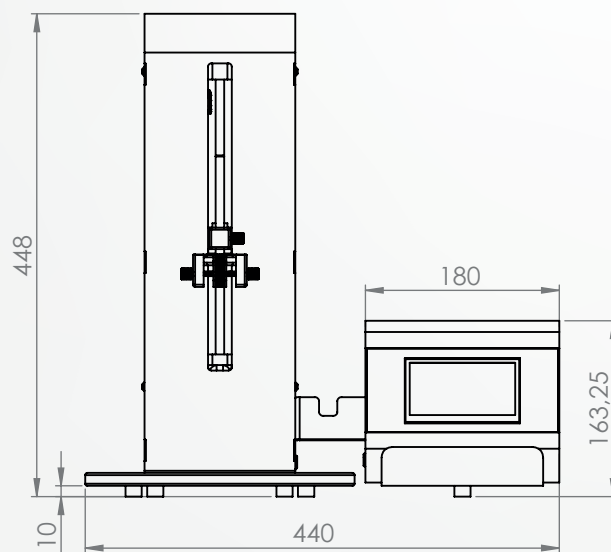

*IDC-20 Dip Coater
Precision, Control, and
Versatility in Every Layer.*

