

For reference only. See data sheet for the detailed specifications.

Technical Specification

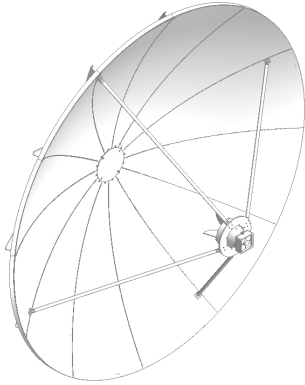

Frequency Range(GHz)	1.0 - 2.0
Gain(dB)	26.9 Typ.
Polarization	Dual Linear
VSWR	2.0:1 Typ.
Connector	N-Female
F/D	0.298
Power Handling(W CW)	200
Antenna Diameter	3m Approx.
Size(mm)	Φ3060 x 1804
Net Weight(Kg)	114.31 Around

Outline Drawing (Size: mm)

Others tolerance: ±10mm

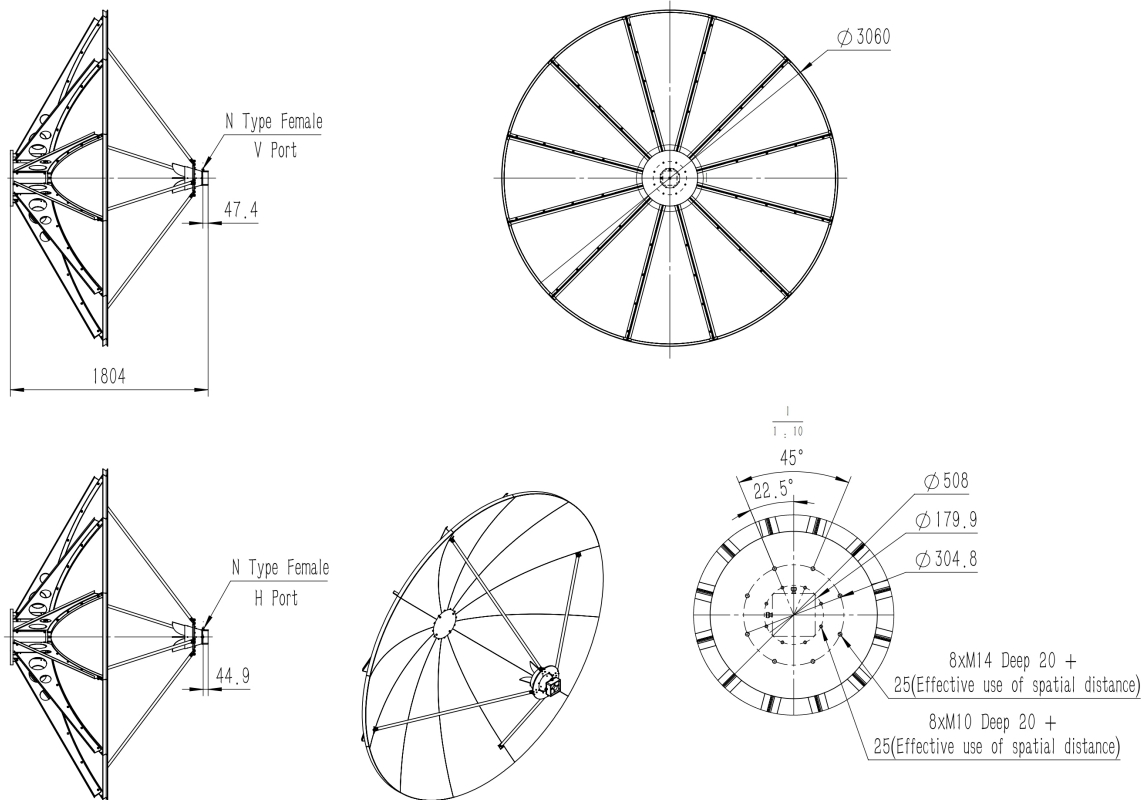

Test Results

1. Gain & Antenna Factor

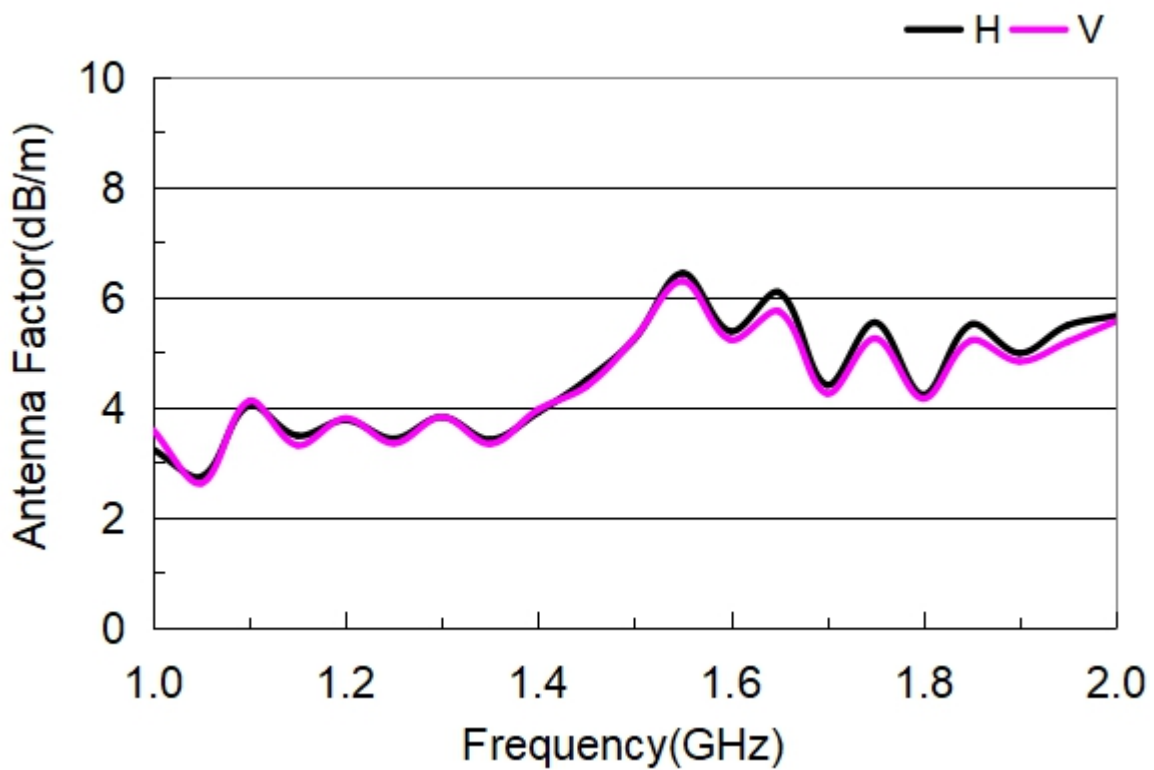
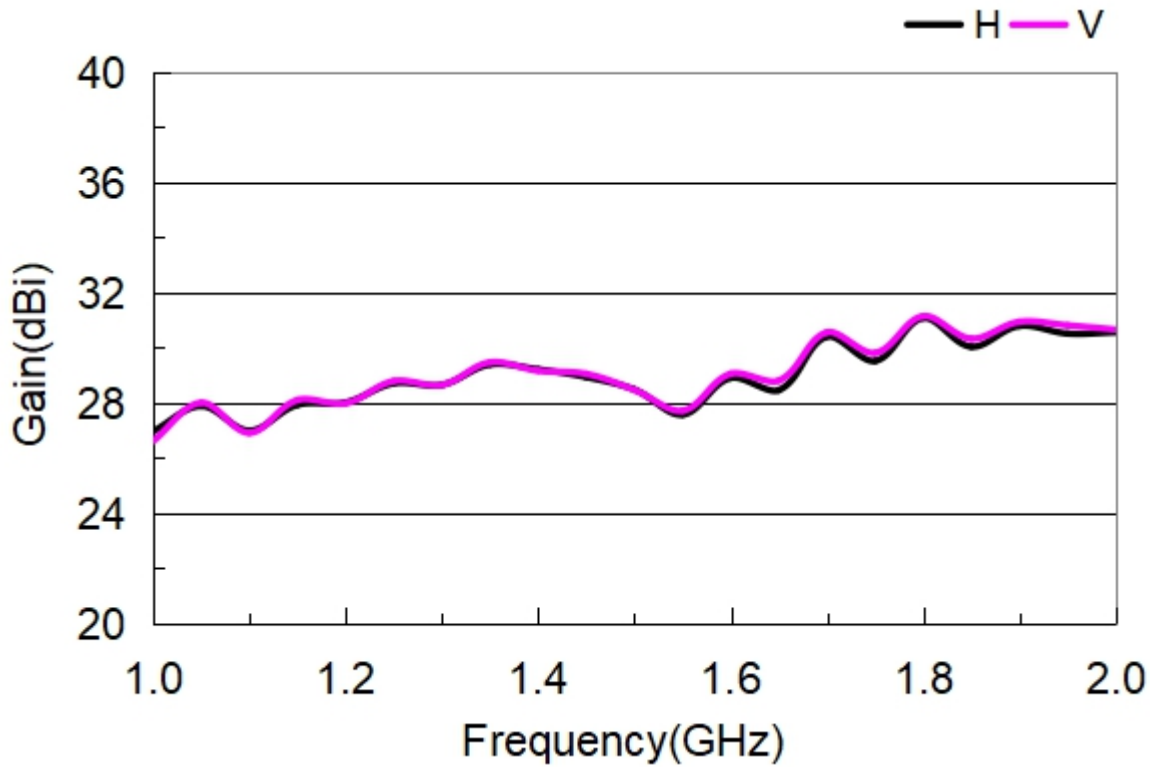

2. Cross Polarization Isolation

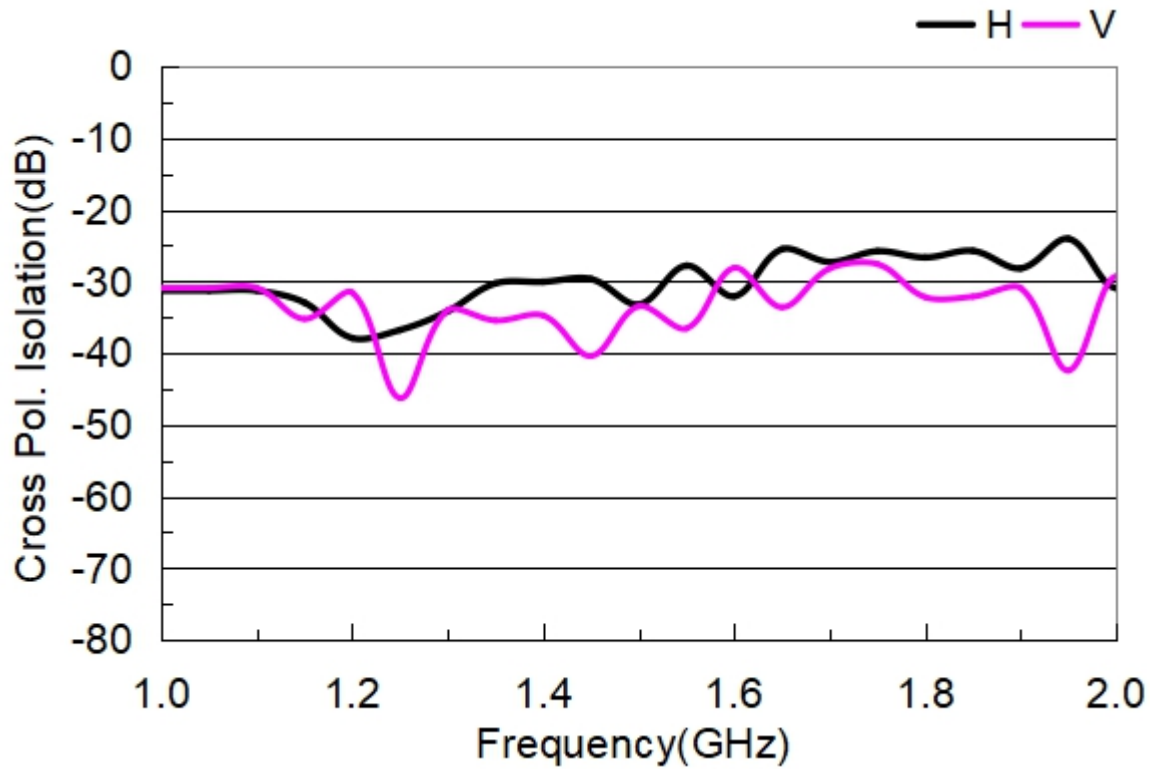

3. Port to Port Isolation

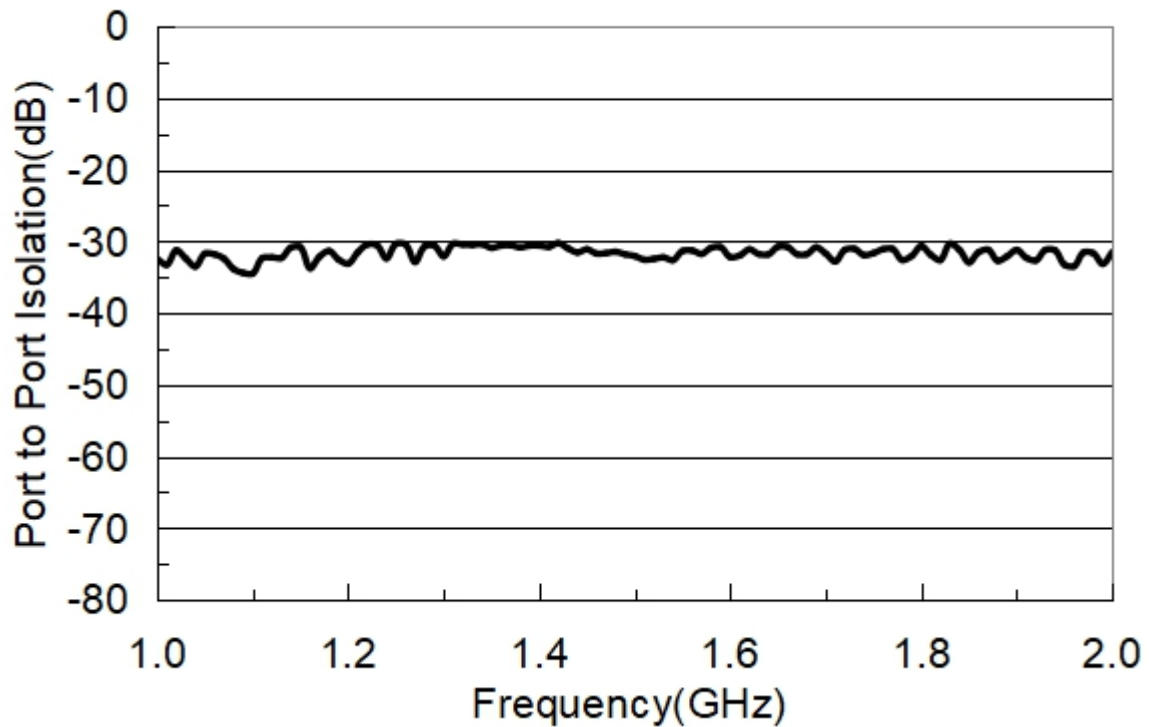

4. VSWR Port-H

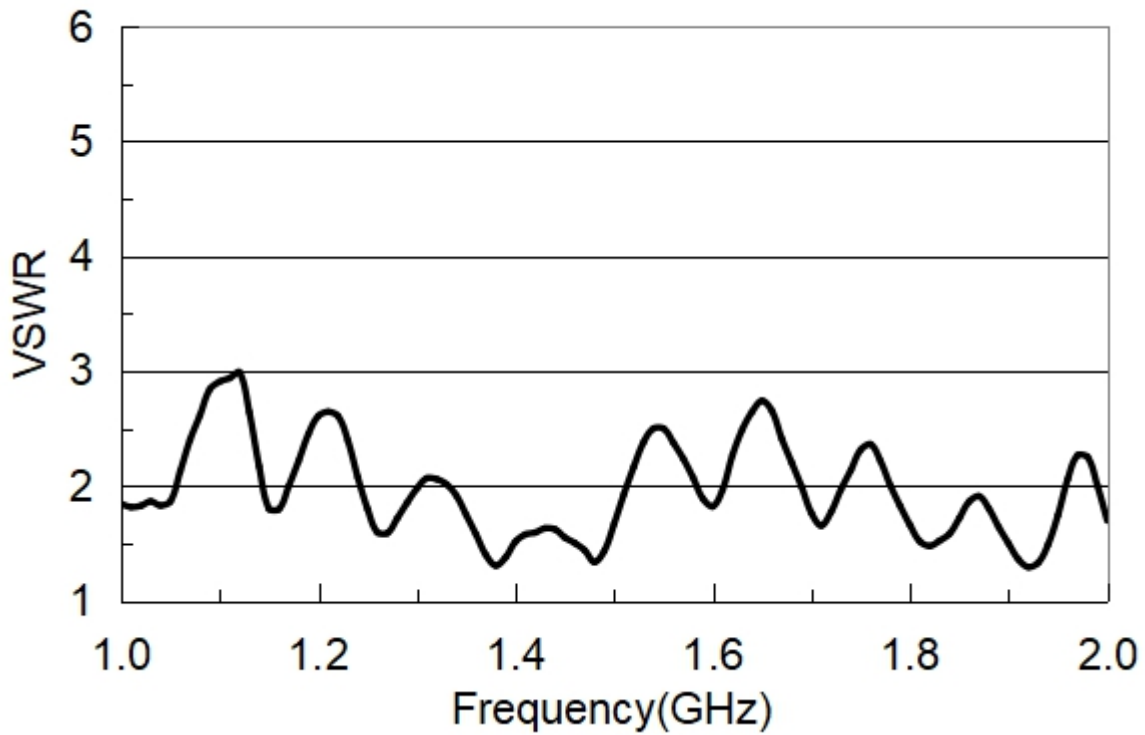

Port-V

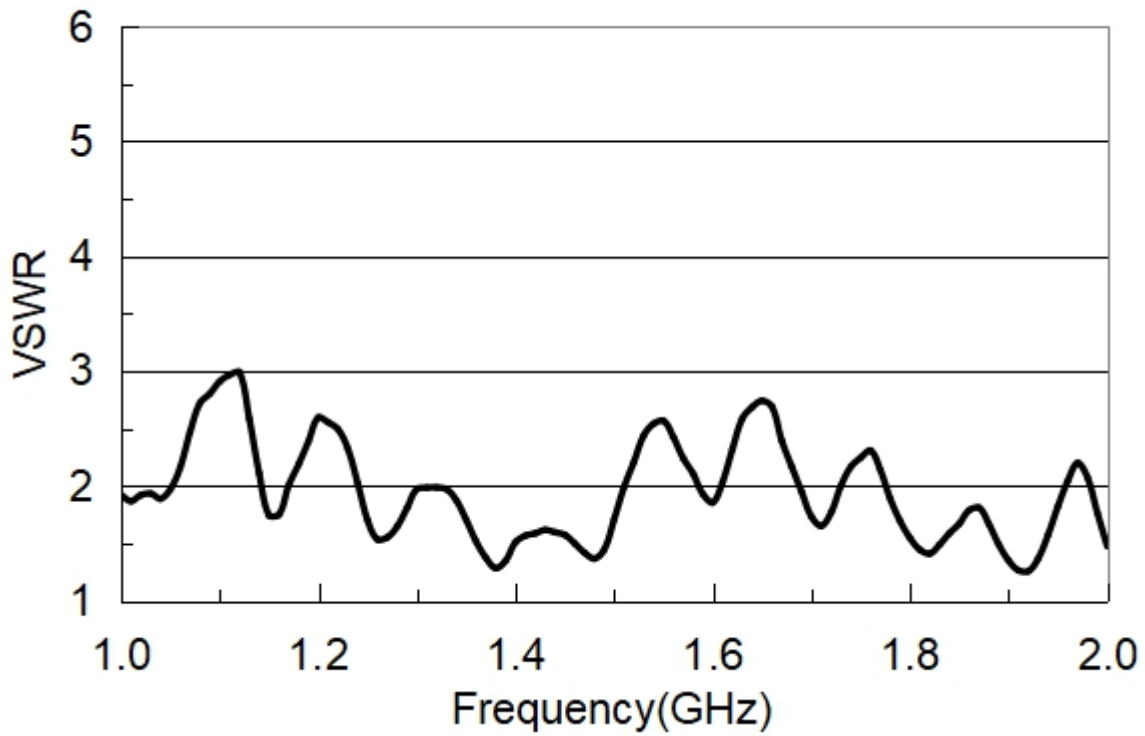

5. Pattern

