

For reference only. See data sheet for the detailed specifications.

## Technical Specification

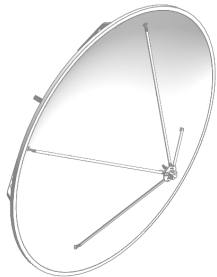

Frequency Range(GHz)	4.0 - 8.0
Gain(dB)	37 Typ.
Polarization	Dual Linear
VSWR	2.0:1 Typ.
Connector	N-Female
F/D	0.373
Power Handling(W CW)	500
Antenna Diameter	2.4m Approx.
Size(mm)	Φ2480 x 1136
Net Weight(Kg)	69.14 Around

## Outline Drawing (Size: mm)

Others tolerance: ±10mm

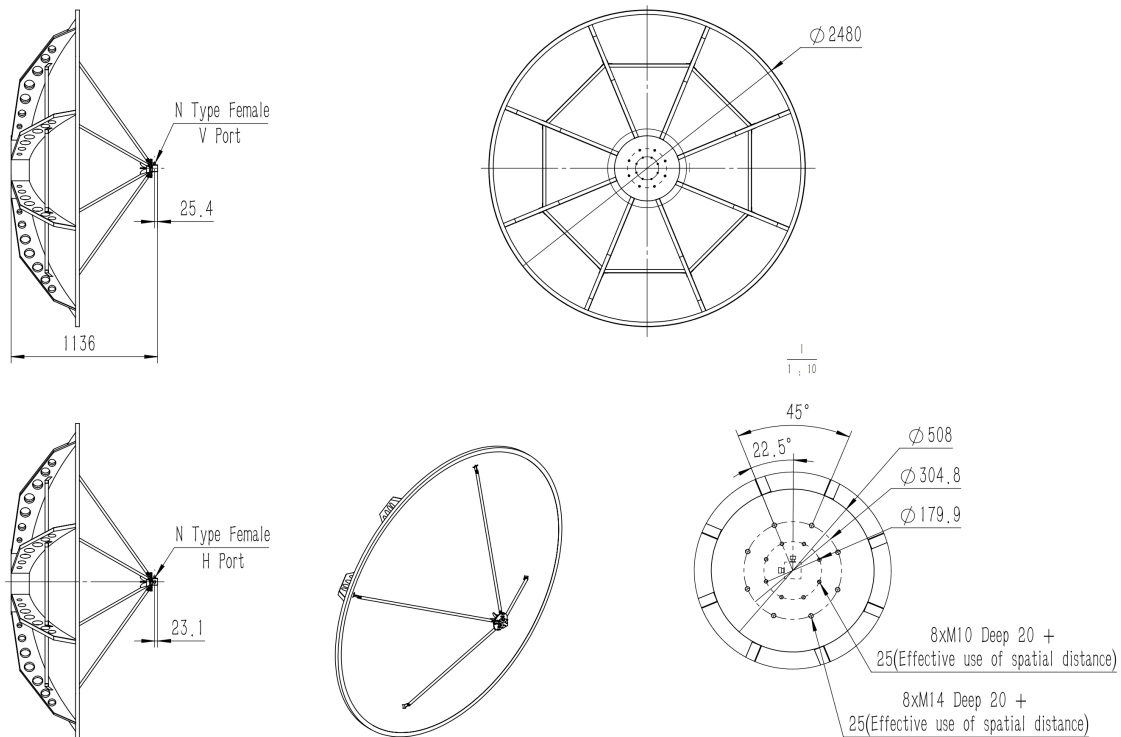

## Test Results

### 1. Gain & Antenna Factor

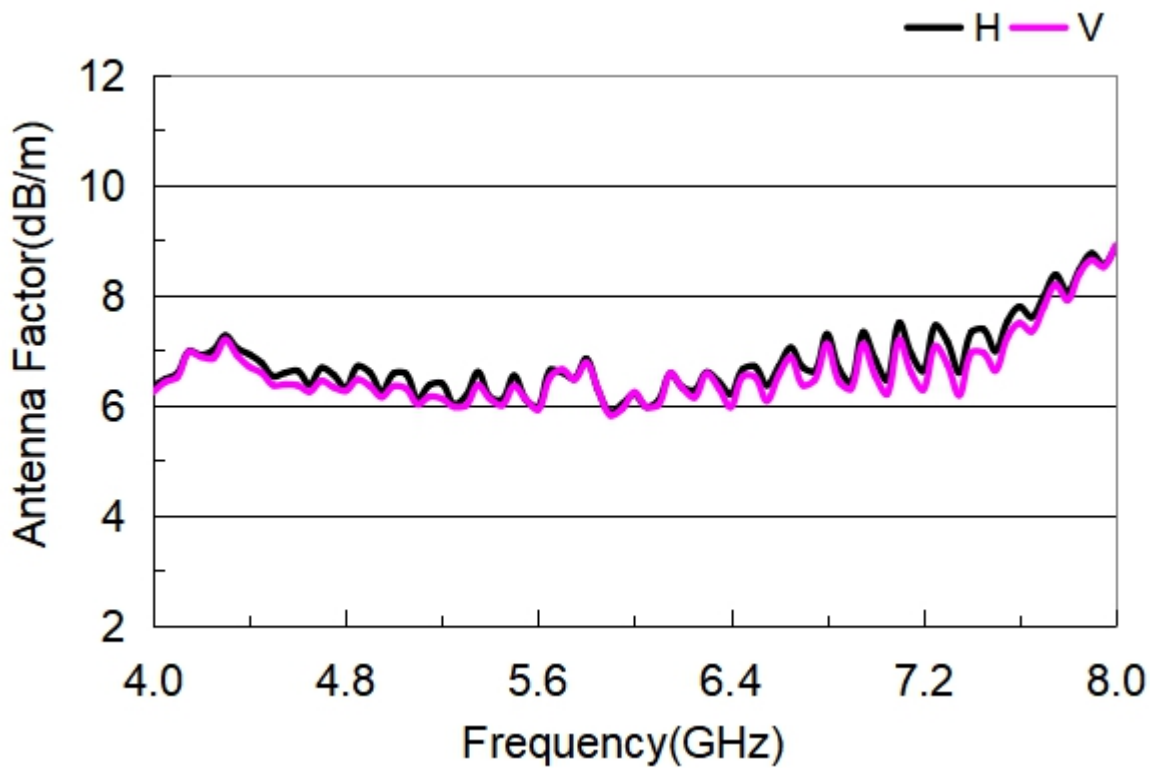
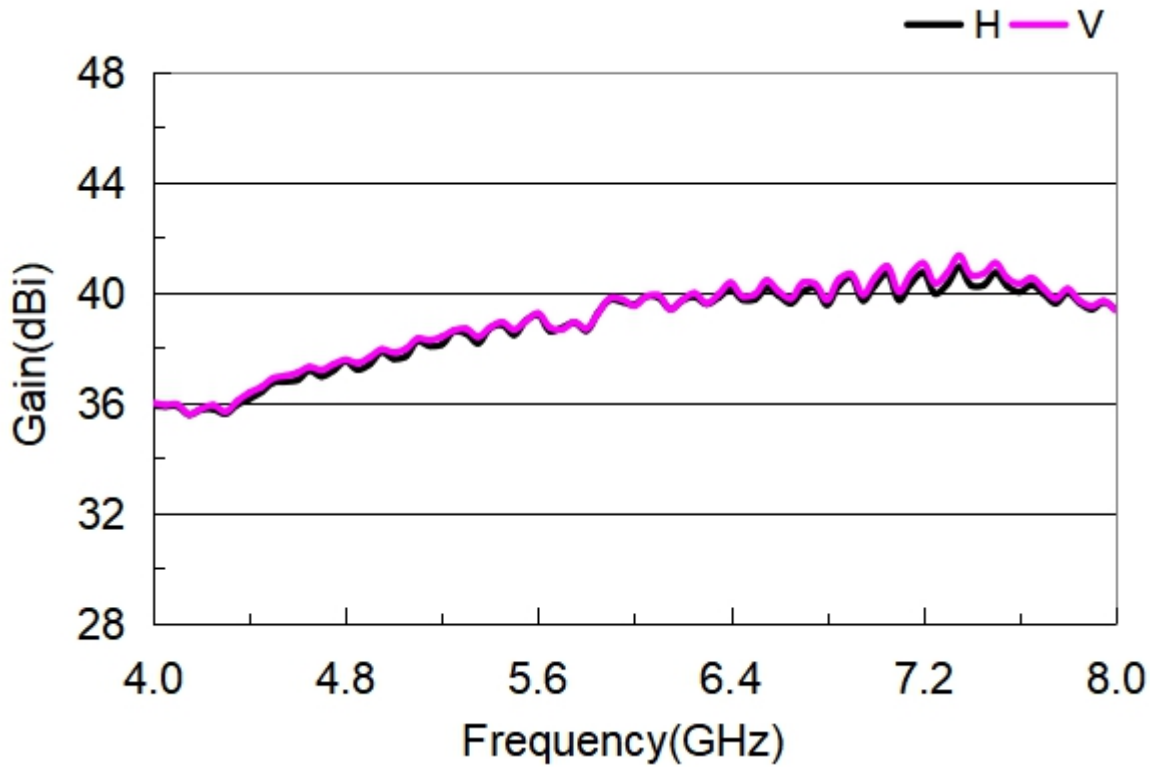

## 2. Cross Polarization Isolation

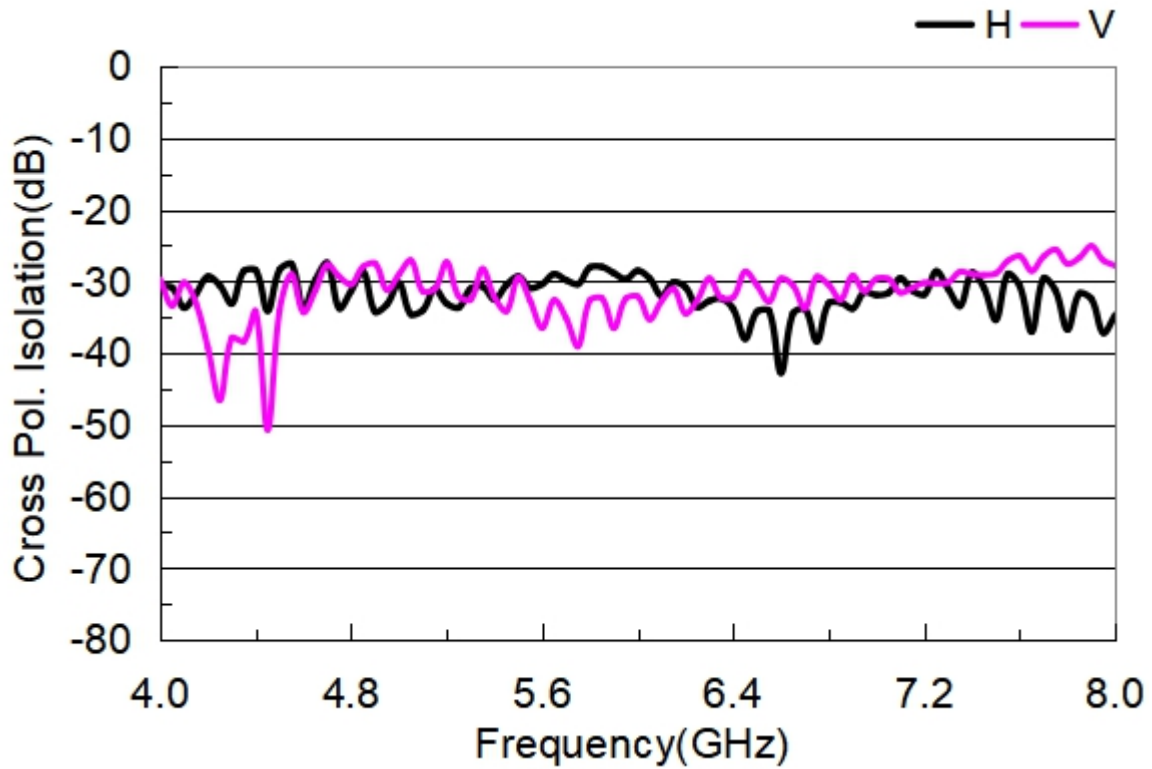

## 3. Port to Port Isolation

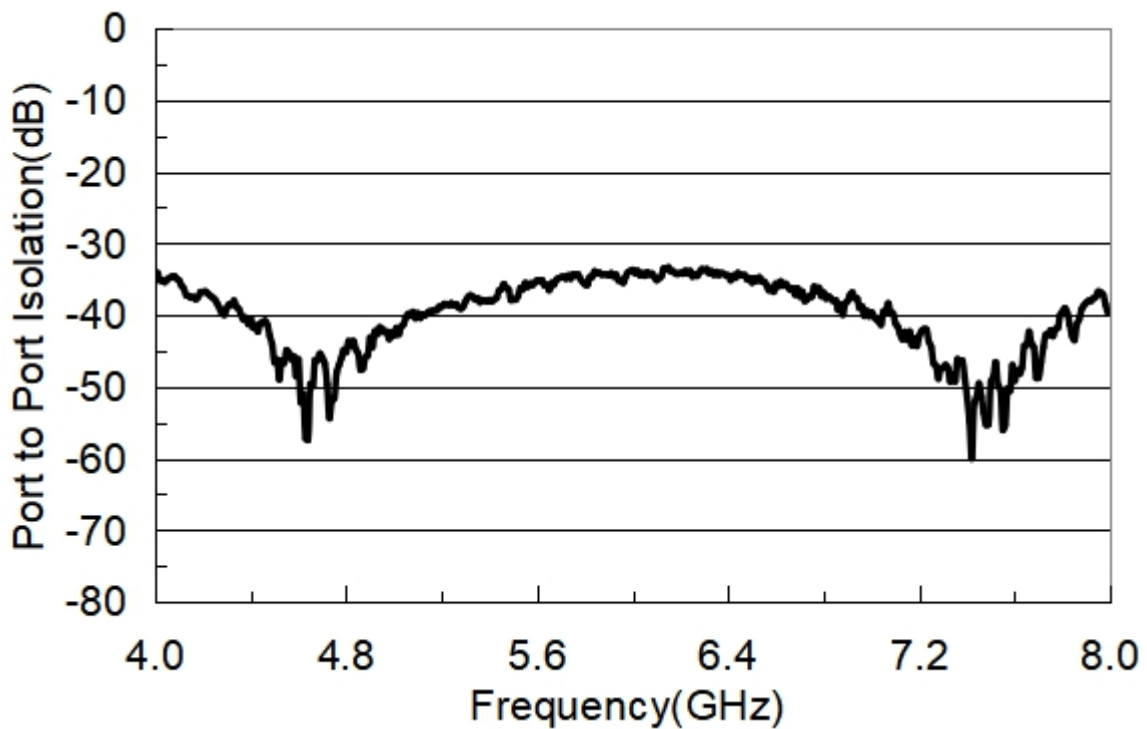

## 4. VSWR Port-H

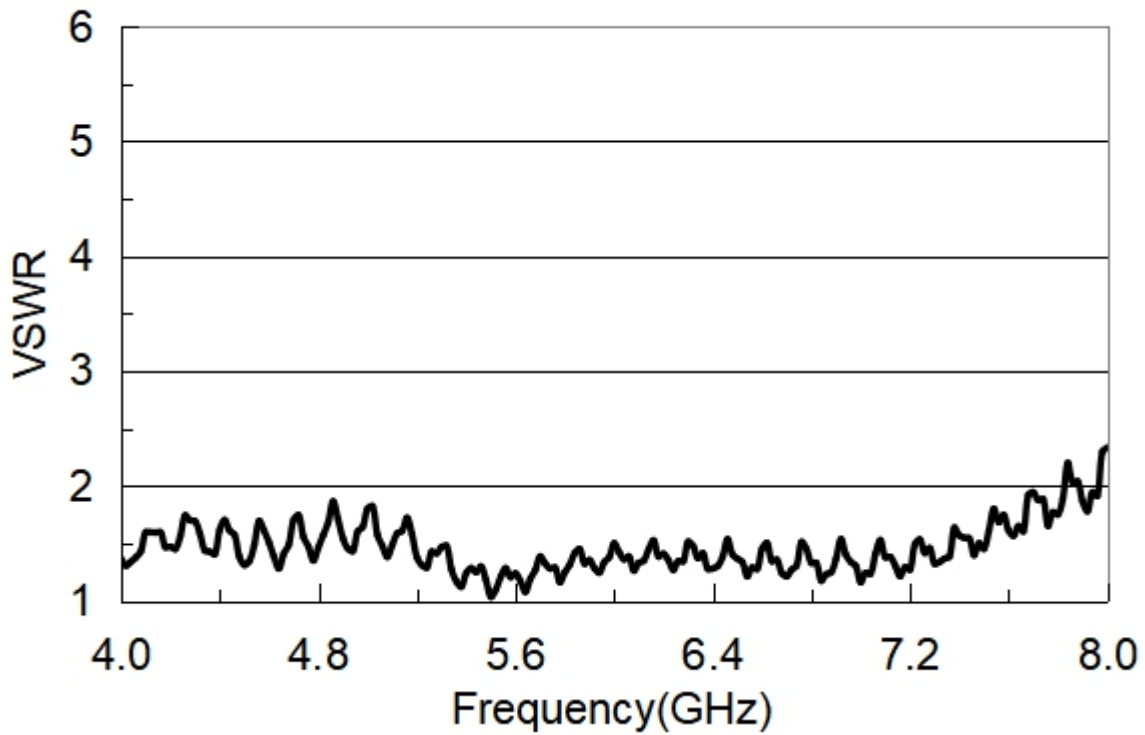

## Port-V

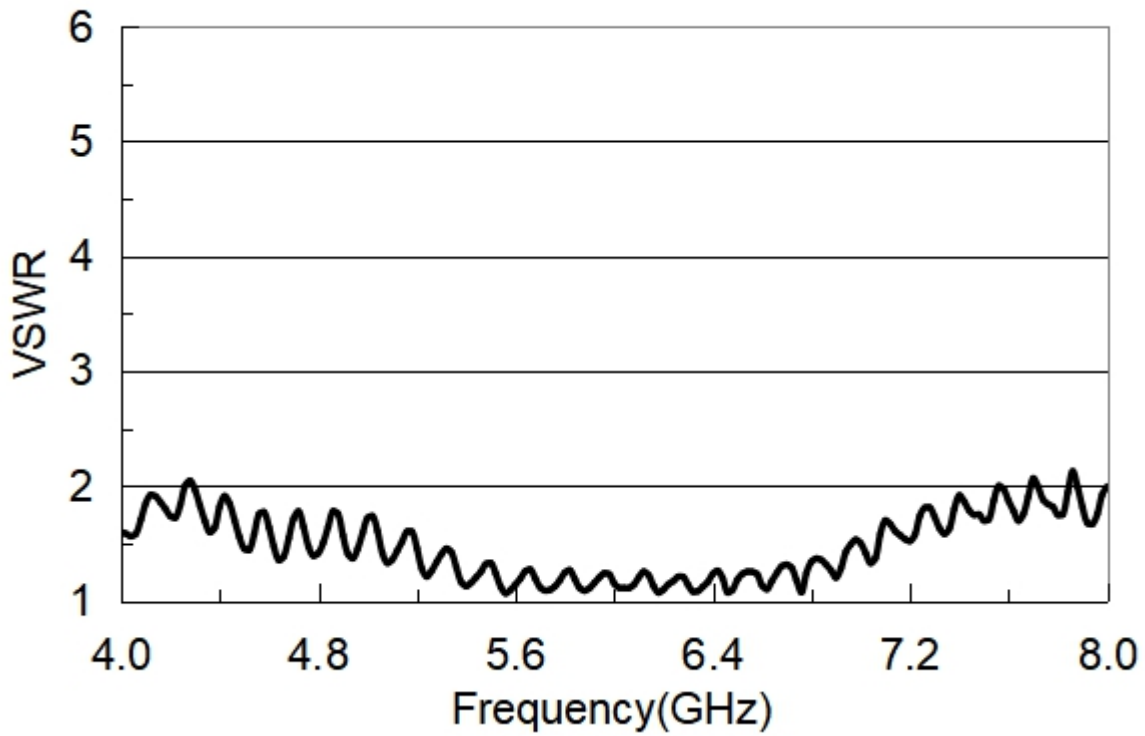

## 5. Pattern

