

AdvanTrack-200™

Overhead inventory system
with beam steering

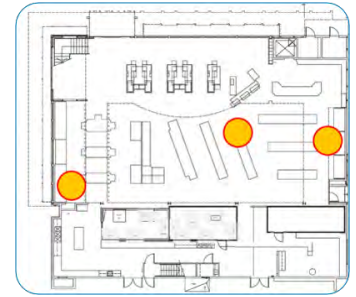



Benefits:

- Persistent inventory
- Reduction of stock-outs
- Fast location of products
- Detection of misplaced items
- Shrinkage reduction

Applications:

- Retail stores
- Hospitals
- Low height warehouses

Product overview

AdvanTrack is an RFID-based system that provides **inventory in real time** of all tagged items located in a given space. Examples of such spaces are retail stores, small warehouses, hospital areas, etc.

AdvanTrack also supplies the **approximate location** of each tagged item in real time.

AdvanTrack uses overhead antenna+reader systems with **beam steering** functionality that scan the area below them identifying the RFID tags.

Thanks to this beam steering functionality, AdvanTrack achieves higher read-rate and wider scan area than systems using stationary antennas.



AdvanTrack steers the beam in two directions, and has four beam orientations in each direction, giving a total of **16 beam orientations** that form a 4 x 4 matrix.

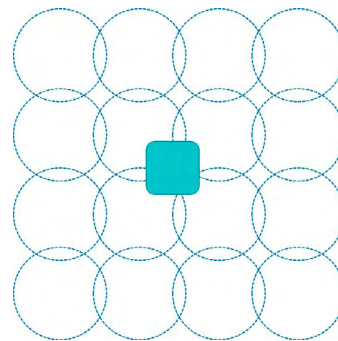

Each AdvanTrack antenna covers an area of approximately 4 x 4 meters. This area may vary depending on, for instance, the height of the system, type of tag used, position of the tags, or type and distribution of tagged products.

The different beam orientations are usually sequentially activated, obtaining the identification and estimation of the position of each tagged item every few seconds.

By providing real time inventory and location, AdvanTrack can reduce stock-outs, detect misplaced items, and reduce theft. Additionally, it helps finding products much faster, which may lead to more satisfied customers and more productive employees.

The antennas have circular polarization, which makes the read rate less dependant on the orientation of the tags versus the antennas.



Product description

AdvanTrack uses **primary units** and **secondary units**:

- The primary unit has an integrated reader and four antennas with beam steering.
- The secondary unit comprises the same but without the reader.

One secondary unit can be connected up to one primary unit.
This reduces the retailers' costs when monitoring wide areas.

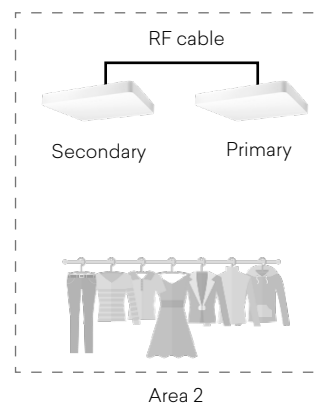
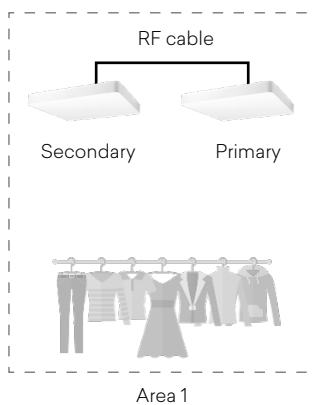

AdvanTrack can be ordered in 2 models:

- Suspended wires mount
- Ceiling mount

Technical specifications



Operating Frequency	FCC (NA, SA) (902 - 928) MHz ETSI (EU, IN) (865.6 - 867.6) MHz MIC (KR) (910 - 914) MHz SRRC-MII (P.R.China) (920.125 - 924.875) MHz (1) Australia (AU) (920.750 - 925.250) MHz New Zealand (NZ) (922.250 - 927.250) MHz Israel (IS) (915.0 - 917.0) MHz (2) Japan (JP) (916.8 - 920.8) MHz (3) Brazil (902 - 907.5) MHz (915 - 928) MHz by using channel selection Chile (916 - 928) MHz by using channel selection Peru (916 - 928) MHz by using channel selection Taiwan (922 - 928) MHz by using channel selection Open Region (4) (865 - 869) MHz and (902 - 928) MHz (by using channel selection) (5)
Detection Height	Maximum: 4 m (Select the height with caution. Read distance depends highly on tag model and tagged products)
Radiation Pattern	Multiple beam
Beamwidth	45° / 45° (surrounding widths of all beams)
Polarization	Circular
Signal Light	Light Emitting Diode (LED) Operation LED - Master units only
Power Supply	Power over Ethernet
Energy Consumption	< 14 W max., < 3 W idle
Reader Power	Maximum 31,5 dBm (may be limited to conform to country or area regulations) Recommended max. 30 dBm
Radiated Power	2 W ERP, 3.2 W EIRP
Interface	Ethernet and USB
Connectors	SMA
Transponder Protocol Standard	EPC Class1 Gen2
Operating System	Linux - Fully open
Temperature Range	-20°C to +50°C
Dimensions	Suspension mount 460 mm x 460 mm x 80 mm 18.1 inches x 18.1 inches x 3.1 inches Ceiling mount 460 mm x 460 mm x 121.5 mm 18.1 inches x 18.1 inches x 4.8 inches
Weight	Suspension mount Master unit: 5.800 Kg (12.8 lb) Slave unit: 5.140 Kg (11.3 lb) Ceiling mount Master unit: 6.520 Kg (14.4 lb) Slave unit: 5.860 Kg (12.9 lb)
Material Housing	Aluminum and methacrylate
Color	Off white
Human Exposure	EN 50364
EMC	EN 301 489, EN 300 220
Air Interface (EU)	EN 302 208 v1.2

(1) PRC band is only available in CH version.

(2) Israeli band is only available in CH version.

(3) Japanese band is only available in CH version. RF conducted power is limited to 30 dBm.

(4) Open channel specified applies to ETSI/FCC versions. CH versions open channel is defined

between 840 to 845 MHz and 920 to 925 MHz.

(5) Band is defined as a carrier sub-set from FCC. There is no specific Surface Acoustic Wave

(SAW) filter for the band. Given the maximum conducted power there shouldn't be problems

with local regulation.



Mechanical specifications

Suspension mount

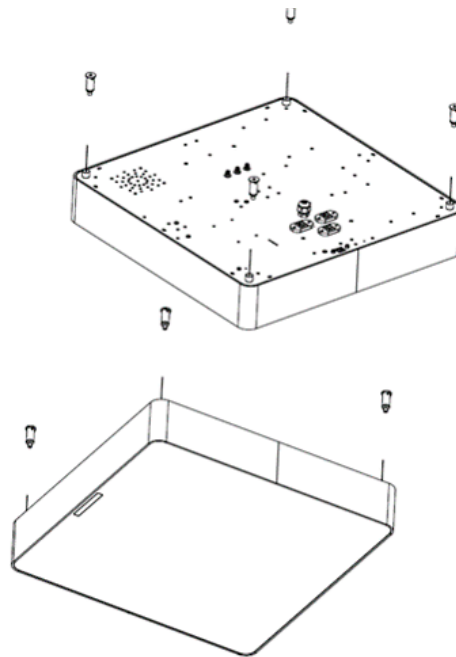
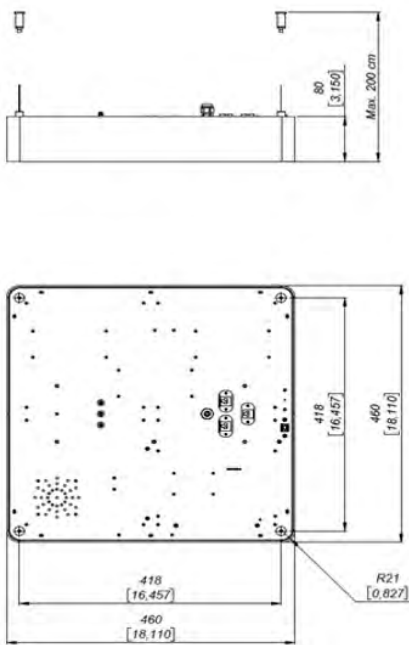

Ceiling mount

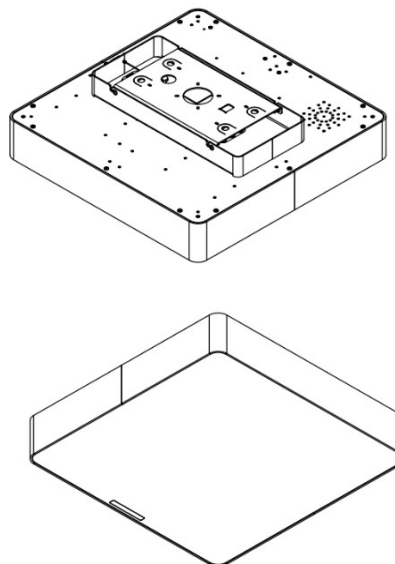
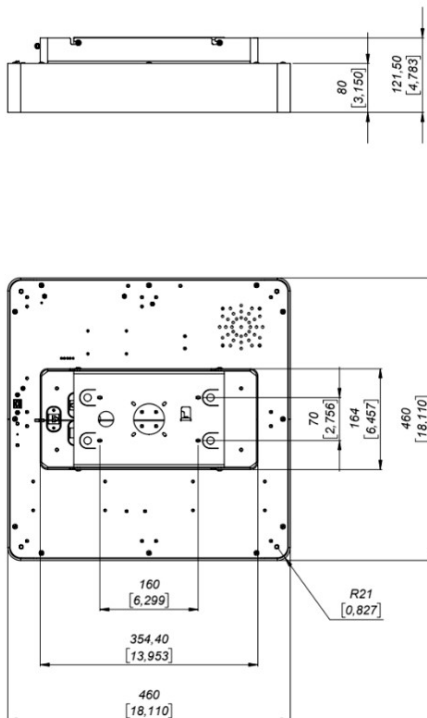

Units in millimeters and [inches]

Product codes for ordering

ADTR	-	o	t	m	FF	-	BS	-	mmm	
										o = overhead
		o								overhead
										t = type
			m							primary
			s							secondary
										m = mount
				c						Ceiling mount (attached to the ceiling or suspended with a pole, pole not included)
				s						Suspended with metallic wires (included)
										FF = frequency band
					EU					865,6 MHz - 867,6 MHz
					US					902,0 MHz - 928,0 Mhz
					CH					For China, Japan and Israel
										BS = beam shape
							22			Pencil beam shape (maximum gain)
										Model
									200	model number

Examples:

ADTR-omsEU-22-200:

- AdvanTrack
- Overhead
- Primary unit
- Suspension mount
- ETSI frequency band
- Pencil beam shape
- Model 200

ADTR-oscUS-22-200:

- AdvanTrack
- Overhead
- Secondary unit
- Ceiling mount (attached to the ceiling or suspended with a pole)
- FCC frequency band
- Pencil beam shape
- Model 200





Copyright © Keonn Technologies S.L.
All rights reserved.

Information in this publication
supersedes all earlier versions.
Specifications subject to change
without notice.

