

CPC304

Fastwel 
Creating the Future!

PC/104-Plus AMD Geode LX800 based SBC

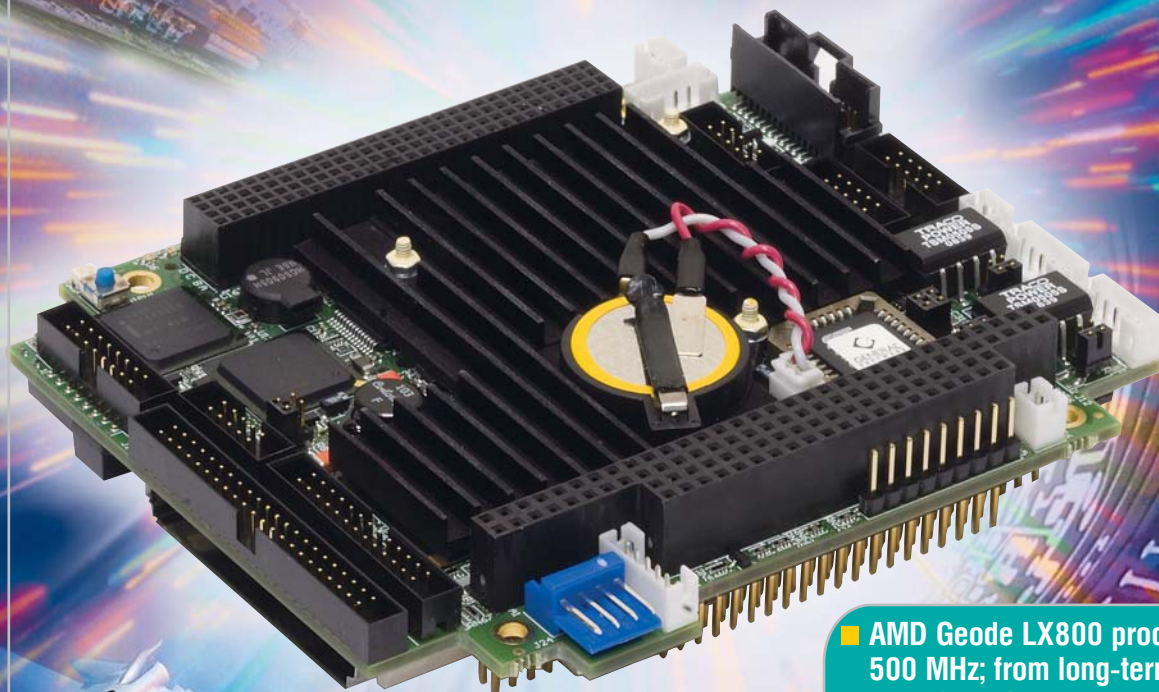
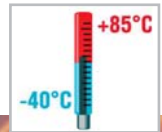

- AMD Geode LX800 processor; 500 MHz; from long-term manufacturing program
- PC/104 and PC/104-Plus expansion modules support; 16-bit ISA and 32-bit PCI buses
- 256 MB soldered DDR SDRAM
- Supported resolutions up to 1920x1440; VGA and LVDS interfaces; LCD panels support
- Soldered NAND flash disk 128 MB
- CompactFlash Type I/II socket
- Two 10/100-BaseT Fast Ethernet ports
- Two USB 2.0; four COM ports
- Industrial operating temperature range: -40°C to +85°C
- Protective coating (option)

Best solutions to fit your demands!



Features

- AMD Geode LX800 processor; 500 MHz
- 256 MB soldered DDR SDRAM
- PC/104 and PC/104-Plus expansion modules support; 16-bit ISA and 32-bit PCI buses
- Supported resolutions up to 1920×1440; VGA and LVDS interfaces; LCD panels support
- Soldered NAND flash disk 128 MB
- CompactFlash Type I/II socket
- Two 10/100-BaseT Fast Ethernet ports
- Two USB 2.0; four COM ports (two isolated RS-232/485 ports)
- Industrial operating temperature range: -40°C to +85°C
- Protective coating (option)

Overview

CPC304 is a PC/104-Plus single board computer for embedded applications. It is designed for use in mission critical on-board systems requiring low power consumption and wide operating temperature range. CPC304 architecture is based on AMD Geode LX800 CPU and AMD CS5536 I/O companion. CPC304 provides full support for PC/104 and PC/104-Plus expansion modules and data exchange via both 16-bit ISA and 32-bit PCI buses.

All key components including CPU, chipset, memory, and periphery controllers are soldered on-board providing excellent vibration stability and increased efficiency of protective conformal coating.

CPC304 offers wide variety of data display capabilities. System developers can take advantage of simultaneous operation of standard VGA interface with resolution up to 1920×1440, 24-bit LVDS interface, and 18-bit interface for TFT or DSTN LCD panels connection.

Data storage subsystem is based on single-channel IDE controller, that is able to drive any two devices out of a number of selected in BIOS Setup and available for connection IDE devices: two external hard drives connected via on-board connectors, CompactFlash card, or soldered on-board 128 MB flash disk.

For data exchange, CPC304 uses two independent Fast Ethernet ports, four COM ports, two USB 2.0 ports, and eight programmable discrete input/output lines.

System control and management capabilities of CPC304 include two watchdog timers, opto-isolated remote reset input, external signal system wake-up controller, reserved BIOS, and possibility to save system configuration and emergency parameters in FRAM chip.

CPC304 is manufactured in two versions: CPC304-01, full function version, and CPC304-02, "light-weight" version without LVDS interface and on-board 128 MB NAND flash disk, with one Fast Ethernet channel and two COM ports.

CPC304 is designed for operation within industrial temperature range from -40°C to +85°C.

CPC304 supports wide range of operating systems — MS DOS, QNX, Windows XPe, Windows CE, RTOS32, and Linux.

Technical Specifications

System

- CPU: AMD Geode LX 800 (500 MHz): 32-bit x86 kernel, 64-bit coprocessor, 64-bit memory bus; 64 KB L1, 128 KB L2; MMX[®], 3DNow![™] technologies support
- 256 MB soldered PC333 DDR SDRAM
- MTBF: 170 000 hours

Flash BIOS

- General[®] Software
- 2 x 512 KB, reserved
- In-system modification

Graphics

- Video controller: 2D accelerator, video memory up to 64 MB (shared with system)
- LCD (TFT or DSTN) panels support, resolutions up to 1024×768 at 60 Hz, 18-bit color depth via TFT interface, 24-bit via LVDS interface
- RGB monitor support, resolutions up to 1600×1200 at 85 Hz or 1920×1440 at 75 Hz, 32 bit

Storage

- Flash disk: soldered, 128 MB NAND flash, IDE interface
- CompactFlash Type I/II socket
- EIDE: one primary channel, up to two devices connection (when flash disk is disabled in BIOS Setup and there is no storage device in CompactFlash socket), UltraDMA/100 support

Software support

- Fastwel DOS[™] (MS[™] DOS compatible)
- QNX 6.3x, QNX 4.25
- Windows XPE, CE
- RTOS32
- Linux 2.4.20

Interfaces

- Two Fast Ethernet controllers, 10/100 Base-T (10/100 Mb/s)
- USB 1.1, USB 2.0 support, up to two devices connection
- Shared FDD/LPT connector: FDD controller and universal parallel port with EPP and ECP support share one connector
- Serial ports:
COM1, COM2: RS232, full control, up to 115.2 Kb/s

COM3, COM4: RS422 / RS485, isolated, up to 115.2 Kb/s

- Console operation via COM1 serial port
- Audio controller: AC-97 compatible, stereo line input/output, microphone input
- PS/2: keyboard and mouse port
- Digital input/output: eight 8-bit input/output lines, individually programmable
- External PME signal use: awakens a sleeping system in response to an external wake-up signal
- CMOS+SFRAM for storage of configuration parameters
- RTC with lithium battery
- Opto-isolated reset/interrupt
- Two watchdog timers: one programmable timer, one hardware based timer with fixed timeout period

Mechanical

- Dimensions: 115.6×101.5×23.7 mm (4.55"×4"×0.93")
- Weight: 0.1 kg

Power requirements

- 5 V ±5%, 1.3 A

Environmental conditions

- Operating temperature range: -40°C to +85°C
- Storage temperature range: -55°C to +90°C
- Humidity: 0% to 95%, non-condensing
- Shocks/vibration: 50G/3G

List of deliverables

- CPC304 module with heatsink installed
- Ribbon cable for 2.5" HDD connection, 44 threads
- Adapter for 3.5" HDD and CDROM drive connection
- IDC10-DB9 adapter cable for connection of a console to COM port
- Lithium battery
- CD with software and documentation
- Package

Warranty:

- 3 years for parts and labor

Board Layout

Top view

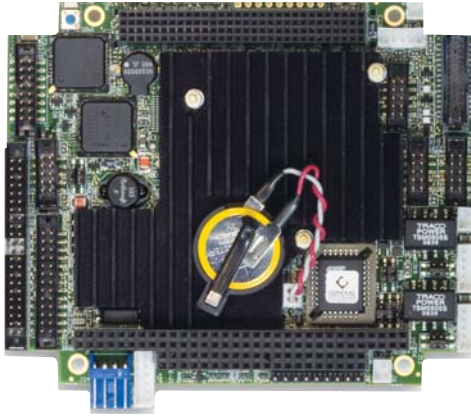

Bottom view

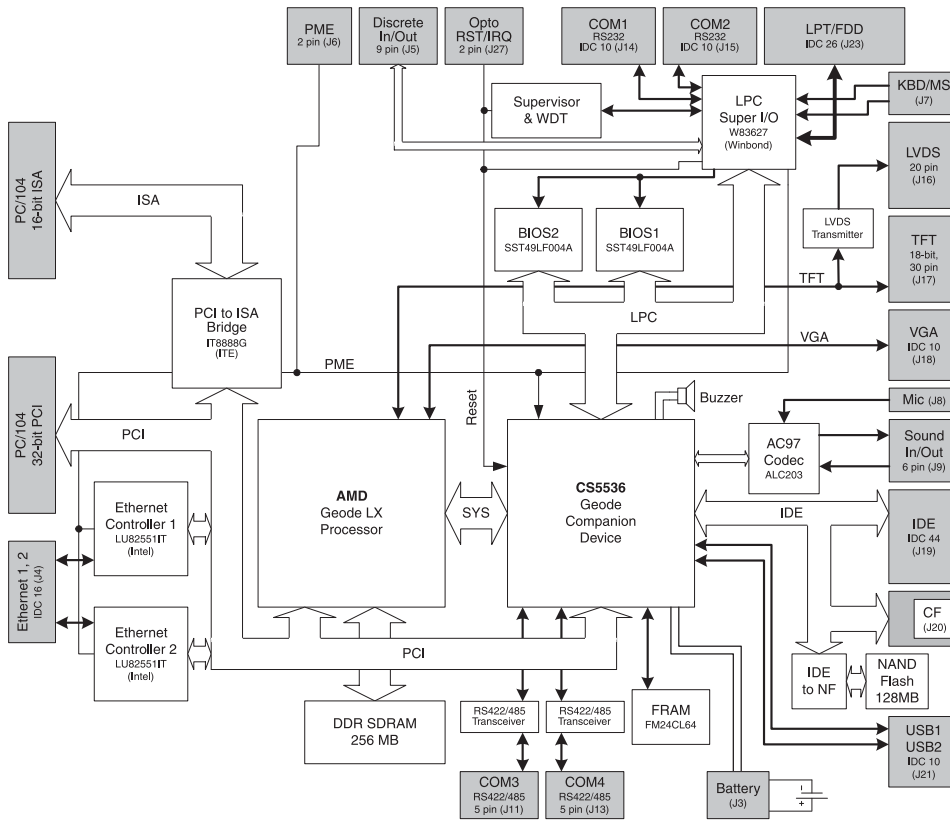
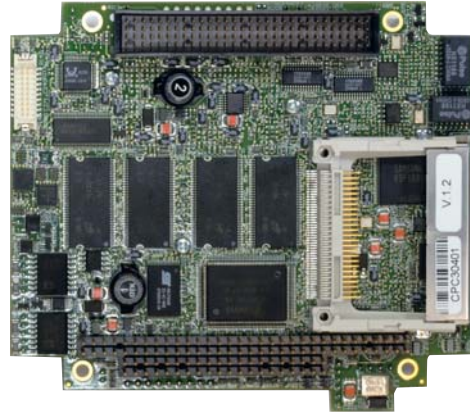

Accessories

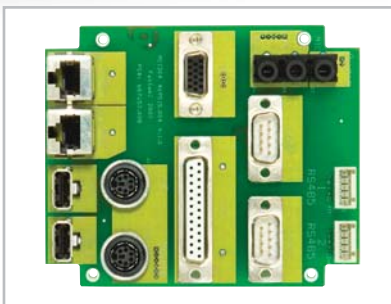

Top view

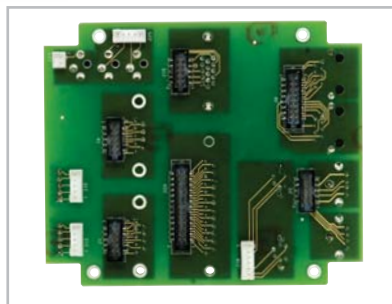

Bottom view

KIB380 Interface Adapter Module for CPC304

KIB380 makes interfaces of the processor module available via standard PC connectors – VGA, Audio (Mic, Line In, Line Out), four COM ports, two LAN, two USB, two PS/2 for keyboard and mouse, and LPT.

Please, see User Manual for details.

CPC304

PC/104-Plus AMD Geode LX800 based SBC

Ordering Information

CPC304 Configuration

CPC304 - 01 \Options

Device Type

CPC304-01 PC/104-Plus board, AMD Geode LX800 500 MHz CPU, AMD CS5536 I/O, RAM 256 MB, VGA, LCD, LVDS, 16-bit ISA, 32-bit PCI, 2 Ethernet 10/100 Base-T, IDE flash disk 128 MB, CompactFlash socket, 2 USB 2.0, COM1- COM4, -40°C to +85°C

CPC304-02 PC/104-Plus board, AMD Geode LX800 500 MHz CPU, AMD CS5536 I/O, RAM 256 MB, VGA, LCD, 16-bit ISA, 32-bit PCI, 1 Ethernet 10/100 Base-T, CompactFlash socket, 2 USB 2.0, COM1- COM2, -40°C to +85°C

Options

\xxx Choose available options from the table

CPC304 Available Options

Compact Flash Module	
\CF1024	1024 MB Compact Flash, industrial
\CF2G	2 GB Compact Flash, industrial
\CF4G	4 GB Compact Flash, industrial
\CF8G	8 GB Compact Flash, industrial
\CF16G	16 GB Compact Flash, industrial
Coating	
\COATED	Protective Coating
Operating System Presetting	
\FDOS	Fastwel DOS
\QNX	QNX 6
\WCE	Windows CE
\LNX	Linux 2.4.20

Other configurations and options are available upon request.

Example

CPC304-01\CF1024\COATED\WCE

PC/104-Plus board, AMD Geode LX800 500 MHz CPU, AMD CS5536 I/O, RAM 256 MB, VGA, LCD, LVDS, 16-bit ISA, 32-bit PCI, 2 Ethernet 10/100 Base-T, IDE flash disk 128 MB, CompactFlash socket, 2 USB 2.0, COM1- COM4, -40°C to +85°C
1024MB Compact Flash, industrial
Protective coating
Windows CE

Ver. 1.2 2009

Product specifications are subject to change without notice

Applications



Mobile



Industrial Automation



Communications



Embedded

READY FOR



RoHS

