

# PG SERIES

## Laminated transformers EI30/5 - 0,6 VA

### Features

- Frequency - 50/60 Hz
- Temperature class - Class B (130°C)
- Ambient temperature (ta) - 70°C
- Insulation voltage - 3750 Vrms
- Split bobbin
- Potted under vacuum
- Degree of protection - IP00
- Short-circuit proof
- The insulation construction of the products are suitable for VDE, UL standard
- V. Secondary tolerance:  $\pm 5\%$
- Weight: 60 gr

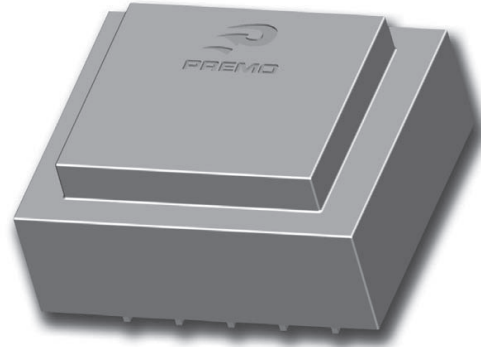

### Electrical specifications

Reference Part Number	Primary Vac	Secondary Rating		Secondary no load Vac	Schematic number
		Vac	mA		
PG30US-060-100	115	6	100	10,4	1
PG30US-090-067	115	9	67	15,6	1
PG30US-120-050	115	12	50	20,8	1
PG30US-150-040	115	15	40	25,4	1
PG30US-180-033	115	18	33	29,5	1
PG30US-240-025	115	24	25	38,1	1
PG30MS-060-100	2x115	6	100	10,4	3
PG30MS-090-067	2x115	9	67	15,6	3
PG30MS-120-050	2x115	12	50	20,8	3
PG30MS-150-040	2x115	15	40	25,4	3
PG30MS-180-033	2x115	18	33	29,5	3
PG30MS-240-025	2x115	24	25	38,1	3
PG30S-060-100	230	6	100	10,4	1
PG30S-090-067	230	9	67	15,6	1
PG30S-120-050	230	12	50	20,8	1
PG30S-150-040	230	15	40	25,4	1
PG30S-180-033	230	18	33	29,5	1
PG30S-240-025	230	24	25	38,1	1
PG30UD-060-100	115	2x6	50	2x10,6	2
PG30UD-090-033	115	2x9	33	2x15,5	2
PG30UD-120-025	115	2x12	25	2x19,7	2
PG30UD-150-020	115	2x15	20	2x24,8	2
PG30UD-180-017	115	2x18	17	2x29,8	2
PG30UD-240-012	115	2x24	12	2x39,1	2
PG30MD-060-050	2x115	2x6	50	2x10,6	4
PG30MD-090-033	2x115	2x9	33	2x15,5	4
PG30MD-120-025	2x115	2x12	25	2x19,7	4
PG30MD-150-020	2x115	2x15	20	2x24,8	4
PG30MD-180-017	2x115	2x18	17	2x29,8	4
PG30MD-240-012	2x115	2x24	12	2x39,1	4
PG30D-060-050	230	2x6	50	2x10,6	2
PG30D-090-033	230	2x9	33	2x15,5	2
PG30D-120-025	230	2x12	25	2x19,7	2
PG30D-150-020	230	2x15	20	2x24,8	2
PG30D-180-017	230	2x18	17	2x29,8	2
PG30D-240-012	230	2x24	12	2x39,1	2

# PG SERIES

## Laminated transformers EI30/12,5 - 1,0 VA

### Features

- Frequency - 50/60 Hz
- Temperature class - Class B (130°C)
- Ambient temperature (ta) - 70°C
- Insulation voltage - 3750 Vrms
- Split bobbin
- Potted under vacuum
- Degree of protection - IP00
- Short-circuit proof
- The insulation construction of the products are suitable for VDE, UL standard
- V. Secondary tolerance:  $\pm 5\%$
- Weight: 80 gr

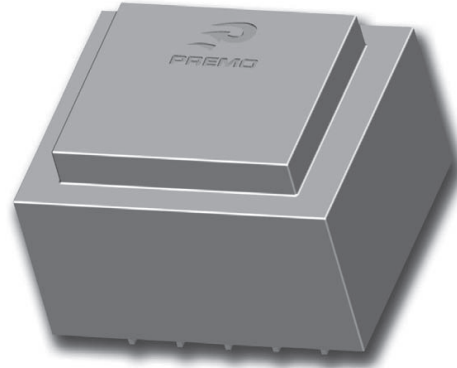

### Electrical specifications

Reference Part Number	Primary Vac	Secondary Rating		Secondary no load Vac	Schematic number
		Vac	mA		
PG30US-060-167	115	6	167	8,5	1
PG30US-090-111	115	9	111	12,45	1
PG30US-120-083	115	12	83	16,3	1
PG30US-150-067	115	15	67	20,2	1
PG30US-180-056	115	18	56	24,2	1
PG30US-240-042	115	24	42	32,2	1
PG30MS-060-167	2x115	6	167	8,5	3
PG30MS-090-111	2x115	9	111	12,45	3
PG30MS-120-083	2x115	12	83	16,3	3
PG30MS-150-067	2x115	15	67	20,2	3
PG30MS-180-056	2x115	18	56	24,2	3
PG30MS-240-042	2x115	24	42	32,2	3
PG30S-060-167	230	6	167	8,5	1
PG30S-090-083	230	9	111	12,45	1
PG30S-120-083	230	12	83	16,3	1
PG30S-150-067	230	15	67	20,2	1
PG30S-180-056	230	18	56	24,2	1
PG30S-240-042	230	24	42	32,2	1
PG30UD-060-083	115	2x6	83	2x8,3	2
PG30UD-090-056	115	2x9	56	2x11,9	2
PG30UD-120-042	115	2x12	42	2x16,2	2
PG30UD-150-033	115	2x15	33	2x20,4	2
PG30UD-180-028	115	2x18	28	2x24,2	2
PG30UD-240-021	115	2x24	21	2x32,1	2
PG30MD-060-083	2x115	2x6	83	2x8,3	4
PG30MD-090-056	2x115	2x9	56	2x11,9	4
PG30MD-120-042	2x115	2x12	42	2x16,2	4
PG30MD-150-033	2x115	2x15	33	2x20,4	4
PG30MD-180-028	2x115	2x18	28	2x24,2	4
PG30MD-240-021	2x115	2x24	21	2x32,1	4
PG30D-060-083	230	2x6	83	2x8,3	2
PG30D-090-056	230	2x9	56	2x11,9	2
PG30D-120-042	230	2x12	42	2x16,2	2
PG30D-150-033	230	2x15	33	2x20,4	2
PG30D-180-028	230	2x18	28	2x24,2	2
PG30D-240-021	230	2x24	21	2x32,1	2

# PG SERIES

## Laminated transformers EI30/12,5 - 1,5 VA

### Features

- Frequency - 50/60 Hz
- Temperature class - Class B (130°C)
- Ambient temperature (ta) - 70°C
- Insulation voltage - 3750 Vrms
- Split bobbin
- Potted under vacuum
- Degree of protection - IP00
- Short-circuit proof
- The insulation construction of the products are suitable for VDE, UL standard
- V. Secondary tolerance:  $\pm 5\%$
- Weight: 80 gr



### Electrical specifications

Reference Part Number	Primary Vac	Secondary Rating		Secondary no load Vac	Schematic number
		Vac	mA		
PG30US-060-250	115	6	250	8,95	1
PG30US-090-167	115	9	167	12,9	1
PG30US-120-125	115	12	125	16,7	1
PG30US-150-100	115	15	100	24,7	1
PG30US-180-083	115	18	83	29,5	1
PG30US-240-062	115	24	62	35,8	1
PG30MS-060-250	2x115	6	250	8,95	3
PG30MS-090-167	2x115	9	167	12,9	3
PG30MS-120-125	2x115	12	125	16,7	3
PG30MS-150-100	2x115	15	100	24,7	3
PG30MS-180-083	2x115	18	83	29,5	3
PG30MS-240-062	2x115	24	62	35,8	3
PG30S-060-250	230	6	250	8,95	1
PG30S-090-167	230	9	167	12,9	1
PG30S-120-125	230	12	125	16,7	1
PG30S-150-100	230	15	100	24,7	1
PG30S-180-083	230	18	83	29,5	1
PG30S-240-062	230	24	62	35,8	1
PG30UD-060-125	115	2x6	125	2x9,15	2
PG30UD-090-083	115	2x9	83	2x13,7	2
PG30UD-120-062	115	2x12	62	2x17,3	2
PG30UD-150-050	115	2x15	50	2x24,7	2
PG30UD-180-042	115	2x18	42	2x29,4	2
PG30UD-240-031	115	2x24	31	2x35,8	2
PG30MD-060-125	2x115	2x6	125	2x9,15	4
PG30MD-090-083	2x115	2x9	83	2x13,7	4
PG30MD-120-062	2x115	2x12	62	2x17,3	4
PG30MD-150-050	2x115	2x15	50	2x24,7	4
PG30MD-180-042	2x115	2x18	42	2x29,4	4
PG30MD-240-031	2x115	2x24	31	2x35,8	4
PG30D-060-125	230	2x6	125	2x9,15	2
PG30D-090-083	230	2x9	83	2x13,7	2
PG30D-120-062	230	2x12	62	2x17,3	2
PG30D-150-050	230	2x15	50	2x24,7	2
PG30D-180-042	230	2x18	42	2x29,4	2
PG30D-240-031	230	2x24	31	2x35,8	2

# PG SERIES

## Laminated transformers EI30/15,5 - 2,1 VA

### Features

- Frequency - 50/60 Hz
- Temperature class - Class B (130°C)
- Ambient temperature (ta) - 70°C
- Insulation voltage - 3750 Vrms
- Split bobbin
- Potted under vacuum
- Degree of protection - IP00
- Short-circuit proof
- The insulation construction of the products are suitable for VDE, UL standard
- V. Secondary tolerance:  $\pm 5\%$
- Weight: 100 gr

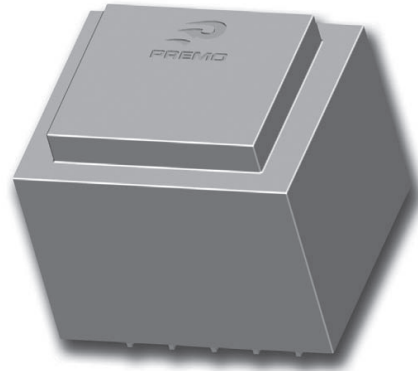

### Electrical specifications

Reference Part Number	Primary Vac	Secondary Rating		Secondary no load Vac	Schematic number
		Vac	mA		
PG30US-060-350	115	6	350	10,5	1
PG30US-090-234	115	9	234	14,6	1
PG30US-120-176	115	12	176	20	1
PG30US-150-140	115	15	140	26	1
PG30US-180-118	115	18	118	29,6	1
PG30US-240-88	115	24	88	37,2	1
PG30MS-060-350	2x115	6	350	10,5	3
PG30MS-090-234	2x115	9	234	14,6	3
PG30MS-120-176	2x115	12	176	20	3
PG30MS-150-140	2x115	15	140	26	3
PG30MS-180-118	2x115	18	118	29,6	3
PG30MS-240-088	2x115	24	88	37,2	3
PG30S-060-350	230	6	350	10,5	1
PG30S-090-234	230	9	234	14,6	1
PG30S-120-176	230	12	176	20	1
PG30S-150-140	230	15	140	26	1
PG30S-180-118	230	18	118	29,6	1
PG30S-240-088	230	24	88	37,2	1
PG30UD-060-175	115	2x6	175	2x8,7	2
PG30UD-090-117	115	2x9	117	2x14,6	2
PG30UD-120-088	115	2x12	88	2x19,45	2
PG30UD-150-070	115	2x15	70	2x24,1	2
PG30UD-180-059	115	2x18	59	2x29,1	2
PG30UD-240-044	115	2x24	44	2x36,5	2
PG30MD-060-175	2x115	2x6	175	2x8,7	4
PG30MD-090-117	2x115	2x9	117	2x14,6	4
PG30MD-120-088	2x115	2x12	88	2x19,45	4
PG30MD-150-070	2x115	2x15	70	2x24,1	4
PG30MD-180-059	2x115	2x18	59	2x29,1	4
PG30MD-240-044	2x115	2x24	44	2x36,5	4
PG30D-060-175	230	2x6	175	2x8,7	2
PG30D-090-117	230	2x9	117	2x14,6	2
PG30D-120-088	230	2x12	88	2x19,45	2
PG30D-150-070	230	2x15	70	2x24,1	2
PG30D-180-059	230	2x18	59	2x29,1	2
PG30D-240-044	230	2x24	44	2x36,5	2

# PG SERIES

## Laminated transformers EI30/18 - 2,3 VA

### Features

- Frequency - 50/60 Hz
- Temperature class - Class B (130°C)
- Ambient temperature (ta) - 70°C
- Insulation voltage - 3750 Vrms
- Split bobbin
- Potted under vacuum
- Degree of protection - IP00
- Short-circuit proof
- The insulation construction of the products are suitable for VDE, UL standard
- V. Secondary tolerance:  $\pm 5\%$
- Weight: 115 gr

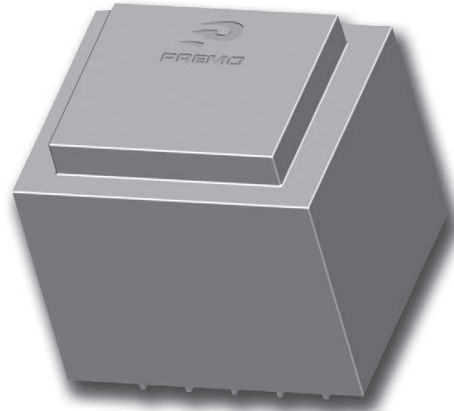

### Electrical specifications

Reference Part Number	Primary Vac	Secondary Rating		Secondary no load Vac	Schematic number
		Vac	mA		
PG30US-060-383	115	6	383	10	1
PG30US-090-255	115	9	255	13,8	1
PG30US-120-192	115	12	192	18,6	1
PG30US-150-153	115	15	153	23,8	1
PG30US-180-128	115	18	128	27,8	1
PG30US-240-96	115	24	96	34,7	1
PG30MS-060-383	2x115	6	383	10	3
PG30MS-090-255	2x115	9	255	13,8	3
PG30MS-120-192	2x115	12	192	18,6	3
PG30MS-150-153	2x115	15	153	23,8	3
PG30MS-180-128	2x115	18	128	27,8	3
PG30MS-240-096	2x115	24	96	34,7	3
PG30S-060-383	230	6	383	10	1
PG30S-090-255	230	9	255	13,8	1
PG30S-120-192	230	12	192	18,6	1
PG30S-150-153	230	15	153	23,8	1
PG30S-180-128	230	18	128	27,8	1
PG30S-240-096	230	24	96	34,7	1
PG30UD-060-191	115	2x6	191	2x9,9	2
PG30UD-090-128	115	2x9	128	2x14	2
PG30UD-120-096	115	2x12	96	2x17,5	2
PG30UD-150-076	115	2x15	76	2x24,4	2
PG30UD-180-064	115	2x18	64	2x29,3	2
PG30UD-240-048	115	2x24	48	2x35,8	2
PG30MD-060-191	2x115	2x6	191	2x9,9	4
PG30MD-090-128	2x115	2x9	128	2x14	4
PG30MD-120-096	2x115	2x12	96	2x17,5	4
PG30MD-150-076	2x115	2x15	76	2x24,4	4
PG30MD-180-064	2x115	2x18	64	2x29,3	4
PG30MD-240-048	2x115	2x24	48	2x35,8	4
PG30D-060-191	230	2x6	191	2x9,9	2
PG30D-090-128	230	2x9	128	2x14	2
PG30D-120-096	230	2x12	96	2x17,5	2
PG30D-150-076	230	2x15	76	2x24,4	2
PG30D-180-064	230	2x18	64	2x29,3	2
PG30D-240-048	230	2x24	48	2x35,8	2

# PG SERIES

## Laminated transformers EI30/23 - 2,8 VA

### Features

- Frequency - 50/60 Hz
- Temperature class - Class B (130°C)
- Ambient temperature (ta) - 70°C
- Insulation voltage - 3750 Vrms
- Split bobbin
- Potted under vacuum
- Degree of protection - IP00
- Short-circuit proof
- The insulation construction of the products are suitable for VDE, UL standard
- V. Secondary tolerance:  $\pm 5\%$
- Weight: 135 gr

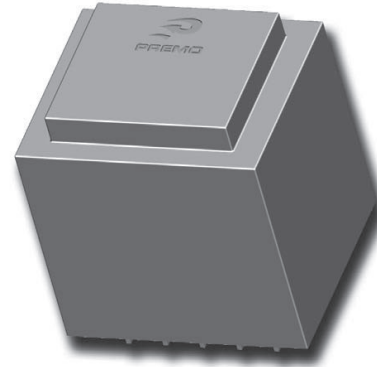

### Electrical specifications

Reference Part Number	Primary Vac	Secondary Rating		Secondary no load Vac	Schematic number
		Vac	mA		
PG30US-060-466	115	6	466	10,7	1
PG30US-090-311	115	9	311	14,8	1
PG30US-120-233	115	12	233	20,8	1
PG30US-150-186	115	15	186	24	1
PG30US-180-155	115	18	155	29,9	1
PG30US-240-116	115	24	116	38,8	1
PG30MS-060-466	2x115	6	466	10,7	3
PG30MS-090-311	2x115	9	311	14,8	3
PG30MS-120-233	2x115	12	233	20,8	3
PG30MS-150-186	2x115	15	186	24	3
PG30MS-180-155	2x115	18	155	29,9	3
PG30MS-240-116	2x115	24	116	38,8	3
PG30S-060-466	230	6	466	10,7	1
PG30S-090-311	230	9	311	14,8	1
PG30S-120-233	230	12	233	20,8	1
PG30S-150-186	230	15	186	24	1
PG30S-180-155	230	18	155	29,9	1
PG30S-240-116	230	24	116	38,8	1
PG30UD-060-233	115	2x6	233	2x10,7	2
PG30UD-090-155	115	2x9	155	2x16	2
PG30UD-120-116	115	2x12	116	2x20,4	2
PG30UD-150-093	115	2x15	93	2x25	2
PG30UD-180-077	115	2x18	77	2x30,5	2
PG30UD-240-058	115	2x24	58	2x38,7	2
PG30MD-060-233	2x115	2x6	233	2x10,7	4
PG30MD-090-155	2x115	2x9	155	2x16	4
PG30MD-120-116	2x115	2x12	116	2x20,4	4
PG30MD-150-093	2x115	2x15	93	2x25	4
PG30MD-180-077	2x115	2x18	77	2x30,5	4
PG30MD-240-058	2x115	2x24	58	2x38,7	4
PG30D-060-233	230	2x6	233	2x10,7	2
PG30D-090-155	230	2x9	155	2x16	2
PG30D-120-116	230	2x12	116	2x20,4	2
PG30D-150-093	230	2x15	93	2x25	2
PG30D-180-077	230	2x18	77	2x30,5	2
PG30D-240-058	230	2x24	58	2x38,7	2

# PG SERIES

## Laminated transformers EI30

50/60Hz Transformers

Dimensions (in mm)

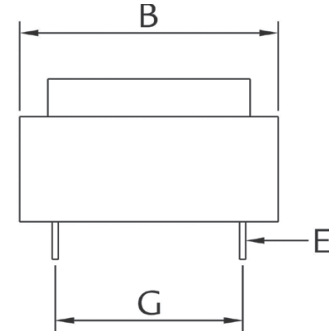
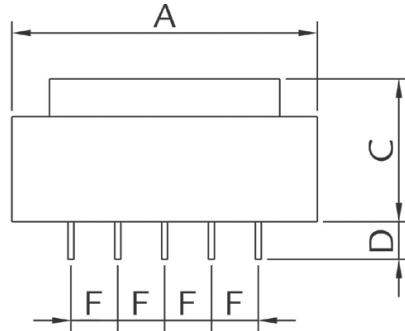
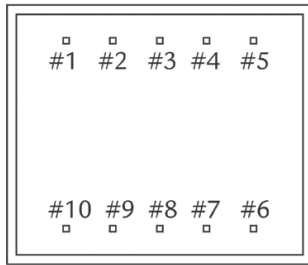

Series	A ±0,5	B ±0,5	C ±0,5	D ±1,0	E ±0,1	F ±0,2	G ±0,5
EI30/5	32,6	27,6	15,2	4,0	SQ0,64	5,0	20,0
EI30/12,5	32,3	27,3	21,3	4,0	SQ0,64	5,0	20,0
EI30/15,5	32,6	27,6	27,8	4,0	SQ0,64	5,0	20,0
EI30/18	32,6	27,6	29,8	4,0	SQ0,64	5,0	20,0
EI30/23	32,6	27,6	34,3	4,0	SQ0,64	5,0	20,0

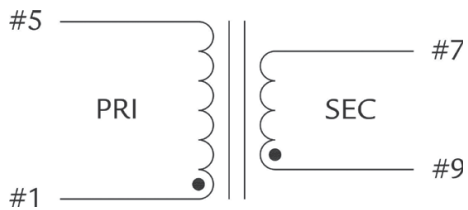

CONFIGURATION 1

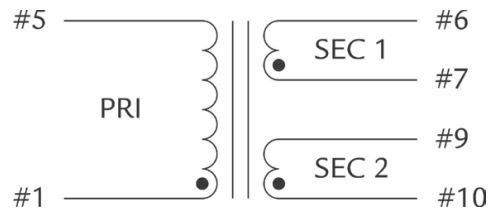

CONFIGURATION 2

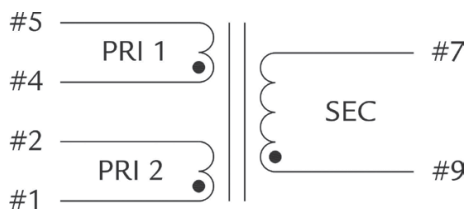

CONFIGURATION 3

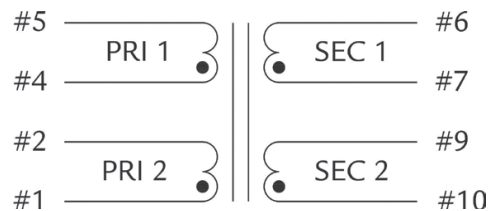

CONFIGURATION 4

# PG SERIES

## Laminated transformers EI38/13,6 - 3,2 VA

### Features

- Frequency - 50/60 Hz
- Temperature class - Class B (130°C)
- Ambient temperature (ta) - 70°C
- Insulation voltage - 3750 Vrms
- Split bobbin
- Potted under vacuum
- Degree of protection - IP00
- Short-circuit proof
- The insulation construction of the products are suitable for VDE, UL standard
- V. Secondary tolerance:  $\pm 5\%$
- Weight: 155 gr



### Electrical specifications

Reference Part Number	Primary Vac	Secondary Rating		Secondary no load Vac	Schematic number
		Vac	mA		
PG38US-060-533	115	6	533	9,2	1
PG38US-090-355	115	9	355	13,95	1
PG38US-120-266	115	12	266	17,8	1
PG38US-150-213	115	15	213	22,2	1
PG38US-180-177	115	18	177	27	1
PG38US-240-133	115	24	133	35	1
PG38MS-060-533	2x115	6	533	9,2	3
PG38MS-090-355	2x115	9	355	13,95	3
PG38MS-120-266	2x115	12	266	17,8	3
PG38MS-150-213	2x115	15	213	22,2	3
PG38MS-180-177	2x115	18	177	27	3
PG38MS-240-133	2x115	24	133	35	3
PG38S-060-533	230	6	533	9,2	1
PG38S-090-355	230	9	355	13,95	1
PG38S-120-266	230	12	266	17,8	1
PG38S-150-213	230	15	213	22,2	1
PG38S-180-177	230	18	177	27	1
PG38S-240-133	230	24	133	35	1
PG38UD-060-266	115	2x6	266	2x8,9	2
PG38UD-090-177	115	2x9	177	2x13,4	2
PG38UD-120-133	115	2x12	133	2x17,5	2
PG38UD-150-106	115	2x15	106	2x22,3	2
PG38UD-180-088	115	2x18	88	2x25,8	2
PG38UD-240-066	115	2x24	66	2x35,9	2
PG38MD-060-266	2x115	2x6	266	2x8,9	4
PG38MD-090-177	2x115	2x9	177	2x13,4	4
PG38MD-120-133	2x115	2x12	133	2x17,5	4
PG38MD-150-106	2x115	2x15	106	2x22,3	4
PG38MD-180-088	2x115	2x18	88	2x25,8	4
PG38MD-240-066	2x115	2x24	66	2x35,9	4
PG38D-060-266	230	2x6	266	2x8,9	2
PG38D-090-177	230	2x9	177	2x13,4	2
PG38D-120-133	230	2x12	133	2x17,5	2
PG38D-150-106	230	2x15	106	2x22,3	2
PG38D-180-088	230	2x18	88	2x25,8	2
PG38D-240-066	230	2x24	66	2x35,9	2



# PG SERIES

## Laminated transformers EI38/13,6 - 4,0 VA

### Features

- Frequency - 50/60 Hz
- Temperature class - Class B (130°C)
- Ambient temperature (ta) - 70°C
- Insulation voltage - 3750 Vrms
- Split bobbin
- Potted under vacuum
- Degree of protection - IP00
- Short-circuit proof
- The insulation construction of the products are suitable for VDE, UL standard
- V. Secondary tolerance:  $\pm 5\%$
- Weight: 155 gr

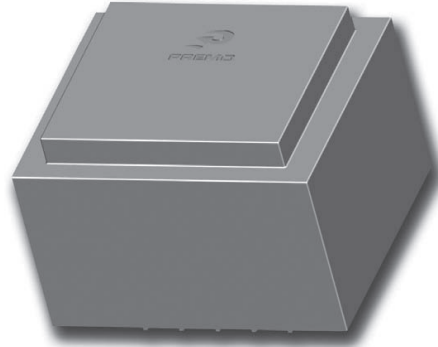

### Electrical specifications

Reference Part Number	Primary Vac	Secondary Rating		Secondary no load Vac	Schematic number
		Vac	mA		
PG38US-060-666	115	6	666	8,5	1
PG38US-090-444	115	9	444	12,6	1
PG38US-120-333	115	12	333	16,4	1
PG38US-150-267	115	15	267	20,9	1
PG38US-180-222	115	18	222	24,3	1
PG38US-240-167	115	24	167	32,8	1
PG38MS-060-666	2x115	6	666	8,5	3
PG38MS-090-444	2x115	9	444	12,6	3
PG38MS-120-333	2x115	12	333	16,4	3
PG38MS-150-267	2x115	15	267	20,9	3
PG38MS-180-222	2x115	18	222	24,3	3
PG38MS-240-167	2x115	24	167	32,8	3
PG38S-060-666	230	6	666	8,5	1
PG38S-090-444	230	9	444	12,6	1
PG38S-120-333	230	12	333	16,4	1
PG38S-150-267	230	15	267	20,9	1
PG38S-180-222	230	18	222	24,3	1
PG38S-240-167	230	24	167	32,8	1
PG38UD-060-333	115	2x6	333	2x8,5	2
PG38UD-090-222	115	2x9	222	2x12,5	2
PG38UD-120-167	115	2x12	167	2x16,4	2
PG38UD-150-133	115	2x15	133	2x21,2	2
PG38UD-180-111	115	2x18	111	2x24,5	2
PG38UD-240-083	115	2x24	83	2x32,7	2
PG38MD-060-333	2x115	2x6	333	2x8,5	4
PG38MD-090-222	2x115	2x9	222	2x12,5	4
PG38MD-120-167	2x115	2x12	167	2x16,4	4
PG38MD-150-133	2x115	2x15	133	2x21,2	4
PG38MD-180-111	2x115	2x18	111	2x24,5	4
PG38MD-240-083	2x115	2x24	83	2x32,7	4
PG38D-060-333	230	2x6	333	2x8,5	2
PG38D-090-222	230	2x9	222	2x12,5	2
PG38D-120-167	230	2x12	167	2x16,4	2
PG38D-150-133	230	2x15	133	2x21,2	2
PG38D-180-111	230	2x18	111	2x24,5	2
PG38D-240-083	230	2x24	83	2x32,7	2

# PG SERIES

## Laminated transformers EI38/13,6

Dimensions (in mm)

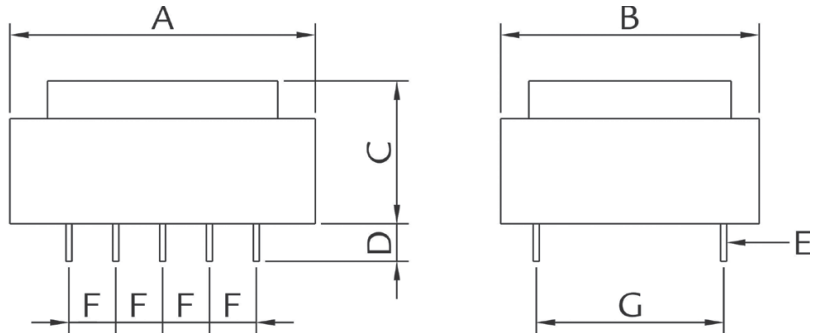
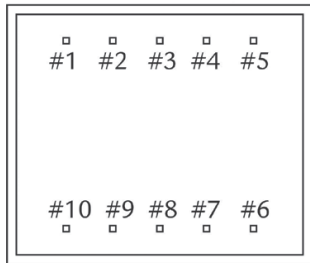

50/60Hz Transformers

Series	A	B	C	D	E	F	G
EI38/13,6	±0,5	±0,5	±0,5	±1,0	±0,1	±0,2	±0,5
	41,0	35,0	28,0	4,0	SQ0,64	5,0	25,0

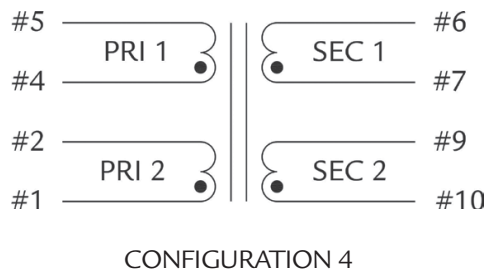
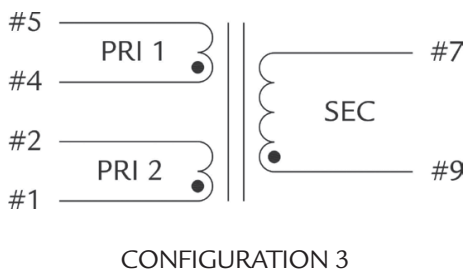
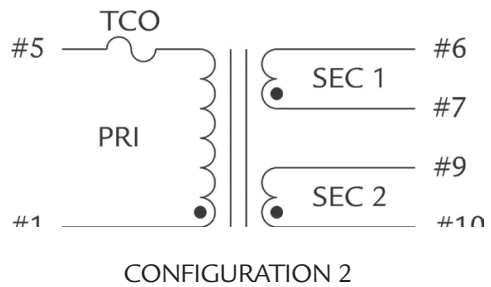
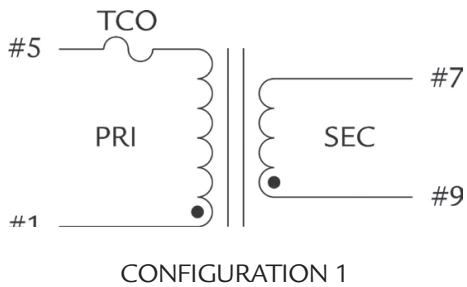

# PG SERIES

## Laminated transformers EI42/14,8 - 5,0 VA

### Features

- Frequency - 50/60 Hz
- Temperature class - Class B (130°C)
- Ambient temperature ( $t_a$ ) - 70°C
- Insulation voltage - 3750 Vrms
- Split bobbin
- Potted under vacuum
- Degree of protection - IP00
- Short-circuit proof
- The insulation construction of the products are suitable for VDE, UL standard
- V. Secondary tolerance:  $\pm 5\%$
- Weight: 200 gr



### Electrical specifications

Reference Part Number	Primary Vac	Secondary Rating		Secondary no load Vac	Schematic number
		Vac	mA		
PG42US-060-833	115	6	833	8,1	1
PG42US-090-555	115	9	555	12	1
PG42US-120-416	115	12	416	15,5	1
PG42US-150-333	115	15	333	19,2	1
PG42US-180-277	115	18	277	23	1
PG42US-240-208	115	24	208	30,5	1
PG42MS-060-833	2x115	6	833	8,1	3
PG42MS-090-555	2x115	9	555	12	3
PG42MS-120-416	2x115	12	416	15,5	3
PG42MS-150-333	2x115	15	333	19,2	3
PG42MS-180-277	2x115	18	277	23	3
PG42MS-240-208	2x115	24	208	30,5	3
PG42S-060-833	230	6	833	8,1	1
PG42S-090-555	230	9	555	12	1
PG42S-120-416	230	12	416	15,5	1
PG42S-150-333	230	15	333	19,2	1
PG42S-180-277	230	18	277	23	1
PG42S-240-208	230	24	208	30,5	1
PG42UD-060-416	115	2x6	416	2x7,7	2
PG42UD-090-277	115	2x9	277	2x11,6	2
PG42UD-120-208	115	2x12	208	2x15,2	2
PG42UD-150-166	115	2x15	166	2x19,4	2
PG42UD-180-138	115	2x18	138	2x23,1	2
PG42UD-240-104	115	2x24	104	2x30,8	2
PG42MD-060-416	2x115	2x6	416	2x7,7	4
PG42MD-090-277	2x115	2x9	277	2x11,6	4
PG42MD-120-208	2x115	2x12	208	2x15,2	4
PG42MD-150-166	2x115	2x15	166	2x19,4	4
PG42MD-180-138	2x115	2x18	138	2x23,1	4
PG42MD-240-104	2x115	2x24	104	2x30,8	4
PG42D-060-416	230	2x6	416	2x7,7	2
PG42D-090-277	230	2x9	277	2x11,6	2
PG42D-120-208	230	2x12	208	2x15,2	2
PG42D-150-166	230	2x15	166	2x19,4	2
PG42D-180-138	230	2x18	138	2x23,1	2
PG42D-240-104	230	2x24	104	2x30,8	2

# PG SERIES

## Laminated transformers EI42/14,8 - 5,0 VA

Dimensions (in mm)

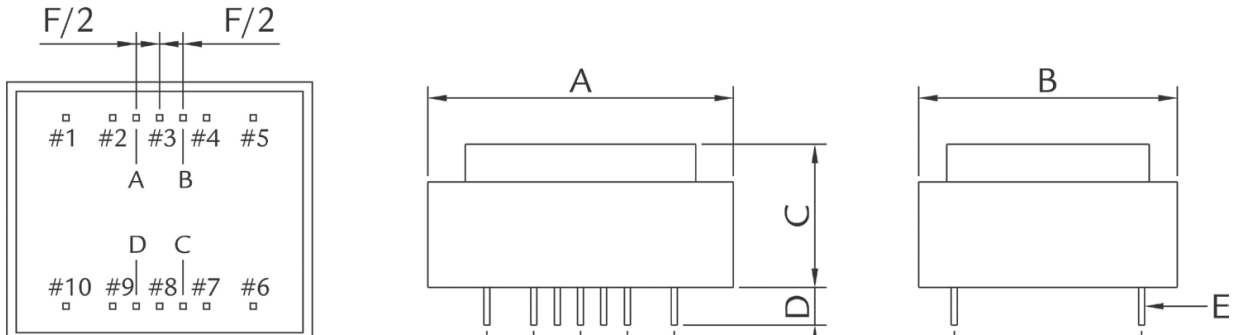

50/60Hz Transformers

Series	A	B	C	D	E	F	G
	±1,0	±1,0	±1,0	±1,0	±0,1	±0,2	±0,5
EI42/14,8	44,0	37,0	31,5	4,0	SQ0,64	5,0	25,0

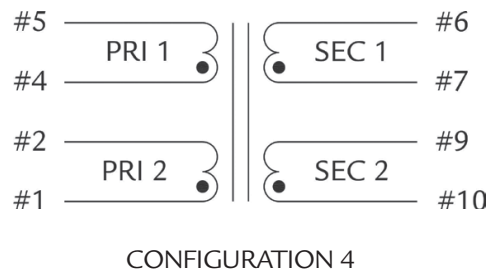
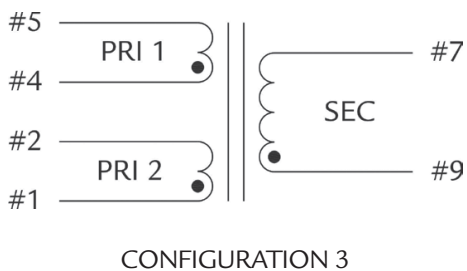
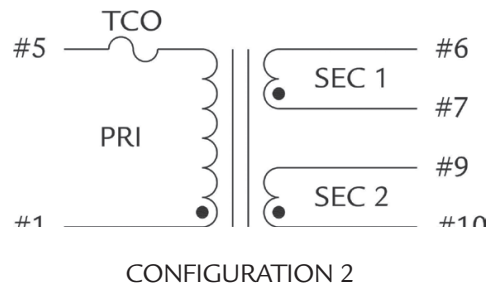
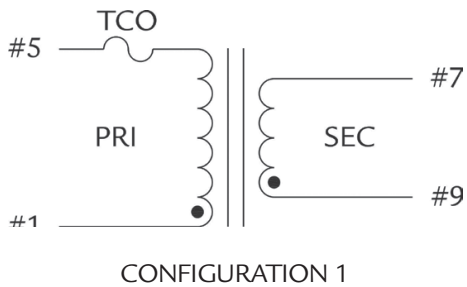

# PG SERIES

## Laminated transformers EI48/16,8 - 10,0 VA

### Features

- Frequency - 50/60 Hz
- Temperature class - Class B (130°C)
- Ambient temperature (ta) - 40°C
- Insulation voltage - 3750 Vrms
- Split bobbin
- Potted under vacuum
- Degree of protection - IP00
- Short-circuit proof
- The insulation construction of the products are suitable for VDE, UL standard
- V. Secondary tolerance:  $\pm 5\%$
- Weight: 300 gr



### Electrical specifications

Reference Part Number	Primary Vac	Secondary Rating		Secondary no load Vac	Schematic number
		Vac	mA		
PG48US-060-1666	115	6	1666	7,9	1
PG48US-090-1111	115	9	1111	12	1
PG48US-120-0833	115	12	833	15,7	1
PG48US-150-0666	115	15	666	19,2	1
PG48US-180-0555	115	18	555	22,9	1
PG48US-240-0416	115	24	416	30,6	1
PG48MS-060-1666	2x115	6	1666	7,9	3
PG48MS-090-1111	2x115	9	1111	12	3
PG48MS-120-0833	2x115	12	833	15,7	3
PG48MS-150-0666	2x115	15	666	19,2	3
PG48MS-180-0555	2x115	18	555	22,9	3
PG48MS-240-0416	2x115	24	416	30,6	3
PG48S-060-1666	230	6	1666	7,9	1
PG48S-090-1111	230	9	1111	12	1
PG48S-120-0833	230	12	833	15,7	1
PG48S-150-0666	230	15	666	19,2	1
PG48S-180-0555	230	18	555	22,9	1
PG48S-240-0416	230	24	416	30,6	1
PG48UD-060-0833	115	2x6	833	2x8,1	2
PG48UD-090-0555	115	2x9	555	2x11,6	2
PG48UD-120-0416	115	2x12	416	2x15,7	2
PG48UD-150-0333	115	2x15	333	2x19,5	2
PG48UD-180-0277	115	2x18	277	2x23,5	2
PG48UD-240-0208	115	2x24	208	2x30,0	2
PG48MD-060-0833	2x115	2x6	833	2x8,1	4
PG48MD-090-0555	2x115	2x9	555	2x11,6	4
PG48MD-120-0416	2x115	2x12	416	2x15,7	4
PG48MD-150-0333	2x115	2x15	333	2x19,5	4
PG48MD-180-0277	2x115	2x18	277	2x23,5	4
PG48MD-240-0208	2x115	2x24	208	2x30,0	4
PG48D-060-0833	230	2x6	833	2x8,1	2
PG48D-090-0555	230	2x9	555	2x11,6	2
PG48D-120-0416	230	2x12	416	2x15,7	2
PG48D-150-0333	230	2x15	333	2x19,5	2
PG48D-180-0277	230	2x18	277	2x23,5	2
PG48D-240-0208	230	2x24	208	2x30,0	2

# PG SERIES

## Laminated transformers EI48/16,8 - 10,0 VA

Dimensions (in mm)

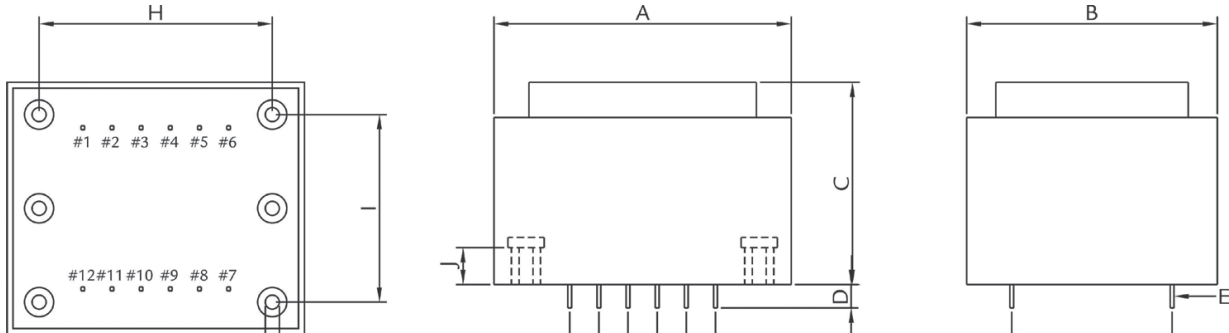

50/60Hz Transformers

Series	A	B	C	D	E	F	G	H	I	J	K
EI48/16,8	±1,0	±1,0	±1,0	±1,0	±0,1	±0,2	±0,5	±1,0	±1,0	min	±0,2
	51,0	43,0	34,5	4,0	SQ0,64	5,0	27,5	40,0	32,0	6,3	ø2,4

